



## **Your Television's Directions for Use**



### **Read this manual first!**

*Congratulations on purchasing this Philips product.*

*We've included everything you need to get started.*

*If you have any problems, Philips Representatives can*

*help you get the most from your new product by explaining:*

- Hookups,
- First Time Setup, and
- Feature Operation.

*Do not attempt to return this product to the store.*

**For fast help, call us first!  
1-800-531-0039**

*Thank you for making Philips a part of your home!*

*Let's make things better.*



**PHILIPS**

# Return your Warranty Registration card today to ensure you receive all the benefits you're entitled to.

Once your PHILIPS purchase is registered, you're eligible to receive all the privileges of owning a PHILIPS product. So complete and return the Warranty Registration Card enclosed with your purchase at once. And take advantage of these important benefits.

## Warranty Verification

Registering your product within 10 days confirms your right to maximum protection under the terms and conditions of your PHILIPS warranty.

## Owner Confirmation

Your completed Warranty Registration Card serves as verification of ownership in the event of product theft or loss.

## Model Registration

Returning your Warranty Registration Card right away guarantees you'll receive all the information and special offers which you qualify for as the owner of your model.

**Congratulations on your purchase, and welcome to the "family!"**

# PHILIPS



**Dear PHILIPS product owner:**

Thank you for your confidence in PHILIPS. You've selected one of the best-built, best-backed products available today. And we'll do everything in our power to keep you happy with your purchase for many years to come.

As a member of the PHILIPS "family," you're entitled to protection by one of the most comprehensive warranties and outstanding service networks in the industry.

What's more, your purchase guarantees you'll receive all the information and special offers for which you qualify, plus easy access to accessories from our convenient home shopping network. And most importantly you can count on our uncompromising commitment to your total satisfaction.

All of this is our way of saying welcome—and thanks for investing in a PHILIPS product.

Sincerely,

Philips Consumer Electronics Company

P.S. Remember, to get the most from your PHILIPS product, you must return your Warranty Registration Card within 10 days. So please mail it to us right now!

## Know these safety symbols



**⚡** This "bolt of lightning" indicates uninsulated material within your unit may cause an electrical shock. For the safety of everyone in your household, please do not remove product covering.

**⚠** The "exclamation point" calls attention to features for which you should read the enclosed literature closely to prevent operating and maintenance problems.

**WARNING:** TO PREVENT FIRE OR SHOCK HAZARD, DO NOT EXPOSE THIS EQUIPMENT TO RAIN OR MOISTURE.

**CAUTION:** To prevent electric shock, match wide blade of plug to wide slot, and fully insert.

**ATTENTION:** Pour éviter les chocs électriques, introduire la lame la plus large de la fiche dans la borne correspondante de la prise et pousser jusqu'au fond.

**PHILIPS** Visit our World Wide Web Site at <http://www.philipsusa.com>

# IMPORTANT SAFETY INSTRUCTIONS

## Read before operating equipment

1. Read these instructions.
2. Keep these instructions.
3. Heed all warnings.
4. Follow all instructions.
5. Do not use this apparatus near water.
6. Clean only with a dry cloth.
7. Do not block any of the ventilation openings. Install in accordance with the manufacturers instructions.
8. Do not install near any heat sources such as radiators, heat registers, stoves, or other apparatus (including amplifiers) that produce heat.
9. Do not defeat the safety purpose of the polarized or grounding-type plug. A polarized plug has two blades with one wider than the other. A grounding type plug has two blades and third grounding prong. The wide blade or third prong are provided for your safety. When the provided plug does not fit into your outlet, consult an electrician for replacement of the obsolete outlet.
10. Protect the power cord from being walked on or pinched particularly at plugs, convenience receptacles, and the point where they exit from the apparatus.
11. Only use attachments/accessories specified by the manufacturer.
12.  Use only with a cart, stand, tripod, bracket, or table specified by the manufacturer, or sold with the apparatus. When a cart is used, use caution when moving the cart/apparatus combination to avoid injury from tip-over.
13. Unplug this apparatus during lightning storms or when unused for long periods of time.
14. Refer all servicing to qualified service personnel. Servicing is required when the apparatus has been damaged in any way, such as power-supply cord or plug is damaged, liquid has been spilled or objects have fallen into apparatus, the apparatus has been exposed to rain or moisture, does not operate normally, or has been dropped.
15. This product may contain lead and mercury. Disposal of these materials may be regulated due to environmental considerations. For disposal or recycling information, please contact your local authorities or the Electronic Industries Alliance: [www.eiae.org](http://www.eiae.org)
16. **Damage Requiring Service** - The appliance should be serviced by qualified service personnel when:
  - A. The power supply cord or the plug has been damaged; or
  - B. Objects have fallen, or liquid has been spilled into the appliance; or
  - C. The appliance has been exposed to rain; or
  - D. The appliance does not appear to operate normally or exhibits a marked change in performance; or
  - E. The appliance has been dropped, or the enclosure damaged.
17. **Tilt/Stability** - All televisions must comply with recommended international global safety standards for tilt and stability properties of its cabinet design.
  - Do not compromise these design standards by applying excessive pull force to the front, or top, of the cabinet which could ultimately overturn the product.
  - Also, do not endanger yourself, or children, by placing electronic equipment/toys on the top of the cabinet. Such items could unsuspectingly fall from the top of the set and cause product damage and/or personal injury.
18. **Wall or Ceiling Mounting** - The appliance should be mounted to a wall or ceiling only as recommended by the manufacturer.
19. **Power Lines** - An outdoor antenna should be located away from power lines.
20. **Outdoor Antenna Grounding** - If an outside antenna is connected to the receiver, be sure the antenna system is grounded so as to provide some protection against voltage surges and built up static charges.

Section 810 of the National Electric Code, ANSI/NFPA No. 70-1984, provides information with respect to proper grounding of the mats and supporting structure grounding of the lead-in wire to an antenna discharge unit, size of grounding connectors, location of antenna-discharge unit, connection to grounding electrodes and requirements for the grounding electrode. See Figure below.
21. **Object and Liquid Entry** - Care should be taken so that objects do not fall and liquids are not spilled into the enclosure through openings.

**Note to the CATV system installer:** This reminder is provided to call the CATV system installer's attention to Article 820-40 of the NEC that provides guidelines for proper grounding and, in particular, specifies that the cable ground shall be connected to the grounding system of the building, as close to the point of cable entry as practical.

### Example of Antenna Grounding as per NEC - National Electric Code

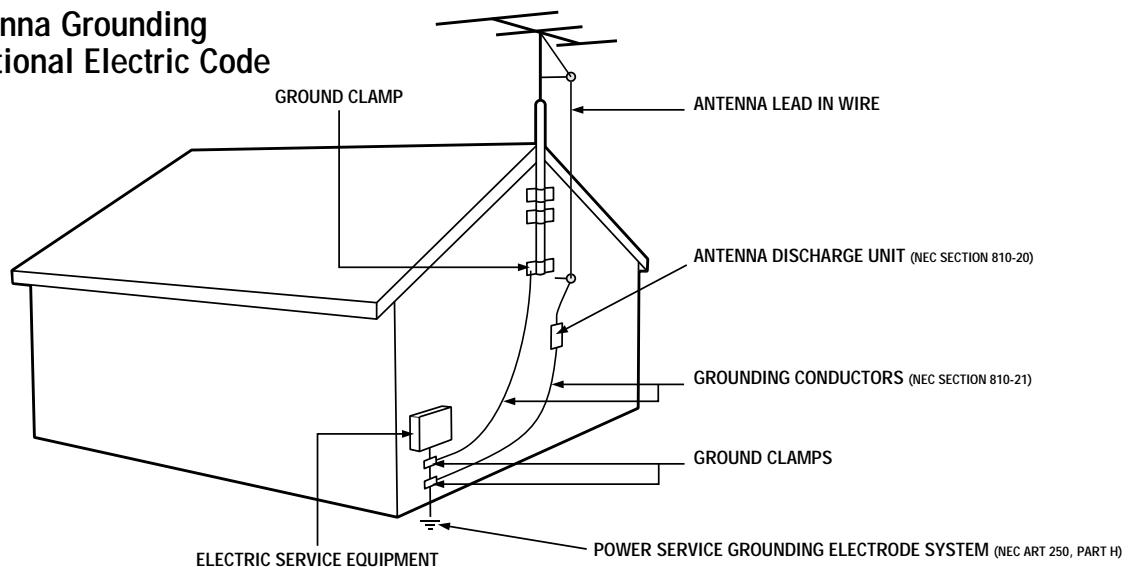

# TABLE OF CONTENTS

## **Introduction**

Welcome/Registration of Your TV .....	2
Safety Instructions .....	3
Table of Contents .....	4



## **Getting Started**

Basic Cable TV Connection .....	5
Basic Antenna Connection .....	6
Basic VCR to Television Connection .....	7
Using the Front Audio/Video Inputs .....	7
Basic Television Operation .....	8
Basic Remote Operation .....	8
Description of Remote Control Buttons .....	9



## **Install Menu**

How to Use the Language Control .....	10
How to Use the Tuner Mode Control .....	11
How to Auto Program TV Channels .....	12
How to Add or Delete Channels .....	13



## **Picture Menu**

How to Use the Picture Adjustment Controls .....	14
How to Use the DNR (Digital Noise Reduction) Control .....	15
How to Use the Contrast + (Black Stretch) Control .....	16



## **Sound Menu**

How to Set the Treble Boost Control .....	17
How to Set the Bass Boost Control .....	17
How to Set the AVL Control .....	18



## **Features Menu**

Using the Timer Controls .....	19
Understanding the AutoLock Controls .....	20
Setting Up the AutoLock Access Code .....	21
How to Block Channels .....	22
How to Clear All Blocked Channels at the Same Time .....	23
How to Block All Channels at the Same Time .....	24
Blocking Programming Based on Movie Ratings .....	25
Blocking Programming Based on TV Ratings .....	26
Other AutoLock Blocking Options .....	27
How to use the Closed Captioning Control .....	28



## **Remote Control Use**

Setting up the Sleptimer Option .....	29
Setting the Auto Picture Control .....	30
Setting the Auto Sound Control .....	31
Using the Quadra Surf Buttons (Alternate Channel) .....	32-33



## **General Information**

Troubleshooting Tips .....	34
Glossary of Terms .....	35
Index .....	36
Warranty .....	37

*Here are a few of the special features built into this new Color Television:*

**AutoLock™** feature allows you to block the viewing of certain channels or external audio/video connections where you might not want your children viewing inappropriate material.

**Infrared Remote Control** works your TV set, and allows you to program certain features with the press of one button.

**Standard broadcast (VHF/UHF) or Cable TV (CATV)** channel capability.

**Closed Captioning** allows the viewer to read TV program dialogue or voice conversations as on-screen text.

**Automatic Programming of Channels** for quick and easy selection of favorite stations available in your area.

**On-screen Features** (in either English or Spanish) show helpful messages for setting of TV controls.

**Audio/Video Jackpanel** located on the front of the television for direct connections with a camcorder, or VCR. Provides quality TV picture and mono sound playback.

**On Timer** automatically turns the TV ON at a preset time, and channel.

**Sleptimer** automatically turns the TV OFF at preset times.

**Auto Picture™** allows you to set the picture color, tint, contrast, etc. for various types of programming such as Sports, Movies, Personal, Weak Signal, or Multi Media with the push of one button.

**Auto Sound™** controls allow you to set the sound controls for various types of listening programs such as Personal (sound controls the way you set them), Theatre, Music, or Voice with the push of one button.

**Bass and Treble Boost** controls to enhance the television's sound.

**NOTE: It is possible that this owner's manual may be used with several different television models. Not all features (and drawings) discussed in this manual will necessarily match those found with your television system. This is normal and does not require you contacting your dealer or requesting service.**

Auto Lock™, Auto Picture™, Auto Sound™ are all registered trademarks of Philips Consumer Electronics Company.  
Copyright © 2001 All rights reserved.

# HOOKING UP YOUR TV (BASIC CABLE TV CONNECTIONS)



Your Cable TV input into your home may be a single (75 ohm) cable, or a Converter Box installation. In either case the connection to the TV is very easy. Just put the threaded end of the cable signal to the TV's antenna plug and screw it down finger tight.

## BEGIN

**1** If your Cable TV signal is a single round cable (75 ohm) then you're ready to connect to the TV.

**If you have a Cable Converter Box:** Connect the Cable TV signal to the Cable Signal IN(put) plug on the Converter.

**2** Connect the Cable TV cable to the 75Ω plug on the TV.

**If you have a Cable Converter Box:** Connect the OUT(put) plug from the Converter to the 75Ω plug on the TV.

STOP

## SMART HELP

 Remember: Set the TV for the type signal you've just connected (see the "Tuner Mode" section on page 11 of this manual.)

To select only the channel numbers on your Cable system see "Auto Program" (page 12). If you use a Cable Converter box, set the TV to the same channel as the converter's CH 3/4 switch (on the rear of the converter.)

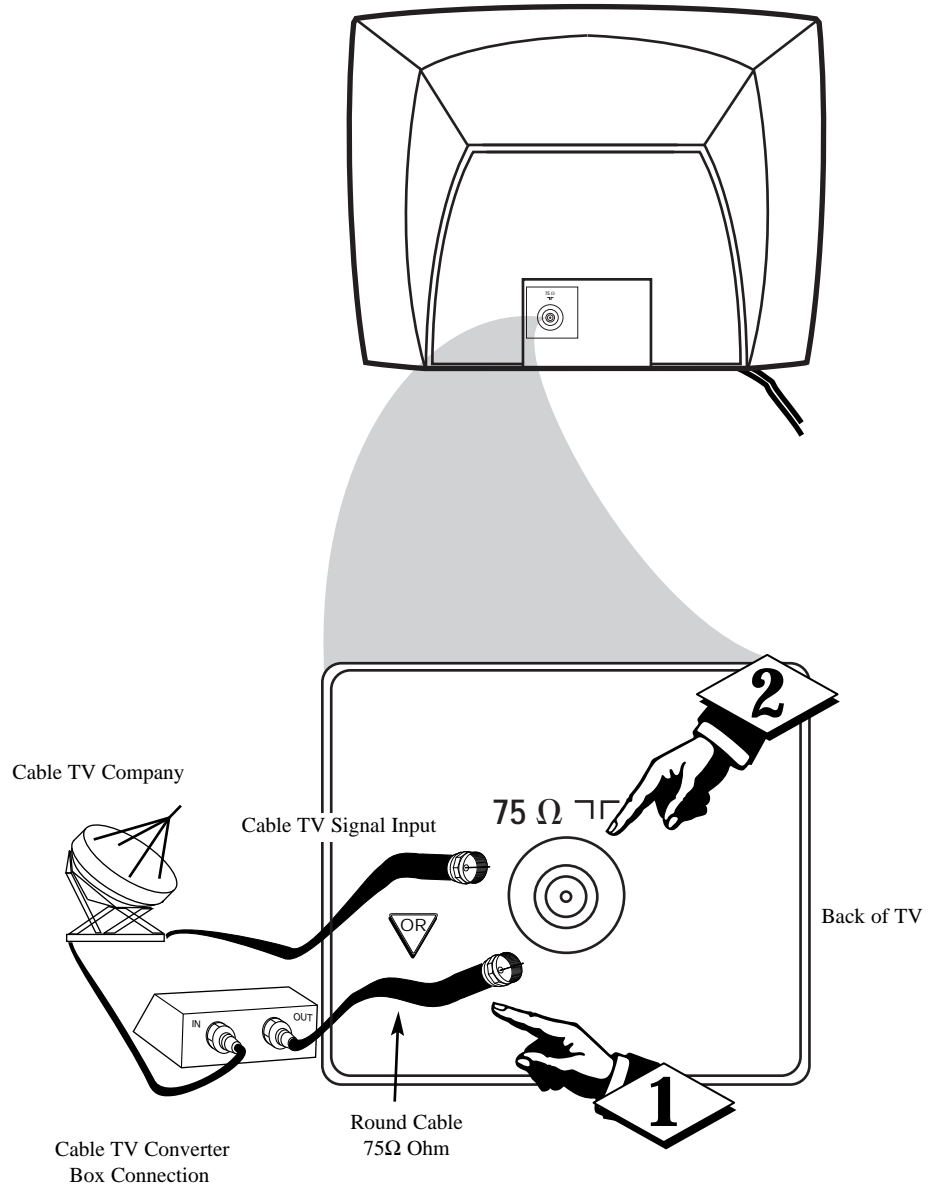



# HOOKING UP YOUR TV (BASIC ANTENNA TV CONNECTIONS)

A combination antenna receives normal broadcast channels (VHF 2-13 and UHF 14-69). Your connection is easy since there is only one 75Ω (ohm) antenna plug on the back of your TV - and that's where the antenna goes.

## BEGIN

**1** If your antenna has a round cable (75 ohm) on the end, then you're ready to connect it to the TV.

If your antenna has flat twin-lead wire (300 ohm), you first need to attach the antenna wires to the screws on a 300 to 75 ohm adapter.

**2** Push the round end of the adapter (or antenna) onto the 75Ω plug on the rear of the TV. If the round end of the antenna wire is threaded, screw it down finger tight.



Note: For homes with separate UHF and VHF antennas you will need an optional combiner to connect to the TV.

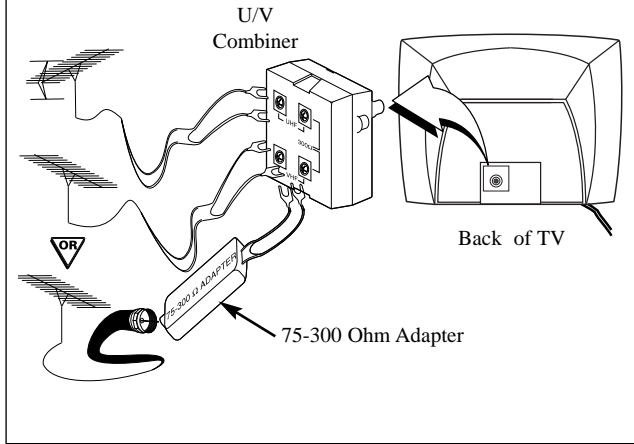

## SMART HELP

Remember: Be sure to set the TV for the type signal you've connected (see the "Tuner Mode" section on page 11 of this manual.)

To set the TV to select only the channel numbers in your area see how to "Program" or "Add" channels in the TV's memory on page 12 (Auto Program section).

To order any optional accessory contact your dealer or the Philips Parts Center at 1-800-851-8885.

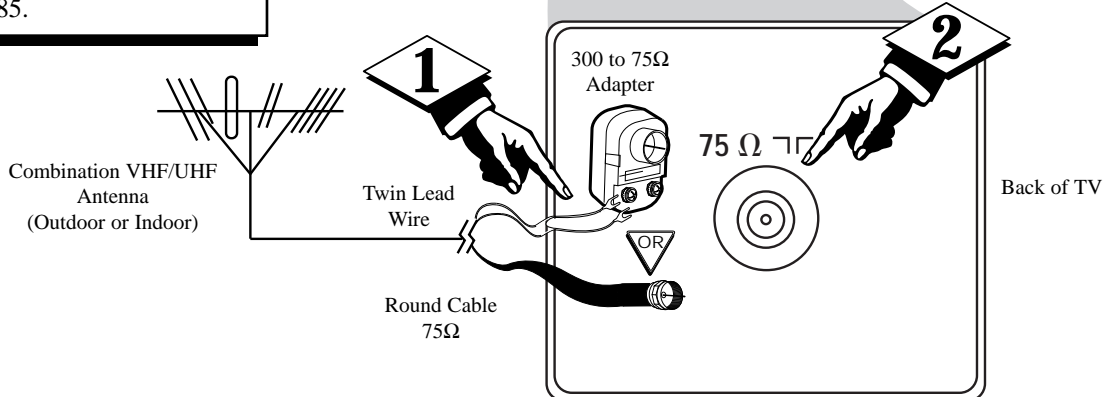
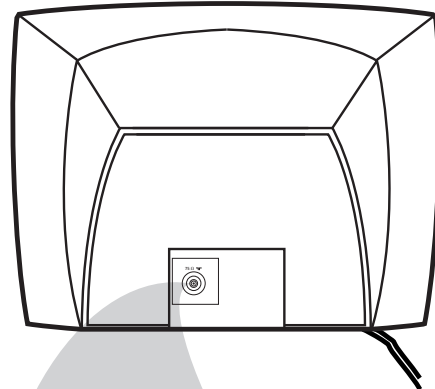



The basic Antenna, or Cable TV, to VCR to TV connection is shown to the right. For more information on other hookups (possible when Cable Converter/Descrambler boxes are included) refer to your accessory VCR and Cable Converter Owner's Manual for details.

**BEGIN**

**1** Connect your Antenna or Cable TV signal to the **IN FROM ANT(enna)** plug on the VCR.

**2** Connect the **OUT TO TV** plug on the VCR to the **75Ω** plug on the TV (connecting cable supplied with the VCR.)

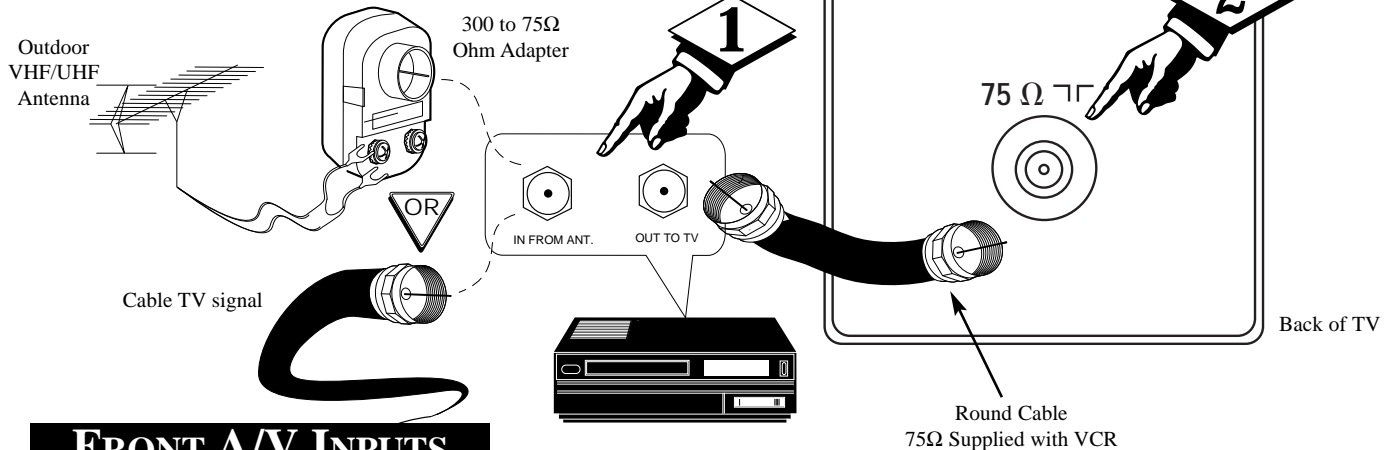
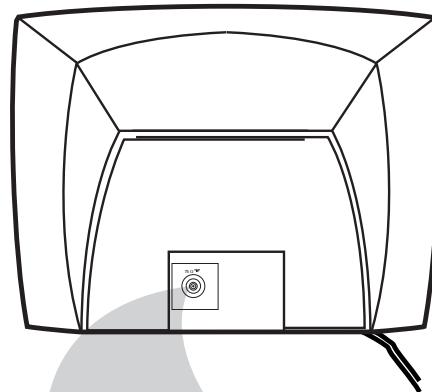

## FRONT A/V INPUTS

Audio and Video Front Mono inputs are available for a quick connection of a VCR or to playback video from a camera. Use the AV button on the remote to tune to the Front A/V Inputs.

**BEGIN**

**1** Connect the yellow video cable from the Video output on the VCR/Camera to the Video input located on the FRONT of the TV.

**2** Connect the audio cables (red and white) from the Audio outputs on the VCR/Camera to the Audio input located on the front of the TV. Note: The use of the "Y" adapter will have to be used if the VCR or Camera has stereo audio outputs.

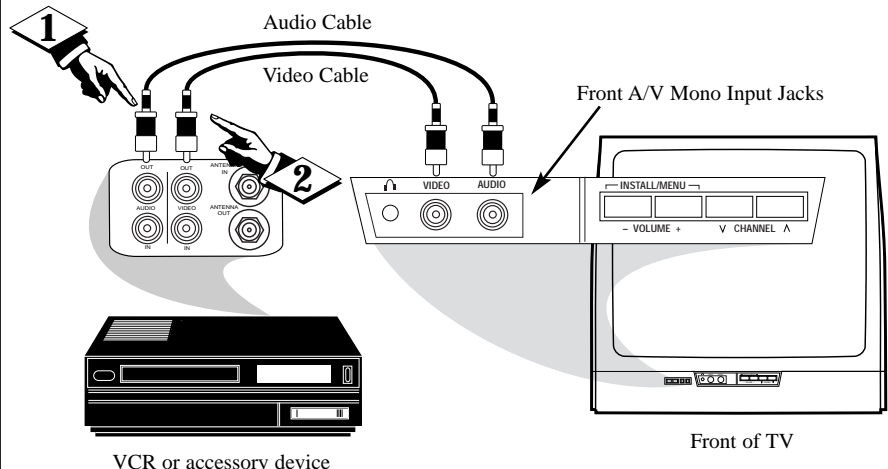



# BASIC TV/REMOTE OPERATIONS

## TELEVISION

### BEGIN

- 1 Press the **POWER** button to turn the TV ON.

Note: You can also press any button on the front of the TV to turn the TV ON.

- 2 Press the **VOLUME +** button to increase the sound level, or the **VOLUME -** button to lower the sound level.

Pressing both buttons at the same time will display the on-screen menu. Once in the menu, use these buttons to make adjustments or selections.

- 3 Press the **CHANNEL UP ▲** or **DOWN ▼** button to select TV channels.

## REMOTE

- 4 Point the remote control toward the remote sensor window on the TV when operating the TV with the remote.



## BATTERY INSTALLATION

To load the supplied batteries into the remote:

1. Remove the battery compartment lid on the back of the remote.
2. Place the batteries (2-AA) in the remote. Be sure the (+) and (-) ends of the batteries line up correctly (inside of case is marked.)
3. Reattach the battery lid.

## SMART HELP

Remember, the tuned channel number will always briefly appear when the TV is first turned ON (and with channel changes.)

You can also press the **STATUS/EXIT** button (on the remote) to see what channel the TV is ON.

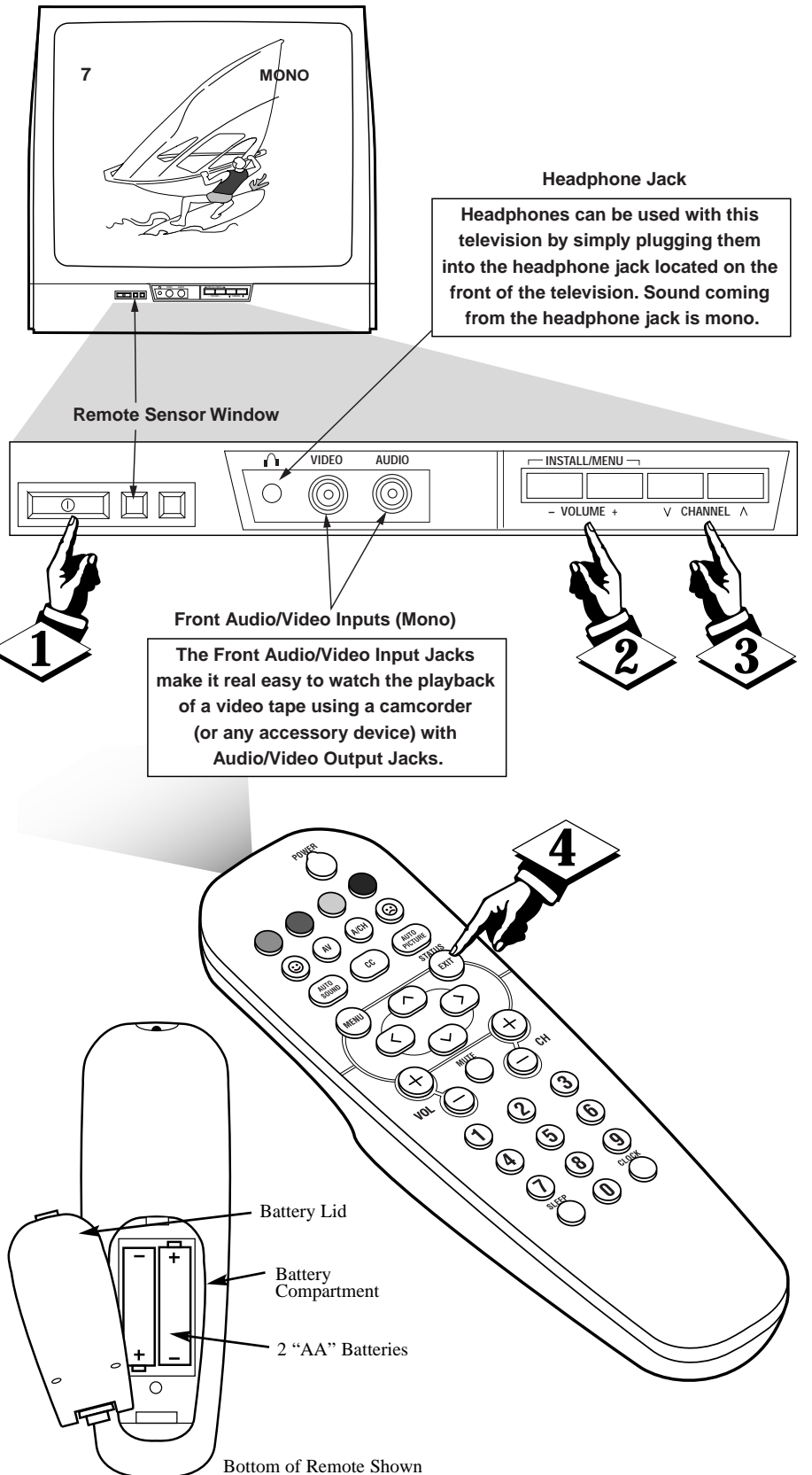



# DESCRIPTION OF REMOTE CONTROL BUTTONS



**QUADRA SURF Buttons - (Red, Green, Yellow, Blue)** Allows you to store and surf up to 10 channels you choose for each colored button.

**AV Button** - Press to select an accessory signal input from the front AV Inputs.

**SMILEY Button** - Press to add channels in the "Quadra Surf" lists. Works with all colored buttons.

**CC Button** - Press to activate the Closed Captioning options. Repeatedly press the CC button will scroll the options available on the TV screen.

**AUTO SOUND Button** - Press repeatedly to choose from different factory pre-defined sound settings. Choose from Personal (how you set the Sound Menu options), Voice (for programming with speaking only), Music (for musical type programs such as concerts), or Theatre (used when watching movies).

**MENU Button** - Press to display the on-screen menu. Also can be used to back out of the on-screen menu until it disappears from the TV's screen.

**VOL(ume) + or - Buttons** - Press the VOL + button to increase the TV's sound level. Press the VOL - button to decrease the TV's sound level.

**MUTE Button** - Press the mute button to eliminate the sound being heard from the TV. "MUTE" will be displayed on the TV's screen. Press again to restore the TV's volume to its previous level.

**SLEEP Button** - Press the Sleep button to set the TV to automatically turn itself off after a set period of time. Press repeatedly to select 15, 30, 45, 60, 90, 120, 180, or 240 minutes.

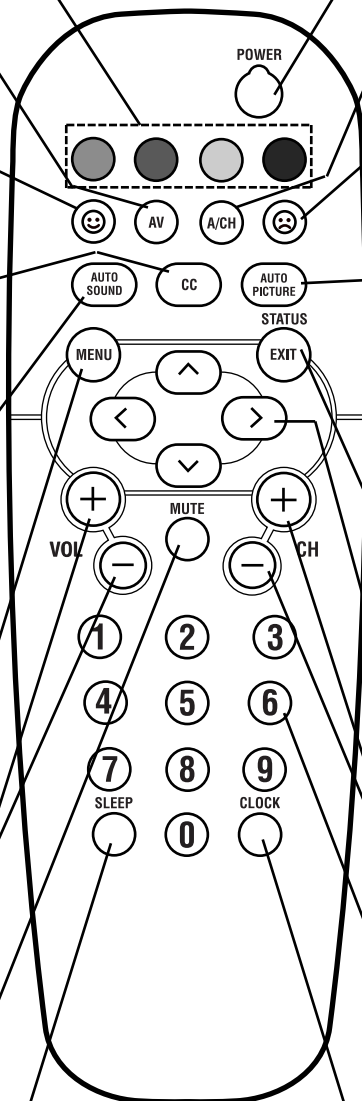

**POWER button** - Press the Power button to turn the TV on or off.

**A/CH Button - (Alternate Channel)** Press to toggle between the last view channel and the channel presently being viewed.

**FROWNIE Button** - Allows you to delete stored channels within the "Quadra Surf" lists for the colored buttons.

**AUTO PICTURE Button** - Press repeatedly to choose from 5 different factory pre-defined picture settings. Choose from Personal (how you set the Picture Menu adjustment controls), Movies (when watching movies), Sports (for any sporting event), Weak Signal (used when the signal being received is not the best), or Multi Media (for use with video gaming).

**STATUS/EXIT Button** - Press to display the current channel number. If the on-screen menu is displayed, press the Status/Exit button will remove it from the TV's screen.

**CURSOR ^, v, <, or > Buttons** - Press to navigate, select and adjust controls within the on-screen menu.

**CH(annel) + or - Buttons** - Press to select channels in ascending or descending order.

**NUMBERED (0-9) Buttons** - Press the numbered buttons to select TV channels or to enter certain values within the on-screen menu. For single channel entries, press the numbered button for the channel you desire. the TV will pause for a second or two before changing to the chosen channel.

**CLOCK Button** - Press to display the "Timer" menu. Within this menu set the time, set the TV to tune to a certain channel at a certain time once, or daily.



# USING THE LANGUAGE CONTROL

*For our Spanish speaking TV owners an on-screen LANGUAGE option is present. With the LANGUAGE control you can set the TV's on-screen menu to be shown in either English or Spanish.*

### BEGIN

- 1 Press the **MENU** button on the remote to show the on-screen menu.
- 2 Press the **CURSOR UP ▲** or **DOWN ▼** buttons to scroll through the on-screen menu until the word **INSTALL** is highlighted.
- 3 Press the **CURSOR RIGHT ►** button to display the **INSTALL** menu features.
- 4 Press **CURSOR UP ▲** or **DOWN ▼** buttons to scroll the Install features until the word **LANGUAGE** is highlighted.
- 5 Press the **CURSOR RIGHT ►** button repeatedly to select **ENGLISH** or **ESPAÑOL** (Spanish).
- 6 When finished, press the **STATUS /EXIT** button to remove the menu from the TV's screen.

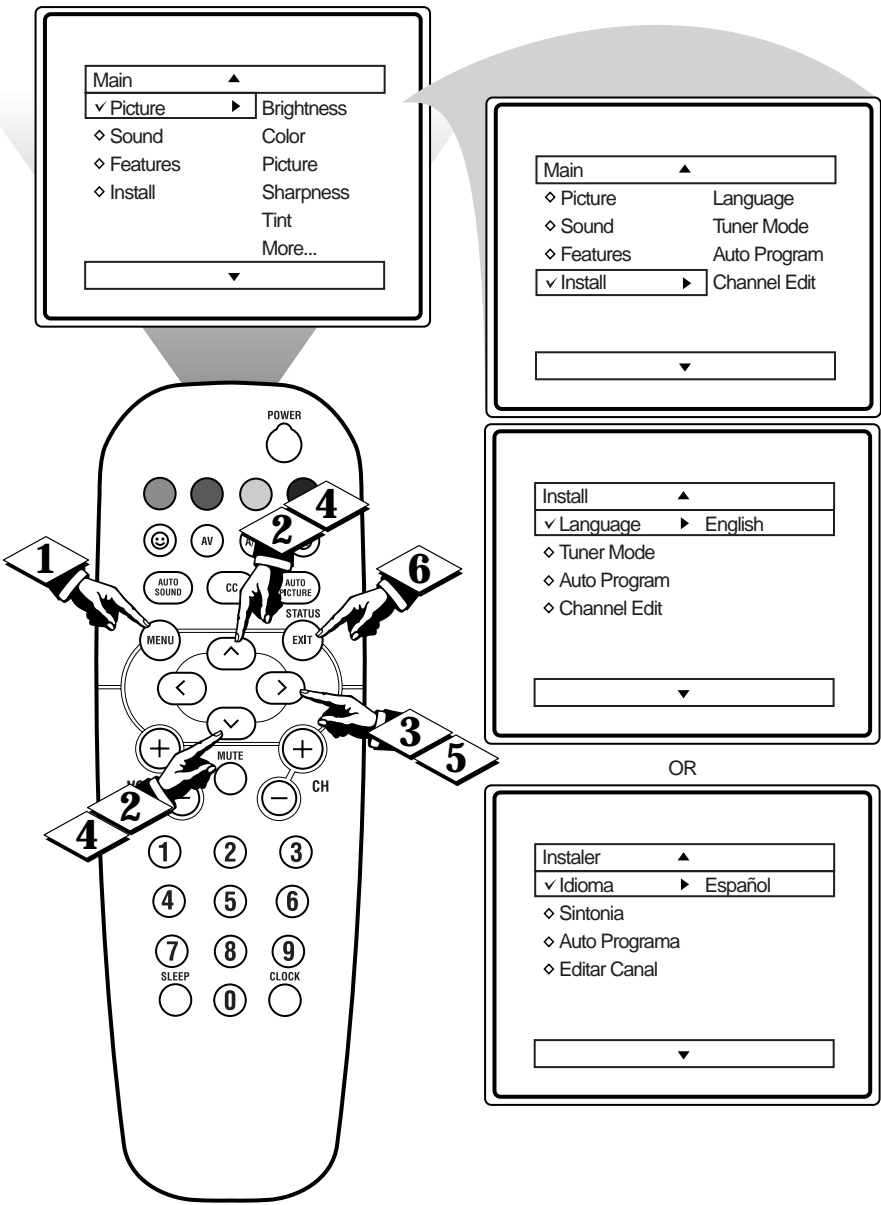

**SMART HELP**

Remember: The Language control only makes the TV's on-screen MENU items appear in English or Spanish text.

It does not change the other on-screen text features such as Closed Caption (CC) TV shows.

# HOW TO USE THE TUNER MODE CONTROL



The **TUNER MODE** control allows you to change the TV's signal input to either **ANTENNA**, **CABLE** or **AUTO** mode. It's important for the TV to know what type of signal to look for. (From a Cable TV signal or a normal Antenna signal.) In the **AUTO** mode, when the **AUTO PROGRAM** feature is activated, the TV will automatically choose the correct mode.

## BEGIN

- 1 Press the **MENU** button on the remote to show the on-screen menu.
- 2 Press the **CURSOR UP ▲** or **DOWN ▼** buttons to scroll through the on-screen menu until the word **INSTALL** is highlighted.
- 3 Press the **CURSOR RIGHT ►** button to display the **INSTALL** menu features.
- 4 Press **CURSOR UP ▲** or **DOWN ▼** buttons to scroll the Install features until the words **TUNER MODE** is highlighted.
- 5 Press the **CURSOR RIGHT ►** button to select either **ANTENNA**, **CABLE**, or **AUTO** mode.
- 6 When finished, press the **STATUS /EXIT** button to remove the on-screen menu from the TV's screen.

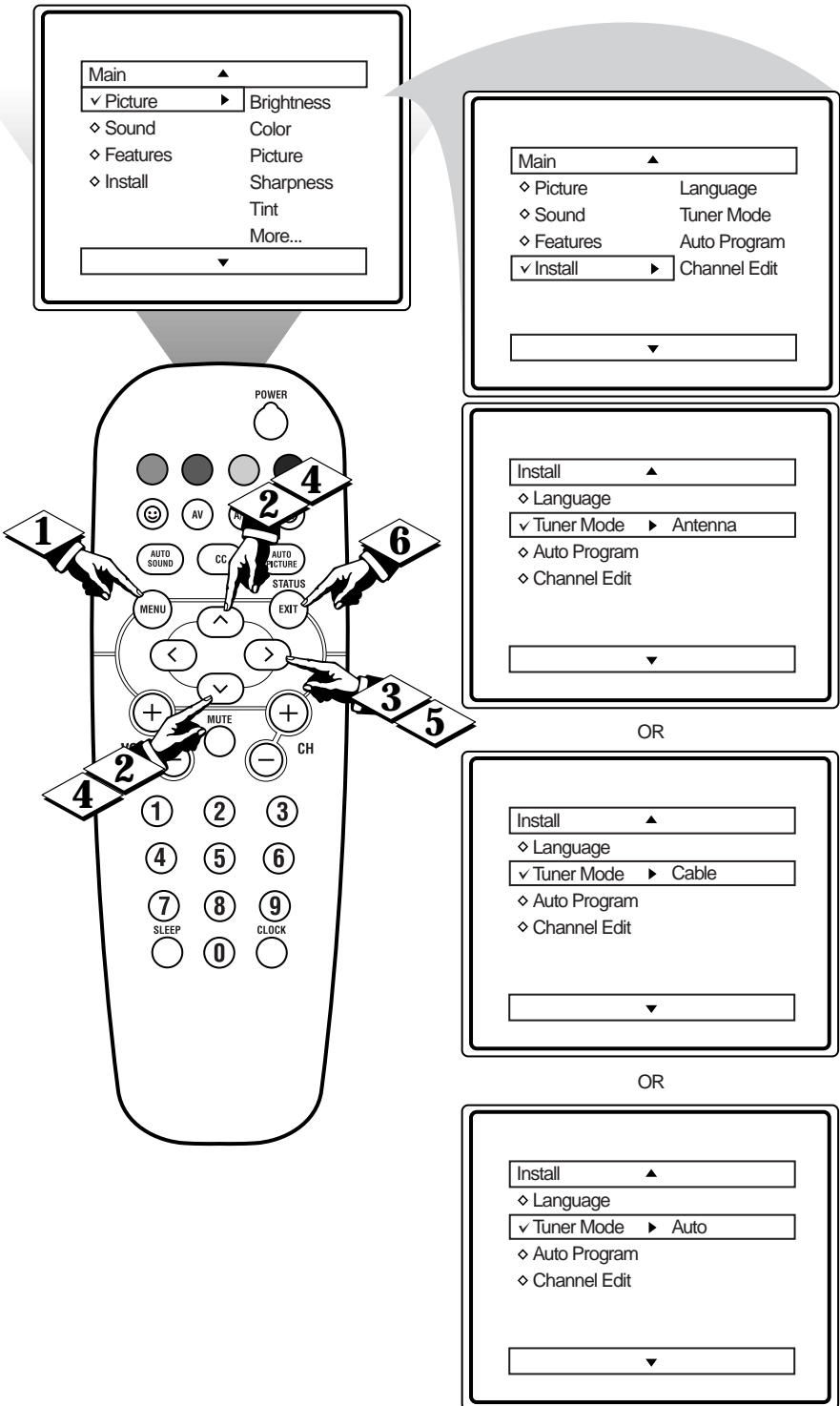

## SMART HELP



When **CABLE** is selected, channels 1-125 are available.

When **ANTENNA** is selected, channels 2-69 are available.

When **AUTO** is selected, the TV will automatically set itself to the correct mode based on the type of signal it detects when the **AUTO PROGRAM** feature is activated.



# HOW TO AUTOMATICALLY PROGRAM TV CHANNELS

Your TV can automatically set itself for local area (or Cable TV) channels. This makes it easy for you to select only the TV stations in your area when the CHANNEL (+), (-) buttons are pressed.

Note: Make sure the antenna or cable signal connection has been completed before AUTO PROGRAM is activated.

## BEGIN

- 1 Press the MENU button on the remote to show the on-screen menu.
- 2 Press the CURSOR UP ▲ or DOWN ▼ buttons to scroll through the on-screen menu until the word INSTALL is highlighted.
- 3 Press the CURSOR RIGHT ► button to display the INSTALL menu features.
- 4 Press CURSOR UP ▲ or DOWN ▼ buttons to scroll the Install features until the words AUTO PROGRAM are highlighted.
- 5 Press the CURSOR RIGHT ► button to start the Auto Program scanning of channels. Auto Programming will store all available channels in the TV's memory then tune to the lowest available channel when done.
- 6 When finished, press the STATUS /EXIT button to remove the menu from the TV's screen.

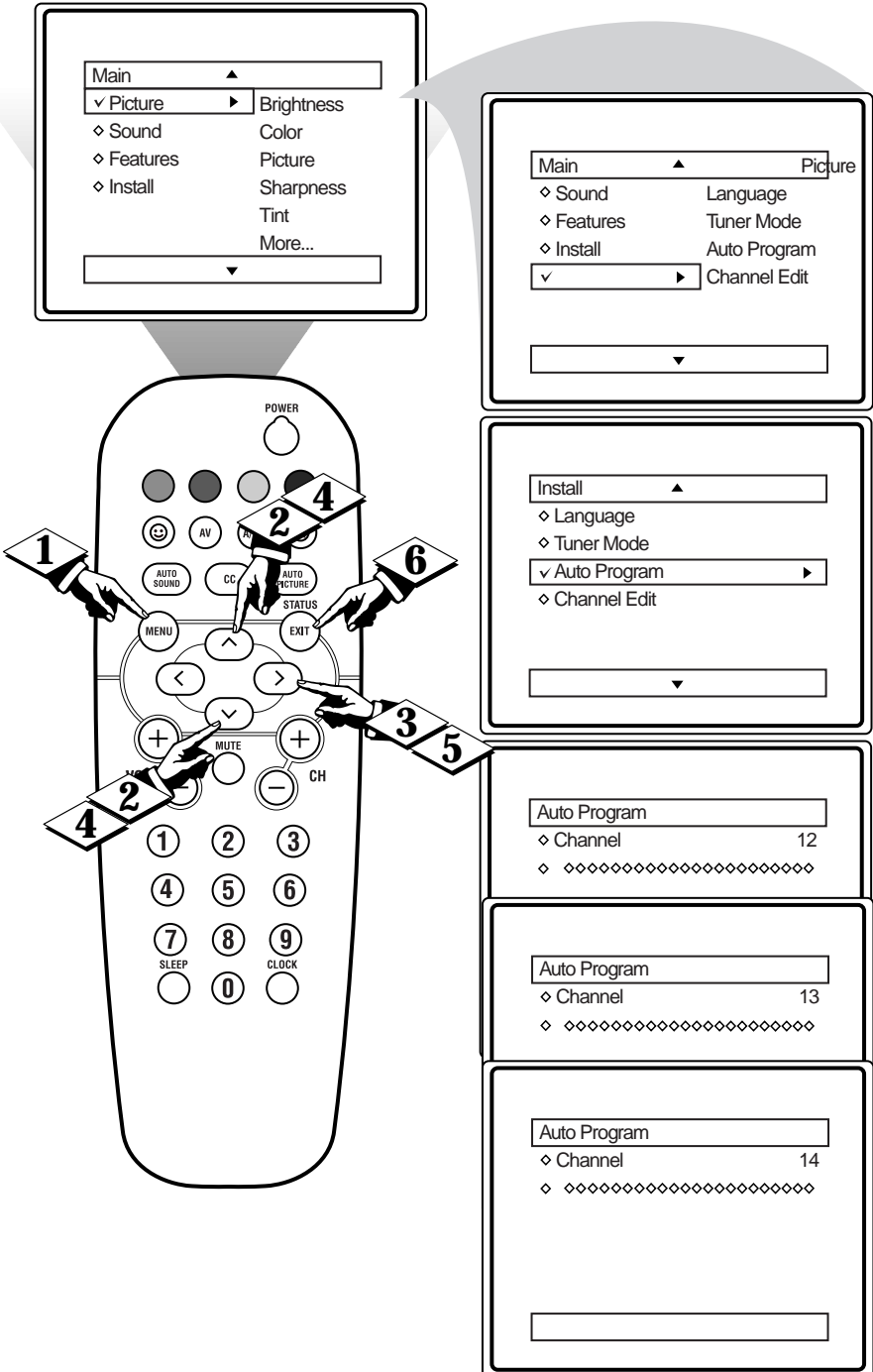

## SMART HELP

Try it out. Press the CHANNEL (+), (-) buttons and see which channels have been added to the TV's memory.

If you want to delete any unwanted channels from the TV's memory, refer to the section on adding and deleting channels (Channel Edit) on the next page.

# HOW TO ADD OR DELETE TV CHANNELS



**C**hannel Edit makes it easy for you to **ADD** or **DELETE** channels from the list of channels stored in the TV's memory.

## BEGIN

- 1 Press the **MENU** button on the remote to show the on-screen menu.
- 2 Press the **CURSOR UP ▲** or **DOWN ▼** buttons to scroll through the on-screen menu until the word **INSTALL** is highlighted.
- 3 Press the **CURSOR RIGHT ►** button to display the **INSTALL** menu features.
- 4 Press the **CURSOR UP ▲** or **DOWN ▼** buttons to scroll the Install features until the words **CHANNEL EDIT** are highlighted.
- 5 Press the **CURSOR RIGHT ►** button to display the **CHANNEL EDIT** options.
- 6 With the **CHANNEL EDIT** options displayed, and **CHANNEL NO.** highlighted; enter the channel number (with the **NUMBERED** or the **CH +** or **-** buttons) you wish to add (Skipped OFF), or delete (Skipped ON) from the TV's memory.
- 7 Scroll down (using the **CURSOR DOWN ▼** button) to highlight the word **SKIPPED**.
- 8 Now use the **CURSOR RIGHT ►** button to toggle between **ON** or **OFF**. If **ON** is selected the channel is skipped when scrolling channels with the **CH +** or **-** buttons. If **OFF** is selected the channel is not skipped when scrolling channels with the **CH +** or **-** buttons.
- 9 When finished, press the **STATUS /EXIT** button to remove the menu from the TV's screen.

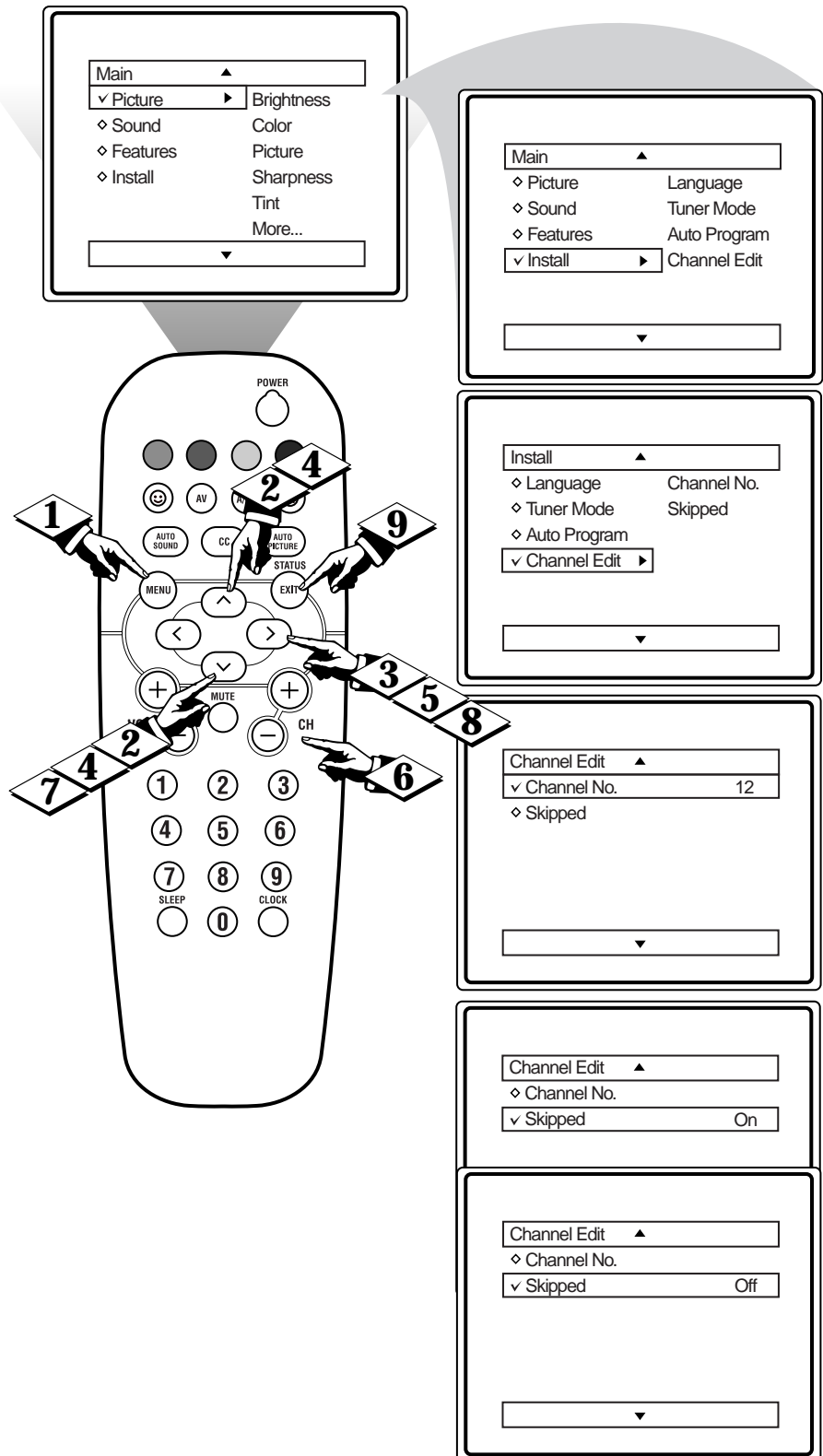

# HOW TO USE THE PICTURE ADJUSTMENT CONTROLS

To adjust your TV picture controls, select a channel and follow the steps shown below:

## BEGIN

- 1 Press the **MENU** button on the remote to display the on-screen menu.
- 2 Press the **CURSOR UP ▲** or **DOWN ▼** buttons until the word **PIC-TURE** is highlighted.
- 3 Press the **CURSOR RIGHT ►** button to display the **PICTURE** menu features.
- 4 Press **CURSOR UP ▲** or **DOWN ▼** buttons to scroll the Picture features and highlight the control you wish to adjust (Brightness, Color, Picture, Sharpness, Tint, or Color Temp.).
- 5 Press the **CURSOR RIGHT ►** or the **CURSOR LEFT ◀** buttons to adjust the selected control or to make selections for the Color Temp. control (Normal, Warm, or Cool).
- 6 Press the **CURSOR UP ▲** or **DOWN ▼** buttons to select and adjust other Picture Menu controls.
- 7 When finished, press the **STATUS /EXIT** button to remove the menu from the TV's screen.

**STOP**

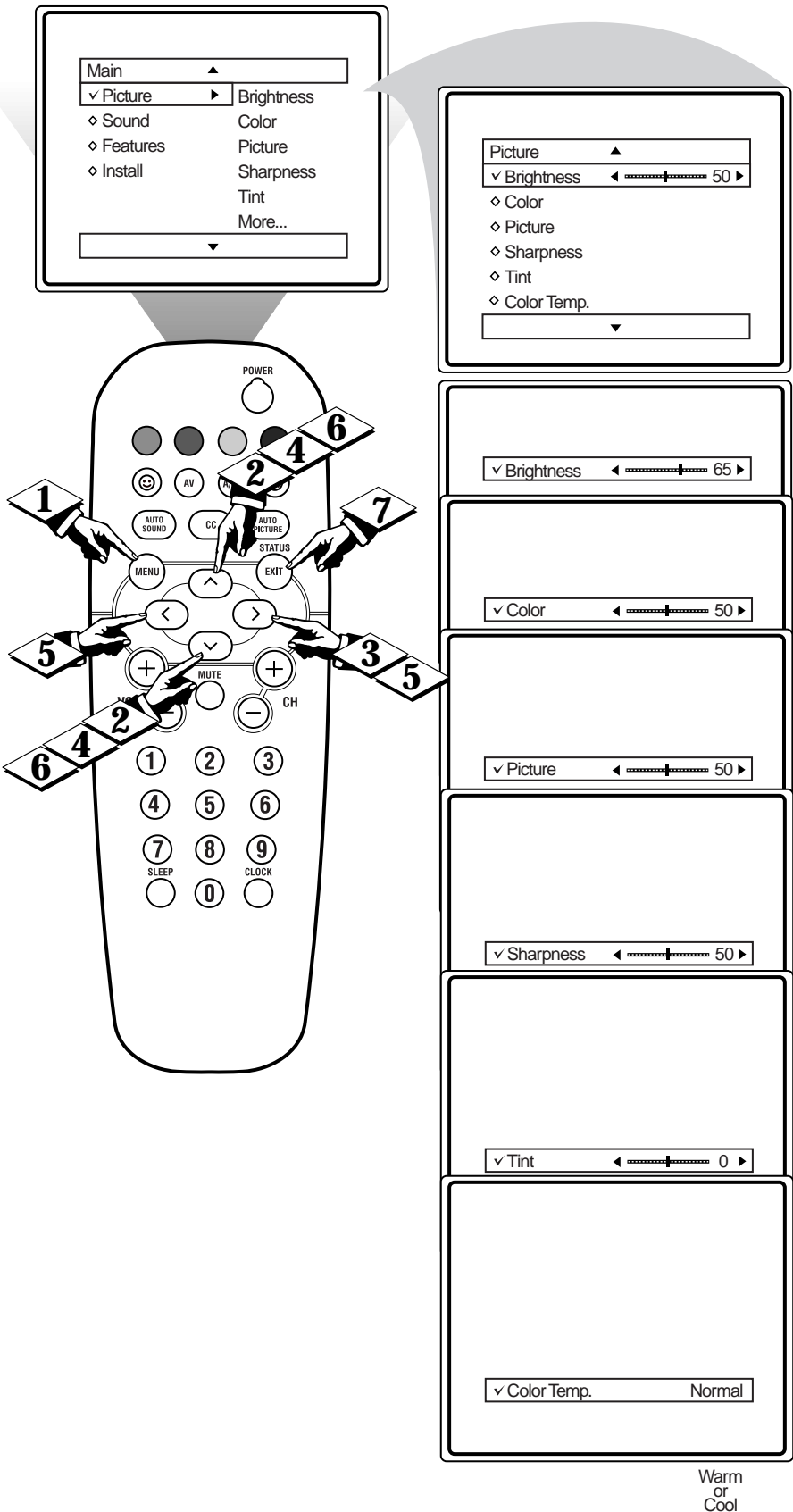

## SMART HELP



**BRIGHTNESS** Press the **►** or **◀** buttons until darkest parts of the picture are as bright as you prefer.

**COLOR** Press the **►** or **◀** buttons to add or eliminate color.

**PICTURE** Press the **►** or **◀** buttons until lightest parts of the picture show good detail.

**SHARPNESS** Press the **►** or **◀** buttons to improve detail in the picture.

**TINT** Press the **►** or **◀** buttons to obtain natural skin tones.

**COLOR TEMP** Press the **►** or **◀** buttons to select **NORMAL**, **COOL**, or **WARM** picture preferences. (**NORMAL** will keep the whites, white; **COOL** will make the whites, bluish; and **WARM** will make the whites, reddish.)



# HOW TO USE THE DNR (NOISE REDUCTION) CONTROL



*For reasons such as poor cable reception, the picture can sometimes appear slightly “speckled” (or has signal noise shown in the picture). The DNR (Dynamic Noise Reduction) control can help eliminate this type of interference and improve the quality of the picture.*

## BEGIN

- 1 Press the **MENU** button on the remote to display the on-screen menu.
- 2 Press the **CURSOR UP ▲** or **CURSOR DOWN ▼** button until the word **PICTURE** is highlighted.
- 3 Press the **CURSOR RIGHT ►** button to display the **PICTURE** menu features.
- 4 Press the **CURSOR UP ▲** or **CURSOR DOWN ▼** button to scroll the Picture menu features until the word **DNR** is highlighted.
- 5 Press the **CURSOR RIGHT ►** button turn the **DNR** feature ON or OFF.
- 6 When finished, press the **STATUS /EXIT** button to remove the menu from the TV's screen.



## SMART HELP



“Noise” Reduction is a video adjustment feature that affects the picture quality of the TV not the sound.

**NOTE:** If the Sharpness control setting is under 50 (see Picture Adjustments on the previous page), the DNR control will have little or no effect to the TV's picture when switched to ON.

The diagram illustrates the steps to use the DNR control. It features a central remote control with numbered arrows (1-6) pointing to specific buttons: 1. MENU, 2. CURSOR UP/DOWN, 3. CURSOR RIGHT, 4. CURSOR UP/DOWN, 5. CURSOR RIGHT, 6. STATUS/EXIT. Surrounding the remote are six inset boxes showing the on-screen menu navigation: 1. Main menu with 'Picture' highlighted. 2. Picture menu with 'Brightness' highlighted. 3. Picture menu with 'DNR' highlighted. 4. Picture menu with 'DNR' set to 'On'. 5. Picture menu with 'DNR' set to 'Off'. 6. Picture menu with 'DNR' set to 'Off'.

# HOW TO USE THE CONTRAST + (BLACK STRETCH) CONTROL

The Contrast + (Black Stretch) control helps to “sharpen” the picture quality. The black portions of the picture become richer in darkness and the whites become brighter.

## **BEGIN**

- 1** Press the **MENU** button on the remote to display the on-screen menu.
- 2** Press the **CURSOR UP ▲** or **CURSOR DOWN ▼** button until the word **PICTURE** is highlighted.
- 3** Press the **CURSOR RIGHT ►** button to display the **PICTURE** menu features.
- 4** Press the **CURSOR UP ▲** or **CURSOR DOWN ▼** button to scroll the Picture menu features until the word **CONTRAST +** is highlighted.
- 5** Press the **CURSOR RIGHT ►** button turn the **CONTRAST +** feature ON or OFF.
- 6** When finished, press the **STATUS /EXIT** button to remove the menu from the TV's screen.

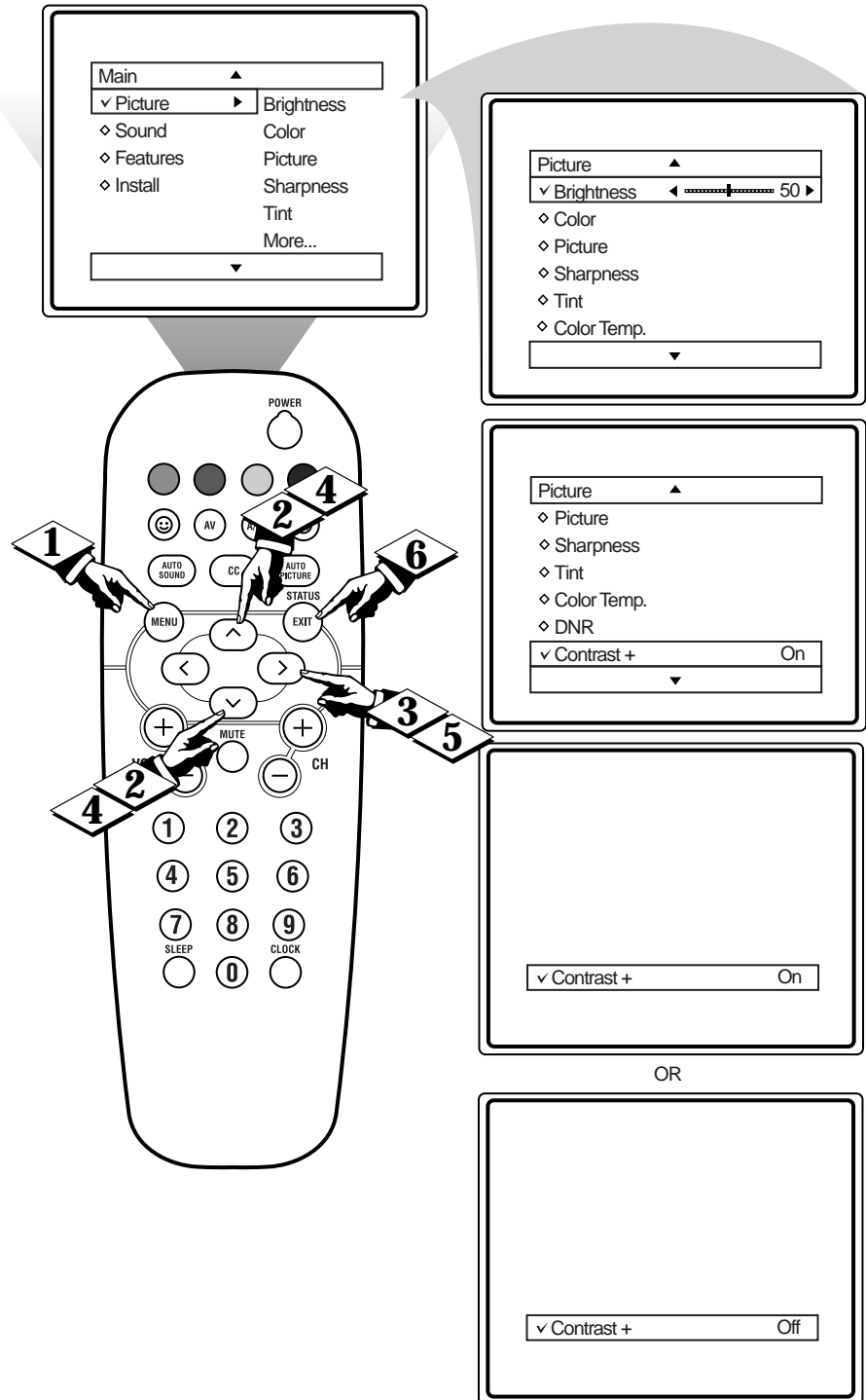



# HOW TO SET THE BASS AND TREBLE BOOST CONTROLS



Besides the normal volume level control, your TV also has Bass and Treble Boost sound controls. The TREBLE Boost effects only the high frequency sound coming from the TV enhancing the highs; while the BASS Boost effects only the low frequency sound coming from the TV enhancing the lows.

## BEGIN

- 1 Press the **MENU** button on the remote to display the on-screen menu.
- 2 Press the **CURSOR UP ▲** or **CURSOR DOWN ▼** button until the word **SOUND** is highlighted.
- 3 Press the **CURSOR RIGHT ►** button to display the **SOUND** menu features.
- 4 Press the **CURSOR UP ▲** or **CURSOR DOWN ▼** button to scroll the Sound menu features until the words **BASS BOOST** or **TREBLE BOOST** are highlighted.
- 5 Press the **CURSOR RIGHT ►** button to turn the Bass or Treble Boost controls ON or OFF.
- 6 When finished, press the **STATUS /EXIT** button to remove the menu from the TV's screen.

STOP

Main ▲  
▼ Picture ▶ Brightness  
◇ Sound Color  
◇ Features Picture  
◇ Install Sharpness  
Tint  
More...  
▼

Main ▲  
◇ Picture Treble Boost  
▼ Sound ▶ Bass Boost  
◇ Features AVL  
◇ Install  
▼

POWER  
MUTE  
CH  
1 2 3  
4 5 6  
7 8 9  
SLEEP 0 CLOCK

1 2 3 4 5 6

Sound ▲  
▼ Treble Boost On  
◇ Bass Boost  
◇ AVL  
▼

▼ Treble Boost On

OR

▼ Treble Boost Off

▼ Bass Boost On

▼ Bass Boost Off



# HOW TO USE THE AVL (AUTOMATIC VOLUME LEVELER) CONTROL

In most cases, the volume levels coming from broadcast programming or commercials are never the same. With the AVL (Audio Volume Leveler) control turned ON, you can have the TV level out sound that is being heard. This makes for a more consistent sound by reducing the peaks and valleys that occur during program changes or commercial breaks. To turn the AVL ON, follow these steps.

## BEGIN

- 1 Press the **MENU** button on the remote to display the on-screen menu.
- 2 Press the **CURSOR UP ▲** or **CURSOR DOWN ▼** button until the word **SOUND** is highlighted.
- 3 Press the **CURSOR RIGHT ►** button to display the **SOUND** menu features.
- 4 Press the **CURSOR UP ▲** or **CURSOR DOWN ▼** button to scroll the Sound menu features until the word **AVL** is highlighted.
- 5 Press the **CURSOR RIGHT ►** button to turn the AVL control ON or OFF.
- 6 When finished, press the **STATUS /EXIT** button to remove the menu from the TV's screen.

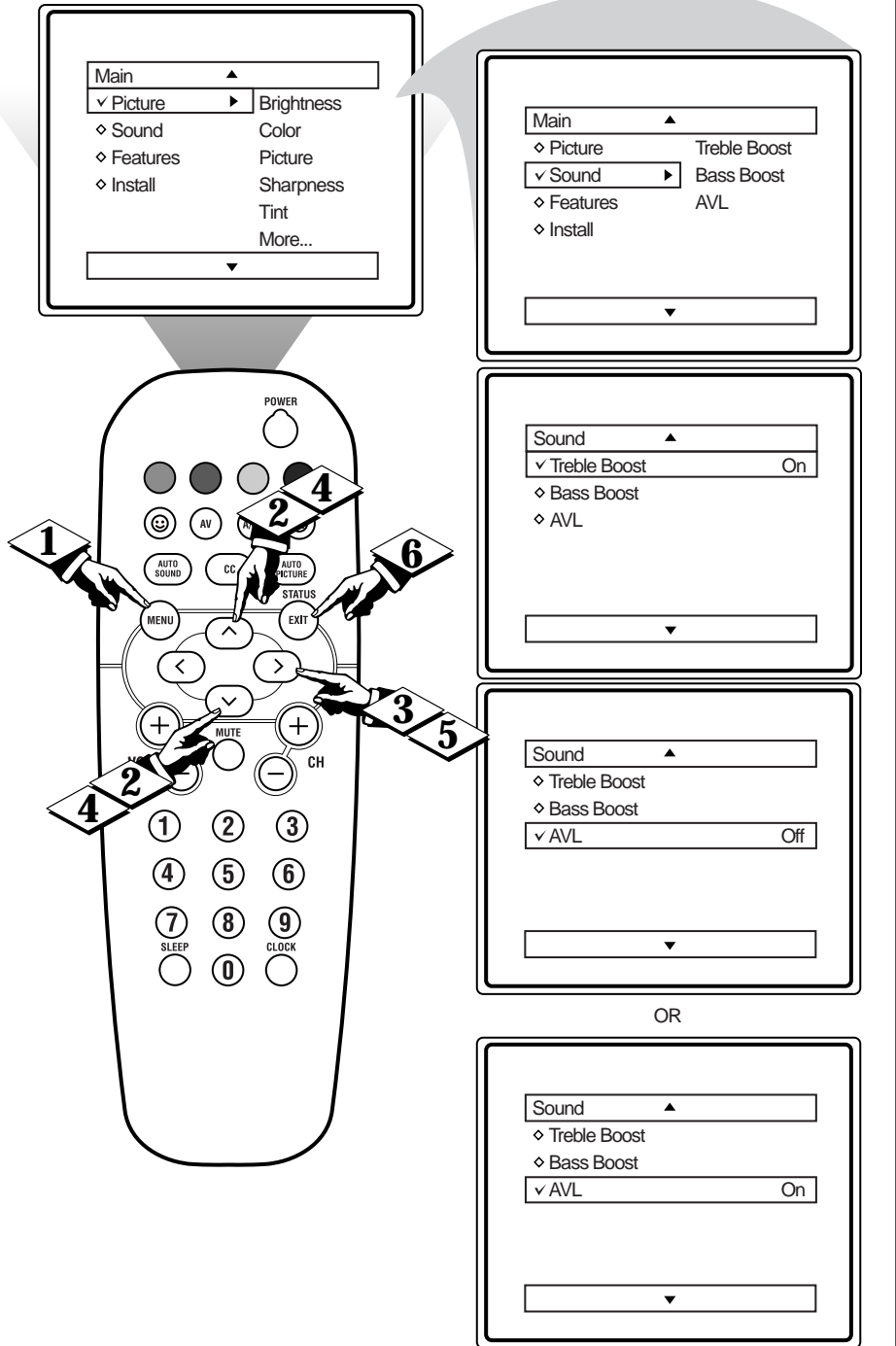

# HOW TO THE TIMER CONTROLS



**T**he Timer controls allow you to use your TV as an alarm clock if set to turn itself on and off at a specific time. It also can be set to tune to a specific channel at a specific time.

## BEGIN

- 1** Press the **CLOCK** button on the remote to display the Timer on-screen menu.
- 2** Press the **CURSOR UP ▲** or **DOWN ▼** button to highlight one of the Timer controls you wish to set (Time, Start Time, Stop Time, Channel, Activate, or Display).

- 3** Press the **CURSOR RIGHT ►** button to adjust the selected option.

**TIME:** Enter the current time with the numbered buttons. Use the Cursor Right button to move to the AM/PM area and use the Cursor Left or Right buttons to toggle AM or PM.

**START TIME:** Use the numbered buttons to enter a start-up time for the TV to turn on or to tune a specific channel.

**STOP TIME:** Use the numbered buttons to enter a time for the TV to shut itself off.

**CHANNEL:** Use the Numbered buttons to select a specific channel for the TV to tune to at the specific Start Time.

**ACTIVATE:** Set the Timer to perform its function **ONCE** or **DAILY**.

**DISPLAY:** Set to **ON** or **OFF**. When **ON**, the time will be displayed permanently while the TV is on. When **OFF** is selected, the time will be displayed whenever the **STATUS/EXIT** button is pressed.

- 4** When finished, press the **STATUS/EXIT** button to remove the menu from the TV's screen.

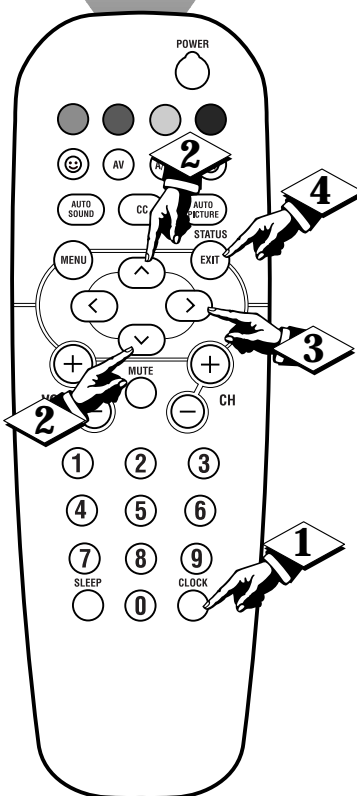
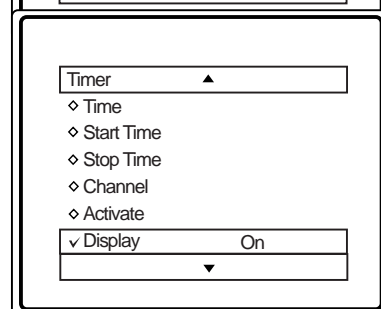
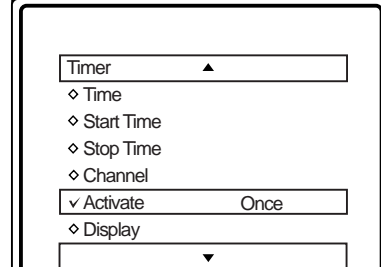
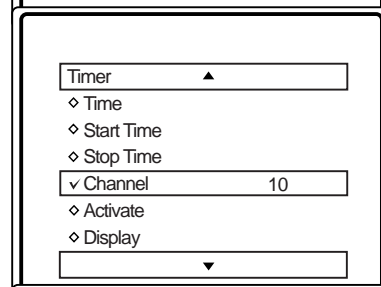
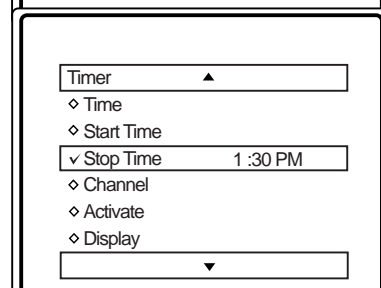
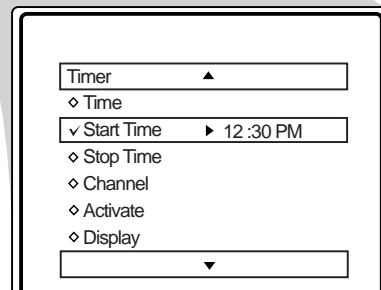
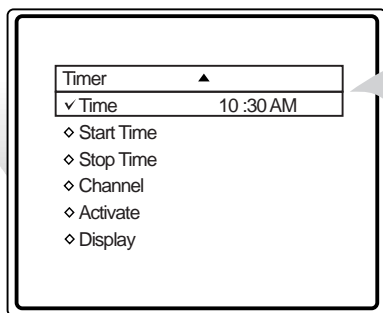



# UNDERSTANDING THE AUTOLOCK CONTROLS

The AutoLock feature is an integrated circuit that receives and processes data sent by broadcasters, or other program providers, that contain program content advisories. When programmed by the viewer, a TV with AutoLock can respond to the content advisories and block program content that may be found objectionable (such as offensive language, violence, sexual situations, etc.). This is a great feature to censor the type of viewing children may watch.

Over the next few pages you'll learn how to block channels and certain rated programming. Below is a brief explanation of some terms and ratings you will find in the AutoLock feature.

**AutoLock offers various BLOCKING controls from which to choose:**

**Access Code:** An Access Code must be set to prevent children from unblocking questionable or censored programming set by their parents.

**Channel Block:** After an access code has been programmed, you can block individual channels including the A/V inputs.

**Clear All:** Allows you clear all channels being blocked from your viewing set with the Channel Block Control.

**Block All:** Allows you to block ALL channels and A/V inputs at one time.

**Movie Ratings:** Certain blocking options exist which will block programming based on ratings patterned by the Motion Pictures Association of America.

**TV Ratings:** Just like the Movie Ratings, programs can be blocked from viewing using standard TV ratings set by TV broadcasters.

To learn more about the Motion Picture Association of America Ratings and the TV Broadcasters Television Ratings, refer to the definitions listed on the columns to the right.

Movie Rating ▲
▼ G On
◇ PG
◇ PG-13
◇ R
◇ NC-17
◇ X
▼

TV Rating ▲
▼ TV-Y On
◇ TV-Y7
◇ TV-G
◇ TV-PG
◇ TV-14
◇ TV-MA
▼

## MOVIE RATINGS

(MOTION PICTURE ASSOCIATION OF AMERICA)

**G: General Audience** - All ages admitted. Most parents would find this program suitable for all ages. This type of programming contains little or no violence, no strong language, and little or no sexual dialogue or situations.

**PG: Parental Guidance Suggested** - This programming contains material that parents may find unsuitable for younger children.) It may contain one or more of the following: Moderate violence, some sexual situations, infrequent coarse language, or some suggestive dialogue.

**PG-13: Parents Strongly Cautioned** - This programming contains material that parents may find unsuitable for children under the age of 13. It contains one or more of the following: violence, sexual situations, coarse language, or suggestive dialogue.

**R: Restricted** - This is programming is specifically designed for adults. Anyone under the age of 17 should only view this programming with an accompanying parent or adult guardian. It contains one or more of the following: intense violence, intense sexual situations, strong coarse language, or intensely suggestive dialogue.

**NC-17: No one under the age of 17 will be admitted.** - This type of programming should be viewed by adults only. It contains graphic violence, explicit sex, or crude indecent language.

**X: Adults Only** - This type of programming contains one or more of the following: very graphic violence, very graphic and explicit or indecent sexual acts, very coarse and intensely suggestive language.

## TV PARENTAL GUIDELINES

(TV BROADCASTERS)

**TV Y** **TV-Y** - (All children -- This program is designed to be appropriate for all children.) Designed for a very young audience, including children ages 2-6. This type of programming is not expected to frighten younger children.

**TV Y7** **TV-Y7** - (Directed to Older Children - This program is designed for children age 7 and above.) It may be more appropriate for children who have acquired the development skills needed to distinguish between make-believe and reality. This programming may include mild fantasy and comic violence (FV).

**TV G** **TV-G** - (General Audience -- Most parents would find this program suitable for all ages.) This type of programming contains little or no violence, no strong language, and little or no sexual dialogue or situations.

**TV PG** **TV-PG** - (Parental Guidance Suggested -- This program contains material that parents may find unsuitable for younger children.) This type of programming contains one or more of the following: Moderate violence (V), some sexual situations (S), infrequent coarse language (L), or some suggestive dialogue (D).

**TV 14** **TV-14** - (Parents Strongly Cautioned - This program contains some material that many parents would find unsuitable for children under 14 years of age.) This type of programming contains one or more of the following: intense violence (V), intense sexual situations (S), strong coarse language (L), or intensely suggestive dialogue (D).

**TV MA** **TV-MA** - (Mature Audience Only -- This program is specifically designed to be viewed by adults and therefore may be unsuitable for children under 17.) This type of programming contains one or more of the following: graphic violence (V), explicit sexual situations (S), or crude indecent language (L).

# SETTING UP THE AUTOLOCK ACCESS CODE



Over the next few pages you'll learn how to block channels and get a better understanding of the rating terms for certain programming.

First, let's start by learning how to set a personal access code:

## BEGIN

- 1 Press the **MENU** button on the remote to display the on-screen menu.
- 2 Press the **CURSOR UP ▲** or **DOWN ▼** button until the word **FEATURES** is highlighted.
- 3 Press the **CURSOR RIGHT ►** button to display the **FEATURES** menu options.
- 4 Press the **CURSOR UP ▲** or **DOWN ▼** button until the words **AUTOLOCK** are highlighted.
- 5 Press the **CURSOR RIGHT ►** button. The screen will read, "ACCESS CODE - - - -."
- 6 Using the **NUMBERED** buttons, enter **0, 7, 1, 1**. "XXXX" appears on the Access Code screen as you press the numbered buttons.  
"INCORRECT CODE" will appear on the screen, and you will need to enter **0, 7, 1, 1** again.
- 7 The screen will ask you to enter a "New Code." Enter a "new" 4 digit code using the **NUMBERED** buttons. The screen will then ask you to **CONFIRM** the code you just entered. Enter your new code again. "XXXX" will appear when you enter your new code and then display the AutoLock menu options.

Proceed to the next page to learn more...

## SMART HELP

Parents - it isn't possible for your child to unblock a channel without knowing your access code or changing it to a new one. If your code changes, and you didn't change it, then you know it's been altered by someone else and blocked channels have been viewed.

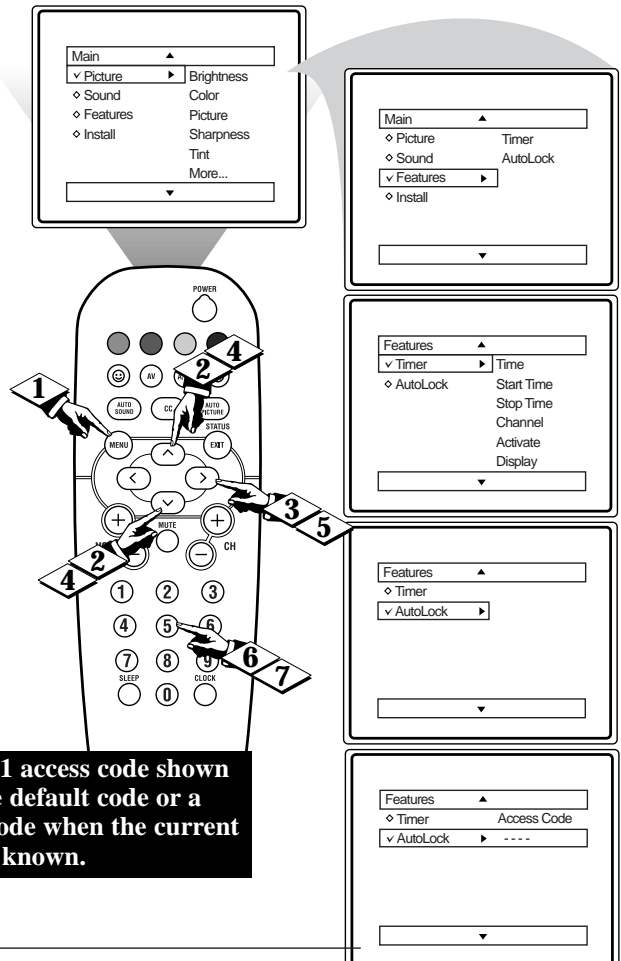

**NOTE: The 0,7,1,1 access code shown on this page is the default code or a way to reset the code when the current access code is not known.**

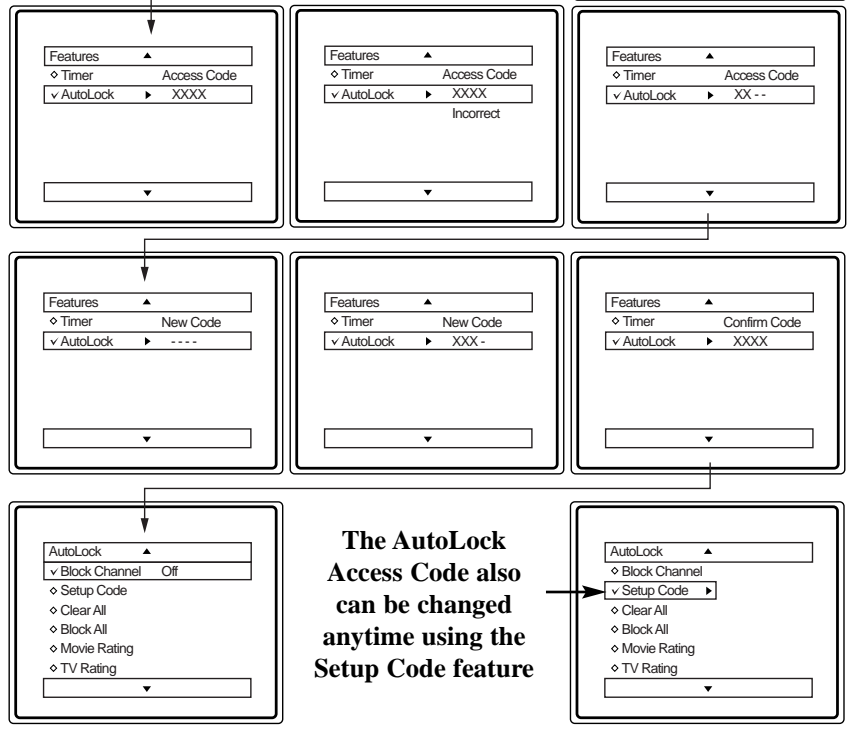

**The AutoLock Access Code also can be changed anytime using the Setup Code feature**



# HOW TO BLOCK CHANNELS

After your personal access code has been set (see previous page), you are now ready to select the channels you want to block out or censor.

## BEGIN

- 1 Press the **NUMBERED (or CH +, -) buttons** to tune the channel you wish to block or censor.
- 2 Press the **MENU button** on the remote to show the on-screen menu.
- 3 Press the **CURSOR UP ▲ or DOWN ▼ button** until the word **FEATURES** is highlighted.
- 4 Press the **CURSOR RIGHT ► button** to display the **FEATURES** menu options.
- 5 Press the **CURSOR UP ▲ or DOWN ▼ button** until the words **AutoLock** are highlighted.
- 6 Press the **CURSOR RIGHT ► button**.
- 7 Enter the correct **access code number**. "XXXX" shows on the Access Code display as you press the **NUMBERED buttons**. AutoLock menu options will be displayed.
- 8 Press the **CURSOR UP ▲ or DOWN ▼ buttons** until the words **BLOCK CHANNELS** are highlighted.
- 9 Press the **CURSOR RIGHT ► button** to turn blocking ON or OFF for that channel. When ON is selected the channel will be blocked.
- 10 Press the **CH + or - button** to select other channels you wish to block. Repeat step 9 to block the new channel.



## SMART HELP

If you tune to a blocked channel and enter your Access Code to view the channel, ALL blocked channels will be viewable until the TV has been turned off. When the TV is powered back ON, the previously blocked channels will be blocked again.

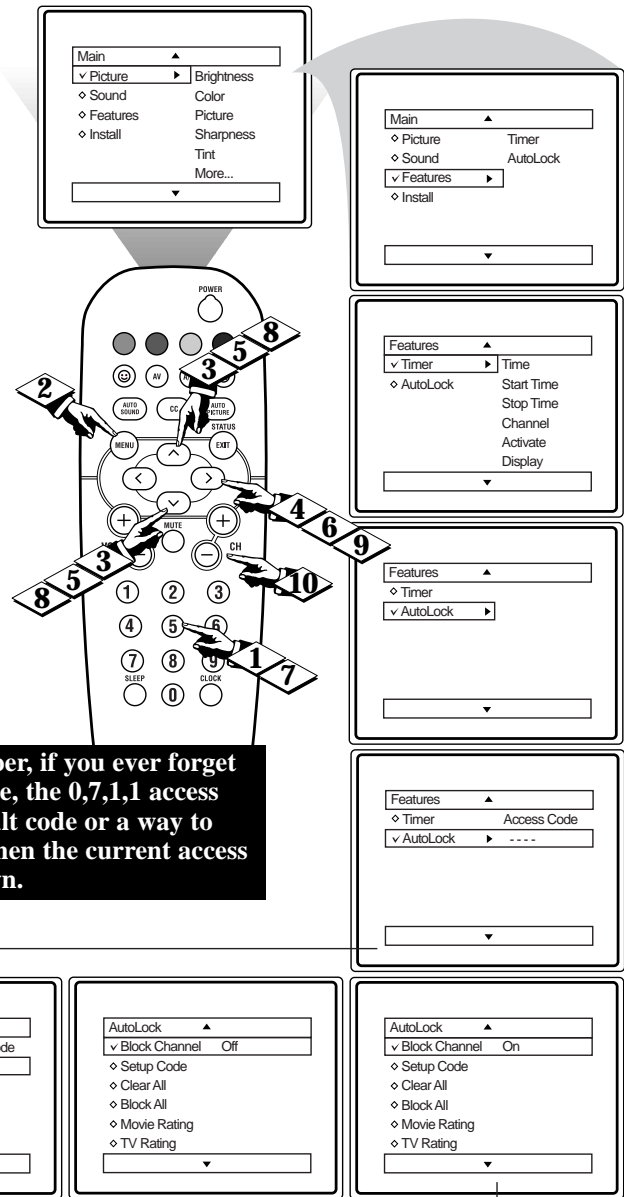

**NOTE:** Remember, if you ever forget your Access Code, the 0,7,1,1 access code is the default code or a way to reset the code when the current access code is not known.

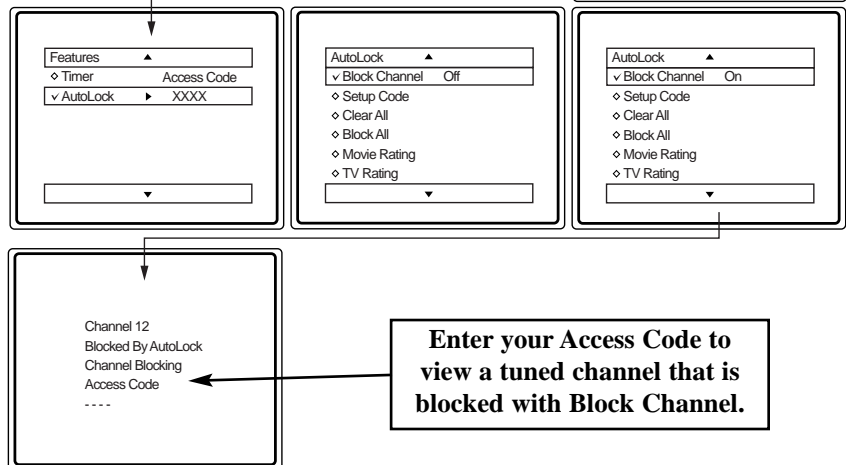

**Enter your Access Code to view a tuned channel that is blocked with Block Channel.**



# HOW TO CLEAR ALL BLOCKED CHANNELS AT THE SAME TIME



After blocking specific channels there may come a time when you want to clear all the channels so they can be viewed. The following steps explain how to CLEAR ALL blocked channels.

## BEGIN

- 1 Press the **MENU** button on the remote to show the on-screen menu.
- 2 Press the **CURSOR UP ▲** or **DOWN ▼** button until the word **FEATURES** is highlighted.
- 3 Press the **CURSOR RIGHT ►** button to display the **FEATURES** menu options.
- 4 Press the **CURSOR UP ▲** or **DOWN ▼** button until the words **AutoLock** are highlighted.
- 5 Press the **CURSOR RIGHT ►** button.
- 6 Enter the correct access code number. "XXXX" shows on the Access Code display as you press the **NUMBERED** buttons. AutoLock menu options will be displayed.
- 7 Press the **CURSOR UP ▲** or **DOWN ▼** buttons until the words **CLEAR ALL** are highlighted.
- 8 Press the **CURSOR RIGHT ►** button to clear all blocked channels. The Clear All option will read, "Cleared."
- 9 When finished, press the **STATUS /EXIT** button to remove the menu from the TV's screen.



## SMART HELP

If you tune to a blocked channel and enter your Access Code to view the channel, ALL blocked channels will be viewable until the TV is powered OFF and then turned back ON. When the TV is powered back ON, the previously blocked channels will be blocked again.

CLEAR ALL will not work with the Movie and TV Ratings. These options must be reset individually.

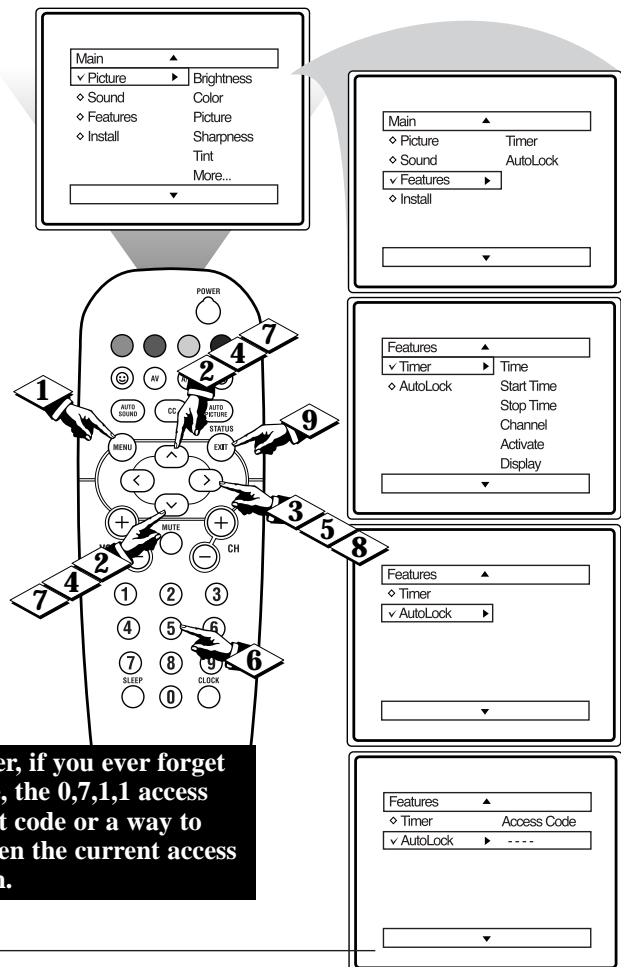

**NOTE:** Remember, if you ever forget your Access Code, the 0,7,1,1 access code is the default code or a way to reset the code when the current access code is not known.

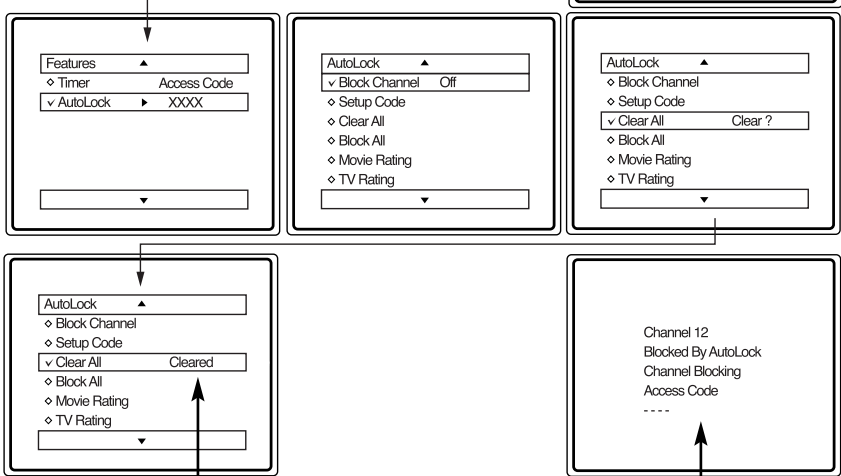

**The Clear All option when activated will unblock ALL blocked channels. It will not affect programming blocked by the Movie or TV Rating options.**

**Or, enter your Access Code to view a tuned channel that is blocked with Block Channel.**

# HOW TO BLOCK ALL CHANNELS AT THE SAME TIME

There may come a time when you want to Block All the television's channels. Maybe you don't want your children to watch TV for a given time. With the Block All control, ALL available channels (including the A/V Inputs) can be set to block at the same time.

## BEGIN

- 1 Press the **MENU** button on the remote to show the on-screen menu.
- 2 Press the **CURSOR UP ▲** or **DOWN ▼** button until the word **FEATURES** is highlighted.
- 3 Press the **CURSOR RIGHT ►** button to display the **FEATURES** menu options.
- 4 Press the **CURSOR UP ▲** or **DOWN ▼** button until the words **AutoLock** are highlighted.
- 5 Press the **CURSOR RIGHT ►** button.
- 6 Enter the correct access code number. "XXXX" shows on the Access Code display as you press the **NUMBERED** buttons. AutoLock menu options will be displayed.
- 7 Press the **CURSOR UP ▲** or **DOWN ▼** buttons until the words **BLOCK ALL** are highlighted.
- 8 Press the **CURSOR RIGHT ►** button to turn Block All ON or OFF. When ON is selected, ALL available channels will be blocked.
- 9 When finished, press the **STATUS/EXIT** button to remove the menu from the screen.

**STOP**

## SMART HELP

If you tune to a blocked channel and enter your Access Code to view the channel, ALL blocked channels will be viewable until the TV has been turned off. When the TV is powered back ON, the previously blocked channels will be blocked again.

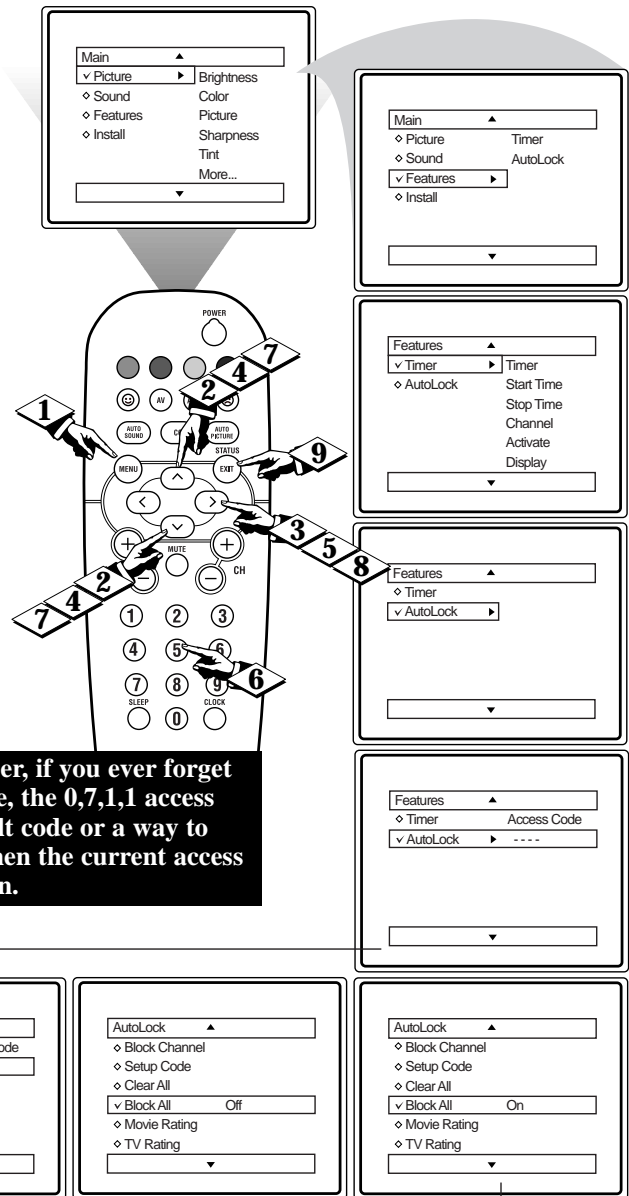

**NOTE:** Remember, if you ever forget your Access Code, the 0,7,1,1 access code is the default code or a way to reset the code when the current access code is not known.

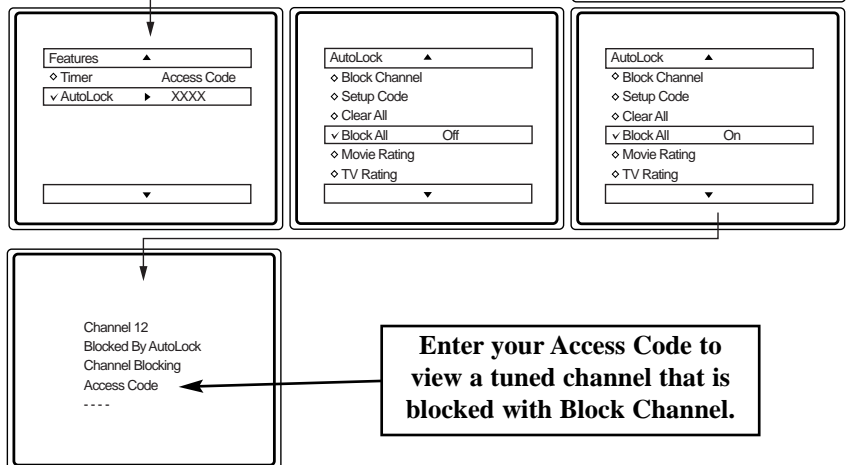

**Enter your Access Code to view a tuned channel that is blocked with Block Channel.**



# BLOCKING PROGRAMMING BASED ON MOVIE RATINGS



There are two types of program ratings within the AutoLock feature. One is based on the Movie Industry ratings while the other is based on the TV Industry ratings. Both can be used to block or censor programming that has been rated in either manner.

Let's first look at the Movie Rating options of AutoLock:

## BEGIN

- 1 Press the **MENU** button on the remote to display the on-screen menu.
- 2 Press the **CURSOR UP ▲** or **DOWN ▼** button until the word **FEATURES** is highlighted.
- 3 Press the **CURSOR RIGHT ►** button to display the **FEATURES** menu options.
- 4 Press the **CURSOR UP ▲** or **DOWN ▼** button until **AutoLock** is highlighted.
- 5 Press the **CURSOR RIGHT ►** button. The screen will prompt you for your Access Code.
- 6 Using the **NUMBERED** buttons on the remote, enter your 4 digit Access Code. The AutoLock menu options will be displayed.
- 7 Press the **CURSOR UP ▲** or **DOWN ▼** button to highlight the words **MOVIE RATINGS**.
- 8 Press the **CURSOR RIGHT ►** button to display the **MOVIE RATINGS** options (G, PG, PG-13, R, NC17, or X).
- 9 Press the **CURSOR UP ▲** or **DOWN ▼** button to highlight any of the Movie Ratings options. When highlighted, all these options can be turned **ON** (which will allow blocking) or **OFF** (which will allow viewing).
- 10 Use the **CURSOR RIGHT ►** button on the remote to turn the rating option ON or OFF.

**STOP**

## SMART HELP

When a rating is set to block, all higher ratings will be automatically blocked as well. (Example: If the PG-13 rating is set to block, the R, NC-17, and X ratings will also be blocked.)

Each Movie Rating can be turned "ON" or "OFF."

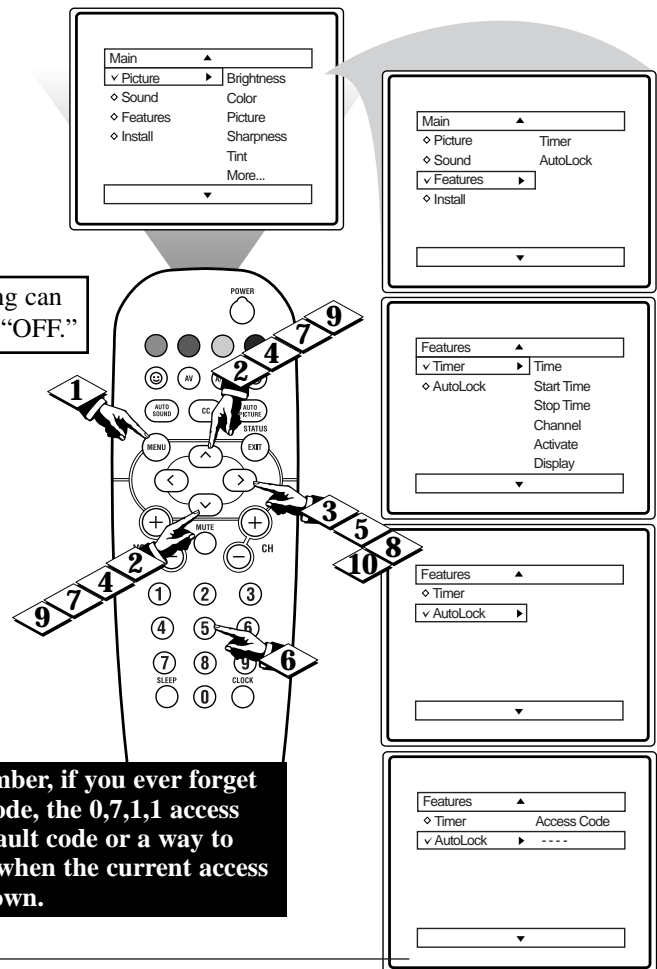

**NOTE: Remember, if you ever forget your Access Code, the 0,7,1,1 access code is the default code or a way to reset the code when the current access code is not known.**

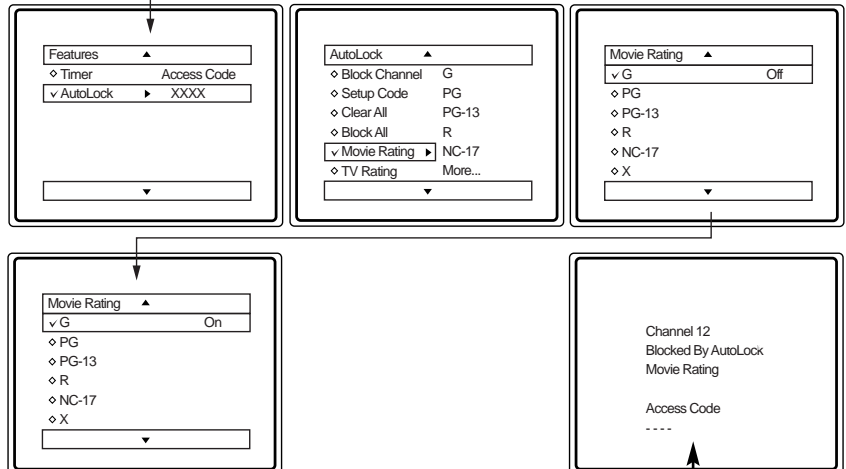

To view a program blocked by the Movie Rating options, enter your 4 digit access code. This will disable all blocked Movie Ratings until the TV is powered off and on again. Then the blocking options will be restored.

# BLOCKING PROGRAMMING BASED ON TV RATINGS

This portion of the AutoLock features cover program ratings based on the TV Industry rating system. This is known as TV Ratings within AutoLock.

After selecting the Autolock feature and entering your personal access code, the AutoLock options screen appears;

## BEGIN

- 1 Scroll the menu using the CURSOR UP ▲ or DOWN ▼ buttons until the words TV RATINGS are highlighted.
- 2 Press the CURSOR RIGHT ► button to display the TV Ratings (TV-Y, TV-Y7, TV-G, TV-PG, TV-14, or TV-MA). When highlighted, the TV-Y and TV-G can be turned ON (which will allow blocking) or OFF (which will allow viewing), of these rated programs. The ratings of TV-Y7, TV-PG, TV-14, TV-MA can be customized to block V (violence), FV (fantasy violence), S (sexual situations), L (coarse language), or D (suggestive dialogue).
- 3 Press the CURSOR UP ▲ or DOWN ▼ button to highlight the desired rating.
- 4 Press the CURSOR RIGHT ► button on the remote to turn the TV-Y or TV-G rating ON or OFF. Or, press the CURSOR RIGHT ► button to enter the sub-menus for the TV-Y7, TV-PG, TV-14 or TV-MA ratings.
- 5 If the TV-Y7, TV-PG, TV-14 or TV-MA sub-menu is accessed, press the CURSOR UP ▲ or CURSOR DOWN ▼ button to select one of the options (Block All, V, S, L, D, or FV).
- 6 Press the CURSOR RIGHT ► button on the remote to turn the option ON or OFF.



To view a program blocked by the TV Rating options, enter your 4 digit access code. This will disable all blocked TV Ratings until the TV is powered off and on again. Then the blocking options will be restored.

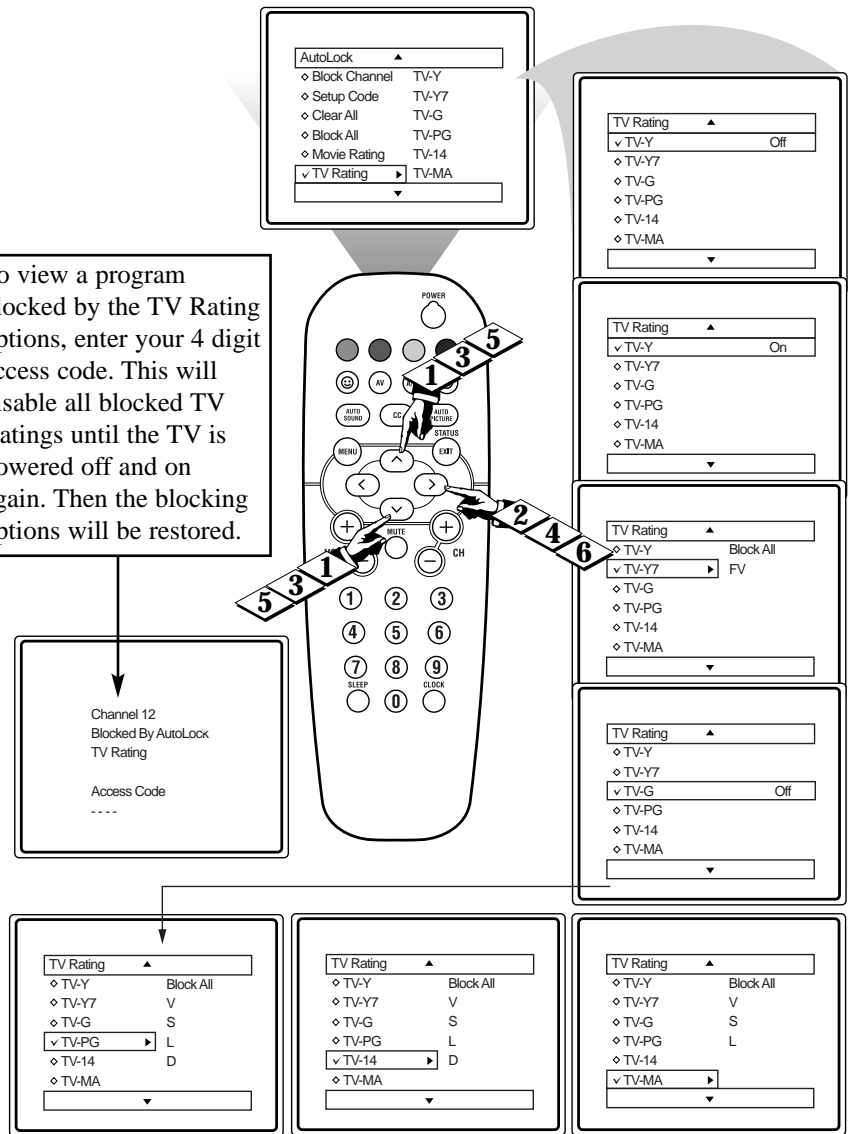

Channel 12  
Blocked By AutoLock  
TV Rating  
Access Code  
----

TV Rating ▲  
◊ TV-Y Block All  
◊ TV-Y7 V  
◊ TV-G S  
▼ TV-PG L  
◊ TV-14 D  
◊ TV-MA

TV Rating ▲ Block All  
◊ TV-Y Block All  
◊ TV-Y7 V  
◊ TV-G S  
▼ TV-PG L  
▼ TV-14 D  
◊ TV-MA

TV Rating ▲ Block All  
◊ TV-Y Block All  
◊ TV-Y7 V  
◊ TV-G S  
▼ TV-PG L  
▼ TV-14  
▼ TV-MA

**TV Ratings and Rating Sub-Menus**  
When a TV Rating is selected to block, ALL higher ratings will be blocked also.

- TV-Y** - (All children -- *This program is designed to be appropriate for all children.*) Designed for a very young audience, including children ages 2-6. This type of programming is not expected to frighten younger children.
- TV-Y7** - (Directed to Older Children -- *This program is designed for children age 7 and above.*) It may be more appropriate for children who have acquired the development skills needed to distinguish between make-believe and reality. This programming may include mild fantasy and comic violence (FV).
- TV-G** - (General Audience -- *Most parents would find this program suitable for all ages.*) This type of programming contains little or no violence, no strong language and little or no sexual dialogue or situations.
- TV-PG** - (Parental Guidance Suggested -- *This program contains material that parents may find unsuitable for younger children.*) This type of programming contains one or more of the following: some suggestive dialogue (D), infrequent coarse language (L), some sexual situations (S), or moderate violence (V).
- TV-14** - (Parents Strongly Cautioned -- *This program contains some material that many parents would find unsuitable for children under 14 years of age.*) This type of programming contains one or more of the following: intensely suggestive dialogue (D), strong coarse language (L), intense sexual situations (S), or intense violence (V).
- TV-MA** - (Mature Audience Only -- *This program is specifically designed to be viewed by adults and therefore may be unsuitable for children under 17.*) This type of programming contains one or more of the following: crude indecent language (L), explicit sexual situations (S), or graphic violence (V).

# USING THE AUTOLOCK BLOCKING OPTIONS



AutoLock offers the viewer other blocking features as well. With these Blocking Options, the censoring can be turned ON or OFF.

## BEGIN

- 1 Press the **MENU** button on the remote to show the on-screen menu.
- 2 Press the **CURSOR UP ▲** or **DOWN ▼** button until the word **FEATURES** is highlighted.
- 3 Press the **CURSOR RIGHT ►** button to display the **FEATURES** menu options.
- 4 Press the **CURSOR UP ▲** or **DOWN ▼** button until the words **AutoLock** are highlighted.
- 5 Press the **CURSOR RIGHT ►** button.
- 6 Enter the correct access code number. "XXXX" shows on the Access Code display as you press the **NUMBERED** buttons. AutoLock menu options will be displayed.
- 7 Press the **CURSOR UP ▲** or **DOWN ▼** buttons until the words **BLOCKING OPTIONS** are highlighted.
- 8 Press the **CURSOR RIGHT ►** button to display the **Blocking Options (BLOCKING, UNRATED, or NO RATING)** menu.
- 9 Press the **CURSOR UP ▲** or **DOWN ▼** buttons to highlight the desired feature.
- 10 When highlighted, each feature can be turned **ON** or **OFF** using the **CURSOR RIGHT ►** or **LEFT ◀** buttons on the remote.

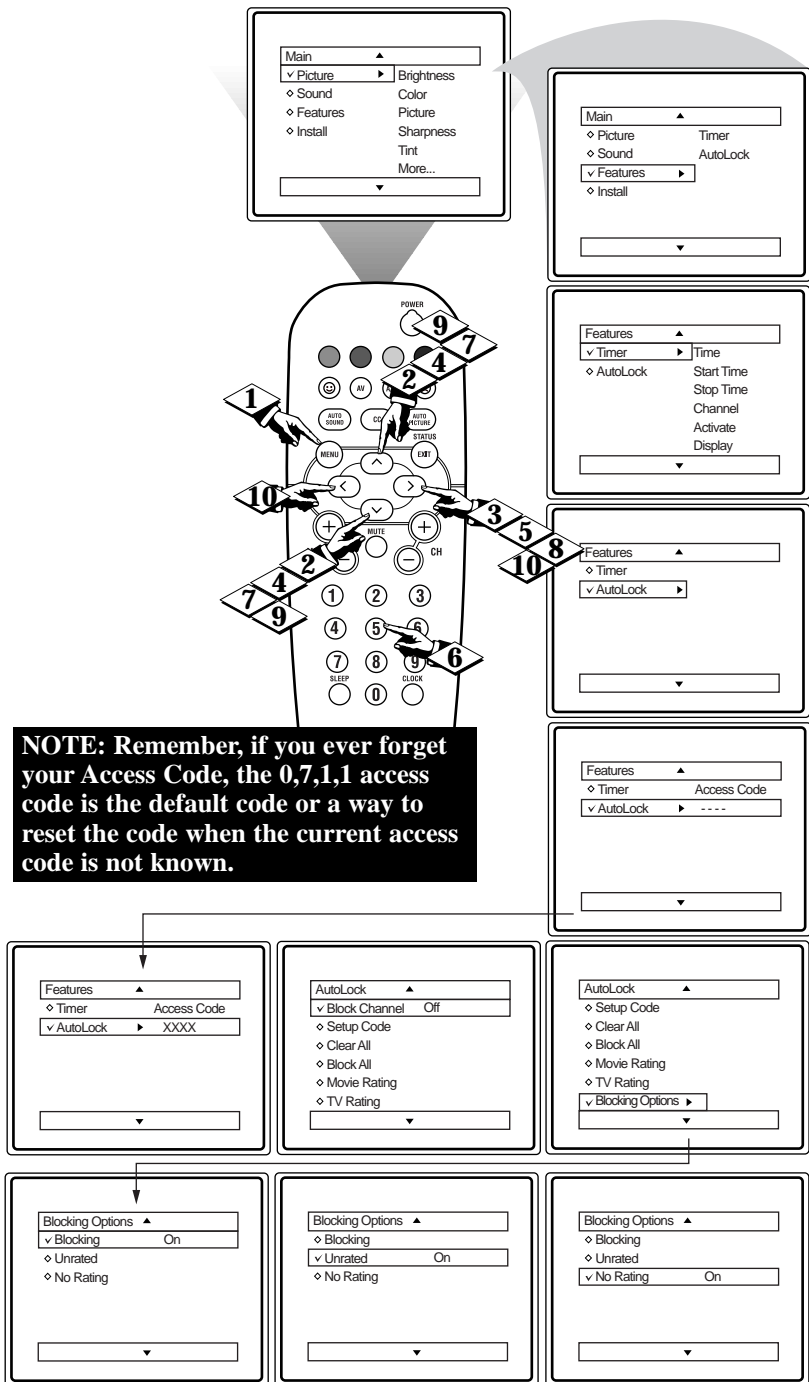

**NOTE: Remember, if you ever forget your Access Code, the 0,7,1,1 access code is the default code or a way to reset the code when the current access code is not known.**

## BLOCKING OPTIONS:

**BLOCKING:** This is what might be called the "master switch" for AutoLock. When in the ON position, ALL blocking/censoring will take place. When in the OFF position, ALL blocking is disabled.

**UNRATED:** ALL unrated programs based on the Movie Ratings or Parental (TV) Guidelines can be blocked if this feature is set to ON and the **BLOCKING** feature is set to OFF.

**NO RATING:** ALL programming with NO content advisory data can be blocked if this feature is set to ON and the **BLOCKING** feature is set to OFF.



# HOW TO USE THE CLOSED CAPTION CONTROL

**C**losed Captioning (CC) allows you to read the voice content of television programs on the TV screen. Designed to help the hearing impaired, this feature uses on-screen "text boxes" to show dialogue and conversations while the TV program is in progress.

## BEGIN

- 1** Press the **CC** button on the remote to display the current Closed Caption setting.
- 2** Press the **CC** button repeatedly to choose from the four Closed Caption options (CC Off, CC 1, CC 2, CC Mute). Dialogue (and descriptions) for the action on the captioned TV program will appear on-screen if the tuned program is broadcasting CC information.
- 3** When finished, press the **STATUS/EXIT** button to remove the menu from the TV's screen or let the option time out and disappear from the TV screen.



## SMART HELP

**Not all TV programs and product commercials** are made with Closed Caption (CC) information included. Neither are all Closed Caption modes (CC1, or CC2) necessarily being used during the transmission of a closed caption program. Refer to your area's TV program listings for the stations and times of Closed Caption shows.

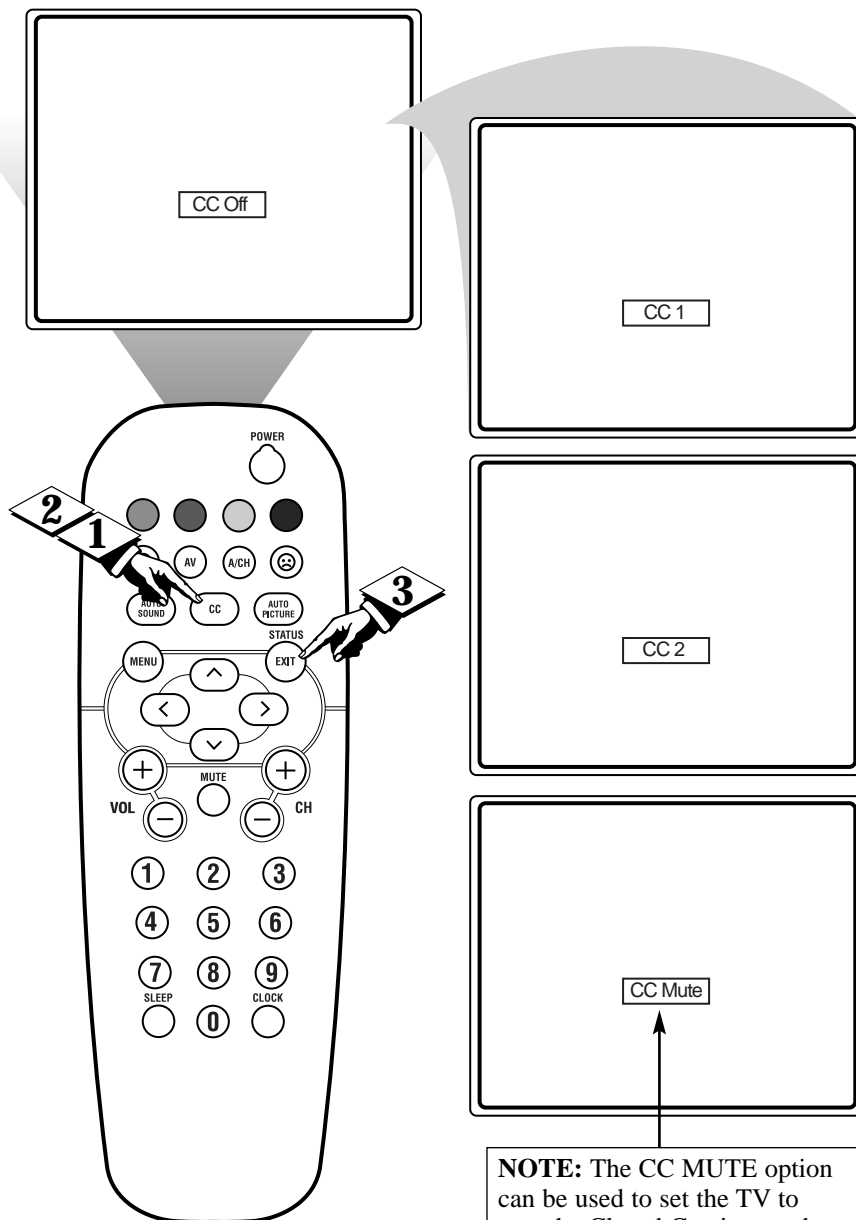

**NOTE:** The CC MUTE option can be used to set the TV to turn the Closed Caption mode "ON" whenever the MUTE button on the remote is pressed. This activates the CC1 option. MUTE will appear smaller in the upper center of the screen.

# SETTING UP THE SLEEPTIMER OPTION



*Have you ever fallen asleep in front of the TV only to have it wake you up at two in the morning with a test pattern screeching in your ears? Well, your TV can save you all that trouble by automatically turning itself off.*

## BEGIN

**1** Press the **SLEEP** button on the remote control and the SLEEP timer display will appear on the screen.

**2** Press the **SLEEP** button repeatedly to pick the amount of time (15, 30, 45, 60, 90, 120, 180, or 240 minutes) before the TV will turn itself off.

An on-screen count down will appear during the last minute before the TV shuts itself off.



## SMART HELP

The on-screen menu will time out and disappear from the screen when you finish, or you can press the **STATUS/EXIT** button to clear the menu from the screen.

After setting the Sleptimer, pressing the **STATUS/EXIT** button will display the time remaining before the TV will shut itself off.

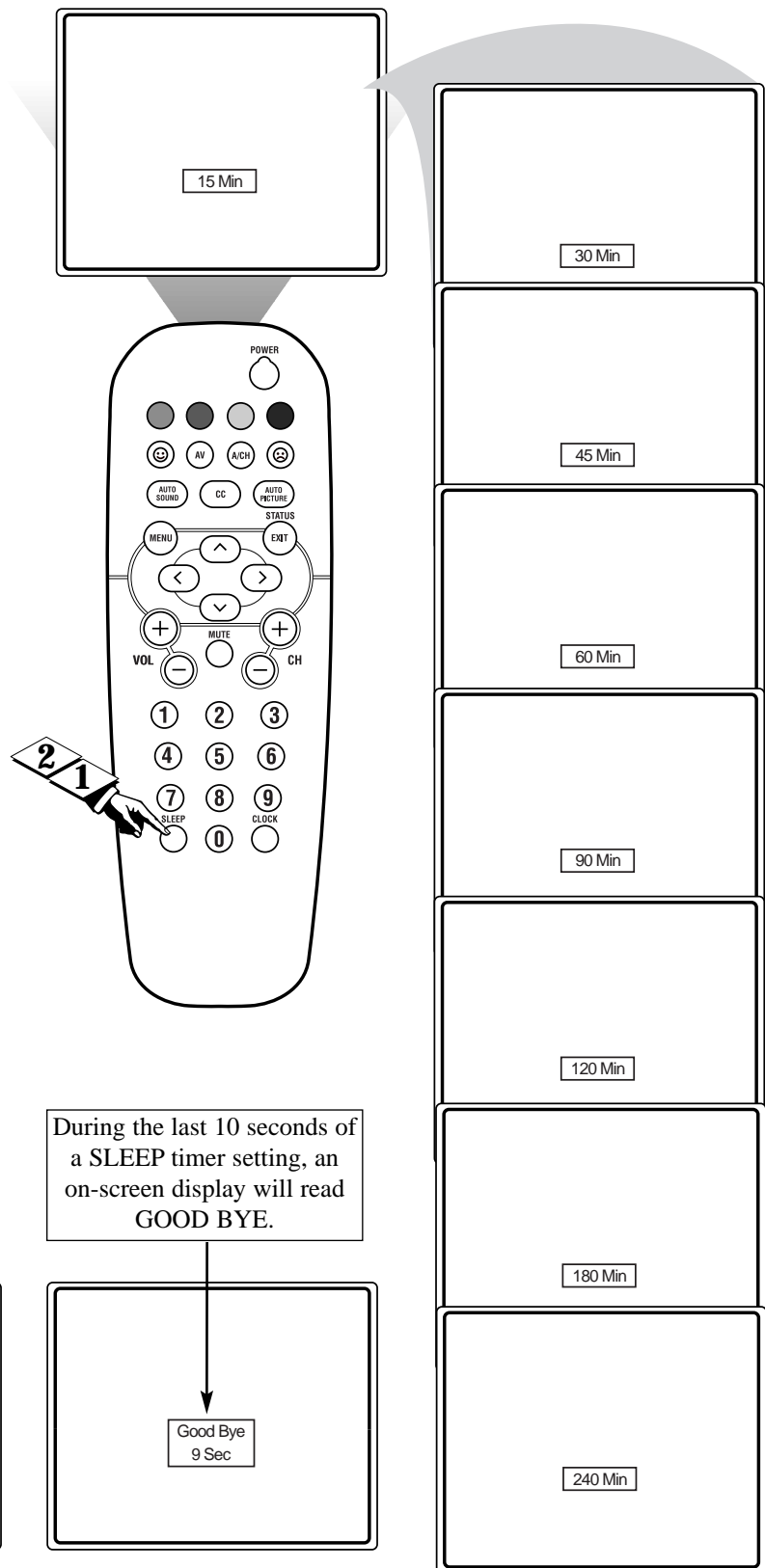



## SETTING THE AUTO PICTURE CONTROL

Whether you're watching a movie or a sporting event, your TV has automatic video control settings matched for your current program source or content. The Auto Picture feature quickly resets your TV's video controls for a number of different types of programs and viewing conditions you may have in your home. Each Auto Picture setting is preset at the factory to automatically adjust the TV's Brightness, Color, Picture, Sharpness, Tint, Color Temperature, DNR and Contrast+ levels.

### BEGIN

**1** Press the **AUTO PICTURE** button on the remote control. The current Auto Picture setting will appear in the middle of the screen.

**2** Press the **AUTO PICTURE** button repeatedly to select either **PERSONAL**, **MOVIES**, **SPORTS**, **WEAK SIGNAL**, or **MULTI MEDIA** picture settings.

**Note:** The **PERSONAL** setting is the setting that you setup using the **PICTURE** options within the on-screen menu. This is the only Auto Picture setting that can be changed. All other settings are setup at the factory during the time of production.

**MOVIES** - Preset picture options for watching Video Tapes, or DVDs.

**SPORTS** - Preset picture options for watching sporting events.

**WEAK SIGNAL** - Preset picture options for watching programs where the reception is not at its best.

**MULTI MEDIA** - Preset picture options for use with video gaming.

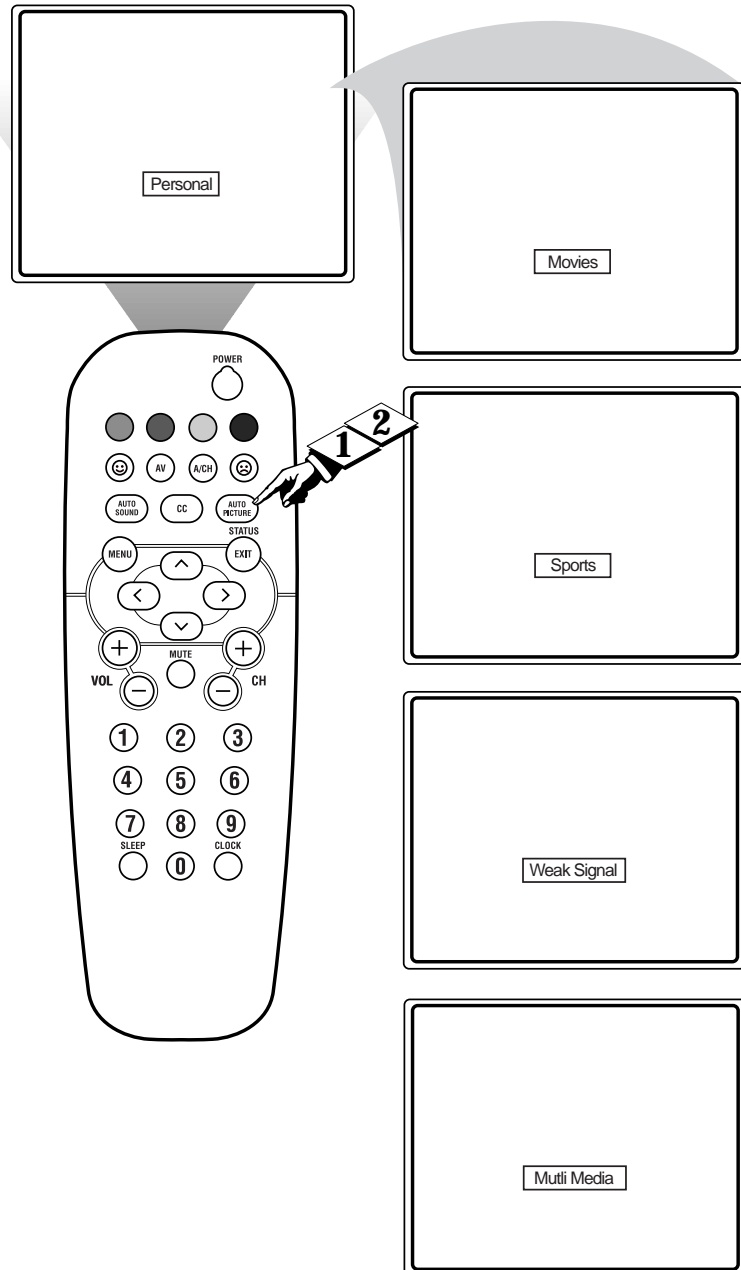

# SETTING THE AUTO SOUND CONTROL



**T**he Auto Sound feature allows the listener to select between four different factory set sound options. Personal (which can be set by the user), Theatre (for movie viewing), Music (for musical type programming) and Voice (when the program is mainly dialogue). These settings affect the Sound menu's Bass, Treble, AVL, and Incredible Surround controls.

To select any of the options follow the directions below.

## BEGIN

**1** Press the **AUTO SOUND** button on the remote control. The current Auto Sound setting will appear in the middle of the screen.

**2** Press the **AUTO SOUND** button repeatedly to toggle between the four settings.

**Note:** Only the **PERSONAL** control can be changed by the viewer. This changes the settings in the main on-screen menu's sound controls.

**THEATRE** - Preset sound options for watching movies.

**MUSIC** - Preset sound options for musical programming where there is little dialogue.

**VOICE** - Preset sound options for programming where heavy dialogue is present.

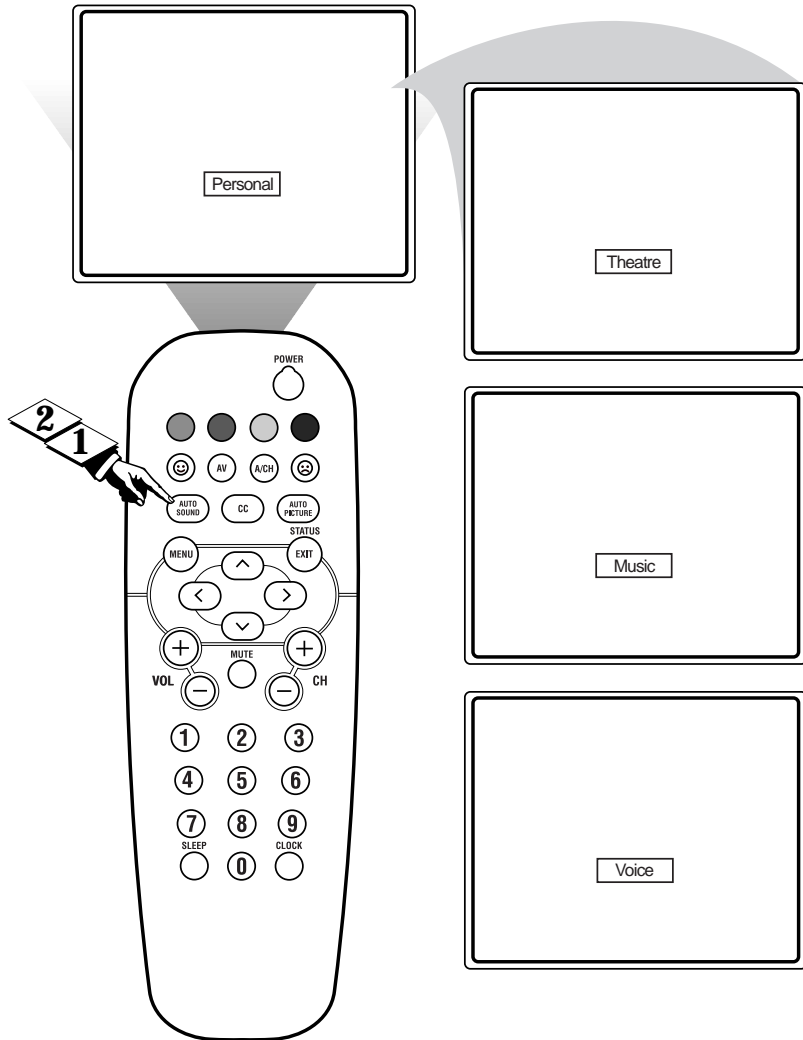





# USING THE QUADRA SURF BUTTONS

A "list" or series of previously viewed channels can be selected with the Quadra SURF (colored) buttons on your remote control. With this feature you can easily switch between different TV programs that currently interest you. The Quadra Surf control allows you set up four different personal Surf lists using the colored buttons (on the remote control), each holding up to ten channels in its quick viewing "list."

## BEGIN

- 1 Press the CHANNEL (+) or (-) buttons (or the NUMBER buttons) to select a channel to add to one of the SURF lists.
- 2 Press the SMILEY ☺ button on the remote control to ADD the channel to one of the SURF lists.
- 3 Press the corresponding COLORED (Red, Green, Yellow or Blue) button to add the channel to that button's Surf list. (Up to ten channels per button can be stored.)

Repeat steps 1 through 3 to add additional channels (up to 10) to each of the SURF lists.

To remove a channel from one of the SURF lists;

- 4 Press the COLORED Quadra Surf button until the desired channel appears. The screen will display the channel number with a colored "Smiley" face to indicate the Colored button it relates to.
- 5 While the "Smiley" face channel indicator is displayed, press the FROWNIE ☹ face button. The screen will read, "Remove item? - Press ☹ ."
- 6 Press the FROWNIE ☹ face button again to confirm your decision to remove the channel from the Surf list.

Repeat steps 4-6 to remove other channels from Surf lists.

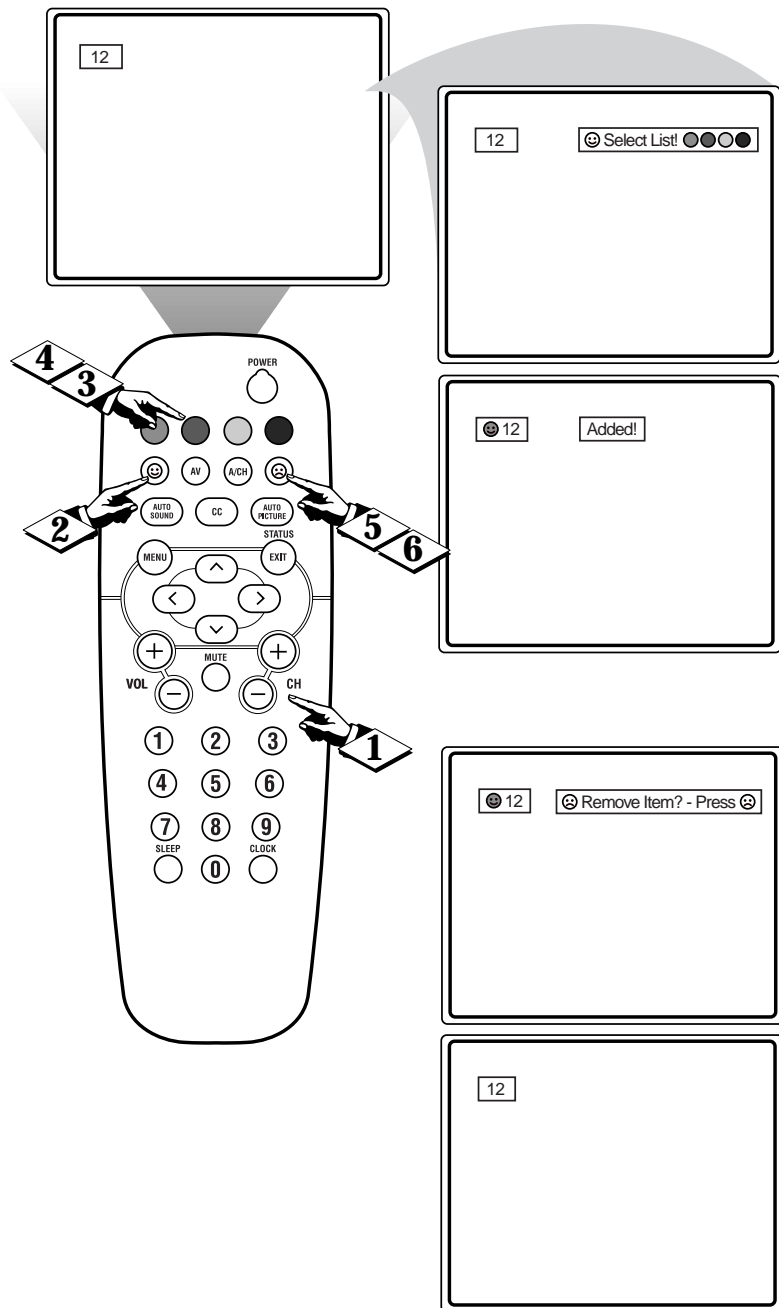

## A/CH BUTTON

Your remote also has an A/CH (Alternate Channel) button. Pressing this button will toggle between the Current and one previously selected channel.

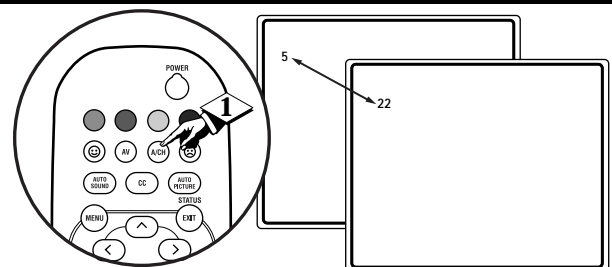



# USING THE QUADRA SURF BUTTONS



The Quadra Surf buttons on your remote control allow you to store up to 10 channels per button (40 total). This is a great feature if you want to store all your favorite Sports channels, Movie channels, or News channels in one surf list. Family members can have their own favorite list of channels. You can even program the A/V Input channels (AV1, AV2, SVHS, FRONT, etc.) for each button making them a "source" button for your external accessory devices.

Assuming channels have now been added to the four Quadra Surf lists (the four colored buttons on the remote, see the previous page), let's review how the feature works.

## BEGIN

**1** Press one of the pre-programmed **COLORED** buttons on the remote (Red, Green, Yellow or Blue). The screen will display a smiley face with the first programmed channel for that surf list.

**2** While the colored "smiley" face still appears on the screen, press the same **COLORED** button on the remote to tune the second channel programmed for that specific surf list.

**3** Repeatedly pressing the same **COLORED** button while the "smiley" face appears will tune all the programmed channels for that specific surf list. After the last channel is tuned, pressing the **COLORED** button again will return you to the first channel in the list.

If the "smiley" face disappears from the screen and the same **COLORED** button is pressed, the surf channels will be displayed starting with the **FIRST** programmed channel again.

**4** Repeat steps 1-3 for the other three **COLORED** buttons (Surf lists) if desired.

**5** Any time the "smiley" face appears with the channel number, **pressing the "frownie" face button** will allow you to remove it from the list (see the previous page for more details).

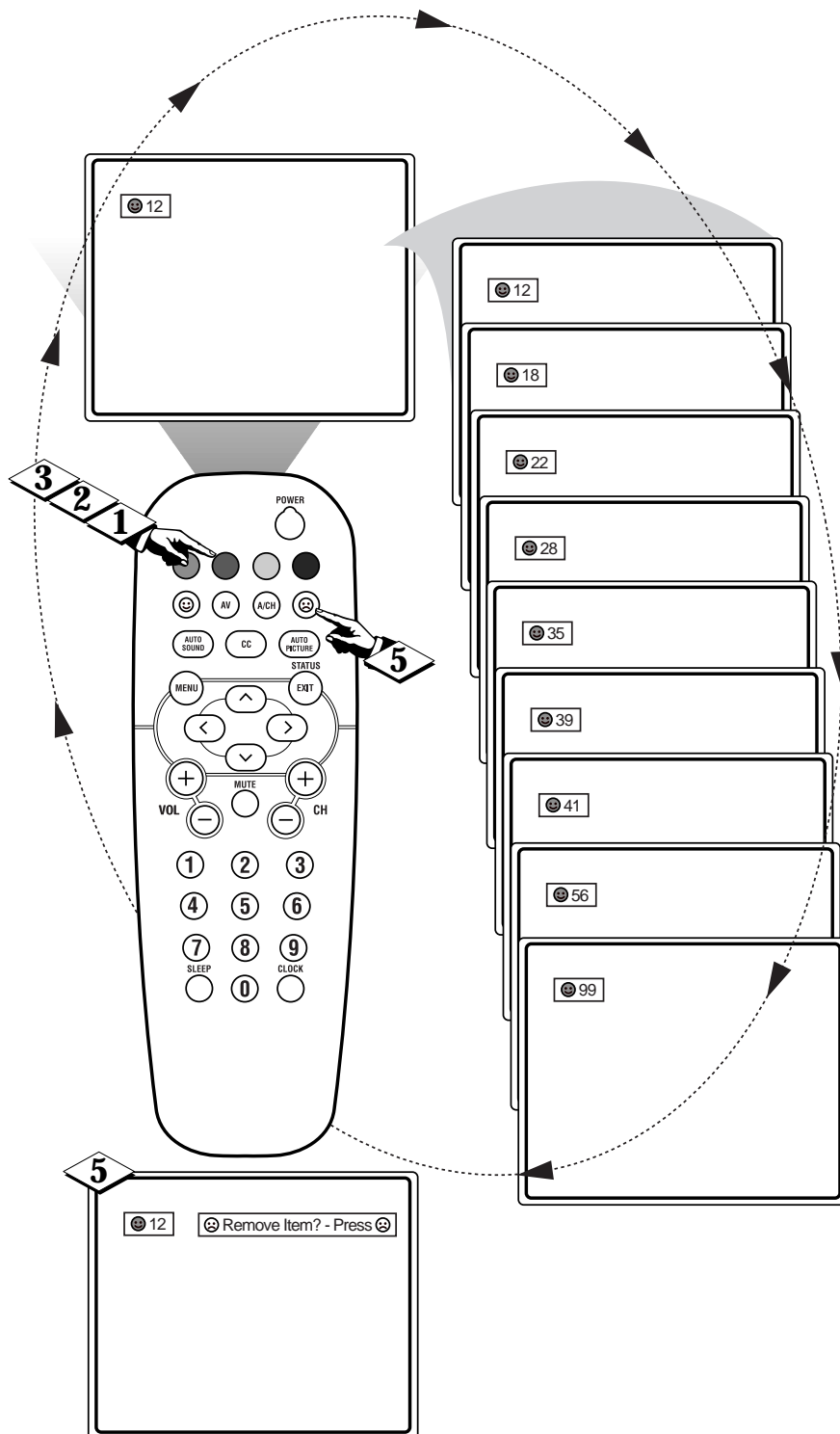



## TROUBLESHOOTING TIPS

*Please make these simple checks before calling for service. These tips can save you time and money since charges for TV installation and adjustment of customer controls are not covered under your warranty.*

### **No Power**

CAUTION: A video source (such as a video game, Compact Disc Interactive - CDI, or TV information channel) which shows a constant non-moving pattern on the TV screen, can cause picture tube damage. When your TV is continuously used with such a source the pattern of the non-moving portion of the game could leave an image permanently on the picture tube. When not in use, turn the video source OFF. Regularly alternate the use of such video sources with normal TV viewing.

- Check the TV power cord. Unplug the TV, wait 10 seconds, then reinsert plug into outlet and push POWER button again.
- Check that outlet is not on a wall switch. Be sure fuse is not blown on AC Power strip.

### **No Picture**

- Check antenna connections. Are they properly secured to the TV's 75Ω plug?
- Check the TUNER MODE control for CABLE or ANTENNA setting.
- Check Audio/Video Input jack connections if using a VCR or other external device.

### **No Sound**

- Check the VOLUME buttons.
- Check the MUTE button on the remote control.
- Check Audio/Video Input jack connections if using a VCR or other external device.

### **Unusual Screen Coloring**

- Turn the TV OFF for several seconds, then power the set back ON.
- Unplug the TV for FIVE minutes. Plug the TV back into the AC outlet and power the TV ON. This should correct the problem.
- Check the Picture menu options for proper control settings.
- Press the Auto Picture button on the remote to change the color options. If the color resets itself, readjust the Picture menu option control.

### **Remote Does Not Work**

- Check batteries. Replace with AA Heavy Duty (Zinc Chloride) or Alkaline batteries if necessary.
- Clean the remote and the remote sensor window on the TV.
- Check the TV power cord. Unplug the TV, wait 10 seconds, then reinsert plug into outlet and push POWER button again. Be sure fuse is not blown on AC Power strip.
- Check to be sure TV outlet is not on a wall switch.

### **TV Displays Wrong Channel or No Channels Above 13**

- Repeat channel selection.
- Add desired channel numbers (CHANNEL control) into TV memory.
- Check to be sure the TUNER MODE control is set to the CABLE option.

#### Cleaning and Care

- To avoid possible shock hazard be sure the TV is unplugged from the electrical outlet before cleaning.
- When cleaning the TV screen take care not to scratch or damage the screen surface (avoid wearing jewelry or using anything abrasive). Wipe the front screen with a clean cloth dampened with water. Use even, easy, vertical strokes when cleaning.
- Gently wipe the cabinet surfaces with a clean cloth or sponge dampened in a solution of cool clear water. Use a clean dry cloth to dry the wiped surfaces.
- Never use thinners, insecticide sprays, or other chemicals on or near the cabinet, as they might cause permanent marring of the cabinet finish.



**Auto Picture Booster** • A control that will automatically amplify “weak video signals” to a point where they are acceptable for viewing.

**Auto Programming** • The procedure of adding or deleting channel numbers into the Television’s memory circuits. In this way the Television “remembers” only the locally available or desired channel numbers and skips over any unwanted channel numbers.

**Coaxial Cable** • A single solid antenna wire normally matched with a metal plug (F-type) end connector that screws (or pushes) directly onto a 75 Ohm input found on the Television or VCR.

**Closed Caption** • Broadcast standard which allows you to read the voice content of television programs on the TV screen. Designed to help the hearing impaired this feature uses on-screen “text boxes” to show dialogue and conversations while the TV program is in progress.

**Front Audio/Video Inputs** • Located on the front of the TV these connectors (phono type plug) are used for the input of audio and video signals. Designed for easy use with VCRs or cameras.

**On Screen Displays (OSD)** • Refers to the wording or messages generated by the television (or VCR) to help the user with specific feature controls (color adjustment, programming, etc.).

**Menu** • An on-screen listing of feature controls shown on the Television screen that are made available for user adjustments.

**Remote Sensor Window** • A window or opening found on the Television control panel through which infrared remote control command signals are received.

**Quadra Surf** • The feature that allows the programming of four separate Surf lists holding up to 10 channels each.

**Status/Exit** • Allows the user to quickly confirm what channel number is currently being viewed. Status can also be used to clear the Television of on screen displays or information (rather than waiting for the displays to “time out” or automatically disappear from the screen).

**Surf** • The action of scanning specific channel in a limited channel list.

**Twin Lead Wire** • The more commonly used name for the two strand 300 Ohm antenna wire used with many indoor and outdoor antenna systems. In many cases this type of antenna wire requires an additional adapter (or balun) in order to connect to the 75 Ohm Input terminals designed into the more recent Televisions and VCRs.

**Tuner Mode** • Designed for first time set up and use where the TV is set for antenna or cable TV signal connections.



# INDEX

Alternate Channel . . . . .	32	Dynamic Noise Reduction (DNR) Control . . . . .	15
Antenna TV Connection . . . . .	6		
Auto Lock Features		Front A/V Inputs . . . . .	7
Access Code . . . . .	21	Glossary of Terms . . . . .	35
Block All Channels Control . . . . .	24	Index . . . . .	36
Block Channels Control . . . . .	22	Language Control . . . . .	10
Blocking Options . . . . .	27	Picture Control . . . . .	14
Clear All Control . . . . .	23	Remote Control Buttons . . . . .	9
Explanation of Auto Lock . . . . .	20	Remote Control Operation (Basic) . . . . .	8
Movie Rating Control . . . . .	25	Safety Instructions . . . . .	3
TV Rating Control . . . . .	26	Sharpness Control . . . . .	14
Auto Picture . . . . .	30	Sleep timer Control . . . . .	29
Auto Program Control . . . . .	12	Surf/Quadra Surf Controls . . . . .	32-33
Auto Sound . . . . .	31	Timer Controls . . . . .	19
Bass Boost Control . . . . .	17	Tint Control . . . . .	14
Brightness Control . . . . .	14	Treble Boost Control . . . . .	17
Cable TV Connection (Basic Connection) . . . . .	5	Troubleshooting Tips . . . . .	34
Channel Edit Control . . . . .	13	Tuner Mode Control . . . . .	11
Closed Caption Control . . . . .	28	TV Operation (Basic) . . . . .	8
Color Control . . . . .	14	VCR Connection (Basic) . . . . .	7
Color Temperature Control . . . . .	14	Warranty . . . . .	37
Contrast + Control . . . . .	16	Welcome/Registration Information . . . . .	2

**RENEWED  
90 DAY  
LIMITED WARRANTY**

## Free Manuals Download Website

<http://myh66.com>

<http://usermanuals.us>

<http://www.somanuals.com>

<http://www.4manuals.cc>

<http://www.manual-lib.com>

<http://www.404manual.com>

<http://www.luxmanual.com>

<http://aubethermostatmanual.com>

Golf course search by state

<http://golfingnear.com>

Email search by domain

<http://emailbydomain.com>

Auto manuals search

<http://auto.somanuals.com>

TV manuals search

<http://tv.somanuals.com>