

Instructions for Use

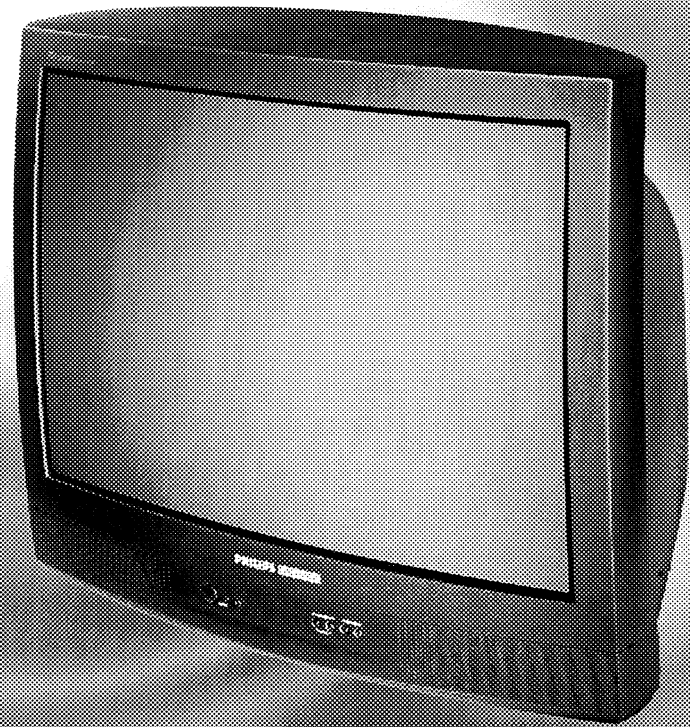

Let's make things better.

PHILIPS **MAGNAVOX**

Return your Warranty Registration card today to ensure you receive all the benefits you're entitled to.

Once your PHILIPS MAGNAVOX purchase is registered, you're eligible to receive all the privileges of owning a PHILIPS MAGNAVOX product. So complete and return the Warranty Registration Card enclosed with your purchase at once. And take advantage of these important benefits.

Warranty Verification

Registering your product within 10 days confirms your right to maximum protection under the terms and conditions of your PHILIPS MAGNAVOX warranty.

Owner Confirmation

Your completed Warranty Registration Card serves as verification of ownership in the event of product theft or loss.

Model Registration

Returning your Warranty Registration Card right away guarantees you'll receive all the information and special offers which you qualify for as the owner of your model.

Congratulations on your purchase, and welcome to the "family!"

PHILIPS MAGNAVOX



Dear PHILIPS MAGNAVOX product owner:

Thank you for your confidence in PHILIPS MAGNAVOX. You've selected one of the best-built, best-backed products available today. And we'll do everything in our power to keep you happy with your purchase for many years to come.

As a member of the PHILIPS MAGNAVOX "family," you're entitled to protection by one of the most comprehensive warranties and outstanding service networks in the industry.

What's more, your purchase guarantees you'll receive all the information and special offers for which you qualify, plus easy access to accessories from our convenient home shopping network.

And most importantly you can count on our uncompromising commitment to your total satisfaction.

All of this is our way of saying welcome—and thanks for investing in a PHILIPS MAGNAVOX product.

Sincerely,

Robert Minkhorst
President and Chief Executive Officer

P.S. Remember, to get the most from your PHILIPS MAGNAVOX product, you must return your Warranty Registration Card within 10 days. So please mail it to us right now!

Know these safety symbols



This "bolt of lightning" indicates uninsulated material within your unit may cause an electrical shock. For the safety of everyone in your household, please do not remove product covering.

The "exclamation point" calls attention to features for which you should read the enclosed literature closely to prevent operating and maintenance problems.

WARNING: TO PREVENT FIRE OR SHOCK HAZARD, DO NOT EXPOSE THIS EQUIPMENT TO RAIN OR MOISTURE.

CAUTION: To prevent electric shock, match wide blade of plug to wide slot, and fully insert.

ATTENTION: Pour éviter les chocs électriques, introduire la lame la plus large de la fiche dans la borne correspondante de la prise et pousser jusqu'au fond.

PHILIPS MAGNAVOX Visit our World Wide Web Site at <http://www.philipsmagnavox.com>

SAFETY INSTRUCTIONS - Read before operating equipment

This product was designed and manufactured to meet strict quality and safety standards. There are, however, some installation and operation precautions which you should be particularly aware of.

1. **Read Instructions** - All the safety and operating instructions should be read before the appliance is operated.
2. **Retain Instructions** - The safety and operating instructions should be retained for future reference.
3. **Heed Warnings** - All warnings on the appliance and in the operating instructions should be adhered to.
4. **Follow Instructions** - All operating and use instructions should be followed.
5. **Water and Moisture** - The appliance should not be used near water - for example, near a bathtub, washbowl, kitchen sink, laundry tub, in a wet basement or near a swimming pool, etc.
6. **Carts and Stands** - The appliance should be used only with a cart or stand that is recommended by the manufacturer.
- 6A.  An appliance and cart combination should be moved with care. Quick stops, excessive force, and uneven surfaces may cause the appliance and cart combination to overturn.
- 6B. **Tilt/Stability** - All televisions must comply with recommended international global safety standards for tilt and stability properties of its cabinet design.
 - Do not compromise these design standards by applying excessive pull force to the front, or top, of the cabinet which could ultimately overturn the product.
 - Also, do not endanger yourself, or children, by placing electronic equipment/toys on the top of the cabinet. Such items could unsuspectingly fall from the top of the set and cause product damage and/or personal injury.
7. **Wall or Ceiling Mounting** - The appliance should be mounted to a wall or ceiling only as recommended by the manufacturer.
8. **Ventilation** - The appliance should be situated so that its location or position does not interfere with its proper ventilation. For example, the appliance should not be situated on a bed, sofa, rug, or similar surface that may block the ventilation openings; or, placed in a built-in installation, such as a bookcase or cabinet that may impede the flow of air through the ventilation openings.
9. **Heat** - The appliance should be situated away from heat sources such as radiators, heat registers, stoves, or other appliances (including amplifiers) that produce heat.
10. **Power Sources** - The appliance should be connected to a power supply only of the type described in the operating instructions or as marked on the appliance.

11. **Power-Cord Protection** - Power supply cords should be routed so that they are not likely to be walked on or pinched by items placed upon or against them, paying particular attention to cords and plugs, convenience receptacles, and the point where they exit from the appliance.
12. **Cleaning** - The appliance should be cleaned only as recommended by the manufacturer.
13. **Power Lines** - An outdoor antenna should be located away from power lines.
14. **Outdoor Antenna Grounding** - If an outside antenna is connected to the receiver, be sure the antenna system is grounded so as to provide some protection against voltage surges and built up static charges.

Section 810 of the National Electric Code, ANSI/NFPA No. 70-1984, provides information with respect to proper grounding of the mats and supporting structure grounding of the lead-in wire to an antenna discharge unit, size of grounding connectors, location of antenna-discharge unit, connection to grounding electrodes and requirements for the grounding electrode. See Fig. below.
15. **Non-use Periods** - The power cord of the appliance should be unplugged from the outlet when left unused for a long period of time.
16. **Object and Liquid Entry** - Care should be taken so that objects do not fall and liquids are not spilled into the enclosure through openings.
17. **Damage Requiring Service** - The appliance should be serviced by qualified service personnel when:
 - A. The power supply cord or the plug has been damaged; or
 - B. Objects have fallen, or liquid has been spilled into the appliance; or
 - C. The appliance has been exposed to rain; or
 - D. The appliance does not appear to operate normally or exhibits a marked change in performance; or
 - E. The appliance has been dropped, or the enclosure damaged.
18. **Servicing** - The user should not attempt to service the appliance beyond that described in the operating instructions. All other servicing should be referred to qualified service personnel.

Note to the CATV system installer: This reminder is provided to call the CATV system installer's attention to Article 820-40 of the NEC that provides guidelines for proper grounding and, in particular, specifies that the cable ground shall be connected to the grounding system of the building, as close to the point of cable entry as practical.

Example of Antenna Grounding as per NEC - National Electric Code

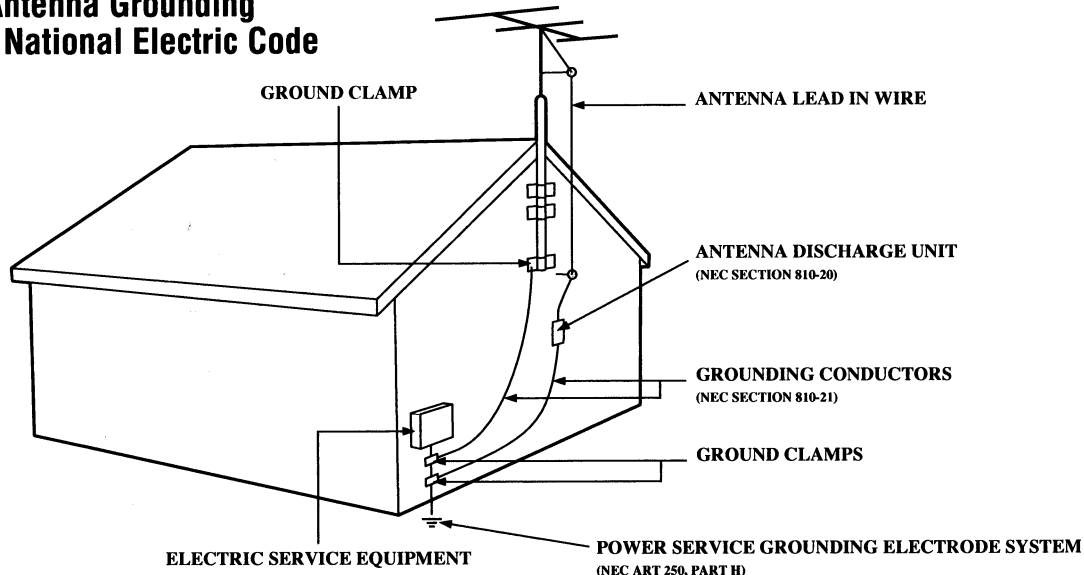

TABLE OF CONTENTS

Introduction

Welcome/Registration of Your TV.....	2
Safety/Precautions	3
Table of Contents	4
Features	4



Onscreen MENU

✦ Adjusting the TV Picture	5
✦ Activating Contrast Plus (Black Stretch).....	6
✦ Activating Noise Reduction (Picture) Control ...	7
✦ Setting the TV's Clock.....	8
✦ Activating the Timer Control.....	8
✦ Activating the Start-Up Channel.....	9
✦ Setting the TV's Start Time Control.....	9
✦ Setting the TV for Closed Caption	10
✦ Using the Sleep Timer Control	11



SmartLock™

✦ Understanding the SmartLock Feature	12
✦ Setting the SmartLock Access Code.....	13
✦ Setting the SmartLock to Block Channels.....	14
✦ Setting SmartLock's Blocking Options	15
✦ Blocking Using the Movie/TV Ratings	16-17
✦ Using the SmartLock Review Screen	18



Sound

✦ Setting the Treble Boost and Bass Boost Controls	19
✦ Setting the TV for Stereo Programs	20
✦ Using the Volume Bar Control.....	21
✦ Using the Input control with the Audio/Video Input Jacks	22



Remote Control Operation

Using the SmartPicture™ Control	23
Using the SmartSound™ (AVL) Control	24
Using SmartSurf™ (Alternate Channel)	25
Setting the Remote Control to Operate Accessory Devices (Code Entry)	26-27
Setting the Remote Control to operate Accessory Devices (Search Method)	28
Remote Control Direct Entry Code List	29-30
Using the Remote's VCR Buttons	31



General Information

Tips if Something Isn't Working	32
Glossary of TV Terms	33
Index	33
Factory Service Locations	34-35
Warranty.....	36

Here are a few of the special features built into this new Color Television:

SmartLock™ feature allows you to block the viewing of certain channel or external audio/video connections were you might not want your children viewing inappropriate material.

Infrared Remote Control works your TV set, VCR, and a variety of wireless remote control Cable Converters (Satellite Receivers, DVD, etc.).

Standard broadcast (VHF/UHF) or Cable TV (CATV) channel capability.

Stereo TV with built-in audio amplifier and twin speaker system for receiving TV programs broadcast in stereo sound. This TV can actually detect if the signal being received is Stereo and adjust for it.

Closed Captioning allows the viewer to read TV program dialogue or voice conversations as onscreen text.

Automatic Programming of Channels for quick and easy selection of favorite stations available in your area.

Onscreen Features (in either English, French, or Spanish) show helpful messages for setting of TV controls.

Audio/Video Jackpanel for direct connections with VCRs (or other video accessories) providing quality TV picture and sound playback.

On Timer automatically turns the TV ON at a preset time, and channel.

Sleeptimer automatically turns the TV OFF at preset times.

SmartPicture™ allows you to set the picture color, tint, contrast, etc. for various types of programming such as Sports, Movies, personal, or Weak Signals with the push of one button.

SmartSound™ controls allow you to set the sound controls for various types of listening programs such as Personal (sound controls the way you set them), Theater, Music, or Voice with the push of one button.

NOTE: This owner's manual is used with several different television models. Not all features (and drawings) discussed in this manual will necessarily match those found with your television system. This is normal and does not require you contacting your dealer or requesting service.

SmartPicture™, SmartSound™, SmartSurf™, and SmartLock™ are all registered trademarks of Philips Consumer Electronics Company.

Copyright © 1999 Philips Consumer Electronics Company. All rights reserved.

HOW TO ADJUST THE TV PICTURE

To adjust your TV picture controls, select a channel and follow the steps shown below:

BEGIN

- 1 Press the **MENU** button on the remote to display the onscreen menu.
- 2 Press the **CURSOR UP** or **DOWN** buttons until the word **BRIGHTNESS** is highlighted. (Or, **COLOR**, **PICTURE**, **SHARPNESS**, **TINT**, **COL. TEMP** depending on the adjustment you want to make.)
- 3 Press the **CURSOR RIGHT** or the **CURSOR LEFT** buttons to increase or decrease the brightness of the picture.



SMART HELP



Remember: The onscreen menu will time out and disappear from the screen when you finish, or you can press the **STATUS/EXIT** button to clear the menu from the screen.

BRIGHTNESS Press the **RIGHT** or **LEFT** buttons until darkest parts of the picture are as bright as you prefer.

COLOR Press the **RIGHT** or **LEFT** buttons to add or eliminate color.

PICTURE Press the **RIGHT** or **LEFT** buttons until lightest parts of the picture show good detail.

SHARPNESS Press the **RIGHT** or **LEFT** buttons to improve detail in the picture.

TINT Press the **RIGHT** or **LEFT** buttons to obtain natural skin tones.

COLOR TEMP Press the **RIGHT** or **LEFT** buttons to select **NORMAL**, **COOL**, or **WARM** picture preferences. (**NORMAL** will keep the whites, white; **COOL** will make the whites, bluish; and **WARM** will make the whites, reddish.)

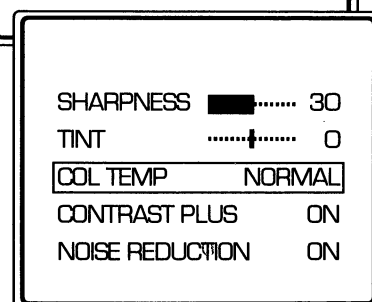
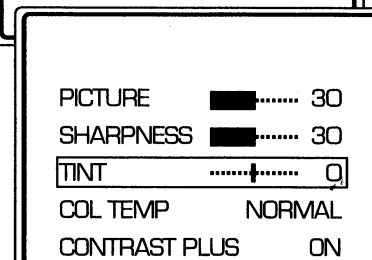
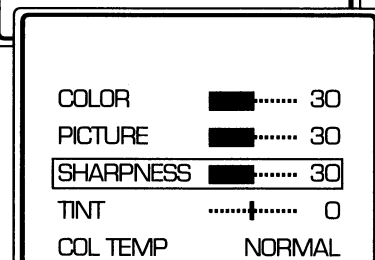
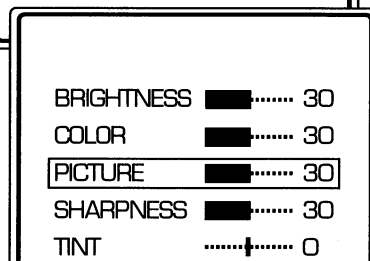
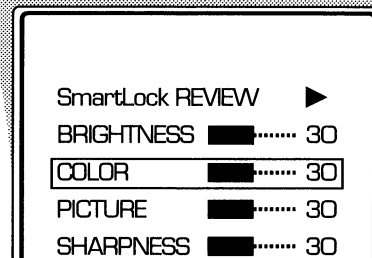
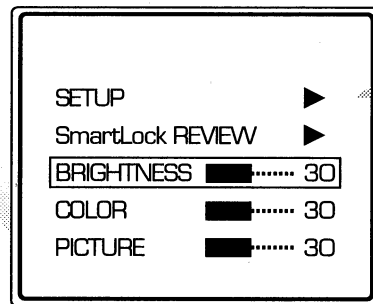

COL TEMP WARM

COL TEMP COOL

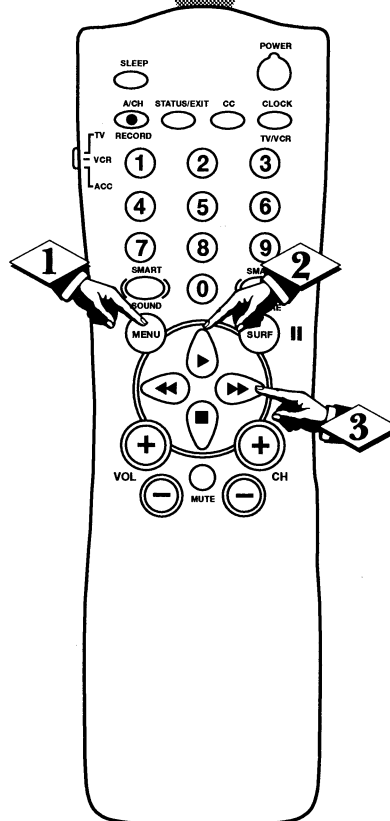

ACTIVATING THE CONTRAST PLUS (BLACK STRETCH) CONTROL

The Contrast Plus (Black Stretch) feature helps to "sharpen" the picture quality. The black portions of the picture become richer in darkness and the whites become brighter.

BEGIN

- 1 Press the **MENU** button on the remote to display the onscreen menu.
- 2 Press the **CURSOR UP** ► or **CURSOR DOWN** ■ buttons until the words **CONTRAST PLUS** are highlighted.
- 3 Press the **CURSOR RIGHT** ►► or **CURSOR LEFT** ◀◀ buttons to activate or deactivate the **Contrast Plus** (Black Stretch) feature.



SMART HELP



Remember: The onscreen menu will disappear in a few seconds after you have finished your adjustment.

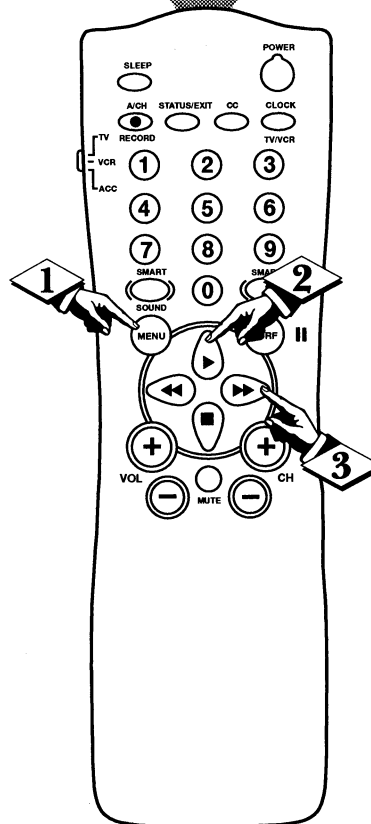
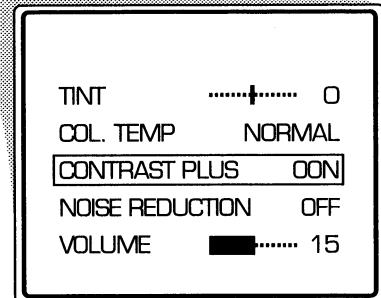
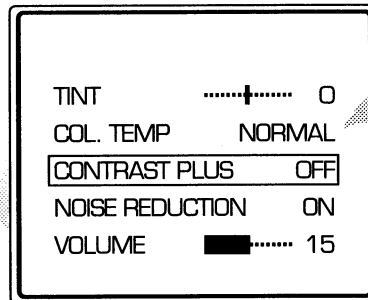

ACTIVATING THE NOISE REDUCTION (PICTURE) CONTROL

For reasons such as poor cable reception, the picture can sometimes appear slightly "speckled" (or signal noise shown in the picture). The **NOISE REDUCTION** control can help eliminate this type of interference and improve the quality of the picture.

BEGIN

- 1 Press the **MENU** button on the remote to display the onscreen menu.
- 2 Press the **CURSOR UP ▲** or **CURSOR DOWN ▼** button until the words **NOISE REDUCTION** are highlighted.
- 3 Press the **CURSOR RIGHT ►►** or **CURSOR LEFT ◄◄** buttons to activate or deactivate the Noise Reduction feature.



SMART HELP

Remember: The onscreen menu will disappear in a few seconds after you have finished your adjustment.

"Noise" Reduction is a video adjustment feature that affects the picture quality of the TV not the sound.

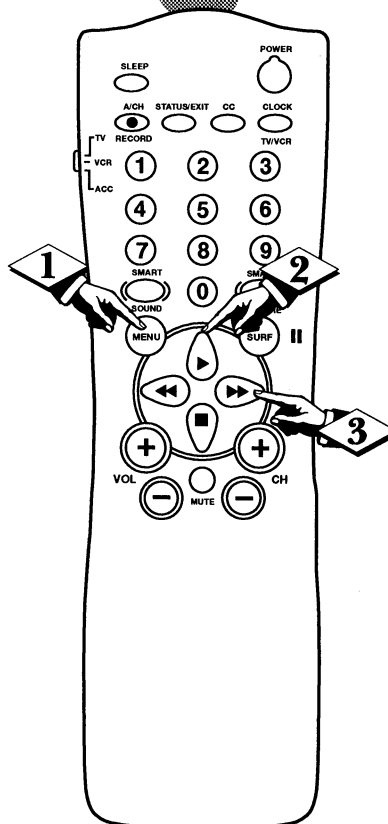
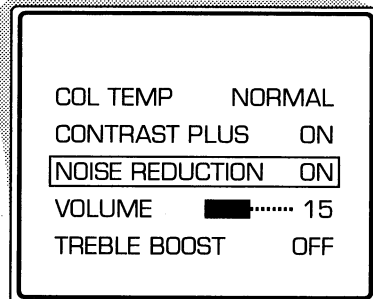
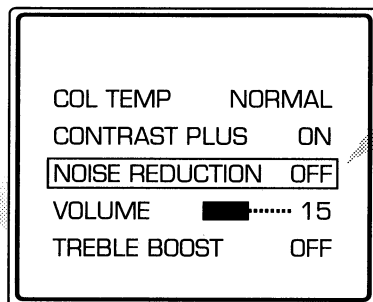

SETTING THE TV'S CLOCK

Your television comes with an onscreen clock. During normal operation the clock appears on the screen when the STATUS/EXIT button is pressed.

BEGIN

- 1 Press the **CLOCK** button on the remote to display the onscreen **CLOCK** menu.
- 2 Press the **CURSOR UP** ► OR **CURSOR DOWN** ▣ buttons until the words **SET CLOCK** are highlighted.
- 3 Enter the current time using the **NUMBERED** buttons. If the first number is a single digit first enter a zero then the digit (ie; press "0", then press "8").
- 4 Press the **CURSOR RIGHT** ►► or **CURSOR LEFT** ◀◀ buttons to set either AM or PM time.

Note: The **CLOCK** onscreen menu can also be accessed through the main menu by pressing the **MENU** button; then scrolling up/down with the **CURSOR UP** ► or **CURSOR DOWN** ▣ buttons until the word **CLOCK** is highlighted. Press the **CURSOR RIGHT** ►► button to activate the **CLOCK** menu and follow the steps above to set the time.

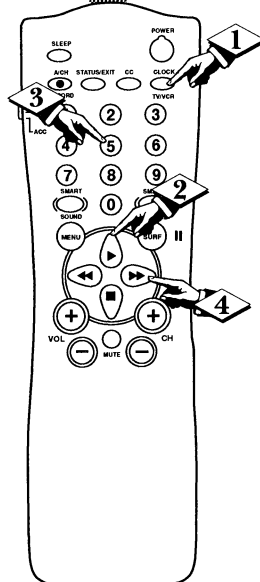
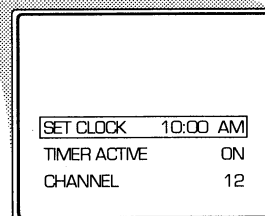
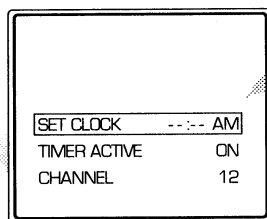

SMART HELP

Remember: Be sure to press "0" first and then the hour number for single digit entries.

To clear the onscreen menu press the **STATUS/EXIT** button or wait a few seconds after you have finished your adjustment and the menu will automatically disappear from the screen.

Note: If a power failure occurs, the TV's **CLOCK** will have to be reset.

If no time is set, the time will not appear onscreen.

ACTIVATING THE TV'S ON TIMER CONTROL

Just like an alarm clock you can set the TV to turn itself on at the same time everyday.

BEGIN

- 1 Press the **CLOCK** button to display the Clock onscreen menu.
- 2 Press the **CURSOR UP** ► or **CURSOR DOWN** ▣ button until the words **TIMER ACTIVE** are highlighted..
- 3 Press the **CURSOR RIGHT** ►► or **CURSOR LEFT** ◀◀ button to select **ON** (if activating) or **OFF** (if deactivating) the Timer control.

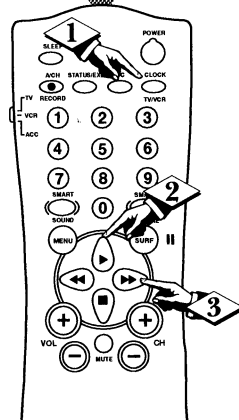
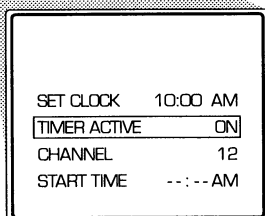
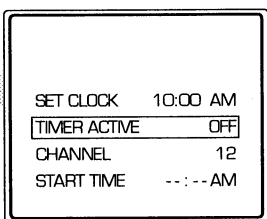

SMART HELP

Remember: Be sure to set the clock and the time you want the television to turn on using the **START TIME** control as described on the next page.

The onscreen menu will time out and disappear from the screen when you finish, or you can press the **STATUS/EXIT** button to clear the menu from the screen.

ACTIVATING THE START UP CHANNEL

Used along with the Clock features, you can select a specific channel that the television will tune to when the Timer Active control is turned ON.

BEGIN

- 1 Press the **CLOCK** button to display the Clock onscreen menu.
- 2 Press the **CURSOR UP** ► or **CURSOR DOWN** ■ button until the word **CHANNEL** is highlighted.
- 3 Press the number buttons to enter the start up channel you would like the television to start on.

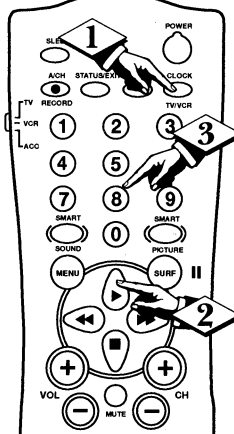
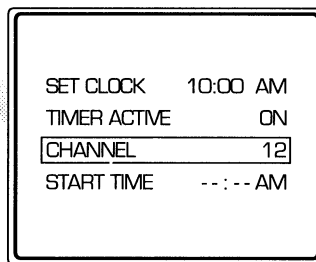

SMART HELP

Remember: Be sure to set the Timer Active control to ON.

The onscreen menu will time out and disappear from the screen when you finish, or you can press the STATUS/EXIT button to clear the menu from the screen.

SETTING THE TV'S START UP TIME

Used along with the Clock feature, you can select a specific time the television will turn on when the Timer Active control is turned ON.

BEGIN

- 1 Press the **CLOCK** button to display the Clock onscreen menu.
- 2 Press the **CURSOR UP** ► or **CURSOR DOWN** ■ button until the words **START TIME** are highlighted.
- 3 Enter the time to turn on the TV using the **NUMBERED** buttons. If the first number is a single digit first enter a zero then the digit (ie, press "0", then press "8").
- 4 Press the **CURSOR RIGHT** ►► or **CURSOR LEFT** ◀◀ buttons to set either AM or PM time.

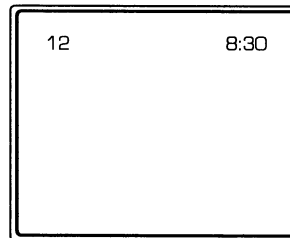
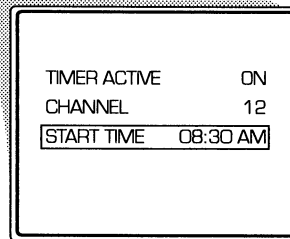
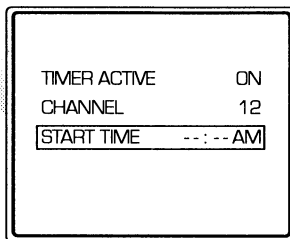

If the TV is in use when the **START TIME** control is about to be activated, the screen will display a warning stating it's going to change channels in 30 seconds. It will appear like the screen shown below and change to the selected start up channel. Pressing any button on the remote within this count down will cancel the change.

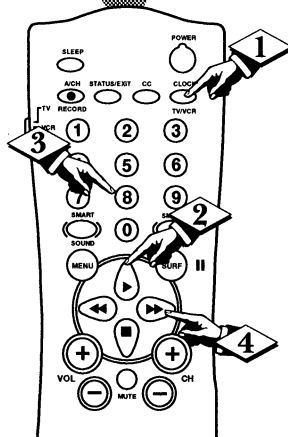
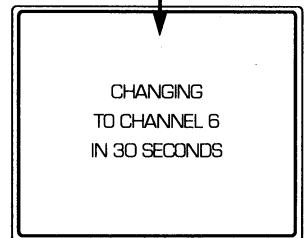

SMART HELP

Remember: Be sure to set the Timer Active to ON.

USING THE CLOSED CAPTION CONTROL



Closed Captioning (CC) allows you to read the voice content of television programs on the TV screen. Designed to help the hearing impaired, this feature uses onscreen "text boxes" to show dialogue and conversations while the TV program is in progress.

BEGIN

- 1 Press the **MENU** button on the remote to display the onscreen menu.
- 2 Press the **CURSOR UP** ► or **CURSOR DOWN** ▾ button until the word **CC** (Closed Caption) is highlighted.
- 3 Press the **CURSOR RIGHT** ►► button to select the **CLOSED CAPTION** option you want (**OFF**, **1**, **2**, or **MUTE**). Dialogue (and descriptions) for the action on the captioned TV program will appear onscreen.
- 4 **NOTE:** You can also set the Closed Caption by **pressing the CC button** on the remote. When pressed repeatedly the screen will display the options: **CC-OFF**, **CC-1**, **CC-2**, or **CC-MUTE**.



SMART HELP

Remember: The onscreen menu will time out and disappear from the screen when you finish, or you can press the **STATUS/EXIT** button to clear the menu from the screen.

NOTE: Not all TV programs and product commercials are made for broadcast with Closed Caption (CC) information included. Neither are all Closed Caption modes (CC-1, or CC-2) necessarily being used by a broadcast station during the transmission of a closed caption program. Refer to your area's TV program listings for the stations and times of Closed Caption shows.

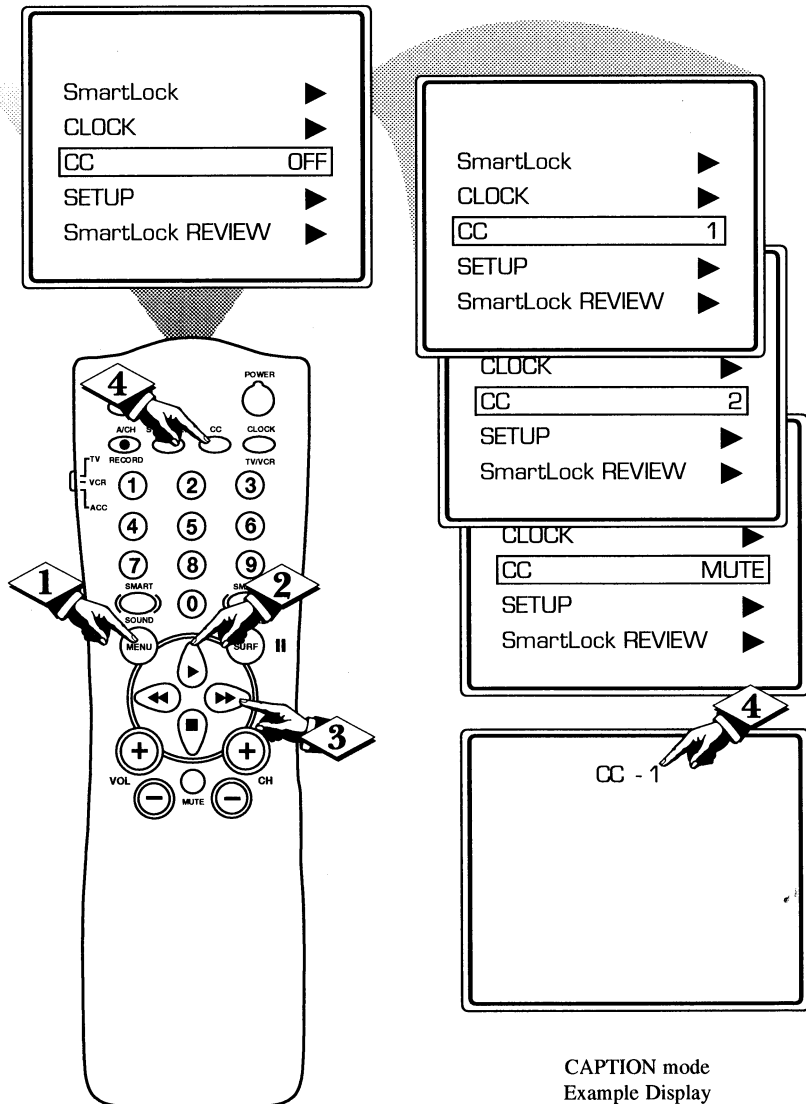

CAPTION mode
Example Display



NOTE: The **CC-MUTE** option can be used to set the TV to turn the Closed Caption mode "ON" whenever the **MUTE** button on the remote is pressed. This activates the **CC-1** option. **MUTE** will appear smaller in the upper center of the screen.

USING THE SLEEP TIMER CONTROL

Have you ever fallen asleep in front of the TV only to have it wake you up at two in the morning with a test pattern screeching in your ears? Well, your TV can save you all that trouble by automatically turning itself off.

BEGIN

1 Press the **SLEEP** button on the remote control and the **SLEEP** timer display will appear on the screen.

2 Press the **SLEEP** button repeatedly to pick the amount of time (in 15 minute increments up to 90 minutes; then 30 minute increments up to 120; then 60 minute increments up to 240) before the TV will turn itself off.

An onscreen count down will appear during the last minute before the TV shuts itself off.

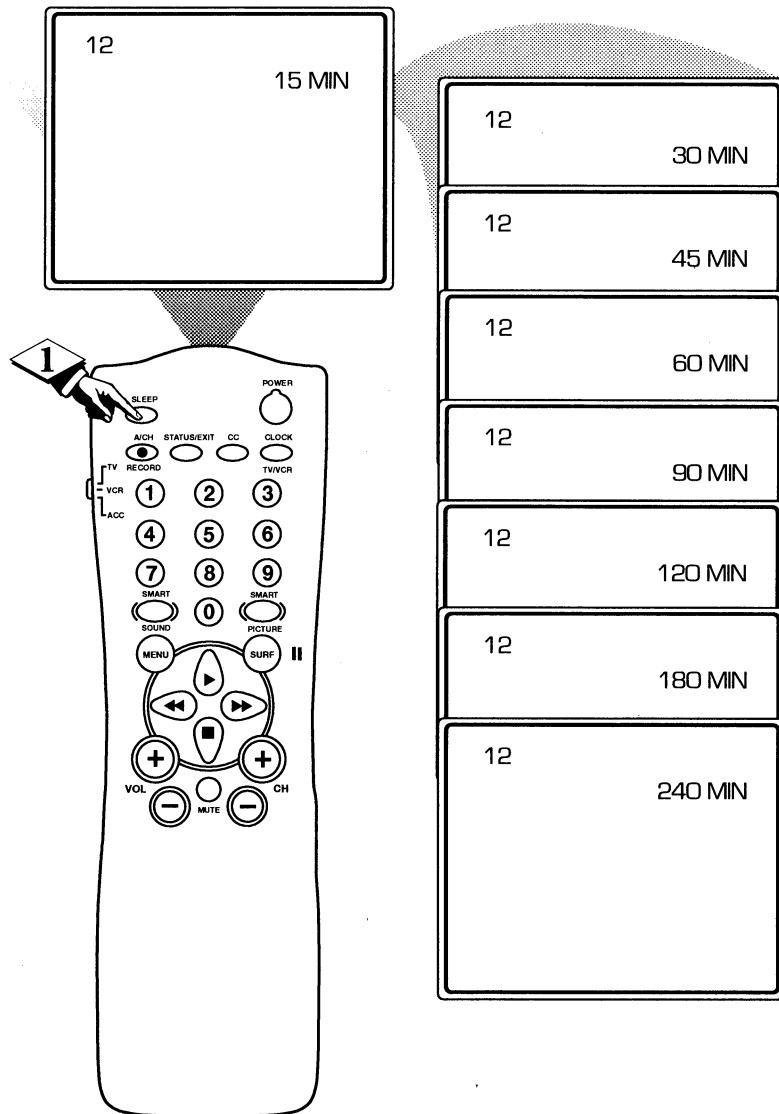

SMART HELP

Remember: The **SLEEP-TIMER** control can also be set within the TV's main menu

The onscreen menu will time out and disappear from the screen when you finish, or you can press the **STATUS/EXIT** button to clear the menu from the screen.

During the last minute of a **SLEEP** timer setting, an onscreen count down will be displayed. Pressing any button during the last minute will cancel the **SLEEP** timer.

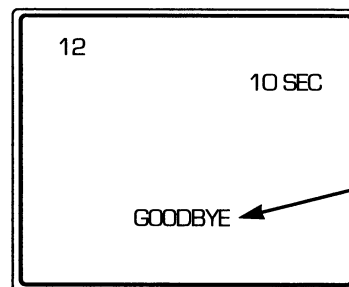
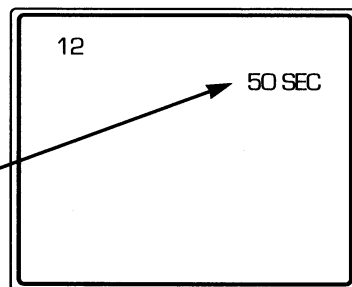

During the last 10 seconds of a **SLEEP** timer setting, an onscreen display will read **GOOD BYE**.

The SmartLock feature is an integrated circuit that receives and processes data sent by broadcasters, or other program providers, that contain program content advisories. When programmed by the viewer, a TV with SmartLock can respond to the content advisories and block program content that may be found objectionable (such as offensive language, violence, sexual situations, etc.). This is a great feature to censor the type of viewing children may watch.

Over the next few pages you'll learn how to block channels and certain rated programming. Below is a brief explanation of some terms and ratings you will find in the SmartLock feature.

SmartLock offers various **BLOCKING OPTION** controls from which to choose:

MASTER DISABLE: This is what might be called the "master switch" for SmartLock. When in the ON position, ALL blocking/censoring is turned off (or disabled). When in the OFF position, ALL blocking based on specifically blocked settings will take place.

BLOCK UNRATED: ALL unrated programs based on the Movie Ratings or Parental (TV) Guidelines can be blocked if this feature is set to ON and the MASTER DISABLE feature is set to OFF.

BLOCK NO RATINGS: ALL programming with NO content advisory data can be blocked if this feature is set to ON and the MASTER DISABLE feature is set to OFF.

After an access code has been programmed, you can block up to 5 individual channels. But more than just blocking channels, certain blocking options exist which will block programming based on ratings patterned by the Motion Pictures Association of America and TV broadcasters. (See description of ratings on this page.)

G	OFF
PG	OFF
PG-13	OFF
R	ON
NC-17	ON
X	ON

TV-Y	OFF
TV-Y7	▶
TV-G	OFF
TV-PG	▶
TV-14	▶
TV-MA	▶

MOVIE RATINGS

(MOTION PICTURE ASSOCIATION OF AMERICA)

G: General Audience - All ages admitted. Most parents would find this program suitable for all ages. This type of programming contains little or no violence, no strong language, and little or no sexual dialogue or situations.

PG: Parental Guidance Suggested - This programming contains material that parents may find unsuitable for younger children.) It may contain one or more of the following: Moderate violence, some sexual situations, infrequent coarse language, or some suggestive dialogue.

PG-13: Parents Strongly Cautioned - This programming contains material that parents may find unsuitable for children under the age of 13. It contains one or more of the following: violence, sexual situations, coarse language, or suggestive dialogue.

R: Restricted - This is programming is specifically designed for adults. Anyone under the age of 17 should only view this programming with an accompanying parent or adult guardian. It contains one or more of the following: intense violence, intense sexual situations, strong coarse language, or intensely suggestive dialogue.

NC-17: No one under the age of 17 will be admitted. - This type of programming should be viewed by adults only. It contains graphic violence, explicit sex, or crude indecent language.

X: Adults Only - This type of programming contains one or more of the following: very graphic violence, very graphic and explicit or indecent sexual acts, very coarse and intensely suggestive language.

TV PARENTAL GUIDELINES (TV BROADCASTERS)

TV-Y **TV-Y** - (All children -- This program is designed to be appropriate for all children.) Designed for a very young audience, including children ages 2-6. This type of programming is not expected to frighten younger children.

TV-Y7 **TV-Y7** - (Directed to Older Children -- This program is designed for children age 7 and above.) It may be more appropriate for children who have acquired the development skills needed to distinguish between make-believe and reality. This programming may include mild fantasy and comic violence (FV).

TV-G **TV-G** - (General Audience -- Most parents would find this program suitable for all ages.) This type of programming contains little or no violence, no strong language, and little or no sexual dialogue or situations.

TV-PG **TV-PG** - (Parental Guidance Suggested -- This program contains material that parents may find unsuitable for younger children.) This type of programming contains one or more of the following: Moderate violence (V), some sexual situations (S), infrequent coarse language (L), or some suggestive dialogue (D).

TV-14 **TV-14** - (Parents Strongly Cautioned -- This program contains some material that many parents would find unsuitable for children under 14 years of age.) This type of programming contains one or more of the following: intense violence (V), intense sexual situations (S), strong coarse language (L), or intensely suggestive dialogue (D).

TV-MA **TV-MA** - (Mature Audience Only -- This program is specifically designed to be viewed by adults and therefore may be unsuitable for children under 17.) This type of programming contains one or more of the following: graphic violence (V), explicit sexual situations (S), or crude indecent language (L).

UNDERSTANDING THE SMARTLOCK™ CONTROL (ACCESS CODE)

Over the next few pages you'll learn how to block channels and get a better understanding of the rating terms for certain programming.

First, let's start by learning how to set a personal access code:

BEGIN

- 1 Press the **MENU** button on the remote to display the onscreen menu.
- 2 Press the **CURSOR UP** or **CURSOR DOWN** buttons until the words **SmartLock** are highlighted.
- 3 Press the **CURSOR RIGHT** button to display the SmartLock Access Code screen.
- 4 Using the **NUMBERED** buttons, enter 0, 7, 1, 1. "XXXX" appears on the Access Code screen as you press the numbered buttons. "INCORRECT CODE" will appear on the screen, and you will need to enter 0, 7, 1, 1 again.
- 5 Press the **CURSOR DOWN** button until the words **CHANGE CODE** are highlighted.
- 6 Press the **CURSOR RIGHT** button to change your personal Access Code.
- 7 "Next enter a "new" 4 digit code using the **NUMBERED** buttons. The screen will then ask you to confirm the code you just entered. Enter your new code again. "XXXX" will appear when you enter your new code.
- 8 Press the **STATUS/EXIT** button after the new code has been entered to set the code in the TV's memory.

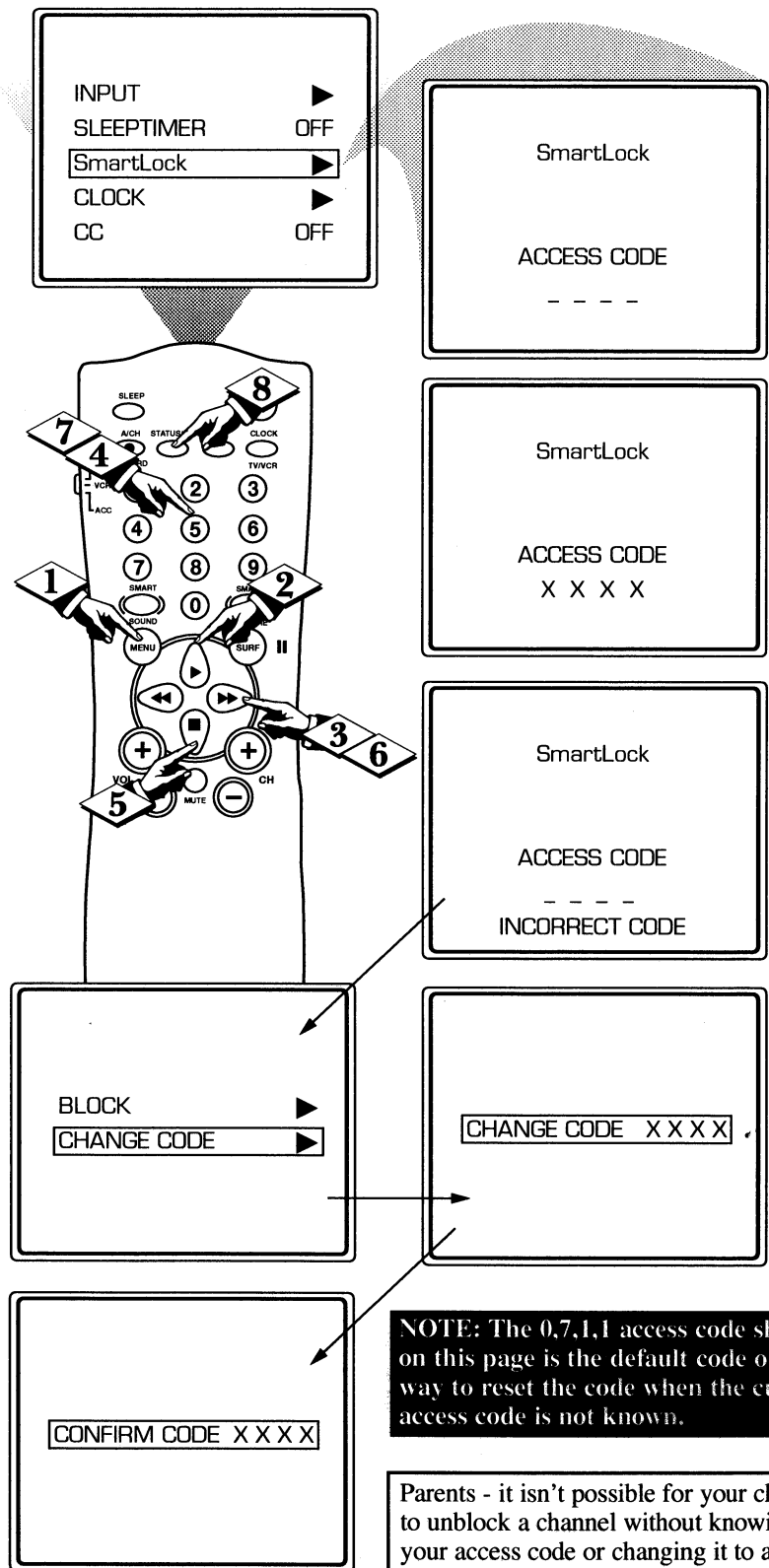

NOTE: The 0,7,1,1 access code shown on this page is the default code or a way to reset the code when the current access code is not known.

Parents - it isn't possible for your child to unblock a channel without knowing your access code or changing it to a new one. If your code changes, and you didn't change it, then you know it's been altered by someone else and blocked channels have been viewed.

UNDERSTANDING THE SMARTLOCK™ CONTROL (BLOCK CHANNEL)

After your personal access code has been set (see previous page), you are now ready to select the channels you want to block out or censor.

BEGIN

- 1 Press the **MENU** button on the remote to show the onscreen menu.
 - 2 Press the **CURSOR UP** ► or **CURSOR DOWN** ▼ button until the words **SmartLock** are highlighted.
 - 3 Press the **CURSOR RIGHT** ►► button to display the SmartLock Access screen.
 - 4 Enter the correct access code number. "XXXX" shows on the Access Code display as you press the **NUMBERED** buttons.
 - 5 Press the **CURSOR UP** ► or **DOWN** ▼ buttons until the word **BLOCK** is highlighted. Press the **CURSOR RIGHT** ►► button then highlight **CHANNELS BLOCKED**.
 - 6 Press the **CURSOR RIGHT** ►► button. Three options will be displayed; **CHANNEL**, **LOCK** or **CLEAR ALL**.
 - 7 With **CHANNEL** highlighted, use the **NUMBERED** buttons to enter the channel number you wish to block.
 - 8 Use the **CURSOR DOWN** ▼ button to highlight the word **LOCK**, then press the **CURSOR RIGHT** ►► button to select **YES** (block) or **NO** (do not block). The channel chosen is now blocked from viewing.
- Repeat steps 7 and 8 for any other channels you wish to block from viewing.

To clear blocked channels follow the steps below:

Press the **CURSOR DOWN** ▼ button until the words **CLEAR ALL** are highlighted, then press the **CURSOR RIGHT** ►► button.

The screen will read "ALL UNBLOCKED" for a moment. At this point ALL the previously blocked channels will be unblocked.

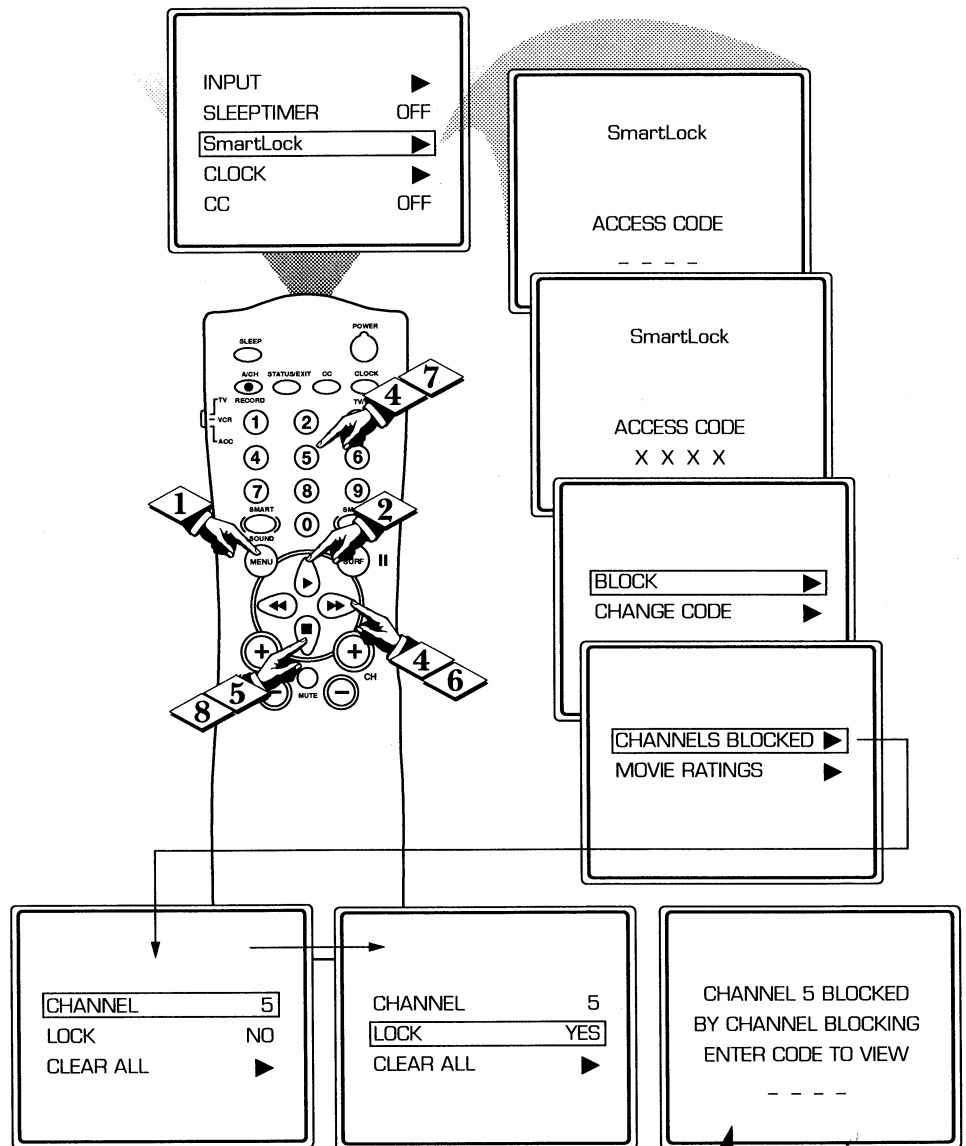

When a blocked channel is viewed, this is what the screen will display. To view the blocked channel, simply enter the current access code. Note: Once the access code is entered ALL blocked channels will be viewable until the TV is powered off. Once the set is turned off and then back on the previously blocked channels will again be blocked.

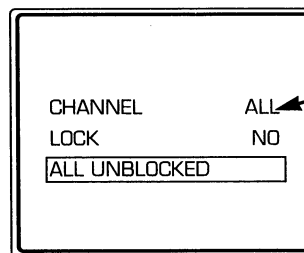
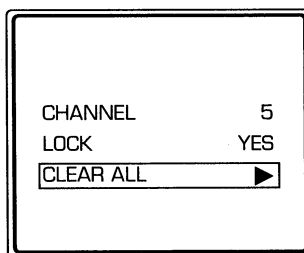

Note: When the **CLEAR ALL** option is selected, the **CHANNEL** option will display **ALL**. If at this point if you change the **LOCK** option to **YES**, **ALL** channels will be blocked from viewing.

UNDERSTANDING THE SMARTLOCK™ CONTROL (BLOCKING OPTIONS)

SmartLock offers the viewer other blocking features as well. With these Blocking Option features, the censoring can be turned ON or OFF.

BEGIN

- 1 Press the **MENU** button on the remote to display the onscreen menu.
- 2 Press the **CURSOR UP ▲** or **CURSOR DOWN ▼** buttons until the words **SmartLock** are highlighted.
- 3 Press the **CURSOR RIGHT ►** button to display the SmartLock Access Code screen.
- 4 Using the **NUMBERED** buttons on the remote, enter your personal Access Code.
- 5 With the word **BLOCK** highlighted, Press the **CURSOR RIGHT ►** button.
- 6 Scroll the menu using the **CURSOR UP ▲** or **CURSOR DOWN ▼** buttons until the words **BLOCKING OPTIONS** are highlighted.
- 7 Press the **CURSOR RIGHT ►** button to display the **Blocking Options (MASTER DISABLE, BLOCK UNRATED, or BLOCK NO RATING)**. When highlighted, each feature can be turned **ON** or **OFF** using the **CURSOR RIGHT ►** or **CURSOR LEFT ◀** buttons on the remote.

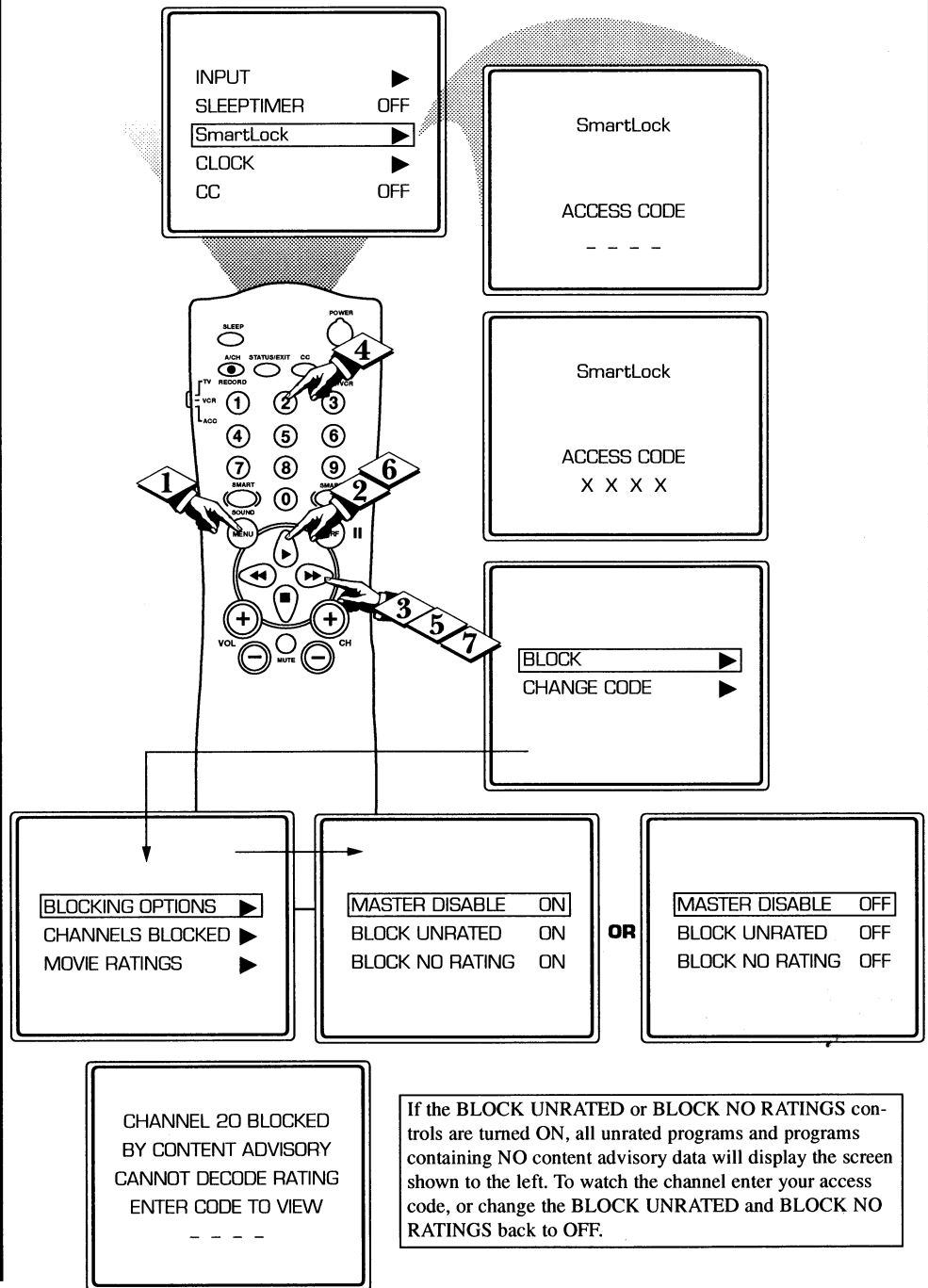

BLOCKING OPTIONS:

MASTER DISABLE: This is what might be called the “master switch” for SmartLock. When in the ON position, ALL blocking/censoring is turned off (or disabled). When in the OFF position, ALL blocking based on specifically blocked settings will take place.

BLOCK UNRATED: ALL unrated programs based on the Movie Ratings or Parental (TV) Guidelines can be blocked if this feature is set to ON and the MASTER DISABLE feature is set to OFF.

BLOCK NO RATINGS: ALL programming with NO content advisory data can be blocked if this feature is set to ON and the MASTER DISABLE feature is set to OFF.

If the **BLOCK UNRATED** or **BLOCK NO RATINGS** controls are turned ON, all unrated programs and programs containing NO content advisory data will display the screen shown to the left. To watch the channel enter your access code, or change the **BLOCK UNRATED** and **BLOCK NO RATINGS** back to OFF.

UNDERSTANDING THE SMARTLOCK™ CONTROL (MOVIE RATINGS)

There are two types of program ratings within the SmartLock feature. One is based on the Movie Industry ratings while the other is based on the TV Industry ratings. Both can be used to block or censor programming that has been rated in either manner.

Let's first look at the Movie Rating options of SmartLock:

BEGIN

- 1 Press the **MENU** button on the remote to display the onscreen menu.
- 2 Press the **CURSOR UP** ► or **CURSOR DOWN** ▾ buttons until the words **SmartLock** are highlighted.
- 3 Press the **CURSOR RIGHT** ►► button to display the SmartLock Access Code screen.
- 4 Using the **NUMBERED** buttons on the remote, enter your Personal Access Code.
- 5 With the word **BLOCK** highlighted, Press the **CURSOR RIGHT** ►► button.
- 6 Scroll the menu using the **CURSOR UP** ► or **CURSOR DOWN** ▾ buttons until the words **MOVIE RATINGS** are highlighted.
- 7 Press the **CURSOR RIGHT** ►► button to display the **MOVIE RATINGS** (G, PG, PG-13, R, NC17, or X).

When highlighted, all these options can be turned **ON** (which will allow blocking) or **OFF** (which will allow viewing).

Use the **CURSOR RIGHT** ►► or **CURSOR LEFT** ◀◀ buttons on the remote to turn the rating option **ON** or **OFF**.

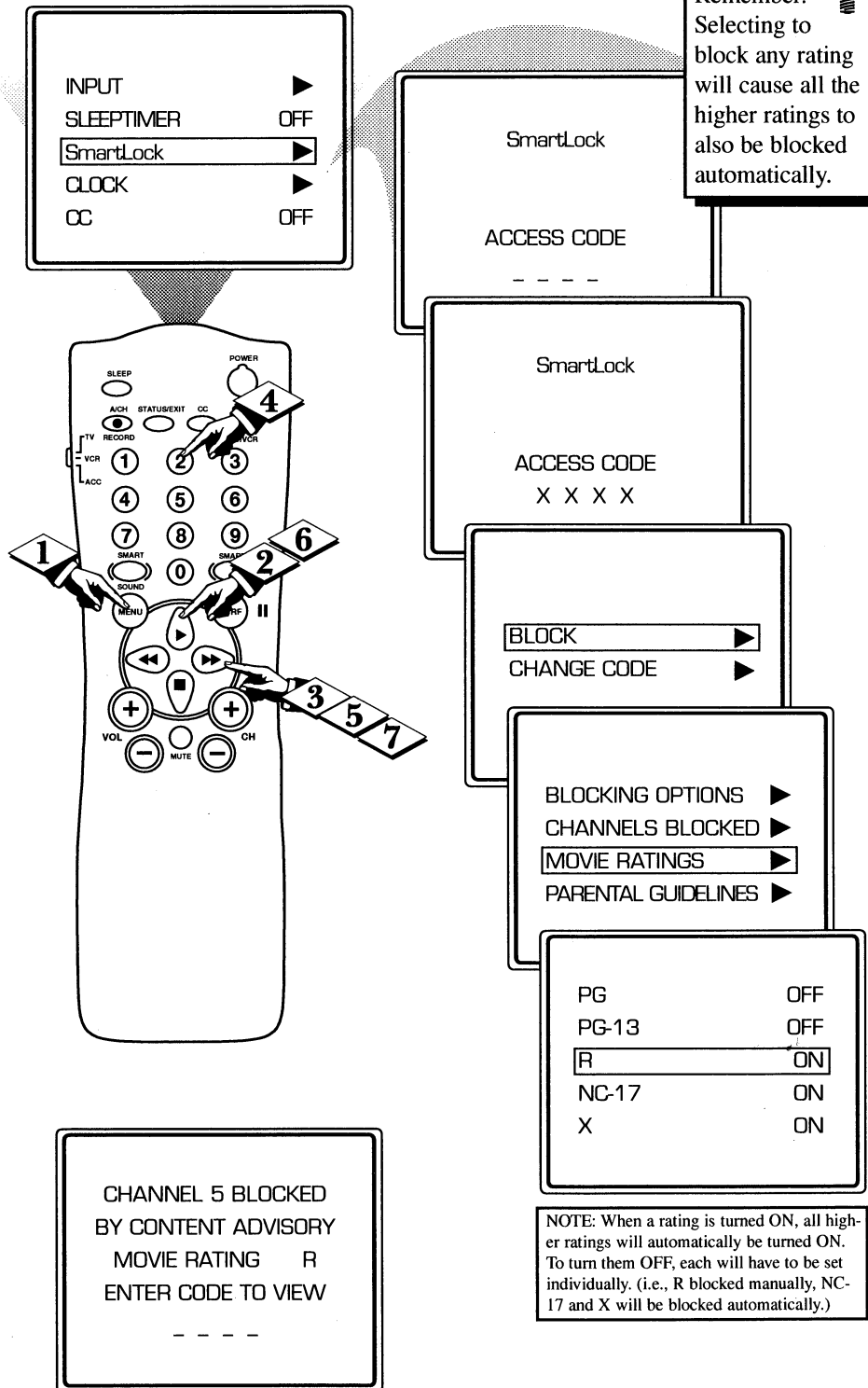

Screen will display a message when programming is blocked by the Movie Rating feature. To unblock, turn the Movie Rating **OFF**, or enter your personal access code. Entering the code will unblock ALL blocked Movie Ratings until the TV is turn off. Then the blocked ratings will be reset to **ON**.

NOTE: When a rating is turned **ON**, all higher ratings will automatically be turned **ON**. To turn them **OFF**, each will have to be set individually. (i.e., R blocked manually, NC-17 and X will be blocked automatically.)

UNDERSTANDING THE SMARTLOCK™ CONTROL (PARENTAL GUIDELINE)

This portion of the SmartLock features cover program ratings based on the TV Industry rating system. This is known as Parental Guideline within SmartLock.

After selecting the SmartLock feature and entering your personal access code, the BLOCK/CHANGE CODE screen appears;

BEGIN

1 With the word **BLOCK** highlighted, Press the **CURSOR RIGHT** button.

2 Scroll the menu using the **CURSOR UP** or **CURSOR DOWN** buttons until the words **PARENTAL GUIDELINE** are highlighted.

3 Press the **CURSOR RIGHT** button to display the **Parental (TV) Guideline (TV-Y, TV-Y7, TV-G, TV-PG, TV-14, or TV-MA)**.

When highlighted, the TV-Y and TV-G can be turned **ON** (which will allow blocking) or **OFF** (which will allow viewing), of these rated programs.

4 The ratings of **TV-Y7, TV-PG, TV-14, TV-MA** can be customized to block **V** (violence), **FV** (fantasy violence), **S** (sexual situations), **L** (coarse language), or **D** (suggestive dialogue).

Using the **CURSOR RIGHT** or **CURSOR LEFT** buttons on the remote to turn the rating option **ON** or **OFF**.



SMART HELP



Remember: Selecting to block any rating will cause all the higher ratings to also be blocked automatically.

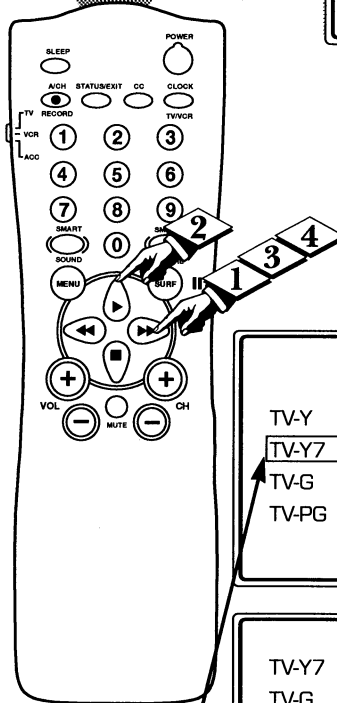
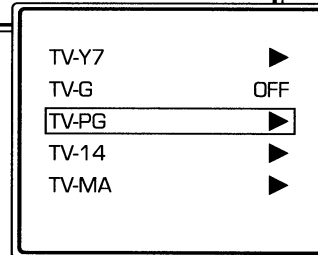
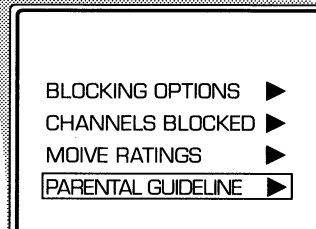
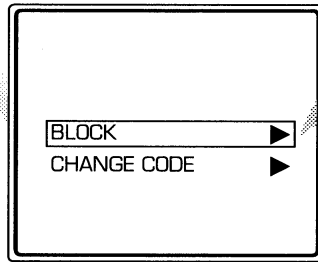

TV RATING SUB MENUS:

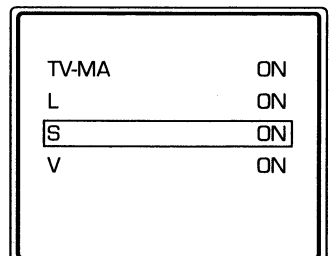
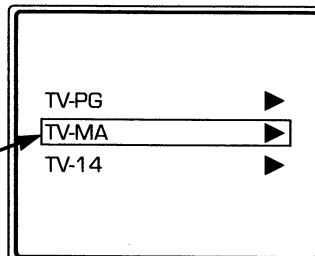
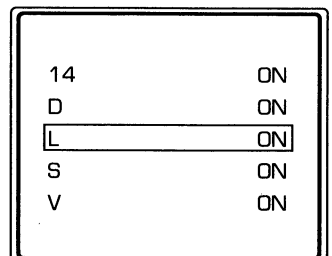
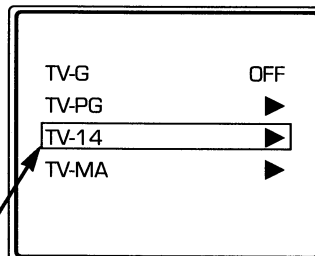
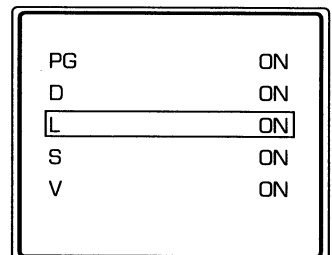
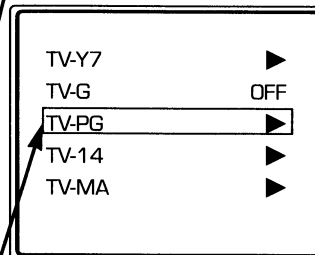
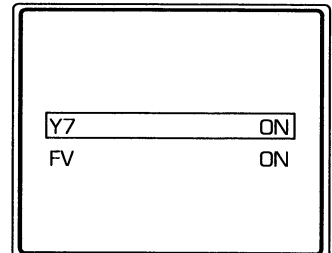
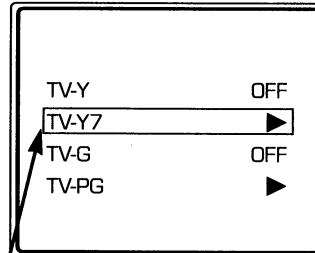

TV-Y - (All children -- This program is designed to be appropriate for all children.) Designed for a very young audience, including children ages 2-6. This type of programming is not expected to frighten younger children.

TV-Y7 - (Directed to Older Children -- This program is designed for children age 7 and above.) It may be more appropriate for children who have acquired the development skills needed to distinguish between make-believe and reality. This programming may include mild fantasy and comic violence (FV).

TV-G - (General Audience -- Most parents would find this program suitable for all ages.) This type of programming contains little or no violence, no strong language and little or no sexual dialogue or situations.

TV-PG - (Parental Guidance Suggested -- This program contains material that parents may find unsuitable for younger children.) This type of programming contains one or more of the following: Moderate violence (V), some sexual situations (S), infrequent coarse language (L), or some suggestive dialogue (D).

TV-14 - (Parents Strongly Cautioned -- This program contains some material that many parents would find unsuitable for children under 14 years of age.) This type of programming contains one or more of the following: intense violence (V), intense sexual situations (S), strong coarse language (L), or intensely suggestive dialogue (D).

TV-MA - (Mature Audience Only -- This program is specifically designed to be viewed by adults and therefore may be unsuitable for children under 17.) This type of programming contains one or more of the following: graphic violence (V), explicit sexual situations (S), or crude indecent language (L).

UNDERSTANDING THE SMARTLOCK™ CONTROL (REVIEW SCREEN)

Now that you've learn how to block channels or censor your viewing using the Movie Ratings or Parental (TV) Guideline let's review what you've done. The SmartLock Review feature allows you to see what has been blocked. Whenever the Menu button is pressed the onscreen menu will be displayed with the SmartLock Review highlighted.

BEGIN

1 Press the **MENU** button on the remote to show the onscreen menu. **SmartLock REVIEW** will be highlighted.

2 Press the **CURSOR RIGHT** button and the SmartLock Review Menu will appear.

This menu will display what channels have been blocked; what Movie Ratings have been blocked; what Parental (TV Ratings) Guidelines have been blocked. This review screen will also display that status of Unrated and No Rating settings. If the Master Disable feature has been turned ON, the SmartLock Review screen will display "SmartLock DISABLED."

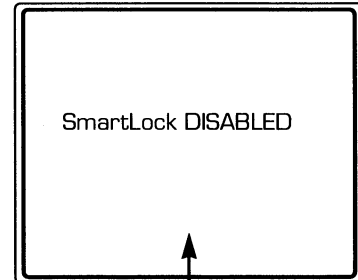
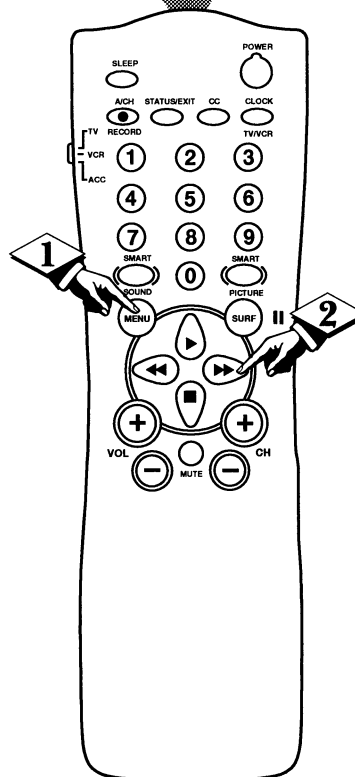
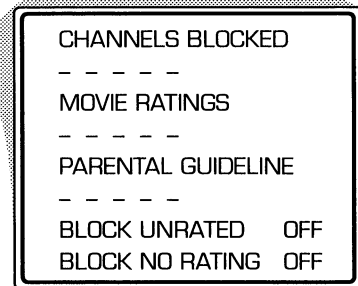
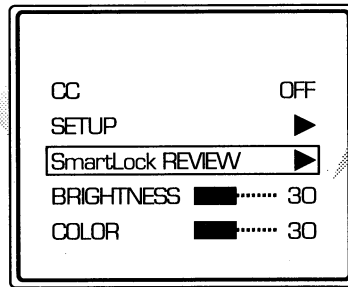

SmartLock DISABLED will appear in the SmartLock Review screen if the SmartLock Disable feature is set to ON.

CHANNELS BLOCKED - Shows all blocked channels that were set within the CHANNELS BLOCKED feature. Up to 5 channels may be blocked at one time.

MOVIE RATINGS - Shows all blocked Movie Ratings that were set within the MOVIE RATINGS feature. All or some may be blocked at one time. Note: If a lower rating is blocked; this will automatically cause the higher ratings to be blocked also. (i.e., if R is set to be blocked, X will automatically be blocked also.)

PARENTAL GUIDELINE - Shows all blocked TV Ratings that were set within the PARENTAL GUIDELINES feature. All or some may be blocked at one time. Note: If a lower rating is blocked; this will automatically cause the higher ratings to be blocked also. (i.e., if TV-14 is set to be blocked, TV-MA will automatically be blocked.) Parental Guidelines also have sub ratings for Violence (V), Fantasy Violence (FV), Sexual Situations (S), Coarse Language (L), and Suggestive Language (D). If the main rating is turned off but the sub rating is turned ON, the program will be blocked but the rating will not appear within the SmartLock Review menu.

BLOCK UNRATED - Shows ON or OFF depending on the status of the BLOCK UNRATED feature. Based on the Movie Ratings or Parental (TV) Guidelines.

BLOCK NO RATING - Shows ON or OFF depending on the status of the BLOCK NO RATING feature. Based on programming with NO content advisory data.

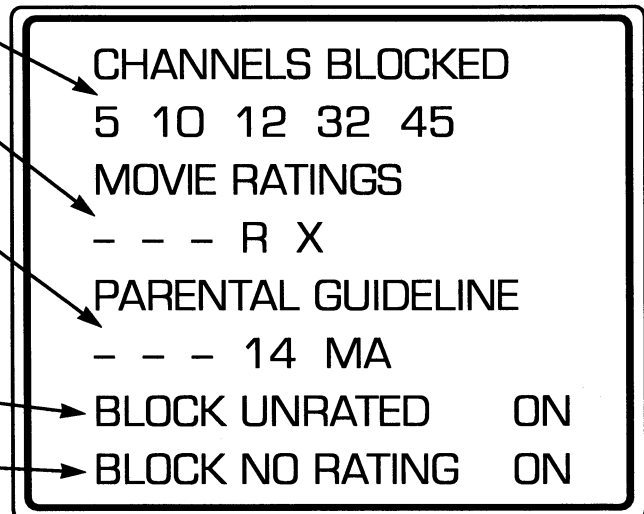

HOW TO USE THE INPUT CONTROL (A/V INPUTS)

AUDIO/VIDEO INPUTS

The TV's Audio/Video Input jacks are for direct picture and sound connections between the TV and a VCR (or similar device) that has Audio/Video Output jacks.

BEGIN

1 Connect the VIDEO (yellow) CABLE to the VIDEO IN jack on the back of the TV. Then connect the AUDIO (red and white) CABLES to the AUDIO (left and right) IN jacks on the rear of the TV.

2 Connect the VIDEO (yellow) CABLE to the VIDEO OUT jack on the back of the VCR. Then connect the AUDIO (red and white) CABLES to the AUDIO (left and right) OUT jacks on the rear of the VCR.

3 Turn the VCR and the TV ON.

4 Press the MENU button on the remote to display the onscreen menu.

5 Press the CURSOR UP \blacktriangleright or CURSOR DOWN \blacktriangledown buttons until the word INPUT is highlighted.

6 Press the CURSOR RIGHT \blacktriangleright or CURSOR LEFT \blacktriangleleft button to display the picture/sound menu (ANTENNA, EXT 1). Use the CURSOR UP \blacktriangleright or DOWN \blacktriangledown buttons to select.

Insert a pre-recorded tape and press the PLAY \blacktriangleright button on the VCR or remote.

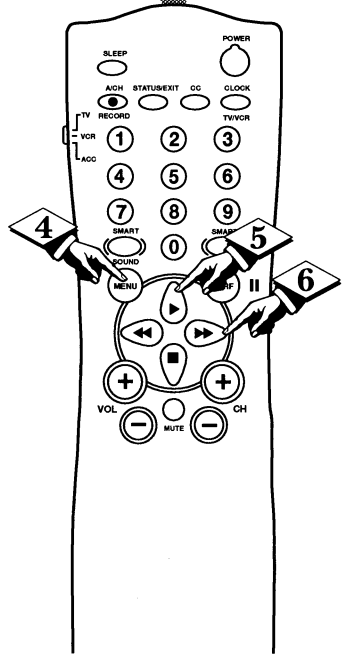
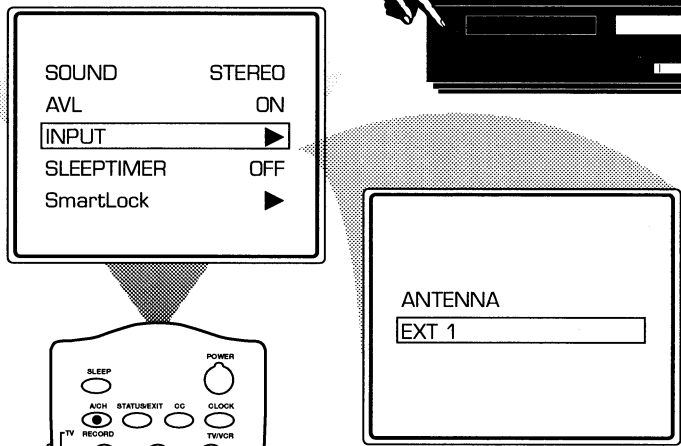
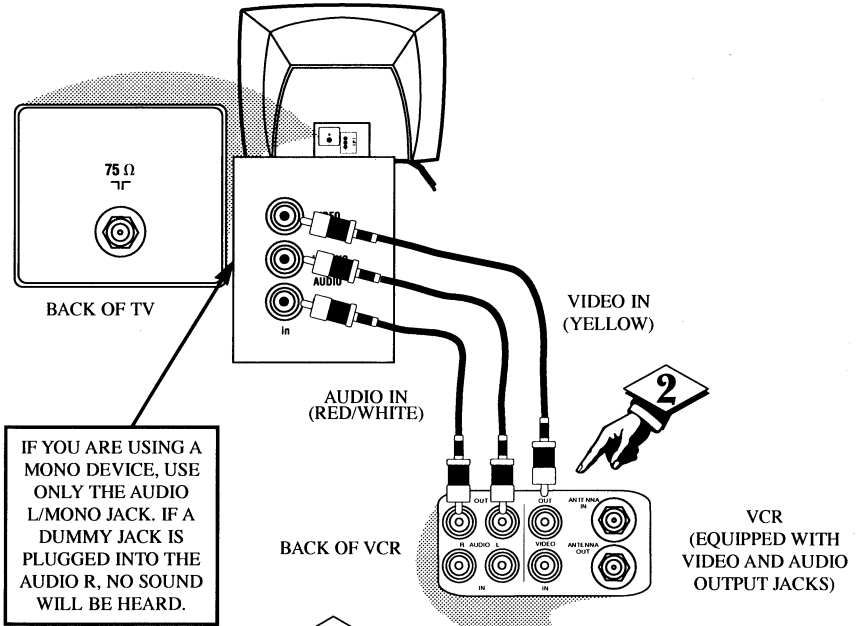



Whether you're watching a movie or a video game, your TV has automatic video control settings matched for your current program source or content. The SmartPicture feature quickly resets your TV's video controls for a number of different types of programs and viewing conditions you may have in your home. Each SmartPicture setting is preset at the factory to automatically adjust the TV's Brightness, Color, Picture, Sharpness, Tint, and Color Temperature levels.

BEGIN

- 1 Press the **SMART PICTURE** button on the remote control. The current SmartPicture setting will appear in the middle of the screen.
- 2 Press the **SmartPicture** button repeatedly to select either **PERSONAL**, **MOVIES**, **SPORTS**, or **WEAK SIGNAL** picture settings.

Note: The **PERSONAL** setting is the setting that you setup using the **PICTURE** options within the onscreen menu. This is the only setting that can be changed. All other settings are setup at the factory during the time of production.

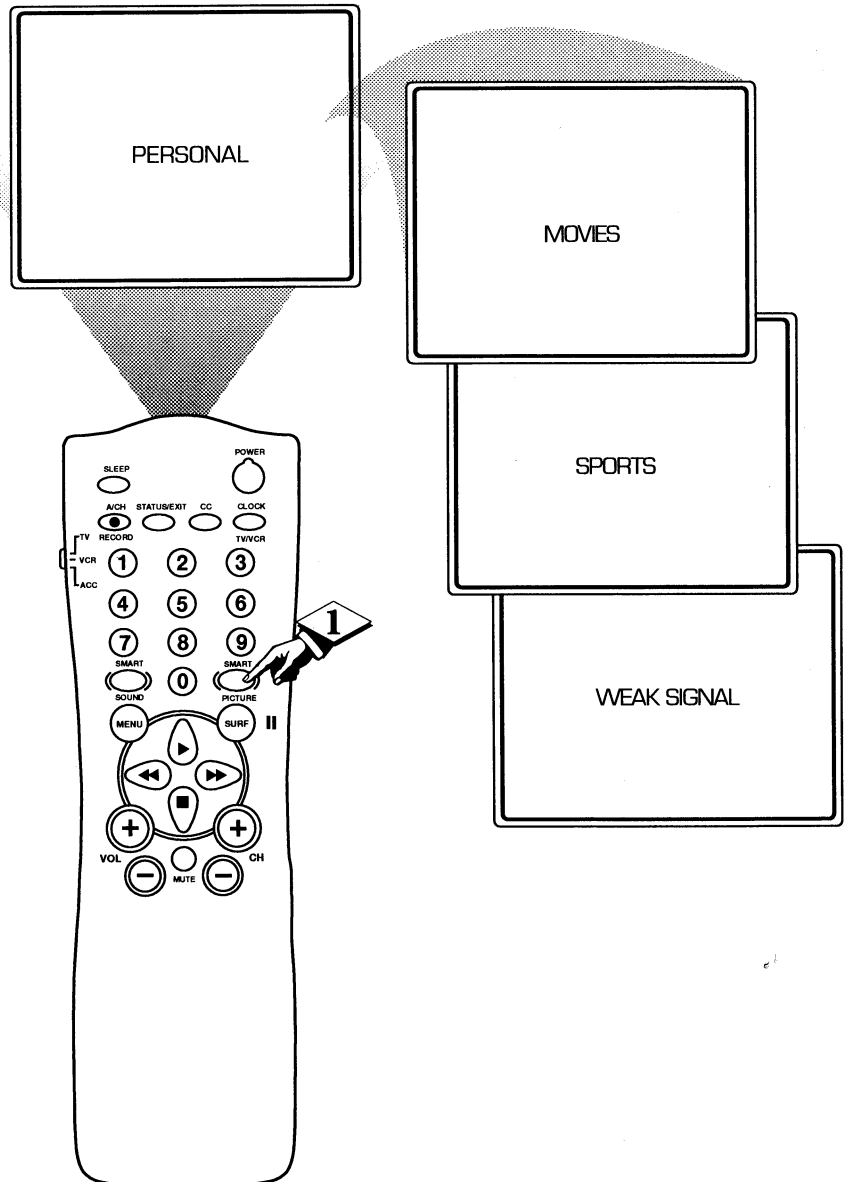

USING THE SMARTSOUND™ CONTROL

The SmartSound feature allows the listener to select between four different factory set sound options. Personal (which can be set by the user), Theater (for movie viewing), Music (for musical type programming) and Voice (when the program is mainly dialogue). To select any of the options follow the directions below.

BEGIN

- 1 Press the SMARTSOUND button on the remote control. The current SmartSound setting will appear in the middle of the screen.
- 2 Press the SMART SOUND button repeatedly to toggle between the four settings.

Remember, only the PERSONAL control can be changed by the viewer. This changes the settings in the main onscreen menu's sound controls.

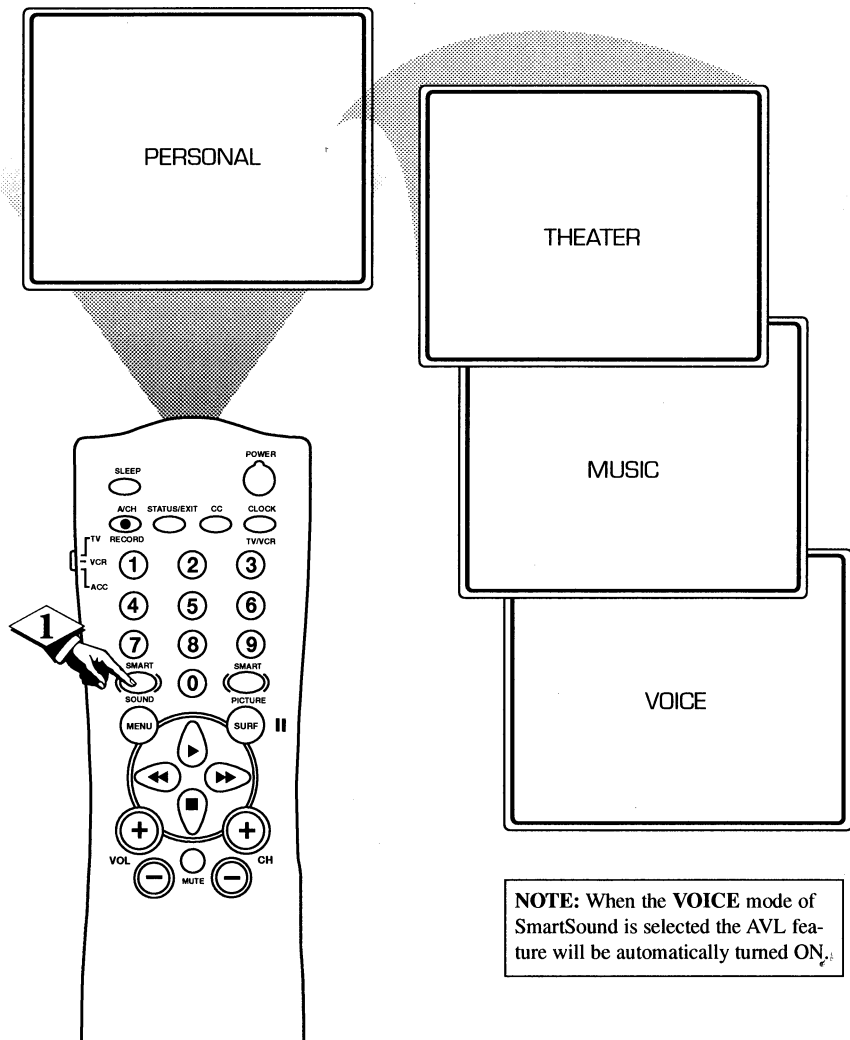

SMART HELP

Remember, Smart Sound works only with the programs coming through the 75 Ω input on the rear of the TV (RF audio). It will not control the sound levels for the External connections.

AVL CONTROL

In most cases the volume levels coming from broadcast programming or commercials are never the same. With the AVL control turned ON, you can have the TV level out the sound being heard. This makes for a more consistent sound by reducing the peaks and valleys that occur during program changes or commercial breaks.

BASS BOOST	ON
SOUND	STEREO
AVL	OFF
INPUT	EXT 1
SLEEPTIMER	OFF

BASS BOOST	ON
SOUND	STEREO
AVL	ON
INPUT	EXT 1
SLEEPTIMER	OFF



A "list" or series of previously viewed channels can be selected with the SURF button on your remote control. With this feature you can easily switch between different TV programs that currently interest you. The SmartSurf control allows you set up to eight channels in its quick viewing "list".

BEGIN

- 1 Press the CHANNEL (+) or (-) buttons (or the NUMBER buttons) to select a channel to add to the SURF list.
- 2 Press the SURF button on the remote while the channel number is still displayed to ADD the channel to the SURF list.
- 3 Repeat steps 1 through 2 to add additional channels (up to 8) to the SURF list.

To remove a channel for the SURF list, simply choose the channel with the numbered buttons and press the SURF button while the channel number is still displayed and the screen will read DELETED.



A/CH BUTTON

Your remote also has an A/CH (Alternate Channel) button. Pressing this button will toggle between the Current and one previously selected channel.

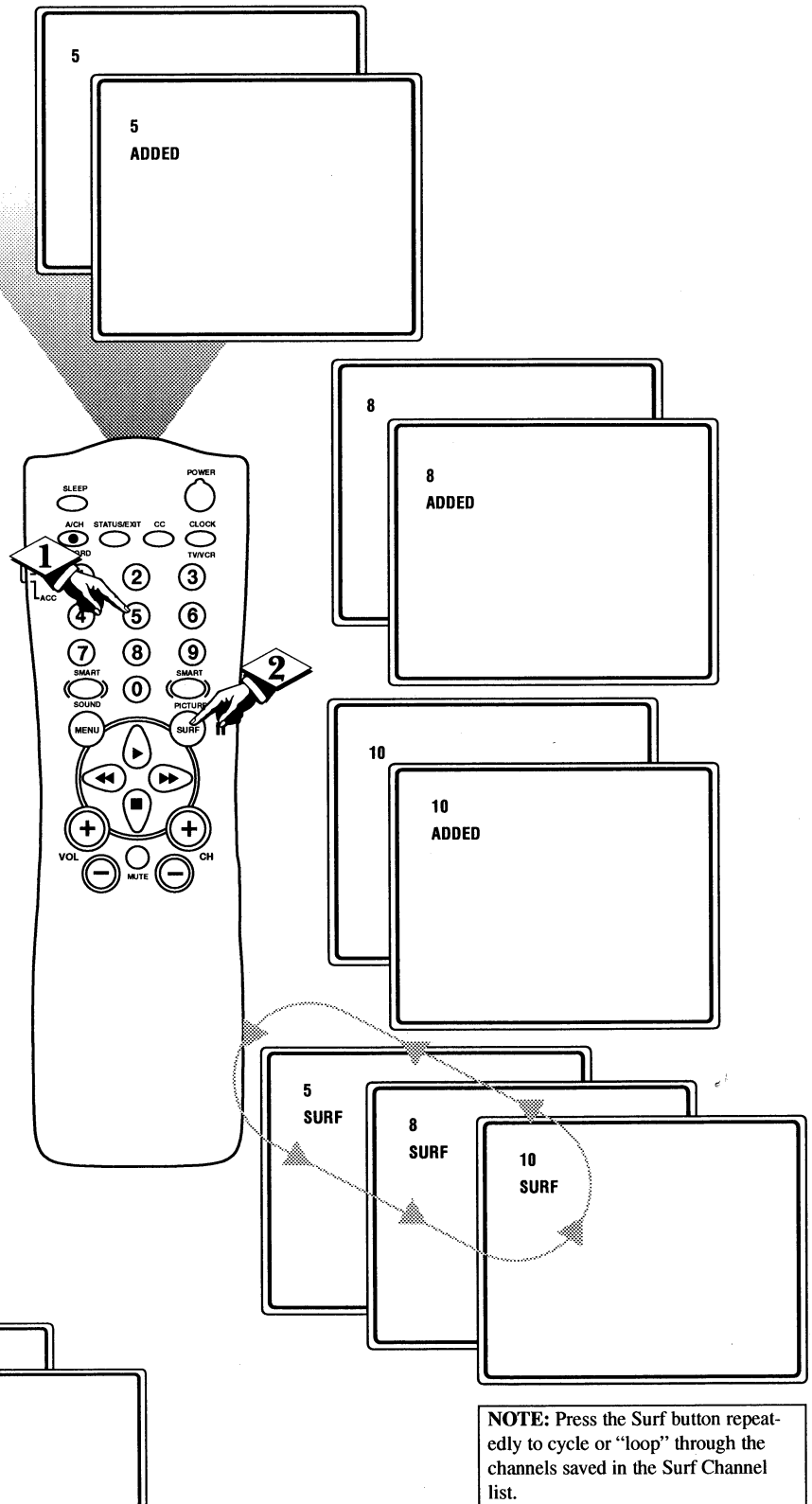

NOTE: Press the Surf button repeatedly to cycle or "loop" through the channels saved in the Surf Channel list.

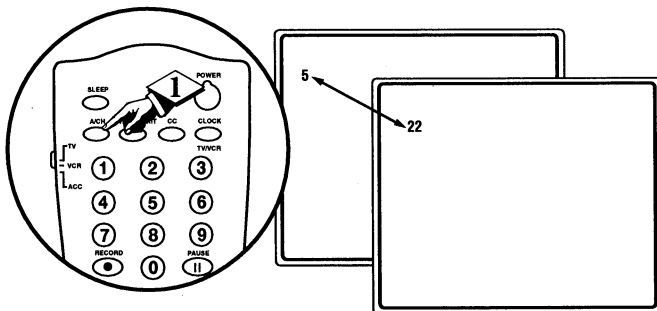

USING THE TREBLE BOOST AND BASS BOOST CONTROLS



Besides the normal volume level control, your TV also has Bass and Treble Boost sound adjustment controls. The **TREBLE Boost** effects only the high frequency sound coming from the TV enhancing the highs; while the **BASS Boost** effects only the low frequency sound coming from the TV enhancing the lows.

BEGIN

- 1 Press the **MENU** button on the remote to show the onscreen menu.
- 2 Press the **CURSOR UP** or **CURSOR DOWN** buttons to select and highlight the name of the control you wish to change (**TREBLE BOOST**, or **BASS BOOST**).
- 3 Use the **CURSOR LEFT** or **RIGHT** buttons to turn the selected control **ON** or **OFF**.



NOISE REDUCTION ON
 VOLUME 15
TREBLE BOOST OFF
 BASS BOOST OFF
 SOUND STEREO

NOISE REDUCTION ON
 VOLUME 15
TREBLE BOOST ON
 BASS BOOST OFF
 SOUND STEREO

OR





VOLUME 15
 TREBLE BOOST ON
BASS BOOST OFF
 SOUND STEREO
 AVL ON

VOLUME 15
 TREBLE BOOST ON
BASS BOOST ON
 SOUND STEREO
 AVL ON

HOW TO SET THE TV FOR STEREO PROGRAMS

Your TV can detect a stereo signal and will set itself automatically so the stereo sound can be heard. However, there may be occasions when you might want to set the TV to mono. The following steps describe how to change the **SOUND** control:

BEGIN

- 1 Press the **MENU** button on the remote to show the onscreen menu.
- 2 Press the **CURSOR UP**  or **CURSOR DOWN**  button until the word **SOUND** is highlighted.
- 3 Press the **CURSOR RIGHT**  or **CURSOR LEFT**  buttons to choose between **STEREO** or **MONO**.

With **STEREO** selected, the television will reproduce any stereo broadcast signal it receives. Please note that you can force a stereo broadcast signal to **MONO**, but you cannot force a mono broadcast signal to stereo.

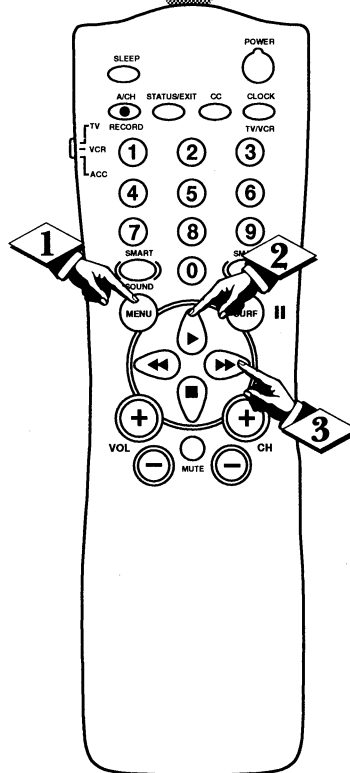
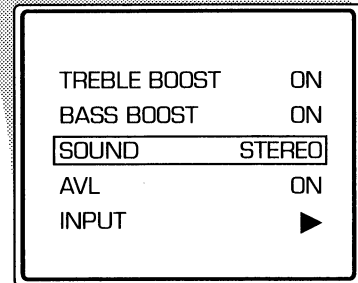
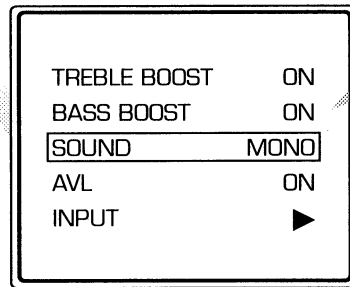

SMART HELP

 Remember: If stereo is not present on a selected show and the TV is placed in the **STEREO** mode, the sound coming from the set will remain monaural (mono).

USING THE TV VOLUME BAR CONTROL



Use the Volume Bar control to see the TV's volume level settings on the TV screen. The Volume Bar will be seen each time the VOLUME buttons (on the TV or remote) are pressed.

BEGIN

- 1 Press the **MENU** button to display the onscreen menu.
- 2 Press the **CURSOR UP** or **CURSOR DOWN** buttons until the word **VOLUME** is highlighted.
- 3 Press the **CURSOR RIGHT** button to increase the TV's volume or the **CURSOR LEFT** button to decrease the sound.

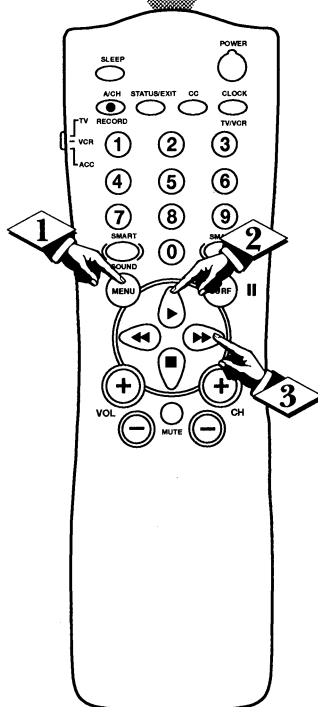
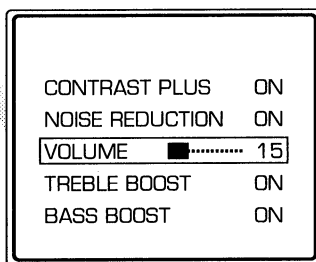

OR

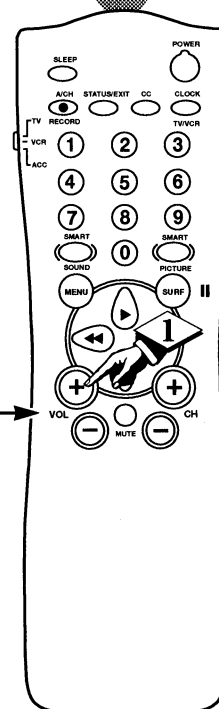
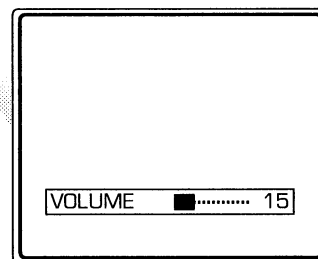

Note: Pressing the VOL (+) or (-) buttons will also allow you to adjust the sound level of the TV. A Volume Bar adjustment will appear onscreen. Press the (+) to increase the volume and the (-) button to decrease the volume.

SETTING THE REMOTE CONTROL TO WORK WITH OTHER DEVICES

Your remote control is set to work your TV and many infrared remote (IR) control VCRs, Cable Boxes, Satellite Systems, DBS, DVD, etc. However, an easy onetime step may be necessary before the remote will work your VCR.

Try this initial check to see if going on to the following section is necessary.

BEGIN

- 1** Place the TV/VCR/ACC Mode Switch in the proper position.
- 2** Point the remote control at the device and press the POWER button.
- 3** Does the remote turn the device ON?
If YES, stop and try other function buttons on the remote. If they also work the device, then the remote is ready and no further steps are needed.
If NO, continue...

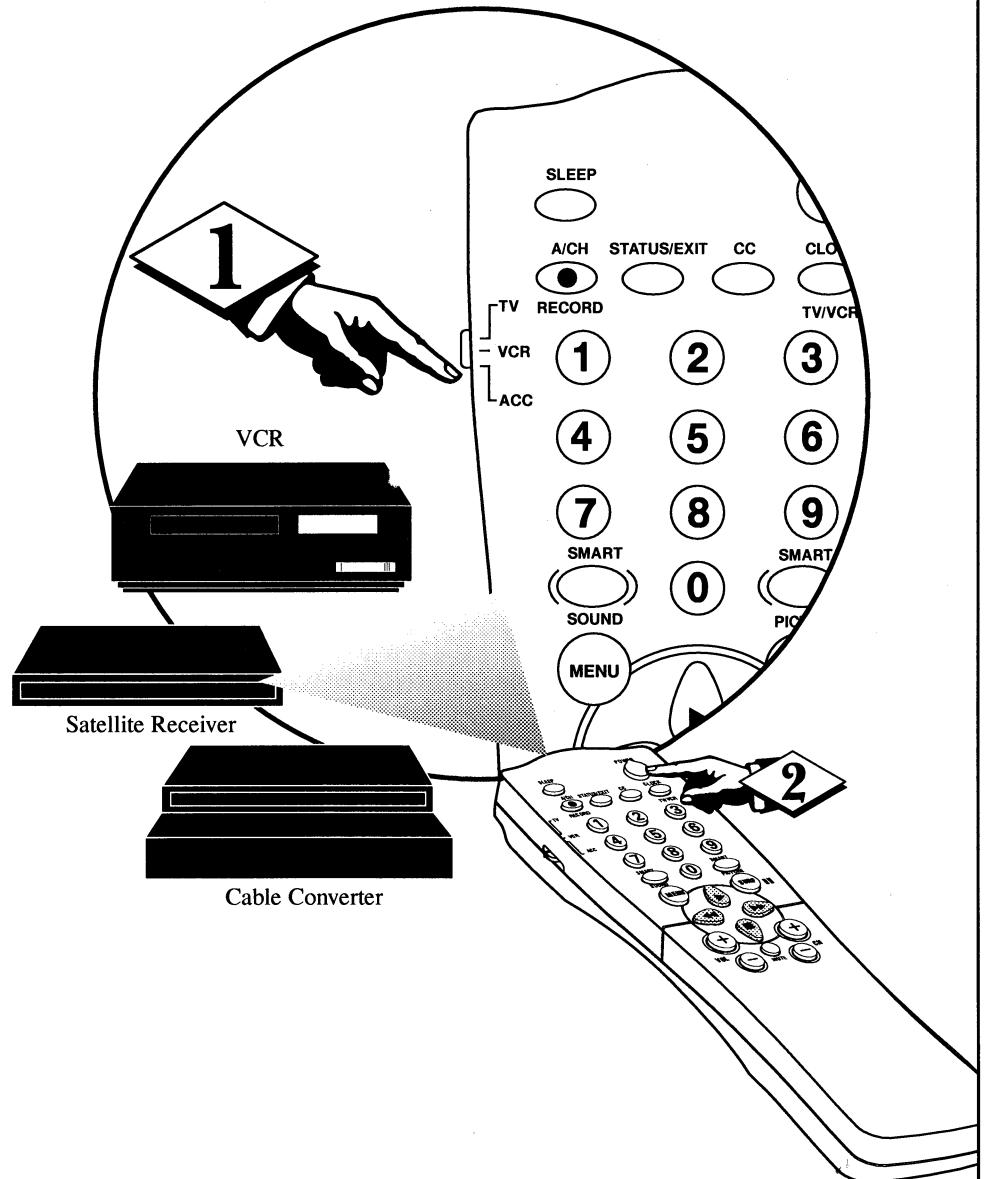

- 1** First look up a **THREE-DIGIT remote control number** for your brand of Device before going through the simple steps on the following page.

Find your Three-Digit Code on pages 29-30.



SMART HELP

Remember, if more than one number is listed, you may have to try more than the first Three-Digit code given in order to locate your Device's remote code.

SETTING THE REMOTE CONTROL TO WORK WITH OTHER DEVICES



Direct Access Method

Now that you have looked up the three-digit Remote Code Number for your brand of device, you are ready to follow the four simple steps below.

Please read through steps 1-4 before beginning.

BEGIN

- 1 Place the TV/VCR/ACC Mode Switch in the proper position.
- 2 Press the A/CH • RECORD button on the remote control and release.
- 3 Press the SMART SOUND button on the remote within 30 seconds, then release.
- 4 Enter the THREE-DIGIT REMOTE CODE NUMBER for your desired device. The remote is now ready to send commands to the unit.
- 5 Point the remote at the Device. Press the POWER button on the remote to turn the unit ON.



SMART HELP

Remember, if this doesn't work the first time, repeat steps using the same remote code number.

After a second try and the remote does not operate your device, see if there is another three-digit code number (pages 29-30) listed for your device and repeat the steps above using the new number.

If after repeated attempts the code number method does not work your device, try the **SEARCH METHOD** on page 28.

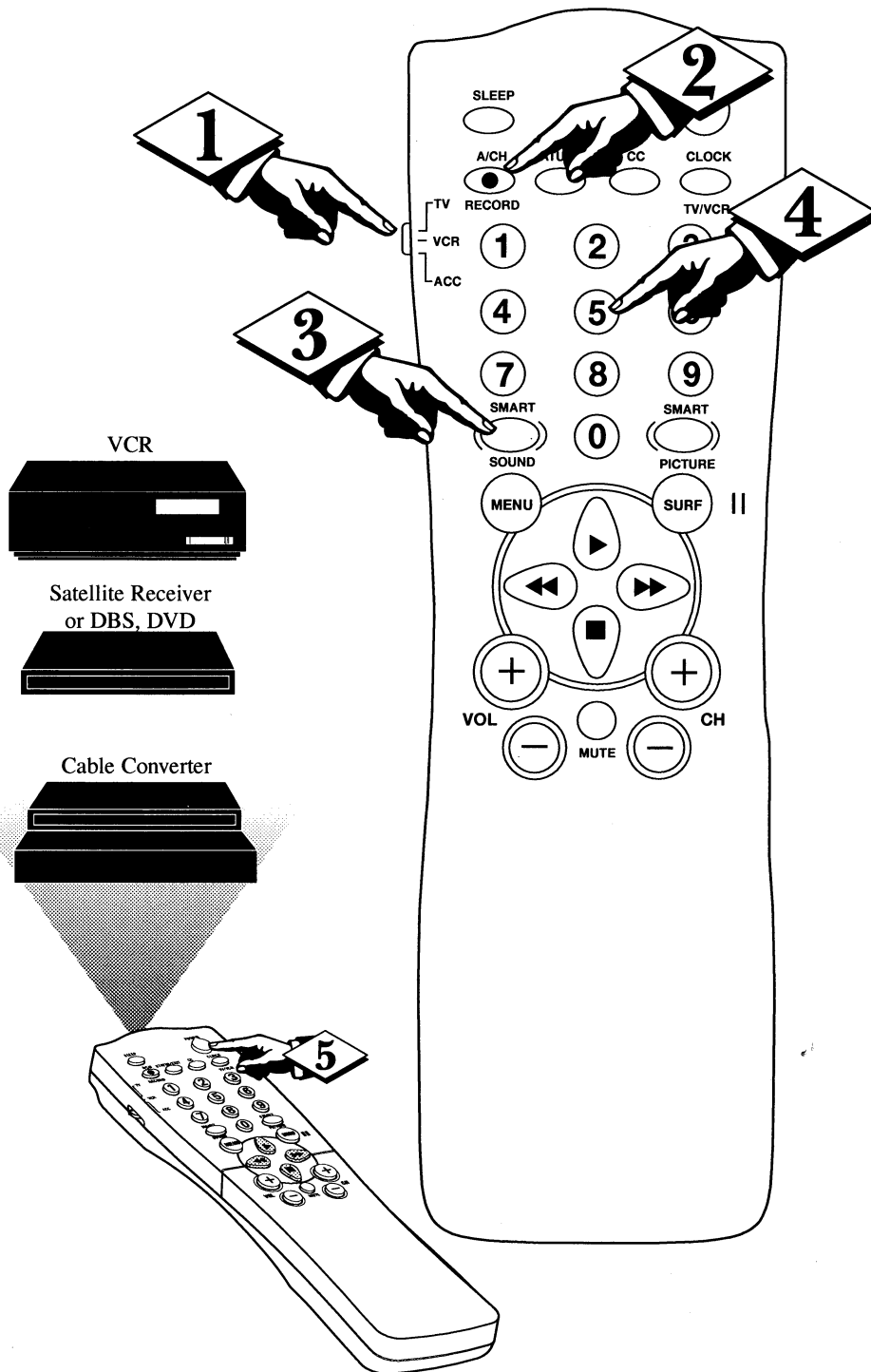

SETTING THE REMOTE CONTROL TO WORK WITH OTHER DEVICES

Search Method

Your TV remote can be set to work various external devices such as VCRs, Cable Boxes, Satellite Receivers, Dss, DVD, etc. by what is called the search method of remote control programming.

If the "Remote Code" number method shown on page did not set your remote to work your external device, then follow the easy steps listed below.

Please read steps 1-4 before beginning.

BEGIN

- 1 Press the **POWER** button on the device you are attempting to program to turn it ON.
- 2 Place the **TV/VCR/ACC Mode Switch** in the proper position.
- 3 Press the **VCR • RECORD** and the **SMART SOUND** buttons simultaneously and hold them down.
- 4 The device will begin to change channels after the remote identifies the correct code. When the channels start to change release the **VCR RECORD** and **SMART SOUND** buttons. The remote should be ready to operate the device.



SMART HELP



This method can take up to two minutes to perform.

Don't let the device scan up more than five channels. If you do the remote may pass up the right code and another two minute search cycle will have to be repeated.

If no channel change happens within two minutes, repeat steps 1-4. Should a channel change still not occur, the remote will not work the desired device.

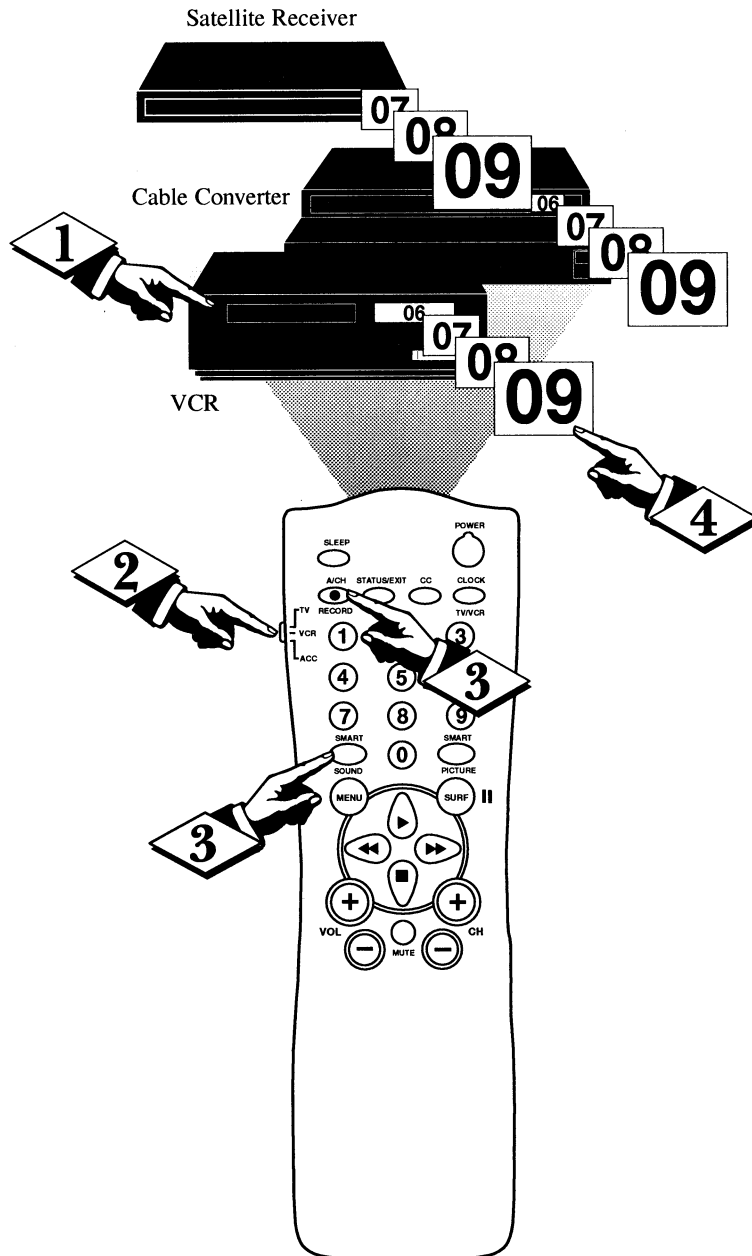

REMOTE CONTROL DIRECT ENTRY CODES



<u>VCR</u>	<u>REMOTE CODE NO.</u>	<u>VCR</u>	<u>REMOTE CODE NO.</u>	<u>VCR</u>	<u>REMOTE CODE NO.</u>
Admiral	.048	Loewi	.004, 072	Sanyo	.046, 047, 104, 240, 268
Advantz	.358	Logik	.004, 072	Saville	.352
Adventure	.000	MEI	.035	Scott	.043, 045, 121, 164, 211, 212
Aiko	.278	MGA	.043, 061	Sears	.000, 035, 037, 042, 046, .047, 054, 066, 104, 105
Aiwa	.000, 037, 307, 348, 352	MGN Technology	.240	Sharp	.046, 062
Akai	.041, 049, 053, 061, 106, 315	MTC	.000, 240	Shintom	.072
Alba	.352	Magnavox	.000, 035, 081, 146, 181	Shogun	.051, 240
Amercian High	.035	Marta	.037	Shoral	.004
Amstrad	.325, 332	Matsui	.004, 348, 352	Siemens	.003
Asha	.240	Matsushita	.035, 162, 454	Singer	.072
Audiovox	.037	Memorex	.307	Sinudyne	.004
Baird	.107	Memorex	.000, 035, 037, 039, 046, .047, 048, 104, 240, 266, 307	Sony	.000, 011, 022, 032, 033, .034, 035, 253, 275
Beaumark	.240	Metz	.003, 347	Sunkel	.348
Bell & Howell	.104	Minolta	.042, 105	Sunpak	.253
Blaupunkt	.003, 006, 154	Mitsubishi	.043, 061, 067, 075, 173, 443	Sylvania	.000, 035, 043, 081, 103, 110
Brandt	.187, 320, 321	Motorola	.035, 048	Symphonic	.000
Broksonic	.121, 184, 211, 295, 361	Multitech	.000, 072	TMK	.036, 208, 240
Bush	.352	NAD	.058	Tatung	.041
CCE	.072, 278	NEC	.036, 040, 041, 067, 104	Teac	.000, 041
Calix	.037	Nikko	.037	Technics	.035, 162
Canon	.035	Nikon	.034, 253	Teknika	.000, 035, 037
Capelhart	.020	Noblex	.240	Telefunken	.187, 320, 321
Carver	.081, 146	Nordmende	.297, 320, 321	Tansal	.322
Citizen	.037, 278	Okano	.346	Thomas	.000
Colt	.072	Olympus	.035, 226	Thomson	.320
Combitach	.352	Optimus	.037, 048, 058, 104, .162, 432, 454	Toshiba	.043, 045, 066, 212, 366
Craig	.037, 047, 072, 240, 271	Optonica	.062	Totavision	.037, 240
Curtis Mathes	.035, 041, 060	Orion	.004, 295, 348, 352, 479	Towada	.322
Cybermax	.051, 240	Panasonic	.035, 077, 162, 225, .226, 378, 454	Unitech	.240
Daewoo	.020, 045, 276	Penney	.035, 037, 038, 040, .042, 065, 105	Universum	.325
Daytron	.020	Pentax	.042, 065, 105	Vactor	.045
Denon	.042	Philco	.035	Vactor Research	.038, 040
Dynatech	.000	Philips	.035, 062, 081, 110, 403	Video Concepts	.040, 045, 061
Electroponic	.037	Pilot	.037	Videosonic	.240
Emerex	.032	Pioneer	.058, 067	Wards	.000, 035, 042, 047, 048, 060, 062, .072, 081, 149, 161, 212, 240
Emerson	.000, 002, 036, 037, 043, 061, .068, 088, 121, 164, 208, 209, .211, 212, 278, 295, 361, 479	Portland	.020	XR-1000	.000, 035, 072
Ferguson	.107, 320, 321	Profax	.322	Yamaha	.038
Fisher	.047, 054, 066, 104	Profitronic	.240	Zenith	.000, 033, 034, 039
Fuji	.033, 035	Protec	.072		
Funai	.000	Pulsar	.039, 051	CABLE CONVERTOR	REMOTE CODE NO.
GE	.035, 060, 065, 202	Quarter	.046	ABC	.001, 003, 007, 008, .011, 013, 014, 017
Garrard	.000	Quartz	.046	Aliegio	.153
Go Video	.232, 279, 432	Quasar	.035, 077, 162, 454	Andover	.544
Gold Star	.037, 038	RCA	.042, 060, 065, 077, .105, 106, 149, 202	Antronix	.022
Gradiente	.000, 406	Radio Shack	.000, 037	Archer	.022, 153
Grundig	.003, 007, 195, 347	Radix	.037	Balcor	.056
HI-Q	.047	Randex	.037	British Telecom	.105
Harley Davidson	.000	Realistic	.000, 035, 037, 045, 047, .048, 062, 066, 104	Cable Star	.056
Harman/Kardon	.038, 075	Ricoh	.034, 253	Cablatenna	.022
Harwood	.068, 072	Runco	.039	Cabletime	.161, 271, 377, 448
Headquarter	.046	SEG	.322	Cableview	.022
Hinari	.004, 352	SEI	.004	Century	.153
Hitachi	.000, 004, 041, 042, .065, 105, 168, 235	STS	.042	Citizen	.153
Ingersol	.004	Saba	.297, 320, 321	Clyde	.086
JVC	.008, 041, 067, 208, 384, 486	Saisho	.004	Colour Voice	.025, 031
Jensen	.041	Salora	.075	Comtec	.274
KEC	.037, 278	Samung	.045, 051, 053, 240	Comtronics	.040
KLH	.072	Sanky	.039, 048	Contec	.019
Kenwood	.038, 041, 067, 384	Sansui	.000, 041, 067, 271	Cryptovision	.600
Kodak	.035, 037			Deecat	.423
LXI	.037				
Lloyd's	.000, 206				



REMOTE CONTROL DIRECT ENTRY CODES

<u>CABLE CONVERTOR</u>	<u>REMOTE CODE NO.</u>
Eastern	.002, 274
Everquest	.015, 040
Filmnet	.443
Focus	.400
France Telecom	.451
GC Electronics	.056
GEC	.086
Ganard	.153
Gemini	.015, 070, 242
General Instrument	.011, 276, 476
Gold Star	.040
Grundig	.529
Hamlin	.009, 020, 034, 259
Hitachi	.011
Hytex	.007
Jasco	.153
Jerrold	.003, 011, 012, 014, .015, 024, 276, 476
M.N.E. T.	.443
MNet	.443
Macon	.033
Magnavox	.027, 032, 334
Memorex	.000
Movie Time	.063
NSC	.063, 070
Oak	.007, 019
Optimus	.021
Panasonic	.000, 021, 107
Paragon	.000
Philips	.025, 027, 031, 153, 242, 290, 334
Pioneer	.533, 753
Popular Mechanics	.400
Pulsar	.000
RCA	.021
Radio Shack	.015
Recoton	.400
Regal	.020, 259
Regency	.002
Rembrandt	.011, 070
Runco	.000
SL Marx	.040
Salora	.382
Samsung	.040
Satbox	.375
Scientific Atlanta	.008, 017, 477
Signal	.015, 040
Signature	.011
Sprucer	.021
Star Sight	.542
Starcom	.003, 015
Stargate	.015, 040
Starquest	.015
Sylvania	.001
TV85	.063
Tandy	.258
Tele+1	.443
Teleservice	.281
Televue	.040
Texscan	.001
Timeless	.274
Tocom	.012, 013, 059
Toshiba	.000
Tudl	.286
Tusa	.015
Unike	.022, 153

<u>CABLE CONVERTOR</u>	<u>REMOTE CODE NO.</u>
United Artists	.007
United Cable	.003
Universal	.022, 056, 153, 191
Videoway	.250
Viewstar	.027, 063, 258
Visi Cable+	.461
Westminster	.105
Wolsey Gaine	.544
Zenith	.000, 054, 525
Zentek	.400

DBS

<u>CABLE CONVERTOR</u>	<u>REMOTE CODE NO.</u>
Alpha Star	.772
Echostar	.775
HTS	.775
Hitachi	.819
Hughes Network System	.749
Jerrold	.627
Magnavox	.722, 724
Memorex	.724
Panasonic	.701
Philips	.722, 724
Primestar	.627
RCA	.566
Sony	.639
Toshiba	.790
Uniden	.724

Satellite

<u>CABLE CONVERTOR</u>	<u>REMOTE CODE NO.</u>
AST	.351
Akai	.515
Alba	.352, 515, 613
Aldea	.288
Amstrad	.080, 252, 345, 461, 509, 689
Ankaro	.220, 288, 369
Anitron	.183
Armstrong	.243
Astra	.108
Avalon	.396
Axis	.369
BT	.515, 668
Beko	.189
Best	.369
Boca	.243, 513
Bush	.067
Cambridge	.344, 515
Channel Master	.362
CommLink	.288
Connexions	.396
Conrad	.607
Crown	.243
DDC	.362
DNT	.396
Echostar	.396
Ferguson	.067, 183, 189, 336
Fidelity	.252
Finiux	.108, 397
Fuba	.369, 396
G-Bat	.183
Galaxis	.286
Gooding	.571
Grundig	.173, 189, 571, 750
Hinari	.183

<u>Satellite</u>	<u>REMOTE CODE NO.</u>
Hirschmann	.397, 573
Houston	.668
Huth	.220, 243, 268
ITT	.108
Intervision	.592
JVC	.515, 571
Kathrein	.092, 504, 622, 658
La Sat	.513, 607
Lennox	.592
Lupus	.369
Luxor	.108, 573
Manhattan	.592
Maspro	.092, 336, 750
Matsui	.571
Mediamarkt	.248
Minerva	.571
Mintec	.576
Morgan's	.243, 513
Newhaus	.220
Nikko	.360, 713
Nokia	.108, 397, 573
Nordmende	.362
Orbitech	.501
Pace	.067, 183, 336, 455, 791
Paliadium	.571
Palsat	.501
Philips	.200, 292, 571, 750
Phonotrend	.288, 592
Plasmatic	.442
Proset	.288
Quadral	.362, 628
RFT	.220, 288
Radix	.396
SAT	.351, 461
SEG	.369
Saba	.336
Salora	.108
Satec	.183
Schwaiger	.183, 504
Seemann	.396, 578, 626
Skymaster	.288, 626
Sony	.704
Star Trak	.421
Strong	.421
Sunstar	.513
Tantec	.336
Techni Sat	.262, 501
Teleka	.243, 613
Tonna	.668
Triad	.351
Universum	.571
Vtech	.351
Wisi	.351, 396

REMOTE CODE NO.

DVD

Kenwood	.534
Mitsubishi	.521
Panasonic	.490
Philips	.539
Pioneer	.550
RCA	.522
Sony	.552
Toshiba	.503

USING THE REMOTE'S VCR BUTTONS



When using the TV remote with a VCR, first make certain it is set to control your VCR (by the REMOTE CODE or SEARCH method).

BEGIN

1 Set the TV/VCR/ACC mode switch to VCR on the remote.

2 Point the top of the remote toward the front of the VCR (remote sensor window) when pressing the buttons.



RECORD BUTTON

Hold the A/CH • RECORD button down to begin a VCR recording.

VCR SYSTEM SWITCH

Set in the VCR position to send remote commands to the VCR.

PLAY BUTTON

Press to begin playback of a video tape.

REWIND BUTTON

Press to rewind tapes. For some VCR's the STOP button may have to be pressed first, then REWIND. In playback mode hold down the button to view picture moving rapidly in reverse.

STOP BUTTON

Press to stop the motion of a tape in playback, rewind, fast forward, etc.

SMART HELP

Remember, the VCR buttons on the remote will not operate your VCR if those features are not found on your VCR remote control.

Note: All VCR functions (particularly Search, Rewind, Fast Forward, etc.) will operate the same as with the original VCR remote control provided with the VCR.

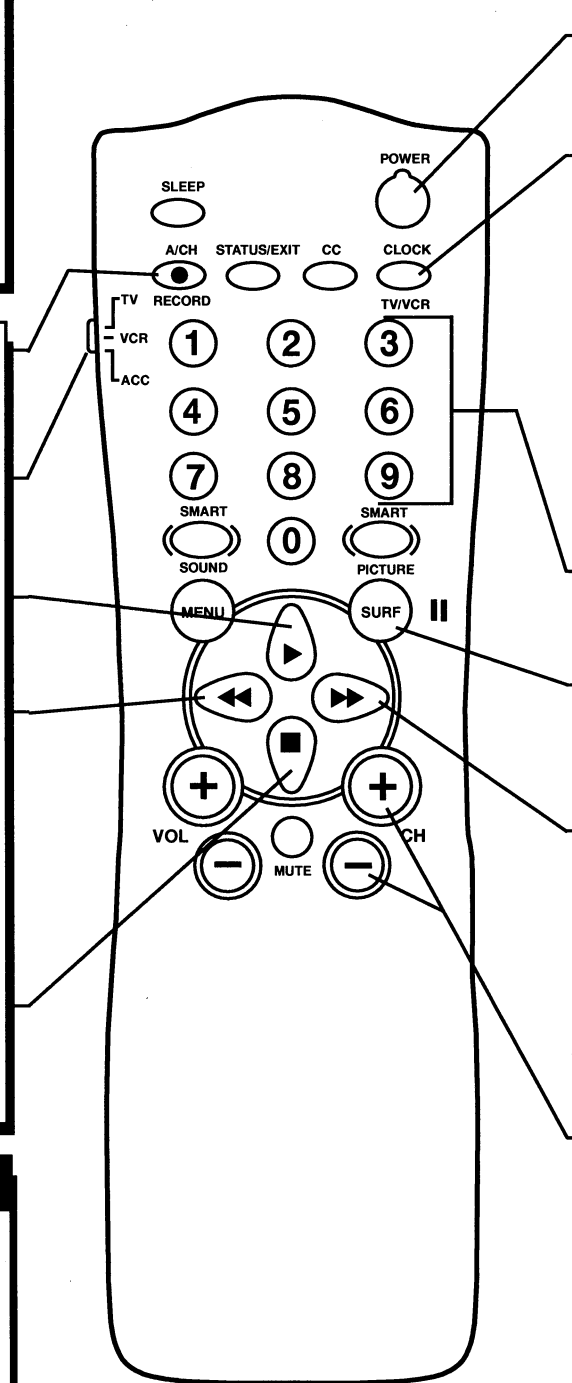

POWER BUTTON

Press to turn the VCR ON and OFF.

TV/VCR BUTTON

Press while in the VCR mode (VCR indicator on the front of the unit will light) to view the playback of a tape. Press again to place in the TV position (VCR indicator light will go off) to view one program while recording another program. When used in the TV mode, the TV/VCR/CLOCK button will access the TV's Clock menu options.

NUMBER BUTTON

Press buttons for direct VCR channel selections.

PAUSE BUTTON

Press to temporarily stop the tape during a playback or recording. Press again to release Pause.

FAST FORWARD BUTTON

Press to rapidly advance the tape. For some VCR's you may need to press the STOP button first, then the FAST FORWARD button. In playback mode hold the button down to view the picture moving rapidly in the forward direction.

CHANNEL + & - BUTTONS

Press to scan up or down through the VCR channel numbers

NOTE: If your VCR requires the pushing of two buttons to start a VCR recording, you will have to press both buttons on the remote also (i.e., RECORD and PLAY).



TIPS IF SOMETHING ISN'T WORKING

Please make these simple checks before calling for service. These tips can save you time and money since charges for TV installation and adjustment of customer controls are not covered under your warranty.

No Power

CAUTION: A video source (such as a video game, Compact Disc Interactive - CDI, or TV information channel) which shows a constant non-moving pattern on the TV screen, can cause picture tube damage. When your TV is continuously used with such a source the pattern of the non-moving portion of the game (CDI, etc.) could leave an image permanently on the picture tube. When not in use, turn the video source OFF. Regularly alternate the use of such video sources with normal TV viewing.

- Check the TV power cord. Unplug the TV, wait 10 seconds, then reinsert plug into outlet and push POWER button again.
- Check that outlet is not on a wall switch. Be sure fuse is not blown on AC Power strip.

No Picture

- Check antenna connections. Are they properly secured to the TV's ANT/CABLE plug?
- Check the TUNER control for CABLE or ANTENNA setting.
- Check Audio/Video Input jack connections if using a VCR or other external device.

No Sound

- Check the VOLUME buttons.
- Check the MUTE button on the remote control.
- Check Audio/Video Input jack connections if using a VCR or other external device.

Remote Does Not Work

- Check batteries. Replace with AA Heavy Duty (Zinc Chloride) or Alkaline batteries if necessary.
- Clean the remote and the remote sensor window on the TV.
- Check the TV power cord. Unplug the TV, wait 10 seconds, then reinsert plug into outlet and push POWER button again. Be sure fuse is not blown on AC Power strip if one is being used.
- Check to be sure TV outlet is not on a wall switch.

TV Displays Wrong Channel or No Channels Above 13

- Repeat channel selection.
- Add desired channel numbers (CHANNEL control) into TV memory.
- Check to be sure the TUNER control is set to the CABLE.

Cleaning and Care

- To avoid possible shock hazard be sure the TV is unplugged from the electrical outlet before cleaning.
- When cleaning the TV screen take care not to scratch or damage the screen surface (avoid wearing jewelry or using anything abrasive). Wipe the front screen with a clean cloth dampened with water. Use even, easy, vertical strokes when cleaning.
- Gently wipe the cabinet surfaces with a clean cloth or sponge dampened in a solution of cool clear water. Use a clean dry cloth to dry the wiped surfaces.
- Never use thinners, insecticide sprays, or other chemicals on or near the cabinet, as they might cause permanent marring of the cabinet finish.



Coaxial Cable • A single solid antenna wire normally matched with a metal plug (F-type) end connector that screws (or pushes) directly onto a 75 Ohm input found on the Television or VCR.

Closed Caption • Broadcast standard which allows you to read the voice content of television programs on the TV screen. Designed to help the hearing impaired this feature uses onscreen "text boxes" to show dialogue and conversations while the TV program is in progress.

Direct Audio/Video Inputs • Located on the rear of the TV these connectors (RCA phono type plug) are used for the input of audio and video signals. Designed for use with VCRs (or other accessories) in order to receive higher picture resolution and offer sound connection options.

Identify • Method by which a remote control searches and finds an operating code for another product (such as a VCR or Cable Converter). Once the code has been "identified" then the TV remote can operate and send commands to the other product.

On Screen Displays (OSD) • Refers to the wording or messages generated by the television (or VCR) to help the user with specific feature controls (color adjustment, programming, etc.).

Menu • An onscreen listing of feature controls shown on the Television screen that are made available for user adjustments.

Multichannel Television Sound (MTS) • The broadcast standard that allows for stereo sound to be transmitted with the TV picture.

Programming • The procedure of adding or deleting channel numbers into the Television's memory circuits. In this way the Television "remembers" only the locally available or desired channel numbers and skips over any unwanted channel numbers.

Remote Sensor Window • A window or opening found on the Television control panel through which infrared remote control command signals are received.

Setup Mode • Automatic feature control settings made by the TV. Designed for first time setup and use. Settings for signal connections (antenna or cable TV), plus channel program memory are held in the TV's memory (even if the set is unplugged and moved to a new location.)

Status • Allows the user to quickly confirm what channel number is currently being viewed. Status can also be used to clear the Television of on screen displays or information (rather than waiting for the displays to "time out" or automatically disappear from the screen).

Twin Lead Wire • The more commonly used name for the two strand 300 Ohm antenna wire used with many indoor and outdoor antenna systems. In many cases this type of antenna wire requires an additional adapter (or balun) in order to connect to the 75 Ohm Input terminals designed into the more recent Televisions and VCRs.

INDEX

Accessories/Optional*(Q/U-1), 22	Remote Control*(Q/U-2), 23-31
Adapter Connector*(Q/U-1)	Requesting Service34-35, 36
Add/Delete Channels(Channel Edit) *(Q/U-4)	RF Coaxial Cable*(Q/U-1)
Alternate Channel25	Safety/Precautions3, 32, 36
Audio/Video Input Jacks22	Sensor Remote*(Q/U-2)
Battery Installation*(Q/U-2)	Set Up/First Time Use*(Q/U-1,2,3,4)
Cable TV Connections/Settings*(Q/U-1,3)	Sleep Timer12
Channel Memory*(Q/U-4)	SmartLock/Understanding the SmartLock Features12
Clock Set Time8	SmartLock Access Code Feature13
Closed Captioning11	SmartLock Block Channel Feature14
Controls/TV*(Q/U-2)	SmartLock Blocking Options15
Controls/Remote*(Q/U-2), 23-31	SmartLock Blocking using the Movie/TV Ratings27-28
External Control*(Q/U-4)	SmartLock Review18
Features4	SmartPicture Control23
Glossary TV Terms33	SmartSound Control/AVL Control24
Input Control22	SmartSurf/Alternate Channel25
Language Option*(Q/U-3)	Start-up Channel Control10
Memory/Program Channels*(Q/U-3)	Start-up Time Control10
Menu Button*(Q/U-2)	Status Button*(Q/U-2)
Minus(-)/Plus (+) Buttons*(Q/U-2)	Timer Control9
Picture Controls5	Tips for Service32, 34-35, 36
Picture Noise Reduction7	VCR/TV Connections*(Q/U-1), 22
Precautions/Safety3, 32, 36	Volume Bar Control20
Programming Channels*(Q/U-4)	Warranty36

* Information contained in Quick-Use (Q/U) Guide-page listed.

Philips Consumer Electronics Company Factory Service Center Locations

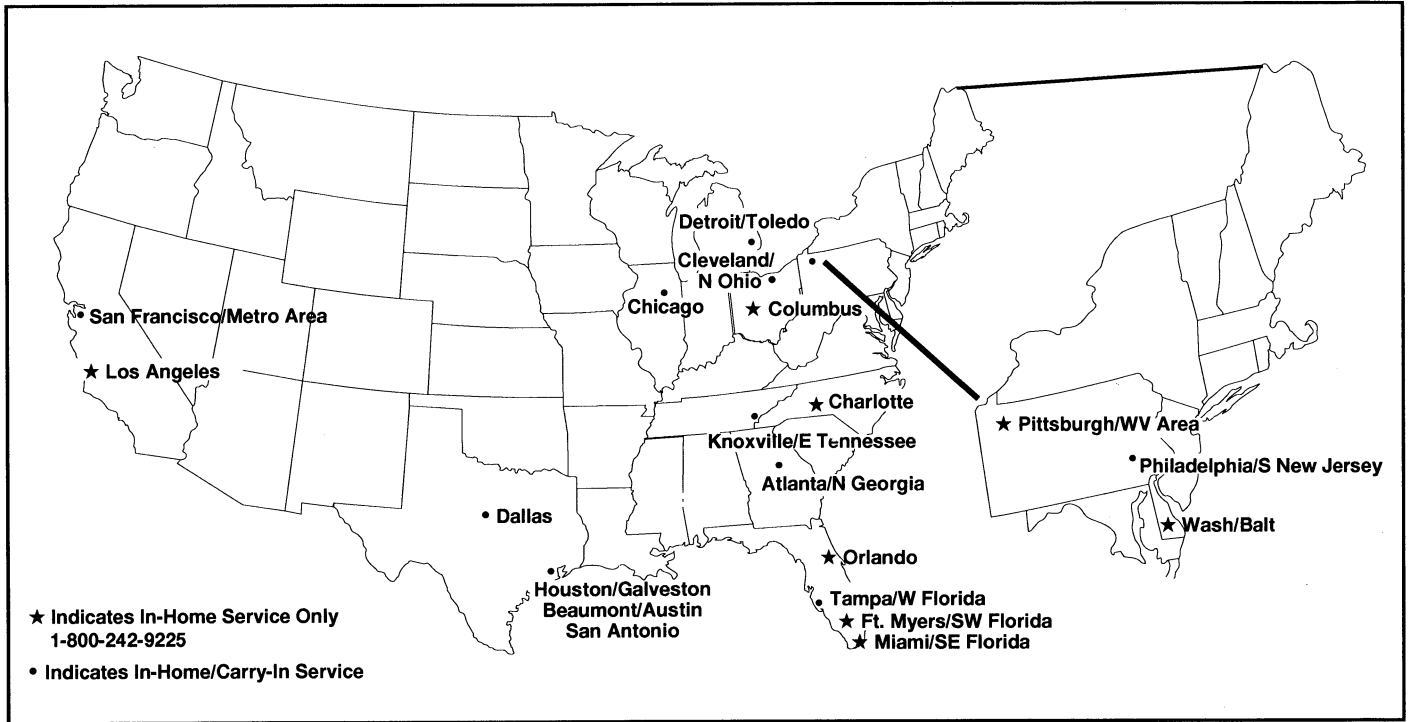

NOTE: If you reside in one of our Philips Factory Service Branch areas (see directory on back), you can contact the nearest Service Branch to obtain efficient and expedient repair for your product. If your product is In-Warranty, you should have proof-of-purchase to ensure No Charge Service. For Out-of-Warranty service, call the location nearest you.

NOTA: Si vous résidez dans une des régions desservies par une succursale de service après vente du fabricant Philips (voir liste ci-dessous), vous pourrez contacter la branche de service après vente la plus près de chez vous pour obtenir un service après vente rapide et efficace. Si le produit est sous garantie, il suffira de présenter une preuve d'achat pour bénéficier d'un service sans frais. Pour les produits non couverts par la garantie, contactez le centre le plus près de chez vous.

NOTA: Si Ud. reside en una de nuestras zonas para sucursales Philips de servicio al de fábrica (ver directorio más abajo), Ud. puede comunicarse con la sucursal de servicio más cercana para obtener una reparación oportuna y eficaz de su producto. Si su producto está todavía bajo garantía, Ud. debe presentar comprobante de compra para no ocasionar ningunos cargos por servicio. Para servicio después del vencimiento de la garantía, llame al lugar más cercano de los abajo indicados.

In Canada

How you can obtain efficient and expedient carry-in, mail-in, or in-home service for your product
Please contact Philips at
1-800-661-6162 (French speaking)
1-800-363-7278 (English speaking)

Au Canada

Comment obtenir le service après-vente pour les produits apportés ou envoyés par la poste à notre centre de service ou le service à domicile
Veuillez contacter philips á:
1-800-661-6162 (Francophone)
1-800-363-7278

En el Canadá

Cómo recibir servicio eficiente para su producto, en persona, por correo o a domicilio
Favor de comunicarse con Philips al:
1-800-661-6162 (francófono)
1-800-363-7278 (anglófono)

QUALITY SERVICE IS AS CLOSE AS YOUR TELEPHONE! SIMPLY LOOK OVER THE LIST BELOW FOR THE NUMBER OF A FACTORY SERVICE CENTER NEAR YOU. YOUR PRODUCT WILL RECEIVE EFFICIENT AND EXPEDIENT CARRY-IN, MAIL-IN, OR IN-HOME SERVICE, AND YOU WILL RECEIVE PEACE OF MIND, KNOWING YOUR PRODUCT IS BEING GIVEN THE EXPERT ATTENTION OF PHILIPS' FACTORY SERVICE. AND, IF THE PHONE NUMBER LISTED FOR YOUR AREA IS LONG DISTANCE, CALL 1-800-242-9225 FOR FACTORY SERVICE.

COMMENT OBTENIR NOTRE SERVICE APRÈS VENTE RAPIDE ET EFFICACE SOIT PAR COURRIER, À DOMICILE, OU EN SE PRÉSENTANT À UN CENTRE DE SERVICE PHILIPS. PLUS DE 600 CENTRES DE RÉCEPTION DE PRODUITS À RÉPARER À TRAVERS LE PAYS: CONTACTER LE CENTRE DE SERVICE AUX CONSOMMATEURS LE PLUS PROCHE POUR SAVOIR L'EMPLACEMENT DE CES DÉPÔTS DANS UN RAYON DE 50 À 75 MILES (80 KM À 120 KM) DU CENTRE DE SERVICE LOCAL.

CÓMO OBTENER UN SERVICIO OPORTUNO Y EFICIENTE POR CORREO, EN CASA O EN PERSONA PARA SU PRODUCTO A TRAVÉS DE UN CENTRO PHILIPS DE SERVICIO. MAS DE 600 SITIOS POR TODO EL PAIS PARA LA RECEPCION DE PRODUCTOS NECESITADOS DE REPARACIONES: COMUNICARSE CON EL CENTRO DE SERVICIO DE FABRICA MAS CERCANO PARA ESTOS LUGARES DENTRO DE UN RADIO DE 80 A 120 KM (50 A 75 MILLAS) DEL CENTRO DE SERVICIO LOCAL.

GEORGIA

Philips Factory Service of Georgia
200 N. Cobb Pkwy., Suite 120
Marietta, GA 30062
(770) 795-0085

FLORIDA

Philips Factory Service of Florida
1911 US Highway 301 North
Tampa, FL 33619
(813) 621-8181

WESTERN U.S.A.

Philips Factory Service Western Region
681 East Brokaw Rd.
San Jose, CA 95112
(408) 436-8566

TEXAS

Philips Factory Service of Texas
1110 N. Post Oak Rd., Suite 100
Houston, TX 77055
(713) 682-3990

CENTRAL U.S.A.

Philips Factory Service Central US
950 Keynote Circle
Brooklyn Heights, OH 44131
(216) 741-3334

MICHIGAN

Philips Factory Service of Michigan
25173 Dequindre
Madison Heights, MI 48071
(248) 544-2110

DALLAS AREA

Philips Factory Service of Dallas
415 N. Main Street, #107
Euless, TX 76040
(713) 682-3990

ILLINOIS

Philips Factory Service of Illinois
1279 W. Hamilton Pkwy.
Itasca, IL 60143
(630) 775-0990

TENNESSEE

Philips Factory Service of East Tennessee
6700 D Papermill Rd.
Knoxville, TN 37919
(423) 584-6614

MID-ATLANTIC

Philips Factory Service Mid-Atlantic
352 Dunks Ferry Rd.
Bensalem, PA 19020
(215) 638-7500

LIMITED WARRANTY

COLOR TELEVISION

90 Days Free Labor

One Year Free Replacement of Parts (Two Years Free Replacement on Color Picture Tube)

This product can be repaired in-home.

WHO IS COVERED?

You must have proof of purchase to receive warranty service. A sales receipt or other document showing that you purchased the product is considered proof of purchase.

WHAT IS COVERED?

Warranty coverage begins the day you buy your product. For 90 days thereafter, all parts will be repaired or replaced free, and labor is free. From 90 days to one year from the day of purchase, all parts will be repaired or replaced free, but you pay for all labor charges. From one to two years from the day of purchase, you pay for the replacement or repair of all parts except the picture tube, and for all labor charges. After two years from the day of purchase, you pay for the replacement or repair of all parts, and for all labor charges.

All parts, including repaired and replaced parts, are covered only for the original warranty period. When the warranty on the product expires, the warranty on all replaced and repaired parts also expires.

WHAT IS EXCLUDED?

Your warranty does not cover:

- labor charges for installation or setup of the product, adjustment of customer controls on the product, and installation or repair of antenna systems outside of the product.
- product repair and/or part replacement because of misuse, accident, unauthorized repair or other cause not within the control of Philips Consumer Electronics Company.
- reception problems caused by signal conditions or cable or antenna systems outside the unit.
- a product that requires modification or adaptation to enable it to operate in any country other than the country for which it was designed, manufactured, approved and/or authorized, or repair of products damaged by these modifications.
- incidental or consequential damages resulting from the product. (Some states do not allow the exclusion of incidental or consequential damages, so the above exclusion may not apply to you. This includes, but is not limited to, prerecorded material, whether copyrighted or not copyrighted.)
- a product used for commercial or institutional purposes.

WHERE IS SERVICE AVAILABLE?

Warranty service is available in all countries where the product is officially distributed by Philips Consumer Electronics Company. In countries where Philips Consumer Electronics Company does not distribute the product, the local Philips service organization will attempt to provide service (although there may be a delay if the appropriate spare parts and technical manual(s) are not readily available).

MAKE SURE YOU KEEP...

Please keep your sales receipt or other document showing proof of purchase. Attach it to this owner's manual and keep both nearby. Also keep the original box and packing material in case you need to return your product.

BEFORE REQUESTING SERVICE...

Please check your owner's manual before requesting service. Adjustments of the controls discussed there may save you a service call.

TO GET WARRANTY SERVICE IN U.S.A., PUERTO RICO OR U.S. VIRGIN ISLANDS...

Contact a Philips factory service center (see enclosed list) or authorized service center to arrange repair.

(In U.S.A., Puerto Rico and U.S. Virgin Islands, all implied warranties, including implied warranties of merchantability and fitness for a particular purpose, are limited in duration to the duration of this express warranty. But, because some states do not allow limitations on how long an implied warranty may last, this limitation may not apply to you.)

TO GET WARRANTY SERVICE IN CANADA...

Please contact Philips at:

1-800-661-6162 (French Speaking)

1-800-363-7278 (English Speaking)

(In Canada, this warranty is given in lieu of all other warranties. No other warranties are expressed or implied, including any implied warranties of merchantability or fitness for a particular purpose. Philips is not liable under any circumstances for any direct, indirect, special, incidental or consequential damages, howsoever incurred, even if notified of the possibility of such damages.)

REMEMBER...

Please record the model and serial numbers found on the product below. Also, please fill out and mail your warranty registration card promptly. It will be easier for us to notify you if necessary.

MODEL # _____

SERIAL # _____



This warranty gives you specific legal rights. You may have other rights which vary from state/province to state/province.

Philips Service Company, P.O. Box 2976, Longview, Texas 75606, (903) 242-4800

Free Manuals Download Website

<http://myh66.com>

<http://usermanuals.us>

<http://www.somanuals.com>

<http://www.4manuals.cc>

<http://www.manual-lib.com>

<http://www.404manual.com>

<http://www.luxmanual.com>

<http://aubethermostatmanual.com>

Golf course search by state

<http://golfingnear.com>

Email search by domain

<http://emailbydomain.com>

Auto manuals search

<http://auto.somanuals.com>

TV manuals search

<http://tv.somanuals.com>