

Digital Surround Sound Receiver

FR-963 · FR-985 · FR-986
FR-994 · FR-995 · FR-996



Read this manual first!

Congratulations on purchasing this Philips product. We've included everything you need to get started. If you have any problems, Philips Representatives can help you get the most from your new product by explaining:

- Hookups,
- First Time Setup, and
- Feature Operation.

Do not attempt to return this product to the store.

For fast help, call us first!

1-800-531-0039

Thank you for making Philips a part of your home!



Let's make things better.



PHILIPS

Return your Warranty Registration card today to ensure you receive all the benefits you're entitled to.

• Once your Philips purchase is registered, you're eligible to receive all the privileges of owning a Philips product.

• So complete and return the Warranty Registration Card enclosed with your purchase at once, and take advantage of these important benefits.

Warranty Verification

Registering your product within 10 days confirms your right to maximum protection under the terms and conditions of your Philips warranty.

Owner Confirmation

Your completed Warranty Registration Card serves as verification of ownership in the event of product theft or loss.

Model Registration

Returning your Warranty Registration Card right away guarantees you'll receive all the information and special offers which you qualify for as the owner of your model.

PHILIPS

Congratulations on your purchase, and welcome to the "family!"

Dear Philips product owner:

Thank you for your confidence in Philips. You've selected one of the best-built, best-backed products available today. And we'll do everything in our power to keep you happy with your purchase for many years to come.

As a member of the Philips "family," you're entitled to protection by one of the most comprehensive warranties and outstanding service networks in the industry.

What's more, your purchase guarantees you'll receive all the information and special offers for which you qualify, plus easy access to accessories from our convenient home shopping network.

And most importantly you can count on our uncompromising commitment to your total satisfaction.

All of this is our way of saying welcome – and thanks for investing in a Philips product.

Sincerely,



Lawrence J. Blanford
President and Chief Executive Officer

P.S. Remember, to get the most from your Philips product, you must return your Warranty Registration Card within 10 days. So please mail it to us right now!



Know these safety symbols

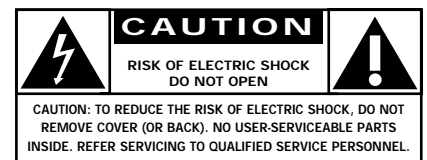

t This "bolt of lightning" indicates uninsulated material within your unit may cause an electrical shock. For the safety of everyone in your household, please do not remove product covering.

S The "exclamation point" calls attention to features for which you should read the enclosed literature closely to prevent operating and maintenance problems.

WARNING: TO PREVENT FIRE OR SHOCK HAZARD, DO NOT EXPOSE THIS EQUIPMENT TO RAIN OR MOISTURE.

CAUTION: To prevent electric shock, match wide blade of plug to wide slot, and fully insert.

For Customer Use

Enter below the Serial No. which is located on the rear of the cabinet. Retain this information for future reference.

Model No. _____

Serial No. _____



English2

English

Français.....28

Français

Español53

Español

Canada

English: This digital apparatus does not exceed the Class B limits for radio noise emissions from digital apparatus as set out in the Radio Interference Regulations of the Canadian Department of Communications.

Français : Cet appareil numérique n'émet pas de bruits radioélectriques dépassant les limites applicables aux appareils numériques de Classe B prescrites dans le Règlement sur le Brouillage Radioélectrique édicté par le Ministère des Communications du Canada.

IMPORTANT SAFETY INSTRUCTIONS

1. Read these instructions.
2. Keep these instructions.
3. Heed all warnings.
4. Follow all instructions.
5. Do not use this apparatus near water.
6. Clean only with dry cloth.
7. Do not block any ventilation openings. Install in accordance with the manufacturer's instructions.
8. Do not install near any heat sources such as radiators, heat registers, stoves, or other apparatus (including amplifiers) that produce heat.
9. Do not defeat the safety purpose of the polarized or grounding-type plug. A polarized plug has two blades with one wider than the other. A grounding type plug has two blades and a third grounding prong. The wide blade or the third prong are provided for your safety. If the provided plug does not fit into your outlet, consult an electrician for replacement of the obsolete outlet.
10. Protect the power cord from being walked on or pinched, particularly at plugs, convenience receptacles, and the point where they exit from the apparatus.

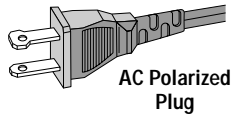

11. Only use attachments/accessories specified by the manufacturer.
12.  Use only with the cart, stand, tripod, bracket, or table specified by the manufacturer or sold with the apparatus. When a cart is used, use caution when moving the cart/apparatus combination to avoid injury from tip-over.
13. Unplug this apparatus during lightning storms or when unused for long periods of time.
14. Refer all servicing to qualified service personnel. Servicing is required when the apparatus has been damaged in any way, such as power-supply cord or plug is damaged, liquid has been spilled or objects have fallen into the apparatus, the apparatus has been exposed to rain or moisture, does not operate normally, or has been dropped.
15. **Battery usage CAUTION** – To prevent battery leakage which may result in bodily injury or damage to the unit:
 - Install **all** batteries correctly, + and - as marked on the unit.
 - Do not mix batteries (**old** and **new** or **carbon** and **alkaline**, etc.).
 - Remove batteries when the unit is not used for a long time.

EL 6475-E003: 01/6

Class II equipment symbol



This symbol indicates that the unit has a double insulation system.

Safety instructions	
Safety instructions	2 & 4
General information	
Scope of supply	5
Setup	5
Environmental information.....	5
Trademark acknowledgement.....	5
Controls	6
Remote control	
Remote control use	7
Remote control buttons	8
Programming the universal remote control (FR 985, FR 986, FR 995, FR 996 only)	9
Connectors	10
Connections	
Analog audio connections	11
Digital audio connections	11
System control bus, CINEMA LINK	12
Video connections.....	12
Power	13
Speaker connections.....	13
TV as the center speaker	13
Antenna connections	13
System setup	
Positioning the speakers.....	14
Speaker setup and testing.....	14
Power handling	14
Headphones	14
Maintenance	14
Receiver adjustment	15
Display	16
Menus	
Receiver menu	17-18
TV menu	18
Activating CINEMA LINK	18
Source selection	
SOURCE SELECT.....	19
6 CHANNEL-DVD/SACD INPUT selection	19
Reassigning a source selection	19
Using one source selection for two or more appliances	19
About 6 CHANNEL-DVD/SACD INPUT	19
Playback, recording	
Playing a source.....	20
Adjusting the sound.....	20
Recording from a source.....	20
Recording from the digital output	20
Surround sound	
About surround sound.....	21
Switching surround sound	21
Surround sound settings.....	22
Tuner	
Tuning to radio stations	23
Switching FM sensitivity	23
Storing radio stations	23
Tuning to stored radio stations.....	24
Resorting stored radio stations	24
Naming radio stations	24
Clearing station names.....	24
Technical data	
Receiver	25
Troubleshooting	
Warning.....	26
Troubleshooting.....	26
Limited warranty	
Limited warranty.....	27

Scope of supply

This receiver is supplied including:

- a remote control
- 2 batteries for the remote control, size AA
- a coaxial cable for audio connection with a DVD player
- a coaxial cable for the CINEMA LINK connection
(FR 985, FR 956, FR 995, FR 996 only)
- a loop antenna
- a wire antenna
- this instruction booklet

Setup

If you have stacked the components of your system, the receiver must be on top. Place the receiver on a flat, hard, stable surface. Do not cover any vents and leave 50 cm (20 inches) above and 10 cm (4 inches) to the left and right of the receiver clear for ventilation.

For good reception the loop antenna should not be placed on top of or beneath VCRs, CD recorders, DVD players, TVs and other radiation sources.

Environmental information

All redundant packing material has been omitted. We have tried to make the packaging easy to separate into three single materials: cardboard (box), polystyrene foam (buffer) and polyethylene (bags, protective foam sheet).

Your set consists of materials which can be recycled if disassembled by a specialized company. Please observe the local regulations regarding the disposal of packing materials, dead batteries and old equipment.

As an ENERGY STAR® partner, Philips has determined that this product meets the ENERGY STAR® guidelines for energy efficiency.



Trademark acknowledgement

Manufactured under license from Dolby Laboratories. "DOLBY", "DOLBY DIGITAL", "PRO LOGIC" and the double-D symbol **DD** are trademarks of Dolby Laboratories. Confidential unpublished works. © 1992-1997 Dolby Laboratories. All rights reserved.

"DTS" and "DTS Digital Surround" are trademarks of Digital Theater Systems, Inc. Copyright 1996 Theater Systems, Inc. All Rights Reserved.

CONTROLS

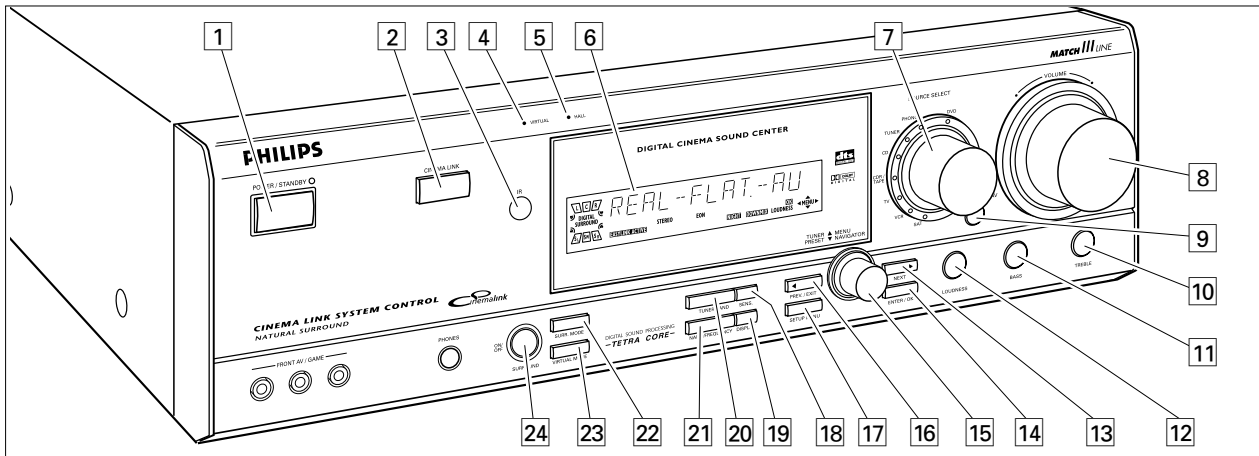

- 1 POWER / STANDBY** Switches the receiver on and off.
- 2 CINEMA LINK** Switches on and off the system control bus between the receiver and the TV.
- 3** Sensor for the infrared remote control.
- 4 3D SURROUND** Control light for virtual 3D surround (FR 963, FR 985, FR 986 only).
- VIRTUAL** Control light for virtual surround (FR 994, FR 995, FR 996 only).
- 5 HALL** Control light for HALL.
- 6** Display
- 7 SOURCE SELECT** Selects the different audio and video connectors. Reactivates the receiver from standby.
- 8 VOLUME** Increases and decreases the volume level.
- 9 FRONT AV** Selects the FRONT AV / GAME input (FR 995, FR 996 only).
- 10 TREBLE** Adjusts the treble when used in combination with VOLUME.
- 11 BASS** Adjusts the bass when used in combination with VOLUME.
- 12 LOUDNESS** Switches LOUDNESS on and off.
- 13 NEXT ▶** TUNER: searches radio stations. MENU: switches to the next menu level.
- 14 ENTER / OK** Confirms selected menu values.
- 15 TUNER PRESET ◄ MENU NAVIGATOR**
TUNER: switches to the next and previous stored radio station. MENU: moves upwards and downwards.
- 16 ◀ PREV. / EXIT**
TUNER: searches radio stations. MENU: switches to the previous menu level.
- 17 SETUP MENU** Switches the menu on and off.
- 18 SENS.** Switches between low and high tuner sensitivity.
- 19 DISPLAY** Switches the brightness of the display.
- 20 TUNER BAND** Switches the wavebands of the tuner.
- 21 NAME/FREQUENCY** Switches between name and frequency display.
- 22 SURR. MODE** Switches through the different speaker configurations.
- 23 3D SURROUND** Switches virtual 3D surround on and off (FR 963, FR 985, FR 986 only).
- VIRTUAL MODE** Scrolls through the different virtual surround sound modes (FR 994, FR 995, FR 996 only).
- 24 SURROUND ON/OFF** Switches between the last selected surround mode and stereo.

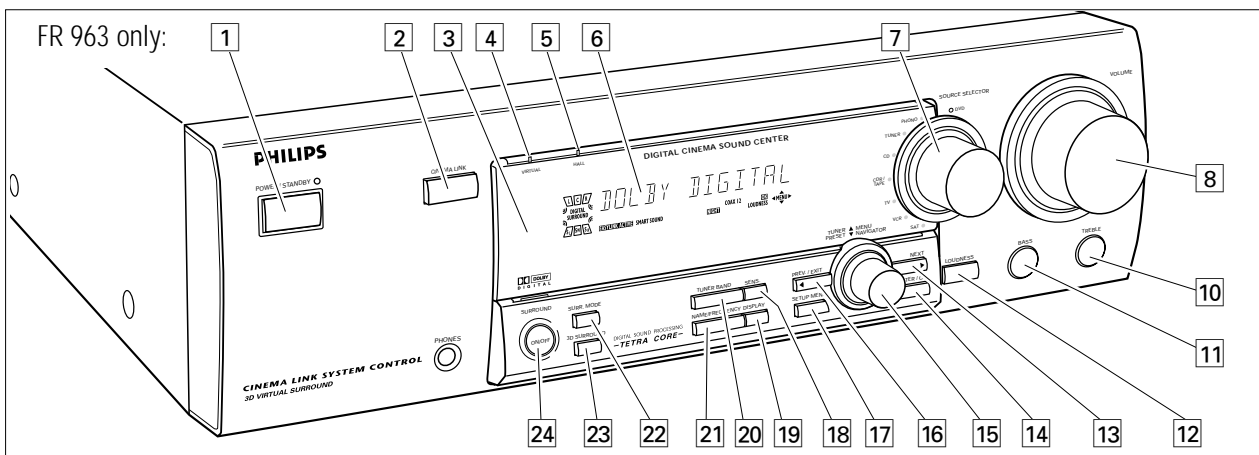

REMOTE CONTROL

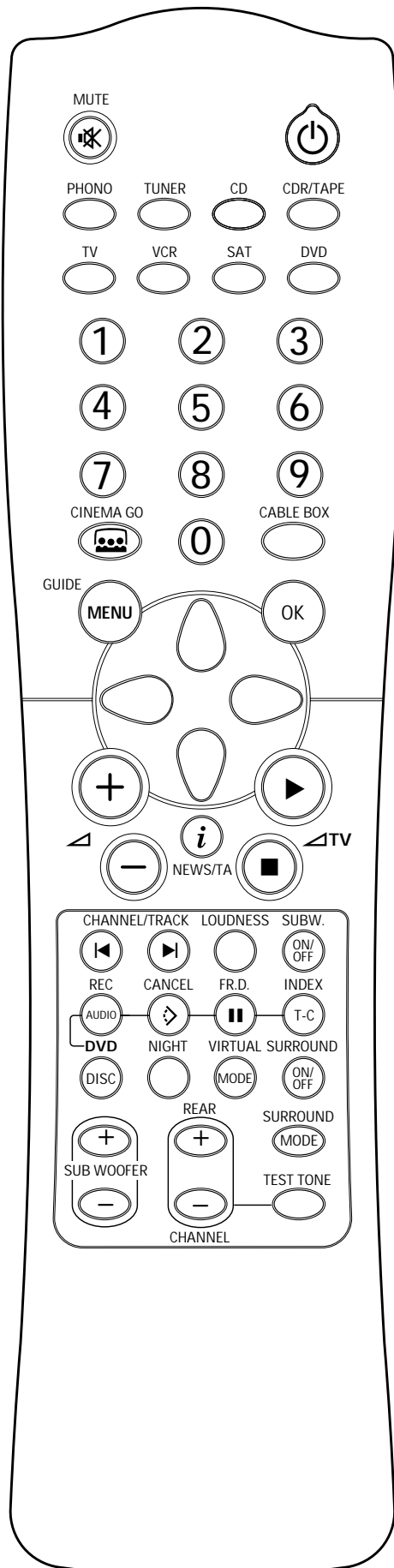

FR 994, FR 995, FR 996

Remote control use

Open the battery compartment of the remote control and insert 2 alkaline batteries, type **AA** (R06, UM-3).

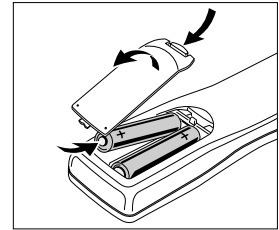

Remove batteries if they are dead or if the remote control will not be used for a long time.

Batteries contain chemical substances, so they should be disposed of properly.

The buttons on the remote control work the same way as the corresponding ones on the receiver.

Important!

You have to press a source button for longer than 1 second to switch the sound source on the receiver. Pressing a source button for less than 1 second will only switch the remote control to use the commands for the selected product.



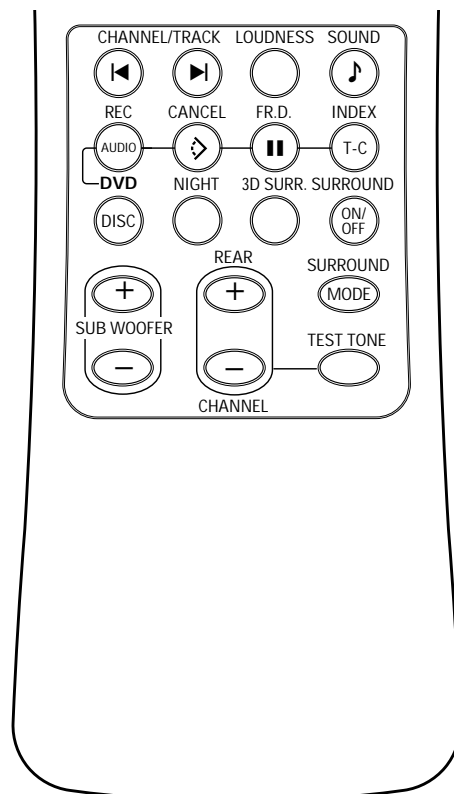









The remote control remains tuned to the selected source until another source button on the remote control is pressed. This enables you to operate additional sources (i. e. winding a tape) without changing the source on the receiver.



FR 963, FR 985, FR 986

REMOTE CONTROL

Remote control buttons

-  MUTEMutes the sound of the receiver in all modes, except TV.
Mutes the sound of your Philips TV set if your remote control is in TV mode.
- Switches the source selected on your remote control (e.g. VCR, TV) to standby. When pressed longer than 2 seconds, the receiver switches to standby.
- PHONO, TUNER, CD, CDR/TAPE, TV, VCR, SAT, DVD.....Switches the remote control to the commands of the different products. Selects the sources if pressed longer than 1 second. SAT only works with *digital* satellite receivers. Reactivates the receiver from standby.
- 1-0.....Keys in numbers for tracks, stations or frequencies. Numbers consisting of two figures must be keyed in within 2 seconds.
-  CINEMA GOActivates CINEMA LINK on the TV.
- CABLE BOX(USA only) Switches the remote control to the cable box codes.
- MENU GUIDE**TUNER: Switches the receiver menu on and off.
DVD, TV: Switches the DVD/TV menu on and off.
- OKConfirms menu options.
- Arrow buttonsTUNER: Moves in the menus. Right/left arrows are tuning up/down. CD, CDR: Left/right arrows are searching backwards/forwards, up/down arrows are selecting the next/previous track.
- + Increases the receiver volume.
- Decreases the receiver volume.
-  NEWS/TA.....TUNER: Without function.
TV: Switches teletext on and off.
SAT: Switches the information text on and off.
-  **TV**Increases the TV volume.
CD, CDR, VCR, DVD: Starts playback.
-  **TV**Decreases the TV volume.
CD, CDR, VCR, DVD: Stops playback.
-  CHANNEL/TRACK ...Selects the previous preset tuner station.
VCR: Rewinds the tape.
CD, CDR, DVD: Selects the previous track.
TV: Selects the previous channel.
-  CHANNEL/TRACK ...Selects the next preset tuner station.
VCR: Fast forwards the tape.
CD, CDR, DVD: Selects the next track.
TV: Selects the next channel.
- LOUDNESSSwitches LOUDNESS on and off.
-  SOUNDScrolls through the different smart sounds (FR 963, FR 985, FR 986 only).
- SUBW. ON/OFFSwitches the subwoofer on and off (FR 994, FR 995, FR 996 only).
- REC, DVD AUDIO.....CDR, VCR: Starts recording.
DVD: Switches audio tracks.
- CANCEL, DVD CD, CDR, SAT, VCR: Clears a program, cancels selections.
DVD: Switches the view angle.
- FR.D., DVD TUNER: Switches to FREQUENCY DIRECT.
CD, CDR, VCR, DVD: Pauses playback.
- INDEX, DVD T-C.....VCR: Switches the index search on and off.
SAT: Switches the themes on and off.
DVD: Switches between title and chapter.
- DISC.....CD-, CDR-, DVD-Changers: Switches to the next disc.
- NIGHTSwitches NIGHT MODE on and off.
- 3D SURR.Switches virtual 3D surround on and off (FR 963, FR 985, FR 986 only).
- VIRTUAL MODEScrolls through the different virtual surround sound modes (FR 994, FR 995, FR 996 only).
- SURROUND ON/OFFSwitches SURROUND SOUND on and off.
- + / - SUBWOOFER...Increases/decreases the subwoofer volume.
- + / - REARIncreases/decreases the volume of the rear speakers. While test tone is on, the volume of the speakers you are hearing can be increased/decreased with these buttons.
- SURROUND MODE.....Scrolls through the different surround modes.
- TEST TONESwitches the test tone on and off. While test tone is on, the volume of the speakers you are hearing can be increased/decreased with + / - REAR.

Programming the universal remote control (FR 985, FR 986, FR 995, FR 996 only)

You can identify the universal remote control by the inscription **Multibrand/Universal**.

The universal remote control must be programmed to use the codes for your appliances of different brands. This is done by keying in a 4-digit code or by scanning the codes until the correct one is found. We recommend to using the 4-digit code. This method is faster and more reliable. The code scanning method should be used only if you cannot find the code for one of your appliances. The codes are listed at the end of this book.

Important!



Use the remote control buttons for programming, not the buttons of the receiver or other appliances.

Programming with the 4-digit code

- 1 Keep the source button for the appliance which should be controlled and  pressed for 3 seconds.
- 2 Key in the 4-digit code for the appliance (codetable at the end of the booklet).

*Notes: – If more than 4 digits are entered, the remote control will recognize only the ones keyed in first.
– If you do not key in a code within 30 seconds the remote control will switch off the programming function without changing the code.
– To program a new appliance, simply overwrite the old code by entering a new one.*

Scanning the codetable

- 1 Switch on the appliance which should be controlled.
 - 2 Keep the source button for the appliance which should be controlled and  pressed for 3 seconds.
 - 3 Press and release  again.
 - The remote control sends the codes for channel up or standby (depending on the selected source) for one brand after the other.
 - 4 As soon as the appliance reacts – switches to the next channel or to standby – press  to confirm the code.
 - The identified code will be used.
- If the set does not react within 2 minutes, the code for this appliance is not stored in the remote control. The code of the remote control will remain unchanged.

Note: When taking out the batteries of the remote control for more than 1 minute the codes must be reprogrammed.

Once you have found and tested the codes for your various appliances, you may want to write them down here.

PHONO
TUNER.....
CD
CDR/TAPE
TV
VCR
SAT
DVD
CABLE BOX

Resetting the remote control

- 1 Keep one of the source buttons and  pressed for 3 seconds.
- 2 Key in the 3-digit code 981.
 - The remote control is now reset to all its original Philips codes.

CONNECTORS

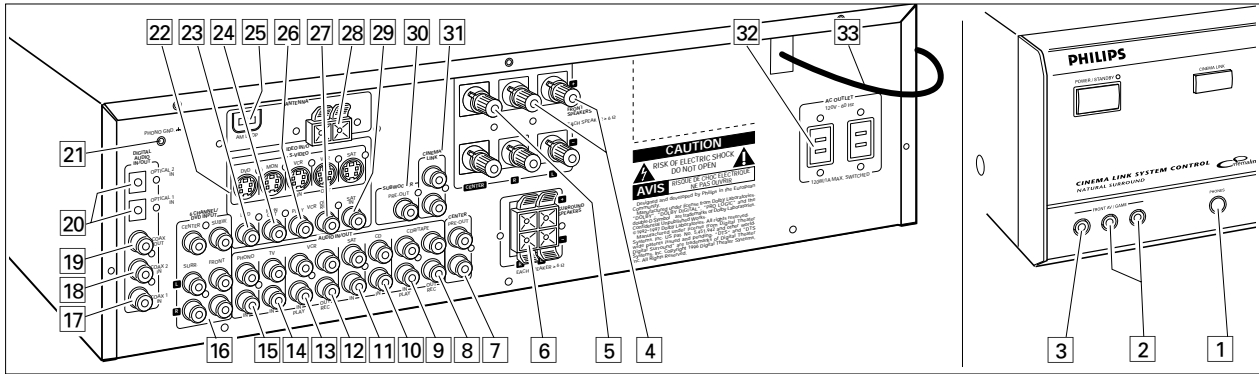

Connectors	Connectors name	Connect to:
6.3 mm headphone jack at the front.	1 PHONES	A headphone with a 6.3 mm plug.
Audio and video inputs at the front (FR 995, FR 996 only).	2 FRONT AV / GAME	Left and right audio out jacks of appliances such as video cameras and game consoles.
FRONT SPEAKERS	3 FRONT AV / GAME	Video out jacks of appliances such as video cameras and game consoles.
SURROUND SPEAKERS	4 R, L	Right and left front speaker.
	5 CENTER	Center speaker.
AUDIO IN/OUT	6 R, L	Right and left surround speaker.
	8 CDR/TAPE OUT	Input of a CD recorder or a tape deck.
	9 CDR/TAPE IN	Output of a CD recorder or a tape deck.
	10 CD IN	Output of a CD player.
	11 SAT IN	Output of a satellite system.
	12 VCR OUT	Input of a video recorder.
	13 VCR IN	Output of a video recorder.
	14 TV IN	Output of a TV.
	15 PHONO IN	Output of a turntable with MM coil.
	21 PHONO GND 	Ground cable of a turntable.
6 CHANNEL / DVD INPUT	16 6 CHANNEL / DVD INPUT	6 channel output of appliances such as DVD or laserdisc players.
DIGITAL AUDIO IN/OUT	17 COAX 1 IN	Coaxial output of digital appliances (default input for source DVD). (FR 994, FR 995, FR 996 only)
	17 COAX OUT	Coaxial input of digital appliances such as CD recorders or MD recorders (FR 963, FR 985, FR 986 only).
	18 COAX 2 IN	Coaxial output of digital appliances.
	19 COAX OUT	Coaxial input of digital appliances such as CD recorders or MD recorders (FR 994, FR 995, FR 996 only).
	19 COAX 1 IN	Coaxial output of digital appliances (FR 963, FR 985, FR 986 only).
	20 OPTICAL IN	Optical output of digital appliances such as DVD players, CD players, CD recorders or MD players (FR 963, FR 985, FR 986, FR 994 only).
VIDEO IN/OUT	20 OPTICAL 1 (2) IN	Optical output of digital appliances such as DVD players, CD players, CD recorders or MD players (FR 995, FR 996 only).
	22 S-VIDEO	S-Video inputs/outputs of video appliances for better video quality (FR 994, FR 995, FR 996 only).
	23 DVD IN	Output of a DVD player.
	24 MON OUT	Input of a monitor (e. g. the TV).
	26 VCR IN	Output of a video recorder.
	27 VCR OUT	Input of a video recorder (for recording).
Antenna connectors	29 SAT IN	Output of a satellite system.
	25 AM LOOP	Frame antenna supplied.
Preamplified outputs	28 FM 300 Ω	Wire antenna supplied or exterior antenna.
	7 CENTER PRE-OUT	Input of a TV when it is used as the center speaker (only possible when the CINEMA LINK system bus is connected).
System control bus	30 SUBWOOFER PRE-OUT	Input of a powered subwoofer.
	31 CINEMA LINK	System control bus jacks of a Philips TV with CINEMA LINK.
Power outlets (not on all versions)	32 AC OUTLET	Supplies same voltage as mains. Up to 120 W/1A total permitted load.
Power cord	33	After all other connections have been made , connect the power cord to the wall outlet.

Analog audio connections

There are analog and digital connectors available on some appliances. If possible use the digital connection; usually this will result in better sound quality. See "Reassigning a source selection" on how to use the digital connectors of the receiver.

Because of a different kind of output signal, the use of Dolby Digital Laserdisc requires an optional AC-3 RF demodulator.

DTS Digital Surround™ is a discrete 5.1-channel digital audio format available on CD, LD, and DVD software which

consequently cannot be decoded and played back inside most CD, LD, or DVD players. For this reason, when DTS-encoded software is played back through the analog outputs of the CD, LD, or DVD player, excessive noise will be exhibited. To avoid possible damage to the audio system, proper precautions should be taken by the customer if the analog outputs are connected directly to the receiver.

To enjoy DTS Digital Surround™ playback, a DTS-compatible player has to be connected to one of the digital inputs of the receiver.

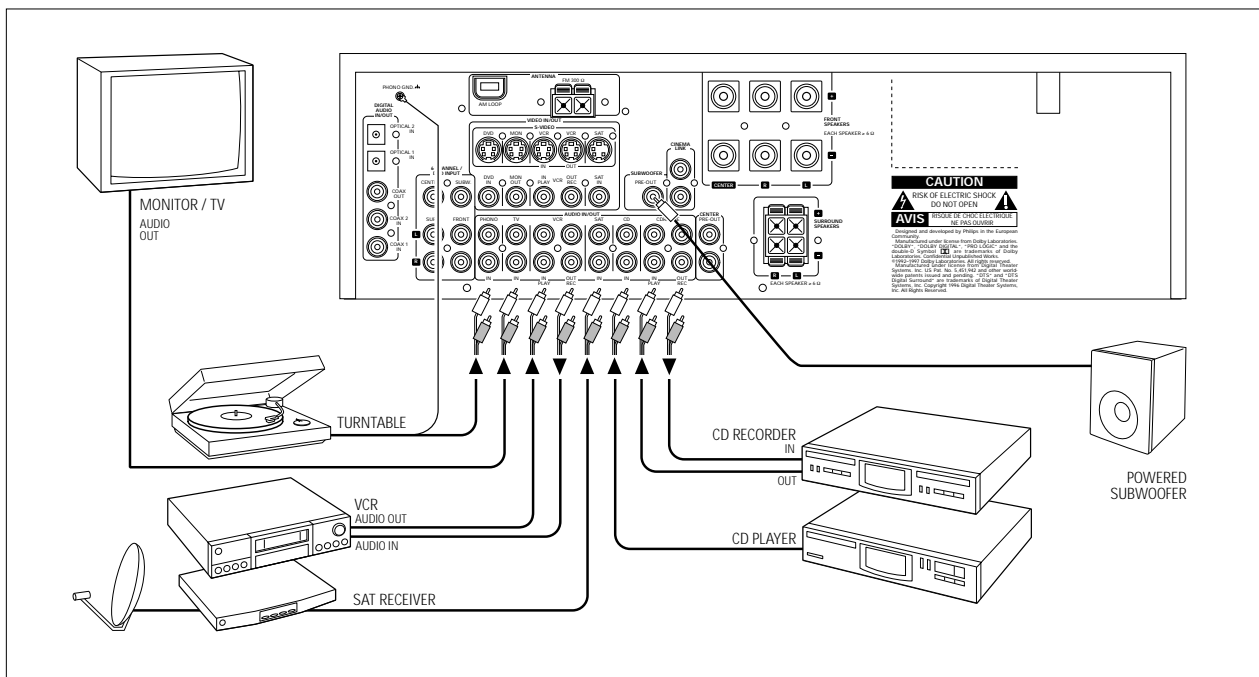

Digital audio connections

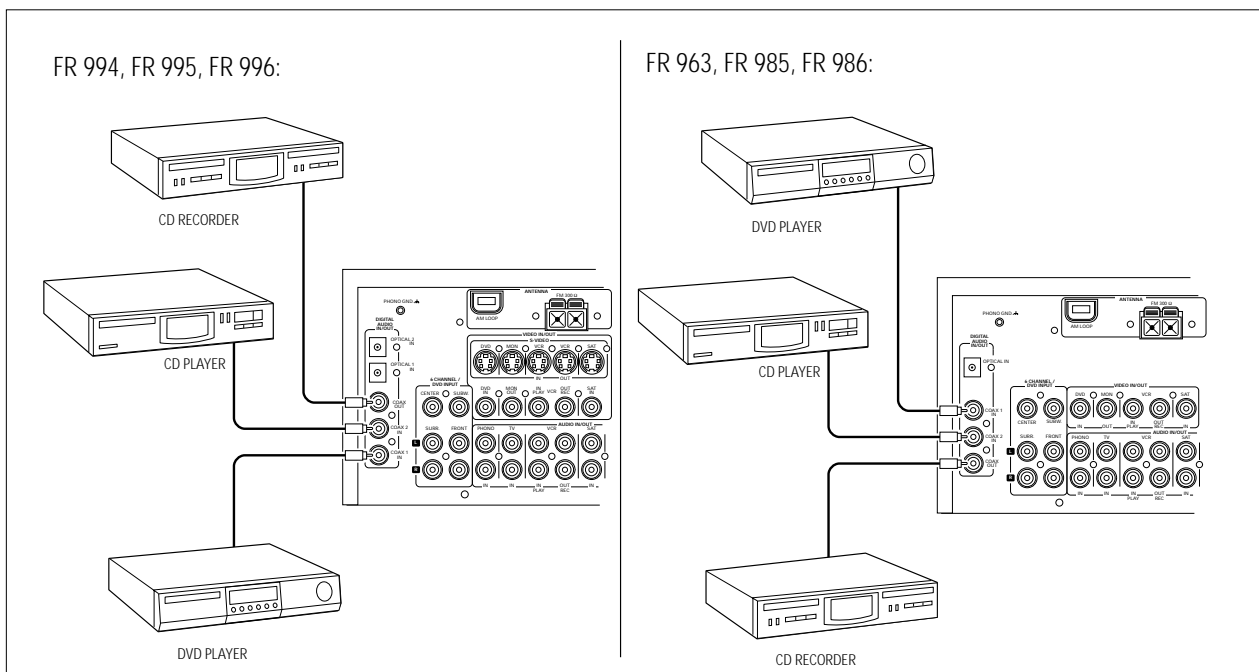

CONNECTIONS

System control bus, CINEMA LINK

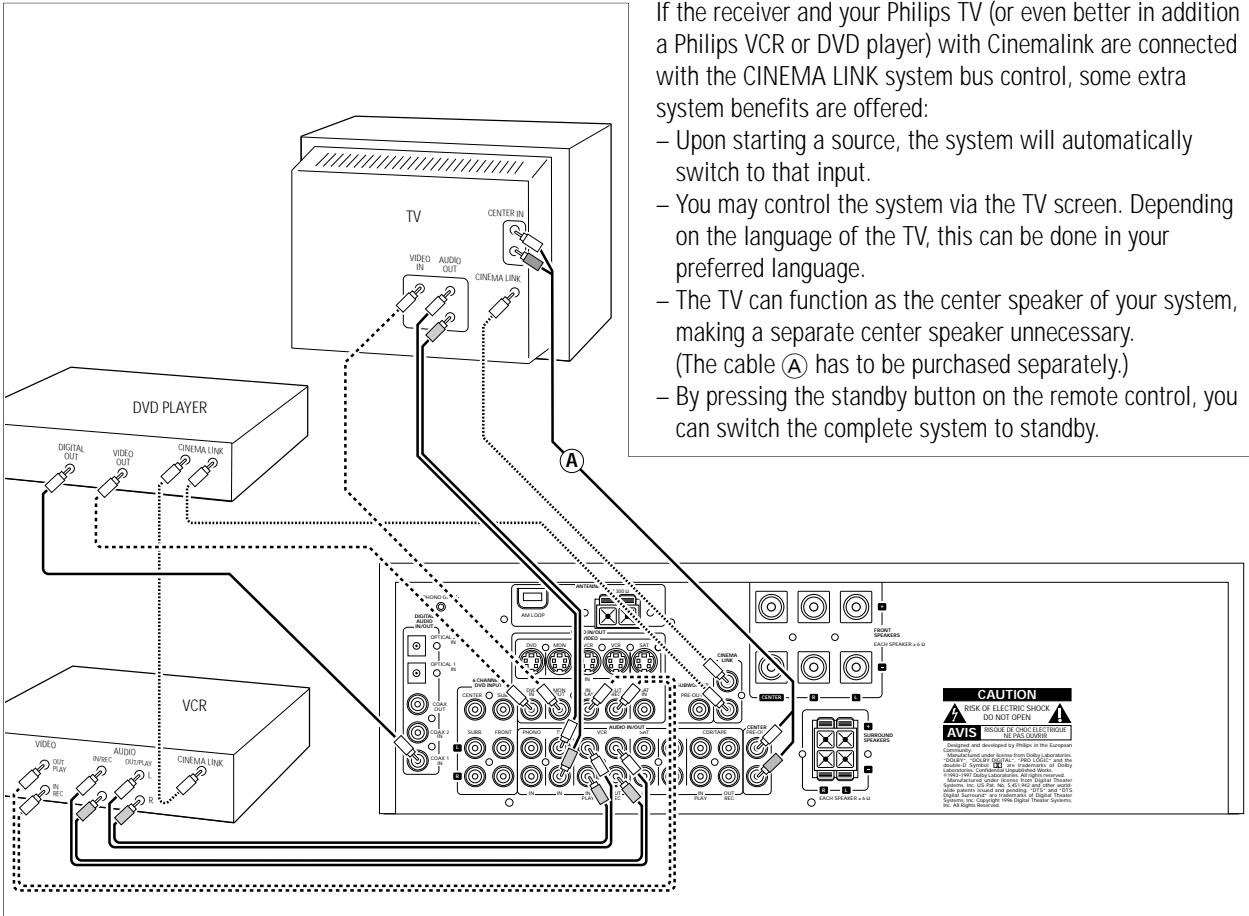

If the receiver and your Philips TV (or even better in addition a Philips VCR or DVD player) with Cinemalink are connected with the CINEMA LINK system bus control, some extra system benefits are offered:

- Upon starting a source, the system will automatically switch to that input.
- You may control the system via the TV screen. Depending on the language of the TV, this can be done in your preferred language.
- The TV can function as the center speaker of your system, making a separate center speaker unnecessary. (The cable (A) has to be purchased separately.)
- By pressing the standby button on the remote control, you can switch the complete system to standby.

Video connections

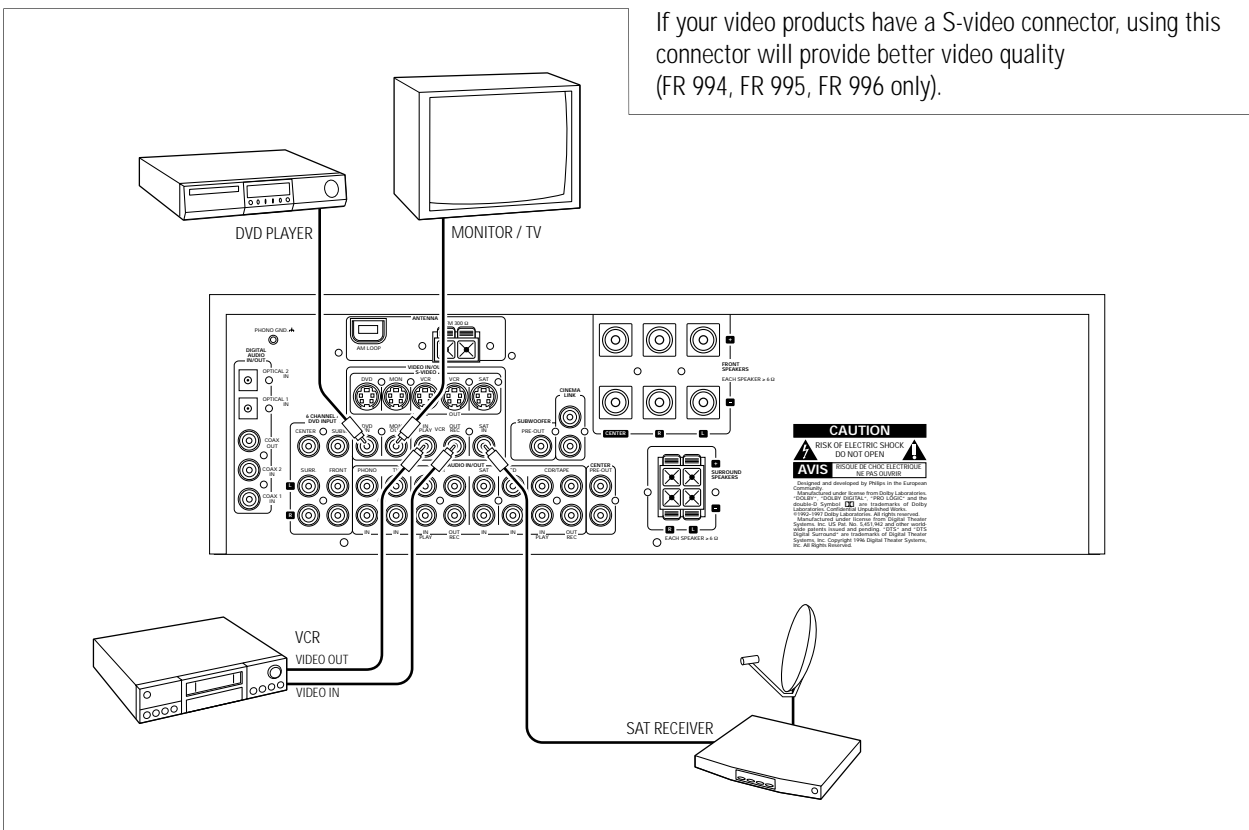

If your video products have a S-video connector, using this connector will provide better video quality (FR 994, FR 995, FR 996 only).

Power

The type plate is located on the rear of the receiver.

- 1 Check whether the power voltage as shown on the type plate corresponds to your local power voltage. If it does not, consult your dealer or service organization.
- 2 Connect the power cord to the power outlet.

To disconnect the unit from the power completely, remove the power plug from the power outlet.

Speaker connections

Some of the speaker connections on the receiver are screw connectors and some are click-fit connectors. Use them as shown below.

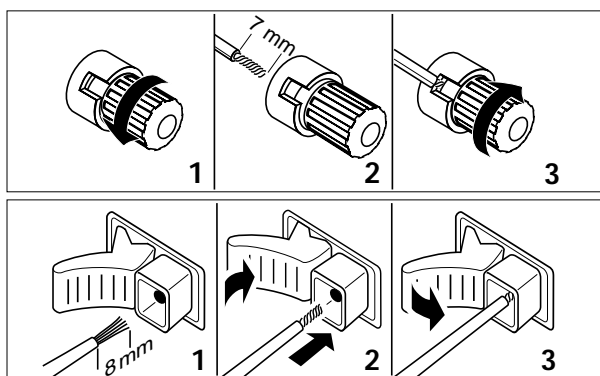

- 1 Always connect the colored (or marked) wire to the colored terminal and the black (or unmarked) wire to the black terminal.
- 2 Connect:
 - Left front speaker to L (red and black)
 - Right front speaker to R (red and black)
 - Center speaker to CENTER (blue and black)
 - Left surround speaker to SURROUND L (grey and black)
 - Right surround speaker to SURROUND R (grey and black)

TV as the center speaker

You may use your Philips TV with CINEMA LINK as the center speaker. For TV's with cinch connectors, additional cinch cables are needed. These cables must be connected to the blue CENTER PRE-OUT connector on the back. Look into the instruction manual of your TV on how to use it as the center speaker.

Antenna connections

AM (MW) antenna

The loop antenna supplied is for indoor use only. Position the antenna as far away as possible from the receiver, a TV, the cables, a DVD player, a VCR and other radiation sources.

- 1 Fit the plug of the frame antenna to AM LOOP as shown below.
- 2 Turn the antenna for optimum reception.

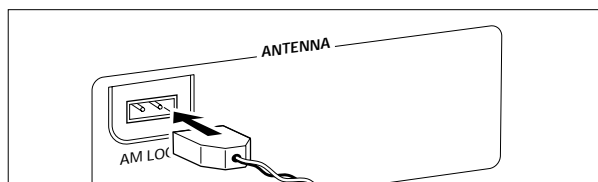

FM antenna

The wire antenna supplied can be used only to receive nearby stations. For better reception we recommend using a cable antenna system or an outdoor antenna.

- 1 Open the FM 300 Ω click-fits by pushing the lever down as shown below.
- 2 Insert each wire of the antenna into one hole.
- 3 Close the click-fits using the lever.
- 4 Move the antenna in different positions for optimum reception.

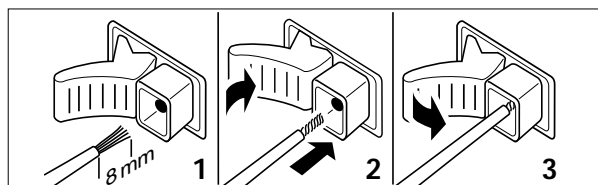

The unit complies with the FCC-Rules, Part 15.

Operation is subject to the following two conditions:

1. *This device may not cause harmful interference, and*
2. *This device must accept any interference received, including interference that may cause undesired operation.*

SYSTEM SETUP

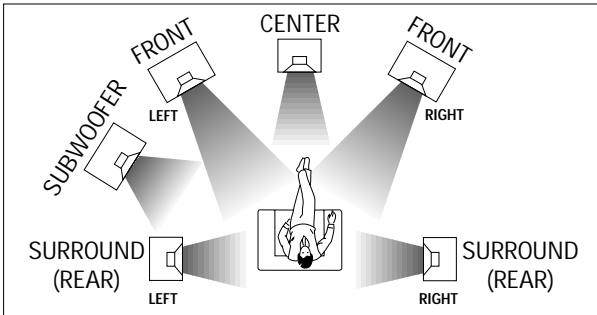

Positioning the speakers

General hints for positioning

Avoid positioning the speakers in a corner or on the floor as this will boost the bass tones too much. Placing the speakers behind curtains, furniture, etc. will reduce the treble response. The listener should always be able to "see" the speakers.

Each room has different acoustic characteristics and the positioning possibilities often are limited. You can find the best position for your speakers by referring to the picture above.

As a minimum we recommend 5 speakers (2 front, a center, 2 surround) for good surround sound. It is possible to reproduce some kind of surround sound with fewer speakers. This is done by redirecting the signals which are foreseen for the missing speakers to the existing ones. See "Menus" on how to set up the receiver correctly for the number and size of the speakers used.

Positioning the front speakers

The front speakers should be placed to the right and left in front of the listening position like usual stereo speakers.

Positioning the center speaker

The center speaker should be placed in the center between the two front speakers, e. g. underneath or on top of the TV. The best height for the center speaker is the height of the listener's ears (while seated).

Positioning the surround speakers

The surround speakers should face each other and be in line with, or slightly behind the listener.

Positioning the subwoofer

A subwoofer can be used to enhance the bass performance of your system dramatically. The subwoofer can be positioned anywhere in the room, because it is not possible to locate the source of deep tones. Nevertheless, you should not place the subwoofer in the middle of a room, since the bass could be severely weakened. Do not place any object on the subwoofer.

Speaker setup and testing

The relative volume of the speakers must be adjusted for optimal surround sound. You should be at your usual listening position when adjusting the speaker volume. See "Receiver menu" on how to unit up the receiver for the used speakers. Ideally, the volume in the listening position should be the same from all speakers.

- 1 Press POWER / STANDBY to switch on the receiver.
- 2 Press TEST TONE on the remote control.
→ A test tone coming from the different speakers, except the subwoofer, is heard.
- 3 Press + / - REAR on the remote control to increase/decrease the volume of the actual speaker. The best result is achieved when all speakers have equal volume in the listening position.
- 4 Press TEST TONE on the remote control.
→ The test tone stops.

Note: If you are not completely satisfied with the volume settings, we recommend making minor adjustments to them during surround sound playback.

Power handling

If the receiver is used at very high power it can produce distortions which may damage your speakers seriously. If distortions occur, reduce the volume and the tone controls to a level where the sound is acceptable again.

To avoid overheating of the unit a safety circuit has been built in. Therefore your set may disconnect under extreme conditions. If this happens, switch the unit off and let it cool down before reusing it. After having let the set cool down switch the set on again and select the desired source by turning SOURCE SELECT.

Headphones

Connecting headphones to PHONES will switch off the speakers. The receiver switches to STEREO and surround sound will be reduced to a stereo signal which is reproducible by standard headphones.

Disconnecting the headphones switches on the speakers again. If you wish to enjoy surround sound again, switch the receiver back to surround sound.

Maintenance

Clean the receiver with a soft, slightly dampened, lint-free cloth. Do not use any cleaning agents as they may have a corrosive effect.



Do not expose the receiver to humidity, rain, sand or excessive heat (caused by heating equipment or direct sunlight).

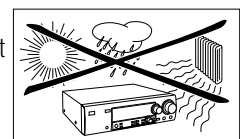

Receiver adjustment

Once the number and position of loudspeakers has been fixed, you can adjust the initial receiver settings for optimum surround sound with the actual setup:

- 1 Set which speakers have been connected to the receiver (see "Menus / SPEAKER SETUP").

Note: The initial setting of your receiver is:
two front speakers left and right: present
(cannot be altered)
center speaker: present
two rear speakers: present
subwoofer: present

- 2 Select the size of the speakers (SMALL or LARGE) (see "Menus / SPEAKER SIZES").
 Select SMALL if your speaker is able to reproduce low notes down to at least 80–100 Hz.
 Select LARGE if your speaker is able to reproduce low notes down to at least 50 Hz.
 (As a rule of thumb, a LARGE speaker has a cone diameter of at least 12 cms (5 inches).)
 See the specification sheets of your loudspeakers.

Note: The initial setting of your receiver is:
FR 985, FR 986, FR 995, FR 996:
all speakers: LARGE
FR 963, FR 994:
all speakers: SMALL

- 3 Set the distance from the speakers to the listener's position (see "Menus / SPK DISTANCE").

Note: The initial setting of your receiver is:
FR 985, FR 986, FR 995, FR 996:
all speakers: 10 feet (3 meters)
FR 963, FR 994:
front speakers, left and right: 13 feet (4 meters)
center speaker: 10 feet (3 meters)
rear speakers, left and right: 7 feet (2 meters)

DISPLAY

Display

The display of the receiver is divided into 4 sections, which are to be used for the following:

Speaker diagram

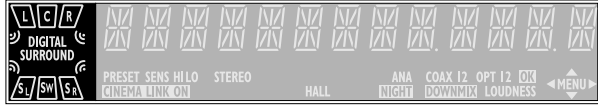

A rectangle with a letter in it shows that a speaker has been selected in the setup menu. However, the subwoofer indicator will only light when a subwoofer signal is available. If only a letter is shown, this speaker is not used and its sound is being reproduced by the other speakers.

-virtual surround sound
- SURROUND**.....surround sound is reproduced
- DIGITAL SURROUND**digital surround sound is reproduced
- L, R**front left and right speaker
- C**.....center speaker
- SL, SR**surround speakers
- SW**.....subwoofer

Menu indication

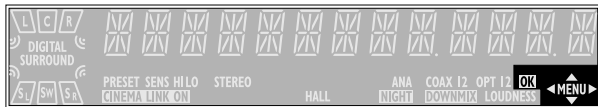

These signs show you if the menu is on or off and indicate in which direction you may move.

- MENU**Menu is on.
-You may move backwards to the previous menu topic using **◀**PREV. / EXIT (“left” key on the remote control).
-You may move up in an option list using MENU NAVIGATOR (“up” key on the remote control).
-You may move down in an option list using MENU NAVIGATOR (“down” key on the remote control).
-You may move forward to the next menu topic using **▶** NEXT (“right” key on the remote control).
- OK**.....You may confirm the displayed value.

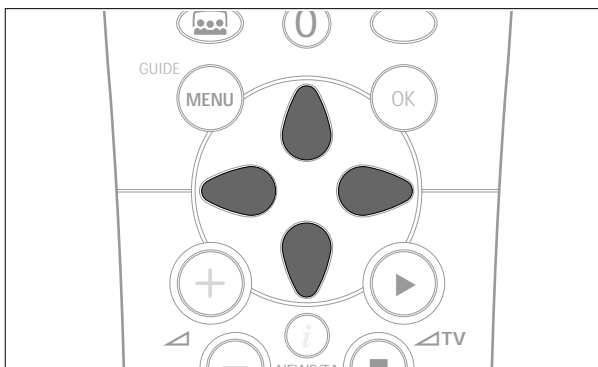

Status lights

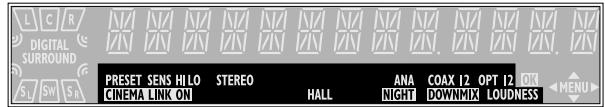

Signs show you various settings and information about the status of the receiver.

- PRESET**Tuner is tuned to a preset radio station.
- SENS HI**.....Tuner is switched to high sensitivity.
- SENS LO**Tuner is switched to low sensitivity.
- CINEMA LINK ON**CINEMA LINK is active
- STEREO**.....An FM station is being received in stereo.
- SMART SOUND**.....One of the preset sound settings of the receiver is being used (FR 985, FR 986 only).
- HALL**.....HALL effect is on.
- ANA**Analog input is being used for the playing source.
- NIGHT**NIGHT MODE is on.
- COAX 1**Coaxial digital input COAX 1 is being used for the playing source.
- COAX 2**Coaxial digital input COAX 2 is being used for the playing source.
- DOWNMIX**Incoming multichannel signals are being reduced to fewer output signals (depending on the number of speakers).
- OPT**Optical digital input OPTICAL IN is being used for the playing source (FR 963, FR 985, FR 986, FR 994 only).
- OPT 1**Optical digital input OPTICAL 1 IN is being used for the playing source (FR 995, FR 996 only).
- OPT 2**Optical digital input OPTICAL 2 IN is being used for the playing source (FR 995, FR 996 only).
- LOUDNESS**LOUDNESS is switched on.

Information area

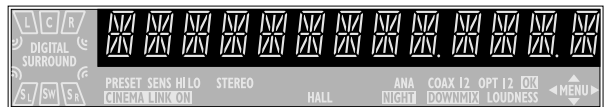

This area is used for feedback of the receiver, tuner frequencies, menu options, values and scrolling text messages.

Receiver menu

The receiver is equipped with a menu system. The menu is used for the setup of the receiver. The different menu options are related to each other in a logical way. Let's assume you have no center speaker connected, and so you switched *CENTER SPEAKR* to *NO*. If you try to use *VOL CENTER*, a message will be scrolled that this is not possible (*INSTALL CENTER SPEAKER*).

The menu always works the same way. Arrows in the display show you the possible moving directions.

- 1 Press **SETUP MENU**.
→ **MENU**, and * *EFFECTS* is displayed.
- **You can exit the menu at any time by pressing SETUP MENU.**
- 2 Turn **▲** **MENU NAVIGATOR** until the desired option (or a value) is displayed.
- 3 Press **NEXT ▶** to choose the displayed option (or **ENTER / OK** to confirm a value).
- You can leave any option (values remain unchanged) by pressing **◀ PREV. / EXIT**.

Menu structure

- * *EFFECTS*
 - Switches sound effects.
 - *3D SURR* (FR 963, FR 985, FR 986 only)
virtual 3D surround: 0...100 %
 - *VIRT SURR* (FR 994, FR 995, FR 996 only)
virtual surround: 0...100 %
- * *VOL BALANCE*
 - Adjusts the relative volume balance between the connected speakers.
 - *TEST TONE*
Test tone: on/off
 - *VOL FRONT--L*
Volume front left speaker: -50...+50
 - *VOL FRONT--R*
Volume front right speaker: -50...+50
 - *VOL CENTER*
Volume center speaker: -50...+50
 - *VOL REAR--L*
Volume rear left speaker: -50...+50
 - *VOL REAR--R*
Volume rear right speaker: -50...+50
 - *VOL SUBWOOFER*
Volume subwoofer: -50...+50

Note: When using the 6 CHANNEL / DVD INPUT the values below cannot be changed.

- * *SPEAKR SETUP*
 - Selects the used speakers.
 - *SUBW PRESENT*
Subwoofer present: yes/no
 - *CENTER SPEAKR*
Center speaker present: yes/no
 - *REAR SPEAKR*
Rear speakers present: yes/no
- * *SPEAKR SIZES*
 - Chooses the speaker sizes of the used speakers, for optimal sound reproduction. *LARGE* indicates a speaker which can reproduce frequencies lower than 50 Hz. If *SUBW PRESENT* is set to *NO*, *FRONT SIZE* can only be set to *LARGE*. If *FRONT SIZE* is set to *SMALL*, *CENTER SIZE* can only be set to *SMALL* and consequently a subwoofer must be connected.
 - *SUBW PRESENT* (FR 963, FR 985, FR 986 only)
Subwoofer present: yes/no
 - *FRONT SIZE*
Left and right front speakers: small/large
 - *CENTER SIZE*
Center speaker: small/large
 - *REAR SIZE*
Rear speakers: small/large
- * *SPK DISTANCE*
 - Distance between the usual listening position and the speakers. This defines the delay time for the surround sound.
 - *DISTANCE L/R*
Distance to front speakers: 1...10 m (3...30 ft)
 - *DISTANCE CNTR*
Distance to center speaker: 1...10 m (3...30 ft)
 - *DISTANCE REAR*
Distance to rear speakers: 1...10 m (3...30 ft)

* SELECT INPUT

Assigns the audio input connectors to the different source selections chosen with SOURCE SELECT (see "Source selection" for details).

- COAX 1
Digital coaxial input 1, COAX 1 IN
- COAX 2
Digital coaxial input 2, COAX 2 IN
- OPT (FR 963, FR 985, FR 986, FR 994 only)
Digital optical input, OPTICAL IN
- OPT 1 (FR 995, FR 996 only)
Digital optical input, OPTICAL 1 IN
- OPT 2 (FR 995, FR 996 only)
Digital optical input, OPTICAL 2 IN
- SAT IN
Analog audio input SAT IN
- VCR IN
Analog audio input VCR IN
- TV IN
Analog audio input TV IN
- CDR IN
Analog audio input CDR IN
- CD IN
Analog audio input CD IN
- 6 CH IN
Analog audio input 6 CHANNEL / DVD INPUT

* TUNER

Setup for preset radio stations (see "TUNER" for details).

- AUTO INSTALL
Stores radio stations automatically
- MAN INSTALL
Stores radio stations manually
- GIVE NAME
Allows you to assign names to stored radio stations
- RESHUFFLE
Resorts stored radio stations

TV menu

If the receiver is connected to a Philips CINEMA LINK TV via the CINEMA LINK system control bus jacks (see "CONNECTIONS"), you may use the TV to set up the system. An option called RECEIVER will be added to the TV menu.

If CINEMA LINK is on, adjustments on the receiver will be shown on the TV screen for a few seconds. Consult the instruction booklet of your TV on how to use the TV menu. The options offered may vary by TV model.

Switching the connection

- Press CINEMA LINK on or off to switch the connection between the receiver and the TV.
 - If the connection is switched on, **CINEMA LINK ON** is displayed.

Note: We recommend switching CINEMA LINK off during recording. This avoids unwanted interruptions due to switching TV functions.

If CINEMA LINK is switched on and the TV menu is active, TV MENU is displayed and the menu and sound functions on the receiver are locked.

Activating CINEMA LINK

- Press  CINEMA GO on the remote control.
 - The TV sends a play command to the CINEMA LINK DVD player, if present. The DVD player will start playing and the receiver automatically switches to the best CINEMA LINK sound.
- If no DVD player is connected or if the DVD player has no disc loaded, the TV will send a play command to the CINEMA LINK video recorder, if present.
 - The video recorder will start playing and the audio receiver selects the best CINEMA LINK sound.
- If no video recorder source is connected or tape is loaded, the TV will select the last watched TV channel.

SOURCE SELECT

When selecting a source by turning SOURCE SELECT, the audio and video inputs with the corresponding name are activated. The incoming signal is reproduced by all audio and – if the source includes a video signal – video outputs of the receiver. It is possible to reassign a source selection to other than these standard inputs.

Source selected.....Connectors used

DVD.....	COAX 1 digital audio input and DVD IN video input
PHONO.....	PHONO IN audio input
TUNER.....	The tuner part of the receiver is used, all inputs are switched off.
CD.....	CD IN audio input
CDR/TAPE.....	CDR/TAPE IN audio input
TV.....	TV IN audio input and no video input
VCR.....	VCR IN audio input and VCR IN video input
SAT.....	SAT IN audio input and SAT IN video input

6 CHANNEL-DVD/SACD INPUT selection

The 6 CHANNEL / DVD INPUT connectors can be assigned to any of the available sources (excluding TUNER and PHONO). The assignment can be done via the * *SELECT INPUT* option in the menu. See below for more details.

Reassigning a source selection

If a source is selected with SOURCE SELECT the standard audio input is used. To change this, the source selection must be reassigned to another audio input.

Example: Reassigning **CD** from the analog CD IN audio input to the digital COAX 2 IN audio input.

- 1 Choose * *SELECT INPUT* from the menu and press NEXT ►.
- 2 Turn SOURCE SELECT to select the source which should be reassigned (e. g. **CD**).
→ The name of the source is displayed and the light of the source flashes.
- 3 Turn ◊ MENU NAVIGATOR to select the input connectors which should be used (e. g. **CD** → **COAX2**).
- 4 Press ENTER / OK to confirm your selection.
→ **STORE** is displayed briefly.
- 5 This source selection is now using the chosen audio input (e. g. **CD** uses the COAX 2 IN input connectors, **COAX 2** lights when switching to CD).

Using one source selection for two or more appliances

You may assign more than one source to a source selection. This can be useful when products are connected one after the other in a chain.

Example: A VCR is connected to the TV but only the TV is connected to the receiver. Both SOURCE SELECT settings, TV as well as VCR, have to use the TV input connectors.

- 1 Choose * *SELECT INPUT* from the menu and press NEXT ►.
- 2 Turn SOURCE SELECT to select the source which should be reassigned (e. g. **VCR**).
→ The name of the source is displayed and the light of the source flashes.
- 3 Turn ◊ MENU NAVIGATOR to select the input connectors which should be used (e. g. **VCR** → **TV IN**).
- 4 Press ENTER / OK to confirm your selection.
→ **STORE** is displayed briefly.
- 5 This source selection is now using the chosen audio input (e. g. **VCR** uses the TV IN input connectors, **VCR (TV IN)** is displayed briefly when switching to VCR).

About 6 CHANNEL-DVD/SACD INPUT

The 6 CHANNEL / DVD INPUT can be used to connect a device with a built-in multichannel decoder (e.g. Dolby Digital, DTS, etc.) and 6-channel output connector, i. e. a high end DVD/SACD player.

When using the 6 CHANNEL / DVD INPUT audio input, the receiver works as a multichannel amplifier. The source reproduces surround sound and sends it to the receiver divided into the necessary channels. Therefore the SURROUND ON/OFF, HALL and SURR. MODE button have no effect since the provided signal is already multichannel.

From a source which is connected to the 6 CHANNEL / DVD INPUT audio input cannot be recorded.

Playing a source

- 1 Press POWER / STANDBY to switch on the receiver.
 - 2 Turn SOURCE SELECT to select a source.
→ The name of the source is displayed.
- You can select the FRONT AV/GAME input by pressing FRONT AV (FR 995, FR 996 only).
- 3 Start playback of the source as usual.

Adjusting the sound

- Turn VOLUME to adjust the volume.
→ VOLUME and the volume level between 0 and 50 is displayed.
- 1 Press BASS or TREBLE.
→ BASS or TREBLE and the actual value are displayed briefly. Then TURN VOLUME KNOB TO CHANGE is scrolled.
 - 2 Turn VOLUME to adjust the bass or treble.
→ BASS or TREBLE and the actual value are displayed.

Note: If VOLUME is not turned within 5 seconds or if any other control is used, the bass or treble adjustment is switched off.

FR 963, FR 985, FR 986 only:

- Press **SOUND** on the remote control to scroll through the built-in smart sounds: **MOVIE**, **SPEECH**, **MUSIC**, **MULTIMEDIA** and **PERSONAL**. (**PERSONAL** is the userdefined bass and treble setting.)
→ **SMART SOUND** is displayed and the name of the chosen sound profile is scrolled once if smart sound is on.

FR 994, FR 995, FR 996 only:

- If a subwoofer is connected, press SUBW. ON/OFF to increase the bass performance.

Note: In case of digital surround sound, a subwoofer signal will only be available when supported by the source material.

- Press **LOUDNESS** to switch on or off loudness.
→ **LOUDNESS** is displayed if loudness is on.

Recording from a source

If you wish to record from a source you must select it with SOURCE SELECT. The incoming signal is reproduced by all audio and – if the source includes a video signal – video outputs of the receiver. The sound settings do not affect the recording.

- 1 Turn SOURCE SELECT (or press FRONT AV – FR 995, FR 996 only) to select the source you want to record from.
→ The name of the source is displayed.
- 2 Prepare the desired recording appliance. It must be connected to one of the outputs of the receiver.
- 3 Start recording on the recording appliance.
- 4 Start the playback of the source as usual.

*Notes: – The audio and video signal of VCR IN is not reproduced by VCR OUT. The same applies to the audio signal of CDR/TAPE IN to CDR/TAPE OUT.
– We recommend not to use the digital output COAX OUT of the receiver to record from an analog source. Use the analog output CDR/TAPE instead.
– From a source which is connected to the 6 CHANNEL / DVD INPUT audio input cannot be recorded.*



Recording from the digital output

It is possible to connect a digital recorder to the digital output of the receiver. In this way, all signals coming from the digital inputs can be recorded directly on the connected audio recorder. The receiver will also convert all signals coming from the analog inputs to the digital output.

The receiver can be used to record digitally a multichannel surround sound audio signal (Dolby Digital or DTS) from, for example, DVD to CD-R. The receiver will convert the digital multichannel signal into a stereo signal without loss of relevant sound information.

*Notes: – Do not use the 3D SURROUND feature while making digital recordings as this will distort the digital audio signal (FR 963, FR 985, FR 986 only).
– When recording a Dolby Digital or DTS signal, each track must be recorded individually.
– Digital recording is not possible when the digital source material is copy-protected.*

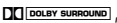
About surround sound

Surround sound gives you a completely new listening sensation. You will have the feeling of being in the middle of the action, because sound is coming from everywhere around you. Look out for TV broadcasts, audio and video tapes and discs with the ,  or  marks which are encoded for multichannel surround sound. You should prefer Dolby Digital or DTS to get the most out of your receiver.

The FR 994, FR 995 and FR 996 are able to reproduce DTS surround sound. DTS is a premium multichannel surround sound system available on DVD discs, laserdiscs and audio discs. Consult your software dealer on the availability of DTS software in your region.

Notice that DVD discs do not always carry full multichannel surround. To be sure that a disc is multichannel encoded consult your dealer.

Most ordinary stereo tapes and discs can be replayed using surround sound settings with good results. If the reproduction is distorted in surround mode, switch to normal stereo mode.

The availability of the various surround sound modes described depends on the number of speakers used and the incoming sound information.

Switching surround sound

With surround sound on, you can switch through the different surround modes. Note that the possibilities are related to speaker setup defined in the receivers menu.

If a digital surround signal is detected, the receiver will scroll either *DOLBY DIGITAL* or *DTS*.

- 1 Press SURROUND ON/OFF to switch on the surround sound.
→ The surround mode in use is scrolled.
- 2 Press SURR. MODE repeatedly to listen to the different surround modes (if available).
→ The chosen mode and the speakers used are displayed.
If the incoming multichannel signals are reduced to fewer output signals, **DOWNMIX** is displayed.

FR 963, FR 985, FR 986 only:

- 3 Press 3D SURROUND to switch on or off virtual 3D surround.
→ A light indicates if virtual 3D surround is on.

FR 994, FR 995, FR 996 only:

- 3 Press VIRTUAL MODE as often as necessary to switch through the virtual surround sound modes:
 - 1 × to activate *3D SURROUND*
 - 2 × to activate *MULTI FRONT*
 - 3 × to activate *MULTI REAR*
 - 4 × to activate *NATURAL SURROUND*
 → A light indicates if a virtual surround sound mode is on.
-signs indicate which virtual surround sound mode is active.

- 4 Press SURROUND ON/OFF to switch off the surround sound.
→ *SURROUND OFF* is scrolled.

SURROUND SOUND

Surround sound settings

HALL

The sound reproduction is enhanced and a slight echo is added. This gives the impression of being in a large room. Can only be used in stereo mode.

SURROUND

The surround mode enables normal surround sound reproduction with 4 or 5 speakers. Depending on the source material, Dolby Surround Pro Logic, Dolby Digital or DTS is reproduced.

PRO LOGIC, DOLBY DIGITAL, DTS

In addition to *SURROUND*, the surround mode used – depending on the source material – will be displayed. In case of digital surround, the sound format AC-3 (for Dolby Digital) or DTS will be displayed, followed by the sound channels, available on the source (e. g. DVD).

- Example: *AC-3 3/2.1* Dolby Digital, 3 front channels, 2 surround channels and a subwoofer channel.
AC-3 3/1.0 Dolby Digital, 3 front channels, 1 (mono) surround channel without subwoofer signal.
DTS 3/2.1 DTS, 3 front channels, 2 surround channels and a subwoofer channel.

FRONT-3 STEREO

The surround sound is muted. 3 Stereo lets you listen to surround sound without using the surround speakers.

STEREO

All sound is reproduced and played through the front left and right speakers. This enables standard stereo reproduction.

Virtual Surround

Your receiver is able to reproduce one or more forms of virtual surround sound. Virtual surround gives a more real life sound impression by creating phantom speakers in addition to or instead of real speakers. The position of the listener influences the surround effect. The area where the effect is best is shown in grey.

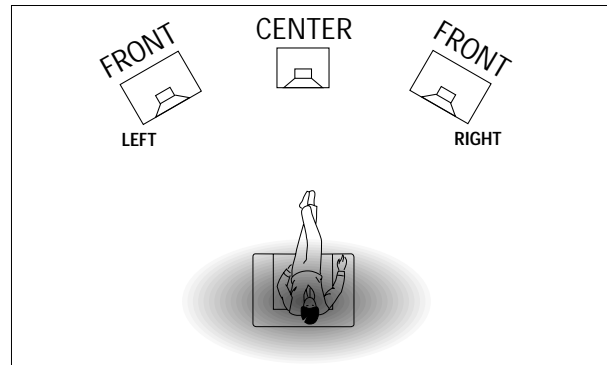

The level of virtual surround sound effect can be adjusted in the setup menu. The following surround sound modes are available:

3D SURROUND

No rear speakers are needed. The sound of the rear channel is simulated by the front speakers. Surround sound is simulated through the front left, right and center speakers.

MULTI FRONT (FR 994, FR 995, FR 996 only)

Phantom speakers are created next to the left and right front speaker.

MULTI REAR (FR 994, FR 995, FR 996 only)

Phantom speakers are created next to the left and right rear speaker.

NATURAL SURROUND (FR 994, FR 995, FR 996 only)

Phantom speakers are created next to the left and right front and rear speakers.

Note: The availability of MULTI FRONT and MULTI REAR depends on the sound channels on the source material (FR 994, FR 995, FR 996 only).

NIGHT MODE (only on the remote control)

The loud parts of the sound are lowered and the soft passages are raised. You can enjoy surround sound without disturbing sleeping children or neighbors. Night mode only works with Dolby Digital, and only if supported by the source material.

Tuning to radio stations

You can search for radio stations by scanning the frequency band. You can also key in the frequency of a known radio station. If an FM station is being broadcast and received in stereo, **STEREO** is shown.

Searching for radio stations

- 1 Turn SOURCE SELECT to select the tuner.
→ **TUNER** is displayed.
 - 2 Select a waveband by pressing TUNER BAND repeatedly.
→ The selected waveband is displayed.
 - 3 Keep ◀ or ▶ pressed for approximately 1 second.
→ **SEARCH** is displayed and the tuner tunes to a station with sufficient strength.
 - 4 Repeat this procedure until you find the desired station.
- To fine tune to a weak transmitter, briefly press ◀ or ▶ as often as necessary for optimum reception.

Tuning to a radio station by frequency (with the remote control only)

- 1 Press TUNER.
→ **TUNER** is displayed.
- 2 Press FR. D..
→ **_** is displayed.
- 3 Use 1–0 to key in the frequency of a radio station.

Notes: Only valid numbers within the frequency range of the tuner can be keyed in.

Switching FM sensitivity

You can switch the tuner to a lower search sensitivity, to search only for stations with a strong signal (FM only).

- 1 Turn SOURCE SELECT to select the tuner.
→ **TUNER** is displayed.
- 2 Press SENS. on the receiver.
→ Either **SENS HI** or **SENS LO** is displayed for 5 seconds.

*Note: While searching for radio stations, the actual sensitivity is displayed. In this case, **SENS LO** means the tuner is looking only for radio stations with a strong signal.*

Storing radio stations

You may store up to 30 radio stations in the memory. The receiver can select and program radio stations by itself or you can choose them yourself.

Automatic programming

- 1 Choose * **TUNER** from the menu and press NEXT ▶.
- 2 Choose **AUTO INSTALL** and press NEXT ▶.
→ The preset number where programming will start, the waveband and **AUTO** are displayed.
- 3 Turn TUNER PRESET ⬇ to change the preset number where programming should start.
- 4 Use TUNER BAND to switch to the desired waveband.
- 5 Press ENTER / OK to start programming.
→ **AUTO INSTALL** flashes and all available radio stations are programmed, this may take a few minutes. Programming is done when **AUTO INSTALL** stops flashing.

Manual programming

- 1 Choose * **TUNER** from the menu and press NEXT ▶.
- 2 Choose **MAN INSTALL** and press NEXT ▶.
→ A preset number, the waveband and the frequency are displayed.
- 3 Turn TUNER PRESET ⬇ to change to the preset number where the radio station should be stored.
- 4 Tune to the desired radio station (see "Searching for radio stations").
- 5 Press ENTER / OK to confirm your selection.
→ **STORE** is displayed briefly. The radio station is programmed at the chosen preset number.
- 6 Select and store all desired radio stations this way.

Tuning to stored radio stations

- 1 Turn SOURCE SELECT to TUNER to select the tuner.
→ *TUNER* is displayed.
- 2 Turn TUNER PRESET \blacklozenge to select a preset radio station.
→ **PRESET**, the preset number and station are displayed.

Resorting stored radio stations

After programming radio stations, you might want to change their sequence. *RESHUFFLE* allows you to exchange the positions of presets.

- 1 Choose * *TUNER* from the menu and press NEXT \blacktriangleright .
- 2 Choose *RESHUFFLE* and press NEXT \blacktriangleright .
→ **PRESET**, a preset number and station are displayed.
- 3 Turn TUNER PRESET \blacklozenge to select a preset station.
- 4 Press ENTER / OK to confirm the selection.
→ The selected preset number *SWAP* (↔) and a second preset number are displayed.
- 5 Turn TUNER PRESET \blacklozenge to select the other preset station.
- 6 Press ENTER / OK to confirm the exchange.
→ *RESHUFFLE* is displayed briefly and these two preset numbers are swapped.

Naming radio stations

It is possible to assign a name to any of the preset radio stations.

- 1 Choose * *TUNER* from the menu and press NEXT \blacktriangleright .
- 2 Choose *GIVE NAME* and press NEXT \blacktriangleright .
→ A preset radio station is displayed.
- 3 Turn TUNER PRESET \blacklozenge to select the preset to be renamed.
- 4 Press ENTER / OK to confirm your selection.
→ The existing name or ----- is displayed.
- 5 Turn TUNER PRESET \blacklozenge to select a letter and NEXT \blacktriangleright or \blacktriangleleft PREV. to move to the next or previous position.
- 6 After you have entered the entire name, press ENTER / OK to confirm.
→ *STORE* is displayed and the name is stored.

Clearing station names

- 1 Use the menu option * *TUNER*, choose *GIVE NAME*.
→ A preset radio station is displayed.
- 2 Turn \blacklozenge MENU NAVIGATOR to select the name to be cleared.
- 3 Press ENTER / OK to confirm your selection.
- 4 Press \blacktriangleleft PREV. while the first letter is flashing.
→ *CL* is flashing to the left of the station name.
- 5 Press ENTER / OK to clear the station name.
Or, if you have changed your mind,
press \blacktriangleleft PREV. to leave the station name as it is.

Receiver

Subject to modification without notice.

General

Power consumption (FR 963, FR 985, FR 986).....	260 W
Power consumption (FR 994, FR 995, FR 996).....	280 W
Standby power consumption	< 2 W
Dimensions, w × h × d	435 × 135 × 350 mm
Weight (FR 963, FR 985, FR 986)	8.6 kg
Weight (FR 994, FR 995, FR 996)	9.4 kg

Amplifier part (0.7 % THD, 6 Ω)

FR 963, FR 985, FR 986:

Output power, stereo mode: FTC (40 Hz–20 kHz).....	2 × 50 W
Output power, surround mode (1 kHz)	
Front	2 × 60 W
Center	60 W
Surround.....	2 × 60 W

FR 994, FR 995, FR 996:

Output power, stereo mode: FTC (40 Hz–20 kHz).....	2 × 80 W
Output power, surround mode (1 kHz)	
Front	2 × 100 W
Center	100 W
Surround.....	2 × 100 W

Bass	±9 dB at 100 Hz
Treble	±9 dB at 10 kHz
Loudness	+6 dB at 100 Hz (-30 dB); +3 dB at 10 kHz (-30 dB)
Total harmonic distortion.....	0.05 % at 1 kHz, 5 W
Frequency response	20–20,000 Hz, ±1 dB
S/N ratio	≥ 82 dB
Stereo separation (1 kHz)	≥ 45 dB
Crosstalk (1 kHz)	≤ -65 dB

Inputs

Linear inputs	250 mV/47 kΩ
6 CH	250 mV/40 kΩ
Front AV (FR 995, FR 996 only).....	250 mV/22 kΩ
Phono	5 mV/47 kΩ
Digital coaxial	75 Ω acc. IEC 958
Digital optical.....	toslink

Outputs

Power supply AC outlets (switched)	totally max. 120 W
Linear outputs.....	250 mV/1 kΩ
Digital coaxial	75 Ω acc. IEC 958
Digital output sampling frequencies	
Analog in	out 48 kHz
Digital in 32 kHz.....	out 32 kHz
Digital in 44.1 kHz.....	out 44.1 kHz
Digital in 48 kHz.....	out 48 kHz
Digital in 96 kHz (FR 994, FR 995, FR 996 only).....	out 48 kHz
Subwoofer pre-out.....	0.8 V/1 kΩ
Center pre-out.....	0.8 V/1 kΩ
Headphones.....	8–600 Ω (3 V e.m.f., 60 Ω)
Speakers	≥ 6 Ω

Tuner part

Wave range	
FM	87.5–108.0 MHz
AM	530–1,700 kHz
Sensitivity	
Stereo FM	41 dBf
Mono FM.....	17 dBf
Total harmonic distortion	
Stereo FM	0.8 %
Mono FM.....	0.9 %
Frequency response	63–12,500 Hz ±1 dB
S/N ratio	
Stereo FM.....	55 dB
Mono FM.....	60 dB
Channel separation	27 dB at 1 kHz

TROUBLESHOOTING

WARNING

Under no circumstances should you try to repair the set yourself as this will invalidate the warranty. Do not open the set as there is a risk of electric shock.

If a fault occurs, first check the points listed, before taking the set for repair.

If you are unable to solve a problem by following these hints, consult your dealer or service center.

PROBLEM	POSSIBLE CAUSE	SOLUTION
Set does not work and is in standby mode	The overheating safety circuit has been activated.	Switch the set off and let it cool down. After having let the set cool down switch it on again and select a source by rotating SOURCE SELECT or pressing a source key on the remote control.
No sound	VOLUME is not adjusted correctly.	Adjust the VOLUME.
	Headphones are connected.	Disconnect headphones.
	The wrong source is selected.	Turn SOURCE SELECT to select the correct source.
No sound on the left or right side	One speaker is connected incorrectly.	Connect the speaker properly.
	A speaker cable is damaged.	Replace the cable.
	Volume balance in the receiver menu is adjusted incorrectly.	Adjust <i>VOL FRONT-L</i> and <i>VOL FRONT-R</i> in the receiver menu.
Poor sound or no sound at the center or surround speakers	SURROUND mode is not switched on.	Press SURROUND ON/OFF to switch on the surround sound.
	Surround and/or center speakers are not (properly) connected.	Connect the speakers properly.
	Surround and/or center speakers are switched off in the <i>SPEAKER SETUP</i> menu.	Set speaker present to YES.
Poor bass sound	A speaker cable is damaged.	Replace the cable.
	Speakers are not in phase.	Connect the colored (or marked) wires to the colored terminals and the black (or unmarked) wires to the black terminals.
Bad sound	Badly matching setting for the given type of music or sound.	Correct the sound settings on the receiver.
Surround sound level is too low or too high	The level of the surround sound is not adjusted properly.	Adjust the level of the surround sound on the receiver.
Center sound level is too low or too high	The sound level of the center channel is not adjusted properly .	Adjust the level of the center channel on the receiver.
Only center speaker is heard in Dolby Surround Pro Logic	A mono signal is reproduced.	Choose a different sound source or switch off surround sound.
Bad radio reception, automatic programming does not work properly	Receiver or antenna is positioned near a radiation source such as TV, CD player, CD recorder, DVD player, etc.	Change the position of the interfering unit or try to switch it off.
No digital recording possible via digital output	The sampling frequency is not accepted by the digital recorder.	Make sure the digital recorder can handle sampling frequencies between 32 kHz and 48 kHz or make the recording via analog output.
Whole recording appears as one track when recording from DVD disc	The DVD player does not provide track information.	Record each track individually or use the "manual track increment" feature on the recorder.

LIMITED WARRANTY

AUDIO SYSTEM

One Year Free Labor

One Year Free Service on Parts

This product must be carried in for repair.

WHO IS COVERED?

You must have proof of purchase to receive warranty service. A sales receipt or other document showing that you purchased the product is considered proof of purchase.

WHAT IS COVERED?

Warranty coverage begins the day you buy your product. For one year thereafter, all parts will be repaired or replaced, and labor is free. After one year from the day of purchase, you pay for the replacement or repair of all parts, and for all labor charges. All parts, including repaired and replaced parts, are covered only for the original warranty period. When the warranty on the product expires, the warranty on all replaced and repaired parts also expires.

WHAT IS EXCLUDED?

Your warranty does not cover:

- labor charges for installation or setup of the product, adjustment of customer controls on the product, and installation or repair of antenna systems outside of the product.
- product repair and/or part replacement because of misuse, accident, unauthorized repair or other cause not within the control of Philips Consumer Electronics Company.
- reception problems caused by signal conditions or cable or antenna systems outside the unit.
- a product that requires modification or adaptation to enable it to operate in any country other than the country for which it was designed, manufactured, approved and/or authorized, or repair of products damaged by these modifications.
- incidental or consequential damages resulting from the product. (Some states do not allow the exclusion of incidental or consequential damages, so the above exclusion may not apply to you. This includes, but is not limited to, prerecorded material, whether copyrighted or not copyrighted.)
- a product that is used for commercial or institutional purposes.

WHERE IS SERVICE AVAILABLE?

Warranty service is available in all countries where the product is officially distributed by Philips Consumer Electronics Company. In countries where Philips Consumer Electronics Company does not distribute the product, the local Philips service organization will attempt to provide service (although there may be a delay if the appropriate spare parts and technical manual(s) are not readily available).

MAKE SURE YOU KEEP...

Please keep your sales receipt or other document showing proof of purchase. Attach it to this owner's manual and keep both nearby. Also keep the original box and packing material in case you need to return your product.

BEFORE REQUESTING SERVICE...

Please check your owner's manual before requesting service. Adjustments of the controls discussed there may save you a service call.

TO GET WARRANTY SERVICE IN U.S.A., PUERTO RICO OR U.S. VIRGIN ISLANDS...

Take the product to a Philips factory service center (see enclosed list) or authorized service center for repair. When the product has been repaired, you must pick up the unit at the center. Centers may keep defective parts. (In U.S.A., Puerto Rico and U.S. Virgin Islands, all implied warranties, including implied warranties of merchantability and fitness for a particular purpose, are limited in duration to the duration of this express warranty. But, because some states do not allow limitations on how long an implied warranty may last, this limitation may not apply to you.)

TO GET WARRANTY SERVICE IN CANADA...

Please contact Philips at:

1-800-661-6162 (French Speaking)
1-800-363-7278 (English Speaking)

(In Canada, this warranty is given in lieu of all other warranties. No other warranties are expressed or implied, including any implied warranties of merchantability or fitness for a particular purpose. Philips is not liable under any circumstances for any direct, indirect, special, incidental or consequential damages, howsoever incurred, even if notified of the possibility of such damages.)

REMEMBER...

Please record the model and serial numbers found on the product below. Also, please fill out and mail your warranty registration card promptly. It will be easier for us to notify you if necessary.

MODEL # _____

SERIAL # _____

This warranty gives you specific legal rights. You may have other rights which vary from state/province to state/province.

Philips Service Solutions Group, P.O. Box 2976, Longview, Texas 75606, (903) 242-4800

EL4965E005 / MAC 4110 / 1-97

Download from www.Somanuals.com. All Manuals Search And Download.

CABLE BOX

ABC.....	0030, 0035, 0038, 0040, 0028, 0034, 0041, 0044
Allegro.....	0180, 0342
Antronix.....	0049, 0234
Archer.....	0049, 0180, 0234, 0824
Belcor.....	0083
Bell & Howell.....	0041
Cable Star.....	0083
Cabletenna.....	0049
Cableview.....	0049
Century.....	0180
Citizen.....	0180, 0342
Colour Voice.....	0052, 0058
Comtronics.....	0067
Contec.....	0046
Digi.....	0664
Eastern.....	0029
Emerson.....	0824
Everquest.....	0042, 0067
Focus.....	0427
France Telecom.....	0923
GC Electronics.....	0083, 0234
Garrard.....	0180
Gemini.....	0269, 0042
General Instrument.....	0303, 0503, 0038, 0837
GoldStar.....	0067, 0171
Goodmind.....	0824
Hamlin.....	0047, 0036, 0286, 0061
Hitachi.....	0038
Hytex.....	0034
Jasco.....	0042, 0180, 0342
Jerrold.....	0030, 0039, 0303, 0038, 0041, 0042, 0051, 0503, 0837
Linsay.....	0467
Magnavox.....	0054, 0041
Memorex.....	0027
Movie Time.....	0090, 0183
NAP.....	0034
NSC.....	0183, 0090
Novaplex.....	0645
Oak.....	0046, 0034
Optimus.....	0048
Panasonic.....	0048, 0134, 0027
Panther.....	0664
Paragon.....	0027
Philips.....	0052, 0058, 0269, 0317, 0054, 0180
Pioneer.....	0171, 0050, 0560
Popular Mechanics.....	0427
Proscan.....	0048
Pulsar.....	0027
Quasar.....	0027
RCA.....	0048
Radio Shack.....	0824, 0042, 0342, 0910
Realistic.....	0234
Recoton.....	0427
Regal.....	0286, 0047
Regency.....	0029
Rembrandt.....	0038
Runco.....	0027
SL Marx.....	0067
Samsung.....	0067, 0171
Scientific Atlanta.....	0035, 0044, 0504
Seam.....	0537
Signal.....	0042, 0067
Signature.....	0038
Sprucer.....	0048
Starcom.....	0030, 0042
Stargate.....	0067, 0042, 0824
Starquest.....	0042
Sylvania.....	0028
TFC.....	0337
TV86.....	0090
Tandy.....	0285
TeleCaption.....	0248
Televue.....	0067
Texscan.....	0028
Timeless.....	0445
Tocom.....	0039, 0040
Toshiba.....	0027
Tusa.....	0042
Unika.....	0234, 0180, 0049
United Artists.....	0034
Universal.....	0234, 0049, 0083, 0218, 0180
Viewstar.....	0285, 0054, 0090
Westminster.....	0132
Zenith.....	0027, 0552, 0081, 0035, 0042, 0234
Zentek.....	0427

CD

ADC.....	0045
Adcom.....	0261, 0182
Aiwa.....	0151, 0039, 0184
Akai.....	0183
Anthem.....	0924
Audio Alchemy.....	0221
Audio-Technica.....	0197
BSR.....	0272, 0221
Burmester.....	0447
California Audio Lab.....	0056
Carrera.....	0221
Carver.....	0184, 0206, 0464
Craig.....	0642
Crown.....	0149
Curtis Mathes.....	0056
DAK.....	0272
DBX.....	0281
DKK.....	0027
Denon.....	0030, 0061, 0900
Emerson.....	0182, 0191, 0332, 0496
Fisher.....	0115, 0206, 0201, 0369
GE.....	0036
Garrard.....	0307, 0272, 0420, 0447, 0452
Genexxa.....	0059, 0191, 0332
GoldStar.....	0444
Harman/Kardon.....	0200, 0184, 0453
Hitachi.....	0059, 0182
JVC.....	0099, 0682, 0685
Kenwood.....	0055, 0217, 0708, 0853, 0064
Kodak.....	0314
Krell.....	0184
Kyocera.....	0045

LXI.....0332
 Linn.....0184
 Luxman.....0120
 MCS.....0056, 0070
 MGA.....0110
 MTC.....0447
 Magnavox.....0184, 0553, 0332
 Marantz.....0184, 0056, 0207, 0462
 McIntosh.....0314
 Mission.....0184
 Mitsubishi.....0110
 NAD.....0046
 NEC.....0261, 0070
 NSM.....0184
 Nakamichi.....0174
 Nikko.....0197, 0191, 0201
 Onkyo.....0128, 0895
 Optimus.....0447, 0495, 0059, 0453, 0206, 0223,
 0464, 0202, 0332, 0064, 0114, 0172,
 0221, 0307, 0369, 0027
 Panasonic.....0056, 0394, 0330, 0779
 Parasound.....0447, 0221
 Philips.....0184, 0314
 Pioneer.....0059, 0495, 0271, 0332
 Proscan.....0080
 Proton.....0184
 QED.....0184
 Quasar.....0056
 RCA.....0080, 0332, 0036, 0182, 0206, 0791
 Realistic.....0182, 0202, 0191, 0206, 0207, 0447
 Rotel.....0184, 0447, 0924
 SAE.....0184
 STS.....0045
 Sansui.....0229, 0184, 0332
 Sanyo.....0114, 0206
 Scott.....0191, 0182, 0332
 Sears.....0332
 Sharp.....0064, 0207, 0888
 Sherwood.....0141, 0207, 0223, 0453
 Shure.....0070
 Sony.....0027, 0212, 0631, 0517, 0632
 Soundesign.....0172, 0452
 Sylvania.....0184
 Tascam.....0447
 Teac.....0420, 0447, 0201, 0207
 Technics.....0056, 0330, 0234
 Toshiba.....0046
 Vector Research.....0221, 0444
 Victor.....0099
 Wards.....0080, 0184
 Yamaha.....0214, 0063, 0197
 Yorx.....0488
 Zenith.....0642

TAPE

Aiwa.....0224, 0227, 0056
 Akai.....0310
 Carver.....0056
 Denon.....0103
 Fisher.....0101
 Garrard.....0335, 0466

Harman/Kardon.....0209, 0056
 JVC.....0271, 0300
 Kenwood.....0098, 0097, 0260
 Magnavox.....0056
 Marantz.....0056, 0036
 Mitsubishi.....0310
 NAD.....0171
 Onkyo.....0162, 0163, 0309
 Optimus.....0247, 0054, 0364, 0466
 Panasonic.....0256
 Philips.....0056
 Pioneer.....0054, 0247, 0126
 Proscan.....0053
 RCA.....0053
 Revox.....0217
 Sansui.....0036, 0056
 Sharp.....0258
 Sherwood.....0364
 Sony.....0270, 0197, 0318
 Teac.....0335, 0316
 Technics.....0256
 Victor.....0300
 Wards.....0054
 Yamaha.....0121, 0124

DVD

Harman/Kardon.....0609
 JVC.....0585
 Kenwood.....0561
 Magnavox.....0530
 Mitsubishi.....0548
 Onkyo.....0530
 Optimus.....0552
 Panasonic.....0517
 Philips.....0566, 0530
 Pioneer.....0552, 0598
 Proscan.....0549
 RCA.....0549
 Samsung.....0600
 Sony.....0560
 Technics.....0517
 Thomson.....0578
 Toshiba.....0530
 Yamaha.....0572, 0517
 Zenith.....0618, 0530

TV

A-Mark.....0030
 AOC.....0079, 0030, 0212, 0046, 0057
 Abex.....0059
 Admiral.....0120
 Adventura.....0073
 Aiko.....0119
 Akai.....0057
 Alaron.....0206
 Allegro.....0747, 0801
 Ambassador.....0204
 Ampro.....0778
 Anam.....0207
 Anam National.....0082
 Archer.....0030

Audiovox.....	0119, 0030, 0207, 0478, 0650	KTV.....	0307, 0207, 0212, 0244, 0066, 0057
Aumark.....	0087	Kaypani.....	0079
Baysonic.....	0207	Kenwood.....	0057, 0046
Belcor.....	0046	Kloss.....	0073, 0051
Bell & Howell.....	0043, 0181	LG.....	0083
Bradford.....	0207	LXI.....	0181, 0205, 0074, 0044, 0081, 0183
Brockwood.....	0046	Loewe.....	0539
Broksonic.....	0030, 0263, 0490	Logik.....	0043
CCE.....	0064, 0244	Luxman.....	0083
CXC.....	0207	MEI.....	0212
Candle.....	0213, 0073, 0057, 0083	MGA.....	0177, 0046, 0057, 0205
Capehart.....	0079	MTC.....	0087, 0046, 0057, 0212, 0083
Carnivale.....	0057	Magnavox.....	0081, 0214, 0051, 0123, 0047, 0213, 0057, 0413, 0206
Carver.....	0081	Majestic.....	0043
Celebrity.....	0027	Marantz.....	0081, 0064, 0057
Cineral.....	0478, 0119	Matsushita.....	0078, 0277
Citizen.....	0213, 0073, 0083, 0057, 0066, 0087, 0119, 0307	Megatron.....	0030, 0172, 0205
Clairtone.....	0212	Memorex.....	0205, 0043, 0083, 0087, 0177, 0181, 0277
Concerto.....	0083	Midland.....	0044, 0059, 0066, 0074, 0078, 0162
Contec.....	0184, 0207, 0212	Minutz.....	0048
Craig.....	0207	Mitsubishi.....	0177, 0046, 0205, 0120
Crosley.....	0081	Motorola.....	0082, 0120
Crown.....	0066, 0207	Multitech.....	0244, 0207
Curtis Mathes.....	0087, 0057, 0181, 0043, 0066, 0074, 0078, 0081, 0083, 0120, 0172, 0193, 0478, 0493	NAD.....	0183, 0193, 0205
Daewoo.....	0119, 0650, 0046, 0651, 0478, 0066	NEC.....	0057, 0046, 0083, 0524
Daytron.....	0046, 0066	NTC.....	0119
Denon.....	0172	Nikko.....	0205, 0044, 0074, 0057, 0119, 0181, 0183
Dumont.....	0044, 0046	Noshi.....	0045
Dwin.....	0747, 0801	Onwa.....	0207
Dynatech.....	0244	Optimus.....	0277, 0193, 0181
Electroband.....	0027, 0212	Optonica.....	0120, 0192
Electrohome.....	0408	Orion.....	0263, 0206, 0490
Emerson.....	0263, 0207, 0205, 0206, 0490, 0204, 0309, 0307, 0651, 0066, 0212, 0650, 0046, 0065, 0181	Panasonic.....	0078, 0277, 0082, 0028, 0074, 0080, 0081, 0087, 0120, 0172, 0177, 0181, 0183, 0192, 0205
Envision.....	0057	Penney.....	0074, 0057, 0087, 0048, 0054, 0162, 0045, 0205, 0078, 0066, 0046, 0030, 0059, 0083, 0183
Fisher.....	0181, 0186	Philco.....	0047, 0046, 0057, 0081, 0123, 0172, 0490, 0051, 0213, 0214
Fujitsu.....	0206	Philips.....	0081, 0044, 0047, 0066, 0064, 0027, 0045, 0046, 0048, 0051, 0054, 0079
Funai.....	0207, 0198, 0206	Pilot.....	0046, 0057, 0066
Futuretech.....	0207	Pioneer.....	0193, 0065
GE.....	0048, 0054, 0074, 0082, 0078, 0205, 0162, 0309, 0478, 0120	Portland.....	0119, 0046, 0066
Gibraltar.....	0044, 0046, 0057	Prism.....	0078
Go Video.....	0087	Proscan.....	0074, 0057
GoldStar.....	0028, 0205, 0057, 0046, 0059, 0066, 0083	Proton.....	0493, 0205, 0030, 0079
Gradiente.....	0083, 0080	Pulsar.....	0044, 0046
Grundig.....	0064, 0222	Quasar.....	0078, 0082, 0277, 0192
Grunpy.....	0206, 0207	RCA.....	0074, 0045, 0162, 0046, 0065, 0078, 0117, 0120
Hallmark.....	0205	Radio Shack.....	0192, 0207, 0205, 0057, 0066, 0046, 0181, 0059, 0074, 0083
Harley Davidson.....	0206	Realistic.....	0192, 0207, 0181, 0057, 0066, 0205, 0046, 0059, 0083
Harman/Kardon.....	0081	Rhapsody.....	0212
Harvard.....	0207	Runco.....	0044, 0524, 0057
Hitachi.....	0172, 0178, 0065, 0083, 0059	SSS.....	0046, 0207
Infinity.....	0081	Sampo.....	0057, 0059, 0066, 0079
Inteq.....	0044		
JBL.....	0081		
JCB.....	0027		
JVC.....	0080		
Janeil.....	0073		
KEC.....	0207		

Samsung.....	0087, 0059, 0205, 0046, 0057, 0066, 0083, 0064	Audiovox.....	0064
Samsux.....	0066	Beaumarck.....	0267
Sansei.....	0478	Bell & Howell.....	0131
Sansui.....	0490	Blaupunkt.....	0033
Sanyo.....	0181, 0186, 0173	Broksonic.....	0211, 0148, 0388, 0029, 0236, 0238, 0322, 0506
Scimitzu.....	0046	CCE.....	0099, 0305
Scotch.....	0205	Calix.....	0064
Scott.....	0263, 0205, 0206, 0207, 0046	Canon.....	0062
Sears.....	0186, 0181, 0173, 0183, 0081, 0083, 0198, 0205, 0074, 0206	Capehart.....	0047
Semivox.....	0207	Carver.....	0108
Semp.....	0183	Cineral.....	0305
Sharp.....	0192, 0120, 0413, 0066, 0184	Citizen.....	0305, 0064
Shogun.....	0046	Colt.....	0099
Signature.....	0043	Craig.....	0064, 0074, 0099, 0267, 0298
Simpson.....	0213, 0214	Curtis Mathes.....	0062, 0068, 0087, 0189
Sony.....	0027, 0138, 0107	Cybernex.....	0078, 0267
Soundesign.....	0205, 0207, 0206, 0213	Daewoo.....	0305, 0588, 0047, 0072
Spectricon.....	0030	Daytron.....	0047
Squareview.....	0198	Denon.....	0069
Starlite.....	0207	Dynatech.....	0027
Supre-Macy.....	0073	Electrohome.....	0064
Supreme.....	0027	Electroponic.....	0064
Sylvania.....	0081, 0047, 0123, 0057, 0408, 0051, 0213, 0214	Emerex.....	0059
Symphonic.....	0198	Emerson.....	0211, 0029, 0148, 0236, 0063, 0238, 0305, 0321, 0115, 0235, 0506, 0088, 0239, 0588, 0095, 0322, 0388, 0027, 0064, 0070
TMK.....	0083, 0204, 0205	Fisher.....	0074, 0131, 0081, 0093
Tandy.....	0120	Fuji.....	0060, 0062
Tatung.....	0030, 0082	Funai.....	0027
Technics.....	0078, 0277, 0044, 0074	GE.....	0062, 0087, 0229, 0075, 0267
Technol Ace.....	0206	Garrard.....	0027
Techwood.....	0030, 0078, 0083	Go Video.....	0459, 0553
Teknika.....	0213, 0043, 0206, 0046, 0066, 0081, 0207, 0083, 0119, 0177, 0087	GoldStar.....	0064, 0065
Telefunken.....	0083	Gradiente.....	0035, 0027
Toshiba.....	0183, 0087, 0181	HI-Q.....	0074
Tosonic.....	0212	Harley Davidson.....	0027
Totevision.....	0066	Harman/Kardon.....	0108, 0065
Trical.....	0184	Harwood.....	0095, 0099
Universal.....	0054, 0048	Headquarter.....	0073
Vector Research.....	0057	Hitachi.....	0069, 0132, 0027, 0068
Victor.....	0080	JVC.....	0094, 0035, 0068
Vidikron.....	0081	Jensen.....	0068
Vidtech.....	0046, 0205	KEC.....	0064, 0305
Viking.....	0073	KLH.....	0099
Wards.....	0081, 0192, 0205, 0183, 0043, 0047, 0048, 0123, 0138, 0214, 0054, 0107, 0206, 0046, 0057, 0083, 0162	Kenwood.....	0068, 0094, 0065, 0073
White Westinghouse.....	0651, 0650	Kodak.....	0062, 0064
Yamaha.....	0046, 0057	LXI.....	0064
Zenith.....	0044, 0043, 0119, 0173	Lloyd's.....	0027, 0235
Zonda.....	0030	Logik.....	0099
VCR		MEI.....	0062
Admiral.....	0075	MGA.....	0070, 0088, 0267
Adventura.....	0027	MGN Technology.....	0267
Aiko.....	0305	MTC.....	0027, 0267
Aiwa.....	0334, 0027, 0064	Magnasonic.....	0305
Akai.....	0133, 0080, 0088, 0068	Magnavox.....	0062, 0108, 0027, 0066, 0176
American High.....	0062	Magnin.....	0267
Asha.....	0267	Marantz.....	0108, 0065, 0062
		Marta.....	0064
		Matsushita.....	0062, 0481, 0189
		Memorex.....	0131, 0074, 0027, 0064, 0062, 0075, 0267, 0334, 0073, 0066

Metz.....	0033, 0064, 0189, 0323
Minolta.....	0132, 0069
Mitsubishi.....	0070, 0088, 0094, 0075
Motorola.....	0062, 0075
Multitech.....	0027, 0099
NAD.....	0085
NAP.....	0060, 0061, 0062, 0064, 0066, 0069, 0093, 0132
NEC.....	0065, 0067, 0068, 0094, 0131
Nikko.....	0064
Nikon.....	0061, 0280
Noblex.....	0267
Olympus.....	0062
Optimus.....	0085, 0075, 0064, 0459, 0131, 0189, 0481
Optonica.....	0089
Orion.....	0506, 0322, 0029, 0211
Panasonic.....	0062, 0104, 0189, 0252, 0481
Penney.....	0062, 0267, 0064, 0065, 0069, 0067, 0081
Pentax.....	0069, 0132
Philco.....	0062, 0506, 0236
Philips.....	0108, 0062, 0089
Pilot.....	0064
Pioneer.....	0085, 0094
Portland.....	0047
Profitronic.....	0267
Proscan.....	0087, 0229
Protec.....	0099
Pulsar.....	0066, 0078
Quarter.....	0073
Quartz.....	0073
Quasar.....	0062, 0189, 0104, 0481
RCA.....	0087, 0176, 0229, 0069, 0132, 0104, 0133, 0062, 0075, 0267
Radio Shack.....	0027
Radix.....	0064
Randex.....	0064
Realistic.....	0074, 0027, 0131, 0075, 0064, 0062, 0089, 0073, 0093
Ricoh.....	0061, 0280
Runco.....	0066
STS.....	0069
Samsung.....	0267, 0072, 0080, 0078
Sanky.....	0066, 0075
Sansui.....	0506, 0068, 0298, 0027, 0094
Sanyo.....	0073, 0074, 0131, 0267
Scott.....	0211, 0148, 0238, 0072, 0237, 0239, 0070
Sears.....	0069, 0132, 0081, 0073, 0064, 0074, 0131, 0027, 0062, 0093
Semp.....	0072
Sharp.....	0075, 0089
Shintom.....	0099
Shogun.....	0078, 0267
Signature.....	0062
Singer.....	0099
Sony.....	0060, 0061, 0059, 0280, 0062, 0027
Sunpak.....	0280
Sylvania.....	0062, 0108, 0027, 0070
Symphonic.....	0027
TMK.....	0063, 0235, 0267
Tatung.....	0068
Teac.....	0027, 0068
Technics.....	0062, 0189, 0066, 0087, 0229
Teknika.....	0027, 0062, 0064
Thomas.....	0027
Toshiba.....	0072, 0239, 0237, 0093, 0070
Totevision.....	0064, 0267
Unitech.....	0267
Vector.....	0072
Vector Research.....	0065, 0067
Video Concepts.....	0067, 0088, 0072
Videosonic.....	0267
Wards.....	0062, 0075, 0089, 0027, 0087, 0074, 0072, 0267, 0239, 0069, 0099, 0176, 0108
White Westinghouse.....	0305
XR-1000.....	0099, 0027, 0062
Yamaha.....	0065, 0068
Zenith.....	0066, 0060, 0061, 0027, 0506

SAT

AlphaStar.....	0799
Astro Industries.....	0122
BSR.....	0122
Capetronic.....	0122
Channel Master.....	0045, 0239
Chaparral.....	0080, 0236, 0243
DX Antenna.....	0068
Drake.....	0091, 0272, 0045
Echostar.....	0307, 0802, 0175, 0186, 0296
Expressvu.....	0802
General Instrument.....	0388, 0896, 0654
Grundig.....	0200
HTS.....	0802
Hitachi.....	0846
Homecable.....	0265
Hughes Network Syst.....	0776
Hytek.....	0122
IQ.....	0237
IQ Prism.....	0237
JVC.....	0802
Janeil.....	0179
Jerrold.....	0388, 0654
Legend.....	0296
Macom.....	0045
Magnavox.....	0749, 0751
Memorex.....	0296, 0751
Next Level.....	0896
Panasonic.....	0179, 0728
Philips.....	0227, 0126, 0749, 0751
President.....	0101
Primestar.....	0654, 0388
Proscan.....	0593
RCA.....	0593, 0170, 0882
Radio Shack.....	0593
Realistic.....	0079
STS.....	0237, 0068
Sony.....	0666
Star Choice.....	0896
Star Trak.....	0207
Toshiba.....	0109, 0817
Uniden.....	0265, 0397, 0079, 0101, 0751, 0103, 0749
Zenith.....	0091, 0883, 0272

English

Français

Español

PHILIPS CONSUMER ELECTRONICS COMPANY

A Division of Philips Electronics North America Corporation
Knoxville, Tennessee 37914-1810, U.S.A.

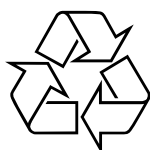

Free Manuals Download Website

<http://myh66.com>

<http://usermanuals.us>

<http://www.somanuals.com>

<http://www.4manuals.cc>

<http://www.manual-lib.com>

<http://www.404manual.com>

<http://www.luxmanual.com>

<http://aubethermostatmanual.com>

Golf course search by state

<http://golfingnear.com>

Email search by domain

<http://emailbydomain.com>

Auto manuals search

<http://auto.somanuals.com>

TV manuals search

<http://tv.somanuals.com>