

PHILIPS

AZ 8070 CD Radio Cassette Recorder

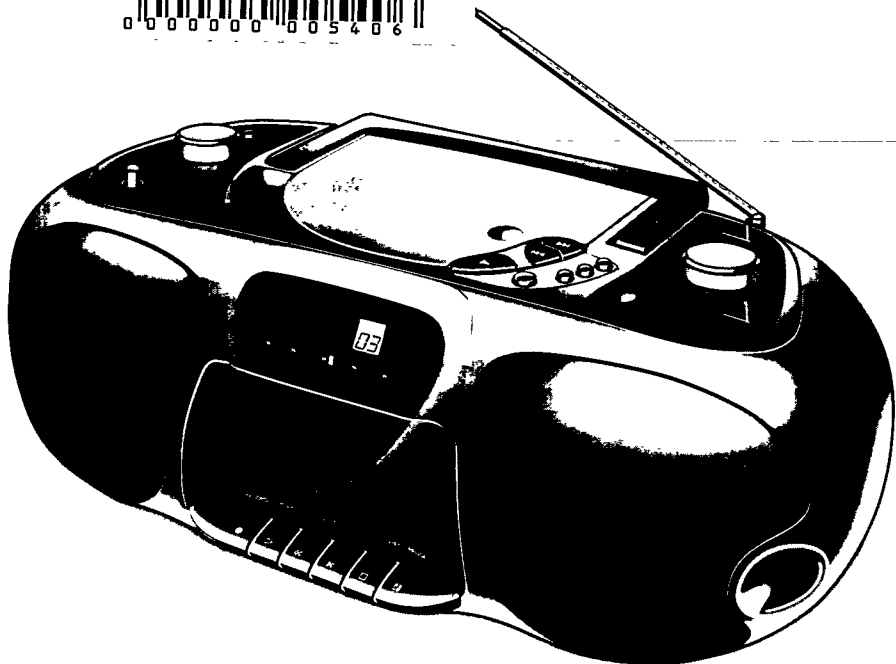

Instructions for use
Mode d'emploi
Instrucciones de manejo
Bedienungsanleitung
Gebruiksaanwijzing
Istruzioni per l'uso
Brugsanvisning
Bruksanvisning
Käyttöohje
Οδηγίες χρήσεως
Manual de utilização



PHILIPS

Norge

Typeskilt finnes på apparatens underside.

Observer: Nettbryteren er sekundert innkoplet. Den innebygde nettdelen er derfor ikke frakoplet nettet så lenge apparatet er tilsluttet nettkontakten.

For å redusere faren for brann eller elektrisk støt, skal apparatet ikke utsettes for regn eller fuktighet.

Italia

DICHIARAZIONE DI CONFORMITA'

Si dichiara che l'apparecchio Lettore CD/Radio-registratore mod. AZ 8070 Philips risponde alle prescrizioni dell'art. 2 comma 1 del D. M. 28 Agosto 1995 n. 548.

Fatto a Eindhoven, il 18/09/1996

Philips Sound & Vision
Philips, Glaslaan 2, SFF 10
5616 JB Eindhoven, The Netherlands

Important notes for users in the U.K.

Mains plug

This apparatus is fitted with an approved moulded 13 Amp plug. To change a fuse in this type of plug proceed as follows:

- 1 Remove fuse cover and fuse.
- 2 Fix new fuse which should be a BS1362 5 Amp, A.S.T.A. or BSI approved type.
- 3 Refit the fuse cover.

If the fitted plug is not suitable for your socket outlets, it should be cut off and an appropriate plug fitted in its place. If the mains plug contains a fuse, this should have a value of 5 Amp. If a plug without a fuse is used, the fuse at the distribution board should not be greater than 5 Amp.

Note: The severed plug must be disposed of to avoid a possible shock hazard should it be inserted into a 13 Amp socket elsewhere.

How to connect a plug

The wires in the mains lead are coloured with the following code: blue = neutral (N), brown = live (L). As these colours may not correspond with the colour markings identifying the terminals in your plug, proceed as follows.

- Connect the blue wire to the terminal marked N or coloured black.
- Connect the brown wire to the terminal marked L or coloured red.
- Do not connect either wire to the earth terminal in the plug, marked E (or \oplus) or coloured green (or green and yellow).

Before replacing the plug cover, make certain that the cord grip is clamped over the sheath of the lead - not simply over the two wires.

Copyright in the U.K.

Recording and playback of material may require consent. See Copyright Act 1956 and The Performer's Protection Acts 1958 to 1972.

English	Controls4 Power supply.....5 Basic Functions6 Radio6	CD player7-9 Cassette recorder ...10-11 Maintenance12 Troubleshooting.....13	English
Français	Commandes14 Alimentation.....15 Fonctions de base.....16 Radio16	Lecteur de CD17-19 Platine cassette.....20-21 Généralités22 Dépistage des pannes .23	Français
Español	Mandos24 Alimentación25 Funciones básicas.....26 Radio26	Lector de CD27-29 Platina de casete...30-31 Generalidades32 Localización de averías...33	Español
Deutsch	Bedienungselemente34 Stromversorgung35 Grundfunktionen36 Radio36	CD-Spieler.....37-39 Cassettenrecorder ...40-41 Allg. Informationen.....42 Fehlersuche43	Deutsch
Nederlands	Bedieningsorganen44 Stroomvoorziening45 Basisfuncties.....46 Radio46	CD-Speler.....47-49 Cassette recorder ...50-51 Algemene gegevens...52 Verhelpen van storingen...53	Nederlands
Italiano	Comandi54 Alimentazione55 Funzioni principali56 Radio56	Lettoce CD57-59 Deck cassetta60-61 Informazioni generali...62 Elenco ricerca guasti ...63	Italiano
Svenska	Kontroller64 Strömförsörjning.....65 Allmänna funktioner ...66 Radio66	CD-Spelaren67-69 Kassettspelaren.....70-71 Allmänt72 Felsökning73	Svenska
Dansk	Betjeningsknapper74 Strømforsyning75 Basisfunktioner76 Radio76	CD-afspilleren77-79 Kassette deck80-81 Generel information....82 Fejlsøgning.....83	Dansk
Suomi	Säätimet84 Käyttöjännite.....85 Perustoiminnot86 Radio86	CD-soitin87-89 Kassettidekki.....90-91 Yleistä92 Tarkistusluettelo.....93	Suomi
Έλληνας	Χειριστήρια94 Τροφοδοσία.....95 Βασικές λειτουργίες...96 ΔΕΚΤΗΣ96	ΦΟΡΗΤΟ CD97-99 ΚΑΣΕΤΟΦΩΝΑ...100-101 Γενικές πληροφορίες102 Διόρθωση βλαβών.....103	Έλληνας
Português	Comandos.....104 Alimentação105 Funções Básicas106 Radio.....106	Leitor de CDs107-109 Deck de cassetes 110-111 Informações gerais112 Avarias.....113	Português

CONTROLS

English

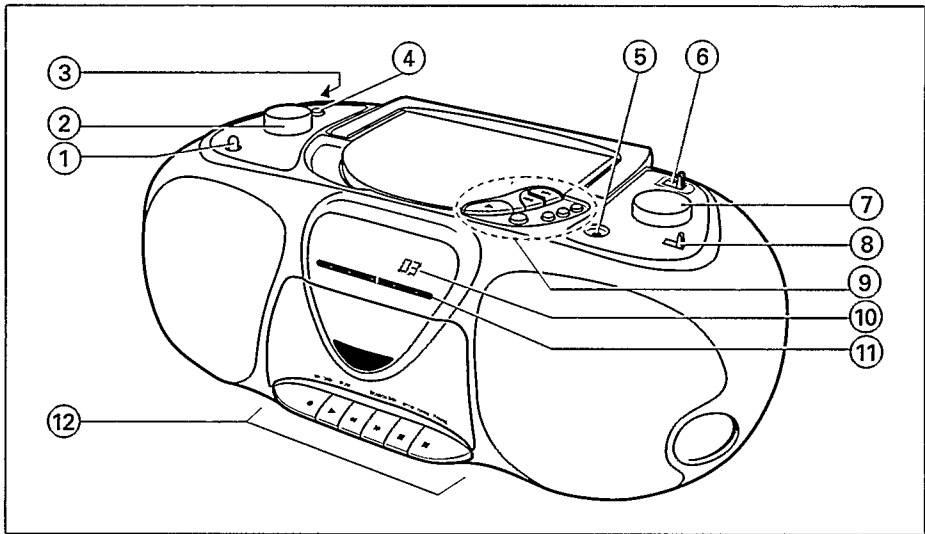

① **INCREDIBLE SURROUND**.....to create a variable phenomenal stereo effect

② **VOLUME**.....to adjust the volume level

③ (at the back)...3.5mm headphone socket.
Note: Inserting the plug will disconnect the speakers.

④ **DBB**Dynamic Bass Boost: to increase the bass level

⑤ **MIC**3.5mm microphone socket (see RECORDING)

⑥ **POWER ON**.....to select the sound source: CD-TAPE/OFF-RADIO

RADIO:

⑦ **TUNING**to tune to radio stations

⑧ **FM-MW-LW**.....to select the wave band

⑪ Indicator for radio tuning

CD PLAYER:

⑨ **OPEN-CLOSE**to open/close the CD lid
PLAY-PAUSE ►to start and to interrupt CD play

SEARCH ◀◀▶▶.....to skip and to search forwards and backwards

STOP ■to stop play and to erase a program

SHUFFLEto play in random order

REPEAT.....to repeat one track or to repeat the CD or program

PROG.....to program track numbers and to review the program

⑩ CD Display

CASSETTE RECORDER:

⑫ **RECORD** ●to start recording

PLAY ►to start playback

◀◀.....to rewind the tape

▶▶.....to wind the tape

STOP-OPEN ■to stop the tape and to open the cassette compartment

PAUSE ||to interrupt recording or playback

Batteries, R20 UM1 or D cells

- Open the battery compartment and insert six batteries, type R20, UM-1 or D-cells (preferably alkaline).
- Remove the batteries if they are empty or the set is not to be used for a long time.

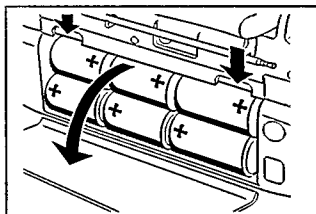

Mains

- 1 Check if the mains voltage as shown on the type plate (on the base of the set) corresponds to your local mains voltage. If it does not, consult your dealer or service organisation.

If the set is equipped with a VOLTAGE selector (⊗), set this selector to the local mains voltage.
- 2 Connect the mains lead to the MAINS outlet and the wall socket. The mains supply is switched on.

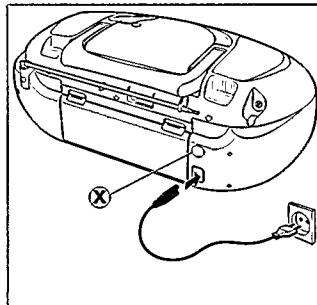

- The battery supply is switched off when the set is connected to the mains. To change over to battery supply, pull out the plug from the unit's MAINS socket.
- To disconnect the set from the mains completely, withdraw the mains plug from the wall socket.
- **For users in the U.K.:** please follow the instructions on page 2.

The typeplate is located on the base of the set.

Environmental information

All redundant packaging material has been omitted. We have done our utmost to make the packaging easy separable into three mono materials: cardboard (box), expandable polystyrene (buffer) and polyethylene (bags, protective foam sheet).

Your set consists of materials which can be recycled if disassembled by a specialized company. Please observe the local regulations regarding the disposal of packing materials, exhausted batteries and old equipment.

Switching on and off/standby

- Set the POWER ON selector to the desired sound source: CD - TAPE/OFF - RADIO.
- The set is switched off when the POWER ON selector is in position TAPE/OFF and the recorder keys are released.
- In order to switch off the power supply, remove the mains plug.

Note: When operating the set with batteries, always be sure to set the POWER ON selector to position TAPE/OFF when the set is not used. This will avoid a permanent power consumption.

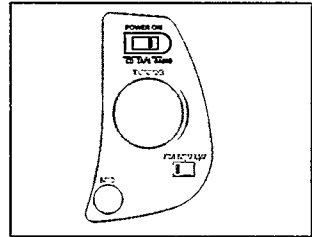

Adjusting volume and sound

- Adjust the sound using the controls VOLUME and DBB and INCREDIBLE SURROUND.
- Use the rotary knob to in- or decrease the phenomenal stereo sound. The surround effect varies from 0% to 100%.
- The bass frequencies can also be emphasised if you place the set against a wall or bookshelf. (Do not cover any vents and leave sufficient room around the unit for ventilation.)

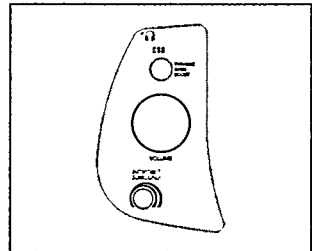

RADIO – tuning to radio stations

- 1 Set the POWER ON selector to RADIO.
- 2 Select the wave band by using the selector FM-MW-LW.
- 3 Tune to the desired radio station by using the TUNING knob.

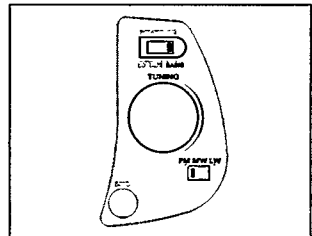

Improving the RADIO reception

- For **FM**, pull out the telescopic antenna. To improve the FM signal, incline and turn the antenna. Reduce its length if the signal is too strong (very close to a transmitter).
- For **MW** and **LW**, direct the built-in antenna by turning the whole set. The telescopic antenna is not needed.

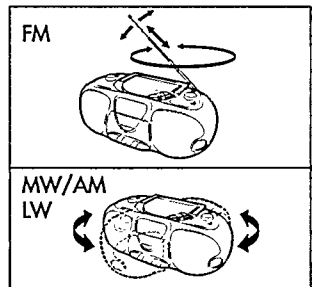

Playing a CD

- 1 Set the POWER ON selector to CD.
 - 2 Open the lid by pressing the OPEN-CLOSE button.
 - 3 Insert an audio CD (printed side up) and close the lid.
 - The CD player starts and scans the contents list of the CD.
 - After that, the total number of tracks appear on the display and the CD player stops.
 - 4 Press the PLAY-PAUSE ► button to start CD play.
 - Display indication: the current track number.
 - 5 Press the STOP ■ button to stop CD play.
 - Display indication: the total number of tracks.
- You can interrupt CD play by pressing PLAY-PAUSE ►. Continue CD play by pressing the button again.
 - Display indication: the current track number flashes.

Note: CD play will also stop

- if you open the lid;
- if you move the POWER ON selector or
- if the end of the CD is reached.

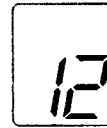
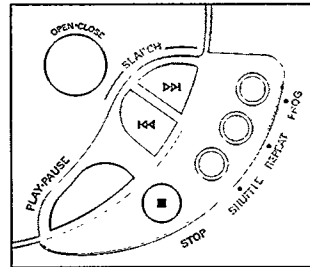

Example
Display indication in stop or play mode: the total or current track number.



Example
Display indication in pause position: the current track number flashes.



Display indication: when the CD lid is open.

SEARCH backwards ◀◀ and forwards ▶▶

Selecting another track

- Briefly press the SEARCH ◀◀ or ▶▶ button once/several times to skip to the beginning of the current/previous or subsequent track(s).
 - Display indication: the selected track number.
 - During play: CD play continues automatically with the selected track.
 - In stop position: press PLAY-PAUSE ► to start CD play.

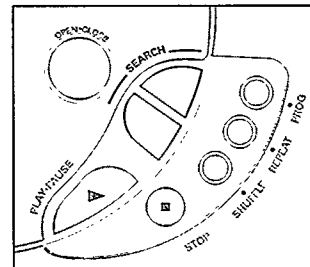

Searching for a passage during CD play

- 1 Hold down the SEARCH ◀◀ or ▶▶ button to find a particular passage in forwards or backwards direction.
 - CD play continues at a low volume.
- 2 Release the button when you have reached the desired passage.

Note: In the SHUFFLE and in REPEAT-1 mode and when playing a program, searching is only possible within the particular track.

CD PLAYER

English

SHUFFLE – playing in random order

- 1 Press SHUFFLE before or during CD play.
→All the tracks will now be played in a random order.
- 2 To return to normal CD play, press SHUFFLE.

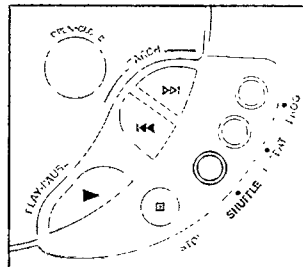

REPEAT – Repeating the entire CD or one track of the CD

- 1 Before or during CD play, press repeatedly REPEAT to cause the display showing the different repeating modes.
 - REPEAT: the current track is played repeatedly.
 - REPEAT ALL: the entire CD or program is played repeatedly.
- 2 To return to normal CD play, press REPEAT until the display indication disappears.

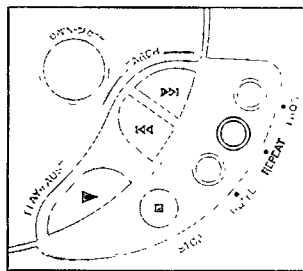

*Note: You can activate the different playing modes at the same time, e.g. to **repeatedly** play the entire CD or program in **random order** (REPEAT ALL/SHUFFLE).*



Example
Display indication when the respective playing mode is activated.

Programming track numbers

You may select a number of tracks and store these in the memory in the desired sequence. You may store any track more than once. At most, 20 tracks can be stored in the memory.

- 1 Select with SEARCH ◀◀ or ▶▶ the desired track.
- 2 As soon as the desired track is displayed, press the PROG button to store the track in the memory.
 - On the display PROGRAM appears and P lights briefly up.
 - After that the stored track number is shown.
- 3 Select and store in this way all desired tracks.

- You can review your settings by pressing the PROG button for more than 2 seconds.
 - The display shows in sequence all stored track numbers.

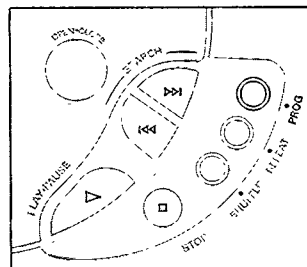

Display indication:
when you store a track.



Display indication
when you try to store
more than 20 tracks.

Playing the program

- If you have selected the tracks in the STOP position, press PLAY-PAUSE ▶.
- If you have selected the tracks during CD play, press first STOP ■ and then press PLAY-PAUSE ▶.



Example
Display indication when
you play the program.

Erasing the program from the STOP position

- From the stop position, press STOP ■.
 - PROGRAM disappears on the display and your program is erased.



Display indication when
you erase a program.

Note: The program will also be erased

- if you interrupt the power supply;
- if you open the lid or
- if you move the POWER ON selector.

CASSETTE RECORDER

English

Playing a cassette

- 1 Set the POWER ON selector to TAPE.
- 2 Press STOP-OPEN ■ to open the cassette compartment.
- 3 Insert a recorded cassette with the open side downwards.
- 4 Press PLAY ► to start playback.
- 5 By pressing ◀▶ fast winding of the tape is possible in both directions.
- 6 To stop the tape, press STOP-OPEN ■.

Note: The keys are automatically released at the end of the tape.

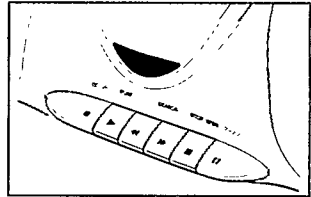
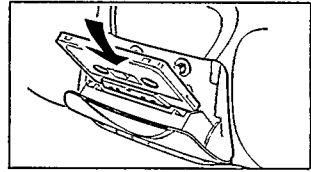

General information on recording

- Recording is permissible insofar as copyright or other rights of third parties are not infringed.
- For recording on this set you should use a cassette of the type "NORMAL" (IEC type I). This deck is not suited for recording on cassettes of the type "CHROME" (IEC II) or "METAL" (IEC IV).
- The recording level is set automatically. The controls VOLUME and DBB or INCREDIBLE SURROUND do not affect the recording.
- At the very beginning and end of the tape, no recording will take place during the 7 seconds when the leader tape passes the recorder heads.

Protecting tapes from accidental erasure

- Keep the cassette side to be safeguarded in front of you and break out the left tab. Now, recording on this side is no longer possible.
- To render this safeguard ineffective, cover the aperture with a piece of adhesive tape.

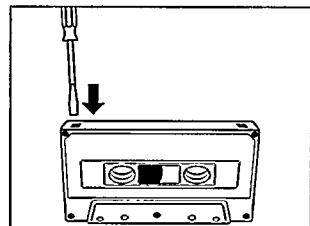

CASSETTE RECORDER

English

CD synchro start – recording from the CD player

- 1 Set the POWER ON selector to CD.
- 2 Insert a CD and if desired, program track numbers.
- 3 Press STOP-OPEN ■ to open the cassette compartment.
- 4 Insert a blank cassette with the open side downwards.
- 5 Press RECORD ● to start recording.
→ Playing of the CD or program starts automatically.
It is not necessary to start the CD player separately.
- 6 For brief interruptions, press PAUSE ■■.
To resume recording, press the key once more.
- 7 To stop recording, press STOP-OPEN ■.

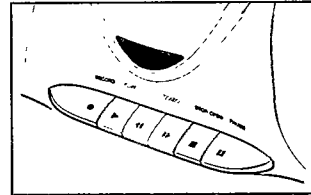
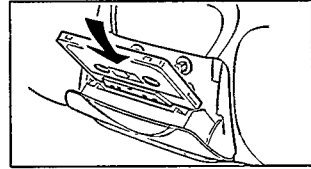

Note: The recording can be started from different positions:
- if the CD player is in the PAUSE position, recording will start from this very position (use SEARCH ◀◀ or ▶▶);
- if the CD player is in the STOP position, recording will start from the beginning of the CD or program.

Recording from the radio or with the microphone

- 1 Set the POWER ON selector to TAPE or RADIO.
- 2 Prepare the sound source for recording:
RADIO: Tune to a radio station.
TAPE (microphone): Connect a microphone with a 3.5mm plug to the MIC socket. Set the VOLUME control to zero (monitoring during microphone recording is not possible).
- 3 Press STOP-OPEN ■ to open the cassette compartment.
- 4 Insert a blank cassette with the open side downwards.
- 5 Press RECORD ● to start recording.
- 6 For brief interruptions, press PAUSE ■■.
To resume recording, press the key once more.
- 7 To stop recording, press STOP-OPEN ■.

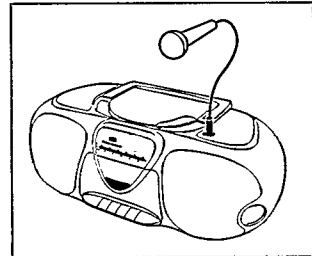

Note: When recording from the radio or a CD, you can connect a microphone and mix the sounds. Otherwise, be sure there is no microphone connected that could disturb your recording.

GENERAL INFORMATION

General maintenance

- Do not expose the set, batteries, CDs or tapes to humidity or rain, sand or to excessive heat caused by heating equipment or direct sunlight.
- The mechanical parts of the set contain self-lubricating bearings and must not be oiled or lubricated !
- You can clean the set with a soft, slightly dampened chamois leather. Do not use any cleaning agents as they may have a corrosive effect.

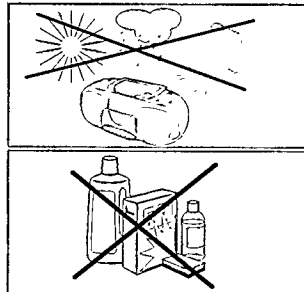

Tape deck maintenance

To ensure a good recording and playback quality of the tape deck, clean the parts (A)(B)(C) after approx. 50 hours of operation. Use a cotton bud slightly moistened with alcohol or a special head cleaning fluid.

- Press PLAY and clean the rubber pressure rollers (C).
- Press PAUSE and clean the capstans (B) and the heads (A).

Note: Cleaning of the heads (A) can also be done by playing a cleaning tape through once.

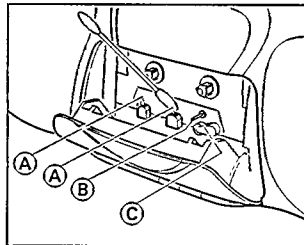

CD player and CD handling

- The lens (X) of the CD player should never be touched!
- The lens may cloud over when the set is suddenly moved from cold to warm surroundings. Playing a CD is then not possible. Leave the CD player in a warm environment until the moisture evaporates.
- To take the CD out of its box easily, press the centre spindle while lifting the CD.
- Always pick up the CD by the edge and put it back in its box after use.
- To clean the CD, wipe it off in a straight line from the center towards the edge using a soft, lint-free cloth. A cleaning agent may damage the disc!
- Never write on a CD or attach any sticker to it.

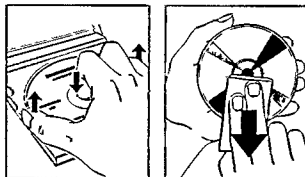
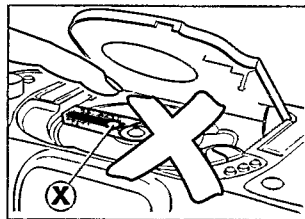

This set complies with the radio interference requirements of the European Community.

TROUBLESHOOTING

English

- If a fault occurs, first check the points listed below before taking the set for repair.
- If you are unable to remedy a problem by following these hints, consult your dealer or service centre.

WARNING:

Under no circumstances should you try to repair the set yourself, as this will invalidate the guarantee.

PROBLEM	POSSIBLE CAUSE	SOLUTION
No sound / no power	VOLUME is not adjusted	Adjust the VOLUME
	Headphones are connected	Disconnect headphones
	Mains lead is not securely connected	Connect the AC power lead properly
	Batteries are exhausted	Insert fresh batteries
	Batteries are incorrectly inserted	Insert the batteries correctly
	Changing over from mains to battery supply	Pull out the mains plug from the unit's MAINS socket
Distorted sound	VOLUME too high, INCREDIBLE SURROUND effect not adjusted	Reduce VOLUME, adjust INCREDIBLE SURROUND effect
No reaction to operation of any keys	Electrostatic discharge	Disconnect the set from power supply reconnect it after a few sec
Poor radio reception	Interference caused by the vicinity of electrical equipment like TVs, video recorders, computers, thermostats, fluorescent lamps (TL), engines, etc.	Keep the radio away from electrical equipment
"E" or "no" indication	CD is badly scratched or dirty	Replace or clean the CD, see maintenance
	CD inserted upside down	Insert a CD with label upwards
	Laser lens is steamed up	Wait until the lens has acclimatized
The CD skips tracks	CD is damaged or dirty	Replace or clean the CD
	SHUFFLE or PROGRAM is active	Switch off SHUFFLE or PROGRAM play
Poor cassette sound quality	Dust and dirt on the heads, capstan or pressure roller	Clean the heads, capstan and pressure roller, see maintenance
	Use of not suited cassette types (METAL or CHROME)	Only use NORMAL cassettes (IEC I) for recording
Recording does not work	Cassette tab(s) may be broken out	Apply a piece of adhesive tape over the missing tab space



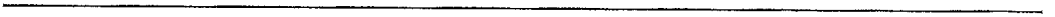



English

Français

Español

Deutsch

Nederlands

Italiano

Svenska

Dansk

Suomi

Ελληνικά

Português

**CLASS 1
LASER PRODUCT**

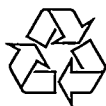

3103 306 15783

VieCHC9650

Free Manuals Download Website

<http://myh66.com>

<http://usermanuals.us>

<http://www.somanuals.com>

<http://www.4manuals.cc>

<http://www.manual-lib.com>

<http://www.404manual.com>

<http://www.luxmanual.com>

<http://aubethermostatmanual.com>

Golf course search by state

<http://golfingnear.com>

Email search by domain

<http://emailbydomain.com>

Auto manuals search

<http://auto.somanuals.com>

TV manuals search

<http://tv.somanuals.com>