

DVD Player/ Recorder

DVDR3400

User Manual

Thank you for choosing Philips.

Need help fast?

Read your Quick Use/Start Guide and/or User Manual first for quick tips that make using your Philips product more enjoyable.

*If you have read your instructions and still need assistance, you may access our online help at **www.philips.com/support***



VIDEO *Plus+*

PHILIPS

Important notes for users in the U.K. Mains plug

This apparatus is fitted with an approved 13 Amp plug. To change a fuse in this type of plug proceed as follows:

- 1 Remove fuse cover and fuse.
- 2 Fix new fuse which should be a BS1362 5 Amp, A.S.T.A. or BSI approved type.
- 3 Refit the fuse cover.

If the fitted plug is not suitable for your socket outlets, it should be cut off and an appropriate plug fitted in its place. If the mains plug contains a fuse, this should have a value of 5 Amp. If a plug without a fuse is used, the fuse at the distribution board should not be greater than 5 Amp.

Note: The severed plug must be disposed of to avoid a possible shock hazard should it be inserted into a 13 Amp socket elsewhere.

How to connect a plug

The wires in the mains lead are coloured with the following code: blue = neutral (N), brown = live (L).

- As these colours may not correspond with the colour markings identifying the terminals in your plug, proceed as follows:
 - Connect the blue wire to the terminal marked N or coloured black.
 - Connect the brown wire to the terminal marked L or coloured red.
 - Do not connect either wire to the earth terminal in the plug, marked E (or e) or coloured green (or green and yellow).

Before replacing the plug cover, make certain that the cord grip is clamped over the sheath of the lead - not simply over the two wires.

Copyright in the U.K.

Recording and playback of material may require consent. See Copyright Act 1956 and The Performer's Protection Acts 1958 to 1972.

Italia DICHIARAZIONE DI CONFORMITA'

Si dichiara che l'apparecchio DVDR3400, Philips risponde alle prescrizioni dell'art. 2 comma 1 del D.M. 28 Agosto 1995 n. 548.

Fatto a Eindhoven

Philips Consumer Electronics
Philips, Glaslaan 2
5616 JB Eindhoven, The Netherlands

Norge

Typeskilt finnes på apparatens underside.

Observer: Nettbryteren er sekundert innkoplet. Den innebygde nettdelen er derfor ikke frakoplet nettet så lenge apparatet er tilsluttet nettkontakten.

For å redusere faren for brann eller elektrisk støt, skal apparatet ikke utsettes for regn eller fuktighet.

For Customer Use:

Read carefully the information located at the bottom or rear of your DVD Recorder and enter below the Serial No. Retain this information for future reference.

Model No. DVD RECORDER
DVDR3400

Serial No. _____

DK

Advarsel: Usynlig laserstråling ved åbning når sikkerhedsafbrydere er ude af funktion. Undgå udsættelse for stråling.

Bemærk: Netafbryderen er sekundært indkoblet og afbryder ikke strømmen fra nettet. Den indbyggede netdel er derfor tilsluttet til lysnettet så længe netstikket sidder i stikkontakten.

S

Klass I laserapparat

Varning! Om apparaten används på annat sätt än i denna bruksanvisning specificerats, kan användaren utsättas för osynlig laserstrålning, som överskrider gränsen för laserklass I.

Observera! Stömbrytaren är sekundärt kopplad och bryter inte strömmen från nätet. Den inbyggda nätdelen är därför ansluten till elnätet så länge stickproppen sitter i vägguttaget.

SF

Luokan I laserlaite

Varoitus! Laitteen käyttäminen muulla kuin tässä käyttöohjeessa mainitulla tavalla saattaa altistaa käyttäjän turvallisuusluokan I ylittävälle näkymättömälle lasersäteilylle.

Oikeus muutoksiin varataan. Laite ei saa olla alttiina tippu- ja roiskevedelle.

Huom. Toiminnanvalitsin on kytketty toisiopuolelle, eikä se kytke laitetta irti sähköverkosta. Sisäänrakennettu verkko-osa on kytkettynä sähköverkkoon aina silloin, kun pistoke on pistorasiasassa.

CAUTION

VISIBLE AND INVISIBLE LASER RADIATION WHEN OPEN. AVOID EXPOSURE TO BEAM

ADVARSEL

SYNLIG OG USYNLIG LASERSTRÅLING VED ÅBNING UNDGÅ UDSÆTTELSE FOR STRÅLING

VARNING

SYNLIG OCH OSYNLIG LASERSTRÅLNING NÄR DENNA DEL ÄR ÖPPNAD BETRakta EJ STRÅLEN

VARO!

AVATTAESSA OLET ALTTIINA NÄKYVÄLLE JA NÄKYMÄTTÖMÄLLE LASER SÄTEILYLLE. ÄLÄ KATSO SÄTEESEEN

VORSICHT

SICHTBARE UND UNSICHTBARE LASERSTRAHLUNG WENN ABDECKUNG GEÖFFNET NICHT DEM STRAHL AUSSETZEN

ATTENTION

RAYONNEMENT LASER VISIBLE ET INVISIBLE EN CAS D'OUVERTURE EXPOSITION DANGEREUSE AU FAISCEAU

Disposal of your old product



Your product is designed and manufactured with high quality materials and components, which can be recycled and reused.

When this crossed-out wheeled bin symbol is attached to a product it means the product is covered by the European Directive 2002/96/EC.

Please inform yourself about the local separate collection system for electrical and electronic products.

Please act according to your local rules and do not dispose of your old products with your normal household waste. The correct disposal of your old product will help prevent potential negative consequences for the environment and human health.

'CONSUMERS SHOULD NOTE THAT NOT ALL HIGH DEFINITION TELEVISION SETS ARE FULLY COMPATIBLE WITH THIS PRODUCT AND MAY CAUSE ARTIFACTS TO BE DISPLAYED IN THE PICTURE. IN CASE OF 525 OR 625 PROGRESSIVE SCAN PICTURE PROBLEMS, IT IS RECOMMENDED THAT THE USER SWITCH THE CONNECTION TO THE 'STANDARD DEFINITION' OUTPUT. IF THERE ARE QUESTIONS REGARDING OUR TV SET COMPATIBILITY WITH THIS MODEL 525p AND 625p DVD PLAYER, PLEASE CONTACT OUR CUSTOMER SERVICE CENTER.'

Due to the inconsistency of disc formats provided by various disc manufacturers, your DVD system/ player/recorder may require a playability enhancement or upgrade. As DVD technology advances, these enhancement will become common and will be easy to complete. Go to www.philips.com/support for software upgrade.

En raison de la diversité des formats utilisés par les fabricants, votre système DVD peut nécessiter l'ajout de périphériques ou une mise à niveau logicielle. Au fur et à mesure des progrès de la technologie DVD, ces périphériques se font de plus en plus courants et aisés à intégrer. Pour télécharger la mise à niveau logicielle, visitez le site www.philips.com/support.

Debido a los diferentes formatos de discos disponibles en el mercado, es posible que deba realizar mejoras o actualizaciones en el sistema de DVD relativas a las funciones de reproducción. Conforme la tecnología DVD avanza, estas mejoras estarán al alcance de todo tipo de usuarios y se podrán llevar a cabo fácilmente. Visite la página "www.philips.com/support" para buscar información sobre actualizaciones de software.

Da das Disk-Format je nach Hersteller verschieden ist, ist für Ihr DVD-System möglicherweise die Erweiterung der Spielbarkeit oder eine Aktualisierung erforderlich. Da die DVD-Technologie sich ständig weiterentwickelt, werden sich diese Erweiterungen durchsetzen und einfach auszuführen sein. Gehen Sie zu für Ihre Software-Aktualisierung zu „www.philips.com/support“.

Doordat fabrikanten verschillende schijfindeligen aanbieden, moet uw dvd-systeem mogelijk worden geüpgradet of uitgebreid. Naarmate de dvd-technologie zich verder ontwikkelt, zullen deze uitbreidingen normaal worden en zult u ze gemakkelijk kunnen uitvoeren. Ga naar "www.philips.com/support" om uw software te upgraden.

A causa della differenza di formato tra i dischi forniti dai vari produttori, il sistema DVD potrebbe richiedere un potenziamento o aggiornamento della riproducibilità. Col progredire della tecnologia DVD, questi potenziamenti diverranno comuni e facili da implementare. Visitare "www.philips.com/support" per scaricare gli aggiornamenti del software.

På grund af uoverensstemmelser mellem diskformater fra de forskellige diskproducenter, kan dit dvd-system kræve en afspilningsudvidelse eller en opgradering. Efterhånden som dvd-teknologien udvikles, vil disse udvidelser blive almindelige og vil være nemme at implementere. Gå til "www.philips.com/support", hvis du ønsker softwareopgradering.

Koska eri levyvalmistajat käyttävät erilaisia levyformaatteja, DVD-järjestelmäsi toimintoja täytyy ehkä laajentaa tai päivittää. DVD-teknikaan kehittyessä nämä laajennukset yleistyvät ja ovat helposti toteutettavissa. Löydät ohjelmistopäivityksen sivustosta "www.philips.com/support".

Devido à inconsistência dos formatos de disco disponibilizados por vários fabricantes de discos, a capacidade de reprodução do seu sistema de DVD pode necessitar de ser melhorada ou atualizada. À medida que a tecnologia do DVD avança, estes melhoramentos tornam-se comuns e fáceis de completar. Visite "www.philips.com/support" para obter atualizações de software.

Λόγω της ασυνέπιας στην διαμόρφωση των δίσκων που παρέχονται από διάφορους κατασκευαστές δίσκων, το σύστημα DVD που χρησιμοποιεί νδεχται να απαιτεί βελτίωση ή αναβάθμιση της δυνατότητας αναπαραγωγής. Καθώς εξίσταται η τεχνολογία των DVD, οι βελτιώσεις αυτές θα είναι συνηθισμένες και θα είναι ύκολο να ολοκληρωθούν. Μπαρίτ στη διύθυνση "www.philips.com/support" για αναβάθμιση λογισμικού.

Ze względu na niekompatybilność formatów płyt oferowanych przez rozmaitych producentów, Twój system DVD może wymagać rozbudowy lub aktualizacji oprogramowania. W miarę zaawansowania technologii DVD możliwości tego rodzaju rozbudowy staną się powszechne i proste w realizacji. Odwiedź stronę "www.philips.com/support" aby pobrać aktualizację oprogramowania.

Из-за несовместимости форматов дисков различных производителей для вашей системы DVD может быть необходимо произвести обновления или улучшить воспроизводимость. С развитием технологии DVD эти улучшения станут широкоиспользуемыми и просто выполняемыми. Обновление программного обеспечения находится на вб-сайт "www.philips.com/support".



This product incorporates copyright protection technology that is protected by US patents. Use of this copyright protection technology must be authorised by Macrovision, and is intended for home and other limited viewing uses only unless otherwise authorised by Macrovision. Reverse engineering or disassembly is prohibited.

U.S. Patent Number 4,631,603; 4,819,098; 4,907,093; 5,315,448; and 6,516,132



Manufactured under license from Dolby Laboratories. "Dolby" and the double-D symbol are trademarks of Dolby Laboratories.



VIDEO Plus+® and PlusCode are registered trademarks of Gemstar Development Corporation. The VIDEO Plus+® system is manufactured under license from Gemstar Development Corporation.



DivX®, DivX Certified, and associated logos are trademarks of DivX Networks, Inc and are used under license.

HDMI

HDMI, and HDMI logo and High-Definition Multimedia Interface are trademarks or registered trademarks of HDMI licensing LLC.

This product complies with the radio interference requirements of the European Community.



This product complies with the requirements of the following directives and guidelines: 73/23/EEC + 89/336/EEC + 93/68/EEC

LASER

Type	Semiconductor laser InGaAlP (DVD) AlGaAs (CD)
Wave length	658 nm (DVD) 790 nm (CD)
Output Power	30 mW (DVD+RW write) 1.0 mW (DVD read) 1.0 mW (CD read)
Beam divergence	84 degrees (DVD) 61 degrees (CD)

Table of Contents

General

Care and Safety Information	8
Setup precautions.....	8
Cleaning discs	8
About recycling.....	8
Product Information	9
Introduction.....	9
Accessories supplied	9
Region codes.....	9
Copyright notice.....	9
Special Features.....	10

Product Overview

Main Unit	11
Remote Control	12
Using the remote control	14

Connections

Step 1: Basic Recorder Connections.....	15
Connecting the aerial cables	15
Connecting the video cable.....	16
Connecting the audio cables	18
Step 2: Optional Connections.....	19
Connecting to a Cable Box or Satellite Receiver	19
Connecting to a VCR or other similar device.....	20
Connecting to a VCR and Cable Box/Satellite Receiver.....	21
Connecting a camcorder to the front sockets	22
Connecting a USB flash drive or USB memory card reader.....	23
Step 3: Installation and Setup.....	24
Finding the correct viewing channel	24
Setting the OSD language.....	24
Select the country of your residence	25
Setting your TV channel programmes.....	25
Setting the date & time.....	26

Recording

Recording	27
Discs for recording	27
Recording settings	28
RECORD settings	29
Recording from various sources	30
Archiving from a USB flash drive or USB memory card reader	32
Instant time-off recording.....	33
Watching another TV programme during recording	33
Timer Recording.....	34
About timer recording.....	34
Timer recording (VIDEO Plus+® System)	34
Timer recording (manually).....	35
Changing/ Deleting a timer recording.....	37

Table of Contents

Playback

Playback	38
Playable discs	38
Starting disc playback.....	39
Additional Playback Features	43
Changing to another chapter/track.....	43
Pausing playback	43
Searching forwards/backwards	43
Using the TOOLS options	44

Edit Recordings

Editing/ Finalising Recording	47
About disc editing	47
Accessing disc editing menu	47
Playing your recordings on other DVD players (DVD±R only)	49
About title editing.....	50
Accessing title editing menu.....	50
About video editing	52
Accessing video editing menu.....	52

Other Information

DVD Setup Menu Options	55
Accessing the Setup Menu	55
GENERAL settings	56
PLAYBACK settings.....	57
DVD settings	59
CHANNEL SETUP settings	61
CLOCK settings.....	63
Software Upgrade	64
Installing the latest software	64
Specifications	65
Troubleshooting	66
Frequently Asked Questions	70
Glossary	72
Display panel symbols/ messages	74
TV System Guide	76

Care and Safety Information

CAUTION!

High voltage! Do not open the device. You run the risk of getting an electric shock.

The machine does not contain any user-serviceable parts. Please leave all maintenance work to qualified personnel.

Setup precautions

Finding a suitable location

- Place the set on a flat, hard and stable surface. Do not place the set on a carpet.
- Do not position the set on top of other equipment that might heat it up (e.g., receiver or amplifier).
- Do not put anything above or under the set (e.g., CDs, magazines).
- Install this unit near the AC outlet and where the AC power plug can be reached easily.

Space for ventilation

- Place the apparatus in a location with adequate ventilation to prevent internal heat build up. Allow at least 10 cm (4") clearance from the rear and the top of the set and 5cm (2") from the left and right to prevent overheating.

Avoid high temperatures, moisture, water and dust

- Apparatus shall not be exposed to dripping or splashing.
- Do not place any sources of danger on the apparatus (e.g., liquid filled objects, lighted candles).

Cleaning discs

Some problems occur (frozen picture, sound disruptions, picture distortions) because the disc inside the unit is dirty. To avoid these problems, discs should be cleaned on a regular basis.

To clean a disc, use a micro fibre cleaning cloth and wipe the disc from the center to the edge in a straight line.

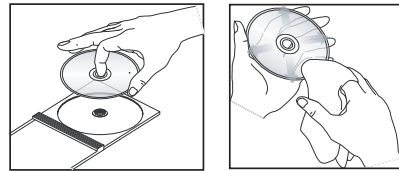

CAUTION!

Do not use solvents such as benzene, thinner, commercially available cleaners, or anti-static sprays intended for discs.

Since the optical unit (laser) of the recorder operates at a higher power than regular DVD or CD players, cleaning CDs intended for DVD or CD players may damage the optical unit (laser). Therefore, refrain from using a cleaning CD.

About recycling

These operating instructions have been printed on non-polluting paper. This electronic equipment contains a large number of materials that can be recycled. If you are disposing of an old machine, please take it to a recycling center. Please observe the local regulations regarding disposal of packaging materials, exhausted batteries, and old equipment.

Product Information

Introduction

Your Philips recorder allows you to record TV programmes or duplicate camcorder recordings to a DVD±RW or DVD±R and play pre-recorded DVDs.

The recordings you make with this recorder will playback on DVD players and DVD-ROM drives. DVD±R discs have to be finalised before they can be played back on other DVD players.

Before you start using this recorder, complete the basic connections and set-up in three easy steps.

Step 1: Basic recorder connections

Step 2: Optional connections for other devices

Step 3: Basic installation and set-up

Please take time to read this user manual before using your recorder. It contains important information and notes regarding operations of the recorder.

Helpful Hints:

- If you have questions or if problems occur during operation, see the chapter 'Troubleshooting'.
- If you need further assistance, please call the customer support service for your country. The corresponding telephone numbers and e-mail addresses are given in the guarantee booklet.
- Refer to the type plate on the rear or bottom of the product for identification and supply ratings.

Accessories supplied

- Remote control and batteries
- SCART cable
- RF coaxial cable
- Quick Start Guide

Region codes

DVD films are usually not released at the same time in all regions of the world, thus all DVD players are keyed to a specific region code.

This device will only play **Region 2** DVDs or DVDs manufactured to be played in all regions ('ALL'). DVDs from other regions cannot be played on this recorder.



Copyright notice

The making of unauthorised copies of copy-protected material, including computer programmes, files, broadcasts and sound recordings, may be an infringement of copyrights and constitute a criminal offence. This equipment should not be used for such purposes.

Product Information (continued)

Special Features

VIDEO Plus+®

This is a simple programming system for recorders. To use it, enter the programming number associated with your television programme. You can find this number in your favourite listings magazine.

VIDEO Plus+® and PlusCode are registered trademarks of Gemstar Development Corporation. The VIDEO Plus+® system is manufactured under license from Gemstar Development Corporation.



i.Link is also known as 'FireWire' and 'IEEE1394'. This connection is used for the transfer of high bandwidth digital signals as used by digital video (DV) camcorders. It carries all audio and video signals via a single cable.

HDMI

HDMI (High-Definition Multimedia Interface) is a high-speed digital interface that can transmit uncompressed high definition video and digital multichannel audio. It delivers perfect picture and sound quality, completely free from noise. HDMI is fully backward-compatible with DVI.



'Copy USB to DVD'

This function allows you to copy your content in your USB flash drive/USB memory card reader to a recordable DVD disc.



A surround sound system developed by Dolby Laboratories containing up to six channels of digital audio



The DivX code is a video codec developed by DivX Networks Inc., that compresses digital video to small sizes while retaining relatively high visual quality.



Philips DVD recorders support 'dual media' recording – the ability to create recordings on + and - discs (DVD+R/+RW, DVD+R DL, DVD-R/-RW).

Main Unit

English

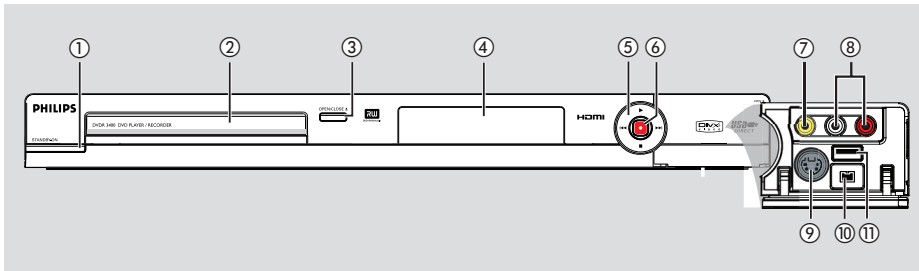

① STANDBY-ON

- Turns on the recorder or switch to standby mode.

② Disc tray

③ OPEN/CLOSE ▲

- Opens/closes the disc tray.

④ System display panel

- Show information about the current status of the recorder.

⑤ ◀◀ (PREV) / ▶▶ (NEXT)

- Go to the previous/next chapter or track. Press and hold to make a forward/reverse search.

▶ (PLAY)

- Plays a disc.

■ (STOP)

- Stops playback/recording.

⑥ ● (RECORD)

- Starts recording the current TV channel or the current video input source.
- Press repeatedly to set up a One Touch Recording at 30, 60 or 90 minutes interval.

Sockets behind the flap

Flip down the door as indicated by the **OPEN ▶** label at the right hand corner.

⑦ VIDEO

- Video input for camcorders or video recorders.

Press **SOURCE** on the remote control to select 'CAM1' in order to view the input source.

⑧ L/R AUDIO

- Audio input for camcorders or video recorders.

⑨ S-VIDEO

- S-video input for SVHS/Hi8 camcorders or SVHS/Hi8 video recorders.

Press **SOURCE** on the remote control to select 'CAM2' in order to view the input source

⑩ DV IN

- Input for digital camcorders or other suitable devices using this connector. Press **SOURCE** on the remote control to select 'DV' in order to view the input source.

⑪ USB

- Input for USB flash drive/ USB memory card reader.

Press **USB** to view the contents of the USB flash drive/ USB memory card reader.

Remote Control

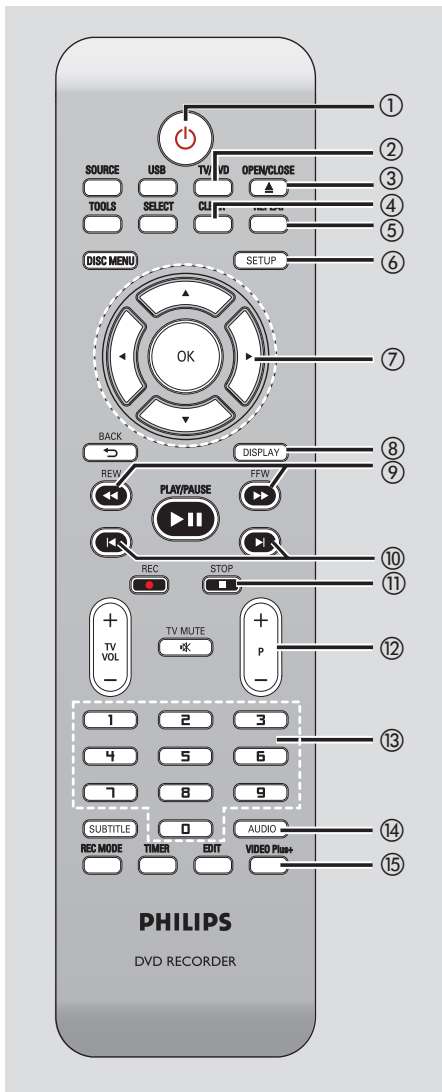

- ① **Power**
– Turns on the recorder or switch to standby mode.
- ② **TV/DVD**
– Switch between playback from the additional devices (connected via EXT2 AUX I/O socket) and playback from the recorder.

- ③ **OPEN/CLOSE ▲**
– Opens/closes the disc tray.
- ④ **CLEAR**
– Clears a track/file in the selection playlist/copylist.
– Clears a timer entry.
- ⑤ **REPEAT**
– Repeat playback of title, chapter, track or disc in DVD mode.
- ⑥ **SETUP**
– Enters/exits the setup menu.
- ⑦ **◀▶** : Cursor buttons for moving to the left or right, do a forward/reverse search.
▲▼ : Cursor buttons for moving up/down or changing the recorder's TV tuner channel.
- ⑧ **DISPLAY**
– Displays/removes the status bar.
- ⑨ **REW ◀◀ / FFW ▶▶**
– Fast reverse or fast forward search.
- ⑩ **PREV ◀◀ / NEXT ▶▶**
– Skips to previous or next chapter/track.
- ⑪ **STOP ■**
– Stops playback/recording.
- ⑫ **P +/-**
– While in tuner, selects the next or previous TV channel.
- ⑬ **Numeric keypad**
– Selects a chapter/track number to play.
– Selects the recorder's preset TV tuner channel.
- ⑭ **AUDIO**
– Selects an audio language (DVD, VCD) or an audio channel.
- ⑮ **VIDEO Plus+**
– Enters/exits the VIDEO Plus+® menu.

Remote Control (continued)

- ⑩⑥ **USB**
 - Accesses the contents of the connected USB flash drive/ USB memory card reader.
- ⑩⑦ **SOURCE**
 - Selects the recorder's input source (DV, EXT1, EXT2, CAM1, CAM2 or Tuner).
- ⑩⑧ **SELECT**
 - Selects a track/chapter/file in the programme menu.
- ⑩⑨ **TOOLS**
 - Enters/exits the tools or disc/title editing menu.
- ⑩⑩ **DISC MENU**
 - Press to access the DVD disc menu or Index Picture screen of a DVD disc.
 - Press to access the VCD disc menu when PBC is turned on.
- ⑩⑪ **OK**
 - Stores/confirms an entry.
- ⑩⑫ **BACK**
 - Returns to the previous menu of a video CD (VCD).
- ⑩⑬ **PLAY/PAUSE**
 - Plays a disc.
 - Pauses the playback or recording.
- ⑩⑭ **REC**
 - Starts recording the current TV channel or the current video input source.
 - Press repeatedly to set up a One Touch Recording at 30, 60 or 90 minutes interval.
- ⑩⑮ **TV VOL + / –**
 - Adjusts the volume of the TV set (Philips TV only).
- ⑩⑯ **TV MUTE**
 - Mutes the volume of the TV set (Philips TV only).
- ⑩⑰ **SUBTITLE**
 - Selects a DVD subtitle language.
- ⑩⑱ **REC MODE**
 - Toggles between recording modes : HQ, SP, SPP, LP, EP or SLP.

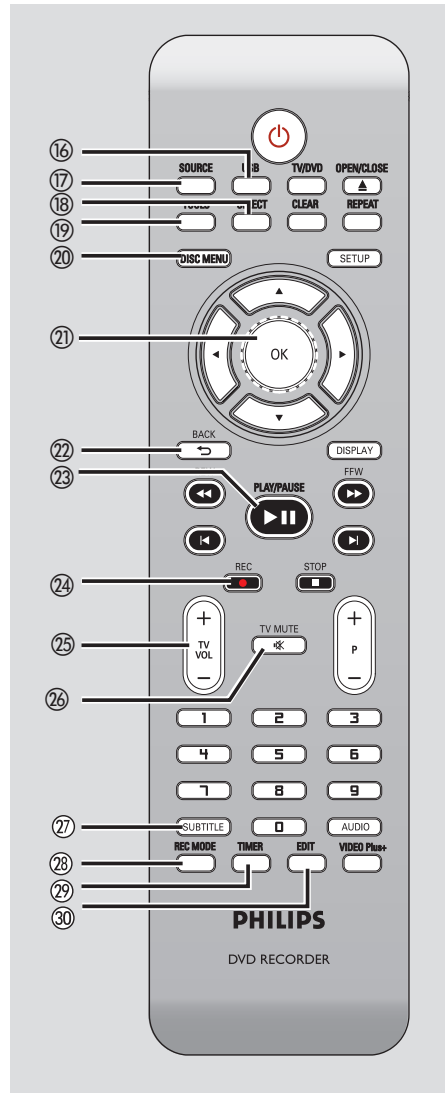

This determines the quality of the recording and the amount/length of time you can record onto a recordable DVD.

- ⑩㉙ **TIMER**
 - Enters/exits the timer recording menu.
- ⑩㉚ **EDIT**
 - Enters/exits the video editing menu.

Remote Control (continued)

Using the remote control

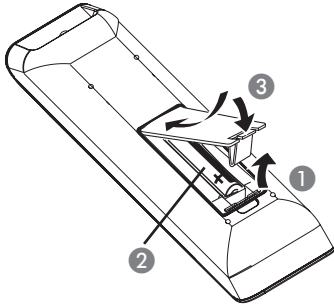

- 1 Open the battery compartment.
- 2 Insert two batteries type R03 or AAA, following the indications (+ -) inside the compartment.
- 3 Close the cover.
- 4 Aim the remote control directly at the remote sensor (IR) on the front panel.

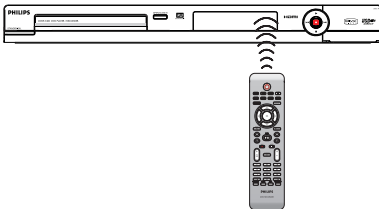

- 5 Select the source you want to control by pressing the **SOURCE** button on the remote control.
- 6 Select the desired function (for example ◀, ▶).

CAUTION!

- Remove batteries if they are exhausted or if the remote control is not to be used for a long time.
- Do not mix batteries (old and new or carbon and alkaline, etc.).
- Batteries contain chemical substances, so they should be disposed of properly.

Step 1: Basic Recorder Connections

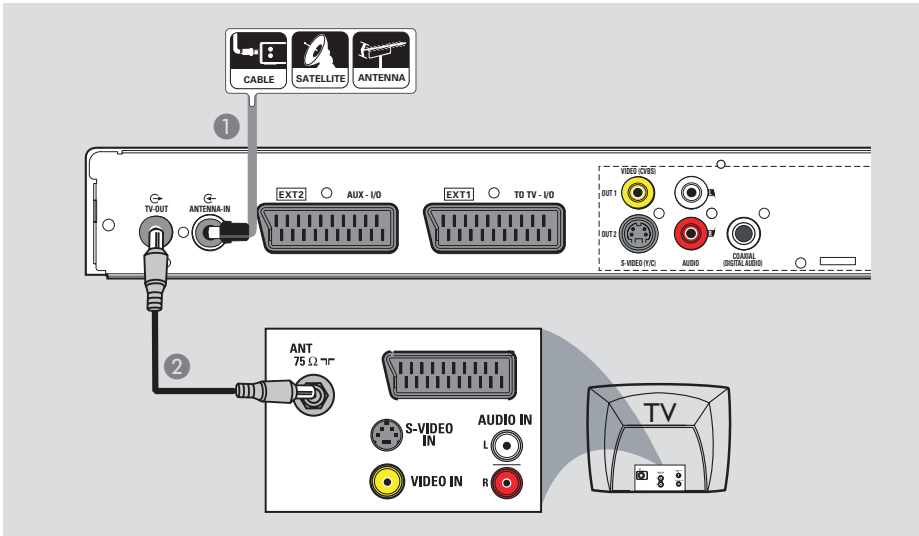

Connecting the aerial cables

These connections enable you to watch and record TV programmes using this recorder. If the aerial signal is connected via a VCR, Cable Box or Satellite Receiver, ensure that these devices are turned on in order to watch or record the cable programmes.

- **If you want to connect to a VCR and/or Cable Box/Satellite Receiver,** see the chapter “Step 2 : Optional Connections” for the complete connections to your TV.

- 1 Connect the existing Aerial/Satellite Receiver/Cable TV signal (labelled as RF OUT or TO TV) to the **ANTENNA-IN** socket on the recorder.
- 2 Use the supplied RF coaxial cable to connect the **TV-OUT** socket on the recorder to the aerial input socket (or labelled as VHF/UHF RF IN) on your TV.

Helpful Hint:

– Depending on how you have currently connected your TV channel (directly from an off-air aerial or Cable box or VCR), you may have to disconnect some of the cables before you make the aerial connection.

TIPS: Before making or changing any connections, make sure that all the devices are disconnected from the power outlet.

Step 1: Basic Recorder Connections (continued)

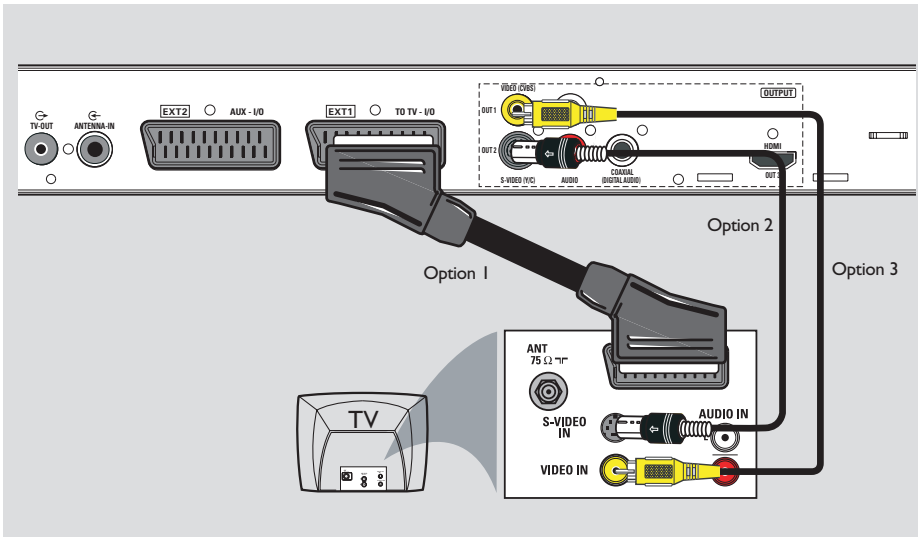

Connecting the video cable

This connection enables you to view the disc playback from this recorder. You need to choose only **one** of the options below to make your video connection.

Option 1: Using a SCART cable

- Use the SCART cable to connect the **EXT1 TO TV-I/O** socket on the recorder to the corresponding SCART input socket on the TV.

Helpful Hints:

- If your TV set has several SCART sockets, select the SCART socket that is suitable for both video output and video input.
- If your TV set displays a selection for the SCART socket, select 'VCR' as the source for the SCART socket.
- The EXT2 AUX-I/O socket is intended only for additional devices.

Option 2: Using an S-Video cable

- Use an S-video cable (not supplied) to connect the **S-VIDEO OUTPUT** socket on the recorder to the S-Video input socket (or labelled as Y/C or S-VHS) on the TV.
→ Audio connection is required in order to hear the sound, see next section "Connecting the audio cables".

Option 3: Using a Video (CVBS) cable

- Use a composite video cable (yellow - not supplied) to connect the **VIDEO OUTPUT** socket on the recorder to the video input socket (or labelled as A/V In, Video In, Composite or Baseband) on the TV.
→ Audio connection is required in order to hear the sound, see next section "Connecting the audio cables".

TIPS: Before making or changing any connections, make sure that all the devices are disconnected from the power outlet.

Step 1: Basic Recorder Connections (continued)

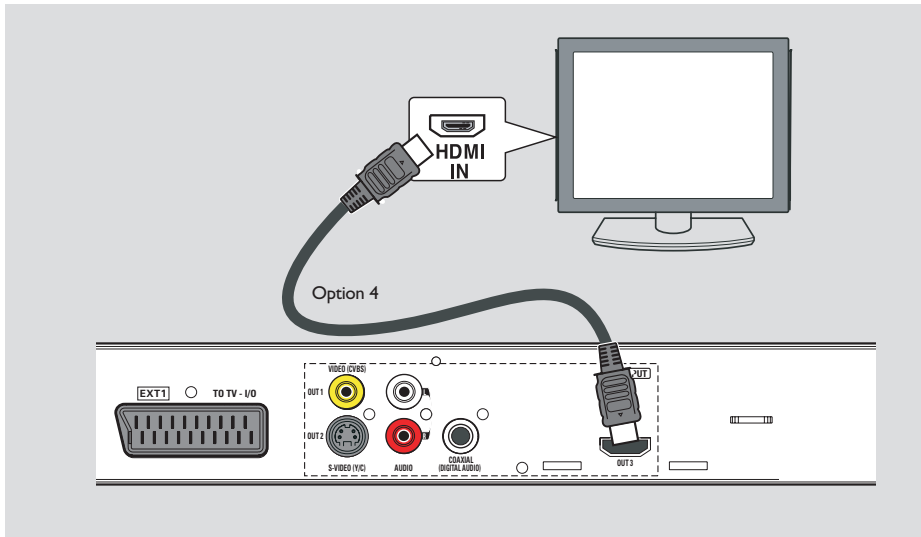

Option 4: Using a HDMI cable

HDMI (High Definition Multimedia Interface) is a digital interface that allows pure digital video transmission without the loss of image quality.

Note:

- Proper working is guaranteed with HDMI compliant products.
- When the HDMI cable is unplugged, the { **HDMI Video Resolution** } setting will automatically switch to default value { **576i** }.

- 1 Use an HDMI cable (not supplied) to connect the **HDMI OUTPUT** socket on this recorder to the HDMI IN on a HDMI compatible device (e.g. HDMI TV, HDCP compliant DVI TV).

- 2 Once you have completed the necessary connections, installation and set-up, see chapter “DVD Setup Menu Options – PLAYBACK Settings”.

Helpful Hints:

- Digital devices from different manufacturers have the possibility of differing output standards which may cause difficulties for the television to properly display.
- The HDMI connector is only compatible with HDMI compliant devices and DVI-TV.

TIPS: Before making or changing any connections, make sure that all the devices are disconnected from the power outlet.

Step I: Basic Recorder Connections (continued)

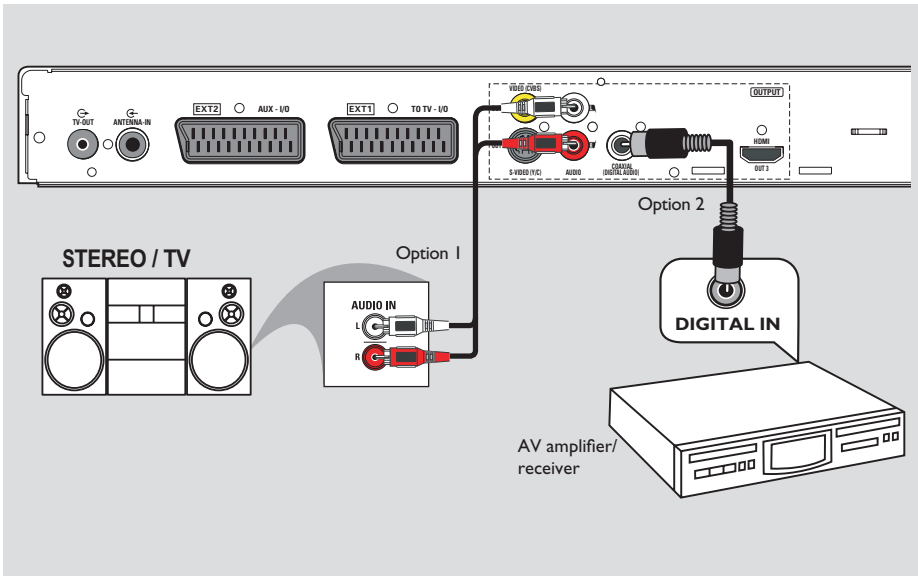

Connecting the audio cables

This connection enables you to listen to the playback from this recorder. However, this connection is not required if this recorder is connected to the TV using the SCART or HDMI cable.

Option 1: Using an audio cable

You can connect the recorder to a two channel stereo system (mini system, TV) or receiver in order to enjoy the stereo sound system.

- Use an audio cable (red/white ends - not supplied) to connect the **AUDIO L/R OUTPUT** sockets to the audio input sockets of the connected device.

Option 2: Using a coaxial cable

You can connect the recorder to an AV amplifier/receiver with a digital multichannel sound decoder in order to enjoy multichannel surround sound.

- Use a coaxial cable (not supplied). Connect the **COAXIAL (DIGITAL AUDIO OUT)** socket on the recorder to the digital input of the receiver/ amplifier.

Before you start operating, set the digital audio output settings accordingly (see the chapter "DVD Setup Menu Options - PLAYBACK settings). If the audio setting does not match your stereo's capabilities, the stereo may produce a strong, distorted sound or no sound at all.

TIPS: Before making or changing any connections, make sure that all the devices are disconnected from the power outlet.

Step 2: Optional Connections

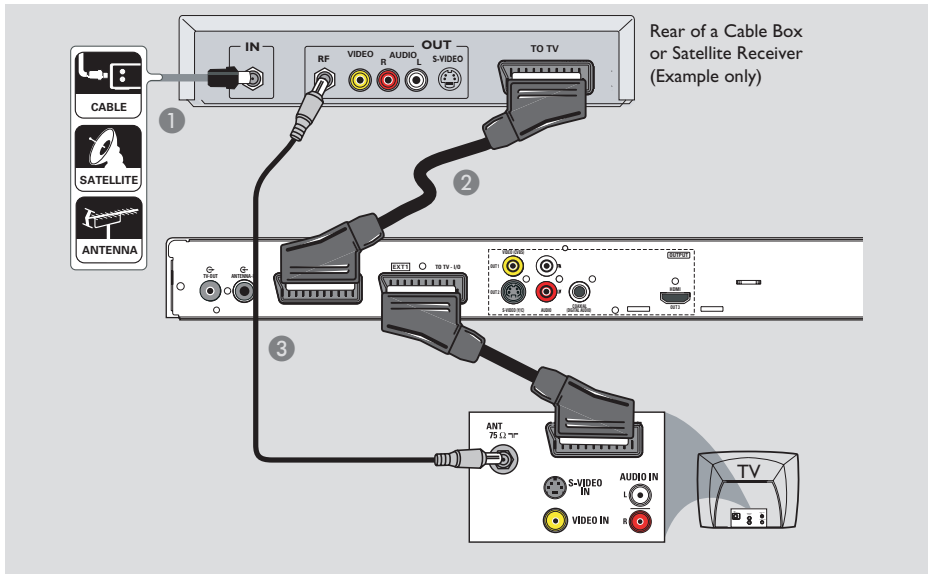

English

Connecting to a Cable Box or Satellite Receiver

Option 1

If your Cable Box/Satellite Receiver has only an aerial output socket (RF OUT or TO TV),

see "Step 1: Basic Recorder Connections – Connecting the aerial cables" for the complete connections to your TV.

Option 2 (see the above illustration)

If your Cable Box/Satellite Receiver has a SCART output socket

- 1 Keep the existing aerial connection from the Cable Box/Satellite Receiver to your TV.
- 2 Use the SCART cable to connect the **EXT1 TO TV-I/O** scart socket on the recorder to the SCART input socket on the TV.
- 3 Use another SCART cable to connect the **EXT2 AUX-I/O** scart socket on the recorder to the SCART output socket (or labelled as TV OUT or TO TV) on the Cable Box/Satellite Receiver.

To start playback, select the TV channel directly on the Cable Box/Satellite Receiver. To view the picture from a connected external device, press the **TV/DVD** key on the remote control.

TIPS: Refer to the respective connected device's user manual for other possible connections.

Step 2: Optional Connections (continued)

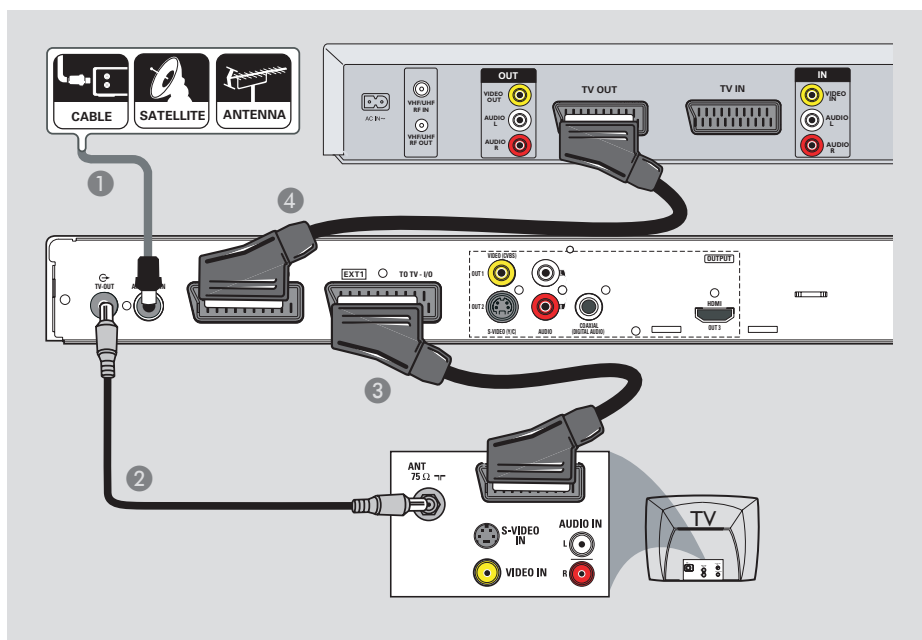

Connecting to a VCR or other similar device

This connection enables you to record from a video tape to a recordable DVD and allows the VCR to be used for playback even if the recorder is turned off.

IMPORTANT!

Your new recorder can replace the VCR for all your recording needs. Just unplug all the connections to your VCR.

- 1 Connect the existing Aerial/Satellite/Cable TV signal (or from the Cable Box/Satellite Receiver, labelled as RF OUT or TO TV) to the **ANTENNA-IN** socket on the recorder.

- 2 Use the supplied RF coaxial cable to connect the **TV-OUT** socket on the recorder to the aerial input socket (or labelled as VHF/UHF RF IN) on your TV.

- 3 Use the SCART cable to connect the **EXT1 TO TV-I/O** socket on the recorder to the corresponding SCART input socket on the TV.

- 4 Use another SCART cable to connect the **EXT2 AUX-I/O** socket on the recorder to the SCART output socket (or labelled as TV OUT or TO TV) on the VCR.

Helpful Hints:

- Most commercial video cassettes and DVDs are copy-protected and therefore cannot be recorded.
- Connect the recorder directly to the TV. If there is a VCR or an additional device in between, the picture quality may be poor because of the copy protection system built into the recorder.

TIPS: Refer to the respective connected device's user manual for other possible connections.

Step 2: Optional Connections (continued)

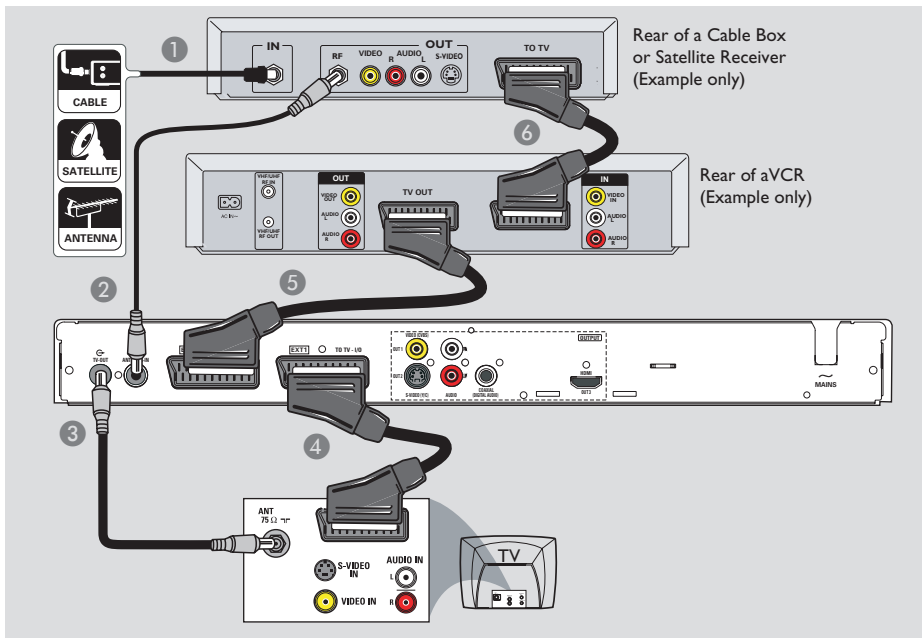

Connecting to a VCR and Cable Box/Satellite Receiver

- 1 Connect the Aerial/Cable TV signal to the aerial input (RF IN) socket on the Cable Box/Satellite Receiver.
- 2 Use the supplied RF coaxial cable to connect the aerial output (RF OUT) socket on the Cable Box/Satellite Receiver to the **ANTENNA-IN** socket on the recorder.
- 3 Use another RF coaxial cable to connect the **TV-OUT** socket on the recorder to the aerial input socket on the TV.
- 4 Use the SCART cable to connect the **EXTI TO TV-I/O** socket on the recorder to the corresponding SCART input socket on the TV.
- 5 Use another SCART cable to connect the **EXT2 AUX-I/O** socket on the recorder to the SCART output socket (or labelled as TV OUT or TO TV) on the VCR.
- 6 Use another SCART cable to connect the SCART input (TV IN) socket on the VCR to the SCART output socket (or labelled as TV OUT or TO TV) on the Cable Box/Satellite Receiver.

TIPS: Refer to the respective connected device's user manual for other possible connections.

Step 2: Optional Connections (continued)

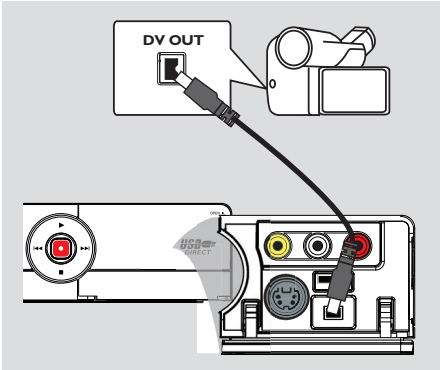

Connecting a camcorder to the front sockets

You can use the front sockets to copy camcorder recordings. These sockets are located behind the flap on the right which provides convenient connections.

Option 1: Using the DV IN socket

Use this connection if you have a Digital Video or Digital 8 camcorder. The DV socket conforms to the i.LINK standard.

- Use an i.LINK 4-pin cable (not supplied) to connect the **DV IN** socket at the front panel of the recorder to the appropriate DV OUT socket on the camcorder.

Before you start operating, press **SOURCE** on the remote control repeatedly to select 'DV' as the input channel.

Helpful Hints:

- The DV IN socket does not support a connection to a Personal Computer.
- It is not possible to record from the recorder to your camcorder via the DV IN socket on your recorder.

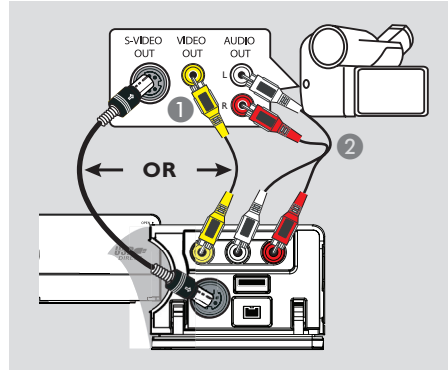

Option 2: Using the VIDEO In or S-VIDEO In sockets

Use this connection if you have a Hi8 or S-VHS(C) camcorder or if your camcorder has only a single video output socket (Composite Video, CVBS).

- 1 Use a video cable (not supplied) to connect the **CAM 1** socket at the front panel of the recorder to the Video output socket on the connected video device.
- Alternatively, use an S-Video cable to connect the **CAM 2** socket if the connected video device has the S-Video output socket. It provides better picture quality.
- 2 Use an audio cable (not supplied) to connect the **AUDIO L/R** sockets at the front panel of the recorder to the audio output sockets on the connected video device.

Before you start operating, press **SOURCE** on the remote control repeatedly to select 'CAM1' or 'CAM2' as the input channel, depending on your connections.

TIPS: Refer to the respective connected device's user manual for other possible connections.

Step 2: Optional Connections (continued)

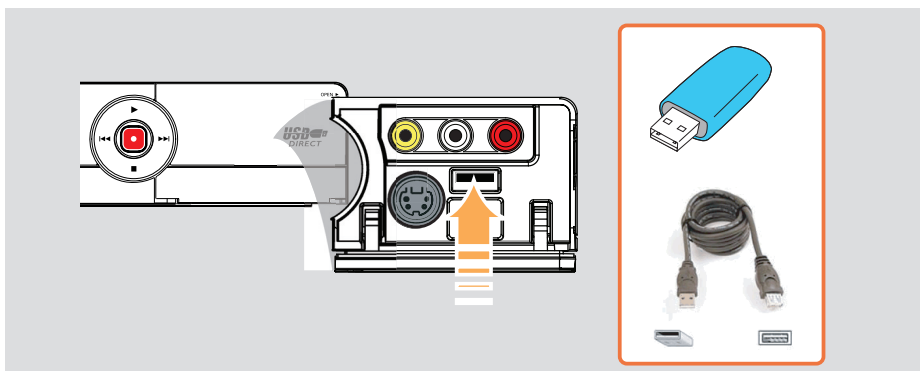

English

Connecting a USB flash drive or USB memory card reader

You can view the contents of a USB flash drive / USB memory card reader through this recorder and record the contents onto a recordable DVD. See the chapter “Recording – Archiving from a USB flash drive or USB memory card.”

- 1 Connect the USB flash drive / USB memory card reader directly to the **USB** port on the front panel (as shown in the above illustration).
- 2 Press **USB** on the remote control to view the files stored in the USB flash drive or USB memory card reader.
- 3 To stop playback, press **STOP** ■ or remove the USB flash drive / USB memory card reader from the USB port.

Helpful Hints:

- The USB port only supports the playback of JPEG/MP3/WMA files.
- The USB port does not support the connection of other USB devices except to a USB flash drive / USB memory card reader.
- When the USB device does not fit into the USB port, a USB extension cable is required.

TIPS: Refer to the respective connected device’s user manual for other possible connections.

Step 3: Installation and Setup

Before you start...

When you complete the connections and turn on the recorder for the first time, it is advisable that you make several basic settings.

Please see the following pages on using the system setup menu features to programme TV channels, menu language and system clock settings. This will optimise the performance of this recorder.

Finding the correct viewing channel



- 1 Press **STANDBY-ON** on the recorder to switch it on.
- 2 Switch on the TV and set it to the correct video-in channel. You should see the blue DVD background screen.
 - You may go to Channel 1 on your TV, then press the Channel Down button on your TV's remote control until you see the Video In channel.
 - You may press  button repeatedly on your TV's remote control.
 - Usually this channel is between the lowest and highest channels and may be called FRONT, A/V IN, VIDEO. See your TV manual for more details.

Setting the OSD language

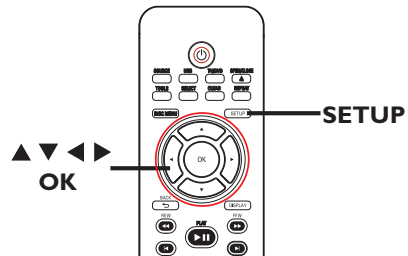

Select the menu language for this recorder's on-screen display. The language options are different depending on your country or region. It may not correspond to the illustrations shown in the user manual.

Language settings can only be changed when there is no disc in the disc tray.

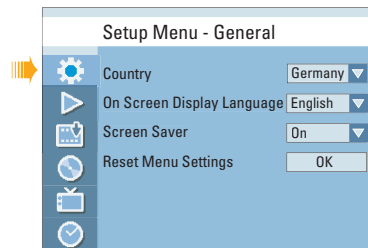

- 1 Press **SETUP**.
→ The setup menu appears.
- 2 Use  keys to highlight  { **Setup Menu - General** } and press  to access the menu.



- 3 Use  keys to highlight { **On Screen Display Language** } and press **OK** to access its options.
- 4 Use  keys to highlight the desired language and press **OK** to confirm.

TIPS: Press  to access the options of an item in the menu.
Press **SETUP** to exit the menu.

Step 3: Installation and Setup (continued)

Select the country of your residence

Select the country of your area for auto channel tuning.

- 1 In setup menu, use ▲▼ keys to highlight  { **Setup Menu - General** } and press ► to access the menu.

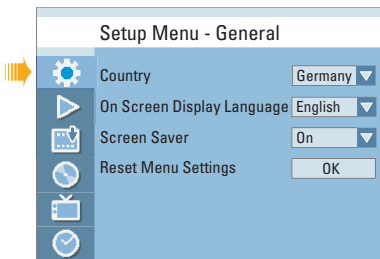

- 2 Select { **Country** } and press **OK**.
- 3 Use ▲▼ keys to select the country of your residence and press **OK** to confirm.

Setting your TV channel programmes

Before the recorder can start recording the TV channel programmes, you need to search for the available TV channels and store them in the recorder.

Tuner settings can only be changed when there is no disc in the disc tray.

Before you start ...

Make sure you have successfully made all the required connections to the recorder, the TV and Satellite Receiver/ Cable Box (if any) and turned them on.

- 1 In setup menu, use ▲▼ keys to highlight  { **Setup Menu - Channel Setup** } and press ►.

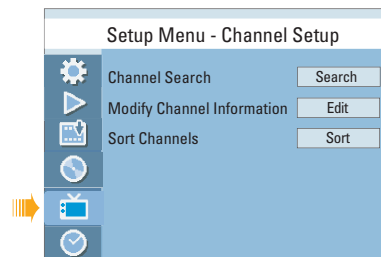

- 2 Select { **Channel Search** } and press **OK**.
→ The automatic TV channel search starts. This process may take several minutes. Once complete, the total number of channels found and stored appears on the TV.

To modify or sort the TV channels, see the chapter “DVD Setup Menu Options – CHANNEL SETUP settings.”

TIPS: Press ► to access the options of an item in the menu.
Press **SETUP** to exit the menu.

Step 3: Installation and Setup (continued)

Setting the date & time

This recorder has an automatic date and time setting feature. If the recorder has not set the time and date correctly, you can further adjust the clock settings.

- 1 In setup menu, use ▲▼ keys to highlight  { **Setup Menu - Clock** } and press ► to confirm.

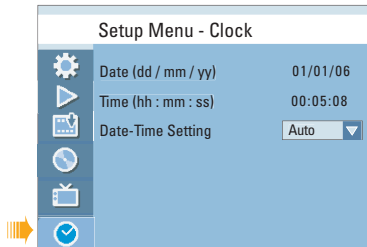

- 2 Select { **Date-Time Setting** } and press ►.
→ Use ▲▼ keys to highlight { **Manual** } and press **OK**.
- 3 Select { **Date (dd/mm/yy)** } and press **OK** to edit the date fields.
→ Use ▲▼ keys to change number and use ◀▶ keys to select different entry fields, then press **OK** to confirm.
- You can also use the **numeric keypad 0-9** on the remote control to key in the numbers.
- 4 Press **OK** to confirm.
- 5 To set { **Time (hh:mm:ss)** }, repeat step 3~4.
- 6 Press **SETUP** to exit the menu.

The basic installation is complete.

TIPS: Press ► to access the options of an item in the menu.
Press **SETUP** to exit the menu.

Discs for recording

Several different types of recordable DVD discs can be used with this recorder:



DVD±RW (DVD Rewritable)

– Discs that are rewritable can be used for multiple recordings once the existing data is erased.



DVD±R (DVD Recordable)

- Discs can only be used for a single recording. Each new recording is always added at the end of all previous recordings as existing recordings cannot be overwritten.
- Editing can be done on DVD±R discs as long as they have not been finalised.
- To play a DVD±R on other DVD player, it must be finalised (see the chapter “Editing/ Finalising Recording – Playing your recordings (DVD±R) on other DVD players”). After this is done, no more data can be added to the disc.



DVD+R DL (DVD+R Double Layer)

– Like the DVD+R, these discs can only be used for a single recording. The only difference is the capacity- 8.5GB. It offers two recordable layers on a single DVD disc. The layers are accessible from the same side of the disc, so recording can occur completely uninterrupted.

Supported disc type and media speeds

Disc	Media speeds
DVD+R	1x - 16x
DVD+RW	2.4x - 4x
DVD-R	1x - 16x
DVD-RW	2.4x - 4x
DVD+R DL	2.4x

Recording (continued)

IMPORTANT!

Unrecordable contents

Contents with copy protection cannot be recorded on this recorder. When the recorder receives a copy guard signal, recording will be paused.

Recording settings

The default recording settings allow you to set the auto chapter markers, preferred recording input source and recording mode. Any change made using the remote control will only apply to the current recording settings. The default recording settings will remain unchanged for the next recording.

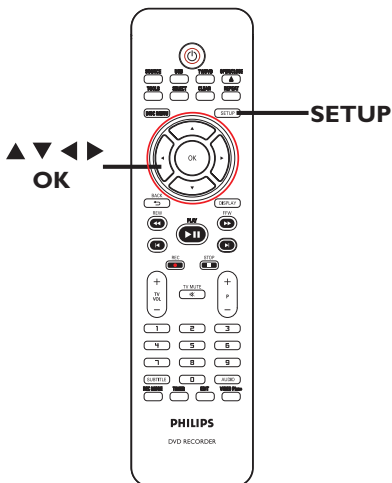

- 1 Press **SETUP** on the remote control.
→ The setup menu appears on the TV.
- 2 Use **▲▼** keys to select  { **Setup Menu - Record** } and press **▶** to confirm.

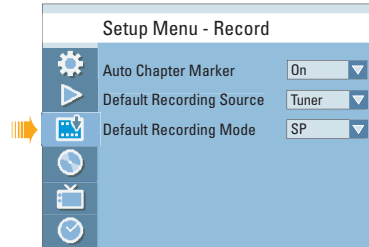

- 3 Use **▲▼** keys to select the setting you wish to change and press **OK** to confirm.
→ Instructions and explanations of the options are provided in the following pages.
- 4 To exit, press **SETUP**.

TIPS: Press **◀** to go back to previous menu item.
Press **SETUP** to exit the menu item.

Recording (continued)

RECORD settings (underlined options are the factory default settings)

Auto Chapter Marker

Automatically divides a recording (title) into chapters by inserting chapter markers at a specific interval. This enables you to access a specific point in the recording quickly.

- { On } – Chapter markers will automatically be inserted within the title during recording at every 5 minutes interval.
- { Off } – No chapter marker is inserted in the recording.

Default Recording Source

Define your frequent source of recording. The recorder will switch to this default source whenever it is turned on.

- { Tuner } – Input source from TV programmes.
- { CAM1 } – Input source from the device connected to the CAM1 and AUDIO L/R sockets at the front panel.
- { CAM2 } – Input source from the device connected to the CAM2 and AUDIO L/R sockets at the front panel.
- { DV } – Input source from the device connected to DV IN socket on the front panel.
- { EXT 1 } – Input source from the device connected to the EXT1 TO TV-I/O SCART socket at the rear panel.
- { EXT 2 } – Input source from the device connected to the EXT2 AUX-I/O SCART socket at the rear panel.

Note: To change the current recording source without changing the default setting, you can press the **SOURCE** button on the remote control.

Default Recording Mode

The recording mode defines the preferred picture quality of recordings and the maximum recording time on a disc. The factory default setting is SP.

Record Mode	Picture Quality	Maximum Recording Time per Disc (hours)
HQ	High Quality	1
SP	Standard Play	2
SPP	Standard Play Plus	2.5
LP	Long Play	3
EP	Extended Play	4
SLP	Super Long Play	6

Recording (continued)

Recording from various sources

You can record a TV programme or copy the content from an external device to a recordable DVD disc. The storage capacity of the disc depends on the recording mode selected.

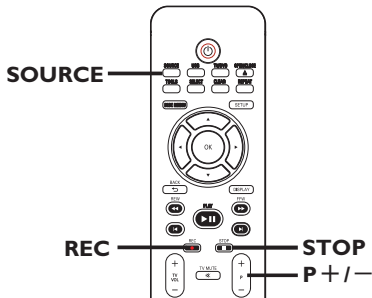

Recording TV programmes

- 1 Switch on the TV to the correct viewing channel for the recorder (e.g. 'EXT', '0', 'AV').
- 2 Insert a recordable DVD into the recorder.
- 3 Press **SOURCE** on the remote control to select { **Tuner** }, then use **P +/-** keys to select the TV channel you wish to record.
- 4 Press **REC** ● to start recording.
 - If the disc contains some prior recordings, the new recording will automatically start after the last recording on the disc.
- To pause the recording, press **PLAY/PAUSE** ►||. To continue recording, press **REC** ●.
 - You can use this function to avoid recording commercials.
- 5 To stop the recording, press **STOP** ■.

Recording from an DV camcorder

Record video directly from a connected DV camcorder to a recordable DVD disc.

- 1 Connect the DV camcorder to **DV IN** socket at the front of the recorder.
- 2 Find the footage on the DV camcorder that you want to start recording and set the camcorder to pause mode.
- 3 Switch on the TV to the correct viewing channel for the recorder (e.g. 'EXT', '0', 'AV').
- 4 Insert a recordable DVD into the recorder.
- 5 Press **SOURCE** on the remote control to select { **DV** }.
- 6 Press **REC** ● to start recording and press the **PLAY** button on the DV camcorder to start playback.
 - To pause the recording, press **PLAY/PAUSE** ►|| once. To continue recording, press **REC** ● again
- 7 To stop the recording, press **STOP** ■.
 - A new title will be created when you begin another recording.

TIPS: Ensure that there is enough space on the recordable DVD before recording. Before you playback the DVD±R on another player, finalise the disc. See "Playing your recordings (DVD±R) on other DVD players".

Recording (continued)

Recording from an external device (Camcorder/VCR/DVD Player)

Record video directly from an external device to a recordable DVD disc.

Before you start...

Set the preferred mode of recording before proceeding. See the section "Recording Settings" in this chapter.

- 1 Connect the external device to this recorder. See the chapter "Step 2: Optional Connections".
- 2 Switch on the TV to the correct viewing channel for the recorder (e.g. 'EXT', '0', 'AV').
- 3 Insert a recordable DVD into the recorder.
- 4 Press **SOURCE** repeatedly to select the correct input channel that matches the connected socket of the device.

{ EXT 1 }

Input source from the device connected to the EXT1 TO TV-I/O SCART socket at the rear panel.

{ EXT 2 }

Input source from the device connected to the EXT2 AUX-I/O SCART socket at the rear panel.

{ CAM1 }

Input source from the device connected to the VIDEO and AUDIO L/R sockets at the front panel.

{ CAM2 }

Input source from the device connected to the S-VIDEO and AUDIO L/R sockets at the front panel.

- 5 Press **REC** ● to start recording.
→ Press **REC** ● repeatedly to toggle between OTR 30, 60 or 90- minutes recording options.
- 6 Start playback on the connected device.
 - To pause the recording, press **PLAY/PAUSE** ►|| once. To continue recording, press **REC** ● again.
→ You can use this function to avoid any unwanted recording.
- 7 To stop the recording, press **STOP** ■.

TIPS: Ensure that there is enough space on the recordable DVD before recording. Before you playback the DVD±R on another player, finalise the disc. See "Playing your recordings (DVD±R) on other DVD players".

Recording (continued)

Archiving from a USB flash drive or USB memory card reader

Archive the contents from a USB device to a recordable DVD disc.

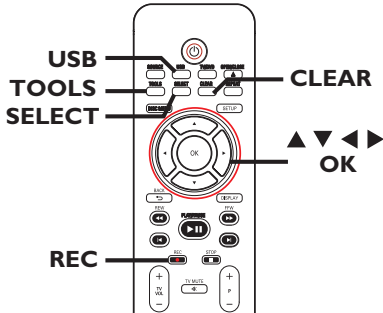

- 1 Switch on the TV to the correct viewing channel for the recorder (e.g. 'EXT', '0', 'AV').
- 2 Insert a recordable DVD into the recorder. (Use a DVD disc only for data archiving. Do not use a disc with video recordings).
- 3 Connect the USB flash drive / USB memory card reader to the **USB** port at the front panel of the recorder.
- 4 Press **USB** on the remote control to view the files stored in the USB flash drive or USB memory card reader.
- 5 Press **TOOLS** on the remote control.
 - The USB mode appears.

Audio	
Type	Audio
Mode	Normal
Audio	Stereo
Search	00:00:00 - 00:00:00
USB	Copy to DVD

- 6 Use **▲▼** keys to select { **Copy to DVD** } and press **OK**.
 - The USB drive content menu appears.

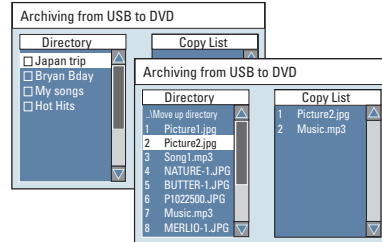

- 7 Use **▲▼** keys to navigate within the menu and press **OK** to access the folder/ album.
- 8 To create a copylist, highlight the track/file and press **SELECT**.
 - The selected tracks/files will appear on the right { **Copy List** } screen.
 - To remove the track/file from the copy list, press **CLEAR**.
- 9 Once the copy list selection is complete, press **REC** to start archiving.
 - A message will appear. Select **OK** in the menu and press **OK** to proceed.

Helpful Hints:

- The USB port supports the playback of JPEG/MP3/WMA/DivX files.
- The USB port does not support the connection of other USB devices except to a USB flash drive / USB memory card reader.
- If the USB device does not fit into the USB port, a USB extension cable is required.
- It is not possible to record content from a DVD disc to the USB drive.

TIPS: Ensure that there is enough space on the recordable DVD before recording. Before you playback the DVD±R on another player, finalise the disc. See "Playing your recordings (DVD±R) on other DVD players".

Timer Recording

About timer recording

Use the timer recording to automatically start and stop a recording at a later date/time. The recorder will tune to the right programme channel and begin recording at the specified time.

With this recorder, you can schedule up to **8 recordings** at a time. During timer recording, changing the channel that is being recorded is not possible.

There are two ways to programme a timer recording

- Using the VIDEO Plus+® system.
- Using manual timer schedule.

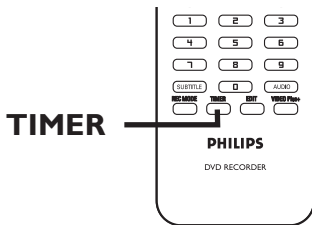

About 'VPS/PDC'

'VPS' (Video Programming System) or 'PDC' (Programme Delivery Control) is used to control the start and duration of TV channel recordings. If a TV programme starts earlier or ends later than was scheduled, the recorder will then turn on and off at the correct time.

VPS/PDC is intended to record the entire programme. To set a timer that is longer/shorter than the VPS/PDC broadcast time, you must turn off the VPS/PDC.

Timer recording (VIDEO Plus+® System)

This is a simple timer programming system. To use it, enter the PlusCode programming number associated with your television programme. You can find this number in your TV listings magazine.

All the information required by this recorder for programming is contained in the programming number.

- 1 Switch on the TV to the correct viewing channel for the recorder (e.g. 'EXT', '0', 'AV').
- 2 Press **VIDEO Plus+** on the remote control.
→ The VIDEO Plus+® System menu appears.

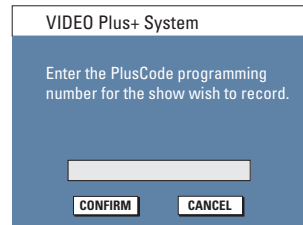

- 3 Use the **numeric keypad 0-9** to enter the PlusCode programming number for the show you wish to record. (e.g. : 5-312-4 or 5,312 4, key in '53124').
- To clear the PlusCode programming number, press **CLEAR** on the remote control.
 - To cancel the PlusCode programming, use **▲▼** keys to select **CANCEL** in the menu and press **OK**.

TIPS: Ensure that there is enough space on the recordable DVD before recording. Before you playback the DVD±R on another player, finalise the disc. See "Playing your recordings (DVD±R) on other DVD players".

Timer Recording (continued)

- To confirm your entry, select **CONFIRM** in the menu and press **OK**.
→ The VIDEO Plus+® programme information will be shown on the timer editor menu.

Timer Editor 09 : 05 : 56

Source	Ch003
Rec Mode	SP
Mode	Once
Date	01 / 01 / 06
Start	10 : 33
End	11 : 03
VPS/PDC	Off

OK CANCEL

- If the channel number of the TV programme has not been assigned to the programming number, you will have to manually key in the channel number that is assigned to the PlusCode. Follow the instructions on the TV.
- Press **TIMER** to exit the menu.
- Insert a recordable DVD into the recorder.
- Press **STANDBY-ON** to turn off the recorder to standby mode.
→ The **TIMER** icon will light up on the display panel if a timer recording is set.
→ If the recorder is not in standby mode, a notification message will appear three minutes before the recording begins.

Timer recording (manually)

- Switch on the TV to the correct viewing channel for the recorder (e.g. 'EXT', '0', 'AV').
- Press **TIMER** on the remote control.
→ The timer schedule appears.

Timer Schedule 09 : 05 : 56

	Source	Rec Mode	Date	Start	End	VPS
1	CH003	SP	05/01/06	14.00	15.30	On
2	CH010	EP	25/01/06	02.00	06.30	Off
3	CH008	SP	30/01/06	17.00	18.15	On
4	CH005	SP	31/01/06	12.30	14.00	Off
5						
6						

- Select an empty field and press **OK**.
→ The timer editor menu appears.

Timer Editor 09 : 05 : 56

Source	Ch003
Rec Mode	SP
Mode	Once
Date	01 / 01 / 06
Start	10 : 33
End	11 : 03
VPS/PDC	Off

OK CANCEL

- Use **▲▼** keys or the **numeric keypad 0-9** to select or enter the recording information, then press **OK** to confirm.

TIPS: Ensure that there is enough space on the recordable DVD before recording. Before you playback the DVD±R on another player, finalise the disc. See "Playing your recordings (DVD±R) on other DVD players".

Timer Recording (continued)

{ Source }

Select the TV channel or the correct input source (DV, EXT1, EXT2, CAM1 or CAM2) which you have used to connect the external device.

{ Rec Mode }

Select the mode of recording. See the chapter "Recording – RECORD settings - Default Recording mode" for more information.

{ Mode }

Select a desired repeat recording mode (Once, Daily, Weekly, Mon-Fri, Mon-Sat or Weekend).

{ Date }

Enter the date for recording (Day/Month/Year).

{ Start }

Enter the start time of recording (hours : minutes).

{ End }

Enter the end time of recording (hours : minutes).

{ VPS/PDC }

Turn on or off the VPS/PDC setting. (See the section "About timer recording – About VPS/PDC").

Note: VPS/PDC setting is not available for the external receiver.

- 5 Use ▲▼ keys to select in the menu and press **OK**.
 - The system will store the timer entry and return to the timer schedule list.
- To cancel the above timer setting, move to in the menu and press **OK**.
- 6 Press **TIMER** to exit the menu.
- 7 Insert a recordable DVD into the recorder.
- 8 Press **STANDBY-ON** to turn off the recorder to standby mode.
 - The 'TIMER' icon will light up on the display panel if a timer recording is set.
 - If the recorder is not in standby mode, a notification message will appear three minutes before the recording begins.

Helpful Hint:

– Set the timer recording one minute ahead of the programme's start time. This helps ensure the entire programme is recorded as the disc requires about 30 seconds to prepare for recording.

TIPS: Ensure that there is enough space on the recordable DVD before recording. Before you playback the DVD±R on another player, finalise the disc. See "Playing your recordings (DVD±R) on other DVD players".

Timer Recording (continued)

Setting a timer recording from an external Cable Box/ Satellite Receiver

If you have a Satellite Receiver/Cable Box connected to this recorder via the EXT2 AUX-I/O SCART connection (see “Step 2: Optional Connections”), follow the steps described below to programme the recordings.

- 1 Select the channel you want to record at the Satellite Receiver/Cable Box.
- 2 Programme the recording with the required information. Follow the steps ①~⑧ of “Timer Recording (manually)” on the previous page.
Note: In { **Source** } entry, select { **EXT2** } as the input source for recording.
- 3 Leave the Satellite Receiver/Cable Box turned on for the recording.

Changing/ Deleting a timer recording

- 1 Switch on the TV to the correct viewing channel for the recorder (e.g. ‘EXT’, ‘0’, ‘AV’).
- 2 Press **TIMER** on the remote control.
→ The timer schedule appears.

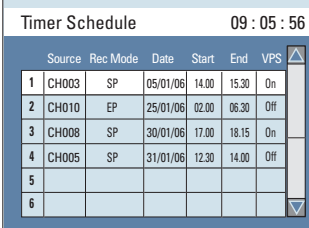

	Source	Rec Mode	Date	Start	End	VPS
1	CH003	SP	05/01/06	14.00	15.30	On
2	CH010	EP	25/01/06	02.00	06.30	Off
3	CH008	SP	30/01/06	17.00	18.15	On
4	CH005	SP	31/01/06	12.30	14.00	Off
5						
6						

- 3 Use ▲▼ keys to select a timer programme which you want to change/delete.
- 4 **To delete the timer entry**, press **CLEAR** on the remote control.
- 5 **To change the timer schedule**, press **OK** to enter the timer editor menu of the selected timer programme.

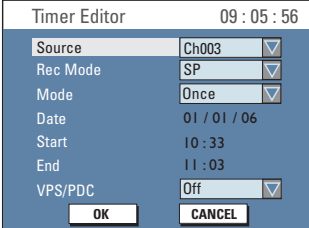

Timer Editor		09 : 05 : 56
Source	Ch003	▼
Rec Mode	SP	▼
Mode	Once	▼
Date	01 / 01 / 06	
Start	10 : 33	
End	11 : 03	
VPS/PDC	Off	▼
<input type="button" value="OK"/>		<input type="button" value="CANCEL"/>

- 6 Select the entry field and make the necessary changes.
- 7 Once complete, select in the menu and press **OK**.
- 8 Press **TIMER** to exit the menu.

TIPS: Ensure that there is enough space on the recordable DVD before recording. Before you playback the DVD±R on another player, finalise the disc. See “Playing your recordings (DVD±R) on other DVD players”.

Playback

Playable discs

Using this recorder, you can playback and record on the following discs:

Recording and Playback

DVD±RW

(DVD Rewritable); can be recorded on over and over again.



DVD±R

(DVD Recordable); can be recorded only once.



DVD+R DL

(DVD+R Double Layer); can be recorded only once.



Playback only:

DVD Video (Digital Versatile Disc)



CD-RW (CD-Rewritable)
Audio/ MP3/WMA JPEG contents



CD-R (CD-Recordable)
Audio/ MP3/WMA JPEG contents



Audio CD (Compact Disc Digital Audio)



MP3/WMA-Disc



Video CD
(Formats 1.0, 1.1, 2.0)



Super Video CD



DivX Disc
(DivX 3.11, 4.x, 5.x, 6)



IMPORTANT!

- If the inhibit icon (**Error**) appears on the TV screen when a button is pressed, it means the function is not available on the current disc or at the current time.
- DVD discs and players are designed with regional restrictions. Before playing a disc, make sure the disc is for the same region as your player.
- Do not push on the disc tray or put any objects other than discs on the disc tray. It may cause the disc player to malfunction.

TIPS: Some discs cannot be played on this recorder due to the configuration and characteristics of the disc, or due to the condition of recording and authoring software.

Starting disc playback

- 1 Press **STANDBY-ON** to switch on the recorder.
 - 2 Press **OPEN/CLOSE ▲**.
→ The disc tray opens.
 - 3 Place the disc onto the tray with the label facing up, then press **OPEN/CLOSE ▲**.
 - 4 Switch on the TV to the correct viewing channel for the recorder (e.g. 'EXT', '0', 'AV').
 - 5 Playback may start automatically or a dialogue box will appear on the TV (see next page).
- If the pin code entry dialogue appears on the TV, this means that the parental control was activated for the inserted disc. You have to enter your four-digit pin code (see "DVD Setup Menu Options – DVD Settings").
 - For more playback features, see "Additional Playback Features".

Playing a DVD video disc

The DVD disc is usually formatted with a disc menu. You may have to make your selection (e.g., subtitle or audio language) within the disc menu.

- 1 Insert a DVD disc.
- If the disc menu appears, use the **numeric keypad 0-9** to input your selection or use **▲▼** keys to select a play option and press **OK** to start playback.

To access the disc menu

- Press **DISC MENU** on the remote control.

To select the previous or next chapter

- During playback, press **◀** or **▶**.
- 2 To stop playback, press **STOP ■**.

Playing an audio CD

- 1 Insert an audio CD.
→ Playback starts automatically.
→ The track number and elapsed playing time appear on the display panel.
- 2 To stop playback, press **STOP ■**.

TIPS: Some discs cannot be played on this recorder due to the configuration and characteristics of the disc, or due to the condition of recording and authoring software.

Playback (continued)

Playing a (Super) Video CD

(Super) Video CDs may feature 'PBC' (Play Back Control). This allows you to play the video CDs interactively by following the menu on the display.

- 1 Insert a (Super) Video CD.

If the 'PBC' is on, the disc index menu will appear on the TV

- 2 Use **numeric keypad 0-9** to input your selection or to select a play option.
 - To return to the previous menu, press **BACK** \leftarrow on the remote control.
 - To turn on/off the Playback Control mode, press **TOOLS** on the remote control during playback to access the VCD menu. Then use $\blacktriangle/\blacktriangledown$ keys to select { **PBC On** } or { **PBC Off** }.
- 3 To stop playback, press **STOP** \blacksquare .

Playing a recordable DVD disc

- 1 Insert a recordable DVD disc.
 - The Index Picture screen appears.
- 2 Use $\blacktriangle/\blacktriangledown$ keys to select a title to play, then press **PLAY/PAUSE** \blacktriangleright **II**.
- 3 To stop playback, press **STOP** \blacksquare .

Helpful Hint:

– If the message 'BLANK' appears on the display panel, this means that there are no recordings on this disc.

Playing an MP3/WMA disc

- 1 Insert an MP3/WMA CD.
 - The disc content menu appears.

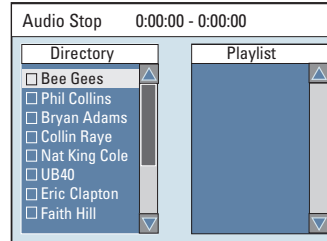

Note: It may require a longer time for the recorder to display the disc content menu on the TV due to the large number of songs/pictures compiled into one disc.

- 2 Use $\blacktriangle/\blacktriangledown$ keys to navigate within the menu and press **OK** to access the folder/album.
- 3 Use $\blacktriangle/\blacktriangledown$ keys to select the track/file to play.
 - To move up to the previous level, press **BACK** \leftarrow .
- 4 To create a playlist, highlight the track/file and press **SELECT**.
 - The selected tracks/files will appear on the right screen.
 - To remove the track/file from the playlist, press **CLEAR**.
- 5 To start playback from the playlist, move the cursor to the right selection screen and press \blacktriangleright **II**.
- 6 During playback, you can press $\blacktriangle/\blacktriangledown$ to select the next/previous track.
- 7 To stop playback, press **STOP** \blacksquare .

Helpful Hints:

– Only the first session of a multi-session CD will playback.
 – This recorder does not support MP3PRO audio format.

TIPS: Some discs cannot be played on this recorder due to the configuration and characteristics of the disc, or due to the condition of recording and authoring software.

Playback (continued)

Playing a picture disc (or musical slide show)

You can display JPEG pictures in the selected roll automatically one after the other.

- 1 Insert a JPEG picture disc (CD, CD-R/RW, recordable DVD).
→ The disc content menu appears.
- 2 Use ▲▼ keys to navigate within the menu and press **OK** to access the folder/ album.
- 3 To create a playlist, highlight the track/file and press **SELECT**.
→ The selected tracks/files will appear on the right screen.
→ To remove the track/file from the playlist, press **CLEAR**.
- 4 You can select to playback from the original disc content or from the playlist. Use ◀▶ keys to move to the correct screen before selecting the track/file for playback.

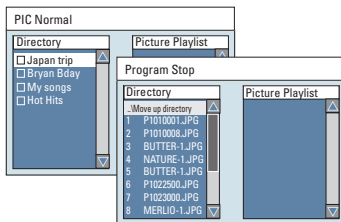

If the disc contains MP3/WMA music and JPEG picture files, you can start a musical slide show playback,

- Select an MP3/WMA file and press **OK** to start playback, then select a picture file in the menu and press **OK** to start the musical slide show playback.

- 5 During playback, press **TOOLS** twice on the remote control to access various settings for the slide show playback.

File Play	
Type	PIC
Mode	Normal
Wipe	Top to bottom
Zoom	Fitscreen
Rotate	Clockwise 0

Top to bottom
Down to top
Left to right
Right to left
Extend center V

- 6 To stop playback, press **STOP** ■.

Playable JPEG picture disc

File format:

- The file extension has to be '.JPG,' '.JPE' or '.JPEG.'
- Only DCF-standard still pictures or JPEG pictures e.g. TIFF are supported.
- Moving pictures, Motion JPEG, progressive JPEG, pictures in non-JPEG formats and including pictures associated with sound are not supported.

TIPS: Some discs cannot be played on this recorder due to the configuration and characteristics of the disc, or due to the condition of recording and authoring software.

Playback (continued)

Playing a DivX disc

This recorder supports the playback of DivX movies which you can copy from your computer onto a CD-R/RW, recordable DVD or USB flash drive.

- 1 Insert a DivX disc.
→ The disc content menu appears.
- If the DivX movie contains external subtitles, you have to first select the subtitle file from the file list.
- 2 Press **PLAY/PAUSE ►II** to start playback.
- During playback, you can press **TOOLS** to display the disc content menu.

To select another character set for the subtitle file,

- During playback, press **TOOLS** once to show the disc content menu. Press **TOOLS** again to access various settings for the slide show playback.

File Play	
Type	Video
Mode	Normal
Character	Standard Set
Audio	Stereo
Time	0:01:31/ 0:41:35
LANG	Language 1

Western European
Standard
Central European
Cyrillic
Greek

- Use **▲▼** keys to select { **Character** } and press **►** to access the options. Select the preferred subtitle set and press **OK** to confirm.

Helpful Hints:

- Subtitle files with the following filename extensions (.srt, .smi, .sub, .sami) are supported.
- It is normal to experience an occasional pixelation during DivX playback due to poor clarity of digital contents during internet downloading.

Playing from a USB flash drive /USB memory card reader

This USB port supports the playback of JPEG/MP3/WMA and DivX files.

- 1 Insert a USB flash drive or USB memory card reader into the USB port.
- 2 Press **USB** on the remote control to access the data in the drive.
→ The content menu appears on the TV.
- 3 Use **▲▼** keys to navigate within the menu and select the file you want to play, then press **OK**.
→ For more playback information, refer to the previous sections on MP3/WMA and DivX playback in this user manual.
- 4 To stop playback, press **STOP ■** or remove the USB flash drive / USB memory card reader from the USB port.

TIPS: Some discs cannot be played on this recorder due to the configuration and characteristics of the disc, or due to the condition of recording and authoring software.

Additional Playback Features

Changing to another chapter/ track

When a disc contains more than one chapter or track, you can change to a different chapter or track as follows.

During playback,

- Press ► (NEXT) to go to the next chapter/track.
- Press ◀ (PREV) to return to the start of the previous chapter/track.
Alternatively,
- Use the **numeric keypad 0-9** to input the title/chapter/track number.
Alternatively,
- Press **TOOLS** to enter the file play (DVD, VCD) menu and use ▲▼ keys to select { **Title** } or { **Chapter** } and use **numeric keypad 0-9** to input the title/chapter/track number.

Pausing playback

- 1 During playback, press **PLAY/PAUSE** ►|| to pause playback.
- 2 To resume normal playback, press ►|| again.

Searching forwards/ backwards

You can search forward or backward on a disc at two, four, sixteen or thirty two times the normal playback speed.

- 1 During playback, press ◀◀ (REW) or ▶▶ (FFW) to switch to the search function.
→ The search status bar appears. It displays the search speed.
→ The sound will be muted.
- 2 Press ◀◀ (REW) or ▶▶ (FFW) to cycle through the search speeds.
- 3 To resume normal playback, press **PLAY/PAUSE** ►||.

TIPS: The operating features described here might not be possible for certain discs. Always refer to the instructions supplied with the discs.

Additional Playback Features (continued)

Using the TOOLS options

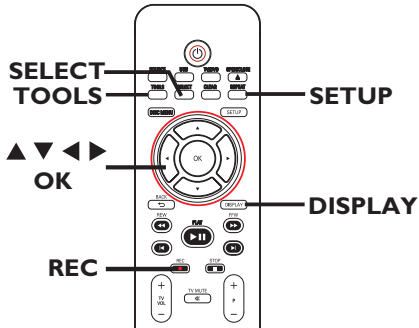

Menu options displayed may differ depending on the disc type.

- 1 During disc playback, press **TOOLS** on the remote control.
→ The Tools menu appears.

DVD	00:22:03 / 01:30:26
Mode	Normal ▶
Title	01/02
Chapter	03/12
Audio	01/02 - 0TH
Subtitle	Off
Angle	01/03
Title	00:22:03 / 01:30:26

- 2 Use ▲▼ keys to select the setting you want to adjust.
→ Instructions and explanations of the options are provided in the following pages.
→ If the selection in the menu is greyed out, that means the feature is not available or cannot be changed in the current state.
- Press **DISPLAY** on the remote control to hide or show the DVD menu.
- 3 To exit, press **TOOLS**.

Selecting various repeat/ shuffle functions

You can select various repeat play or random play mode during playback.

- During disc playback, press **REPEAT** repeatedly to toggle through the options on the disc.
Alternatively,
- 1 During disc playback, press **TOOLS** on the remote control.
→ The Tools menu appears.
- 2 Use ▲▼ keys to select { **Mode** } and press **OK**.
- 3 Use ▲▼ keys to select one of the repeat options.

{ **Repeat A-B** } (DVD/VCD)

Repeat the playback of a specific segment within a title/chapter/track. Press **OK** to mark the start and end of the segment you want to repeat.

{ **Repeat Chapter** }

Repeat playback of the current chapter (DVD, recorded DVD only).

{ **Repeat Track/Title** }

Repeat playback of the current track/title.

{ **Repeat Directory** }

Repeat playback of the current folder/ directory (MP3, JPEG, picture disc only).

{ **Repeat Disc** }

Repeat playback of the entire disc. (MP3, JPEG, SVCD and CDDA discs only).

{ **Shuffle** }

Randomly playback all the tracks within the disc (MP3/DivX/WMA and audio CDs).

{ **Normal** }

Cancel the repeat or programmed modes and return to normal playback.

- 4 To cancel repeat playback, press **STOP** ■ or select { **Normal** } and press **OK**.

TIPS: The operating features described here might not be possible for certain discs. Always refer to the instructions supplied with the discs.

Additional Playback Features (continued)

Creating a playlist

You can play the contents of the disc in the order you want by creating a playlist.

- 1 During disc playback, press **TOOLS** on the remote control.
→ The Tools menu appears.
- 2 Select { **Mode** } > { **Program** }.
→ The programme menu appears.

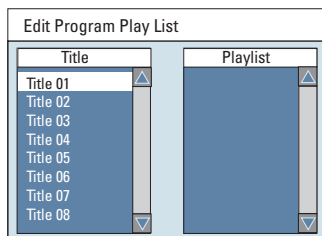

- 3 If the disc is recorded with Titles/Folders/Albums, press **OK** to access the tracks/files/chapters.
- 4 Use **▲▼** keys to select the track/file/chapter and press **SELECT** on the remote control.
→ The selected track/ file/ title will appear in the { **Playlist** } screen at the right.

To remove from the playlist

- 5 Move to the right screen, select the item to remove and press **CLEAR** on the remote control.
- 6 To start playback from the playlist, move to the right screen and press **OK**.
→ Playback will start from the selected track/ file/ chapter according to the order of the playlist.
- 7 To exit playlist play, press **STOP ■**.

Changing the audio language

This operation works only on DVDs with multiple soundtrack language or VCDs with multiple audio channels.

- During disc playback, press **AUDIO** repeatedly to toggle through the audio channels on the disc.

Alternatively,

- 1 During disc playback, press **TOOLS** on the remote control.
→ The Tools menu appears.
- 2 Use **▲▼** keys to select { **Audio** } and press **▶** to access its options.
- 3 Use **▲▼** keys to select the audio language and press **OK** to confirm.
→ The languages may be numbered or abbreviated, such as “En” for English.
→ If the language selected is not available on the disc, the disc’s default setting for language will be used instead.

Helpful Hint:

– Some DVDs allow soundtrack language changes only via the DVD disc menu. To access the disc menu, press **DISC MENU**.

TIPS: The operating features described here might not be possible for certain discs. Always refer to the instructions supplied with the discs.

Additional Playback Features (continued)

Changing subtitle languages

This operation works only on DVDs with multiple subtitle languages, you can to change the language you want during playback of the DVD.

- During disc playback, press **SUBTITLE** repeatedly to toggle through the language options on the disc.

Alternatively,

- 1 During disc playback, press **TOOLS** on the remote control.
→ The Tools menu appears.
- 2 Use ▲▼ keys to select { **Subtitle** } and press ► to access its options.
- 3 Use ▲▼ keys to select the language and press **OK** to confirm.
→ The languages may be numbered or abbreviated, such as “En” for English.
→ If the language selected is not available on the disc, the disc’s default setting language will be used instead.

Helpful Hint:

– Some DVDs discs allow subtitle language changes only via the DVD disc menu. To access the disc menu, press **DISC MENU**.

Switching camera angles

This option is only available with DVDs that contain sequences recorded from different camera angles. This allows you to view the picture from different angles.

- 1 During disc playback, press **TOOLS** on the remote control.
→ The Tools menu appears.
- 2 Use ▲▼ keys to select { **Angle** } and press ► to enter its options.
→ The camera angles available for selection appears.
- 3 Use ▲▼ keys to select the camera angle you want to switch to, and press **OK** to confirm.

Searching by time

This option allows you to skip to a specific point on the current disc.

- 1 During disc playback, press **TOOLS** on the remote control.
→ The Tools menu appears.
- 2 Use ▲▼ keys to select { **Search** } and press ► to time field (hours : minutes : seconds).
- 3 Use the **numeric keypad 0-9** to enter the time where playback should start and press **OK**.
→ Playback skips to the time entered.

TIPS: The operating features described here might not be possible for certain discs. Always refer to the instructions supplied with the discs.

Editing/ Finalising Recording

About disc editing

This recorder offers various disc edit options for various disc types. You can change the disc content and settings of a recorded DVD from the disc editing menu. The edited contents may not be available when you play the disc on another DVD player.

The displayed options in the disc editing menu differ depending on the type of disc.

{ Play }

Start playback from the beginning of the disc.

{ Rename Disc }

Change the name of the disc.

{ Erase Disc } - DVD±RW only

Erase all the recordings on the disc.

{ Record New Title }

Start recording from the last empty title on the disc.

{ Overwrite Disc } - DVD±RW only

Start a new recording from the beginning of the disc, all the recorded content will be overwritten.

{ Make Compatible } - DVD±RW only

To ensure the edited changes remain when the disc is played back on another DVD player. (eg., hidden chapters to remain hidden).

{ Lock/Unlock Disc } - DVD±RW only

Lock or unlock a disc to prevent accidental erasure or changes being made.

{ Finalize Disc } - DVD±R only

Finalise the disc to enable playback on other DVD players. Further recording and editing to the disc are not allowed. It is not possible to unfinalise the disc.

Accessing disc editing menu

- 1 Insert a recorded DVD±R/±RW into the recorder.
→ The Index Picture screen appears on the TV.
- 2 Select the first title on the disc, press ▲ on the remote control.
→ The disc editing menu appears.
- 3 Press ► on the remote control to display the disc editing options.
→ The available editing options are different for DVD±R and DVD±RW discs.

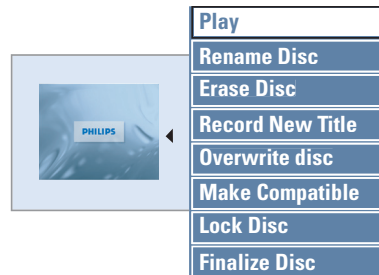

- 4 Use ▲▼ keys to access different options and **OK** to select.
→ Instructions and explanations of the options are provided in the following pages.
- 5 To exit from the disc editing menu, press ◀ once to exit from the disc editing menu. Press ▼ to return to the disc Index Picture menu.

TIPS: No further recording and editing can be carried out on a full or finalised DVD±R. Press ◀ to go back to the previous menu. Press **DISC MENU** to exit.

Editing/ Finalising Recording (continued)

Rename disc

The original disc name is generated automatically by the recorder. You can change the disc name by following the steps below.

- 1 In disc editing menu, use ▲▼ keys to select { **Rename Disc** } and press **OK**.
→ The keyboard screen appears.
- 2 Use ◀▶▲▼ keys to highlight a character on the keyboard and press **OK** to select.
→ The maximum input is up to 20 characters.
- You can use the following keys on the keyboard screen to edit your input:
 - : to remove the character to the left of the cursor.
 - : to remove the character to the right of the cursor.
 - : to create a space between characters.
 - : to toggle between upper and lower case characters.
 - : to clear the entry field completely.
- 3 To confirm your entry, select on the keyboard and press **OK**.
→ The info panel is now updated.
- To cancel the changes, select on the keyboard and press **OK**.

Erase disc (DVD±RW only)

This erases the content of the DVD±RW including those that was not recorded on this recorder. Once the existing content is erased, it can be used for recording again.

- 1 In disc editing menu, use ▲▼ keys to select { **Erase Disc** } and press **OK**.
→ A warning message will appear.
- 2 Select in the menu to proceed or to abort, then press **OK** to confirm.

Record new title

This function allows you to start a new recording at the remaining empty space in the DVD±RW.

- 1 In disc editing menu, use ▲▼ keys to select { **Record New Title** } and press **OK**.
- 2 Select the source you want to record from and press **REC** ● to start recording.

Overwrite disc (DVD±RW only)

This function allows you to start a new recording from the beginning of a DVD±RW regardless of the contents of the disc.

- 1 In disc editing menu, use ▲▼ keys to select { **Overwrite disc** } and press **OK**.
- 2 Select the source you want to record from and press **REC** ● to start recording.

TIPS: No further recording and editing can be carried out on a full or finalised DVD±R. Press ◀ to go back to the previous menu. Press **DISC MENU** to exit.

Editing/ Finalising Recording (continued)

Make compatible (DVD±RW only)

The edited DVD±RW may still display the original titles or hidden scenes when played back on other DVD players. This function ensures that the edited changes of the DVD±RW remain when played back on other players.

- In disc editing menu, use ▲▼ keys to select { **Make Compatible** } and press **OK** to confirm.

Helpful Hint:

– If the option {Compatible} is not available for selection, it means that the disc is already compatible.

Lock/Unlock disc (DVD±RW only)

You can choose to protect the recorded DVD±RW in order to prevent accidental loss of recordings.

- 1 In disc editing menu, use ▲▼ keys to select { **Lock Disc** } and press **OK**.
 - The disc is locked for this DVD recorder only.
 - When the disc is locked, the option in the disc editing menu will change to { **Unlock Disc** }.
- 2 If you want to overwrite or edit on the protected disc, select { **Unlock Disc** }.

Playing your recordings on other DVD players (DVD±R only)

It is necessary to finalise a DVD±R disc before you can play it on another DVD player. Otherwise, the DVD±R will only playback on this recorder.

After a DVD±R disc has been finalised, no further recordings or editing can be made to it. Make sure that you have completed all the recordings and editing before finalising the disc.

- 1 In disc editing menu, use ▲▼ keys to select { **Finalise Disc** } and press **OK**.
 - A warning message will appear.
 - 2 Select **YES** in the menu and press **OK** to start the process.
 - Finalisation will take a few minutes, depending on the length of recordings.
 - Do not try to open the disc tray or turn off the power as this may render the disc unusable.
- Otherwise, select **NO** in the menu and press **OK** to abort the operation.

TIPS: No further recording and editing can be carried out on a full or finalised DVD±R. Press ◀ to go back to the previous menu. Press **DISC MENU** to exit.

Editing/ Finalising Recording (continued)

About title editing

You can change the individual title information or delete a title (recording) in a recorded DVD. If a DVD±R has been finalised, it cannot be edited.

The displayed options in the title editing menu differ depending on the type of disc.

{ Play Title }

Start playing a recording.

{ Edit Title }

Access the video editing menu.

{ Rename Title }

Change the name of the recording.

{ Erase Title } - DVD±RW only

Delete the title (recording).

{ Overwrite Title } - DVD±RW only

Start a new recording, the existing title (recording) will be overwritten.

{ Overwrite Disc } - DVD±RW only

Overwrite from the selected title onwards to the end of the disc.

{ Append Title }

Insert a new recording to the last existing recording.

Accessing title editing menu

- 1 Insert a recorded DVD±R/±RW into the recorder.
→ The Index Picture screen appears on the TV.
- 2 During playback, press **DISC MENU** to access the Index Picture screen.
- 2 Use **▲▼** keys to highlight a title (recording), and press **▶**.
→ The title editing menu appears.

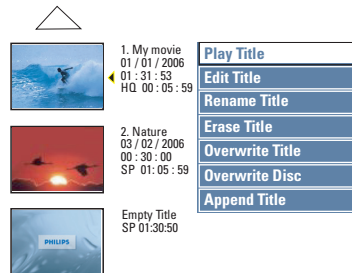

- 3 Use **▲▼** keys to access different options and **OK** to select.
→ Instructions and explanation of the options are provided in the following pages.
- 4 To exit, press **◀**.

Video editing

This feature allows access to the video editing menu. See the chapter “Editing/ Finalising Recording – About video editing” for more information.

- In title editing menu, use **▲▼** keys to select { **Edit Title** } and press **OK**.
→ The video editing menu appears.
→ The recorder will play the selected title.

TIPS: No further recording and editing can be carried out on a full or finalised DVD±R. Press **◀** to go back to the previous menu.

Editing/ Finalising Recording (continued)

Rename title

The original title name is generated automatically by the recorder. You can give a new name to the title by following the steps below.

- 1 In title editing menu, use ▲▼ keys to select { **Rename Title** } and press **OK**.
→ The keyboard screen appears.
- 2 Use ◀▶ ▲▼ keys to highlight a character and press **OK** to select.
→ The maximum input is up to 9 characters.
- You can use the following keys on the keyboard screen to edit your input:
 - : to remove the character to the left of the cursor.
 - : to remove the character to the right of the cursor.
 - : to create a space between characters.
 - : to toggle between upper and lower case characters.
 - : to clear the entry field completely.
- 3 To confirm your entry, select on the keyboard and press **OK**.
→ The info panel is now updated.
- To cancel the changes, select on the keyboard and press **OK**.

Erase title (DVD±RW only)

You can delete a specific title (recording) from the disc.

- 1 In title editing menu, use ▲▼ keys to select { **Erase Title** } and press **OK**.
→ A warning message will appear.
- 2 Select in the menu to proceed or to abort, then press **OK**.

Overwrite title (DVD±RW only)

This function allows you to overwrite the selected title in the DVD±RW. The other titles will not be affected.

- 1 In title editing menu, use ▲▼ keys to select { **Overwrite Title** } and press **OK**.
- 2 Select the source you want to record from and press **REC** ● to start overwriting.

Overwrite from the selected title

You can select to overwrite only the recordings from the selected title to the end of the disc.

- In title editing menu, use ▲▼ keys to select { **Overwrite Disc** } and press **OK** to confirm.

Append recording

This function allows you to append recording to the last existing title.

- 1 In title editing menu, use ▲▼ keys to select { **Append Title** } and press **OK**.
- 2 Press **SOURCE** to select the input channel to append.
- 3 Press **REC** ● to start append recording.
- 4 To stop append recording, press **STOP** ■.

TIPS: No further recording and editing can be carried out on a full or finalised DVD±R. Press ◀ to go back to the previous menu.

Editing/ Finalising Recording (continued)

About video editing

After a recording has been made, this recorder allows you to edit the video content. You can add/delete chapter markers, hide unwanted scenes, change the picture in the index picture screen and split a title (recording) into two.

When you playback a recording in video edit mode, the entire recording will be played back including hidden scenes.

The edit functions available in the disc editing menu are:

{ Title }

Select a title (recording) to play.

{ Chapter }

Select a chapter within the selected title.

{ Chapter Marker }

Insert a chapter marker in the recording or erase a chapter marker to combine two chapters.

{ Hide Chapter }

Hide the unwanted scene in the recording.

{ Index Picture }

Select a scene in the recording as the index picture screen.

{ Split Title } – DVD±RW only

Divide the recording into two separate titles.

Accessing video editing menu

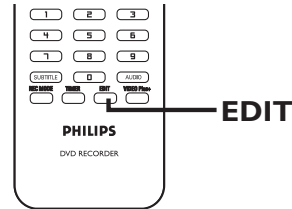

- 1 Insert a recorded DVD±R/±RW into the recorder.
→ The Index Picture screen appears on the TV.
- 2 Use ▲▼ keys to select a title (recording).
- 3 Press ►|| to start playback.
- 4 Press **EDIT** on the remote control.
→ The video editing menu appears.

Edit Mode	0:03:28
Title 02/06	
Chapter 01/10	
Chapter Marker	
Hide Chapter	
Index Picture	
Split Title	

- 5 Use ▲▼ keys to access different options and press **OK** to select.
→ Instructions and explanations of the options are provided in the following pages.
- 6 To exit, press **EDIT**.

TIPS: No further recording and editing can be carried out on a full or finalised DVD±R. Press ◀ to go back to the previous menu.

Editing/ Finalising Recording (continued)

Selecting a title

This option shows the current title and the total number of titles in the disc. It also allows you to select a specific title.

- 1 During playback, press **EDIT** to display the video editing menu.
- 2 Use **▲▼** keys to select { **Title** } and press **OK**.
- 3 Use the **numeric keypad 0-9** to key in a title and press **OK**.
→ The recorder will play the selected title.

Selecting a chapter

This option shows the current chapter and the total number of chapters in the title. It also allows you to select a specific chapter within the title.

- 1 During playback, press **EDIT** to display the video editing menu.
- 2 Use **▲▼** keys to select { **Chapter** } and press **OK**.
- 3 Use the **numeric keypad 0-9** to key in the chapter and press **OK**.
→ The recorder will play the selected chapter.

Creating chapter marker

You can create a chapter by inserting chapter markers at any point within a title during playback. This will allow you to access a specific point in the recording easily or set a chapter you wish to hide.

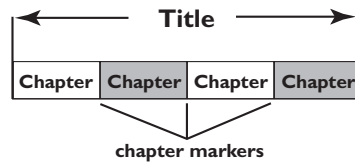

- 1 During playback, press **EDIT** to display the video editing menu.
- 2 Use **▲▼** keys to select { **Chapter Marker** } and press **OK**.
- 3 Use **▲▼** keys to select one of the options and press **OK** to confirm.

{ **Insert Marker** }

Select this to insert a new chapter marker at the current point of playback.

{ **Delete Marker** }

Select this to delete the current chapter marker (it refers to the closest marker before the current point of playback).

{ **Delete All Markers** }

Select this to delete all the chapter markers in the current title.

TIPS: No further recording and editing can be carried out on a full or finalised DVD±R. Press **◀** to go back to the previous menu.

Editing/ Finalising Recording (continued)

Hiding unwanted scenes

You can choose to hide certain scenes from playback (e.g. skipping a commercial scene) or make it visible again.

- 1 Create a chapter marker at the start and end of the scene you want to hide. (See previous page on "Creating Chapter Marker").
- 2 Select the chapter you want to hide and start playback. (See previous page on "Selecting a chapter").
- 3 During playback, press **EDIT** to display the video editing menu.
- 4 Use **▲▼** keys to select { **Hide Chapter** } and press **OK**.
→ The current chapter will be hidden.

To unhide a chapter

- 1 Press **EDIT** on the remote control during playback.
→ The video editing menu appears.
→ While in editing mode, the hidden chapter/chapters will be played back.
- 2 Wait for the chapter you want to unhide to occur or use **◀▶** keys on the remote control to make a fast search.
- 3 Use **▲▼** keys to select { **Unhide Chapter** } and press **OK**.
→ The current chapter will be visible during playback.

Helpful Hints:

- All the hidden chapters will be played back while in video editing mode.
- To locate a specific frame during playback, press **▶||** and the **▶** key to forward search to the frame that you want.

Changing Index Picture

The index picture is the picture of the title you will see when the recorder loads up the Index menu. Normally, the first frame of a recording is shown as the title's index picture.

- 1 During playback, press **EDIT** to display the video editing menu, then use **▲▼** keys to highlight { **Index Picture** }.
- 2 Press **▶||** to pause playback.
- 3 Press **▶** to search for the desired frame and press **OK** to select the current frame as the index picture for the title.

Splitting a title (DVD±RW only)

You can divide the current title into two new titles. Each of these titles is characterised by its own index picture.

Warning! Once a title is divided, the process cannot be reversed.

- 1 During playback, press **EDIT** to display the video editing menu, then use **▲▼** keys to highlight { **Split Title** }.
- 2 Press **▶||** to pause playback.
- 3 Press **▶** to search for the desired frame, and press **OK** to divide the title at the current frame.
→ A new title will be shown at the Index Picture screen.

TIPS: No further recording and editing can be carried out on a full or finalised DVD±R. Press **◀** to go back to the previous menu.

DVD Setup Menu Options

Accessing the Setup Menu

The setup menu provides various options for you to adjust the recorder to suit your preferences.

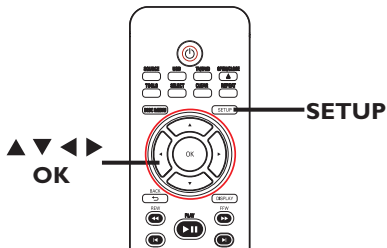

- 1 Press **SETUP** on the remote control.
→ The setup menu appears on TV.
- 2 Use **▲▼** keys to highlight a menu item and press **▶** to access its options.
- 3 Use **▲▼** keys to highlight the setting you wish to change and press **OK** to confirm and go back to the previous menu item.
→ Instructions and explanations of the options are provided in the following pages.
- 4 To exit, press **SETUP**.

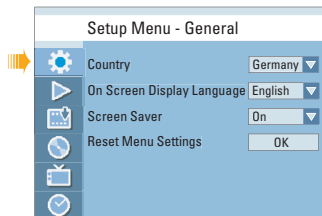

See this chapter – “GENERAL Settings”

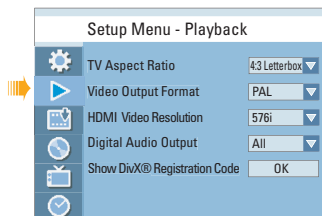

See this chapter – “PLAYBACK Settings”

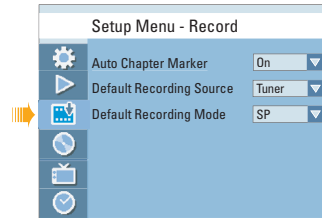

See Recording chapter – “RECORD Settings”



See this chapter – “DVD Settings”

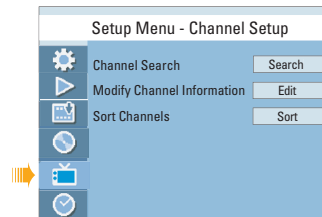

See this chapter “CHANNEL SETUP Settings”

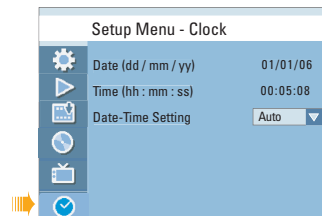

See this chapter “CLOCK Settings”

DVD Setup Menu Options (continued)

GENERAL settings (underlined options are the factory default settings)

Country Select the country of your area for auto channel tuning. (See section "Step 3: Installation and Setup - Select the country of your residence").

On-Screen Display Language Select the menu language for this recorder on-screen display.

Screen Saver The screen saver prevents damage to the TV screen by avoiding exposure to a static image for too long.

{ On } – Switches to TV screen saver mode when playback has been stopped or paused for longer than 15 minutes.

{ **Off** } – Turns off the screen saver function.

Reset Menu Settings Restore all the settings of this recorder, except for the PIN code. **Reset Menu settings can only be changed when there is no disc in the disc tray.**



- 1) Press **OK** to confirm the default restore.
- 2) A warning message will appear. Select in the menu to proceed or to abort, then press **OK** to confirm.

DVD Setup Menu Options (continued)

PLAYBACK settings (underlined options are the factory default settings)

TV Aspect Ratio

Set the aspect ratio of the recorder according to the TV type you have connected.

- { **16:9** } – Select this for wide screen TV (frame ratio 16:9). 
- { **4:3 Letterbox** } – Select this for a 'wide screen' display with black bands on the upper and lower portions of the TV screen. 
- { **4:3 Panscan** } – Select this for a full-height picture with both side trimmed. 

Video Output Format

The colour system of the DVD system, DVD and TV should match. Only then will it be possible to play a DVD on this system. Before changing the TV system, determine the colour system of your TV.

- { **NTSC** } – Select this if the connected TV has the NTSC colour system. It will change the video signal of a PAL disc and output it to NTSC format.
- { **PAL** } – Select this if the connected TV has the PAL colour system. It will change the video signal of an NTSC disc and output it to PAL format.

Note: If a blank/distorted TV screen appears, wait for 15 seconds for the auto recovery.

HDMI Video Resolution

This feature is only applicable if you have connected a HDMI device. Select the video resolution depending on the capability of the connected HDMI TV/device: { **480i** }, { **480p** }, { **576i** }, { **576p** }

Digital Audio Output

Adjust the digital output setting only if you have connected other devices to the coaxial socket on the recorder.

- { **All** } – Select this if you have used the COAXIAL socket on the recorder to connect to a stereo receiver that has a built in multichannel decoder.
- { **LPCM** } – Select this if the connected audio equipment is not capable of decoding multichannel audio. Dolby Digital and MPEG-2 multi-channel signals are converted to PCM (Pulse Code Modulation).

DVD Setup Menu Options (continued)

English

PLAYBACK settings (underlined options are the factory default settings)

Show DivX® Registration code

Display the DivX® VOD (Video On Demand) registration code that allows you to rent and purchase videos using the DivX® VOD service. For more information, visit www.divx.com/vod.

- 1) Press ► to display the registration code.
- 2) Use the registration code to purchase or rent videos from DivX® VOD service at www.divx.com/vod. Follow the instructions and copy the video from your computer onto a CD-R/RW or recordable DVD disc for playback on this recorder.

DVD Setup Menu Options (continued)

DVD settings (underlined options are the factory default settings)

Default Disc Menu Language

Select the preferred disc menu language for DVD playback.

Default Subtitle Language

Select the preferred subtitle language for DVD playback.

Default Audio Language

Select the preferred audio language for DVD playback.

Notes:

- If the selected audio/subtitle language is not available on the disc, the disc's default setting language will be used instead.
- For some DVDs, the subtitle/audio language can only be changed via the DVD disc menu.

Parental Rating Level

Some DVDs may have a parental level assigned to the complete disc or to certain scenes on the disc. This feature lets you set a playback limitation level.

- 1) Use **▲▼** keys to select { **Parental Rating Level** } and press **OK**.
- 2) Use the **numeric keypad 0-9** to enter your four-digit pin code.

Note: When doing this for the first time or if you forget your four-digit pin code, enter the default password '3308'.

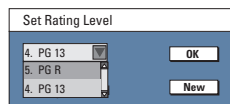
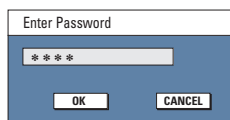

- 3) Move to **OK** in the menu and press **OK** on the remote control. The set rating level menu appears.
- 4) Use **▲▼** keys to select the desired parental level, then move to **OK** in the menu and press **OK** on the remote control to confirm.

Notes:

- The rating levels range from 1 to 8 and are country dependent. DVDs that are rated higher than the level you have selected will not play unless you enter your four-digit pin code.
- To disable parental controls and allow all discs to play, select { **Off** }.
- VCD, SVCD, CDs have no level indication, so parental control has no effect on these type of discs. This also applies to most illegal DVDs.
- Some DVDs are not coded with a rating though the movie rating may be printed on the disc cover. The rating level feature does not prohibit playback of such discs.

DVD Setup Menu Options (continued)

DVD settings

Parental Rating Level

New Password

New password

Confirm password

To change/ reset the password

- 1) Use **▲▼** keys to select { **Parental Rating Level** } and press **OK**.
- 2) Use the **numeric keypad 0-9** to enter your four-digit pin code.
- 3) Move to in the menu and press **OK** on the remote control. The set rating level menu appears.
- 4) Move to in the menu and press **OK** to access new password menu.
- 5) Use the **numeric keypad 0-9** to enter your new four-digit pin code, then press **▼** to select the next entry field and enter the same pin code a second time.
- 6) Move to in the menu and press **OK** to confirm.

Note: To abort the change, select and press **OK**.

DVD Setup Menu Options (continued)

CHANNEL SETUP settings

Channel Search

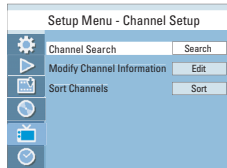

Automatically scans all the receivable analogue local TV channels and stores these channels on the recorder.

Press **OK** on the remote control to start the automatic TV channel search process and replace all previously stored analogue TV channels. This process may take several minutes.

Modify Channel Information

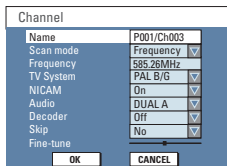

Adjust a stored TV channel to your preference and improve the reception and the sound quality of that TV channel.

- 1) Use **▲▼** keys to highlight { **Modify Channel Information** } and press **OK** to view the channel menu.
- 2) Use **▲▼** keys to select one of the options and press **OK**.

- { **Name** }
 - Use the **numeric keypad 0-9** to select the channel preset number that you wish to change.
 - To rename the channel, press **►**.
 - Use **◀▶▲▼** keys to highlight a character in the keyboard screen and press **OK** to select. The maximum input is up to 5 (five) characters.
 - Select **OK** on the keyboard to confirm your entry or **EXIT** to abort, then press **OK** to exit.
- { **Scan Mode** } – Select TV channel search mode based on channel allocation or frequency (Channel, S-Channel or Frequency) and press **OK** to confirm.
- { **Frequency** } – Show the frequency of the current TV channel. If required, use **◀▶** keys to manually search and press **OK** to confirm.
- { **TV System** } – Use **▲▼** keys to select a suitable TV system that produces the least distortion of picture and sound, then press **OK** to confirm. (See chapter “TV System Guide” at the back of this manual for more information).

DVD Setup Menu Options (continued)

CHANNEL SETUP settings

Modify Channel Information

Channel	
Name	P001/CH003
Scan mode	Frequency
Frequency	555.26MHz
TV System	PAL B/G
NICAM	On
Audio	DUAL A
Decoder	Off
Skip	No
Fine-tune	

OK CANCEL

Adjust a stored TV channel to your preference and improve the reception and the sound quality of that TV channel.

- { **NICAM** }
- NICAM is a digital sound transmission system. It can transmit either one stereo channel or two separate mono channels.
 - { **On** } – Improve the sound transmission of the TV channel.
 - { **Off** } – Select this if the reception is poor and the sound is distorted.
- { **Audio** }
- For bilingual TV programmes, you can switch between stereo (original) and additional audio language.
 - { **DUAL A** } – Original broadcast language.
 - { **DUAL B** } – Additional audio language.
- { **Decoder** }
- If the current TV channel is transmitted by coded TV signals that can only be viewed properly with a decoder which is connected to the EXT2 AUX-I/O scart socket, you need to activate the connected decoder.
 - { **On** } – Select this to allocate the connected decoder to this TV channel.
 - { **Off** } – Turn off the decoder feature.
- { **Skip** }
- Select this to set the channel to be skipped.
 - { **No** } – The TV channel can be accessed using the **P +** – on the remote control.
 - { **Yes** } – The TV channel can only be accessed by pressing the corresponding number button on the remote control.
- { **Fine-Tune** }
- Select this to fine-tune the TV channel manually if the reception is poor. Use ◀▶ keys to adjust the frequency and press **OK** to confirm.

DVD Setup Menu Options (continued)

CHANNEL SETUP settings

Sort Channels

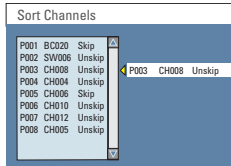

Rearrange the stored TV channels.

- 1) Use ▲▼ keys to highlight { **Sort Channels** } and press **OK** to show a list of TV channel programmes.
- 2) Use ▲▼ keys to highlight the channel you want to change and press **OK**.
- 3) Use ▲▼ keys to shift the TV channel to the desired position and press **OK** again. The selected channel will be inserted before the current position.

Note: Press **BACK** on the remote control to go back to the previous menu.

CLOCK settings (underlined options are the factory default settings)

Date (dd/mm/yy)

Use ▲▼ keys to change the number and use ◀▶ keys to select different entry fields, then press **OK** to confirm.

Time (hh:mm:ss)

Use ▲▼ keys to change the number and use ◀▶ keys to select different entry fields, then press **OK** to confirm.

Date-Time Setting

Enable/disable the automatic setting of date and time. This feature is dependent on your local broadcaster.

- { Auto } – Select to activate automatic setting of date and time.
- { **Manual** } – Select this to manually set the date and time.

Software Upgrade

Installing the latest software

The software installed in your recorder is continuously being refined for greater stability and compatibility of the set. Periodically, Philips will issue upgrades for the software which you copy onto a CD and install the software of your recorder.

Caution! Power supply must not be interrupted during upgrade!

- Visit Philips' website at 'www.philips.com/support' to check for the availability of the latest software upgrade.

Note: When checking for the latest software upgrade, please also check for any accompanying instructions on installing the software.

Specifications

Picture/Display

- Aspect ratio: 4:3, 16:9
- D/A converter: 10 bit, 54 MHz
- A/D converter: 10 bit, 27 MHz

Sound

- D/A converter: 24 bit, 192 kHz
- A/D converter: 24 bit, 96 kHz
- Signal to noise ratio: 102 dB
- Crosstalk (1kHz): 105 dB
- Dynamic Range (1kHz): 90 dB

Video Recording

- Recording system: PAL
- Compression formats: MPEG2
- Recording modes:
 - High Quality : HQ
 - Standard Play : SP
 - Standard Play Plus : SPP
 - Long Play : LP
 - Extended Play : EP
 - Super Long Play : SLP
- Audio compression: Dolby Digital

Video Playback

- Disc playback media: CD, CD-R/-RW, DVD, DVD-Video, DVD+R/+RW, DVD-R/-RW SVCD, Video CD
- Compression formats: MPEG2, MPEG1, DivX
- Video disc playback system: NTSC, PAL

Audio Playback

- Disc playback media: CD, CD-R/-RW, MP3-CD, MP3-DVD, WMA
- Compression formats: Dolby Digital, DTS, MP3, MPEG2 Multichannel, PCM
- MP3 bit rates: 32~256 kbps and VBR

Still Picture Playback

- Disc formats: DVD+R/+RW, DVD-R/-RW, Picture CD
- Picture compression formats: JPEG
- Picture enhancement: Rotate

Storage Media

- Recording media: DVD+R, DVD+RW, DVD+R DL, DVD-R, DVD-RW,

Tuner/Reception/Transmission

- TV system: PAL
- Aerial Input: 75 Ohm coaxial (IEC75)

Connectivity

Front Connections:

- i.LINK DV in (IEEE 1394 4-pin)
- CVBS In (CAM 1)
- S-Video In (CAM 2)
- Audio left/right In
- USB

Rear Connections:

- SCART EXT1
- SCART EXT2
- Composite video (CVBS) Out
- S-Video Out
- HDMI Out
- Video (CVBS) Out
- Audio left/right Out
- Digital audio out (coaxial)
- RF aerial In
- RF TV Out
- Mains

Convenience

- Programming/Timer Enhancements: Daily/Weekly, Repeat Timer Programme, Manual Timer, One Touch Recording, VIDEO PLUS+®
- Programmable events: 8

Power

- Power supply: 220 – 240V; 50 Hz
- Consumption: 25 W (typical)
- Standby power consumption: < 3W

Cabinet

- Dimensions (wxhxd) : 435 x 43 x 322mm
- Net Weight : 3 kg

Troubleshooting

WARNING

Under no circumstances should you try to repair the system yourself, as this will invalidate the warranty. Do not open the system as there is a risk of electric shock.

If a fault occurs, first check the points listed below before taking the system for repair. If you are unable to remedy a problem by following these hints, consult your dealer or Philips for help.

Problem (General)	Solution
No power.	<ul style="list-style-type: none"> – Press STANDBY-ON button on the front of the recorder to switch on the system. – Make sure the AC outlet has power.
Remote control does not work.	<ul style="list-style-type: none"> – Aim the remote control directly at the sensor on the front of the DVD recorder (not towards TV). – Remove any obstacles between the recorder and the remote control. Aim the remote control towards the set at different angles and/or distances. – Batteries are weak, replace the batteries. – Press SOURCE on the remote control to select an input source.
No picture.	<ul style="list-style-type: none"> – Switch on your TV and set to the correct Video In channel. Switch the TV channel until you see the DVD screen. Read chapter “Step 3 - Installation and Setup – Finding the correct viewing channel” for details. – Check the video connection between the recorder and the TV.
No sound.	<ul style="list-style-type: none"> – Check the audio connections, the red and white sockets. Read chapter “Step 1: Basic Recorder Connections - Connecting the audio cables” for details. – Set the Digital output correctly, based on the equipment you connected to the DVD recorder. Read chapter “DVD Setup Menu Options – PLAYBACK settings – Digital Audio Output” for details.
No TV signal received from the recorder.	<ul style="list-style-type: none"> – Have your aerial or cable TV signal checked. – Install the TV channel. Read chapter “Step 3: Installation and Setup - Setting your TV channel programmes” for details.

Troubleshooting (continued)

Problem (General)	Solution
A TV channel installed during the DVD recorder's automatic TV channel search is fuzzy or distorted.	<ul style="list-style-type: none">– Check the video connection between the DVD recorder and the TV.– You can further fine-tune the signal of the TV channel. Read chapter on “DVD Setup Menu Options - CHANNEL SETUP Settings – Modify Channel Information.”– Press P +/- to search for the same TV channel which may have a clearer picture.
Unable to eject disc tray.	<ul style="list-style-type: none">– Exit from any system or recording setup menu until you see the Philips wallpaper on the screen.– Press STOP to stop any playback or recording. Then press EJECT on the set or press OPEN/CLOSE on the remote control to eject the disc tray.
The contents of the USB flash drive cannot be read.	<ul style="list-style-type: none">– The USB flash drive format is not compatible with the system.– Drive is formatted with a different file system which is not supported by this DVD system (e.g. NTFS).
Slow operation of the USB flash drive.	<ul style="list-style-type: none">– Large file size or high memory USB flash drive takes longer time to read and display on the TV.
No HDMI audio output.	<ul style="list-style-type: none">– You will not hear any sound from the HDMI output if the source device is only DVI/HDCP (High-bandwidth Digital Content Protection)-compatible.– It is not possible to output SACD or copy-controlled DVD-Audio sources from the HDMI connection.
No HDMI video output.	<ul style="list-style-type: none">– HDMI connection can only be made to HDMI-equipped devices with HDCP (High Bandwidth Digital Content Protection). If you wish to connect to a DVI connector (equipped with HDCP), you will need a separate adaptor (DVI to HDMI).– Make sure the resolution of this DVD system matches the device you have connected using the HDMI. See HDMI setting.
No display on the TV screen.	<ul style="list-style-type: none">– When the HDMI and the scart/ S-Video/Video(CVBS) sockets are used to connect to a TV at the same time, there may be no picture output from the video connection. Disconnect the HDMI cable from the TV.

Troubleshooting (continued)

English

Problem (Playback)	Solution
Disc does not play.	<ul style="list-style-type: none">- Insert the disc with the label facing up.- Wrong region code. The DVD must be coded for ALL regions or Region 2 in order to play on this DVD recorder.- There is no recording on the disc or wrong disc type. Read chapter "Playback - Playable discs" for details.- Make sure the disc is not scratched or warped. Clean the disc or replace a new one.- Check if the disc is defective by trying another disc.
Distorted sound coming from a connected hi-fi system or amplifier.	<ul style="list-style-type: none">- Do not connect any cables from the recorder to the 'Phono' input of your amplifier.- If you are playing a DTS CD, you have to connect the COAXIAL socket of this recorder to a Hi-Fi system or amplifier.
Unable to play DivX movies.	<ul style="list-style-type: none">- Ensure that the DivX file is encoded according to the 'Home Theatre Profile' with the DivX encoder.- Check that the DivX movie downloaded is a complete file.
The picture is distorted or black and white during playback.	<ul style="list-style-type: none">- The disc does not match with the TV colour system standard (PAL/NTSC). Change the { Video Output format } in { Setup Menu - General }.- The disc is dirty, clean the disc.- Sometimes a small amount of picture distortion may appear. This is not a malfunction.
There is picture or sound interference with the TV reception.	<ul style="list-style-type: none">- Have your aerial or cable TV signal checked.- Do not tie the cables of the connected equipments together.- Fine-tune your TV channel. Read chapter "Installation and Setup - Setting your TV channel programs" for details.
The message 'UNKNOWN DISC' appears.	<ul style="list-style-type: none">- This message may appear if you insert a disc that may have encountered one of the following:<ul style="list-style-type: none">- Error during recording: The title may be missing.- Error while changing the title/index picture: The original title/index picture may be visible.- Error while finalizing or the disc has not been finalised.

Troubleshooting (continued)

Problem (Recording)	Solution
The wrong TV channel was decoded (recorded) after you programmed a recording using the VIDEO Plus+® system.	<ol style="list-style-type: none">1) Press the VIDEO Plus+ key on the remote control, enter the PlusCode programming number of the desired TV channel.2) Press OK to confirm.3) Check the channel number in the {Program #} input field. If this does not correspond to the desired TV channel, select this entry field and change the channel number.4) Press OK to confirm.
Picture is fuzzy and brightness varies when copying DVD Video discs or prerecorded video tapes.	<ul style="list-style-type: none">– This happens if you try to copy DVDs or video tapes that have been copy-protected. Even though the picture on the TV is fine, but the recording on the recordable DVD disc is faulty. This interference is unavoidable with copy-protected DVDs or video tapes.– The recordable DVD disc has a limited recording lifetime, please change a new disc for recording.
Recordings are not occurring as scheduled. New recordings cannot be made.	<ul style="list-style-type: none">– The TV channel you want to record is not stored or you selected the wrong program number. Check TV channels stored.– If you adjust the clock after you set a timer recording, you have to reset the timer recording.– If the recorder cannot read the disc, you cannot record.– You cannot use the recorder to duplicate copyrighted materials (DVDs or videotapes) onto a DVD±R/±RW.– A finalised recordable DVD has been inserted. Change disc.
A DVD±R/±RW, DVD+R DL disc recorded on this DVD recorder does not playback on a DVD player.	<ul style="list-style-type: none">– If a recording is too short, it is possible that a DVD player cannot detect it. Please observe the following 'minimum recording times'. Mode of record quality: {High Quality - HQ} – 5 minutes, {Standard Play - SP} – 10 minutes, {Standard Play Plus - SPP} – 13 minutes, {Long Play - LP} – 15 minutes, {Extended Play - EP} – 20 minutes, {Super Long Play - SLP} – 30 minutes.– You have to finalise the DVD±R. Refer to chapter "Playing your recordings on other DVD players (DVD±R)" for details.
The picture on my decoder appears to be distorted during recording.	<ul style="list-style-type: none">– If you are recording a programme from your decoder box, you can view the same programme by pressing TV/DVD on the recorder's remote control.

Frequently Asked Questions

What kind of disc should I use for recording?

You can only record on DVD±R, DVD±RW or DVD+R DL discs. They are compatible with DVD-Video players and DVD-ROM drives in computers.

What is the capacity of a DVD±R/+RW disc?

4.7GB, or equivalent to six CDs. You can store only one hour of recordings on a single disc at the highest quality (DVD standard) and about 6 hours recording at the lowest quality (VHS standard).

What is the difference between DVD±R and DVD±RW?

DVD±R is "recordable" and DVD±RW is "rewritable". With a DVD±R, you can record multiple sessions on the same disc, but when the disc is full, you cannot record any more on the disc. The DVD±RW allows you to record over the same disc repeatedly.

How do I check the remaining space available on a recordable DVD disc?

In disc menu mode, press REC MODE on the remote control to display the remaining time available. (The length if time available depends on the mode of recording quality).

What is DV?

Using DV, also known as i.LINK, you can connect a DV-equipped camcorder to this recorder using a single DV cable for input and output of audio, video, data and control signals.

- This recorder is only compatible with DV-format (DVC-SD) camcorders. Digital satellite tuners and Digital VHS video recorders are not compatible.
- You cannot connect more than one DV camcorder at a time to this recorder.
- You cannot control this recorder from external equipment connected via the DV IN socket.

Can I copy a VHS tape or DVD from an external player?

Yes, but only if the VHS tape or DVD is not copy protected.

What are Titles and Chapters?

A DVD disc contains Titles and Chapters, which are similar to the Titles and Chapters of a book. A Title is often a complete movie and is broken down into Chapters, or individual scenes from the movies.

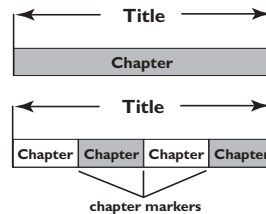

Programmes are recorded as a single title, it may consist of one chapter or a few chapters within a title, depending on the recording settings.

How do I set up Titles and Chapters?

The recorder automatically creates a new Title every time you start a new recording. You can then add Chapters to these recordings manually or have them automatically inserted at 5-minute intervals.

What does "finalising" a disc do?

Finalising a disc locks the disc so it can no longer be recorded, only required for DVD±R. It will then be compatible with any DVD player. To close a disc without finalising it, simply stop recording and eject the disc. You will still be able to record on the disc if there is room for more recordings.

Frequently Asked Questions (continued)

How good is the quality of the recording?

There are a few quality levels to choose from, ranging from “1 hour mode” (High Quality) to “6 hours mode” (Super Long Play). Press the REC MODE button on the remote control to choose the quality level that best suits your purpose and the length of material.

Record Mode	Picture Quality	Maximum Recording Time per Disc (hours)
HQ	High Quality	1
SP	Standard Play	2
SPP	Standard Play Plus	2.5
LP	Long Play	3
EP	Extended Play	4
SLP	Super Long Play	6

What is HDMI?

High-Definition Multimedia Interface (HDMI) is a high-speed digital interface that can transmit uncompressed high definition video and digital multichannel audio. It delivers perfect picture and sound quality, completely free from noise. HDMI is fully backward-compatible with DVI.

As required by the HDMI standard, connecting to HDMI or DVI products without HDCP (High-bandwidth Digital Content Protection) will result in no video or audio output.

Glossary

Analogue: Sound that has not been turned into numbers. Analogue sound varies, while digital sound has specific numerical values. These sockets send audio through two channels, the left and right.

Aspect ratio: The ratio of vertical and horizontal sizes of a displayed image. The horizontal vs. vertical ratio of conventional TVs. is 4:3, and that of wide-screens is 16:9.

AUDIO OUT Sockets: Red and white sockets on the back of the system that send audio to another system (TV, Stereo, etc).

Chapter: Sections of a picture or a music piece on a DVD that are smaller than titles. A title is composed of several chapters. Each chapter is assigned a chapter number enabling you to locate the chapter you want.

Digital: Sound that has been converted into numerical values. Digital sound is available when you use the DIGITAL AUDIO OUT COAXIAL. These sockets send audio through multiple channels, instead of just two channels as analogue does.

Disc menu: A screen display prepared for allowing selection of images, sounds, subtitles, multi-angles, etc recorded on a DVD.

DivX: The DivX code is a patent pending, MPEG-4 based video compression technology, developed by DivXNetworks Inc., that can shrink digital video to sizes small enough to be transported over the internet, while maintaining high visual quality.

Dolby Digital: A surround sound system developed by Dolby Laboratories containing up to six channels of digital audio (front left and right, surround left and right, centre and subwoofer).

DTS: Digital Theatre Systems. This is a surround sound system, but it is different from Dolby Digital. The formats were developed by different companies.

HDMI: High-Definition Multimedia Interface (HDMI) is a high-speed digital interface that can transmit uncompressed high definition video and digital multichannel audio. It delivers perfect picture and sound quality, completely free from noise. HDMI is fully backward-compatible with DVI. As required by the HDMI standard, connecting to HDMI or DVI products without HDCP (High-bandwidth Digital Content Protection) will result in no Video or Audio output.

Index Picture Screen: A screen that gives an overview of a recorded DVD disc. An Index Picture represents each recording.

JPEG: A very common digital still picture format. A still-picture data compression system proposed by the Joint Photographic Expert Group, which features small decrease in image quality in spite of its high compression ratio.

MP3: A file format with a sound data compression system. "MP3" is the abbreviation of Motion Picture Experts Group 1 (or MPEG-1) Audio Layer 3. By using the MP3 format, one CD-R or CD-RW can contain about 10 times more data than a regular CD.

MPEG: Motion Picture Experts Group. A collection of compression systems for digital audio and video.

Multichannel: DVDs are formatted to have each sound track constitute one sound field. Multichannel refers to a structure of sound tracks having three or more channels.

Glossary (continued)

PBC: Playback Control. Refers to the signal recorded on video CDs or SVCDs for controlling playback. By using menu screens recorded on a Video CD or SVCD that supports PBC, you can enjoy interactive playback and searching.

PCM: Pulse Code Modulation. A digital audio encoding system.

Parental control: Limits disc play according to the age of the users or the limitation level in each country. The limitation varies from disc to disc; when it is activated, playback will be prohibited if the software's level is higher than the user-set level.

Region code: A system allowing discs to be played only in the region designated. This unit will only play discs that have compatible region codes. You can find the region code of your unit by looking on the product label. Some discs are compatible with more than one region (or ALL regions).

S-Video: Produces a clear picture by sending separate signals for the luminance and the colour. You can use S-Video only if your TV has an S-Video In socket.

Surround: A system for creating realistic three dimensional sound fields full of realism by arranging multiple speakers around the listener.

Title: The longest section of a movie or music feature on DVD. Each title is assigned a title number, enabling you to locate the title you want.

VIDEO OUT socket: Yellow socket on the back of the DVD system that sends the DVD picture video to a TV.

WMA : WMA is short for Windows Media Audio and refers to an audio compression technology developed by Microsoft Corporation. WMA data can be encoded by using Windows Media Player version 9 or Windows Media Player for Windows XP. Files are recognised by their file extension". wma" or ".WMA".

Display panel symbols/ messages

The following symbols/ messages may appear on your recorder display:

- 00:00:00
Multifunction display/ text line
 - Title/ track number
 - Total/ elapsed/remaining title/track time
 - Disc/title name
 - Additional information regarding the disc
 - TV channel number or source of video
 - Clock (This is displayed in Standby mode).
 - TV program title
- BLANK
There are no recordings in the disc on the tray.
- FULL
Disc is full. There is no more storage space for new recordings.
- HDMI TV ERROR
The TV connected is non-HDCP compliant. No video can be displayed via the HDMI connection.
- LOADING
Disc is being recognised by the recorder.
- MENU
The setup menu, disc menu, title menu or timer menu display is on.
- NO DISC
No disc has been inserted. If a disc has been inserted, then it is possible that the disc cannot be read.
- OPEN
Disc tray is opening or opened.
- PHOTO
A picture disc has been inserted.
- STARTUP
The recorder has been turned on.
- REGION
When the DVD inserted is in a wrong region code as the recorder.
- STOP
When playback / recording is stopped.
- ⌚ TIMER
A timer recording has been programmed or is active.
- UPDATE
The recorder is writing to the disc.
- UNKNOWN
The recorder has encountered an error in handling the disc inserted.
- SET CLOCK
The system clock has to be set.
- UNRECORDABLE DISC
The disc inserted cannot be used for recording.
- COPY PROTECT
The content is copy- protected.
- FINALIZED DISC
The disc inserted has been finalised. No further recordings can be made on the disc.
- RECORDING
A recording is in progress.

TV System Guide

English

COUNTRY	VHF	UHF	DVD REGIONS
AFGHANISTAN	PAL/SECAM B		5
ALBANIA	PAL B	PAL G	2
ALGERIA	PAL B	PAL G	5
ANGOLA	PAL I		5
ARGENTINA	PAL N	PAL N	4
AUSTRALIA	PAL B	PAL H	4
AUSTRIA	PAL B	PAL G	2
AZORES	PAL B		
BAHAMAS	NTSC M		4
BAHRAIN	PAL B	PAL G	2
BANGLADESH	PAL B		5
BARBADOS	NTSC M		4
BELGIUM	PAL B	PAL H	2
BERMUDA	NTSC M		
BOLIVIA	NTSC M	NTSC M	4
BOTSWANA	PAL I		5
BRAZIL	PAL M	PAL M	4
BRUNEI	PAL B	PAL B	
BULGARIA	SECAM D	SECAM K	2
BURKINA FASO	SECAM K1		5
BURMA	NTSC M		
BURUNDI	SECAM K1		5
CAMBODIA	NTSC M		3
CAMEROON	PAL B	PAL G	5
CANADA	NTSC M	NTSC M	1
CANARY ISLANDS	PAL B		2
CHAD	SECAM K1		5
CHILE	NTSC M	NTSC M	4
CHINA	PAL D		6
COLOMBIA	NTSC M	NTSC M	4
COSTA RICA	NTSC M	NTSC M	4
CROATIA	PAL B	PAL G	2
CUBA	NTSC M	NTSC M	4
CYPRUS	PAL B	PAL G	
CZECH REPUBLIC	PAL D	PAL K	2
DAHOMEY	SECAM K1		
DENMARK	PAL B	PAL G	2
DJIBOUTI	SECAM B	SECAM G	5
DOMINICAN REP	NTSC M	NTSC M	4
ECUADOR	NTSC M	NTSC M	4
EGYPT	SECAM B/PAL B	SECAM G/PAL G	2
EL SALVADOR	NTSC M	NTSC M	4
EQUAT. GUINEA	PAL B		5
ESTONIA	PAL B (was SECAM)	PAL D	5
ETHIOPIA	PAL B	PAL G	5
FIJI	PAL B		
FINLAND	PAL B	PAL G	2
FRANCE	SECAM L	SECAM L	2
FRENCH POLYNESIA	SECAM K1		
GABON	SECAM K1		5
GAMBIA	PAL I		5
GERMANY	PAL B	PAL G	2
GHANA	PAL B	PAL G	5
GIBRALTAR	PAL B	PAL H	2
GREECE	PAL B (was SECAM)	PAL G	2
GREENLAND	NTSC/PAL B		2
GUADELOUPE	SECAM K1		
GUAM	NTSC M		1
GUATEMALA	NTSC M	NTSC M	4
GUINEA	PAL K		5
GUYANA (FRENCH)	SECAM K1		4
HONDURAS	NTSC M	NTSC M	4

TV System Guide (continued)

COUNTRY	VHF	UHF	DVD REGIONS
LIBYA	SECAM B	SECAM G	5
LITHUANIA	PAL D (was SECAM)	PAL K	5
LUXEMBOURG	PAL B/SECAM L	PAL G/SEC L	2
MADAGASCAR	SECAM K1		5
MADEIRA	PAL B		
MALAGASY	SECAM K1		
MALAWI	PAL B	PAL G	5
MALAYSIA	PAL B		3
MALI	SECAM K1		5
MALTA	PAL B	PAL H	2
MARTINIQUE	SECAM K1		
MAURITANIA	SECAM B		5
MAURITIUS	SECAM B		5
MEXICO	NTSC M	NTSC M	4
MONACO	SECAM L		2
MONGOLIA	SECAM D		5
MOROCCO	SECAM B		5
MOZAMBIQUE	PAL B		5
NAMIBIA	PAL I		5
NEPAL	PAL B		
NETHERLANDS	PAL B	PAL G	2
NETH. ANTILLES	NTSC M	NTSC M	
NEW CALEDONIA	SECAM K1		
NEW GUINEA	PAL B	PAL G	4
NEW ZEALAND	PAL B	PAL G	4
NICARAGUA	NTSC M	NTSC M	4
NIGER	SECAM K1		5
NIGERIA	PAL B	PAL G	5
NORWAY	PAL B	PAL G	2
OMAN	PAL B	PAL G	2
PAKISTAN	PAL B		5
PANAMA	NTSC M	NTSC M	4
PARAGUAY	PAL N	PAL N	4
PERU	NTSC M	NTSC M	4
PHILIPPINES	NTSC M	NTSC M	3
POLAND	PAL D	PAL K	2
PORTUGAL	PAL B	PAL G (was SECAM D)	2
PUERTO RICO	NTSC M	NTSC M	1
QATAR	PAL B		2
REUNION	SECAM K1		
RUMANIA	PAL D	PAL K	2
RUSSIA	SECAM D	SECAM K	5
RWANDA	SECAM K1		5
SABAH/SAWARA	PAL B		
ST. KITTS	NTSC M	NTSC M	
SAMOA (US)	NTSC M		1
SAUDI ARABIA	SECAM-B/PAL-B	SECAM G	2
SENEGAL	PAL		5
SEYHELLES	PAL B	PAL G	5
SIERRA LEONE	PAL B	PAL G	5
SINGAPORE	PAL B	PAL G	
SLOVAK REPUBLIC	PAL	PAL	2
SOMALIA	PAL B	PAL G	5
SOUTH AFRICA	PAL I	PAL I	2
SPAIN	PAL B	PAL G	2
SRI LANKA	PAL B		5
SUDAN	PAL B	PAL G	5
SURINAM	NTSC M	NTSC M	4
SWAZILAND	PAL B	PAL G	
SWEDEN	PAL B	PAL G	2
SWITZERLAND	PAL B	PAL G	2
SYRIA	SECAM B		2

English

English

Meet Philips at the Internet
<http://www.philips.com>
<http://www.philips.com/support>



Be responsible
Respect copyrights

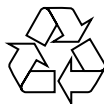

**CLASS 1
LASER PRODUCT**

3139 245 20891



Sgp-0618/05-1

Free Manuals Download Website

<http://myh66.com>

<http://usermanuals.us>

<http://www.somanuals.com>

<http://www.4manuals.cc>

<http://www.manual-lib.com>

<http://www.404manual.com>

<http://www.luxmanual.com>

<http://aubethermostatmanual.com>

Golf course search by state

<http://golfingnear.com>

Email search by domain

<http://emailbydomain.com>

Auto manuals search

<http://auto.somanuals.com>

TV manuals search

<http://tv.somanuals.com>