

MDR515H / F7 *HDD & DVD PLAYER / RECORDER* *WITH DIGITAL TUNER*

THANK YOU FOR CHOOSING MAGNAVOX.



NEED HELP FAST?

READ YOUR QUICK GUIDE AND/OR OWNER'S MANUAL FIRST FOR QUICK TIPS THAT MAKE USING YOUR MAGNAVOX PRODUCT MORE ENJOYABLE.

IF YOU HAVE READ YOUR INSTRUCTIONS AND STILL NEED ASSISTANCE,
YOU MAY ACCESS OUR ONLINE HELP AT WWW.MAGNAVOX.COM/SUPPORT
OR WWW.FUNAISERVICE.COM/
OR CALL **1-800-605-8610** WHILE WITH YOUR PRODUCT.

INSTRUCCIONES EN ESPAÑOL INCLUIDAS.

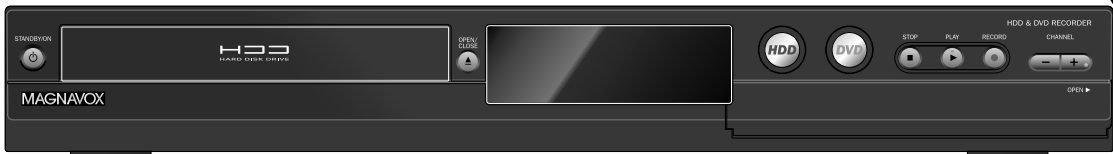

SAFETY INFORMATION

Safety Instructions

The model and serial numbers of this unit may be found on the cabinet.
You should record and retain those numbers for future reference.

Model No.: _____

Serial No.: _____

WARNING: TO REDUCE THE RISK OF FIRE OR ELECTRIC SHOCK, DO NOT EXPOSE THIS APPARATUS TO RAIN OR MOISTURE. APPARATUS SHALL NOT BE EXPOSED TO DRIPPING OR SPLASHING AND NO OBJECTS FILLED WITH LIQUIDS, SUCH AS VASES, SHALL BE PLACED ON THE APPARATUS.



CAUTION:

TO REDUCE THE RISK OF ELECTRIC SHOCK, DO NOT REMOVE COVER (OR BACK). NO USER SERVICEABLE PARTS INSIDE. REFER SERVICING TO QUALIFIED SERVICE PERSONNEL.



The lightning flash with arrowhead symbol, within an equilateral triangle, is intended to alert the user to the presence of uninsulated "dangerous voltage" within the product's enclosure that may be of sufficient magnitude to constitute a risk of electric shock to persons.



The exclamation point within an equilateral triangle is intended to alert the user to the presence of important operating and maintenance (servicing) instructions in the literature accompanying the appliance.

The important note is located on the rear or bottom of the cabinet.

 The symbol for CLASS II (Double Insulation)

IMPORTANT SAFETY INSTRUCTIONS

1. Read these instructions.
2. Keep these instructions.
3. Heed all warnings.
4. Follow all instructions.
5. Do not use this apparatus near water.
6. Clean only with dry cloth.
7. Do not block any ventilation openings. Install in accordance with the manufacturer's instructions.
8. Do not install near any heat sources such as radiators, heat registers, stoves, or other apparatus (including amplifiers) that produce heat.
9. Do not defeat the safety purpose of the polarized or grounding-type plug. A polarized plug has two blades with one wider than the other. A grounding type plug has two blades and a third grounding prong. The wide blade or the third prong are provided for your safety. If the provided plug does not fit into your outlet, consult an electrician for replacement of the obsolete outlet.
10. Protect the power cord from being walked on or pinched particularly at plugs, convenience receptacles, and the point where they exit from the apparatus.
11. Only use attachments/accessories specified by the manufacturer.
12. Use only with the cart, stand, tripod, bracket, or table specified by the manufacturer, or sold with the apparatus. When a cart is used, use caution when moving the cart/apparatus combination to avoid injury from tip-over. 
13. Unplug this apparatus during lightning storms or when unused for long periods of time.
14. Refer all servicing to qualified service personnel. Servicing is required when the apparatus has been damaged in any way, such as power-supply cord or plug is damaged, liquid has been spilled or objects have fallen into the apparatus, the apparatus has been exposed to rain or moisture, does not operate normally, or has been dropped.

FCC WARNING

This equipment may generate or use radio frequency energy. Changes or modifications to this equipment may cause harmful interference unless the modifications are expressly approved in the manual. The user could lose the authority to operate this equipment if an unauthorized change or modification is made.

RADIO-TV INTERFERENCE

This equipment has been tested and found to comply with the limits for a Class B digital device, pursuant to Part 15 of the FCC Rules. These limits are designed to provide reasonable protection against harmful interference in a residential installation. This equipment generates, uses, and can radiate radio frequency energy and, if not installed and used in accordance with the instructions, may cause harmful interference to radio communications. However, there is no guarantee that interference will not occur in a particular installation. If this equipment does cause harmful interference to radio or television reception, which can be determined by turning the equipment off and on, the user is encouraged to try to correct the interference by one or more of the following measures:

- 1) Reorient or relocate the receiving antenna.
- 2) Increase the separation between the equipment and receiver.
- 3) Connect the equipment into an outlet on a circuit different from that to which the receiver is connected.
- 4) Consult the dealer or an experienced radio/TV technician for help.

This Class B digital apparatus complies with Canadian ICES-003.

Disconnect the mains plug to shut off when find trouble or not in use. The mains plug shall remain readily operable.

SAFETY INFORMATION

CAUTION: Danger of explosion if battery is incorrectly replaced. Replace only with the same or equivalent type.
WARNING: Batteries (Battery pack or battery installed) shall not be exposed to excessive heat such as sunshine, fire, or the like.

LASER SAFETY

This apparatus employs a laser. Only a qualified service person should remove the cover or attempt to service this apparatus, due to possible eye injury.

CAUTION: Use of controls or adjustments or performance of procedures other than those specified herein may result in hazardous radiation exposure.

CAUTION: Visible and invisible laser radiation when open and interlocks defeated. Do not stare into beam.

LOCATION: Inside, near the deck mechanism.

IMPORTANT COPYRIGHT INFORMATION

Unauthorized copying, broadcasting, public performance and lending of discs are prohibited. This item incorporates copy protection technology that is protected by U.S. patents and other intellectual property rights of Rovi Corporation. Reverse engineering and disassembly are prohibited.

Do not place the unit on the furniture that is capable of being tilted by a child and an adult leaning, pulling, standing or climbing on it. A falling unit can cause serious injury or even death.

To Avoid the Hazards of Electrical Shock and Fire

- Do not handle the power cord with wet hands.
- Do not pull on the power cord when disconnecting it from an AC outlet. Grasp it by the plug.
- Do not put your fingers or objects into the unit.

Location and Handling

- Do not install the unit in direct sunlight, near strong magnetic fields, or in a place subject to dust or strong vibration.
- Avoid a place with drastic temperature changes.
- Install the unit in a horizontal and stable position. Do not place anything directly on top or bottom of the unit. Depending on your external devices, noise or disturbance of the picture and/or sound may be generated if the unit is placed too close to them. In this case, please ensure enough space between the external devices and the unit.
- Depending on the environment, the temperature of this unit may increase slightly. This is not a malfunction.
- Be sure to remove the disc and unplug the AC power cord from the outlet before carrying the unit.

Dew Condensation Warning

- Dew condensation may form inside the unit in the following conditions. If so, do not use this unit at least for a few hours until its inside gets dry.
 - The unit is moved from a cold place to a warm place.
 - Under conditions of high humidity.
 - After heating a cold room.

Note about Recycling

- This unit's packaging materials are recyclable and can be reused. Please dispose of any materials in accordance with your local recycling regulations.
- Batteries should never be thrown away or incinerated but disposed of in accordance with your local regulations concerning chemical wastes.



Notice for Progressive Scan Output

- Consumers should note that not all high definition television sets are fully compatible with this product and may cause artifacts to be displayed in the picture. In case of picture problems with 480 progressive scan output, it is recommended that the user switch the connection to the 'standard definition' output. If there are questions regarding your TV set compatibility with this 480p DVD recorder, please contact our customer service center.

SAFETY INFORMATION

Supplied Accessories

Remote Control (NC003UD) with AA (1.5 V) battery x2

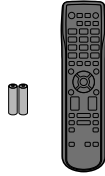

RF coaxial cable (WPZ0901TM002 / WPZ0901TM005)

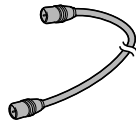

RCA audio/video cables (WPZ0102TM018/WPZ0102LTE01)

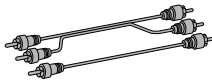

Owner's Manual (EN/FR) (1VMN29896/1VMN29897)

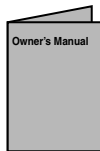

Quick Start Guide (EN) (1VMN29898)

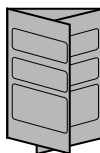

Maintenance

Servicing

- Please refer to relevant topics on "TROUBLESHOOTING" on pages 115-119 before returning the product.
- If this unit becomes inoperative, do not try to correct the problem by yourself. There are no user-serviceable parts inside. Turn the unit to the standby mode, unplug the power plug and please call our help line mentioned on the front page to locate an Authorized Service Center.

Cleaning the cabinet

- Wipe the front panel and other exterior surfaces of the unit with a soft cloth.
- Never use a solvent, thinner, benzene or alcohol to clean the unit. Do not spray insecticide liquid near the unit. Such chemicals may discolor the surface or damage the unit.

Cleaning discs

- When a disc becomes dirty, clean it with a cleaning cloth. Wipe the disc from the center to out. Do not wipe in a circular motion.
- Do not use solvents such as benzene, thinner, commercially available cleaners, detergent, abrasive cleaning agents or antistatic spray intended for analog records.

Cleaning the disc lens

- If this unit still does not perform properly although you refer to the relevant sections and to "TROUBLESHOOTING" in this owner's manual, the laser optical pickup unit may be dirty. Consult your dealer or an Authorized Service Center for inspection and cleaning of the laser optical pickup unit.

Disc handling

- Handle the discs so that fingerprints and dust do not adhere to the surfaces of the discs.
- Always store the disc in its protective case when it is not used.

HDD handling

- HDD is a precision apparatus that is susceptible to vibration, strong impact or dirt. Depending on the installation environment or handling, the unit may become partially damaged or in the worst case, recording or replaying may not be available. Especially while the HDD is in motion, do not subject it to vibration or strong impact or pull out the power plug. And if a power failure occurs, the content of the recording / replaying program may be lost.
- HDD rotates at high speed when in operation. Be sure that rotation has stopped and then move the unit without subjecting it to strong impact or vibration.

IR signal check

If the remote control does not work properly, you can test if the remote control sends out the infrared signal with a digital camera (including built-in camera of cellular phone). It will help to locate the cause of malfunction.

With a digital camera (including built-in camera of cellular phone):

Direct a digital camera to remote control, press and hold a button on remote control. If infrared light appears through digital camera, the remote control is working.



Trademark Information



Kodak and KODAK Picture CD Compatible are trademarks of Kodak used under license.



HDMI, the HDMI Logo, and High-Definition Multimedia Interface are trademarks or registered trademarks of HDMI Licensing LLC in the United States and other countries.



Manufactured under license from Dolby Laboratories. Dolby and the double-D symbol are trademarks of Dolby Laboratories.

Dolby® Digital Stereo Creator

"Dolby® Digital Stereo Creator enables consumers to create stereo DVD-Videos with stunning Dolby Digital sound tracks at home. The technology, when utilized instead of PCM recording, also saves recordable disc space, allowing for higher video resolution or extended recording time on each DVD. DVDs mastered using Dolby Digital Stereo Creator will play back on all DVD-Video players."

Note: This is true when the players are compatible with actual recordable DVD discs.

© 2010 Funai Electric Co., Ltd.

All rights reserved. No part of this manual may be reproduced, copied, transmitted, disseminated, transcribed, downloaded or stored in any storage medium, in any form or for any purpose without the express prior written consent of Funai. Furthermore, any unauthorized commercial distribution of this manual or any revision hereto is strictly prohibited.

Information in this document is subject to change without notice. Funai reserves the right to change the content herein without the obligation to notify any person or organization of such changes.

FUNAI with the  design is a registered trademark of Funai Electric Co., Ltd. and may not be used in any way without the express written consent of Funai. All other trademarks used herein remain the exclusive property of their respective owners. Nothing contained in this manual should be construed as granting, by implication or otherwise, any license or right to use any of the trademarks displayed herein. Misuse of any trademarks or any other content in this manual is strictly prohibited. Funai shall aggressively enforce its intellectual property rights to the fullest extent of the law.

CONTENTS

Introduction

SAFETY INFORMATION	2
Safety Instructions	2
Supplied Accessories	4
Maintenance	4
Trademark Information	5
FEATURES	8
Features	8
Symbols Used in this Owner's Manual	9
FUNCTIONAL OVERVIEW	10
Front Panel	10
Rear Panel	11
Remote Control	12
Front Panel Display	14

Connections

CONNECTION	15
Antenna Connection (Required)	15
Overview	15
Connecting to a TV Using Audio/Video jacks	16
Connecting to a TV Using the S-Video Out jack	16
Connecting to a TV Using	
Component Video Out jacks	17
Connecting to a TV with an HDMI Compatible Port	17
Connecting to a Cable/Satellite Box	19
Connecting to a TV without Audio/Video jacks	20
Digital Audio Connection	21

Basic Setup

BEFORE YOU START	22
Finding the Viewing Channel on your TV	22
Guide to On-Screen Display/Menu	23
Main Menu	25
Switching HDD/DVD Mode	27
How to Insert a Disc	27
INITIAL SETTING	28
CHANNEL SETTING	29
Auto Channel Scan	29
Adding/Deleting Channels	30
SETTING THE CLOCK	32
Auto Clock Setting	32
Manual Clock Setting	34
Daylight Saving Time	34
TUNER SETTINGS	35
Switching Analog Mode/Digital Mode	35
Channel Selection	35
Selecting TV Audio	36
DTV Closed Caption	38
Closed Caption Style	39

Recording

INFORMATION ON RECORDING	41
BEFORE RECORDING	43
Make Recording Compatible	43
Setting for Auto Chapter	43
Recording the DTV Closed Caption	43
BASIC RECORDING & ONE-TOUCH TIMER RECORDING ..	44
AUTOSTART RECORDING	46
TIMER RECORDING	47
Hints for Timer Recording	51
SPECIAL RECORDING	52
Overwriting from the Beginning of the Title	52
Overwriting in the Middle of the Title	52
Hints for Overwriting	53
DUBBING	54
Information on Dubbing	54
Setting for an External Device	55
Recording from an External Device	56
Information on DV Dubbing	57
DVC to HDD/DVD Dubbing	58
Selected Title Dubbing	60
One Title Dubbing (HDD to DVD only)	62
PROTECTING A DISC	63
PLAYING THE DISCS ON OTHER DVD PLAYERS	64
Finalizing a Disc	64
Auto Finalizing	65

Playback

INFORMATION ON PLAYBACK	66
BASIC PLAYBACK	68
Direct Playback	68
Playback from the Title List	69
Playing Back an Audio CD and CD-RW/-R with MP3 / JPEG Files	71
Using the Title / Disc Menu	72
Pause	72
SPECIAL PLAYBACK	73
Resume Playback	73
Fast Forward / Fast Reverse Playback	73
Variable Skip / Variable Replay	73
Rapid Playback	73
Step by Step Playback	74
Slow Forward / Slow Reverse Playback	74
Chasing Playback during Recording	74
Simultaneous Playback and Recording	74
Zoom	75
Marker Setting	75
Repeat Playback	76
Random Playback	76
Slide Show	76
Program Playback	77
Playing Back the Autostart Recording	77
SEARCH	78
Title / Chapter Search	78
Track Search	78
Time Search	79
SELECTING THE FORMAT OF AUDIO AND VIDEO ..	80
Switching Subtitles	80
Switching Audio Soundtrack	80
Switching Virtual Surround System	81
Switching Camera Angles	81
Reducing Block Noise	81

Editing

INFORMATION ON EDITING	82
Guide to a Title List	82
Edit Menu	83
How to Access the Edit Menu	83
EDITING	84
Deleting a Title	84
Deleting Selected Titles	86
Putting Names on Titles	87
Chapter Marks (Add)	88
Chapter Marks (Delete)	89
Chapter Marks (Delete All)	90
Dividing a Title	91
Deleting a Scene of a Title	92
Protecting a Title	94
Hiding Chapters	95
Setting an Index Picture	96
Putting Name on Disc	97
Erasing Disc	98
Making Edits Compatible	99
Deleting All Titles in HDD	100

Function Setup

LIST OF SETTINGS	101
SETUPS	104
Playback	104
Display	108
Video	111
HDMI	113

Others

TROUBLESHOOTING	115
Error Message	119
LANGUAGE CODE	120
GLOSSARY	121
SPECIFICATIONS	122

Español

ESPAÑOL	123
Discos Reproducibles	123
Códigos de Región	123
Disco Grabable	123
Disco no Grabable	123
Conexión Básica	124
Conexión a un Televisor con un Puerto Compatible con HDMI	124
Configuración Inicial	125
Reproducción Directa	126
Grabación Básica	126
Copiado Básica	127

LIMITED WARRANTY	Back cover
-------------------------------	-------------------

FEATURES

Features

This unit not only plays back the contents on internal HDD, DVD, or CD, but also offers features for you to record on HDD or DVD and edit them after that. The following features are offered with this unit.

Recording

This unit allows you to record on the HDD, a DVD+RW/-RW (rewritable) and a DVD+R/-R (one-time write). You can choose any one for your convenience. Even if you choose DVD-RW/-R, these discs will automatically be recorded in the DVD+VR mode.

HDD DVD

Up to 36 program recording:

You can program the unit to record up to 36 programs within a one-month period. Daily or weekly program recordings are also available.

One-touch timer recording (OTR):

You can easily set a recording time as you prefer. Every time [REC] is pressed during recording, the recording time will be increased by 30 minutes up to 6 hours. The recording automatically stops when the recording time you set is reached or the disc is full.

Automatic chapter mark setting:

Chapter marks will be put on recordings as you set before attempting to record.

Automatic title list making:

The unit makes a title list with the index automatically.

Left channel stereo recording:

This unit can record the sound of the left channel monaural input as left and right channels automatically (the input from the L2 jacks only).

500 GB hard disk:

This unit is equipped with a 500GB hard disk which allows you to record up to 620 hours (with SLP mode).

HDD

Autostart recording:

Every time you turn on this unit, this unit automatically records the channel currently viewed and temporarily stores the recorded content to the HDD. By using this function, you can pause or go back to the TV program you are currently watching, and you can also start recording the whole TV program even at the middle of the TV program.

DVD

Automatic title finalizing (DVD+R/DVD-RW/-R only):

You can finalize discs automatically after finishing all timer recordings or at the end of the disc space if you set this in the main menu.

Alternate recording:

In the following cases, the unit will detect it and automatically record to the HDD even when DVD is selected as the recording media.

- If there is no recordable disc in the unit
- If the disc does not have enough space to complete the recording
- If the material is "copy-once" program and prohibited to be recorded on a DVD
- If the disc is not available because the repairing process is canceled halfway

This feature is available only for timer recording. Not available for one-touch timer recording.

Dubbing

With this unit, you can enjoy bi-directional dubbing between HDD and DVD.

HDD

DVD

High speed dubbing (HDD → DVD only):

If you dub a title recorded in SLP mode to DVD+R/-R, dubbing speed will be 24 times at the maximum.

Auto recording mode dubbing:

When dubbing, if you set the recording mode to "Auto", the recording mode will automatically be adjusted so the titles will fit nicely in the remaining space of the disc.

DV dubbing:

This function helps you to easily dub the contents of the DVC (digital video camcorder) to HDD/DVD.

Playback

HDD

DVD

Theater surround sound in your home:

When connecting the unit to an amplifier or a decoder which is compatible with Dolby Digital, you can experience the theater surround sound from discs with surround sound system.

Quick search for what you want to watch:

You can easily find the part you want to watch using the search functions. You can search for a desired point by title, chapter or time.

Virtual surround system:

You can enjoy stereophonic space through your existing 2 channel stereo system.

Variable skip:

You can skip forward a certain time, which is specified in "Playback" menu in advance, with one-touch while playback.

Variable replay:

You can skip back a certain time, which is specified in "Playback" menu in advance, with one-touch while playback.

HDD

Chasing playback during recording and simultaneous playback and recording:

You can play back the already recorded part of the current recording or another title during recording.

DVD

Playing back MP3/JPEG/KODAK Picture CD files:

You can enjoy MP3/JPEG/KODAK Picture CD files which are recorded on CD-RW/-R.

Editing

Available for a disc that is not finalized or DVD+RW.

Deleting a title:

HDD

DVD

You can delete a title which you do not need anymore.

Putting names on titles:

You can put your favorite names on titles.

Setting / clearing chapter marks:

You can set / clear chapter marks on titles.

Dividing titles:

You can divide a title into 2 or more.

Deleting a scene of a title:

HDD

You can delete a scene from a title as you like.

Hiding chapters:

DVD

To keep others from playing back some chapters without permission, you can hide chapters.

Setting an index pictures:

You can change pictures for an index.

Putting name on disc:

You can put your favorite disc name.

Compatibility

DVD

Available for playing back discs on a regular DVD player:

Recorded discs can be played back on regular DVD players, including computer DVD drives compatible with DVD-video playback. Although DVD+R are playable on other units without finalization in most cases, it is recommended to finalize in order to stabilize the performance. For DVD-RW/-R, you need to finalize the recorded discs to play back on other DVD players.

Others

HDD

DVD

Progressive scan system:

Unlike conventional interlace scanning, the progressive scan system provides less flickering and images in higher resolution than that of traditional television signals.

HDMI (High-Definition Multimedia Interface)

You can enjoy clearer audio/video output when connecting this unit to a display device with an HDMI-compatible port.

Symbols Used in this Owner's Manual

To specify for which media type each function is, we put the following symbols at the beginning of each item to operate.

- * DVD-RW/-R recorded in VR mode or non compatible recording format are not playable.
- * DVD-RW recorded in the mode other than +VR is not recordable on this unit unless you erase all contents in the disc (refer to page 98).
- * DVD-R recorded in the mode other than +VR is not recordable on this unit.

Symbol	Description
--------	-------------

For Recording, Playing Back, and Editing



Description refers to HDD



Description refers to DVD+RW



Description refers to DVD+R



Description refers to DVD-RW



Description refers to DVD-R

For Playback only



Description refers to DVD-video



Description refers to audio CD



Description refers to video CD with PBC function



Description refers to video CD without PBC function



Description refers to CD-RW/-R with MP3 files



Description refers to CD-RW/-R with JPEG files (KODAK Picture CD files included)

If you do not find any of the symbols listed above under the function heading, the operation is applicable to all media.

FUNCTIONAL OVERVIEW

Front Panel

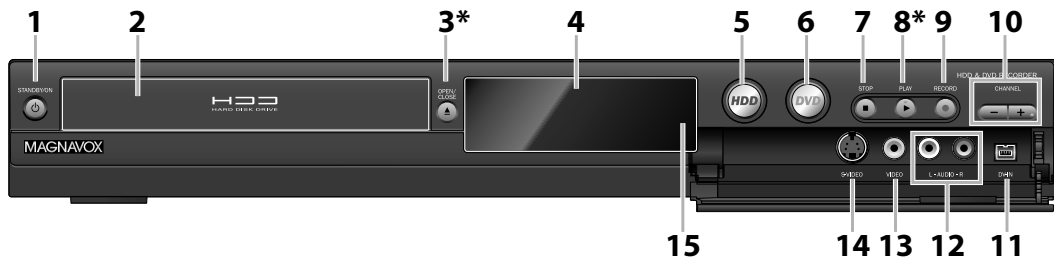

(*) The unit can also be turned on by pressing these buttons.

1. STANDBY/ON button

Press to turn on the unit, or to turn the unit to the standby mode. (To completely shut down the unit, you must unplug the AC power cord)

2. Disc tray

Place a disc when opening the disc tray.

3. OPEN/CLOSE button*

Press to open or close the disc tray.

4. Display

Refer to "Front Panel Display" on page 14.

5. HDD button

Press to select the HDD output mode.

6. DVD button

Press to select the DVD output mode.

7. STOP button

Press to stop playback or recording.

8. PLAY button*

Press to start or resume playback.

9. RECORD button

Press once to start a recording. Press repeatedly to start one-touch timer recording.

10. CHANNEL +/- buttons

Press to change the channel up and down.

11. DV-IN jack (L3)

Use to connect the DV output of external device with a DV cable.

12. AUDIO input jacks (L2)

Use to connect external device with an RCA audio cable.

13. VIDEO input jack (L2)

Use to connect external device with an RCA video cable.

14. S-VIDEO input jack (L2)

Use to connect the S-video output of external device with an S-video cable.

15. Infrared sensor window

Receive signals from your remote control so that you can control the unit from a distance.

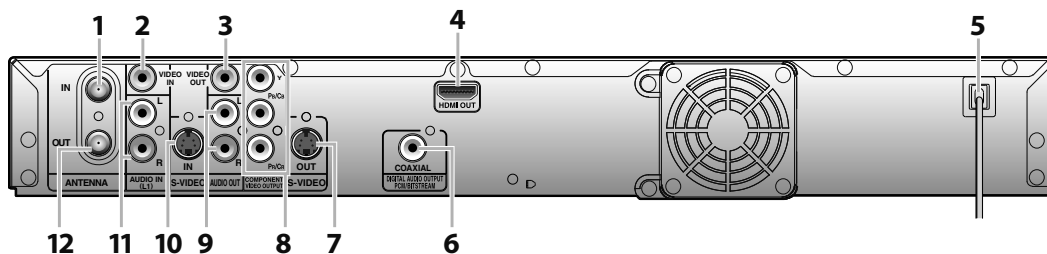

1. ANTENNA IN jack

Use to connect an antenna.

2. VIDEO IN jack (L1)

Use to connect external device with an RCA video cable.

3. VIDEO OUT jack

Use to connect a TV monitor, AV receiver or other device with an RCA video cable.

4. HDMI OUT jack

Use an HDMI cable to connect to a display with an HDMI compatible port.

5. AC Power Cord

- Connect to a standard AC outlet to supply power to this unit.
- Unplug this cord from the AC outlet to completely shut down the unit.

6. DIGITAL AUDIO OUTPUT (COAXIAL) jack

Use to connect an AV receiver, Dolby Digital decoder or other device with a digital audio coaxial input jack with a digital audio coaxial cable.

7. S-VIDEO OUT jack

Use to connect the S-video input of a TV monitor, AV receiver or other device with an S-video cable.

8. COMPONENT VIDEO OUTPUT jacks

Use to connect a TV monitor with component video inputs with a component video cable.

9. AUDIO OUT jacks

Use to connect a TV monitor, AV receiver or other device with an RCA audio cable.

10. S-VIDEO IN jack (L1)

Use to connect the S-video output of external device with an S-video cable.

11. AUDIO IN jacks (L1)

Use to connect external device with an RCA audio cable.

12. ANTENNA OUT jack

Use to connect an RF coaxial cable to pass the signal from the ANTENNA IN to your TV.

Note

- Do not touch the inner pins of the jacks on the rear panel. Electrostatic discharge may cause permanent damage to the unit.
- This unit does not have the RF modulator.

FUNCTIONAL OVERVIEW

Remote Control

Installing the Batteries in the Remote Control

Install the 2 AA (1.5 V) batteries matching the polarity indicated inside battery compartment of the remote control.

1 Open the cover.

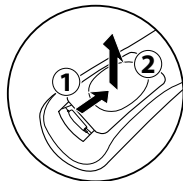

2 Insert batteries.

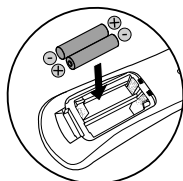

Make sure to match + and - on the batteries to the marks indicated in the battery compartment.

3 Close the cover.

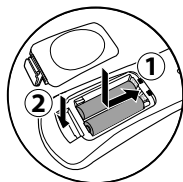

Note

Incorrect use of batteries can result in hazards such as leakage and bursting. Please observe the following:

- Do not mix alkaline, standard (carbon-zinc), or rechargeable (ni-cad, ni-mh, etc) batteries.
- Do not mix new and old batteries together.
- Do not use different kinds of batteries together. Although they may look similar, different batteries may have different voltages.
- Make sure that the + and - ends of each battery match the indications in the battery compartment.
- Remove batteries from battery compartment that is not going to be used for a month or more.
- When disposing of used batteries, please comply with governmental regulations or environmental public instruction's rules that apply in your country or area.
- Do not recharge, short-circuit, heat, burn or disassemble batteries.

Using a Remote Control

Keep in mind the following when using the remote control:

- Make sure that there are no obstacles between the remote control and the infrared sensor window on the unit.
- Remote operation may become unreliable if strong sunlight or fluorescent light is shining on the infrared sensor window of the unit.
- Remote controls for different devices can interfere with each other. Avoid using remote controls for other devices located close to the unit.
- Replace the batteries when you notice a fall off in the operating range of the remote control.
- The maximum operable ranges from the unit are as follows.
 - **Line of sight:** approx. 23 feet (7m)
 - **Either side of the center:** approx. 16 feet (5m) within 30°
 - **Above:** approx. 16 feet (5m) within 15°
 - **Below:** approx. 10 feet (3m) within 30°

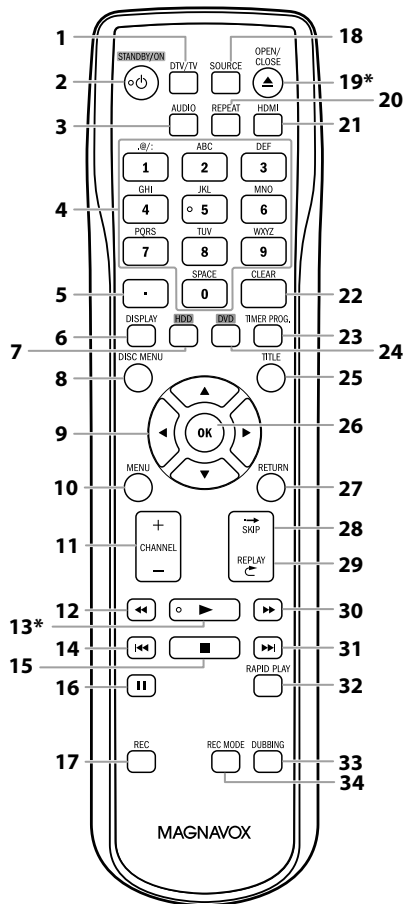
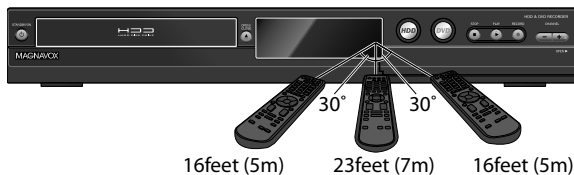

(*) The unit can also be turned on by pressing these buttons.

1. DTV/TV button

- Press to switch between digital TV (DTV) mode and analog TV (TV) mode.

2. STANDBY/ON button

- Press to turn on the unit, or to turn the unit to the standby mode. (To completely shut down the unit, you must unplug the AC power cord)

3. AUDIO button

- Press to switch the audio language for digital TV.
- Press to display the audio menu during playback.

4. Number/Character buttons

- Press to select channel numbers.
- Press to select a title/chapter/track/file on display.
- Press to enter values for the settings in the main menu.
- Press to enter title names.

5. Decimal (.) button

- Digital mode:**
- Press to confirm the major / minor channel selection made by [the Number buttons].

6. DISPLAY button

- Press to turn the display menu on or off.

7. HDD button

- Press to select the HDD output mode.

8. DISC MENU button

- Press to display the disc menu.

9. Cursor / / / buttons

- Press to select items or settings.

10. MENU button

- Press to display the main menu.
- During playback, press and hold for more than 3 seconds to switch the progressive scanning mode to the interlace mode.

11. CHANNEL / buttons

- Press to change the channel up and down.

12. REW button

- During playback, press to fast reverse the playback.
- When playback is in pause, press to slow reverse the playback.

13. PLAY button*

- Press to start playback or resume playback.

14. PREV button

- During playback, press to return to the beginning of the current chapter, track or file.
- When playback is in pause, press repeatedly to reverse the playback step by step.

15. STOP button

- Press to stop playback or recording.
- Press to exit from the title list.

16. PAUSE button

- Press to pause playback or recording.

17. REC button

- Press once to start a recording.
- Press repeatedly to start the one-touch timer recording.

18. SOURCE button

- Press to select the appropriate input.

19. OPEN/CLOSE button*

- Press to open or close the disc tray.

20. REPEAT button

- Press to display the repeat menu.

21. HDMI button

- Press to set the HDMI connector's video signal output mode.

22. CLEAR button

- Press to clear the information once entered, to clear the marker settings, or to cancel the programming for CD, etc.

23. TIMER PROG. button

- Press to display the timer programming list.

24. DVD button

- Press to select the DVD output mode.

25. TITLE button

- Press to display the title list.

26. OK button

- Press to confirm or select menu items.

27. RETURN button

- Press to return to the previously displayed menu screen.

28. SKIP button

- Skips by the amount of time set in advance.

29. REPLAY button

- Replays by the amount of time set in advance.

30. FFW button

- During playback, press to fast forward the playback.
- When playback is in pause, press to slow forward the playback.

31. NEXT button

- During playback, press to skip to the next chapter, track or file.
- When playback is in pause, press repeatedly to forward the playback step by step.

32. RAPID PLAY button

- During playback, press to play back in a slightly faster/slower mode while keeping the sound output.

33. DUBBING button

- During playback, press to start dubbing right away.
- In stop mode, press to display "Dubbing" menu.

34. REC MODE button

- Press repeatedly to switch the recording mode.

FUNCTIONAL OVERVIEW

Front Panel Display

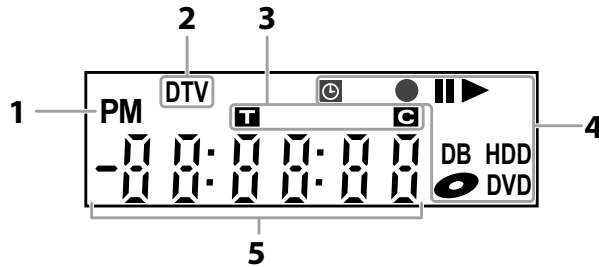

- | | | |
|--|---|---|
| <p>1.</p> <p>PM : Appears in the afternoon with the clock display.</p> <p>2.</p> <p>DTV : Appears when the channel is in DTV mode.</p> <p>3. Title/track/file and chapter mark</p> <p>T : Appears when indicating a title/track/file number.</p> <p>C : Appears when indicating a chapter number.</p> | <p>4. Current status of the unit</p> <p> : Appears when playback is paused.</p> <p>▶ : Appears when playing back an HDD or disc.</p> <p>⏰ : Appears when the timer programming or OTR has been set and is proceeding.</p> <p>● : Appears during recording process.</p> <p>⦿ : Appears when a disc is in this unit.</p> <p>DB : Appears during dubbing.</p> <p>HDD : Appears when the unit is in HDD mode.</p> <p>DVD : Appears when the unit is in DVD mode.</p> | <p>5. Displays the following</p> <ul style="list-style-type: none"> • Elapsed playback time • Current title / chapter / track / file number • Recording time / remaining time • Clock • Channel number • Remaining time for one-touch timer recording • Selected HDMI output mode |
|--|---|---|

Display Message

- | | | | |
|--|---|--|--|
| | Appears when the disc tray is opening. | | Appears when HDMI output mode (480p) is selected. |
| | Appears when the disc tray is closing. | | Appears when HDMI output mode (720p) is selected. |
| | Appears when a disc is loaded on the disc tray. | | Appears when HDMI output mode (1080i) is selected. |
| | Appears when data is being recorded on a disc. | | Appears when HDMI output mode (1080p) is selected. |
| | Appears when the PBC function is activated. (Video CD playback only. Refer to page 67.) | | |

CONNECTION

Read this first:

- 1) Disconnect the AC power cords of the devices from the AC outlet.
- 2) Make the connection as illustrated below.
- 3) After making all the connections, connect the AC power cords of the devices.

- Connect this unit directly to the TV. If the RCA audio/video cables are connected to a VCR, pictures may be distorted due to the copy protection system.
- **When "Progressive Scan" is set to "ON", no video signal will be output from the VIDEO OUT or S-VIDEO OUT jack.**

Antenna Connection (Required)

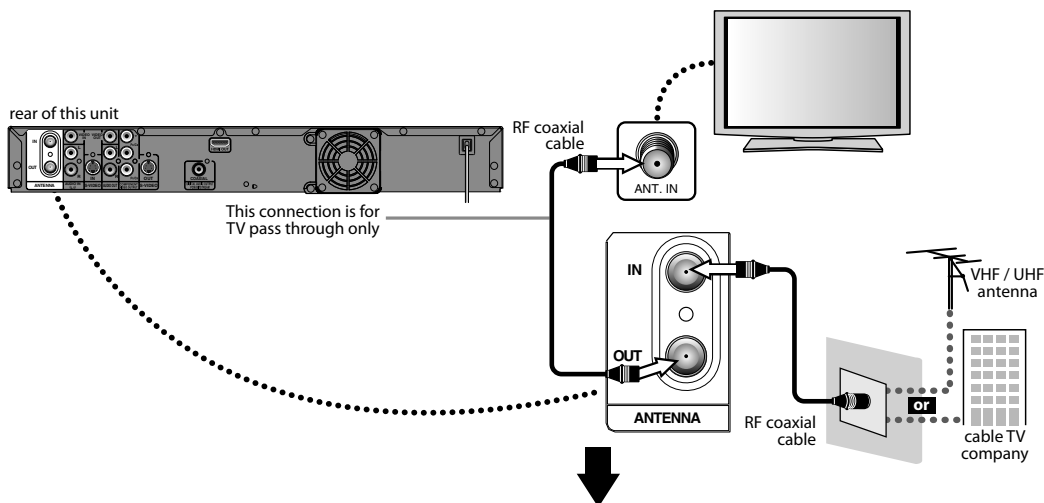

Choose one of the following connections depending on the jacks on your TV.

Note

- For your safety and to avoid damage to the device, please unplug the RF coaxial cable from the ANTENNA IN jack before moving the unit.
- If you use an antenna to receive analog TV, it should also work for DTV reception. Outdoor or attic antennas will be more effective than set-top versions.
- ANTENNA OUT jack is for tuner pass through only. HDD / DVD playback through the RF is not possible.

Supplied cables used in this connection are as follows:

- RF coaxial cable x 1
- Please purchase the rest of the necessary cables at your local store.

Overview

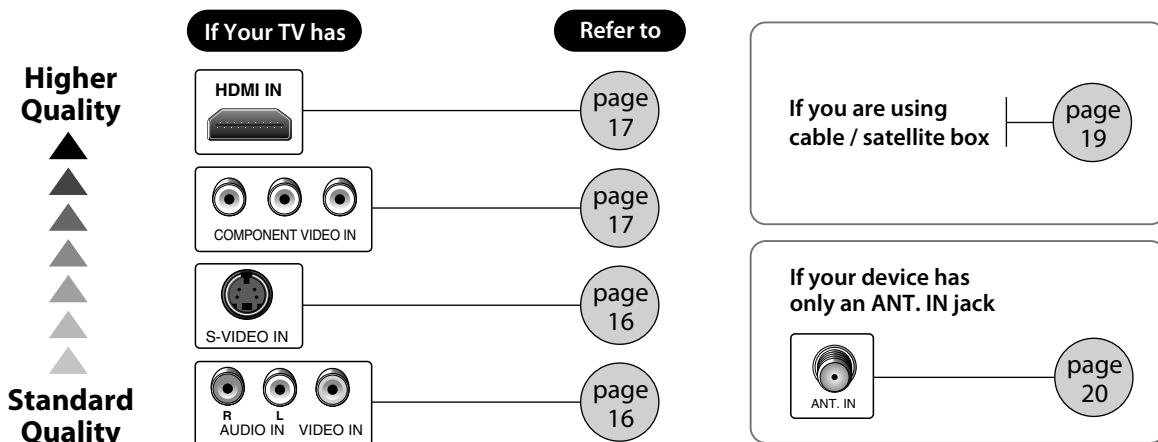

CONNECTION

Connecting to a TV Using Audio /Video jacks

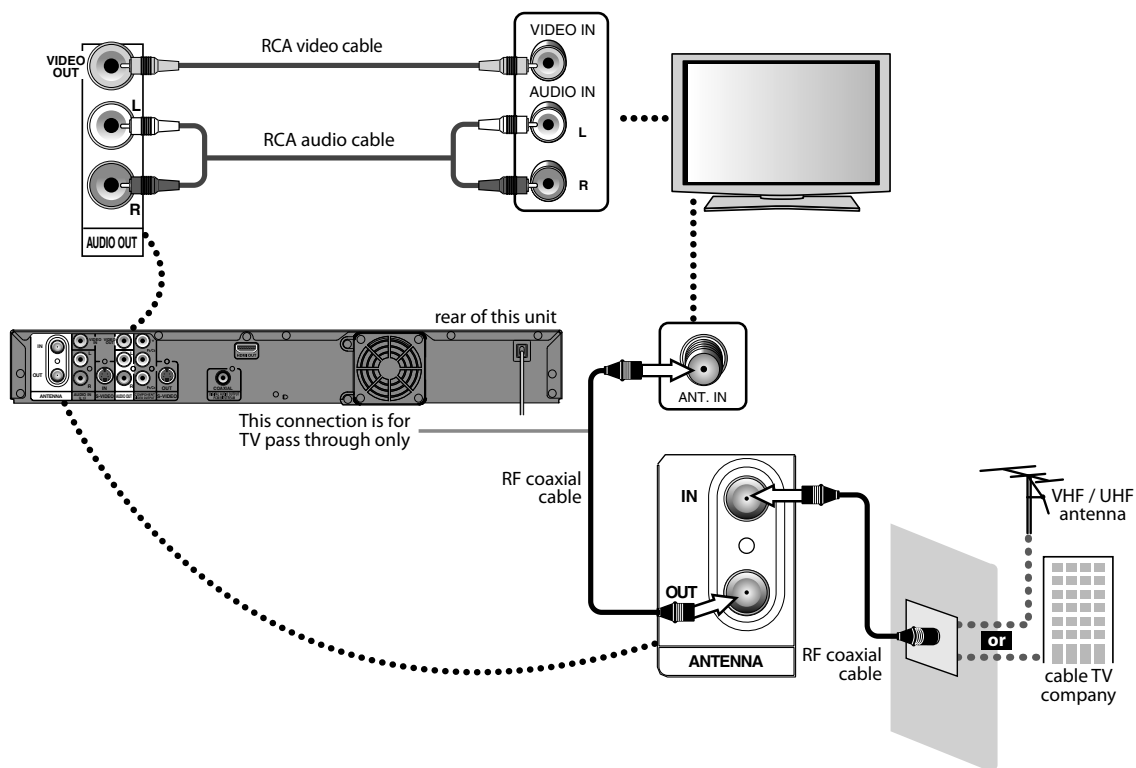

Supplied cables used in this connection are as follows:

- RF coaxial cable x 1
- RCA audio cable (L/R) x 1
- RCA video cable x 1

Please purchase the rest of the necessary cables at your local store.

Connecting to a TV Using the S-Video Out jack

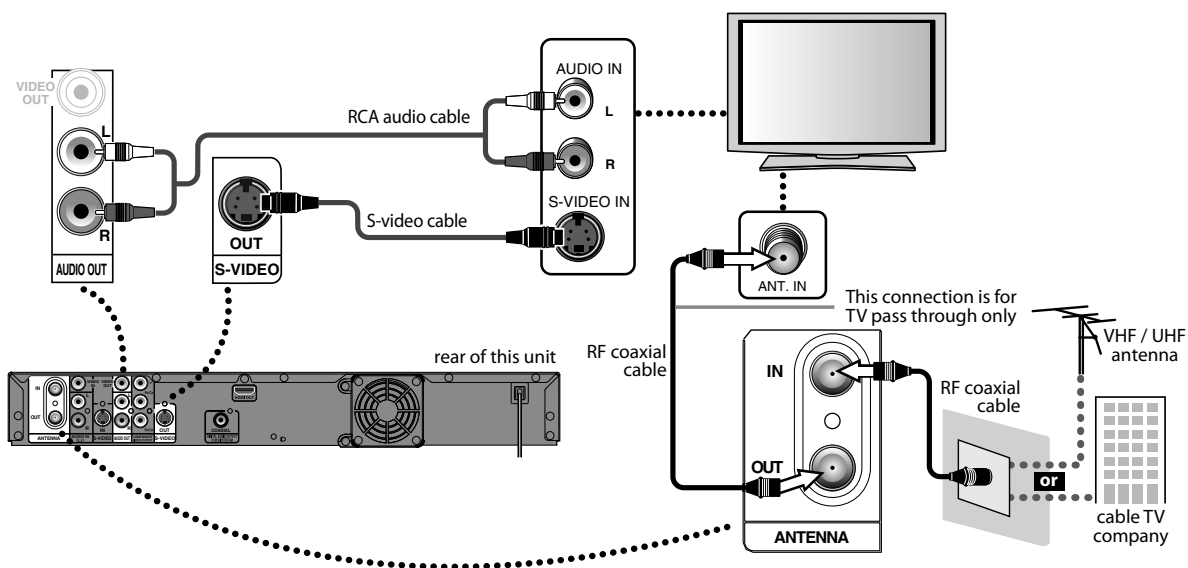

CONNECTION

Connecting to a TV Using Component Video Out jacks

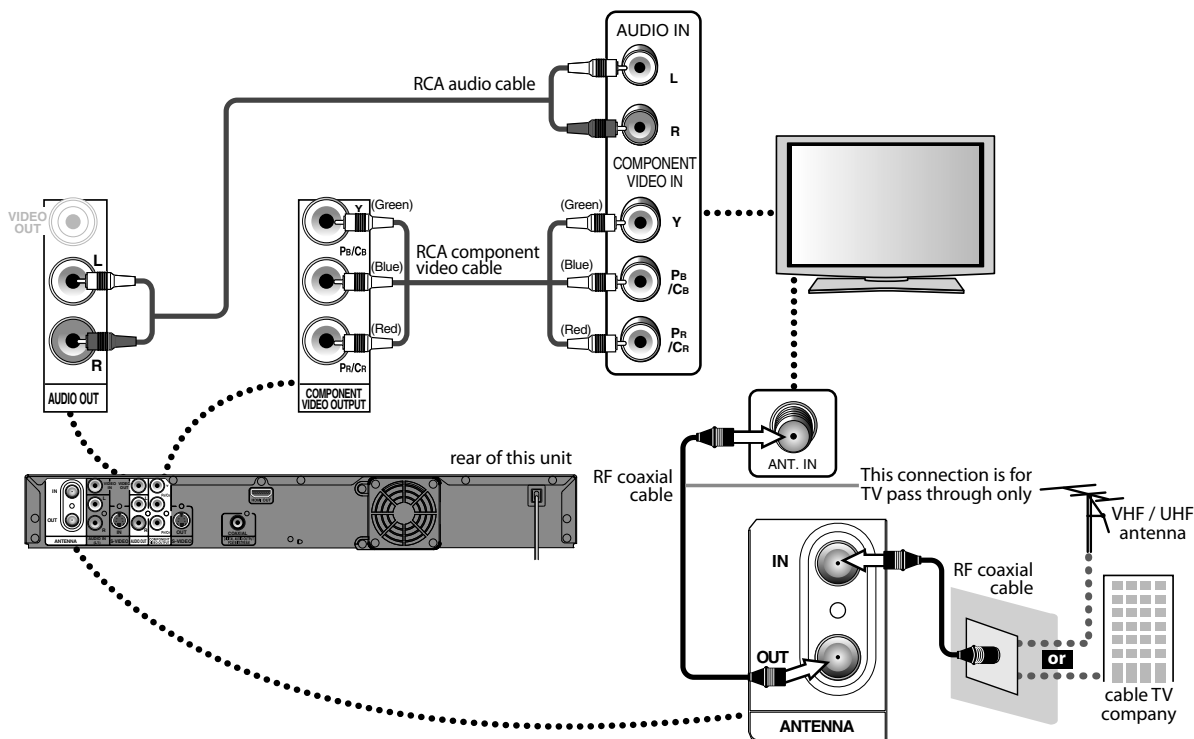

Supplied cables used in this connection are as follows:

- RF coaxial cable x 1
- RCA audio cable (L/R) x 1

Please purchase the rest of the necessary cables at your local store.

Connecting to a TV with an HDMI Compatible Port

- HDMI outputs the video/audio signals without converting to analog signals.
- No audio connection is required.
- High Speed HDMI cable (also known as HDMI category 2 cable) is recommended for better compatibility.
- Use an HDMI cable with the HDMI logo (a certified HDMI cable) for this connection.

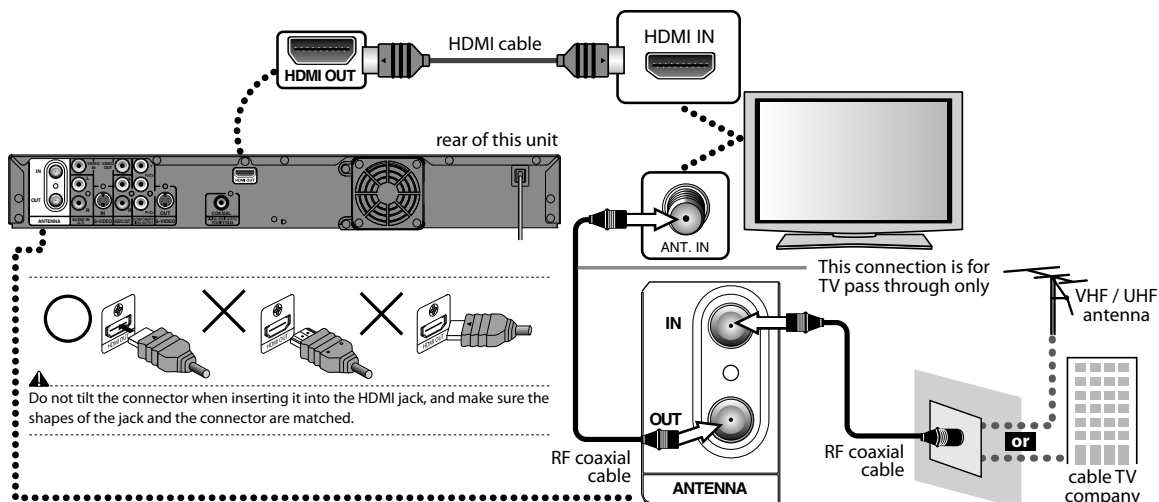

Supplied cables used in this connection are as follows:

- RF coaxial cable x 1

Please purchase the rest of the necessary cables at your local store.

CONNECTION

HDMI Mode and Actual Output Signals

Press **[HDMI]** to select the HDMI output mode. The output mode changes as follows every time **[HDMI]** is pressed.

Front Panel Display	Video Output Signal
480P	480 Progressive
Press [HDMI]	↓
720P	720 Progressive
Press [HDMI]	↓
1080i	1080 interlaced
Press [HDMI]	↓
1080P	1080 Progressive
Press [HDMI]	

Copyright protection system

To play back the digital video images of a DVD via an HDMI connection, it is necessary that both the player and the display device (or an AV amplifier) support a copyright protection system called HDCP (high-bandwidth digital content protection system). HDCP is copy protection technology that comprises data encryption and authentication of the connected AV device. This unit supports HDCP. Please read the operating instructions of your display device (or AV amplifier) for more information.

*HDMI: High Definition Multimedia Interface

- The HDMI mode that is not supported by display device will be skipped.

Note

- Some devices with an HDMI input may not operate properly with this unit.
- When using an HDCP-incompatible display device, the image will not be viewed properly.
- Among the devices that support HDMI, some devices can control other devices via the HDMI connector; this unit can be controlled by another device via the HDMI connector.
- The audio signals from the HDMI connector (including the sampling frequency, the number of channels and bit length) may be limited by the device that is connected.
- Among the monitors that support HDMI, some do not support audio output (for example, projectors). In connections with device such as this unit, audio signals are not output from the HDMI output connector.
- When this unit's HDMI connector is connected to a DVI-D compatible monitor (HDCP compatible) with an HDMI-DVI converter cable, the signals are output in digital RGB.
- When a power failure occurs, or when you unplug the unit, some problems with the HDMI setting might occur. Please check and set the HDMI setting again.

CONNECTION

Connecting to a Cable / Satellite Box

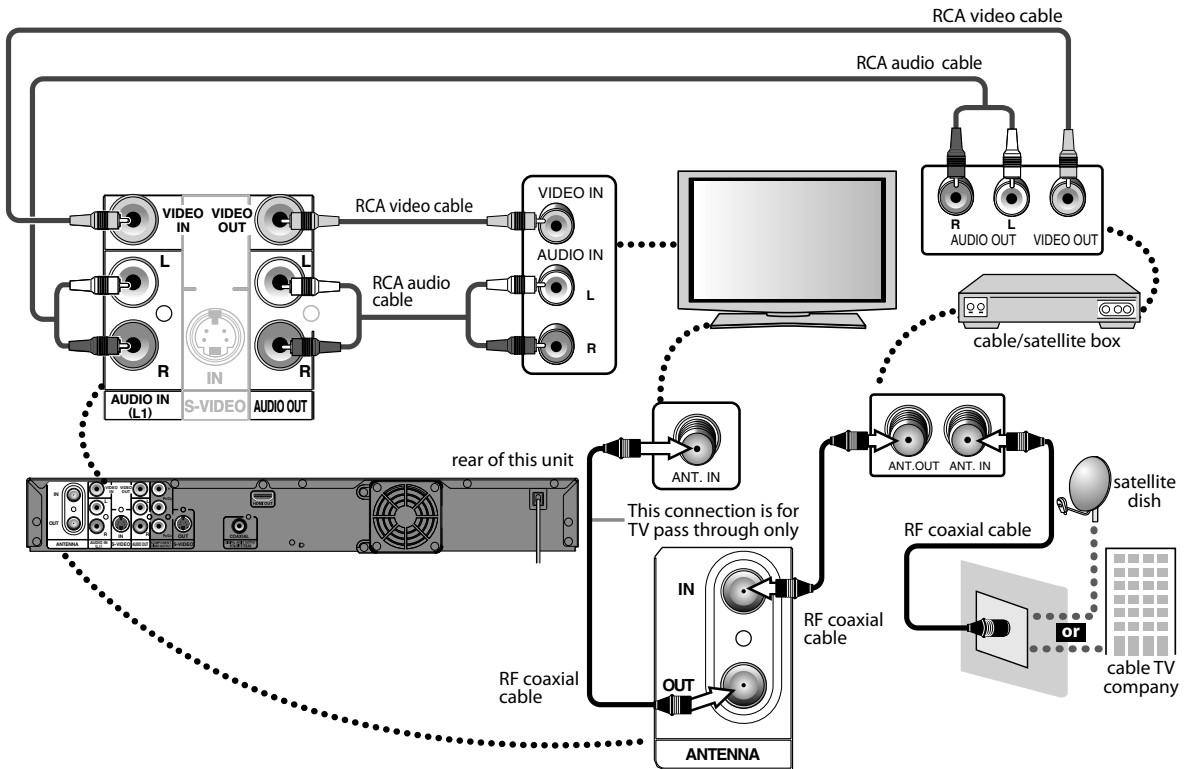

Supplied cables used in this connection are as follows:

- RF coaxial cable x 1
- RCA audio cable (L/R) x 1
- RCA video cable x 1

Please purchase the rest of the necessary cables at your local store.

Note

- Required cables and connecting methods differ depending on the cable/satellite box. For more information, please contact your cable/satellite provider.
- Instead of using VIDEO OUT jack of this unit, you can also use S-VIDEO OUT jack, COMPONENT VIDEO OUTPUT jack or HDMI OUT jack for connecting to your TV.

With this setup:

- You can record any unscrambled non-copy protected program by selecting the channel on the cable/satellite box. Be sure that the cable/satellite box is turned on.
- **You cannot record one channel while watching another channel.**

CONNECTION

Connecting to a TV without Audio /Video jacks

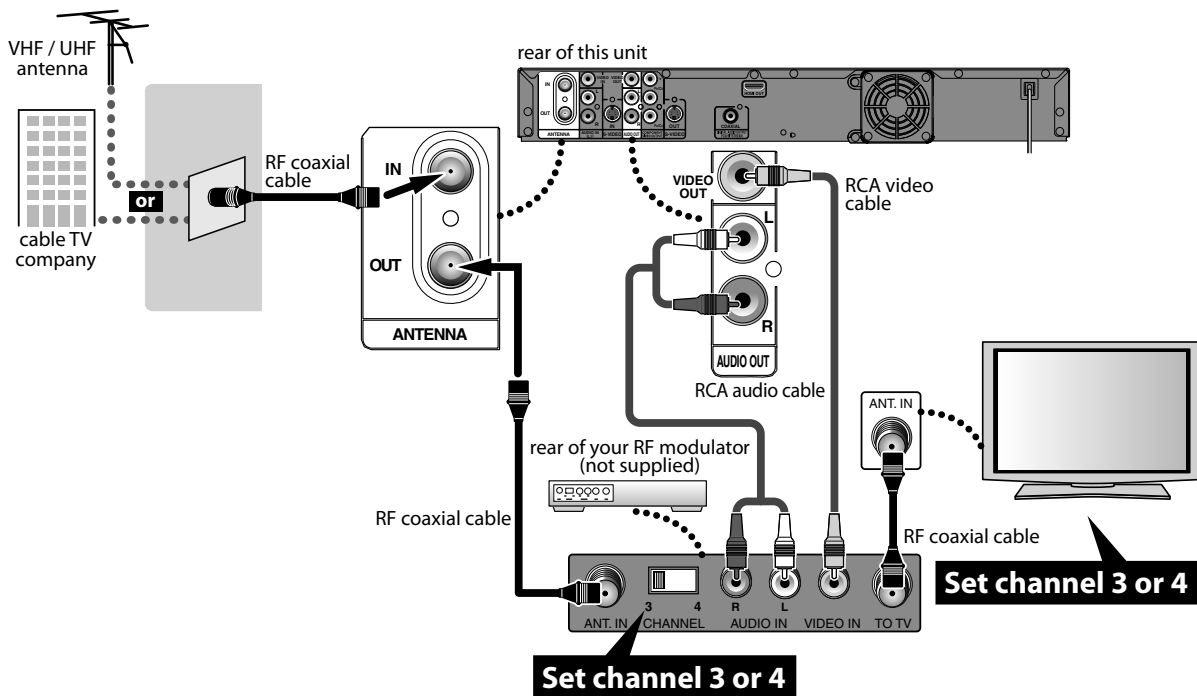

Supplied cables used in this connection are as follows:

- RF coaxial cable x 1
- RCA audio cable (L/R) x 1
- RCA video cable x 1

Please purchase the rest of the necessary cables at your local store.

Note

- **RF modulator is not supplied with this unit. You need to purchase it at your local store.**
- The quality of picture may become poor if this unit is connected to an RF modulator.

CONNECTION

Digital Audio Connection

Coaxial Cable Connection

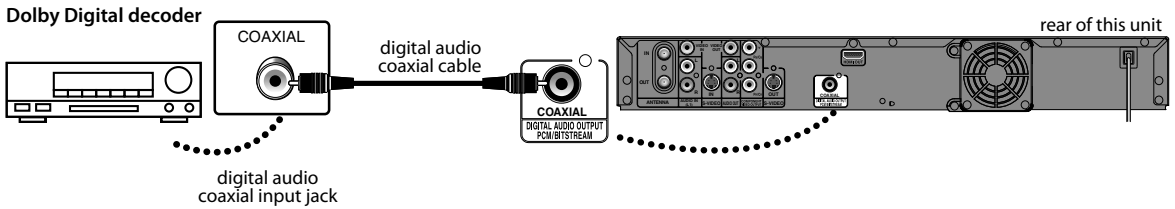

HDMI Audio Connection

AV receiver / amplifier with an HDMI input jack

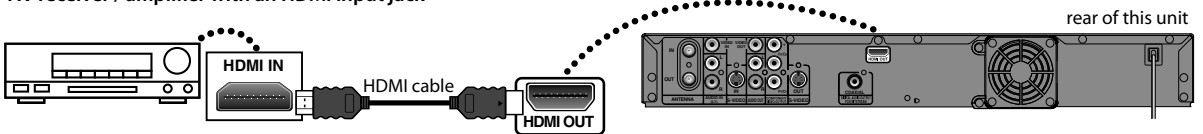

To set up "HDMI Audio" refer to pages 103 and 113.

To set up "Dolby Digital" refer to pages 101 and 106.

Audio format (disc)	Dolby Digital Setting of this unit	HDMI	Digital Output
Dolby Digital	PCM	2 channel PCM	2 channel PCM
	Stream	Dolby Digital	Dolby Digital
LPCM	PCM	2 channel PCM	—
	Stream		

↑
Actual Output

Cables not included.

Please purchase the necessary cables at your local store.

Note

- The audio source on a disc in a Dolby Digital multi channel surround format cannot be recorded as digital sound by an MD or DAT deck.
- By connecting this unit to a Dolby Digital decoder, you can enjoy high-quality Dolby Digital multi channel surround sound as in movie theaters.
- Playing back a DVD using incorrect digital audio settings may generate noise distortion and also damage speakers.

2 Channel Analog Audio Connection

stereo system

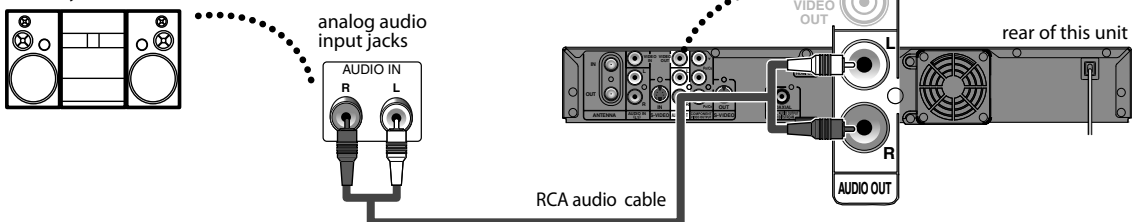

Supplied cables used in these connections are as follows:

- RCA audio cable (L/R) x 1

BEFORE YOU START

Finding the Viewing Channel on your TV

After you have completed all the connections, you must find the viewing channel (external input channel) on your TV.

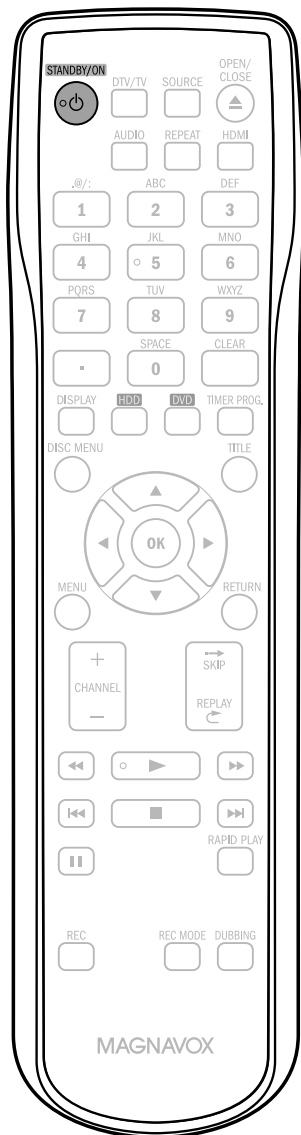

1 After you have made all the necessary connections, press [STANDBY/ON 

2 Turn on your TV.

- If connected to your VCR make sure it is switched off or in standby mode before proceeding.

3 Press "2" on the TV's remote control, then press channel down button repeatedly until you see "Initial Setup" menu.

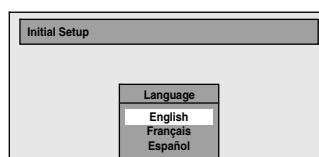

This is the correct viewing channel (external input channel) for the recorder.

- For some TVs, there may be a button on the TV's remote control that accesses the external input channel. It may be labeled "SOURCE", "AV", or "SELECT". In such case, press it repeatedly. Refer to your TV's user manual for details.
- If more than 10 minutes have passed since you have turned on the unit, you may see the MAGNAVOX screen saver instead of "Initial Setup" menu.

MAGNAVOX screen saver:



4 Proceed to step 2 in "INITIAL SETTING" on page 28.

Note

- Video input selection varies for different brand's models of TVs.
- Consult your TV manufacturer if none of the above is successful.

Guide to On-Screen Display / Menu

This unit uses the following on-screen displays and menus to guide you to the easy operations. The on-screen displays give you the information on the loaded disc or the disc/file in playback, or the HDMI status, etc. The menus allow you to change the various kinds of settings for playing back, recording, or editing to suit your preference.

The on-screen display changes in the following order as you press [DISPLAY].

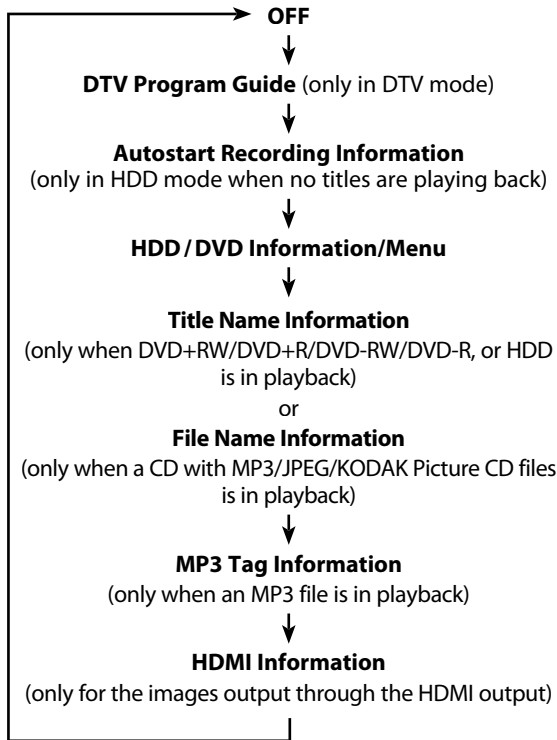

DTV Program Guide

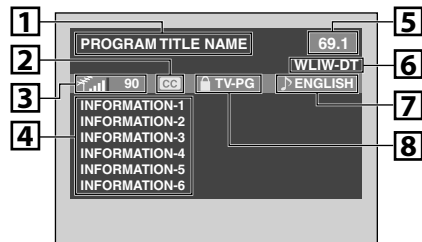

1. Program title (max. 2 lines displayed)
2. Closed Caption (Indicates that the program being broadcast is available with closed captioning.)
3. Signal strength (Indicates the signal strength of the current channel.)
4. Program guide (max. 6 lines displayed)
5. Channel number
6. Broadcast station
7. Audio language ("Other" is displayed when the audio language cannot be acquired, or the acquired languages are other than English, Spanish or French.)
8. Program rating

Note

- When the program guide is displayed in more than 6 lines, use [▲/▼] to scroll.
- "No description provided." is displayed when the program guide is not provided.

Autostart Recording Information

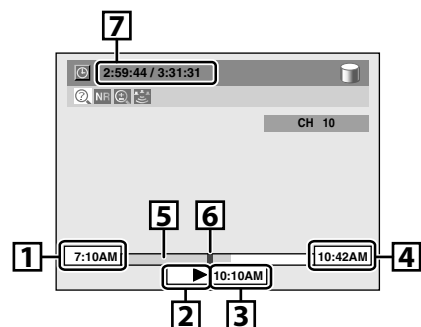

1. Starting time of the autostart recording
2. Status of the time autostart recording
Live: Indicates when watching live TV
▶ : Indicates when playing back the autostart recording.
3. The time that the picture currently displayed on the screen is broadcasted
4. Current time
5. The progress of the autostart recording
6. Current point of the playback of the autostart recording
7. Elapsed time of the playback of the autostart recording / total time of the autostart recording

BEFORE YOU START

HDD / DVD Information / Menu

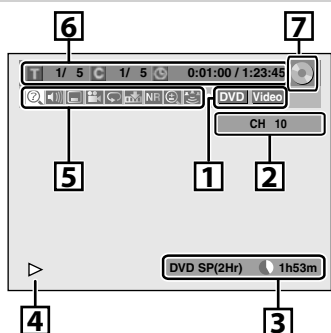

* This is an example screen only for explanation. Displayed items may vary depending on the disc you insert.

1. Indicates the file type or a disc type and format mode. (DVD mode only)

2. Indicates a channel number or selected external input channel.

3. Indicates the component in use, a recording mode and possible recording time left.

The on-screen indication of the possible recording time left on HDD/DVD may differ from the actual recordable time as this unit employs the variable bit rate encoding system which varies the recording (storage) amount of data in conformity with the amount of information on the video.

4. Indicates an operation status.

5. Each icon means:

- : Search
- : Audio
- : Subtitle
- : Angle
- : Repeat
- : Marker
- : Noise Reduction
- : Zoom
- : Surround

6. Indicates the current title number/total number of titles, the current chapter number/total number of chapters, and time lapse of the current title playback/total duration of the title.

7. Indicates the component in use.

- : HDD
- : DVD

Title / File Name Information

Title Name Information

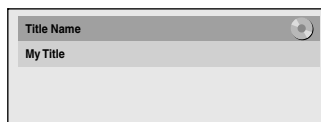

File Name Information

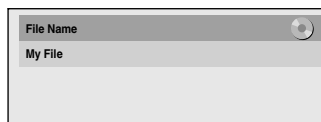

MP3 Tag Information

• First, track name will be displayed.

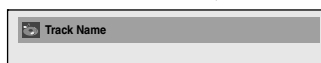

• If you press **[DISPLAY]** one more time, artist name will be displayed.

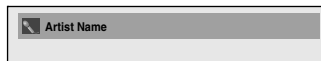

• If you press **[DISPLAY]** one more time, album name will be displayed.

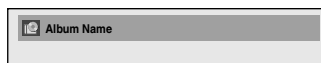

• If there is no artist, track or album name, "Not Available" will be displayed.

HDMI Information

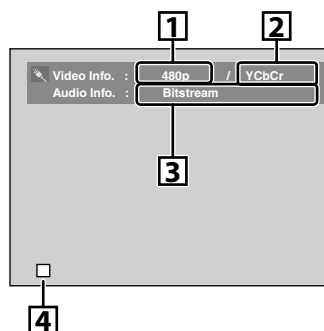

*1. Indicates the resolution of the HDMI output image.

*2. Indicates the HDMI video format.

*3. Indicates the HDMI audio format.

4. Indicates current disc status.

* "-" will be displayed, when it does not have any information.

Main Menu

Press **[MENU]** to display the main menu. Then use **[▲/▼]** to select a menu and press **[OK]** to display the menu. These menus provide entries to all main functions of the unit.

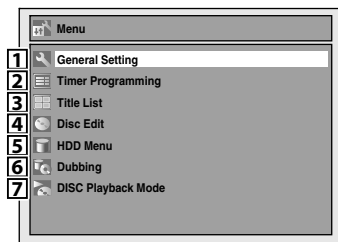

1. General Setting:

To go to general setting menu.

2. Timer Programming:

To program a timer recording.

3. Title List:

To call up the title list.

4. Disc Edit:

To set up the DVD setting.

5. HDD Menu:

To set up the HDD setting.

6. Dubbing:

- To dub the content of the HDD to DVD or vice versa.
- “Dubbing” is available only when a recordable disc is loaded.

7. DISC Playback Mode:

To set up the disc playback setting.

- “DISC Playback Mode” is available only when, an audio CD, a video CD, a CD-RW/-R with MP3/JPEG/KODAK Picture CD files is inserted into the unit.

General Setting Menu

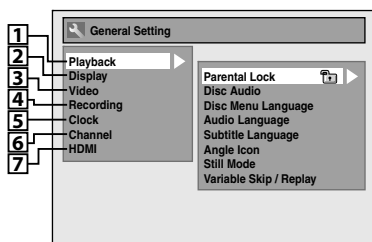

1. Playback:

To set up the unit to play back discs as you prefer.

2. Display:

To set up the screen as you prefer.

3. Video:

To set up the video setting.

4. Recording:

To set up the unit to record to discs as you prefer.

5. Clock:

To set up the clock of the unit as you need.

6. Channel:

To adjust the channel setting of the unit as you prefer.

7. HDMI:

To set up the HDMI connection setting.

Disc Edit / HDD Menu / Dubbing / DISC Playback Mode

<Disc Edit menu (DVD+RW)>

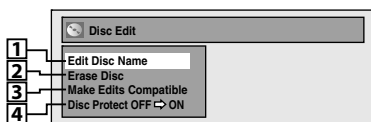

<Disc Edit menu (DVD-RW)>

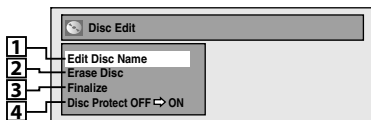

<Disc Edit menu (DVD+R/DVD-R)>

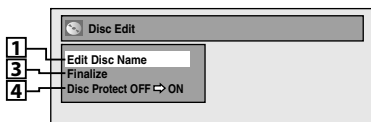

<DISC Playback Mode menu (audio CD/VCD)>

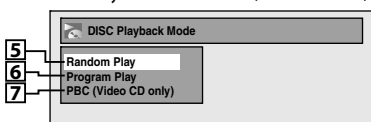

<DISC Playback Mode menu (MP3/JPEG)>

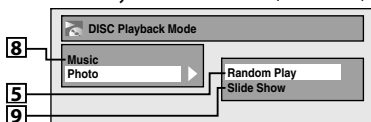

<HDD Menu>

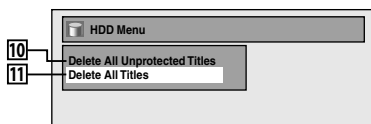

<Dubbing menu>

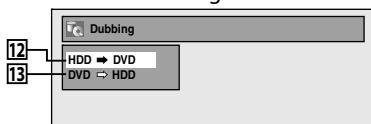

1. Edit Disc Name:

Allows you to rename the disc.

2. Erase Disc: (DVD+RW/DVD-RW only)

Allows you to erase all contents in the disc and format it.

3. Make Edits Compatible: (DVD+RW only)

Allows you to memorize the editing status on the disc if you have added or deleted chapters, or made chapters hidden on this unit, and to show the effects when playing back on the other unit.

Finalize: (DVD+R/DVD-RW/-R only)

Allows you to finalize a disc containing recorded titles.

4. Disc Protect :

Allows you to protect a disc from accidental editing or recording.

5. Random Play:

Allows you to activate the random playback feature.

6. Program Play: (audio CD/video CD only)

Allows you to activate the program playback feature.

7. PBC (Video CD only):

Allows you to select images or information on the menu screen by activating PBC (playback control) function.

8. Music/Photo: (Mixed media disc only)

When a mixed media disc is inserted, this menu screen will appear instead of "DISC Playback Mode" menu allowing you to select the media you want to play.

9. Slide Show: (JPEG/KODAK Picture CD files only)

Allows you to select the display time of the slide show mode.

10. Delete All Unprotected Titles:

Allows you to delete all unprotected titles in the HDD title list.

11. Delete All Titles:

Allows you to delete all titles, including the protected titles, in the HDD title list.

12. HDD → DVD:

Allows you to dub from HDD to DVD.

13. DVD → HDD:

Allows you to dub from DVD to HDD.

Note

- Disc edit is available for a disc which is not finalized or DVD+RW.

BEFORE YOU START

Switching HDD / DVD Mode

Because this unit is a combination of HDD and DVD recorder, you must first select which component (output mode) you wish to operate.

HDD mode

Press [**HDD**] to activate the HDD component.

DVD mode

Press [**DVD**] to activate the DVD component.

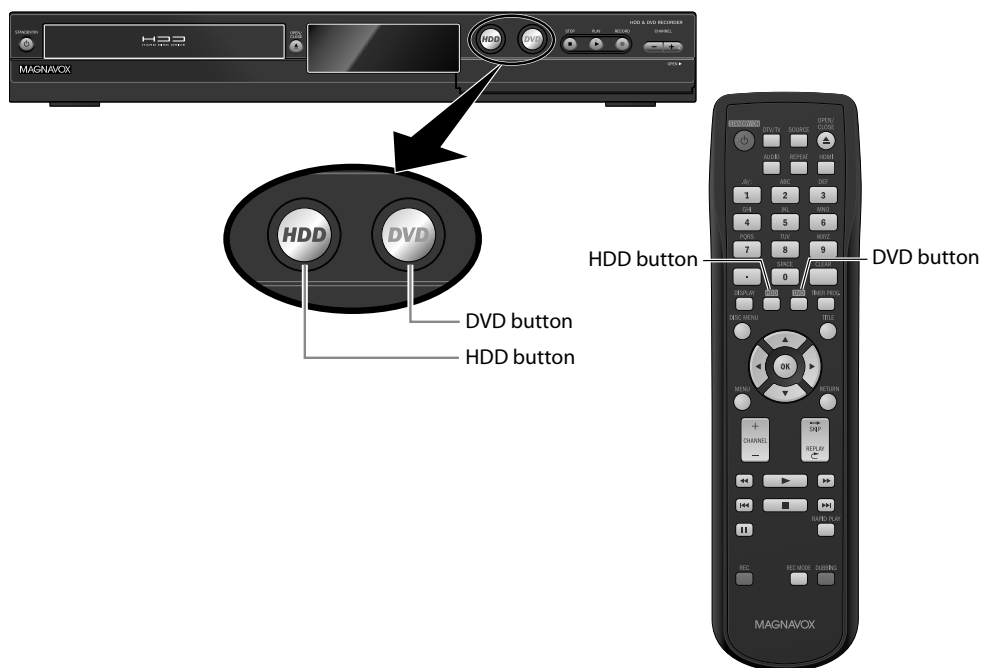

How to Insert a Disc

1) Press [**OPEN/CLOSE ▲**] to open the disc tray.

2) Place the disc on the disc tray with its label side facing up.

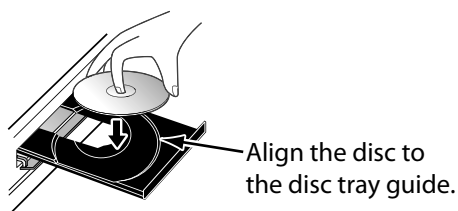

3) Press [**OPEN/CLOSE ▲**] to close the disc tray.

It may take a while to load the disc data after the disc tray closes.

To eject the disc:

Press [**OPEN/CLOSE ▲**] to open the disc tray, then remove the disc before turning the unit to the standby mode.

- When inserting a brand-new DVD+RW/DVD-RW, the unit automatically starts to format.
- If titles have been recorded on the disc, the title list is displayed. Press [**STOP ■**] to exit the title list.

INITIAL SETTING

You need to follow these steps when you turn on this unit for the first time.

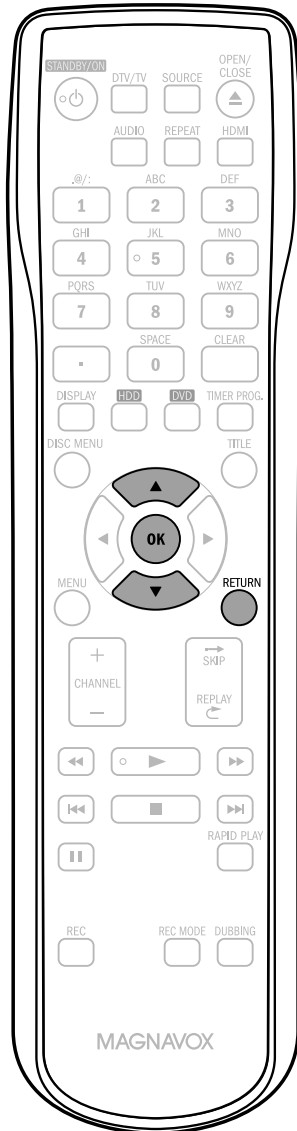

1 Follow the procedure in “Finding the Viewing Channel on Your TV” on page 22 to display “Initial Setup” menu.

2 Use [▲/▼] to select your desired language, then press [OK].

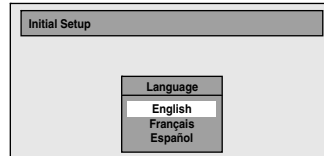

3 Use [▲/▼] to select the type of broadcasting signal, then press [OK].

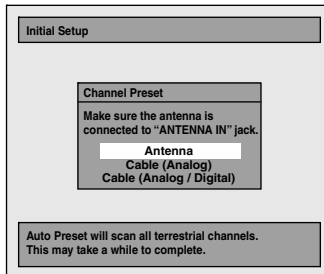

The unit will start getting channels available in your area.

Antenna:

(When using antenna)

The channels broadcasted in analog TV and digital TV are automatically scanned and memorized. Only the receivable channels in the area will be memorized.

Cable (Analog):

(When using basic cable)

The channels broadcasted in analog Cable TV are automatically scanned and memorized.

Cable (Analog / Digital):

(When using basic cable)

The channels broadcasted in analog Cable TV and digital Cable TV are automatically scanned and memorized.



4 If a PBS (public broadcasting station) is available in your area, clock setting may automatically be performed and the correct clock will be displayed following the channel preset procedure.

Initial setting is then complete.

Press [RETURN] to exit.

If a PBS (public broadcasting station) is not available in your area, press [OK]. Then proceed to step 5 in “Manual Clock Setting” on page 34.

CHANNEL SETTING

Auto Channel Scan

If you have changed antenna connection, we recommend that you program available channels in your area with the following procedures.

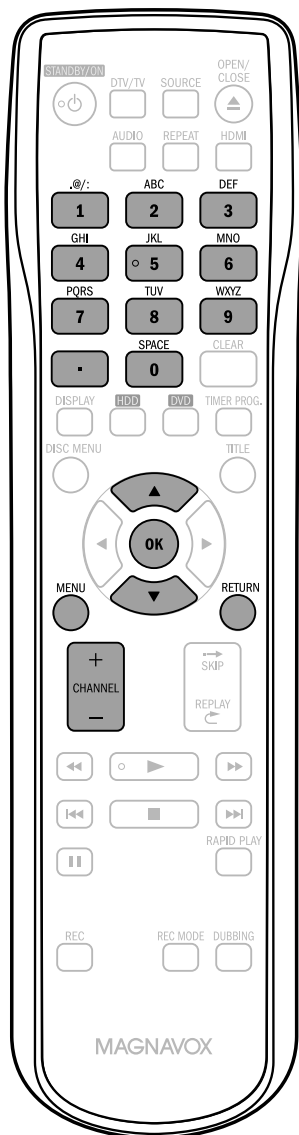

1 Press [MENU] and use [▲/▼] to select **“General Setting”**, then press [OK].
“General Setting” menu will appear.

2 Use [▲/▼] to select **“Channel”**, then press [OK].
“Channel” menu will appear.

3 Use [▲/▼] to select **“Auto Channel Preset”**, then press [OK].

4 Use [▲/▼] to select the type of broadcasting signal, then press [OK].

Auto Channel Preset

Antenna
Cable (Analog)
Cable (Analog / Digital)

The unit will start getting channels available in your area.

- When aerial antenna is connected, select “Antenna”.
- When connected to Cable TV, select “Cable (Analog)” or “Cable (Analog / Digital)”.

To cancel the auto channel preset during scanning:

Press [RETURN] to go the previous screen or [MENU] to cancel.

5 When scanning is over, press [MENU] to exit.

To cycle through only the memorized channels, use [CHANNEL +/–].

To select a channel directly (including the ones not memorized), use [the Number buttons] and [•] (for digital TV channels).

Note

- If the auto channel preset is canceled during presetting, some channels not yet preset may not be received.

CHANNEL SETTING

Adding / Deleting Channels

You may want to add or delete TV channels if your channel lineup changes or if you no longer watch some channels.

Adding a channel is only available for the analog TV channels.

Make sure:

- You perform the "Auto Channel Scan" before adding or deleting the channels.

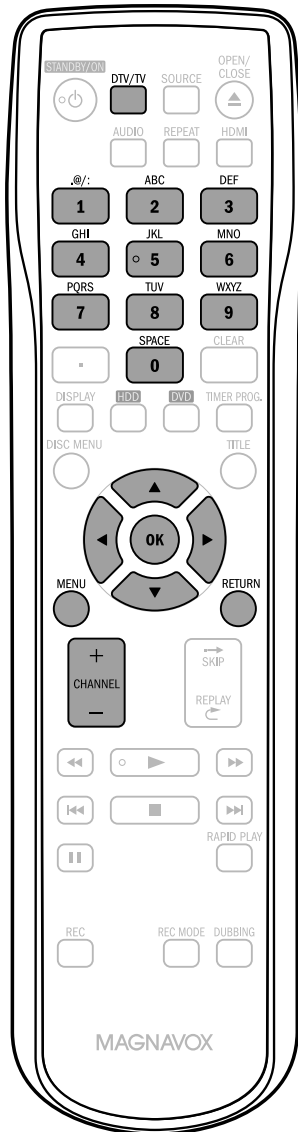

1 Press [DTV/TV] to select the mode (DTV or TV) to/from which you want to add/delete channels.

2 Press [MENU] and use [▲/▼] to select "General Setting", then press [OK]. "General Setting" menu will appear.

3 Use [▲/▼] to select "Channel", then press [OK]. "Channel" menu will appear.

4 Use [▲/▼] to select "Manual Channel Preset", then press [OK].

Auto Channel Preset
Manual Channel Preset
TV Audio Select

- If you are adding or deleting analog TV/Cable channels, go to **ANALOG** to continue.
- If you are deleting digital TV/Cable channels, go to **DIGITAL** to continue.

ANALOG

5 Select the channel number to add or delete.

- Use [CHANNEL +/-] to cycle through only the memorized channels.
- Use [◀/▶] to cycle through all the channels including the ones not memorized.
- Use [the Number buttons] to select a channel directly.
- When a memorized channel is selected, "Add" is checked and highlighted as a default.
- When an unmemorized channel is selected "Delete" is checked and highlighted as a default.

6 Use [▲/▼] to select "Add" or "Delete", then press [OK].

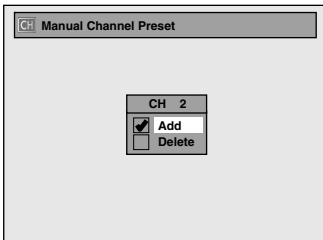

Your setting will be activated and it will automatically switch to the next channel so that you can continue adding or deleting channels.

7 Press [MENU] to exit.

DIGITAL

5 Select the channel number to delete.

- Only the major channel is displayed in "Manual Channel Preset" menu. (The channel number displayed in the parenthesis is a virtual channel number)
- Use [CHANNEL +/-] to cycle through only the memorized channels.
- You cannot use [◀/▶] for the digital TV channel selection.
- Use [the Number buttons] to select a channel directly.
- When a memorized channel is selected, "Add" is checked and highlighted as a default. For Digital channels you can only delete them.
- When an unmemorized channel is selected "Delete" is checked and highlighted as a default.

6 Use [▲/▼] to select "Delete", then press [OK]. Then select the next channel to delete.

- If the setting is complete, press [RETURN] to activate "Manual Channel Preset".

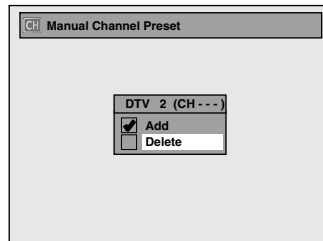

Your setting will be activated.

WARNING:

- For the digital TV channels, you cannot recover the deleted channels once they are deleted unless you perform the auto channel preset again.

7 Press [MENU] to exit.

SETTING THE CLOCK

Auto Clock Setting

This unit can set the time and date automatically by referring to a channel that carries a clock information. If a PBS (public broadcasting station) is available on Cable in your area, follow "Auto Clock Setting" below. If not, follow "Manual Clock Setting" on page 34.

Make sure

- The cable TV connections are correct.
- Channels are set. (Refer to page 29.)

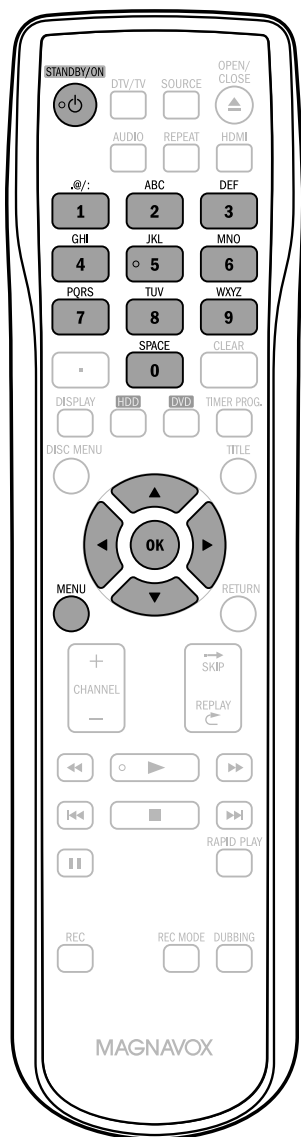

Analog Auto Clock Setting (Cable TV only)

- 1** Press [MENU] and use [▲/▼] to select "General Setting", then press [OK].
"General Setting" menu will appear.
- 2** Use [▲/▼] to select "Clock", then press [OK].
"Clock" menu will appear.
- 3** Use [▲/▼] to select "Auto Clock Setting", then press [OK].
- 4** Use [▲/▼] to select "Auto", then press [OK].

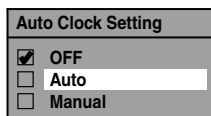

- 5** Press [MENU] to exit.
- 6** Press [STANDBY/ON ⏻] to turn the unit to the standby mode.

This unit will search for the time only when the power is in the standby mode. Initially leave it in standby mode for at least 15 minutes to give this unit time to set the clock. Once the clock is set, the unit receives the clock data at 12:00 am & 12:00 pm when unit is in standby mode. Check the time after the Auto Clock was set, if it is incorrect time then set the "Auto Clock Setting" to "OFF" in step 4 above. Then try "Manual Clock Setting" on page 34.

Note

- The clock may set itself automatically after you connect the antenna/cable signal and plug in the power cord.
- Only the Analog PBS channel Cable TV signal is effective for auto clock setting.
- For analog auto clock setting, incorrect time may be obtained depending on the broadcast information. If this occurs, set the "Auto Clock Setting" to "OFF" at step 4 above and try "Manual Clock Setting" on page 34.

SETTING THE CLOCK

Manual Auto Clock Setting

If the unit chooses an incorrect PBS channel on Cable TV, set the PBS channel manually by following the steps below.

1 Select "Manual" at step 4 in "Analog Auto Clock Setting (Cable TV only)" on page 32, then press [OK].

2 Use [the Number buttons] or [▲/▼] to enter your Cable TV Analog PBS channel number, then press [OK].

Set Channel No.
CH 1

3 Press [MENU] to exit and turn the unit to the standby mode.

Digital Auto Clock Setting

1 Press [MENU] and use [▲/▼] to select "General Setting", then press [OK]. "General Setting" menu will appear.

2 Use [▲/▼] to select "Clock", then press [OK]. "Clock" menu will appear.

3 Use [▲/▼] to select "Auto Clock Setting", then press [OK].

4 Use [▲/▼] to select "Manual", then press [OK].

Auto Clock Setting
<input checked="" type="checkbox"/> OFF
<input type="checkbox"/> Auto
<input type="checkbox"/> Manual

Enable Manual operation to select the DTV Channel for receiving the Clock Data and selecting your Time Zone below.

5 Press [◀] to highlight "CH". Press [▲/▼] to select "DTV", then press [▶].

Set Channel No.
DTV 1

6 Use [the Number buttons] or [▲/▼] to enter the desired major channel number to receive the Clock Data, then press [OK].

7 Use [▲/▼] to select the desired time zone, then press [OK].

Time Zone
<input checked="" type="checkbox"/> Atlantic
<input type="checkbox"/> Eastern
<input type="checkbox"/> Central
<input type="checkbox"/> Mountain
<input type="checkbox"/> Pacific
<input type="checkbox"/> Alaska
<input type="checkbox"/> Hawaii

8 Press [MENU] to exit and turn the unit to the standby mode.

This unit will search for the time only when the power is in the standby mode. Initially leave it in standby mode for at least 15 minutes to give this unit time to set the clock. Once the clock is set, the unit receives the clock data at 12:00 am & 12:00 pm when unit is in standby mode. Check the time after the Auto Clock was set, if it is incorrect time then set the "Auto Clock Setting" to "OFF" in step 4 above. Then try "Manual Clock Setting" on page 34.

Note for auto clock setting

- The clock may set itself automatically after this unit receives the antenna/cable signal and plug in the power cord.
- If the clock is not set correctly, timer recording does not work properly.
- Analog off the air broadcasts have ended. Analog auto clock setting will no longer be available except via Cable TV. Try digital auto clock setting in this case.
- For digital auto clock setting, incorrect time may be obtained depending on the broadcast information. If this occurs, set the "Auto Clock Setting" to "OFF" at step 4 and try "Manual Clock Setting" on page 34.

Time adjustment for each time zone

Atlantic	GMT (Greenwich Mean Time) - 4 hours
Eastern	GMT (Greenwich Mean Time) - 5 hours
Central	GMT (Greenwich Mean Time) - 6 hours
Mountain	GMT (Greenwich Mean Time) - 7 hours
Pacific	GMT (Greenwich Mean Time) - 8 hours
Alaska	GMT (Greenwich Mean Time) - 9 hours
Hawaii	GMT (Greenwich Mean Time) - 10 hours

SETTING THE CLOCK

Manual Clock Setting

1 Press [MENU] and use [▲/▼] to select "General Setting", then press [OK].
"General Setting" menu will appear.

2 Use [▲/▼] to select "Clock", then press [OK].
"Clock" menu will appear.

3 Use [▲/▼] to select "Clock Setting", then press [OK].

4 Use [▲/▼] to select calendar or time, then press [OK].

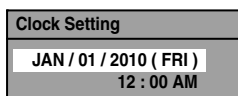

5 Use [◀/▶] to select an item to set, and use [▲/▼] to select the contents to suit your preference, then press [OK] when you finish setting all the contents.

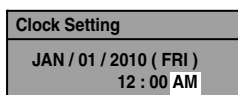

Your setting will be activated.
The clock starts counting when you press [OK].

6 Press [MENU] to exit.

Daylight Saving Time

When "Daylight Saving Time" is "ON", the unit clock will automatically adjust the time in order to fit the daylight saving time.

"ON (MAR - NOV)" has been selected as the default.

1 Press [MENU] and use [▲/▼] to select "General Setting", then press [OK].
"General Setting" menu will appear.

2 Use [▲/▼] to select "Clock", then press [OK].
"Clock" menu will appear.

3 Use [▲/▼] to select "Daylight Saving Time", then press [OK].

4 Use [▲/▼] to select "ON (MAR - NOV)", "ON (APR - OCT)" or "OFF", then press [OK].

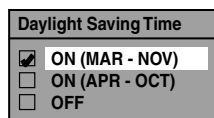

ON (MAR - NOV):

Move forward one hour on the second Sunday in March and move back one hour on the first Sunday in November.

ON (APR - OCT):

Move forward one hour on the first Sunday in April and move back one hour on the last Sunday in October.

5 Press [MENU] to exit.

Note

- Your setting will be canceled if you press [MENU] before pressing [OK] at step 5.
- Your clock setting will be lost if either there is a power failure or this unit has been unplugged for more than 1 hour when you set the clock manually.
- For setting the day, year, hour, and minute, [the Number buttons] can also be used.
- You can set the built-in calendar from the year 2009 up to 2059.

TUNER SETTINGS

Switching Analog Mode/Digital Mode

You can easily switch the analog TV (NTSC) and digital TV (ATSC) with the remote control.

Press [DTV/TV] on the remote control.

- The analog mode and digital mode switch alternately.

Channel Selection

Select channels by using [CHANNEL +/-] or [the Number buttons] found on remote control.

[CHANNEL +/-]

Use [CHANNEL +/-] to change the channel.

[the Number buttons]

Press the channel number with [the Number buttons] to select a channel you want to watch.

<Analog TV Channels>

Enter the channel number with [the Number buttons] to select a channel you want to watch.

For 1-digit number

e.g.) 2 ch: [0] + [2], [2] + [•] or [2] + leave it for 2 seconds.

For 2-digit number

e.g.) 12ch: [1] + [2]

<Digital TV Channels>

Enter the major and minor channel number with [the Number buttons] to select a channel you want to watch.

For 1-digit number

e.g.) 2.1 ch:
major channel [0] + [2] or [2] + [•]
minor channel [0] + [1], [1] + [•] or [1] + leave it for 2 seconds.

For 2-digit number

If 2 channel numbers are pressed consecutively, that number will become the major channel.

e.g.) 35.1ch:
major channel [3] + [5] + [•]
minor channel [1]

- If you enter 1 or 2 digit for major channel and leave it for 2 seconds, the number will be taken as the major channel and lowest minor channel of the major channel will be displayed.

Note

- It may take up to 5 to 7 seconds to switch the digital TV channels.
- In digital TV broadcasting, 2 or more channels, called minor channels, are simultaneously broadcast on one main channel, called major channel.

About digital TV broadcasting:

With its high definition broadcast, digital broadcasting far surpasses analog broadcasting in both its picture and sound quality.

What is the minor channel?

By using high compression technology, digital broadcasting offers a service that enables multiple signals to send simultaneously.

Therefore, you can select more than one program per major channel since digital broadcasting technology distinguishes between multiple channels broadcast by a single network.

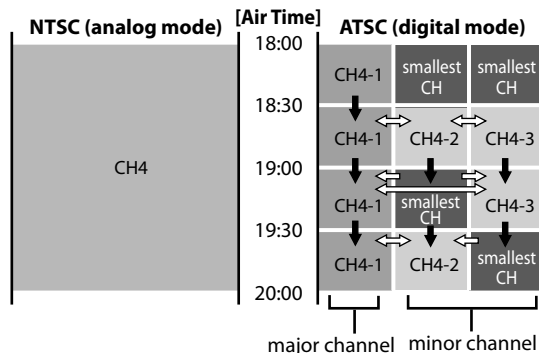

➔ : change automatically

⇔ : change manually by using [CHANNEL +/-] or [the Number buttons]

TUNER SETTINGS

Selecting TV Audio

This section describes how to switch the TV audio. When you record a TV program, only the audio selected here will be recorded.

Digital TV

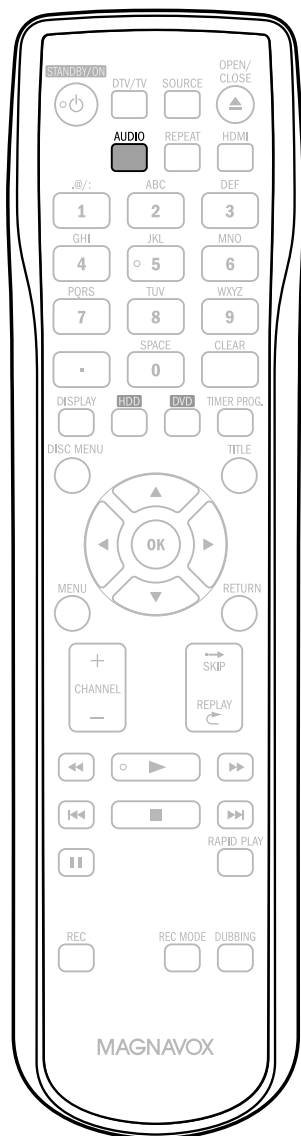

1 Press [AUDIO] to cycle through available audio languages.

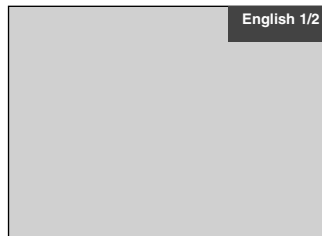

- When you press **[AUDIO]**, selected language will be displayed on the TV screen.
- Every time you press **[AUDIO]**, the language will be switched.
e.g.) English 1/3 → Spanish 2/3 → Other 3/3
- Available languages differ depending on the broadcast.
- The language information display will automatically disappear.
- When you record digital TV broadcasting, the audio language you have selected will be recorded.

Note

- You cannot change the audio language for the recording of digital TV broadcasting.
- Pressing **[AUDIO]** does not control external device audio.
- When there is only one audio channel on the broadcast, pressing **[AUDIO]** does not display anything.

TUNER SETTINGS

Analog TV

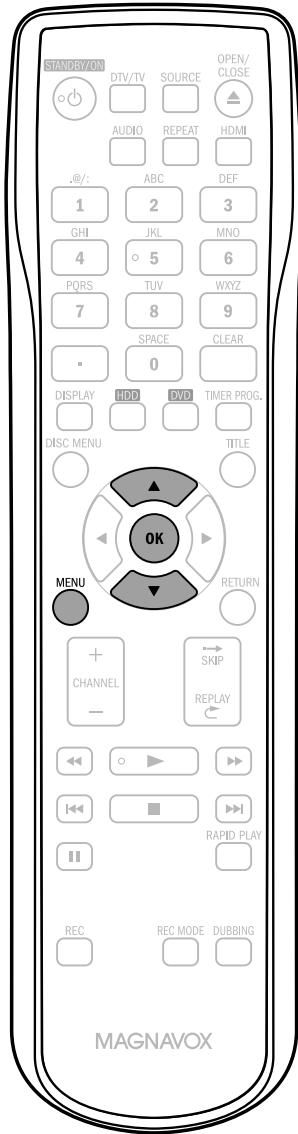

1 Press [MENU] and use [▲/▼] to select “General Setting”, then press [OK].
“General Setting” menu will appear.

2 Use [▲/▼] to select “Channel”, then press [OK].
“Channel” menu will appear.

3 Use [▲/▼] to select “TV Audio Select”, then press [OK].

4 Use [▲/▼] to select “Stereo” or “SAP”, then press [OK].

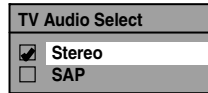

Stereo:

Outputs main-audio.

SAP (secondary audio program):

Outputs sub-audio.

5 Press [MENU] to exit.

Note on recording analog TV audio

- When you record an analog TV program available in second audio or stereo, you have to select either “Stereo” or “SAP” in “General Setting” menu beforehand. Refer to the following table to check an appropriate setting.

Selected audio	Broadcast audio	Disc recording	Audio output
Stereo	STEREO+SAP	STEREO	STEREO
	STEREO	STEREO	STEREO
	MONO+SAP	MONO	MONO
	MONO	MONO	MONO
SAP	STEREO+SAP	SAP	SAP
	STEREO	STEREO	STEREO
	MONO+SAP	SAP	SAP
	MONO	MONO	MONO

TUNER SETTINGS

DTV Closed Caption

Digital TV

Digital TV has its own closed captions called DTV CC. Use this menu to change the settings for DTV CC.

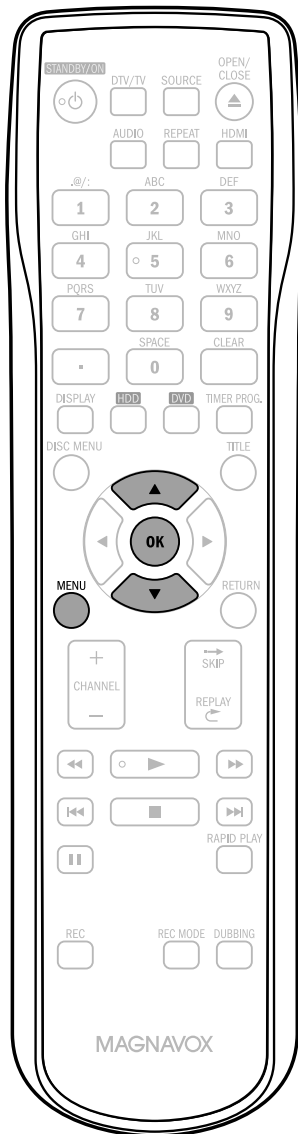

1 Press [MENU] and use [▲/▼] to select "General Setting", then press [OK].
"General Setting" menu will appear.

2 Use [▲/▼] to select "Display", then press [OK].

3 Use [▲/▼] to select "DTV CC", then press [OK].

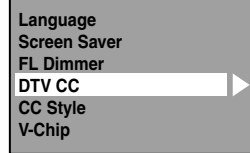

4 Use [▲/▼] to select "Caption Service", then press [OK].

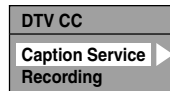

5 Use [▲/▼] to the desired DTV closed caption, then press [OK].

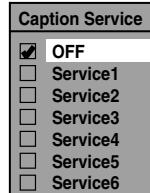

OFF:

Select if you do not want DTV CC. This is the default.

Service 1 to Service 6:

Select one of these before changing any other item in the closed caption menu. Choose "Service 1" under normal circumstances.

6 Press [MENU] to exit.

TUNER SETTINGS

Closed Caption Style

Digital TV

Digital TV can also change the style of its closed caption such as font, color or size, etc.

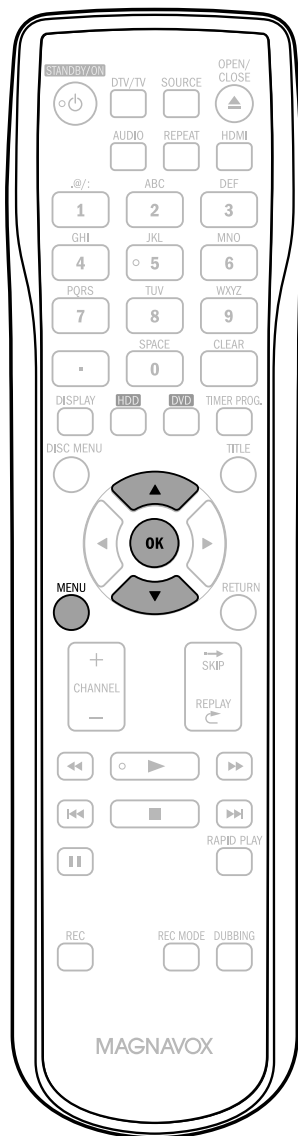

1 Press [MENU] and use [▲/▼] to select "General Setting", then press [OK].
"General Setting" menu will appear.

2 Use [▲/▼] to select "Display", then press [OK].

3 Use [▲/▼] to select "CC Style", then press [OK].

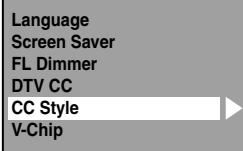

4 Use [▲/▼] to select "User Setting", then press [OK].

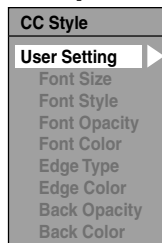

5 Use [▲/▼] to select "ON", then press [OK].

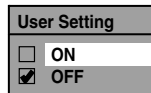

Instructions continue on the next page.

6 Use [▲/▼] to select the item and switch the setting for each item you want to set, then press [OK].

- When "User Setting" is set to "ON", you can set the following items. CC style set by "User Setting" will be displayed.
- The setting description for each item is shown below.

Font size of the displayed caption can be switched as below.

Font Size	
<input checked="" type="checkbox"/>	Large
<input type="checkbox"/>	Middle
<input type="checkbox"/>	Small

Font style of the displayed caption can be switched as below.

Font Style	
<input checked="" type="checkbox"/>	Style1
<input type="checkbox"/>	Style2
<input type="checkbox"/>	Style3
<input type="checkbox"/>	Style4
<input type="checkbox"/>	Style5
<input type="checkbox"/>	Style6
<input type="checkbox"/>	Style7
<input type="checkbox"/>	Style8

Font opacity of the displayed caption can be switched as below.

Font Opacity	
<input checked="" type="checkbox"/>	Solid
<input type="checkbox"/>	Transparent
<input type="checkbox"/>	Translucent
<input type="checkbox"/>	Flash

Font color of the displayed caption can be switched as below.

Font Color	
<input checked="" type="checkbox"/>	White
<input type="checkbox"/>	Black
<input type="checkbox"/>	Red
<input type="checkbox"/>	Green
<input type="checkbox"/>	Blue
<input type="checkbox"/>	Yellow
<input type="checkbox"/>	Magenta
<input type="checkbox"/>	Cyan

<Edge Type>

Edge type of the displayed caption can be switched as below.

Edge Type	
<input checked="" type="checkbox"/>	None
<input type="checkbox"/>	Raised
<input type="checkbox"/>	Depressed
<input type="checkbox"/>	Uniform
<input type="checkbox"/>	L.Shadow
<input type="checkbox"/>	R.Shadow

<Edge Color>

Edge color of the displayed caption can be switched as below.

Edge Color	
<input type="checkbox"/>	White
<input checked="" type="checkbox"/>	Black
<input type="checkbox"/>	Red
<input type="checkbox"/>	Green
<input type="checkbox"/>	Blue
<input type="checkbox"/>	Yellow
<input type="checkbox"/>	Magenta
<input type="checkbox"/>	Cyan

<Back Opacity>

Background opacity of the displayed caption can be switched as below.

Back Opacity	
<input checked="" type="checkbox"/>	Solid
<input type="checkbox"/>	Transparent
<input type="checkbox"/>	Translucent
<input type="checkbox"/>	Flash

<Back Color>

Background color of the displayed caption can be switched as below.

Back Color	
<input type="checkbox"/>	White
<input checked="" type="checkbox"/>	Black
<input type="checkbox"/>	Red
<input type="checkbox"/>	Green
<input type="checkbox"/>	Blue
<input type="checkbox"/>	Yellow
<input type="checkbox"/>	Magenta
<input type="checkbox"/>	Cyan

7 Press [MENU] to exit.

INFORMATION ON RECORDING







Before you make a recording, read the following information.

Recordable Discs

This unit can record to DVD+RW, DVD+R, DVD-RW and DVD-R.

DVD+R/DVD-R can only be recorded to once. DVD+RW/DVD-RW can be recorded to and erased many times.

DVD-RW/-R will be recorded in the DVD+VR mode automatically in this unit.

Logos	Attributes
 DVD+ReWritable	8cm/12cm, single-sided, single layer disc Approx. max. recording time (SLP mode): 360 minutes (4.7GB) (for 12cm) 108 minutes (1.4GB) (for 8cm)
 DVD+R	
 DVD+RW	360 minutes (4.7GB) (for 12cm) 108 minutes (1.4GB) (for 8cm)
 DVD+R	
 DVD-RW	
 DVD-R	

- The following discs are recommended for good recording quality and are proven to be compatible with this unit. However, depending on the media condition the unit may not read the disc properly.

Verbatim DVD+R 8x, DVD+RW 4x,
DVD-R 8x, DVD-RW 2x

JVC DVD-RW 4x

Maxell DVD+R 4x/8x/16x, DVD-R 8x/16x

SONY DVD+R 4x/8x/16x, DVD+RW 4x

TDK DVD+R 4x/8x/16x

Performance of any other discs are not guaranteed.

- **You can play back DVD+RW on most DVD players without finalizing. However, if you have added or deleted chapters, or made chapters hidden, you must perform "Make Edits Compatible" before being able to see those effects on other units. (Refer to page 99 for more details.) To play back discs other than DVD+RW on other DVD players, you will need to finalize.**

Unrecordable Discs

- DVD-RW recorded in the mode other than +VR is not recordable on this unit unless you erase all contents in the disc (refer to page 98).
- DVD-R recorded in the mode other than +VR is not recordable on this unit.

Maximum recordable numbers of title / chapters

HDD :	600 titles 99 chapters per title
DVD :	49 titles per disc 254 chapters per disc 99 chapters per title

Recording Mode

You can select a recording mode among 6 options, and the recording time will depend on the recording mode you select as follows.

Disc size	Recording mode	Recording time	Video/sound quality
8cm Disc	HQ	18 min	☆☆☆☆☆☆ (good)
	SP	36 min	☆☆☆☆☆
	SPP	45 min	☆☆☆☆
	LP	54 min	☆☆☆
	EP	72 min	☆☆
	SLP	108 min	☆ (poor)
12cm Disc	HQ	60 min	☆☆☆☆☆☆ (good)
	SP	120 min	☆☆☆☆☆
	SPP	150 min	☆☆☆☆
	LP	180 min	☆☆☆
	EP	240 min	☆☆
	SLP	360 min	☆ (poor)
HDD (Internal)	HQ	103 hrs	☆☆☆☆☆☆ (good)
	SP	206 hrs	☆☆☆☆☆
	SPP	258 hrs	☆☆☆☆
	LP	310 hrs	☆☆☆
	EP	413 hrs	☆☆
	SLP	620 hrs	☆ (poor)

- The recording time is only an estimate. The actual recording time may differ.
- The audio and video quality gets poorer as the recording time becomes longer.
- Each time [REC MODE] is pressed, recording mode and its allowed recording time will be displayed.

Note

- **This unit cannot record to CD-RW or CD-R.**
- All high definition pictures will be down converted to the standard definition pictures when they are recorded on this unit.
- DVD+RW/+R, DVD-RW/-R and CD-RW/-R recorded on a personal computer or a DVD or CD recorder may not be played back if the disc is damaged or dirty or if there is condensation on the player's lens.
- If you record a disc using a personal computer, even if it is recorded in a compatible format it may not be played back because of the settings of the application software used to create the disc. (Check with the software publisher for more detailed information.)
- Since the recording is made by the VBR (variable bit rate) method, depending on the picture you are recording, the actual remaining time for recording may be a little shorter than the remaining time displayed on the TV screen.
- You cannot record a copy-protected program using this unit. (Copy-protected signal is included in DVD-video, some satellite and cable broadcasts.)
- You cannot record "copy-once only" program's on DVD.

About HDD

HDD is a special device which has high recording density and is suited for long-time recording or high-speed cueing but by contrast, has many factors which can cause breakage. Use HDD on the premise that you should dub the recorded programs to a DVD to protect your precious videos.

HDD is a temporary storage location:

HDD is not a permanent storage location of the recorded contents. Be sure to use it as a temporary storage location until you watch the programs once, edit them, or dub them to a DVD.

Be sure to dub (back up) data promptly if you find abnormalities in HDD:

If there is mechanical trouble with the HDD, grinding or other sounds may be heard or blocky noise may appear on the image. If you continue to use as it is, deterioration may continue and eventually the HDD may not be usable at all. If you notice these symptoms of a failing HDD, promptly dub the data to a DVD. When an HDD fails, recovery of recorded content (data) may be impossible.

About the remaining capacity of HDD recording time:

The on-screen indication of the possible recording time left on HDD / DVD may differ from the actual recordable time as this unit employs the variable bit rate encoding system which varies the recording (storage) amount of data in conformity with the amount of information on the video.

Before recording to the HDD, ensure there is sufficient space on the HDD by deleting unnecessary titles in advance.

BEFORE RECORDING

Make Recording Compatible



Use this feature to make unfinalized +VR mode discs recorded on another unit recordable on this unit. When you make an additional recording on this unit with "Make Recording Compatible" set to "ON", the title menu is automatically converted to our style.

- 1) Press [MENU] and use [▲/▼] to select "General Setting", then press [OK].
"General Setting" menu will appear.
- 2) Use [▲/▼] to select "Recording", then press [OK].
"Recording" menu will appear.
- 3) Use [▲/▼] to select "Make Recording Compatible", then press [OK].
- 4) Use [▲/▼] to select "ON" or "OFF", then press [OK].

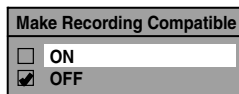

ON: Title list will be replaced when you make additional recordings to the discs recorded by other units.

OFF: Prohibiting additional record to the disc that has a title list created by other units.

- 5) Press [MENU] to exit.

Setting for Auto Chapter

You can set a specified time for chapter marks.

- 1) Press [MENU] and use [▲/▼] to select "General Setting", then press [OK].
"General Setting" menu will appear.
- 2) Use [▲/▼] to select "Recording", then press [OK].
"Recording" menu will appear.
- 3) Use [▲/▼] to select "Auto Chapter", then press [OK].
- 4) Use [▲/▼] to select a desired time option, then press [OK].

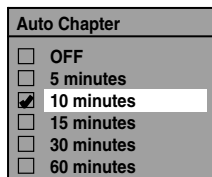

- 5) Press [MENU] to exit.

Note

- The interval for auto chapter may be up to two minutes different from the time option you set.
- A blank chapter may be created depending on the remaining time of the disc.

Recording the DTV Closed Caption

You can record the DTV Closed Caption as the part of the image for the recording program and see the recorded closed caption even with the TV that is not closed caption compliant.

- 1) Press [MENU] and use [▲/▼] to select "General Setting", then press [OK].
- 2) Use [▲/▼] to select "Display", then press [OK].
- 3) Use [▲/▼] to select "DTV CC", then press [OK].
- 4) Use [▲/▼] to select "Recording", then press [OK].
 - If "Caption Service" is set to "OFF", you cannot select "Recording".
- 5) Use [▲/▼] to select "ON", then press [OK].

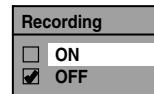

- 6) Press [MENU] to exit.

Note

- If "Caption Service" is set to "OFF", the caption will not be recorded.

BASIC RECORDING & ONE-TOUCH TIMER RECORDING

Follow the steps to record TV programs.

If you are recording to the HDD, press **[HDD]** first, then proceed to step 2.

If you are recording to a disc, press **[DVD]** first.

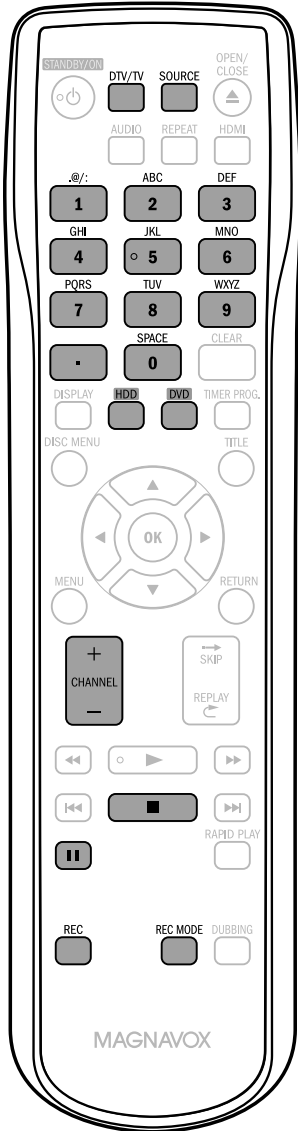

1 Insert a recordable disc (refer to page 27 on how to insert a disc).

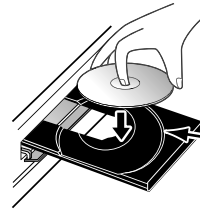

Align the disc to the disc tray guide.

* Make sure the disc is compatible with this unit. (Refer to page 41 for the list of compatible discs.)

It may take a while to load the disc data after the disc tray closes.

- When inserting a brand-new DVD+RW/DVD-RW, the unit automatically starts to format. (Except when HDD is recording, or when there is a timer program which starts in 15 minutes.)
- If titles have been recorded on the disc, the title list is displayed. Press **[STOP ■]** to exit the title list.

2 Press **[REC MODE]** repeatedly to select a recording mode.

Refer to "Recording Mode" on page 42.

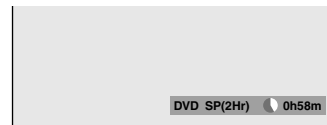

3 Select the appropriate external input channel by pressing **[SOURCE]** or **[CHANNEL +/-]**.

Press **[DTV/TV]** to select analog TV or digital TV, then use **[CHANNEL +/-]** or **[the Number buttons]** and **[.]** (for digital TV channels) to select a desired channel to record.

Refer to "Switching Analog Mode/Digital Mode" and "Channel Selection" on page 35.



4 Press [REC] to start recording.
 "● HDD" or "● DVD" will be displayed for 4 seconds.
 e.g.) DVD

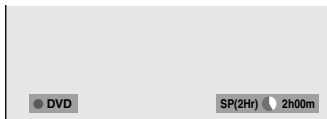

Press **[PAUSE II]** to pause recording.
 Press **[PAUSE II]** or **[REC]** again to restart recording.

To set one-touch timer recording (OTR)...

This is a simple way to set the recording time in blocks of 30 minutes.

Press **[REC]** repeatedly until the desired recording time (30 minutes to 6 hours) appears on the TV screen.

One-touch timer recording will start.

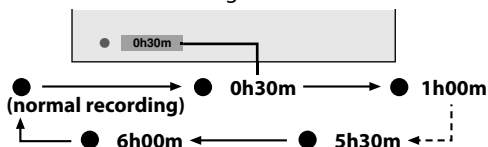

To change the recording length during the one-touch timer recording:

Press **[REC]** repeatedly until the desired length appear.

To cancel the one-touch timer recording within the specified time:

Press **[STOP ■]**.

When the recording is completed, the unit will ask you whether to turn the unit to the standby mode except under conditions listed below.

- If a timer recording is programmed to start in 5 minutes.
- During playback of HDD or DVD.
- While displaying menus or information on the screen.
- The unit will be turned to the standby mode automatically if you select "Yes" or if you do not reply in 1 minute.

Note

- When you press **[REC]**, recording starts immediately and continues until the HDD or disc is full, record 12 hours to HDD or you stop recording.
- This unit cannot record images as aspect ratio of 16:9. The 16:9 images will be recorded as 4:3.
- When the unit clock has not been set, the space for a date and time of title names will be blank.
- When you record a TV program, you have to select the TV channel audio beforehand. Only the selected channel audio will be recorded. Refer to "Selecting TV Audio" on pages 36-37 for more details.
- This unit cannot record in both stereo and SAP (secondary audio program) at the same time.
- You cannot change the recording mode during the recording pause mode.
- You can change a channel to be recorded during the recording pause mode.
- You can play back a title on one component while making a recording on other. To do so, simply select the component (HDD or DVD) you like to use for the playback by pressing **[HDD]** or **[DVD]** during HDD/DVD recording. And then follow the normal playback procedure.
- If playback and recording are in progress at the same time, select the appropriate component by pressing **[HDD]** or **[DVD]** before you press **[PAUSE II]** or **[STOP ■]** to pause or stop the operation.

Note for one-touch timer recording

- The remaining recording time will be displayed on the front panel display during one-touch timer recording. Press **[DISPLAY]** to see it on the TV screen.
- Unlike the timer recording, you can perform the following operations during one-touch timer recording.
 - Turning the power to the standby mode to stop one-touch timer recording.
 - Using **[REC]** or **[STOP ■]** on the remote control.
- You cannot use the pause function during one-touch timer recording.

5 Press [STOP ■] to stop recording.

As for DVD recording, the title list will appear automatically after writing to a disc complete.
 (Refer to "Guide to a Title List" on page 82.)
 e.g.) DVD+R

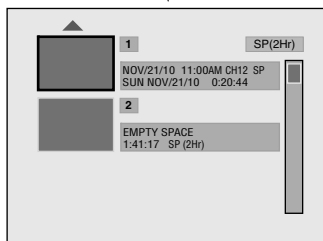
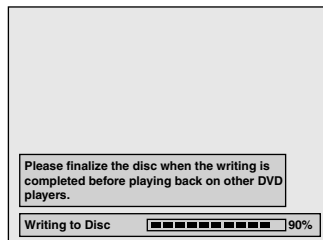

- Press **[STOP ■]** to exit the title list.

AUTOSTART RECORDING



Every time you turn on this unit, this unit automatically records the channel currently viewed and temporarily stores the recorded content to the HDD (Autostart recording). By using this function, you can pause or go back the TV program you are currently watching, and you can also start recording the whole TV program even at the middle of the TV program. The temporary recording can be made up to 6 hours of time range. If the recording exceeds 6 hours, earliest recording will be overwritten.

Recording the Contents of the Autostart Recording

For how to playback the autostart recording, refer to "Playing Back the Autostart Recording" on page 77.

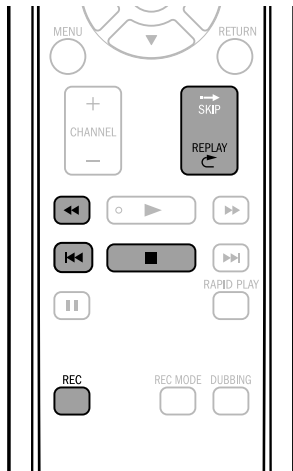

1 When watching TV program through this unit's tuner, use [◀◀], [◀◀] or [REPLAY ⏮] to locate your desired point to start recording.

- The autostart recording information will appear. Refer to page 23.

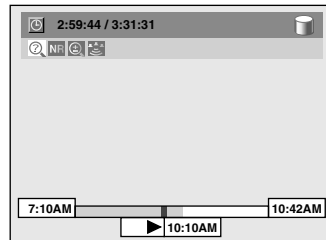

2 Press [REC] to start recording.



From the selected point, the contents of the autostart recording become a recording title in the HDD while the unit continues to record the current content of the channel.

3 Press [STOP ■] twice to stop recording.

The recording stops and new autostart recording begins.

- If you press [STOP ■] once, the image on the TV screen goes back to current content of the channel while the recording continues.

The autostart recording will be stopped, cleared in the following cases:

- Turning the power to the standby mode
- Start recording
- Editing titles or goes into editing menu
- Deleting titles (DVD only)
- Start dubbing
- Changing input channels
- Using any functions in "Disc Edit" or "HDD Menu"
- Selecting following menus:
 - "General Setting" → "Display" → "V-Chip" → "Downloadable Rating"
 - "General Setting" → "Channel" → "Auto Channel Preset"
 - "General Setting" → "Channel" → "Manual Channel Preset"
- The autostart recording will automatically resume for new recording

Note

- In the autostart recording, when you display the DTV program information, the information will be recorded as the part of the picture.
- If there is not enough recordable space on HDD to record from the selected point to current point, you cannot record the content of autostart recording.
- When you record the content of the autostart recording, the recording mode will be SP.
- When you are recording the contents of the autostart recording, if you record the part that is copy-protected, "Copy guard detected." appears and you are not able to watch the part.

TIMER RECORDING

You can program the unit to record up to 36 programs within a month in advance. Daily or weekly program recordings are also available.

Before recording, make sure

- Set the clock before setting a timer programming.
- If you are recording to a disc, insert a recordable disc with enough recordable space.

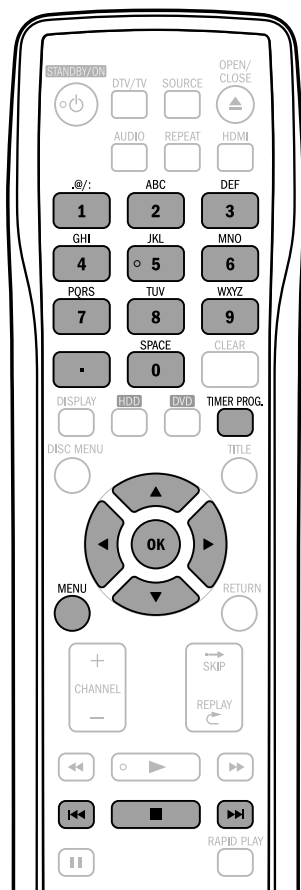

Guide to Timer Programming Display

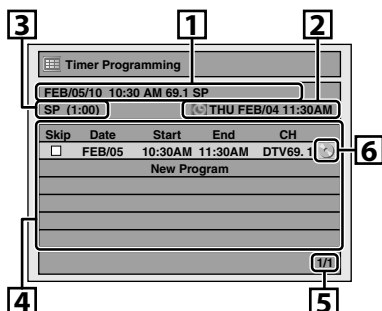

- 1 Title of a timer program (Contains date, time, channel, recording mode of the program)
- 2 Current date and time
- 3 Recording mode, and length of the recording
- 4 Timer program list
- 5 Total number of pages and current page (6 pages maximum)
- 6 Recording media ("HDD" (HDD) or "DVD" (DVD))

1 Press [TIMER PROG.].

2 Use [▲/▼] to select "New Program", then press [OK].

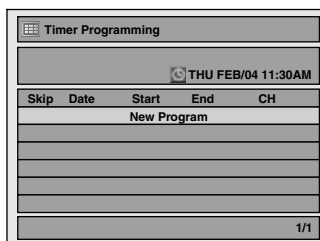

- If there are 6 or more programs, use [◀▶] to change pages.

3 Use [▲/▼] to enter the date, then press [▶].

Skip	Date	Start	End
OFF	FEB/05	--:--	--:--
CH	REC To	Mode	
DTV 69.1	HDD	SP	2h00m

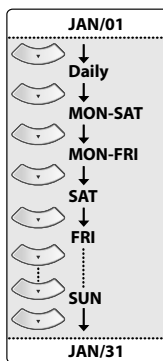

When pressing [▼] at the current date, the date will change as follows.

e.g.) January 1st

4 Use [▲/▼/▶/◀] or [the Number buttons] to enter the start and end time, then press [▶].

Skip	Date	Start	End
OFF	FEB/05	10:30AM	--:--
CH	REC To	Mode	
DTV 69.1	HDD	SP	2h00m

- You cannot make a program whose recording time exceeds 12 hours.

Instructions continue on the next page.

5 Use [▲/▼ ◀/▶] to select analog (“- - -”)/digital (“DTV”) mode or external input (L1 / L2), then press [▶].

e.g.) external input mode

Skip	Date	Start	End
OFF	FEB/05	10 : 30AM	11 : 30AM
CH	REC To	Mode	
L1	HDD	SP	1h00m

To record from external input (e.g., cable/ satellite box), select L1 or L2.

Use [▲/▼] or [the Number buttons] to select the channel number to record, then press [▶]. For digital mode, select both major and minor channels. Refer to “How to select a channel number for the timer recording” on page 49 for more details.

e.g.) analog mode

Skip	Date	Start	End
OFF	FEB/05	10 : 30AM	11 : 30AM
CH	REC To	Mode	
- - - 10	HDD	SP	1h00m

e.g.) digital mode

Skip	Date	Start	End
OFF	FEB/05	10 : 30AM	11 : 30AM
CH	REC To	Mode	
DTV 69.1	HDD	SP	1h00m

6 Use [▲/▼] to select the recording media (“HDD” or “DVD”), then press [▶].

e.g.) recording to DVD

Skip	Date	Start	End
OFF	FEB/05	10 : 30AM	11 : 30AM
CH	REC To	Mode	
DTV 69.1	DVD	SP	1h00m

7 Use [▲/▼] to select a recording mode.

Skip	Date	Start	End
OFF	FEB/05	10 : 30AM	11 : 30AM
CH	REC To	Mode	
DTV 69.1	DVD	SP	1h00m

Refer to “Recording Mode” on page 42.

- You can check the remaining recordable space of the disc when you select the recording mode.

Skip	Date	Start	End
OFF	FEB/05	10 : 30AM	11 : 30AM
CH	REC To	Mode	
DTV 69.1	DVD	SP	1h00m

Auto recording mode select...

When “Auto” is selected as a recording mode, the unit calculates how much time is available on the disc and selects the best recording mode available automatically to complete recording the program.

Skip	Date	Start	End
OFF	FEB/05	10 : 30AM	11 : 30AM
CH	REC To	Mode	
DTV 69.1	DVD	Auto	1h00m

- “Auto” is only available for one program in the timer program list.

Alternate recording (DVD only)...

In the following cases, the unit will detect it and automatically record to the HDD even when DVD is selected as the recording media.

- If there is no recordable disc in the unit
- If the disc does not have enough space to complete the recording
- If the material is “copy-once” program and prohibited to be recorded on a DVD
- If the disc is not available because the repairing process is canceled halfway

This feature is available only for timer recording. Not available for one-touch timer recording.

8 Press [OK] when all items are entered.

 will appear on the front panel display.

Timer Programming				
FEB/05/10	10:30 AM	69.01	SP	
SP (1:00)				THU FEB/04 11:30AM
Skip	Date	Start	End	CH
<input type="checkbox"/>	FEB/05	10:30AM	11:30AM	DTV69.1
New Program				
1/1				

Your program setting is now stored.

- To set another program, repeat steps 2 to 8.
- To exit, press [TIMER PROG.] or [MENU].
- When 2 or more programs are overlapped, “Timer program overlapped” appears, and the overlapped program will be displayed in blue.
- To correct the timer program refer to “Checking, canceling, or correcting the timer programming information” on page 49.

Note

If you have not set the clock yet:

- Entry screen for the clock setting will appear instead of the timer programming list at step 1. Continue with the step 5 in “Manual Clock Setting” on page 34 before setting a timer programming.
- Use [◀/▶] to move the cursor to the left and the right in the entry screen for the timer programming.
- You cannot make a program whose recording time exceeds 12 hours.

TIMER RECORDING

How to select a channel number for the timer recording

Analog TV	For channel number 2-6 press, press [▶] or [•] to decide the channels. For other channels (7-69), the channel will be decided as soon as you enter the channel number.
Analog Cable TV	For channel number 1-12 press, press [▶] or [•] to decide the channels. For other channels (13-125), the channel will be decided as soon as you enter the channel number.
Digital TV	For channel number 1-9 press, press [▶] or [•] to decide the channels. For other channels (10-99), the channel will be decided as soon as you enter the channel number.
Digital Cable TV	For channel number 1-13 press, press [▶] or [•] to decide the channels. For other channels (14-135), the channel will be decided as soon as you enter the channel number.
minor channels	For channel number 1-9 press, press [▶] or [•] to decide the channels. For other channels (10-99), the channel will be decided as soon as you enter the channel number.

<Hint>

- You can decide the 1-digit channel number by pressing 0 first, then enter desired 1-digit channel number. e.g.) "5": [0]+[5]
- For selecting the channels with [▲/▼] you need to press [▶] or [•] to decide the channel number.
- For selecting the minor channels with [▲/▼], please make sure the minor channel you are selecting exists. [▲/▼] does not skip the non-existing minor channels.

To stop the timer recording in progress

- 1) Press [STOP ■] on the remote control.
- 2) Confirmation message will appear. Select "Yes", then press [OK].
 - To stop the timer recording immediately, press [■ STOP] on the unit.

Checking, canceling, or correcting the timer programming information

- 1) Press [TIMER PROG.].
- 2) Check the information.

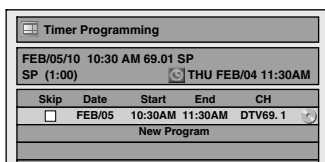

- 3-A) To delete the timer program:
 - 1 Use [▲/▼] to select the program you want to delete, then press [OK].
 - 2 Use [▲/▼] to select "Delete", then press [OK]. Confirmation window will appear.
 - 3 Use [▲/▼] to select "Yes", then press [OK].

- 3-B) To correct the timer program:
 - 1 Use [▲/▼] to select the program you want to correct, then press [OK].
 - 2 Use [▲/▼] to select "Program Change", then press [OK].
 - 3 Correct the timer program by using [▲/▼/◀/▶], then press [OK].

- 4) Press [TIMER PROG.] to exit.

Note

- Press [TIMER PROG.] to check the timer recording in progress.
- As to the timer recording in progress (which is shown in red in the timer program list), you only can edit the end time. The changes made during recording will be recognized as only specific to that recording in progress and it will not affect the daily or the weekly recording setting.

Skip the Periodical Timer Recording

You can deactivate the periodical (Daily, MON-SAT, MON-FRI or Weekly) timer recording temporarily.

- 1) In stop mode, press [TIMER PROG.].
- 2) Select the periodical timer recording program you want to skip using [▲/▼], then press [OK].
- 3) Select "Program Change" using [▲/▼], then press [OK].
- 4) Move the cursor to the "Skip" field using [◀/▶], then select "ON" using [▲/▼] and then press [OK] to activate the setting.
 - "✓" will be displayed on the left side of the timer program.
 - The setting will go back to "OFF" after the program is skipped once.

Putting Names on Timer Programs

- 1) In stop mode, press [TIMER PROG.].
- 2) Use [▲/▼] to select the program you want to edit the timer program name, then press [OK].
- 3) Use [▲/▼] to select "Edit Title Name", then press [OK].

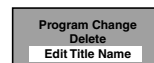

A window for entering a title name will appear.

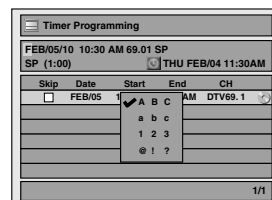

- 4) To enter a title name, follow the steps of "Guide to Edit Title Name" on page 87.
- 5) After entering a title name, press [OK].
- 6) Use [▲/▼] to select "Yes", then press [OK].
 - The program name is now updated.

TIMER RECORDING

If the timer program did not complete correctly, the error number appears in the timer programming list.

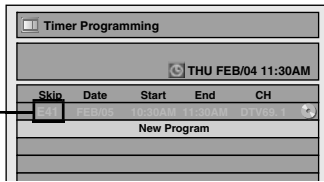

Each error number means:

E1-22 E37-39	Recording error other than below	E44	Already 254 chapters recorded
E24	Unrecordable disc	E45	Copy prohibited program
E25-26	Copy prohibited program	E46	It is impossible to record additionally on a disc recorded by other units when setting "Make Recording Compatible" to "OFF".
E29	Disc protected		
E30	Disc full		
E35	PCA full *1		
E36	Already finalized video format disc	E47	Already 600 titles recorded on the HDD
E40	Some portion has not been recorded because of program overlapping. Recording did not start at the start time.	E49	There was no disc space on the HDD at the starting time for the HDD timer recording.
E41		Power failed	
E42	No disc when recording	E50	HDD recording is canceled due to the insufficiency of the disc space on the HDD.
E43	Already 49 titles recorded		

- E23, E27, E28, E31, E32, E33 and E34 are not displayed.
- A program with the error number is grayed in the timer programming list.
- Timer program with an error number will be cleared once the entry screen for the program is displayed.

*1 PCA is a disc's space reserved for recording test.

TIMER RECORDING

Hints for Timer Recording

- If there is a power failure or this unit has been unplugged for more than 1 hour, the clock setting and all timer programming will be lost.
- When recording to a DVD, if a disc is not inserted, the unit will perform the alternate recording to the HDD (refer to page 48).
- When a timer recording is completed, the unit will ask you whether to turn the unit to the standby mode if there is no timer recording which starts within 5 minutes, except under conditions listed below.
 - During playback of HDD or DVD.
 - While displaying menus or information on the screen.
- The unit will be turned to the standby mode automatically if you select "Yes" or if you do not reply in 1 minute.
- When the programmed starting and ending time are earlier than the current time, the setting will not be accepted and be cleared for redoing.
- If the starting time is earlier and the ending time is later than the current time, the recording will start right after you press **[OK]** at step 8 on page 48.
- You cannot change the audio language for the timer recording of digital TV broadcasting.
- Timer recording whose recording time exceeds 12 hours cannot be made.
- It is prohibited to turn the unit to the standby mode from 4 minutes before the programmed starting time.
- It is prohibited to change channel from 15 seconds before the programmed starting time.
- **[REC]** does not work from 2 minutes before the programmed starting time. If it comes to 2 minutes before the starting time during regular or one-touch timer recording, the recording in progress will be stopped.
- Playback of DVD/CD is prohibited from 2 minutes before the programmed starting time when the recording media is DVD. If it comes to 2 minutes before the programmed starting time during DVD playback, the playback will be stopped.

The Priority of Overlapped Settings

- Timer program which has the earlier start time will be placed first in the timer program list, and be given priority over the programs with the later start time when timer programs overlap.
- When timer programs overlap, the first 2 minutes (at the longest) of the later recording will be cut off.
- When 2 or more timer programs have the same start time, the program set first will be given priority.
- A timer recording of lower priority will be canceled or start from the middle.
- Check the overlapped timer programmings and change the priority if necessary.

■ When the starting time is the same:

A program set previously (PROG. A) has priority.

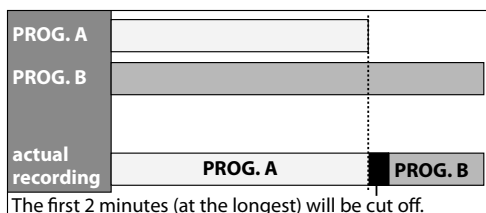

Note for DVD recording

- When the recording time of 2 programs are overlapped, or the end time of a program and the start time of another program is the same, the first 2 minutes (at the longest) of the subsequent program will be cut off.
- If the cut-off portion comes up to 3 minute or more, this program will be displayed with error number E40 in the timer programming list.

■ When the end time of the programming currently being recorded and the start time of the subsequent program are same:

The beginning of the PROG. B may be cut off.

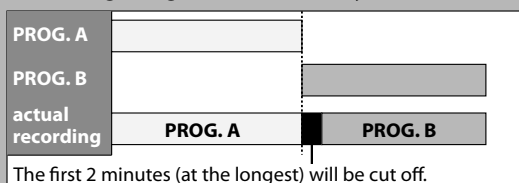

SPECIAL RECORDING

Overwriting from the Beginning of the Title



You can overwrite the existing title from the beginning.

1) Press [STANDBY/ON ○].

Make sure that the TV input is set on the unit.

2) Load the disc that includes a title to be overwritten.

It takes a while to display the title list.

Title list will appear.

If the title list does not appear, press [TITLE].

3) Press [REC MODE] repeatedly to select a recording mode.

Refer to "Recording Mode" on page 42.

4) Use [▲/▼] to select a title to be overwritten, then press [OK].

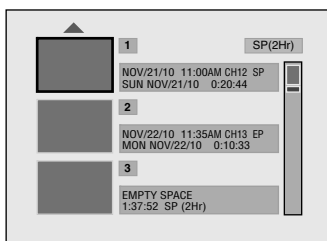

5) Use [▲/▼] to select "Overwrite", then press [OK].

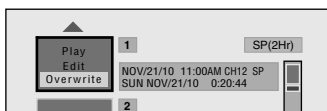

6) Select the channel you want to record.

(Refer to page 35 on how to select a channel.)

e.g.) DVD+RW

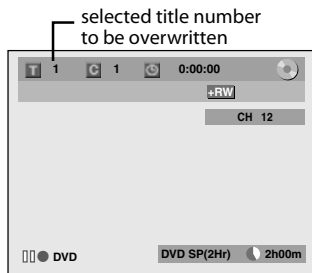

7) Press [REC].

Overwriting recording starts.

The elapsed-time counter starts running.

8) Press [STOP ■] to stop recording.

Title name is also overwritten.

This operation may take a while to be completed.

Note

- The remaining recording time is displayed on the bottom right corner of the TV screen during overwriting.

Overwriting in the Middle of the Title



You can overwrite the existing title from the selected position.

1) Follow the steps 1, 2 and 4 on the left.

2) Use [▲/▼] to select "Play", then press [OK].

Playback will start.

3) Press [PAUSE ■] at the point from which you want to start overwriting.

4) Press [REC].

"11 ● DVD", display menu, channel, and the time lapse will be displayed as illustrated on the left.

5) Select the channel you want to record.

(Refer to page 35 on how to select a channel.)

6) Press [REC] again.

Overwriting recording starts.

7) Press [STOP ■] to stop recording.

This operation may take a while to be completed.

Note

- Recording mode of the overwriting title is the same as that of the original (overwritten) title when overwriting in the middle of the title.
- Title name will not be overwritten.

SPECIAL RECORDING

Hints for Overwriting

When you overwrite on the unnecessary title, there were various circumstances such as follows. Please note that following cases only describe the overwriting without any recording mode discrepancy. To avoid accidental deletion please check if there is no important title after the overwriting point.

When overwriting title is shorter than the existing title:

(overwriting from the beginning of the title)

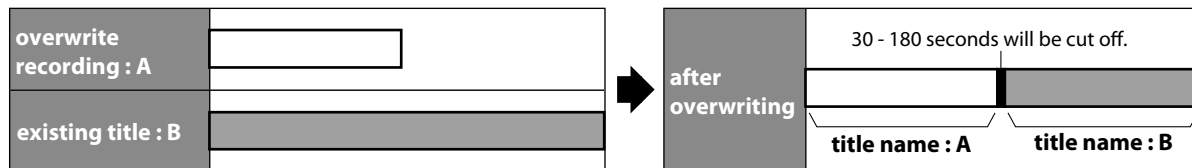

When overwriting title is longer than the existing title:

(overwriting from the beginning of the title)

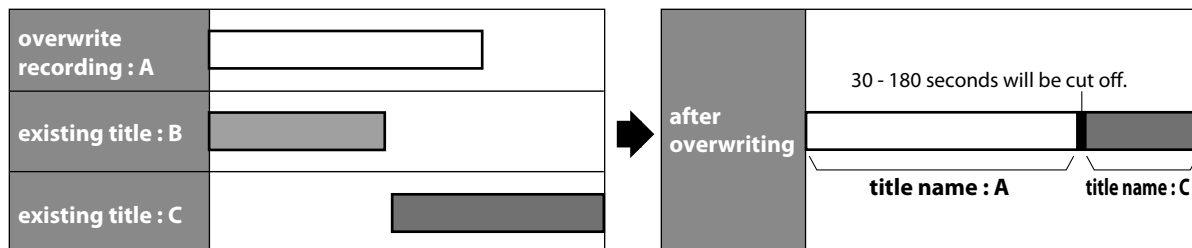
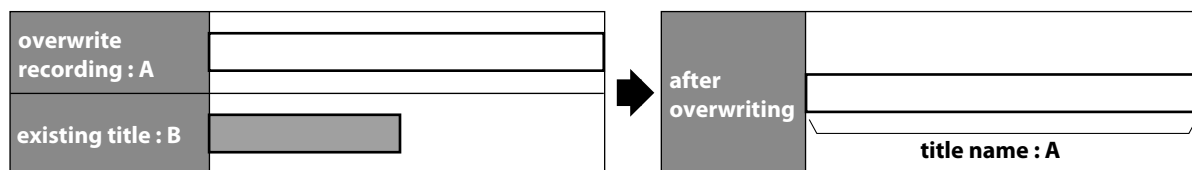

When overwriting in the middle of the title:

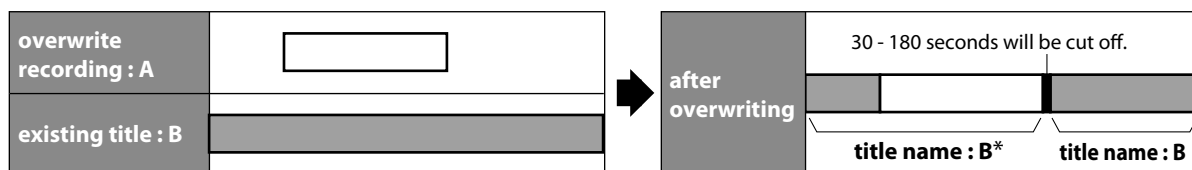

*Overwritten section and the rest of the sections will have the same title name as the original existing title (B).

Note

- When a title name is overwritten, its index picture is also overwritten.
- "Auto Chapter" interval time is reset at the overwriting start point.
- A chapter mark is put at the beginning of the overwrite title when overwriting in the middle of the title.

DUBBING

Information on Dubbing

You can dub the contents of the HDD to DVD or vice versa. Before you start dubbing, refer to pages 41-43 to see the recording compatibility.

Guide to Dubbing Menu Display

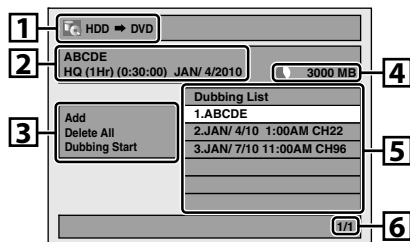

- 1 Dubbing direction
- 2 Selected title information
- 3 Dubbing menu
- 4 Remaining recordable space
- 5 Dubbing list
- 6 Current page number/total number of pages

Recording Mode for Dubbing

“High”

This unit is compatible with the high speed dubbing from HDD to DVD.

If you dub a title recorded in SLP mode to DVD+R/-R, dubbing speed will be 24 times at the maximum. To perform the high speed dubbing, set the recording mode to “High”. Dubbing speed will vary depending on original recording mode.

- Duration of high speed dubbing will vary depending on the recording mode or the title amount.
- High speed dubbing is not available when;
 - recording mode is set to other than “High”.
 - dubbing from a DVD to the HDD.
 - there is not enough space in the disc.
- During dubbing (except for high speed dubbing), you can use **[STOP]** on the front panel or press **[STOP]** for 2 seconds on the remote control, and any other buttons will be invalid.

“Auto”

When “Auto” is selected as a recording mode, the unit calculates how much time is available on the disc and selects the best recording mode available automatically.

- The recording may be cut short when the available recording space of the disc is too limited.

Note on dubbing

- During normal dubbing, you can watch the playback picture of the title being dubbed (the audio cannot be changed). During high speed dubbing, however, the playback picture will not appear.
- Dubbing of a “copy-once only” program is not possible with this unit.
- If you stop the dubbing halfway, the contents will be dubbed up to the point where you stop the dubbing (except for the high speed dubbing). With high speed dubbing, nothing will be dubbed if you stop it halfway.
- To stop the dubbing in progress, press **[STOP]** on the front panel or press **[STOP]** for 2 seconds on the remote control.

Other modes

Refer to page 42 for the information on other modes.

Setting for an External Device

Connect the external device properly to the unit by using either L2 and L3 (Front) or L1 (Rear) input jacks. When connecting an external device of monaural output to this unit, use AUDIO L jack of L2 (Front) or L1 (Rear). Use S-video or the RCA audio/video cables for this connection. When connecting a DVC (digital video camcorder), use DV-IN jack of L3 (Front).

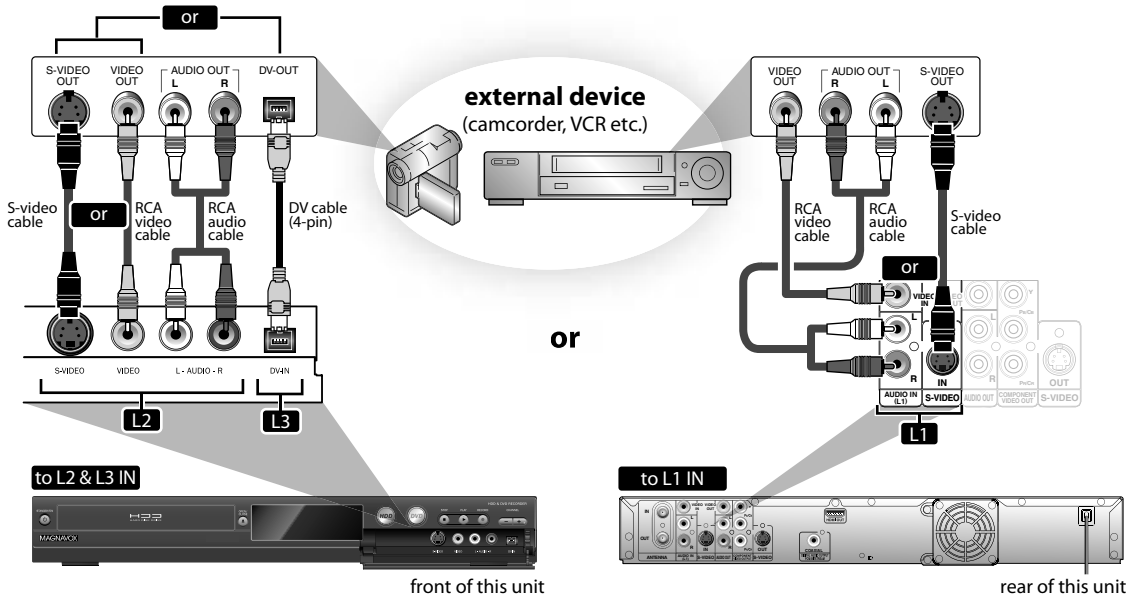

Supplied cables used in this connection are as follows:

- RCA audio cable (L/R) x 1
- RCA video cable x 1

Please purchase the rest of the necessary cables at your local store.

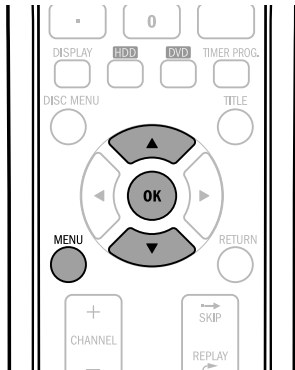

1 Press [MENU] and use [▲/▼] to select "General Setting", then press [OK]. "General Setting" menu will appear.

2 Use [▲/▼] to select "Video", then press [OK]. Submenu will appear.

3 Use [▲/▼] to select "Video Input", then press [OK].

4 Use [▲/▼] to select desired external input, then press [OK].

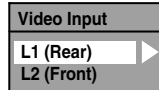

5 Use [▲/▼] to select the input jack type to connect, then press [OK]. If you want to use VIDEO IN jack, select "Video In". If you want to use S-VIDEO IN jack, select "S-Video In".

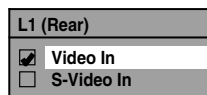

6 Press [MENU] to exit.

Recording from an External Device

Before recording from an external device, refer to the instructions for the connection on page 55.

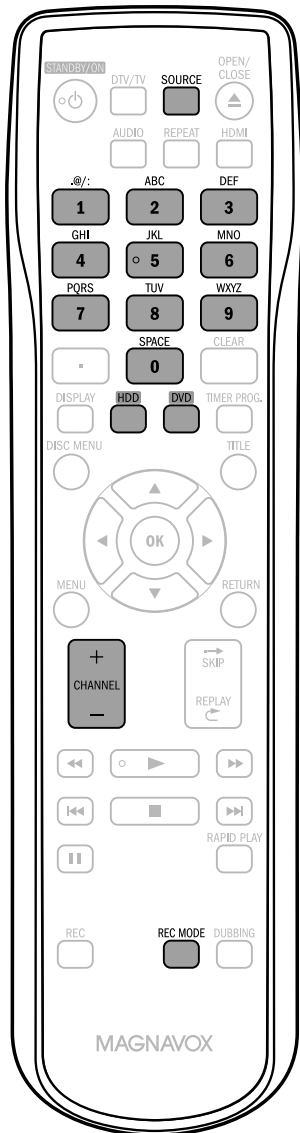

If you are recording to the HDD, press **[HDD]** first, then proceed to step 2.

If you are recording to a disc, press **[DVD]** first.

1 Insert a recordable disc (refer to page 27 on how to insert a disc).

It may take a while to load the disc data after the disc tray closes.

2 Select the appropriate external input channel (L1, L2 or L3) by pressing **[SOURCE]** or **[CHANNEL +/-]**.

- If the external device is connected to the rear of this unit, select L1.
- If the external device is connected to the front of this unit, select L2 or L3.
- If you are connecting the digital video camcorder to the DV-IN jack of this unit, refer to pages 57-59.
- You can also select L1 or L2 channel by using **[the Number buttons]**. e.g.) For L1, press **[0]**, **[0]**, **[1]**.

3 Press **[REC MODE]** repeatedly to select a recording mode.

Refer to "Recording Mode" on page 42.

4 Press **[RECORD]** on the unit to start recording.

5 Start playback on the external device to record from.

6 Press **[STOP]** on the unit to stop recording.

This operation may take a while to be completed.

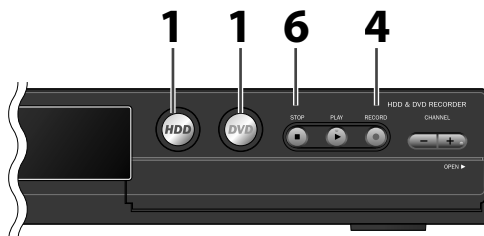

Information on DV Dubbing

Guide to DV and On-Screen Display

This function helps you to easily dub the contents of the DVC (digital video camcorder) to HDD or DVD.

You can control basic operations of the DVC from the remote control of this unit such as playback, fast forward or reverse and stop all operations if the DVC is in video mode. Use the DV cable that has 4-pin input jack and is compliance with the IEEE1394 standards. When you connect to DV-IN jack on the front of this unit, select "L3(DV-IN)" position by using [SOURCE] or [CHANNEL +/-] on the remote control and press [DISPLAY] to show the DV dubbing information for the operation of your DVC.

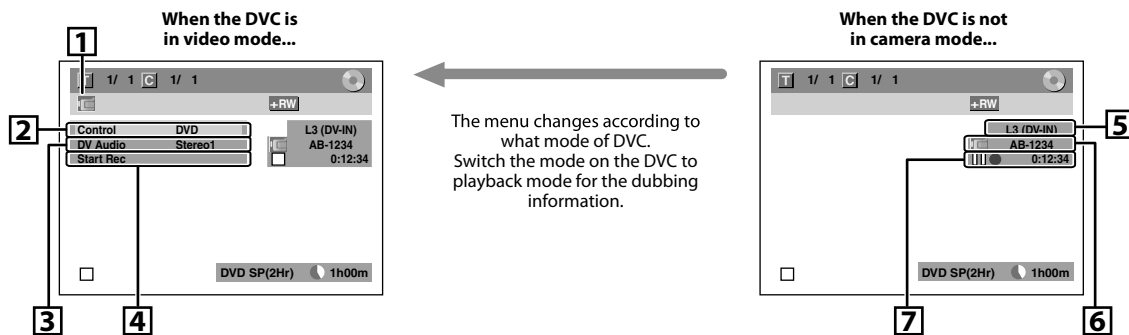

The following instructions are described with the operations using the remote control of this unit.

1. DV icon

2. Indicator of active device

- When "Control" is highlighted, press [OK] to display the item selection. Use [▲/▼] to select the device you wish to operate, then press [OK] to activate.
- Select "HDD"/"DVD" to control this unit.
- Select "DV Input" to control your DVC.

3. Recording audio mode

- With DVC in stop mode while other sources are available, then "DV Audio" can be selected. Press [OK] to display the item selection and then use [▲/▼] to select the audio you wish to output. Press [OK] again to activate.
- Select "Stereo1" to dub the stereo sound.
- Select "Stereo2" to dub the sound with after recording sound.
- Select "Mix" to dub the stereo1 and stereo2.

4. Indicator of dubbing function

- When the unit is ready for dubbing, "Start Rec" will appear.
- When the unit is dubbing, "Pause Rec" will appear.

5. Channel position

- When you select "L3(DV-IN)" by using [SOURCE] or [CHANNEL +/-], "L3(DV-IN)" will appear.

6. Product name of your DVC

- If the unit cannot recognize the input signal from the DVC or the unknown product, "No Device" or "*****" will appear instead.

7. Status of the current operation and the time counter

Each icon means (Available icons may vary depending on the DVC):

- | | | | |
|--------------------------|---|-----|--|
| <input type="checkbox"/> | DVC is in stop mode. | ⏩ | DVC is fast forwarding. (in stop mode) |
| ▶ | DVC is in playback mode. | ⏪ | DVC is fast reversing. (in stop mode) |
| ⏸ | DVC is in pause mode. | ⏮ | DVC is fast reversing. (standard speed) |
| ▶▶ | DVC is fast forwarding. (standard speed) | ⏭ | DVC is fast reversing. (faster than above) |
| ▶▶▶ | DVC is fast forwarding. (faster than above) | ⏭⏭ | DVC is fast reversing. (faster than above) |
| ▶▶▶▶ | DVC is fast forwarding. (faster than above) | ⏭⏭⏭ | DVC is in slow reverse playback. |
| ▶▶▶▶▶ | DVC is slow forwarding. (standard speed) | ● | DVC is recording. |
| ▶▶▶▶▶▶ | DVC is slow forwarding. (faster than above) | ⏸● | DVC is in recording pause mode. |
| ▶▶▶▶▶▶▶ | DVC is slow forwarding. (faster than above) | | |

DVC to HDD / DVD Dubbing

Before recording from DVC, see page 55 for connection instructions.

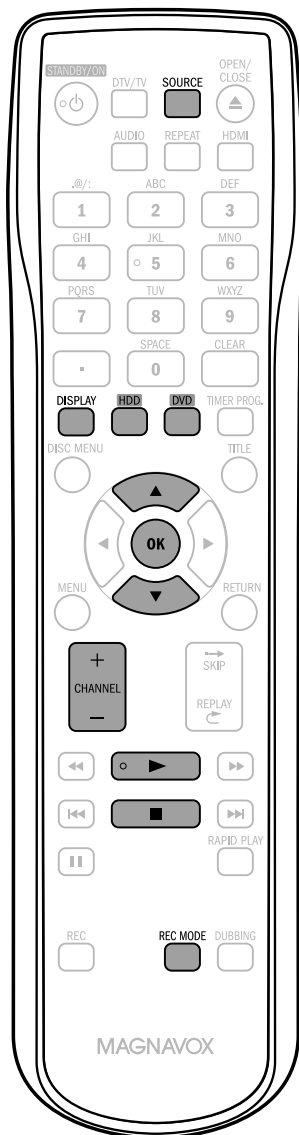

Preparing for DV dubbing (DVC to HDD):

- Make sure your DVC is in video mode.

Preparing for DV dubbing (DVC to DVD):

- Insert a recordable DVD.
- Make sure your DVC is in video mode.

If you are recording to the HDD, press **[HDD]** first.

If you are recording to a disc, press **[DVD]** first.

1 Use **[SOURCE]** or **[CHANNEL +/-]** to select "L3(DV-IN)".

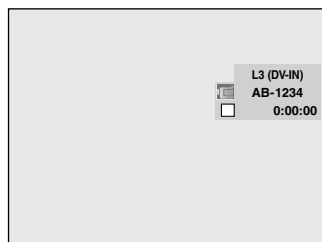

2 Press **[REC MODE]** repeatedly to select a recording mode. (Refer to page 42.)

3 Press **[DISPLAY]**.

4 Press **[OK]** to display the item selection. Use **[▲/▼]** to select "DV Input", then press **[OK]**.

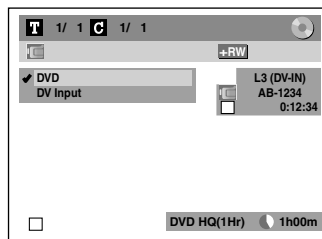

5 Press **[PLAY ▶]** to find where you wish to start dubbing. Then, press **[STOP ■]** where you wish to start dubbing.

6 Use [▲/▼] to select "Start Rec", then press [OK].
The dubbing will start.

7 To stop dubbing;
A) Press [■STOP] on the unit. or
B) Use [▲/▼] to select "Control", then press [OK].
Use [▲/▼] to select "HDD" / "DVD", then press [OK].
Then press [STOP ■].

Note for DV dubbing

- If you press [PAUSE ■■] at step 5, the tape will rewind to the point a few seconds preceding the paused point. When you press [OK] at step 6, then, it will start dubbing when it comes to the paused point.
- The unit does not send out the output signal to DVC.
- For the proper operation, connect DVC to the unit directly. Do not connect this unit and DVC via any other unit.
- Do not connect more than 1 DVC.
- The unit can only accept DVC. Other DV device such as cable/satellite box or D-VHS VCR cannot be recognized.
- If no video signal is detected from the DVC during DVC to HDD or DVD dubbing, the recording will be paused and "●" will flash on the TV screen. The recording will resume when the unit detects the video signal again.
- When the DVC is in camera mode, refer to "Guide to DV and On-Screen Display" on page 57.
- Date/time and cassette memory data will not be recorded.
- Pictures with a copy-guard signal cannot be recorded.
- A DV terminal is a terminal that can use the transmission mode conforming to the IEEE 1394 standards called "Fire Wire". It serves as the interface that connects the PC and peripheral device such as "i.LINK" (registered trademark of SONY). It enables digital dubbing between DV devices with little degradation.
- You cannot dub from DVC to both HDD and DVD at the same time.

Selected Title Dubbing

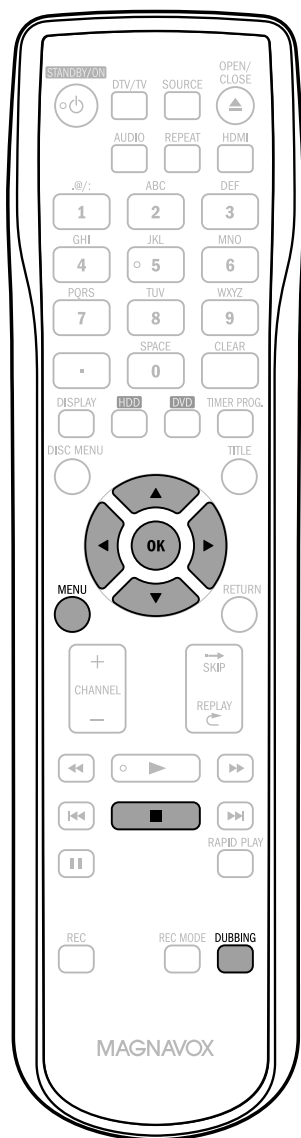
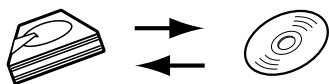

Preparing for dubbing (HDD to DVD):

- Insert a recordable DVD.

Preparing for dubbing (DVD to HDD):

- Insert a disc to be dubbed.

1 Press [MENU] in stop mode.

2 Use [▲/▼] to select “Dubbing”, then press [OK].

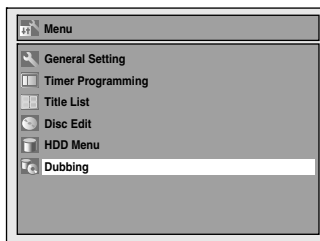

3 **HDD to DVD**
Use [▲/▼] to select “HDD → DVD”, then press [OK].

DVD to HDD

Use [▲/▼] to select “DVD → HDD”, then press [OK].

e.g.) HDD → DVD

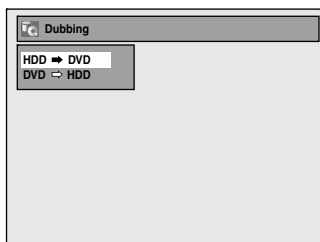

4 Use [▲/▼] to select “Add”, then press [OK].

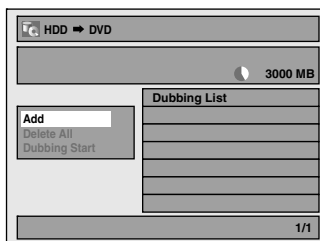

- If you have registered any dubbing before, they will be listed in the dubbing list.

5 Use [▲/▼/◀/▶] to select a desired title, then press [OK].

At the upper left of each title, the number will appear in the order of selection .

6 Repeat step 5 until you register all the titles to be dubbed, then press [DUBBING].

e.g.) HDD

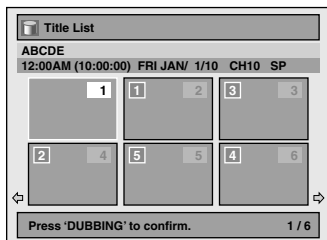

The titles are now registered in the dubbing list. When you go back to the title list to add another title, titles already registered are shown with a check mark.

To delete a title:

- 1 Go to the dubbing list, then use [▲/▼] to select a title. Then press [OK].
- 2 Use [▲/▼] to select "Delete", then press [OK].
- 3 Use [▲/▼] to select "Yes", then press [OK].

To move a title:

- 1 Go to the dubbing list, then use [▲/▼] to select a title. Then press [OK].
- 2 Use [▲/▼] to select "Move", then press [OK].
- 3 Use [▲/▼] to select a desired insert point, then press [OK].

To erase all the titles in the dubbing title list:

- 1 Use [▲/▼] to select "Delete All" in the dubbing menu, then press [OK].
- 2 Use [▲/▼] to select "Yes", then press [OK].

- To go back and forth between dubbing menu and dubbing list, use [◀/▶].

7 After adding all the titles you want, use [▲/▼] to select "Dubbing Start" in the dubbing menu, then press [OK].

8 Use [◀/▶] to select a desired recording mode, then press [OK].

e.g.) HDD → DVD

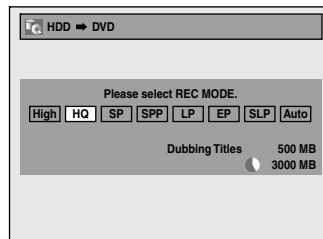

Confirmation message will appear.

- Depending on the dubbing direction, the available recording mode varies.
- When dubbing from HDD to DVD, you can select "High" to perform the high speed dubbing (refer to "Recording Mode for Dubbing" on page 54 for more details).

9 Use [▲/▼] to select "Yes", then press [OK].

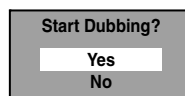

Dubbing will start.

- It may take awhile to prepare for the dubbing.

To stop the dubbing in progress:

Press [■STOP] on the front panel.

Press [STOP ■] for 2 seconds on the remote control.

When you are dubbing from HDD to DVD, the confirmation message will appear, then select "Yes".

One-touch Dubbing...

With one-touch dubbing, you can start dubbing right away with just one touch.

To dub the contents in a DVD which is finalized on other unit, use this function.

During playback of the title you want to dub, press [DUBBING].

If you are playing back a DVD, DVD to HDD dubbing will start right away.

If you are playing back HDD, HDD to DVD dubbing will start right away.

- The dubbing will start from the beginning of the title being played back.
- The unit will dub only the title being played back.
- When dubbing from HDD to DVD, recording mode will automatically be set to "High" whenever the conditions are met (refer to page 54). Otherwise, the last selected recording mode will automatically be applied.

To stop the dubbing in progress:

Press [■STOP] on the front panel.

Press [STOP ■] for 2 seconds on the remote control.

When you are dubbing from HDD to DVD, the confirmation message will appear, then select "Yes".

DUBBING

One Title Dubbing (HDD to DVD only)

This function lets you select one specific title from the title list for dubbing.

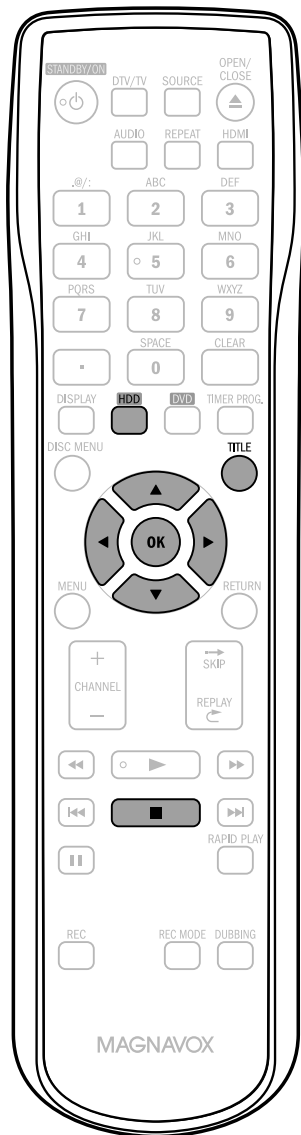
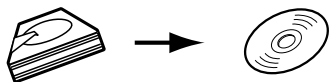

Preparing for dubbing:
• Insert a recordable DVD.

**Press [HDD] first.
Press [TITLE].**

1

2 Use [▲/▼/◀/▶] to select a desired title to dub, then press [OK].

3

Use [▲/▼] to select "Dubbing", then press [OK].

```
Resume Playback
Play From Start
Edit
Title Delete
Delete Multiple Titles
Dubbing
```

4

Use [▲/▼] to select "Yes", then press [OK].

Start Dubbing?

Yes
No

Dubbing of the selected title will start.

To stop the dubbing in progress:

Press [■STOP] on the front panel.

Press [STOP ■] for 2 seconds on the remote control.

PROTECTING A DISC



To prevent accidental recording, editing or erasing of the titles, you can protect them from the "Disc Edit" menu.

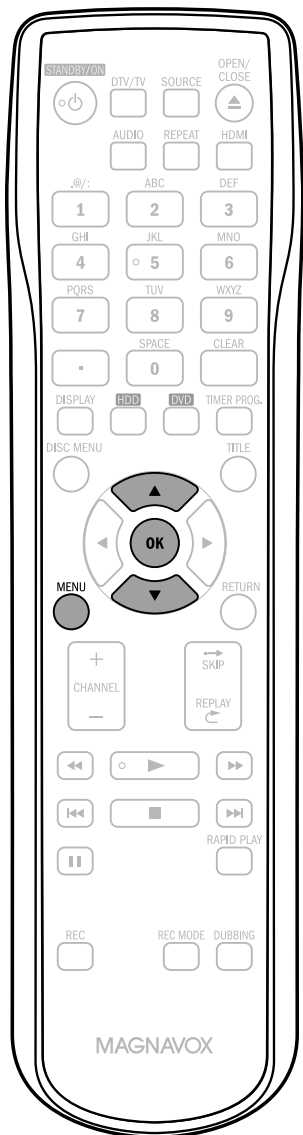

- 1** Press [MENU].
- 2** Use [▲/▼] to select "Disc Edit", then press [OK].
- 3** Use [▲/▼] to select "Disc Protect OFF → ON", then press [OK].
e.g.) DVD+RW
- 4** Use [▲/▼] to select "Yes", then press [OK].

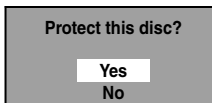
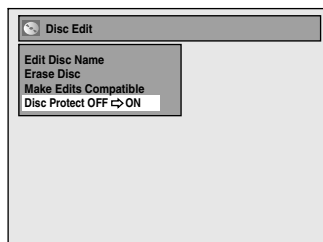

The disc is now protected.

This operation may take a while to be completed.

Note

To cancel the disc protection:

- When you insert a disc protected with this unit, "Disc Protect ON → OFF" will appear instead of "OFF → ON" at step 3.



To release the protection for the disc, select "Disc Protect ON → OFF" at step 3, then follow rest of the procedures.

PLAYING THE DISCS ON OTHER DVD PLAYERS

Finalizing a Disc



You will need to finalize DVD+R, DVD-RW or DVD-R to play them back on other DVD players.

Finalizing may take several minutes up to an hour.

A shorter recording period on the disc will require a longer time period for finalization. Do not unplug the power cord during finalization.

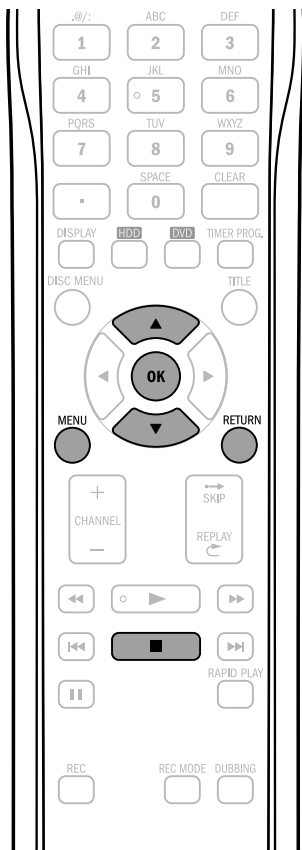

- 1** Press [MENU].
- 2** Use [▲/▼] to select "Disc Edit", then press [OK].
"Disc Edit" menu will appear.
- 3** Use [▲/▼] to select "Finalize", then press [OK].
- 4** Use [▲/▼] to select "Yes", then press [OK].

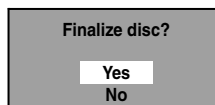

Finalizing will start.



To cancel finalizing... (DVD-RW only)

- To cancel finalizing at step 4, press [STOP ■], select "Yes" with [▲/▼], then press [OK]. Finalizing is canceled and the unit will be in stop mode.

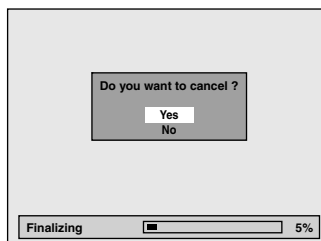

- If appears when pressing [STOP ■], you cannot cancel finalizing because the finalizing has been in certain progress.
- When selecting "No" and pressing [OK] or [RETURN], finalizing will be continued.
- You cannot cancel finalizing a DVD+R/DVD-R disc once it has started.

This operation may take a while to be completed.

Note

- Once you started finalization, no controls are available. You cannot cancel or stop the finalizing mode. Please wait until it finishes the finalization process.
- There is no need to finalize DVD+RW.
- When you insert a DVD-RW finalized with this unit, "Undo Finalize" will appear instead of "Finalize".

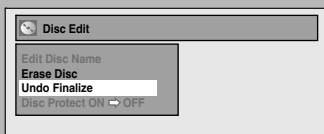

To release the finalizing for the disc, select "Undo Finalize" at step 3.

* DO NOT turn the power off or place unit in standby mode during finalization, this will result in a malfunction.

- 5** Finalizing is completed.

PLAYING THE DISCS ON OTHER DVD PLAYERS

Auto Finalizing



You can finalize discs automatically using this function. You can use this function to finalize discs after finishing timer recordings and at the end of the disc space.

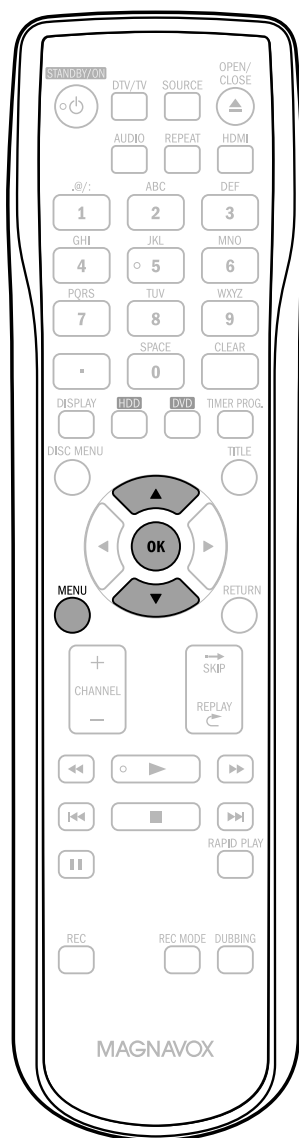

1 Press [MENU] and use [▲/▼] to select "General Setting", then press [OK].
"General Setting" menu will appear.

2 Use [▲/▼] to select "Recording", then press [OK].
"Recording" menu will appear.

3 Use [▲/▼] to select "Auto Finalize", then press [OK].

4 Use [▲/▼] to select "Disc Full" or "End of Timer Rec", then press [OK].

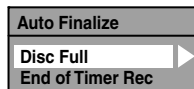

5 Use [▲/▼] to select "ON", then press [OK].
e.g.) "Disc Full"

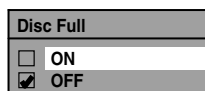

Your setting will be activated.

6 Press [MENU] to exit.

Note







- This function is not available after finishing daily or weekly program recording.

INFORMATION ON PLAYBACK

Before you play back a DVD, read the following information.

Playable Discs and Files

This unit is compatible to play back the following discs. To play back a DVD, make sure that it meets the requirements for region codes and color systems as described below. You can play back discs that have the following logos. Other disc types are not guaranteed to play back.

Playable discs	Logos
DVD-video	
DVD+RW	
DVD+R	
DVD-RW (Finalized video mode discs only)	
DVD-R (Finalized video mode discs only)	
CD-DA (audio CD)	
video CD	 
CD-RW	 
CD-R	 
KODAK Picture CD	

Playable files	Media
MP3	CD-RW/-R
JPEG	

 is a trademark of DVD Format/Logo Licensing Corporation.

Unplayable Discs

The following discs will not play back on this unit.

- CD-ROM
- DVD-RAM
- DVD-ROM
- Unfinalized disc
- DVD or CD contains Windows Media™ Audio/DivX® files
- DVD-R or DVD-RW recorded in VR mode or non-compatible recording format
- Blu-ray Disc
- Super Video CD
- Compact Disc-Interactive (CD-I)
- Video Single Disc (VSD)
- DVD-audio
- HD DVD

On the following disc, the sound may not be heard.

- Super Audio CD - Only the sound on the CD layer can be heard. The sound on the high-density super audio CD layer cannot be heard.

Color Systems

DVD is recorded in different color systems throughout the world. The most common color system is NTSC (which is used primarily in the United States and Canada). This unit uses NTSC, so a DVD you play back must be recorded in the NTSC system. You cannot play back a DVD recorded in other color systems.

Region Codes

This unit has been designed to play back a DVD with region 1. A DVD must be labeled for ALL regions or for region 1 in order to play back on the unit. You cannot play back DVDs that are labeled for other regions. Look for the symbols on the right on your DVD. If these region symbols do not appear on your DVD, you cannot play back the DVD in this unit.



The number inside the globe refers to region of the world.

A DVD labeled for a specific region can only play back on the unit with the same region code.

PBC (playback control) for Video CD

You can select images or information on the menu screen by activating the PBC (playback control) function of the video CD.

This unit conforms to ver.1.1 and ver. 2.0 of video CD standard with PBC function.

Ver.1.1 (without PBC function): You can enjoy playback picture as well as music CD.

Ver.2.0 (with PBC function): While using a video CD with PBC function, "PBC" appears on the TV screen.

Note

- PBC setting turns to "ON" when loading video CD with PBC function, thus, even after setting PBC to "OFF" and ejecting the video CD then reloading the video CD, this setting turns to "ON" automatically.
- Some operations cannot be performed while PBC function is on. Cancel PBC function temporarily to perform those operations by following the instruction below.

- 1) Press [MENU].
- 2) Use [▲/▼] to select "DISC Playback Mode", then press [OK].
"DISC Playback Mode" menu will appear.
- 3) Use [▲/▼] to select "PBC (Video CD only)", then press [OK].
- 4) Use [▲/▼] to select "ON" or "OFF", then press [OK].
Your setting will be activated.

You can play back interactive software using menu screens. Refer to instructions in the video CD.

Hint for HDD / DVD Playback

The contents of HDD / DVD are generally divided into titles. Titles may be further subdivided into chapters.

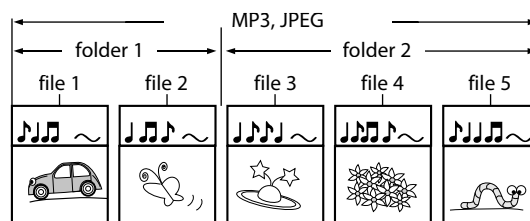
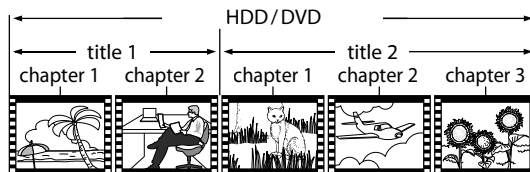

BASIC PLAYBACK

Direct Playback



If you are playing back the titles in HDD, press **[HDD]** first, then proceed to step 2.
If you are playing back the titles in DVD, press **[DVD]** first.

1 Insert a disc (refer to page 27 on how to insert a disc).

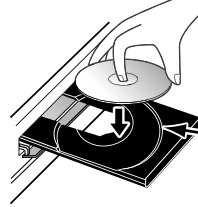

Align the disc to the disc tray guide.

* Make sure the disc is compatible with this unit.
(Refer to page 66 for the list of compatible discs.)

It may take a while to load the disc data after the disc tray closes.

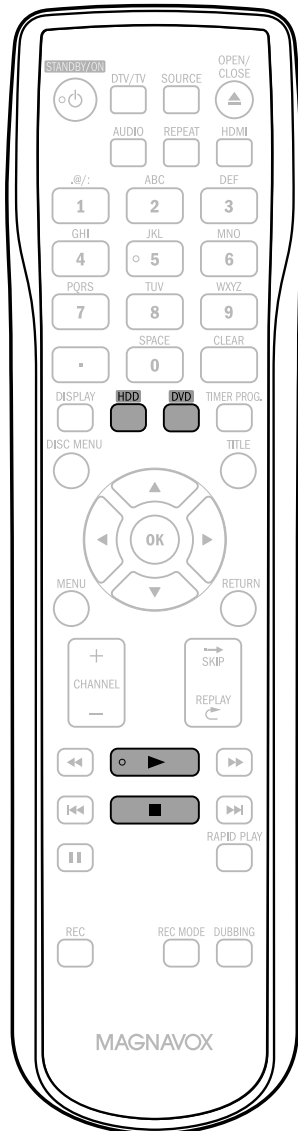

2 Press **[PLAY ►]** to start playback.

If you are playing back a DVD-video or video CD with PBC function, a menu may appear.
Refer to "Using the Title/Disc Menu" on page 72.

3 Press **[STOP ■]** once to stop playback temporarily.

• Refer to "Resume Playback" on page 73.

Note

- Some discs may start playback automatically.
- You can select images or information on the menu screen by activating PBC (playback control) function (page 67).
- If you insert a disc when the unit is in HDD mode, playback will start automatically when you press **[DVD]**.

BASIC PLAYBACK

Playback from the Title List



If you are playing back the titles in HDD, press [HDD] first, then proceed to step 2.

If you are playing back the titles in DVD, press [DVD] first.

1 Insert a disc (refer to page 27 on how to insert a disc).

* Make sure the disc is compatible with this unit. (Refer to page 66 for the list of compatible discs.)

It may take a while to load the disc data after the disc tray closes.

2 For HDD, press [TITLE] to call up the title list. For DVD, the title list will automatically appear when you insert a disc. Otherwise, press [TITLE] or [DISC MENU].

- To exit the title list, press [STOP ■].
- To resume the title list, press [TITLE].

3 Use [▲/▼/◀/▶] to select a desired title, then press [OK].

<HDD title list>

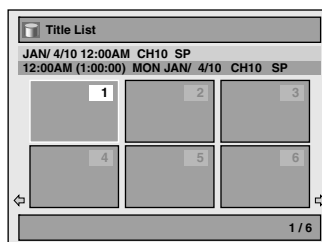

<DVD title list>

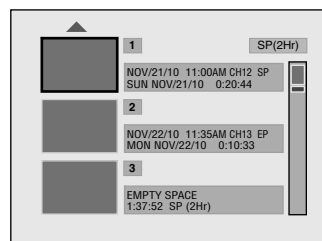

- For video CD, when "PBC (Video CD only)" in the "DISC playback Mode" menu is set to "ON", the video CD main menu will appear when inserting a disc. In such case, select a numbered menu with [the Number buttons].
- Press [▶▶] (for HDD) / [▶] (for DVD) to display the next page, and press [◀◀] (for HDD) / [◀] (for DVD) to display the previous page.

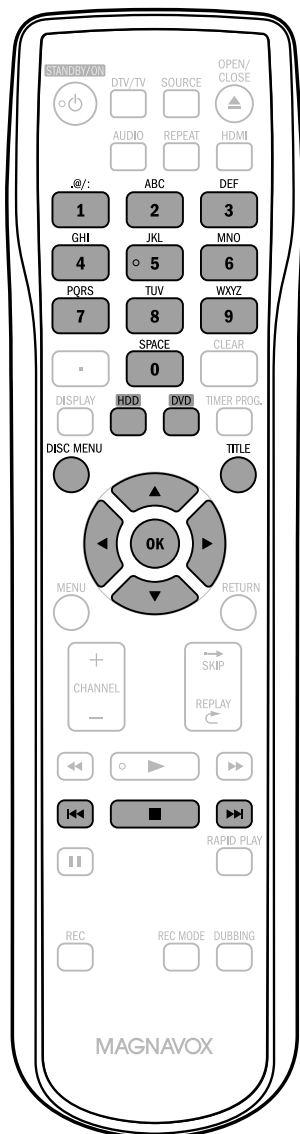

Note

- Some discs may start playback automatically.
- You can also start playback by pressing [PLAY ▶] instead of [OK] at step 3.

Instructions continue on the next page.

Note for DVD title list

If you want to see disc information, press [◀] when the first page of the title list is displayed or press [▲] when the first title is selected but not when "Play", "Edit" or "Overwrite" is highlighted.

e.g.) DVD+RW

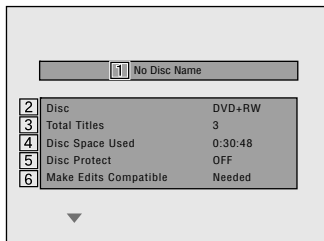

e.g.) DVD+R

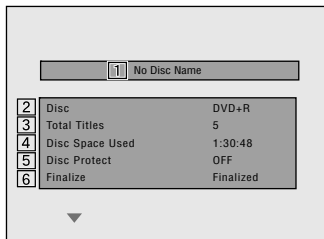

1. Disc name
(Default "No Disc Name")
2. Disc type
(DVD+RW/DVD+R/ DVD-RW/DVD-R)
3. Total number of title
(include "EMPTY SPACE")
4. Total time of recorded disc space
5. Status of disc protection
(“ON” is protected disc.)
6. Making edits compatible/finalize
 - When DVD+RW is inserted:
If the disc needs to be set "Make Edits Compatible", "Needed" is displayed. Otherwise, "Not Needed" is displayed. (Refer to page 99.)
 - When DVD+R, DVD-RW or DVD-R is inserted:
If "Finalize" is done, "Finalized" is displayed. Otherwise, "Unfinalized" is displayed.

- ## 4
- Use [▲/▼] to select "Play" (for DVD), or select "Resume Playback" or "Play from Start" (for HDD), then press [OK].
e.g.) DVD



Playback will start.

- ## 5
- Press [STOP ■] once to stop playback temporarily.
- Refer to "Resume Playback" on page 73.

BASIC PLAYBACK

Playing Back an Audio CD and CD-RW/-R with MP3 / JPEG Files

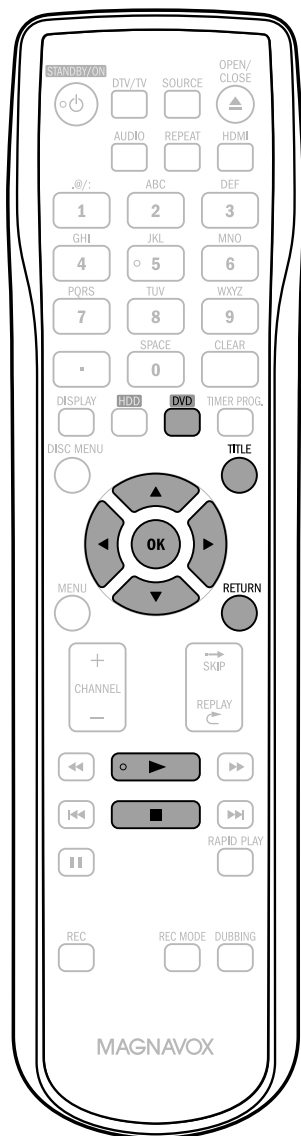

Note

- The audio source of MP3 files cannot be recorded as digital sound by an MD or DAT deck.
- Files whose extension is other than ".mp3(MP3)" or ".jpg/ .jpeg(JPEG)" will not be listed.
- Some unplayable folders or files may be listed due to the recording status.
- High-resolution JPEG files take longer to be displayed.
- Progressive JPEG files (JPEG files saved in progressive format) cannot be played back on this unit.

Press [DVD] first.

1 Insert a playable disc (refer to page 27 on how to insert a disc).

* Make sure the disc is compatible with this unit. (Refer to page 66 for the list of compatible discs.)

It may take a while to load the disc data after the disc tray closes.

When an audio CD is inserted, the track list will appear.

When a CD-RW/-R with MP3/JPEG files is inserted, the file list will appear.

When you insert a CD-RW/-R mixed with MP3/JPEG files, the playback media selection screen will be displayed.

For MP3, select "Music", for JPEG, select "Photo".

- To exit the track/file list, press [STOP ■].
- To resume the track/file list, press [TITLE].

2 Use [▲/▼] to select a desired folder or track/file, then press [OK].

e.g.) File list

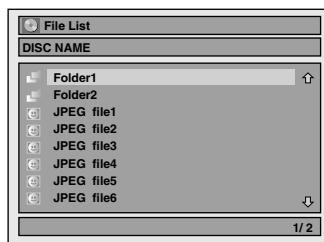

When selecting track/file:

Playback will start.





When selecting the folder (Not available for audio CD):

The files in the folder will appear.

Use [▲/▼] to select the file or folder you want to play back, then press [OK].

- Press [PLAY ►], [OK] or [▶] to move to any lower hierarchies.
- Press [◀] or [RETURN] to move back to the previous hierarchy.

Hints for audio CD tracks and MP3 / JPEG files:

- Folders are shown by .
- Audio CD tracks are shown by .
- MP3 files are shown by .
- JPEG files are shown by .
- The system can recognize up to 255 folders, up to 99 tracks/999 files.
- Letters of a file/folder name overflowing the given space will be displayed as "...". Unrecognizable characters will be replaced with asterisks.
- If there are no files in the folder, "No Files" will be displayed.

It is recommended that files to be played back in this unit are recorded under the following specifications:

<MP3>

- Sampling frequency : 44.1 kHz or 48 kHz.
- Constant bit rate : 112 kbps - 320 kbps

<JPEG>

- Upper limit : 6,300 x 5,100 dots.
- Lower limit : 32 x 32 dots.
- File size of image maximum: 12 MB.

BASIC PLAYBACK

KODAK Picture CD

The Picture CD is a service to convert photographs taken by a conventional film camera into digital data and write the data on a CD. You can enjoy picture images on the TV set by playing back the Picture CDs.

For details of KODAK Picture CD, contact a shop that provides developing service of Kodak Inc.

1) Press [TITLE].

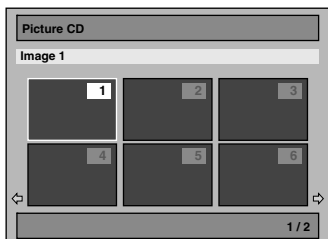

- To exit the Picture CD thumbnail List, press [RETURN] or [STOP ■].

Arrow icons mean the title list includes a next or previous page. Use [◀/▶] in the direction of the icon you wish to follow. You can also quick review the six thumbnails at once between the first and last pages by pressing [◀◀]/[▶▶].

2) Use [▲/▼/◀/▶] to select a desired track to be played back, then press [PLAY ▶] or [OK].

An image will be played back from the selected track and go to the next one in turn.

3) Press [STOP ■] to stop playback.

- Press [TITLE] to display the thumbnail again.

Notes on JPEG and KODAK Picture CD:

- After track is displayed for 5 seconds or 10 seconds (set in "Slide Show" on page 76) the display moves to the next track.

During JPEG or KODAK Picture CD playback, press [▶] or [◀] to rotate a picture 90 degrees clockwise or counterclockwise respectively.

(Not available when the display menu appears.)

Using the Title / Disc Menu



DVD or video CD with PBC function may contain a title list, which describes the contents of the disc, or a disc menu, which guides you through the available functions in the disc.

Press [DVD] first.

1) Insert a disc (refer to page 27 on how to insert a disc).

- * Make sure the disc is compatible with this unit. (Refer to page 66 for the list of compatible discs.)

It may take a while to load the disc data after the disc tray closes.

2) Press [TITLE] or [DISC MENU] to call up the title list or disc menu.

3) Use [▲/▼/◀/▶] to make a selection, and then press [OK] to enable your selection.

4) Press [STOP ■] to exit.

Note

- You can select a numbered menu with [the Number buttons] also.
- Menus vary among discs. Refer to the information accompanying the disc for details.
- [TITLE] or [DISC MENU] will not always be active with all DVD.
- For video CD, when "PBC (Video CD only)" in "DISC Playback Mode" menu is "ON", the video CD main menu will appear when inserting a disc.

Pause

1) During playback, press [PAUSE II].

Playback will be paused.

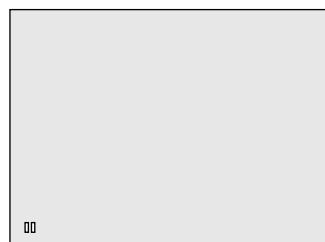

2) Press [PLAY ▶] to return to the normal playback.

Note

- On DVD, set "Still Mode" to "Field" in "Playback" menu if pictures in pause mode are blurred. (Refer to page 107.)

Resume Playback

You can play back from where you last stopped the disc.

1) During playback, press [STOP ■].

The resume message will appear.

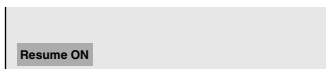

2) Press [PLAY ►].

In a few seconds, playback will resume from the point at which it stopped last. You can resume playback at the same point even if you turn the unit to the standby mode (HDD/DVD only).

To cancel the resume playback and start playing back the disc from the beginning, press [STOP ■] again while the playback is stopped.

For HDD:

You can set a resume point per every title.

For DVD+RW/+R, DVD-RW/-R, Video CD, Audio CD, MP3 files and JPEG files:

You can set only one resume point per disc.

Note

- For MP3/JPEG files, playback will resume from the beginning of the file at which playback was stopped.
- Resume Playback is available when you play back the video CD without PBC function.
- Some video CD with the PBC function resume playback from the beginning of the track.

Fast Forward / Fast Reverse Playback



1) During playback, press [►►] or [◄◄].

Every time you press [►►] or [◄◄], approximate speed will be changed as follows.

Fast forward or fast reverse playback across titles (for HDD/DVD) or files (for MP3) is not possible.



For video CD, approximate forward/reverse speeds are 2x, 8x, 16x.

For audio CD, MP3 files, approximate speed is fixed at 8x with sound (indicated with ►►►►/◄◄◄◄).

2) Press [PLAY ►] to return to the normal playback.

Note

- Forward/reverse speed will be indicated with icons as follows.

forward (approx. speed)

2x: ►►

20x: ►►►

40x: ►►►►

reverse (approx. speed)

5x: ◄◄

20x: ◄◄◄

40x: ◄◄◄◄

Variable Skip / Variable Replay



During playback, you can skip forward or backward by the amount of time you set in "Playback" menu. To set the time amount, refer to "[8] Variable Skip / Replay" on page 107.

During playback, press [SKIP →] if you want to skip forward. Press [REPLAY ◀] if you want to skip backward.

Rapid Playback



Rapid playback function is available only during playback.

This function is available only on discs recorded in the Dolby Digital format, and plays back in a slightly faster/slower speed while keeping the sound output.

1) During playback, press [RAPID PLAY].

- **x0.8:** Press [RAPID PLAY] once during playback. Plays back approximately at 0.8 times of normal playback.
- **x1.3:** Press [RAPID PLAY] twice during playback. Plays back approximately at 1.3 times of normal playback.
- **:** Press [RAPID PLAY] 3 times to play back in normal speed. No effects.

2) Press [PLAY ►] to return to the normal playback.

Note

- Audio (language) setting cannot be changed while using this mode.
- This feature may not work at some point in a disc.
- Audio is PCM during rapid playback mode except when using digital audio connection.
- When using digital audio connection (COAXIAL), the LPCM sound (2 channel) will be output.

Step by Step Playback



1) During playback, press [PAUSE II].

Playback will be paused and sound will be muted.

2) Press [▶▶] repeatedly.

Playback will advance one frame (or step) at a time when you press [▶▶] with the sound muted.

To play back step by step backward:

Press [◀◀] repeatedly.

Every time you press the button, the playback will go backward by one frame.

- Press and hold [◀◀]/[▶▶] to reverse/advance continuously.

3) Press [PLAY ▶] to return to the normal playback.

Note

- Only step by step forward playback is available for playing back video CD.

Slow Forward / Slow Reverse Playback



1) During playback, press [PAUSE II]. Then press [▶▶] or [◀◀].

Every time you press [▶▶] or [◀◀], approximate speed will be changed as follows. (The sound will remain muted.)

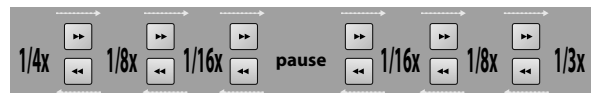

2) Press [PLAY ▶] to return to the normal playback.

Note

- Forward/reverse speed will be indicated with icons as follows.

forward (approx. speed)

1/16x: ▶▶▶▶

1/8x: ▶▶▶▶▶

1/3x: ▶▶▶▶▶▶

reverse (approx. speed)

1/16x: ◀◀◀◀

1/8x: ◀◀◀◀◀

1/4x: ◀◀◀◀◀◀

- Only slow forward is available when playing back video CD.

Chasing Playback during Recording



You can play back a title being recorded from the beginning while recording continues.

1) During recording, press [PLAY ▶].

Playback of the title you are recording will start from the beginning.

- Elapsed playback time will be displayed in the front panel display.

2) Press [STOP ■] once to stop the playback, .

The front panel display will switch back to show the elapsed recording time.

If you press [STOP ■] twice, it will stop the recording.

Note

- You can also use the special playback functions such as [◀◀], [▶▶] etc. during chasing playback mode.
- [REC] is invalid during chasing playback.
- You can no longer fast forward the playback when it comes to a few seconds before the current recording point.

Simultaneous Playback and Recording



With regard to HDD, you can continue recording a program while playing back another title.

To do so, press [TITLE] during recording and select a title you like to play back, and then press [PLAY ▶].

(You can also start the playback from the title list menu.)

To playback a title being recorded while continuing to record, refer to "Chasing Playback during Recording" above (available only with HDD).

Note

- Video CD, audio CD, MP3/JPEG files recorded on a disc can also be played back during HDD recording.

Zoom



1) During playback, press [DISPLAY].

2) Use [◀/▶] to select to display the selection menu.

e.g.) DVD-video

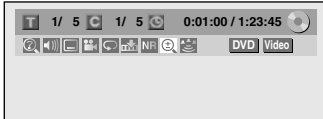

3) Use [▲/▼] to select a desired zoom factor to zoom, then press [OK].

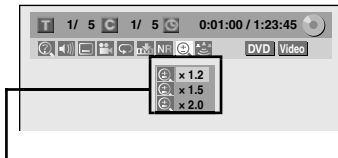

Zoom menu will appear.

There are four options (x1.0, x1.2, x1.5 and x2.0), these are displayed excluding the current zoom rate.

Zoom area will be displayed.

4) Use [▲/▼/◀/▶] to select a desired zoom position, then press [OK].

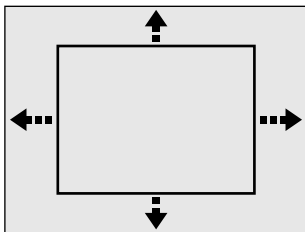

Zoom playback will start.

Note

- When selecting a smaller factor than the current one, the zoom area will not be displayed.
- To exit the zoom menu, press [RETURN] repeatedly at step 3.
- To cancel the zoom function, select "x1.0" using [▲/▼], then press [OK] at step 3.
- When you zoom a picture during a slide show, the slide show will be put in the pause mode. Press [PLAY ▶] to resume the slide show and the zoom function will be turned off.

Marker Setting



This feature allows you to assign a specific point on a title to be called back later.

1) During playback, press [DISPLAY] to bring up the display menu.

If the display menu is already shown, skip to step 2.

2) Use [◀/▶] to select to display the marker list.

e.g.) DVD-video

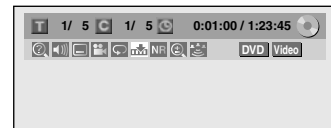

3) Use [▲/▼] to select a desired marker number. When it reaches the desired point, press [OK].

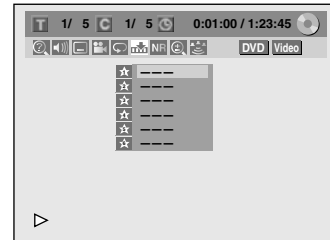

The title (track) number and the time will be displayed.

4) To return to the marker later:

Use [▲/▼] to select the desired marker number, then press [OK].

Note

- To clear a marker, select the marker number to be cleared, then press [CLEAR].
- All markers will be erased when you operate these operations listed below.
 - opening the disc tray (DVD/CD only)
 - turning the unit to the standby mode (DVD/ CD only)
 - make additional recording on the disc (DVD only)
 - editing any title (DVD only)
 - dividing the title (HDD only)
 - deleting a scene of the title (HDD only)
- You can mark up to 6 points.
- Marker setting is not available when you play back the video CD with PBC function.

Repeat Playback

Available repeat function may vary depending the discs.

1) During playback press [DISPLAY], then proceed to step 2), or press [REPEAT] then proceed to step 3).
 • If the display menu is already shown, skip to step 2.

2) Use [◀/▶] to select  to display the selection menu.

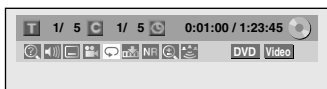

3) Use [▲/▼] to select a desired repeat type, then press [OK].

e.g.) HDD/DVD

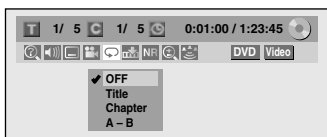

e.g.) audio CD, video CD

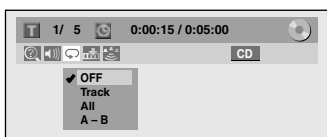

e.g.) MP3 files

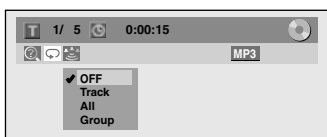

e.g.) JPEG files

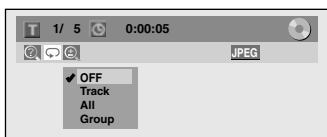

The selected repeat playback will start.

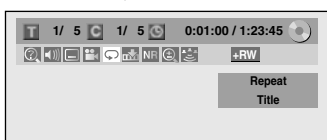

Title (HDD/DVD only):

The current title will be played back repeatedly.

Chapter (HDD/DVD only):

The current chapter will be played back repeatedly.

All (DVD/audio CD/video CD without PBC function/ CD with MP3, JPEG):

All titles in the media will be played back repeatedly.

A-B (HDD/DVD/audio CD/video CD without PBC function only):

Desired section can be played back repeatedly.

- 1) Use [▲/▼] to select "A-B", then press [OK].
- 2) Press [OK] at the desired starting point A.
- 3) Press [OK] at the desired ending point B.

Track (audio CD/video CD without PBC function/ MP3 or JPEG files only):

The current track or file will be played back repeatedly.

Group (MP3/JPEG files only):

The current folder will be played back repeatedly.

Note

- Point B for the repeat A-B playback should be set within the same title or track as point A.
- To cancel the repeat playback, select "OFF" at step 3. The repeat setting will also be canceled when you stop playback.
- You cannot select "Group" during the random playback.
- Repeat playback is not available when you play back the video CD with PBC function.

Random Playback



You can play back a disc randomly instead of playing back in the original order.

1) Press [MENU].

2) Use [▲/▼] to select "DISC Playback Mode", then press [OK].

"DISC Playback Mode" menu will appear.

For MP3, use [▲/▼] to select "Music", then press [OK].

For JPEG, use [▲/▼] to select "Photo", then press [OK].

3) Use [▲/▼] to select "Random Play", then press [OK].

Random playback will start.

Note

- To cancel random playback, press [STOP ■] twice during random playback. "OFF" appears on the TV screen.
- For video CD with PBC function, the PBC setting will be switched to the standby mode automatically when you start random playback.

Slide Show



You can select the display time between 5 seconds and 10 seconds.

1) Follow steps 1 and 2 in "Random Playback" on page 76.

2) Use [▲/▼] to select "Slide Show", then press [OK].

3) Use [▲/▼] to select the display time, then press [OK].

4) Press [MENU] to exit.

Note

- Large-size JPEG files take a few moments to be displayed.

Program Playback



You can program the disc to play back in your desired order.

- 1) Press [MENU].
- 2) Use [▲/▼] to select "DISC Playback Mode", then press [OK].
"DISC Playback Mode" menu will appear.
- 3) Use [▲/▼] to select "Program Play", then press [OK].
- 4) Use [▲/▼] to select a desired track, then press [OK] or [▶].

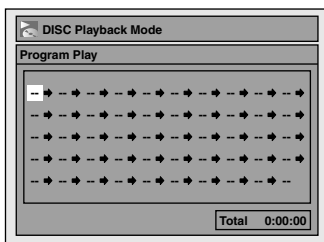

Repeat this step until you program all the desired tracks.

- 5) Press [PLAY ▶].

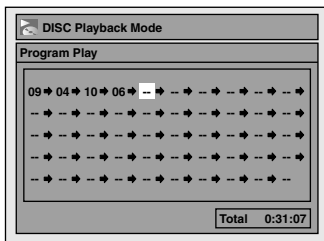

Program playback will start.

Note

- To erase tracks you selected, press [CLEAR] at step 4.
- You can program up to 50 tracks.
- To cancel program playback, press [STOP ■] twice during program playback. "OFF" appears on the TV screen.
- Program information will be retained until you turn the unit to the standby mode or open the disc tray.
- You may also select a desired track using [the Number buttons] at step 4.
- For video CD with PBC function, the PBC setting will be switched to the standby mode automatically when you start program playback.

Playing Back the Autostart Recording



By playing back the autostart recording, you can pause or go back the TV program you are currently watching. For the autostart recording refer to "AUTOSTART RECORDING" on page 46.

To pause and resume the TV program:

- 1) When watching TV program through this unit's tuner, press [PAUSE II].
TV program will be paused and sound will be muted.
- 2) Press [PLAY ▶] to resume the TV program you were watching from where you have paused.

To rewind or fast forward the TV program:

When watching TV program through this unit's tuner, press [◀◀], [◀], [REPLAY ⏮], [▶▶], [▶▶] or [SKIP ▶▶].

- While playing back the autostart recording, pressing [◀◀] or [▶▶] skips playback point 5 minutes backward or forward.

To go back to the specific time:

- 1) When watching a TV program through this unit's tuner, press [DISPLAY], then press [OK].
- 2) Use [▲/▼/◀/▶] or [the Number buttons] to enter a desired time, then press [OK].

- While playing back the autostart recording, press [STOP ■] to cancel the playback.
- When watching TV program or while playing back the autostart recording, press [DISPLAY] once to display the autostart recording information. Refer to "Autostart Recording Information" on page 23.
- Noise reduction, zoom and virtual surround functions are available while playing back the autostart recording.

Note

- While playing back the autostart recording, you cannot change the channels.
- While playing back the autostart recording, you cannot change the DTV audio language.
- If you change to DVD mode or if the timer recording starts while playing back the autostart recording, the playback will be stopped.
- When this unit turns on for the timer recordings, the autostart recording will not be performed.
- For the contents of the autostart recording, you cannot change the TV audio.

SEARCH

Title / Chapter Search



Using [◀◀]/[▶▶]

- 1) During playback, press [▶▶] to skip the current title or chapter and move to the next.

The title or chapter will move forward one at a time.

- If there is no chapter in one title, the current title will be skipped.

To go back to the beginning of the current title or chapter, press [◀◀].

Press it repeatedly to go to the previous title or chapter. The title or chapter will move backward one at a time.

Note

- With regard to HDD, chapter search using [◀◀]/[▶▶] is available only within the same title.

Using [DISPLAY]

- 1) During playback, press [DISPLAY].

- 2) Use [◀/▶] to select , then press [OK].

e.g.) DVD-video

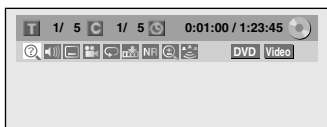

The number next to **T** will be highlighted.

- 3) Title:

Use [▲/▼] or [the Number buttons] to enter a desired title number to search, then press [OK].

Title search will start.

Chapter:

Press [▶] to move to the number next to **C** for chapter.

Use [▲/▼] or [the Number buttons] to enter a desired chapter number to search, then press [OK].

After the search, playback will start automatically.

Note

- In search mode display, total numbers of each search contents (title/chapter/time) are shown as a denominator.

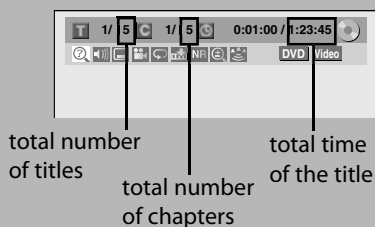

Track Search



Using [◀◀]/[▶▶]

- 1) During playback, press [▶▶] to skip the current track/file and move to the next.

The track/file will move forward one at a time.

To go back to the beginning of the current track/file, press [◀◀].

Press it repeatedly to go to the previous track/file. The track/file will move backward one at a time.

For JPEG files, press it once to go to the previous file.

Using [DISPLAY]

- 1) During playback, press [DISPLAY] to bring up the display menu.

If the display menu is already shown, skip to step 2.

- 2) Use [◀/▶] to select , then press [OK].

e.g.) audio CD

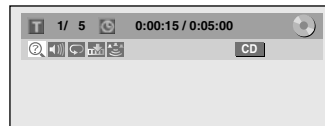

e.g.) MP3 files

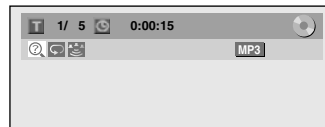

The number next to **T** will be highlighted.

- 3) Use [▲/▼] or [the Number buttons] to enter a desired track/file number to search, then press [OK].

After the search, playback will start automatically.

Note

- During CD playback you can enter a track number directly using [the Number buttons] for track search without displaying the menu.
- Track search using [DISPLAY] is not available when you play back the video CD with PBC function.

Time Search



1) During playback, press [DISPLAY] to bring up the display menu.

If the display menu is already shown, skip to step 2.

2) Use [◀/▶] to select , then press [OK].

e.g.) DVD-video

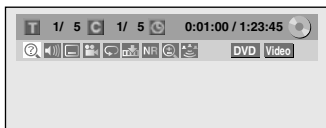

e.g.) audio CD

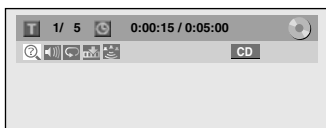

The number next to **T** will be highlighted.

To move to the number next to , press [▶].

When time search is not available,  and time counter are not displayed.

3) Use [▲/▼ / ◀/▶] or [the Number buttons] to enter a desired time to search, then press [OK].

After the search, playback will start automatically.

Note

- Time search is available only in the same track, file or title.
- Time search is not available when you play back the video CD with PBC function.

SELECTING THE FORMAT OF AUDIO AND VIDEO

You can select the format of audio and video as you prefer depending on the contents of the disc you are playing back.

Switching Subtitles



DVD-video may have subtitles in 1 or more languages. Available subtitle languages can be found on the disc case. You can switch subtitle languages anytime during playback.

- 1) During playback, press [DISPLAY].
- 2) Use [◀/▶] to select  to display the selection menu.
e.g.) DVD-video

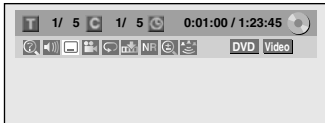

- 3) Use [▲/▼] to select a desired subtitle language, then press [OK].

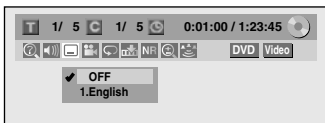

Subtitle will be displayed in the selected language. When selecting "OFF", subtitle will disappear.

Note

- Some discs will only allow you to change the subtitle from the disc menu. Press [TITLE] or [DISC MENU] to display the disc menu.
- If a 4-digit language code appears in the subtitle menu, refer to "LANGUAGE CODE" on page 120.

Switching Audio Soundtrack



When playing back a DVD-video recorded with 2 or more soundtracks (these are often in different languages), you can switch them during playback. When playing back video CD, audio CD you can switch "L/R"(stereo), "L"(left) or "R"(right).

- 1) During playback press [DISPLAY], then proceed to step 2), or press [AUDIO] then proceed to step 3).
 - If the display menu is already shown, skip to step 2.
- 2) Use [◀/▶] to select  to display the selection menu.
- 3) Use [▲/▼] to select a desired audio soundtrack or audio channel, then press [OK].

For DVD-video

- Audio soundtrack will switch.

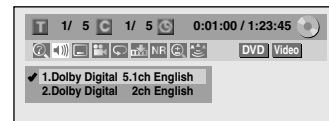

- If the title contains both main and sub audio, you can further select "L" (main), "R" (sub), or "L/R" (mixed of main and sub).

For audio CD, video CD

- Audio channel will switch.

e.g.) audio CD

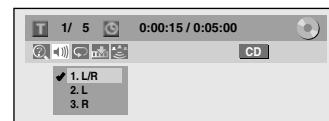

Note

- Some discs will only allow you to change the soundtrack from the disc menu. Press [TITLE] or [DISC MENU] to display the disc menu.

SELECTING THE FORMAT OF AUDIO AND VIDEO

Switching Virtual Surround System



You can enjoy stereophonic virtual space through your existing 2 channel stereo system.

1) During playback, press [DISPLAY] to bring up the display menu.

If the display menu is already shown, skip to step 2.

2) Use [◀/▶] to select to display the selection menu.

e.g.) DVD-video

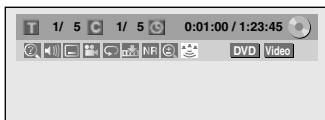

3) Use [▲/▼] to select "OFF", "Type 1" or "Type 2", then press [OK].

e.g.) DVD-video

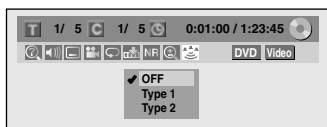

- OFF** : no effect
- Type 1** : natural effect
- Type 2** : emphasized effect

Note

- Select "OFF" in a case sound is distorted.
- The setting will be kept even when the unit is turned off.

Switching Camera Angles



Some DVD-videos have scenes shot from 2 or more angles. Angle information should be on the disc case if the disc contains multi-angle scenes.

1) During playback, press [DISPLAY].

2) Use [◀/▶] to select , then press [OK].

e.g.) DVD-video



Angle icon appears when a switching camera angle is available.

Angle will switch each time you press [OK].

Note

- Angle icon does not appear on the TV screen in a case you set "Angle Icon" to "OFF" in "Playback" menu. Refer to page 107.

Reducing Block Noise



This function reduces noise in the playback picture.

1) During playback, press [DISPLAY].

2) Use [◀/▶] to select **NR** to display the selection menu.

e.g.) DVD-video



3) Use [▲/▼] to select a desired option, then press [OK].

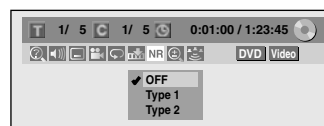

Your setting will be activated.

- OFF** : When playing back titles with a few noises such as DVD-video.
- Type 1** : For the titles recorded in long time mode such as SLP mode.
- Type 2** : Same as type 1, only more effective.

INFORMATION ON EDITING

Guide to a Title List

Title list allows you to check the titles recorded on the HDD or the disc easily. You can choose a title to play back from this list and easily edit the titles as you prefer.

Press [HDD], then press [TITLE].

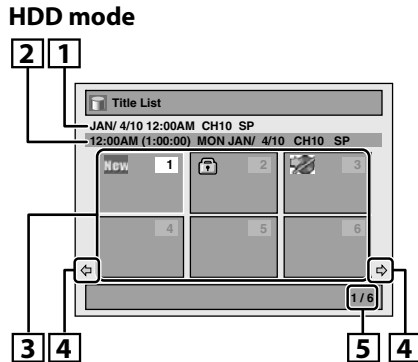

Press [DVD], then press [TITLE].

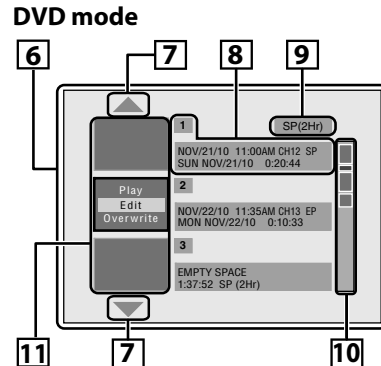

e.g.) DVD

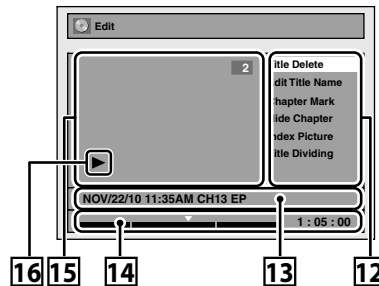

- Title name** (editable): Recording date, time, channel and the recording mode will be assigned automatically as the title name until you edit it.
- Title information:** Time at which the recording of the title was started, duration of the title, date recorded, channel recorded, and the recording mode in which the title was recorded.
- Title List:** List of titles recorded on the HDD. Each title is indicated by its index picture. Following icons may be displayed on the index picture.
 - NEW:** Indicating the title has never been played back.
 - Lock icon:** Indicating the title is protected.
 - Copy-protected icon:** Indicating the title is a copy-protected title.
 - :** If you call up the title list while recording, "●" will be displayed on the index picture of the title currently being recorded.
- Arrow:** Indicating there is a previous/next page.
- Title list page number:** Current page/total pages.
- Title list:** List of the titles recorded on the disc, and their information.
- Arrow:** Indicating there is a previous/next page.
- Title information:** On the first line, title name (editable) is displayed. On the second line, the date recorded and length of the title are displayed.

EMPTY SPACE: The portion of the disc where there are no recordings made. As for the EMPTY SPACE, available recording time by the selected recording mode is displayed on the second line.
- Recording mode:** Currently selected recording mode is displayed here.
- Capacity indicator:** Indicating the position and the amount of each title in the disc. The portion for the selected title is highlighted.
 - It may not indicate the precise capacity of the disc.
 - If the duration of a title is too short, it may not be reflected in the capacity indicator.
- Index pictures:** A cut from the recorded content is displayed here.
- Submenu:** Submenus for the selected menu are displayed here.
- Title name** (editable): If you do not name the title, the recorded date, time, channel, and the recording mode are displayed here.
- Progress bar:** Indicating the progress of the playback.
- Preview window:** Preview of the selected title is displayed here.
- Playback status:** Indicating the current playback status of the selected title.

Press [STOP ■] to exit the title list.

INFORMATION ON EDITING

Edit Menu

Available Features	Media	
	HDD	DVD
Putting names on titles	✓	✓
Deleting a title	✓	✓
Deleting selected titles	✓	
Deleting a scene of a title	✓	
Adding / deleting chapter marks	✓	✓
Hiding chapters		✓
Protecting a title	✓	
Dividing a title	✓	✓ *1
Setting an index picture		✓
Finalizing a disc		✓
Making edits compatible		✓ *2
Putting name on disc		✓
Setting or Releasing disc protect		✓

✓ : Available

□ : Not available

*1 : -RW/+RW discs only

*2 : +RW discs only

Note

- Once you have finalized a DVD+R/ DVD-R, you cannot edit or record anything on that disc.
- While recording a title to an HDD or a DVD, only deleting HDD titles is available.

How to Access the Edit Menu

HDD

Press [HDD] first.

1) Press [TITLE].

2) Use [▲/▼/◀/▶] to select a desired title, then press [OK].

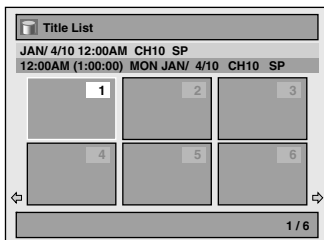

3) Use [▲/▼] to select "Edit", then press [OK].

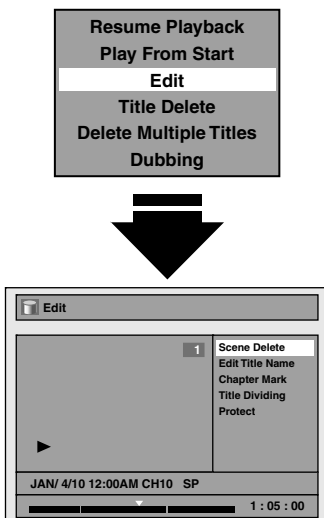

DVD

Press [DVD] first.

1) Press [TITLE].

2) Use [▲/▼] to select a desired title, then press [OK].

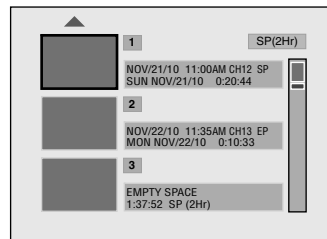

3) Use [▲/▼] to select "Edit", then press [OK].

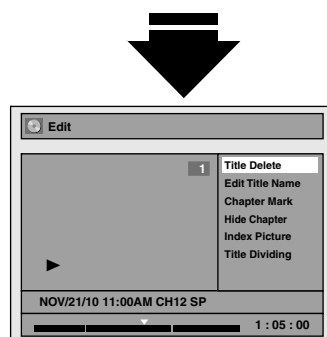

EDITING

Deleting a Title

You can delete a title which you do not need anymore.
Please be advised that the title once deleted cannot be brought back.

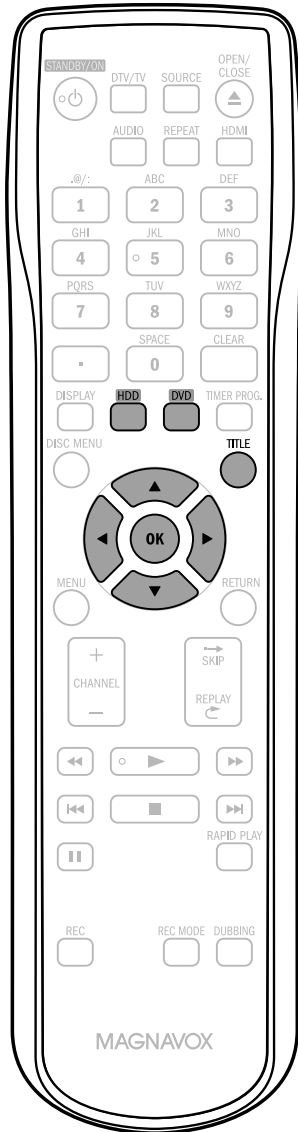

If you are editing the titles on HDD, press **[HDD]** first.
If you are editing the titles on DVD, press **[DVD]** first.

1 Press **[TITLE]**.

2 Use **[▲/▼/◀/▶]** to select a desired title to delete, then press **[OK]**.
If you are editing the titles on HDD, proceed to step 4.
If you are editing the titles on DVD, proceed to step 3.
HDD mode

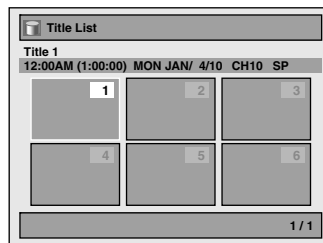

DVD mode

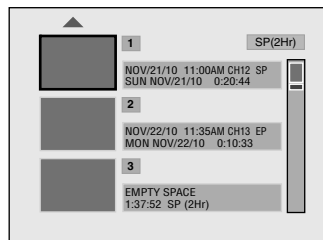

3 Use **[▲/▼]** to select "Edit", then press **[OK]**.



Note

- For DVD+RW/DVD-RW, the available disc space will increase only when the last recorded title in the title list is deleted. For DVD+R/DVD-R, the disc space will not be affected.
- Deleted part of the titles in the capacity indicator changes in color.
- As for DVD+RW/DVD-RW if you delete the title, deleted title will be displayed as "EMPTY SPACE".
- For DVD, it may take a while to write the data to the disc after you press **[OK]** at step 5.

4 Use [▲/▼] to select "Title Delete", then press [OK].

HDD mode

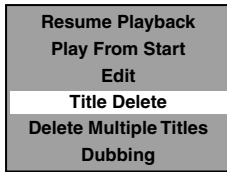

DVD mode

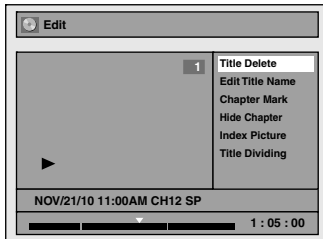

Confirmation message will appear.

5 Use [▲/▼] to select "Yes", then press [OK].

The title is now deleted.

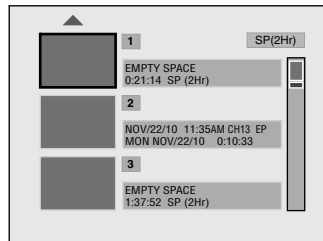
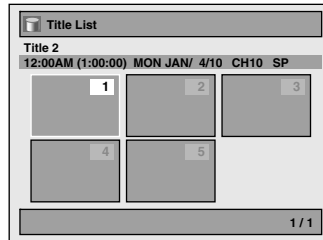

Deleting Selected Titles



You can delete titles which you do not need anymore.
Please be advised that the titles once deleted cannot be brought back.

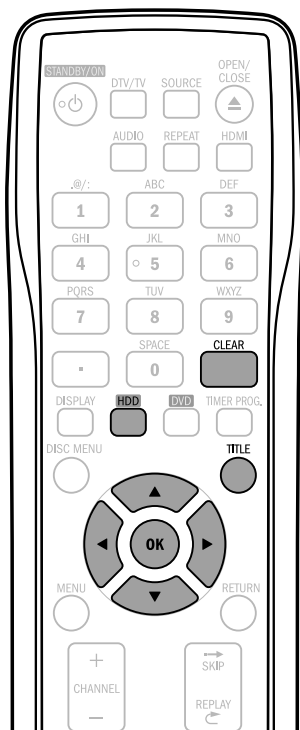

1 Press [HDD], then press [TITLE].

2 Use [▲/▼/◀/▶] to select any title, then press [OK].

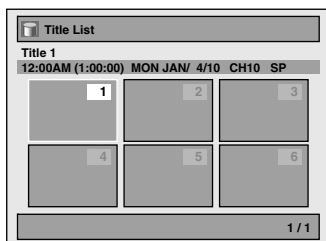

3 Use [▲/▼] to select "Delete Multiple Titles", then press [OK].

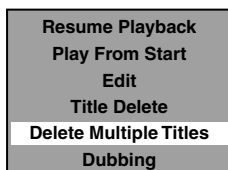

4 Use [▲/▼/◀/▶] to select the title you want to delete, then press [OK].

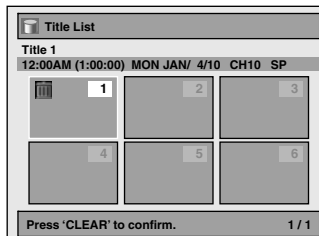

Trash mark will appear indicating the title is marked for deletion.

5 Repeat step 4 until you select all the titles you want to delete.

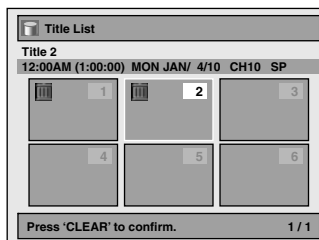

6 Press [CLEAR].
Confirmation message will appear.

7 Use [▲/▼] to select "Yes", then press [OK].
Titles are now deleted.

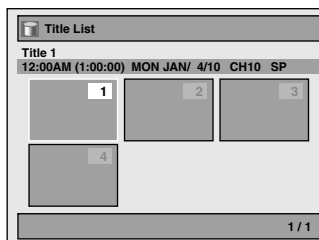

To remove the trash mark from the title:
Select the title with the trash mark, then press [OK].

Putting Names on Titles

You can put title names on the titles and change the names from this menu.



1 Follow steps in "How to Access the Edit Menu" on page 83 to display "Edit" menu.

2 Use [▲/▼] to select "Edit Title Name", then press [OK].
e.g.) DVD

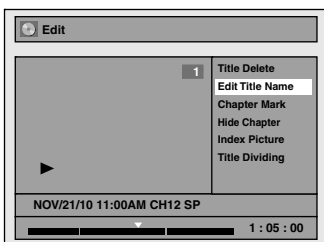

3 To enter a title name, follow the steps of "Guide to Edit Title Name" on page 87.

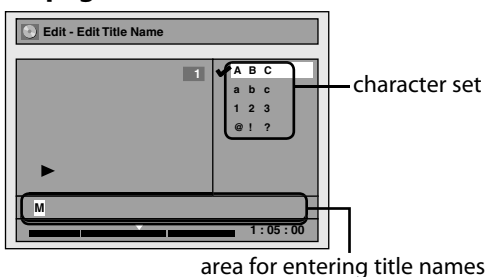

4 Use [▲/▼] to select "Yes", then press [OK].

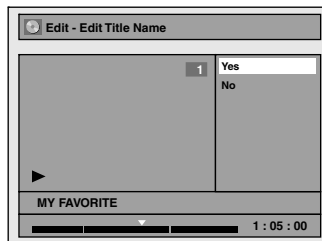

The title name is now updated.

5 Press [RETURN] once or repeatedly to go back to the title list.
For DVD, the data will be written onto the disc momentarily.

This operation may take a while to be completed.

Guide to Edit Title Name

1) Use [▲/▼] to select a desired character set, then press [OK].

2) Follow the list below, use [the Number buttons] repeatedly until the desired letter appears.

When you finish entering a title name, press [OK].

Select Press	ABC	abc	123	@!?
0	<space>	<space>	0	<space>
1	(*1)	(*1)	1	! " # \$ % & ' () * + , - . / : ; < = > ? @ [] ^ _ { }
2	ABC	abc	2	
3	DEF	def	3	
4	GHI	ghi	4	
5	JKL	jkl	5	
6	MNO	mno	6	
7	PQRS	pqrs	7	
8	TUV	tuv	8	
9	WXYZ	wxyz	9	

*1 Press **1**, character set will be changed to "@!?" mode automatically. Press **2** to **9** to go back to the previous character set.

• To delete letters, press [CLEAR] repeatedly. Holding [CLEAR] will delete all letters.

• Use [◀/▶] to move the cursor to the left and right.

• You can enter up to 30 letters.

Note

• Undefined letters in a title name are shown by "x". If you delete them, adjoining letters may change to "x".

• Press the corresponding number key repeatedly to choose the available letters.

e.g.) Press **2** three times to choose the letter "C".

Chapter Marks (Add)

You can put chapter marks in each title. Once a chapter is marked, you can use it for the chapter search feature.

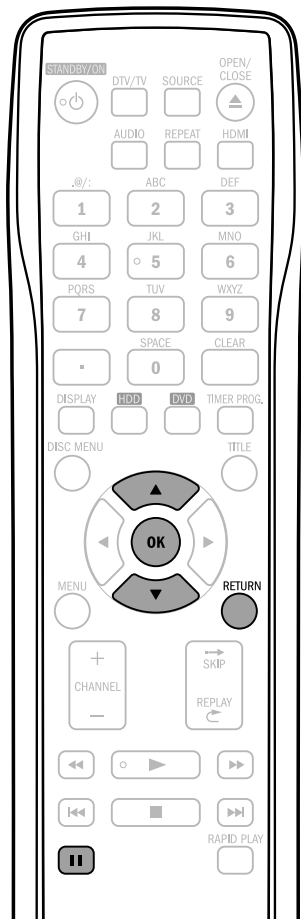

To add a chapter mark:

- 1** Follow steps in “How to Access the Edit Menu” on page 83 to display “Edit” menu.
- 2** Use [▲/▼] to select “Chapter Mark”, then press [OK].
Submenu will appear.
- 3** Play back the title up to the point where you want to set a new chapter mark.
When it comes to the desired point, press [PAUSE III].
- 4** Use [▲/▼] to select “Add”, then press [OK].
e.g.) DVD
- 5** Use [▲/▼] to select “Yes”, then press [OK].

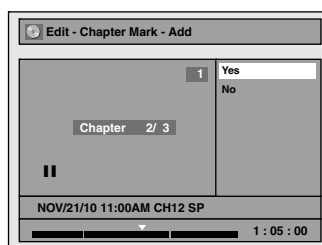
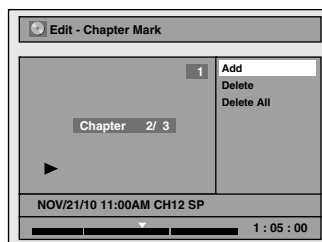

A new chapter mark is now added.

To add more chapter marks, repeat steps 3 to 5.

- 6** Press [RETURN] once or repeatedly to go back to the title list.
For DVD, the data will be written onto the disc momentarily.

This operation may take a while to be completed.

Note for adding or deleting chapter marks

- Maximum number of chapter marks in a title is 99 (for HDD/DVD) and the maximum number of chapter marks in total is no limit (for HDD) / 254 (for DVD). If the number of the chapter marks exceed the limit, you cannot add any more chapter marks.
- Only with regard to DVD editing, you may not be able to add chapter marks depending on the duration of the title or the number of chapters.
- Only with regard to DVD editing, remaining time of the disc may decrease when adding chapter marks or increase when clearing chapter marks depending on the recording time or edited contents.
- When you search for a point at step 3, you can also use the special playback functions such as [▶▶], [▶▶▶] etc.

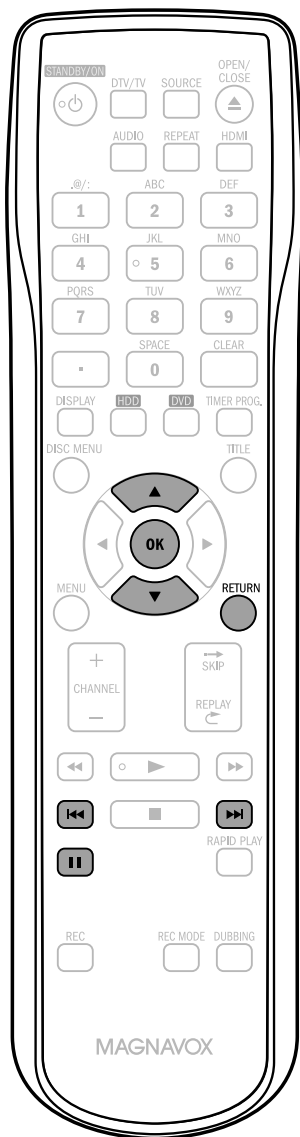

To delete a chapter mark:

- 1** Follow steps in “How to Access the Edit Menu” on page 83 to display “Edit” menu.
- 2** Use [▲/▼] to select “Chapter Mark”, then press [OK].
Submenu will appear.
- 3** Use [◀◀]/[▶▶] to go to the chapter with the chapter mark number you want to delete, then press [PAUSE III].
Chapter mark number is displayed on the preview screen.
e.g.) DVD

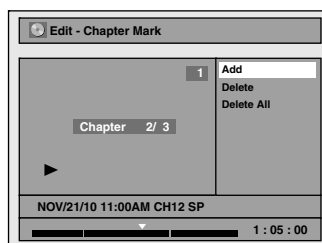

- 4** Use [▲/▼] to select “Delete”, then press [OK].

- 5** Use [▲/▼] to select “Yes”, then press [OK].

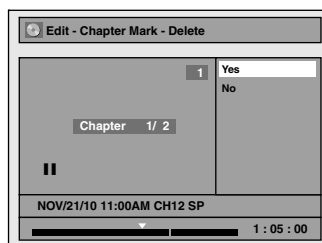

The selected chapter mark is now deleted.
To delete more chapter marks, repeat steps 3 to 5.

- 6** Press [RETURN] once or repeatedly to go back to the title list.
For DVD, the data will be written onto the disc momentarily.

This operation may take a while to be completed.

Note

- You cannot delete the first chapter mark.

Chapter Marks (Delete All)

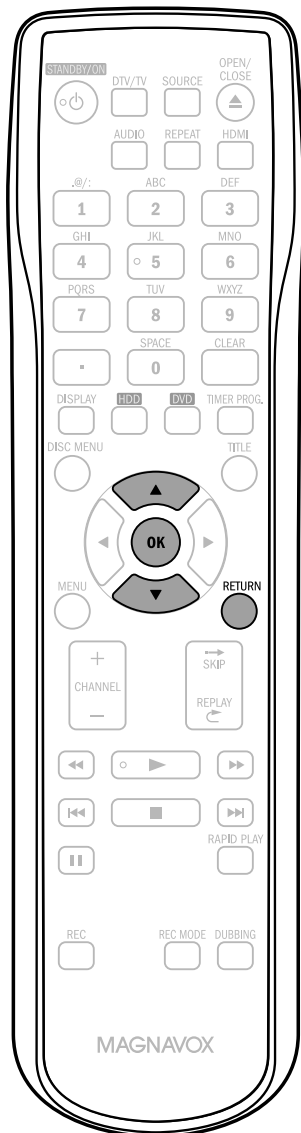

To delete all chapter marks:

- 1** Follow steps in “How to Access the Edit Menu” on page 83 to display “Edit” menu.
- 2** Use [▲/▼] to select “Chapter Mark”, then press [OK].
Submenu will appear.
- 3** Use [▲/▼] to select “Delete All”, then press [OK].
- 4** Use [▲/▼] to select “Yes”, then press [OK].

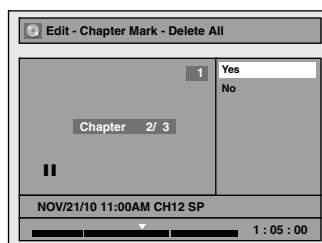

All chapter marks are now deleted.

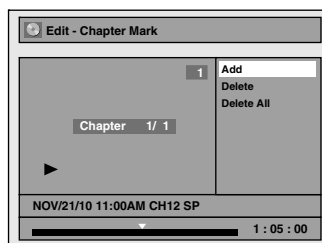

- 5** Press [RETURN] once or repeatedly to go back to the title list.
Data will be written onto the disc momentarily.

This operation may take a while to be completed.

Dividing a Title



You can divide one title into 2 new titles.

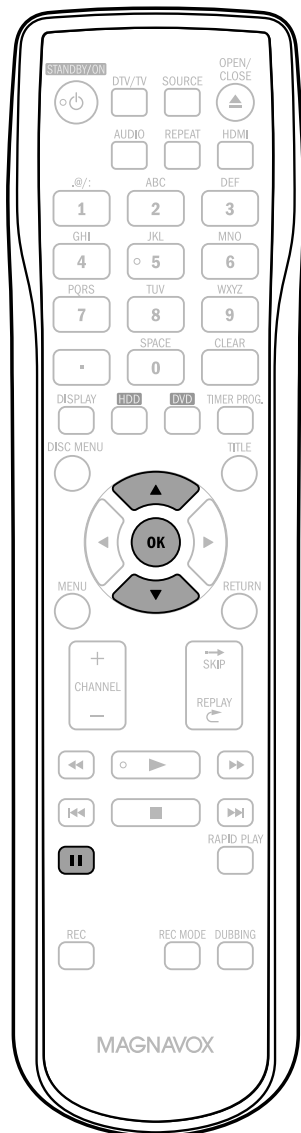

1 Follow steps in “How to Access the Edit Menu” on page 83 to display “Edit” menu.

2 Play back the title up to the point where you want to divide the title. When it comes to the desired point, press [PAUSE II].

3 Use [▲/▼] to select “Title Dividing”, then press [OK].

4 Use [▲/▼] to select “Yes”, then press [OK].
The title is now divided into 2 new titles, and it will go back to the title list automatically. Title name's of the divided titles are identical, and index pictures are reset to the first scene at this point.

Note

- If an internal HDD or a DVD contains the maximum number of titles (HDD: 600, DVD+RW/-RW: 49), you cannot divide any titles.
- With DVD+RW/-RW, you cannot divide the titles if the total number of chapters has already reached 254.
- When you search for a point at step 2, you can also use the special playback functions such as [▶▶], [▶▶▶] etc.
- For DVD, it may start writing data to the disc as you complete the editing procedure.

Deleting a Scene of a Title



You can delete a specific part of a title.

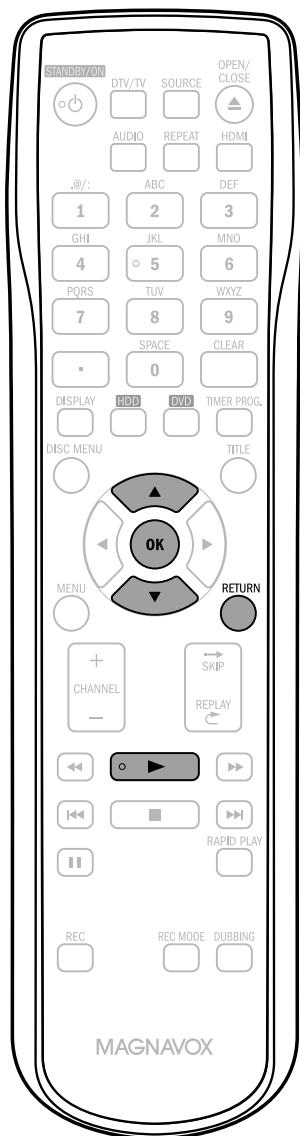

1 Follow steps in “How to Access the Edit Menu” on page 83 to display “Edit” menu.

2 Use [▲/▼] to select “Scene Delete”, then press [OK].

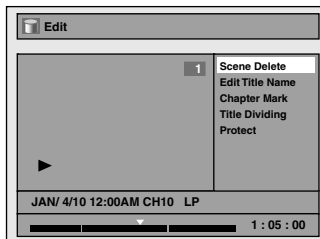

3 Play back the title up to the point where you want to set a start point for the scene to be deleted, then press [OK].

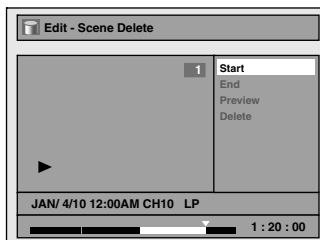

Start point is now set, and the highlight automatically moves to “End”.

4 Play back the title up to the point where you want to set an end point, then press [OK].

At the end of a title, playback will be in pause mode. Press [PLAY ►] to resume playback from the beginning of the title.

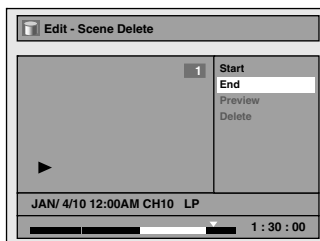

End point is now set, and the highlight automatically moves to “Preview”.

The portion for deletion is indicated in red in the progress bar at the bottom of the screen.

Note

- When you search for the start/end point at step 3/4, you can also use the special playback functions such as [▶▶], [▶▶▶] etc.

5 With "Preview" highlighted, press [OK] to preview the result.

Every time [OK] is pressed, the deleted scene will be shown including scene material 5 seconds before and after the deleted scene.

- If you are not satisfied with the result, use [▲/▼] to go back to "Start" or "End", and try setting them again.
- If you are satisfied with the result, proceed to step 6.

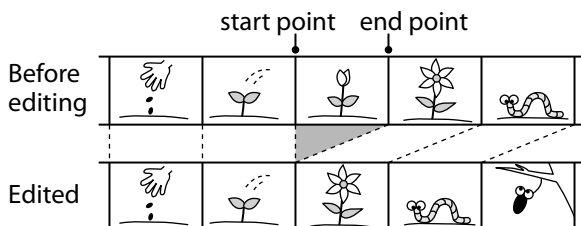

6 Use [▲/▼] to select "Delete" then press [OK].

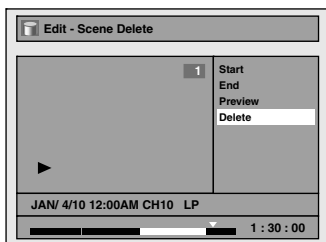

7 Use [▲/▼] to select "Yes" then press [OK].

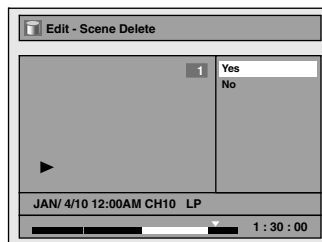

The selected scene is now deleted.

8 Press [RETURN] once or repeatedly to go back to the title list.

Protecting a Title



To prevent the accidental editing, or erasing of the titles, you can protect them using the “Edit” menu.

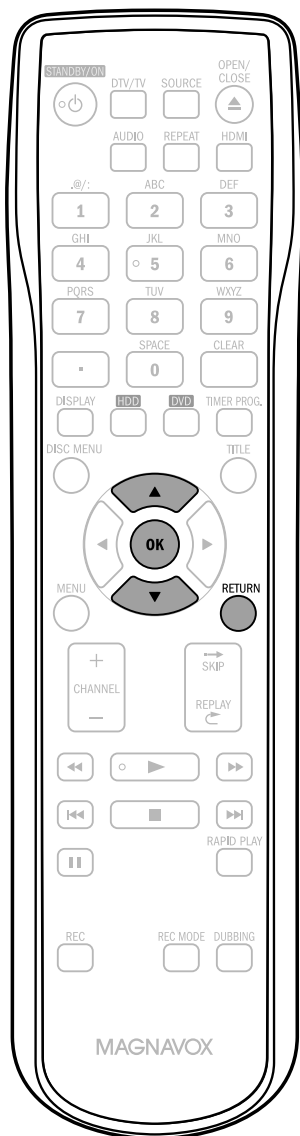

1 Follow steps in “How to Access the Edit Menu” on page 83 to display “Edit” menu.

2 Use [▲/▼] to select “Protect”, then press [OK].

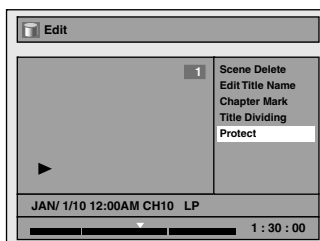

3 With “OFF ➔ ON” selected, press [OK].

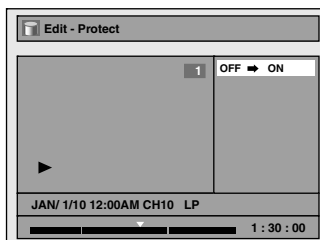

The title is now protected.

- If the title is already protected, “ON ➔ OFF” will appear instead. Press [OK], to release the title from protection.
- The protected title will be marked with  icon.

4 Press [RETURN] once or repeatedly to go back to the title list.

Hiding Chapters



You can hide chapters from the title list. Hidden chapters are skipped during playback.

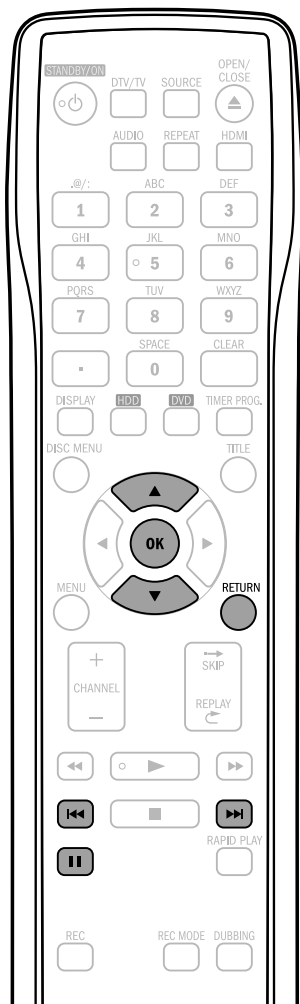

1 Follow steps in “How to Access the Edit Menu” on page 83 to display “Edit” menu.

2 Use [▲/▼] to select “Hide Chapter”, then press [OK].
Submenu will appear.

3 Use [◀◀]/[▶▶] to go to the chapter you want to hide, then press [PAUSE II].

4 Use [▲/▼] to select “Hidden”, then press [OK].

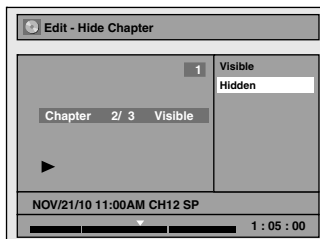

The chapter is now hidden.

5 Press [RETURN] once or repeatedly to go back to the title list.
Data will be written onto the disc momentarily.

This operation may take a while to be completed.

If you want hidden chapters to be “Visible”, select the chapter to be shown. Then use [▲/▼] to select “Visible” at step 4 on page 95. Data will be written onto the disc momentarily. After the data is written, the title list is displayed.

Note

- “Hidden” will be displayed in the preview window while previewing the hidden chapter.
- When you make all chapters in the title “Hidden”, “Hidden” is displayed on an index picture of the title list.

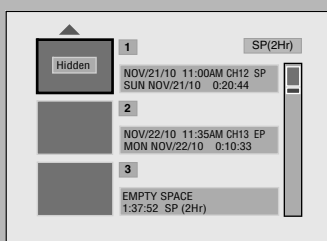

Setting an Index Picture



You can set your desired scene as an index picture for each title.

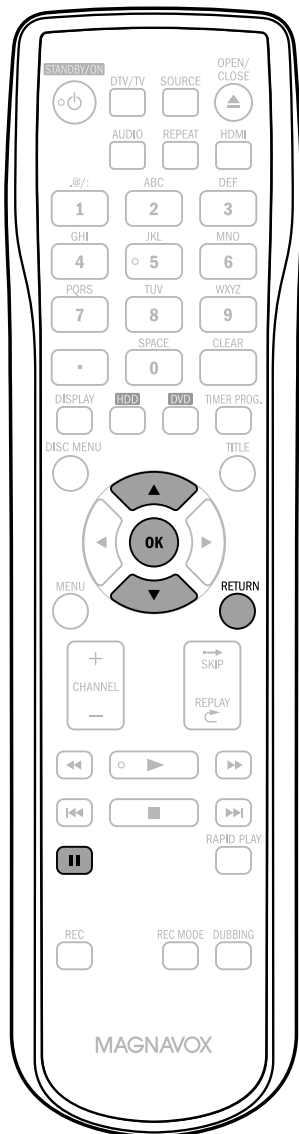

- 1** Follow steps in “How to Access the Edit Menu” on page 83 to display “Edit” menu.

- 2** Play back the title to find the scene you want to use as an index picture. When it comes to the desired point, press [PAUSE II].

- 3** Use [▲/▼] to select “Index Picture”, then press [OK].

- 4** Use [▲/▼] to select “Yes”, then press [OK].

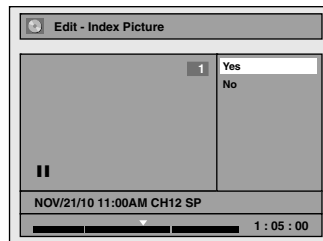

A new index picture is now set.

- 5** Press [RETURN] once or repeatedly to go back to the title list. Data will be written onto the disc momentarily.

This operation may take a while to be completed.

Note

- If the selected picture for an index picture is overwritten, the index picture is reset to the first scene of the title.
- When you search for the point at step 2, you can also use the special playback functions such as [▶▶], [▶▶▶] etc.

Putting Name on Disc



You can put a name on the disc and change it from this menu.

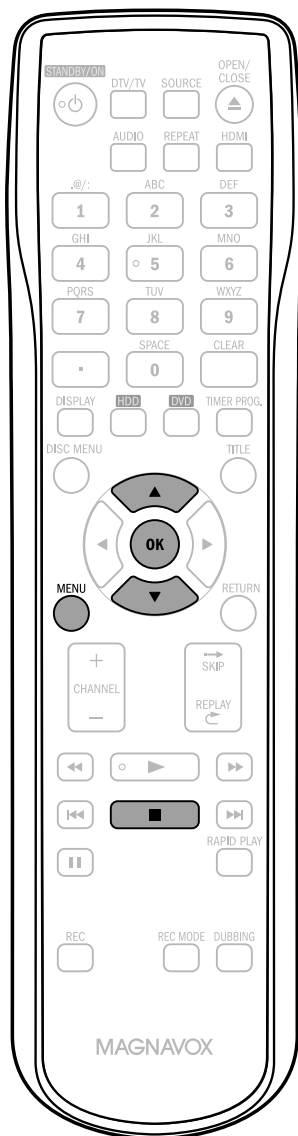

Press [STOP ■] if you are playing back a disc.

1 Press [MENU].

2 Use [▲/▼] to select "Disc Edit", then press [OK].

3 Use [▲/▼] to select "Edit Disc Name", then press [OK].
e.g.) DVD+RW

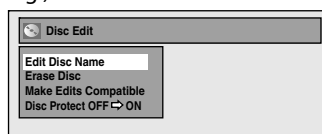

A window for entering a title name will appear.

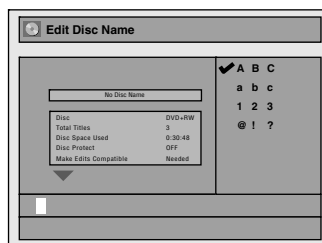

4 To enter a disc name, follow the steps of "Guide to Edit Title Name" on page 87.

When you finish entering a title name, press [OK].

5 Use [▲/▼] to select "Yes", then press [OK].
Data will be written onto the disc momentarily.

This operation may take a while to be completed.

The disc name is now updated.

Note

- You cannot select "Disc Edit" when finalized DVD+R or DVD-R is inserted.

Erasing Disc



You can erase all titles on a disc.

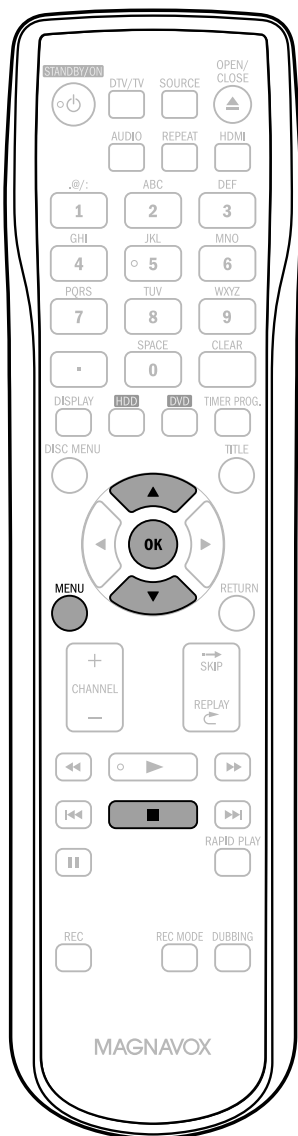

Press **[STOP ■]** if you are playing back a disc.

1 Press **[MENU]**.

2 Use **[▲/▼]** to select "Disc Edit", then press **[OK]**.

3 Use **[▲/▼]** to select "Erase Disc", then press **[OK]**.
e.g.) DVD+RW

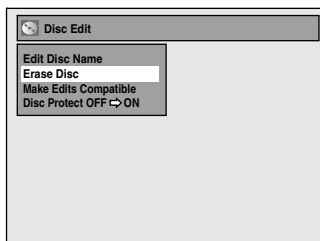

4 Use **[▲/▼]** to select "Yes", then press **[OK]**.

When you press "Yes", all the contents in the disc will be erased.
Are you sure to erase the disc?

Yes
No

Format data will be written onto the disc momentarily.

This operation may take a while to be completed.

Note

- When you select "Yes" at step 4, all contents of the disc will be erased.

Making Edits Compatible



If you have added or deleted chapters, or made chapters hidden, you must perform "Make Edits Compatible" to see those effects on another unit.

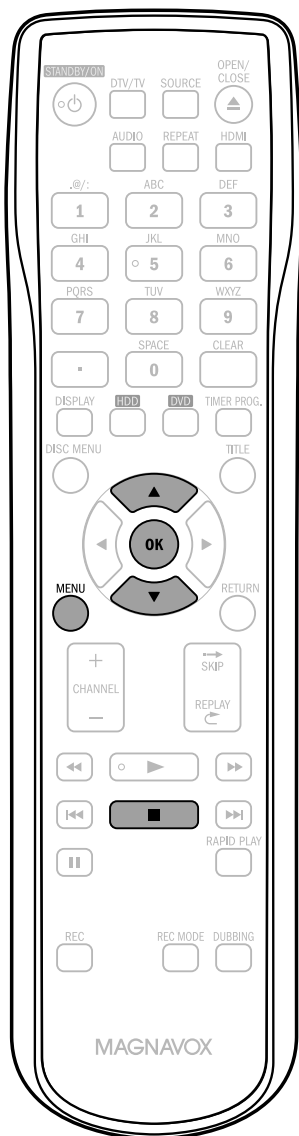

Press [STOP ■] if you are playing back a disc.

1 Press [MENU].

2 Use [▲/▼] to select "Disc Edit", then press [OK].

3 Use [▲/▼] to select "Make Edits Compatible", then press [OK].

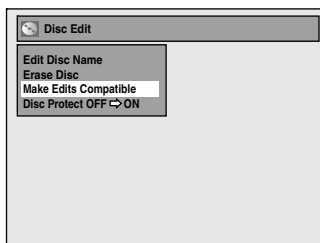

4 Use [▲/▼] to select "Yes", then press [OK].

Activate the Make Edits Compatible?

Yes
No

Data will be written onto the disc momentarily.

This operation may take a while to be completed.

Deleting All Titles in HDD

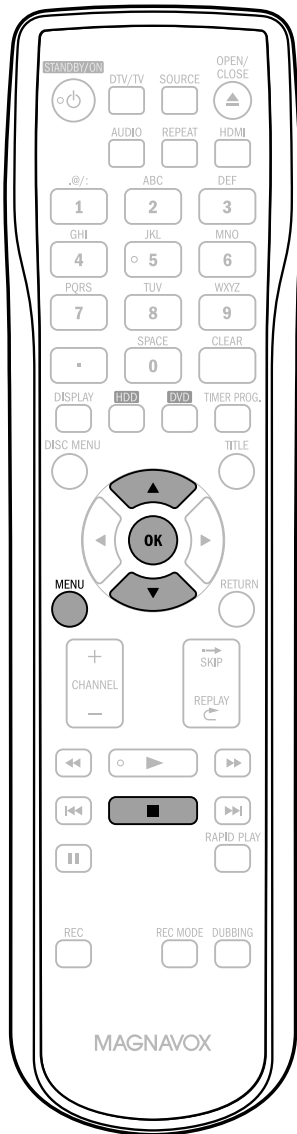

Press [STOP ■] if you are playing back a disc.

1 Press [MENU].

2 Use [▲/▼] to select "HDD Menu", then press [OK].

3 Use [▲/▼] to select the desired type of deletion, then press [OK].

Select "Delete All Unprotected Titles" to delete only unprotected titles.

Select "Delete All Titles" to delete all titles including protected titles.

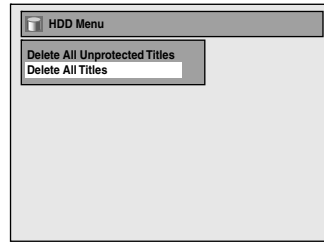

4 Use [▲/▼] to select "Yes", then press [OK].

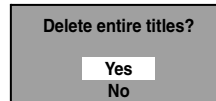

All titles are now deleted.

LIST OF SETTINGS

The following table is the contents which you can set and the default setting. Refer to the following table for useful operation.

Menu	Items (highlight is the default)		Contents		
General Setting	Playback → pages 104-107	Parental Lock	OFF level 8 [Adult] to 1 [Kid Safe]	Set the parental level for DVD playback.	
		Disc Audio	Dynamic Range Control	ON OFF	Compressing the range of sound volume.
			PCM	48kHz 96kHz	Set whether the sound recorded in 96kHz will be down sampled in 48kHz.
			Dolby Digital	PCM Stream	Set the type of sound signal which outputs from the digital audio output jack.
		Disc Menu Language		English French Spanish Other	Set the language for disc menu language.
		Audio Language		Original English French Spanish Other	Set the language for audio.
		Subtitle Language		OFF English French Spanish Other	Set the language for subtitles.
		Angle Icon		ON OFF	Set whether or not to display the angle icon.
		Still Mode		Auto Field Frame	Set the type of still image in pausing playback.
	Variable Skip/Replay		Variable Skip 5 seconds 15 seconds 30 seconds 1 minute 5 minutes	Set the amount of skip time when you press [SKIP →].	
			Variable Replay 5 seconds 15 seconds 30 seconds 1 minute 5 minutes	Set the amount of rewind time when you press [REPLAY ↶].	
	Display → pages 108-110	Language		English Français Español	Set the language for OSD (on-screen display).
		Screen Saver		OFF 1 minute 5 minutes 10 minutes 15 minutes	Set the idling time before the screen saver starts.
FL Dimmer		Auto Bright Dark	Set the brightness of the front panel display.		
DTV CC		Caption Service → page 38	OFF Service1 Service2 Service3 Service4 Service5 Service6	Set the type of the DTV closed caption.	
		Recording → page 43	ON OFF	Set whether to record the DTV closed caption or not.	
CC Style → pages 39-40		User Setting	ON OFF	Set the CC style setting whether or not it is effective.	
	Font Size	Large Middle Small	Set font size of the displayed caption.		

LIST OF SETTINGS

Menu	Items (highlight is the default)	Contents	
General Setting	Display → pages 108-110 CC Style → pages 39-40	Font Style Style1 Style2 Style3 Style4 Style5 Style6 Style7 Style8	Set font style of the displayed caption.
		Font Opacity Solid Transparent Translucent Flash	Set the font opacity of the displayed caption.
		Font Color White Black Red Green Blue Yellow Magenta Cyan	Set the font color of the displayed caption.
		Edge Type None Raised Depressed Uniform L.Shadow R.Shadow	Set edge type of the displayed caption.
		Edge Color White Black Red Green Blue Yellow Magenta Cyan	Set edge color of the displayed caption.
		Back Opacity Solid Transparent Translucent Flash	Set back opacity of the displayed caption.
		Back Color White Black Red Green Blue Yellow Magenta Cyan	Set back color of the displayed caption.
	V-Chip	MPA Rating X NC-17 R PG-13 PG G NR	Set the viewing limitation according to US movie ratings.
		TV Rating TV-MA TV-14 TV-PG TV-G TV-Y7 TV-Y None	Set the viewing limitation according to US TV program ratings.
		Canadian English Rating 18+ 14+ PG G C8+ C E	Set the viewing limitation according to Canadian English language ratings.
		Canadian French Rating 18ans+ 16ans+ 13ans+ 8ans+ G E	Set the viewing limitation according to Canadian French language ratings.

LIST OF SETTINGS

Menu	Items (highlight is the default)		Contents		
General Setting	Display → pages 108-110	V-Chip	Block Setting	To set the rating.	
		Downloadable Rating	Clear Downloadable Rating	Clear the downloadable rating information and its setting.	
		Change Password		Change the password.	
	Video → pages 111-112	Progressive Scan		ON OFF	To set the progressive scan mode (set to "ON") or the interlace scan mode (set to "OFF").
		TV Aspect		4:3 Letter Box 4:3 Pan & Scan 16:9 Wide	Set a picture size according to aspect ratio of your TV.
		Video Input → page 55	L1(Rear)	Video In S-Video In	Set the video input type for the external input.
	L2(Front)		Video In S-Video In		
	Recording	Auto Chapter → page 43		OFF 5 minutes 10 minutes 15 minutes 30 minutes 60 minutes	Insert chapter marks at a preset time interval's.
		Auto Finalize → page 65	Disc Full	ON OFF	Set the unit to finalize the disc automatically.
			End of Timer Rec	ON OFF	
Make Recording Compatible → page 43				ON OFF	Set to prohibit additional recording (OFF) or to replace the title list after recording (ON).
Clock → pages 32-34	Clock Setting			Set the clock.	
	Auto Clock Setting		OFF Auto Manual	Set the clock automatically.	
	Daylight Saving Time		ON(MAR-NOV) ON(APR-OCT) OFF	Set the clock for the daylight saving time.	
Channel → pages 29-31	Auto Channel Preset		Antenna Cable (Analog) Cable (Analog / Digital)	Tune the channels automatically.	
	Manual Channel Preset			Tune the channels manually.	
	TV Audio Select → page 37			Stereo SAP	Set the analog TV audio type for output and recording.
HDMI → pages 113-114	Format		RGB YCbCr	Set the color space for the HDMI output.	
	HDMI Audio		ON OFF	Set to output the HDMI audio signal. Set to "OFF" to not output the HDMI audio signal.	
	RGB Range		Normal Enhanced	Set the black-white contrast level for HDMI RGB output.	
	fun-Link (HDMI CEC)		ON OFF	Set to utilize fun-Link (HDMI CEC).	

Note

- Your change to each setting stays on even when the power is off.
- An item which is not currently available is grayed in the settings.

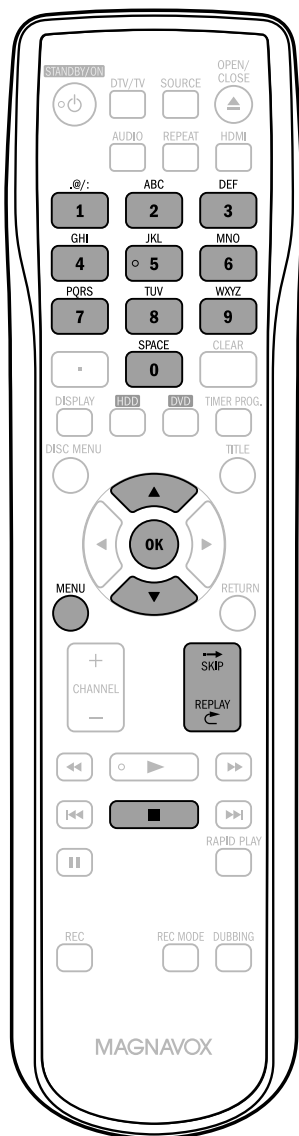

Press [STOP ■] if you are playing back a disc.

1 Press [MENU] and use [▲/▼] to select "General Setting", then press [OK].
"General Setting" menu will appear.

2 Use [▲/▼] to select "Playback", then press [OK].

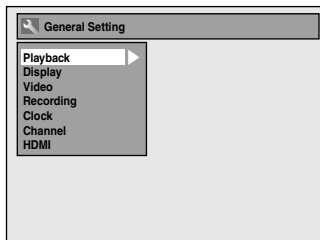

3 Use [▲/▼] to select a desired item, then press [OK].

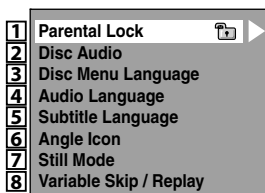

Submenu will appear.

4 Refer to **1** to **8** on pages 105-107 and set the selected item.

5 When you finish with the setting, press [MENU] to exit.

SETUPS

1 Parental Lock (Default: OFF) (DVD only)

Some DVD-videos feature a parental lock level. Playback will stop if the ratings exceed the levels you set, it will require you to enter a password before the disc will playback. This feature prevents your children from viewing inappropriate material.

Use **[▲/▼]** to select the desired level, then press **[OK]**.

Parental Lock	
<input checked="" type="checkbox"/>	OFF
<input type="checkbox"/>	8 [Adult]
<input type="checkbox"/>	7 [NC 17]
<input type="checkbox"/>	6 [R]
<input type="checkbox"/>	5 [PG R]
<input type="checkbox"/>	4 [PG 13]
<input type="checkbox"/>	3 [PG]
<input type="checkbox"/>	2 [G]
<input type="checkbox"/>	1 [Kid Safe]

If a password has not been set yet, proceed to **A**.

If a password has been set already, proceed to **B**.

Note

- Parental lock function may not be available to some discs.
- With some DVDs, it may be difficult to find if they are compatible with parental lock. Be sure to check if the parental lock function operates in the way that you have set.
- Record the password in case you forget it.
- If there is a DVD in the unit when you set up the parental lock, press **[OPEN/CLOSE ▲]** to activate the parental lock level.

A A password has not been set yet.

Use **[▲/▼]** to select "Yes". Use **[the Number buttons]** to enter a new password except for 4737, then press **[OK]**.

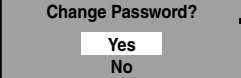

Change Password?
Yes
No

Yes → Password Input

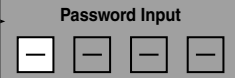

— — — —

Your setting will be activated.

B A password has been set already.

• Use **[the Number buttons]** to enter the current password.



Password Input

* * * —

Your setting will be activated.

• If you want to change password, use **[▲/▼]** to select "Yes". Use **[the Number buttons]** to enter a new password except for 4737, then press **[OK]**.

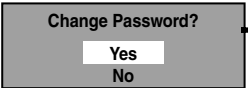

Change Password?
Yes
No

<change the password>

Yes → Password Input

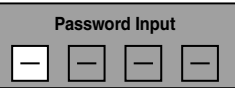

— — — —

Your setting will be activated.

Note

- Press **[CLEAR]** to erase numbers entered incorrectly.
- When you forget the password or you want to clear all settings in "Parental Lock" menu, enter 4737 using **[the Number buttons]** in password input window. Password will be cleared and parental levels will be set to "OFF".

Instructions continue on the next page.

SETUPS

2 Disc Audio

Choose the appropriate audio setting for your external device.

It will only affect disc playback.

Use [▲/▼] to select desired item, then press [OK].

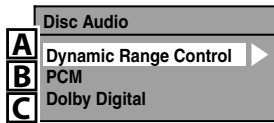

A Dynamic Range Control (Default : ON) (DVD only)

Set to "ON" to compress the range between soft and loud sounds.

Use [▲/▼] to select a setting, then press [OK].

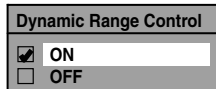

Your setting will be activated.

Note

- Dynamic range control function is available only with the titles which are recorded in the Dolby Digital format.

B PCM (Default : 48kHz)

Use [▲/▼] to select a setting, then press [OK].

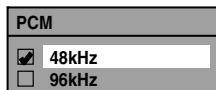

Your setting will be activated.

48kHz : If your amplifier/decoder is NOT compatible with 96kHz PCM, select "48kHz". 96kHz sound will be output in 48kHz.

96kHz : If your amplifier/decoder is compatible with 96kHz PCM, select "96kHz". 96kHz sound will be output.

Note

When playing back a disc with copyright protection

- Even if you select "96kHz", the sound will be down sampled at 48kHz.

C Dolby Digital (Default : Stream)

Use [▲/▼] to select a setting, then press [OK].

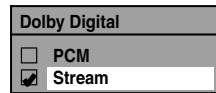

Your setting will be activated.

PCM : Converts the Dolby Digital into PCM (2 channel). When your amplifier/decoder is NOT compatible with Dolby Digital, set to "PCM".

Stream : Outputs Dolby Digital signals. When your amplifier/decoder is compatible with Dolby Digital, set to "Stream".

- With regard to DVD playback, if the audio source is in Dolby Digital format, set "Dolby Digital" to "PCM" so that you can switch to main audio (L), sub audio (R), or a combination of both (L/R) using your amplifier / decoder.

3 Disc Menu Language (Default : English) (DVD only)

Set the disc menu language.

Use [▲/▼] to select a setting, then press [OK].

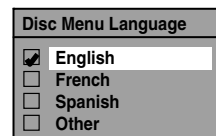

Your setting will be activated.

4 Audio Language (Default : Original) (DVD only)

Set the audio language.

Use [▲/▼] to select a setting, then press [OK].



Your setting will be activated.

- When "Original" is selected, the audio language will be in the disc's default language.

SETUPS

5 Subtitle Language (Default : OFF) (DVD only)

Set the subtitle language.

Use [▲/▼] to select a setting, then press [OK].

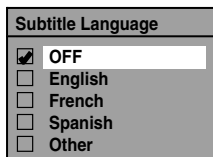

Your setting will be activated.

If "Other" is selected for **3** to **5**, press 4-digit code using [the Number buttons].

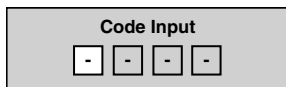

- When you finish entering the code, press [OK]. Refer to the language code table on page 120.

Note

- Only the languages supported by the disc can be selected.
- Audio language setting may not be available to some discs.
- You can change or switch off the subtitles on a DVD also from the disc menu if it is available.
- Press [CLEAR] or [◀] to erase numbers entered incorrectly.

6 Angle Icon (Default : ON) (DVD only)

Set to "ON" to show the angle icon during the playback.

Use [▲/▼] to select a setting, then press [OK].

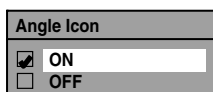

Your setting will be activated.

7 Still Mode (Default : Auto) (DVD only)

Select "Auto" usually.

Use [▲/▼] to select a setting, then press [OK].

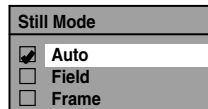

Your setting will be activated.

Auto : Optimum resolution setting ("Field" or "Frame") will be selected.

Field : Images in the still mode will be stabilized.

Frame : Images in the still mode will be highly defined.

Note

- Frame is 1 completed video image made up of 2 fields (There are 30 frames per second of NTSC video).

8 Variable Skip / Replay

Assign [SKIP →] or [REPLAY ←] to skip or rewind by a certain amount of time when they are pressed.

Use [▲/▼] to select a desired item, then press [OK].

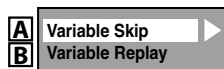

Refer to the explanations below and set the selected item.

A Variable Skip (Default: 30 seconds)

Sets the amount of skip time for [SKIP →].

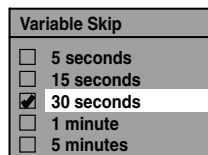

B Variable Replay (Default: 30 seconds)

Sets the amount of rewind time for [REPLAY ←].

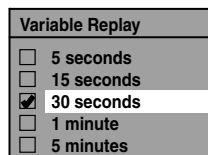

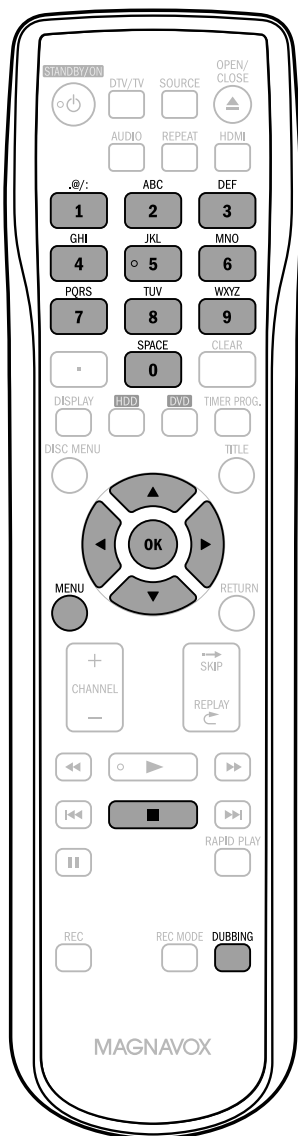

Press [STOP ■] if you are playing back a disc.

1 Press [MENU] and use [▲/▼] to select "General Setting", then press [OK].

2 Use [▲/▼] to select "Display", then press [OK].

3 Use [▲/▼] to select a desired item, then press [OK].

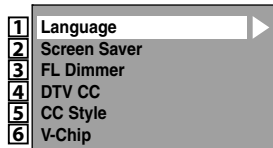

Selection menu will appear.

4 Refer to **1** to **6** on pages 108-110 and set the selected item.

• For **4** and **5** refer to pages 38-40.

5 When you finish with the setting, press [MENU] to exit.

1 Language (Default : English)

Set the language for the on-screen display.

Use [▲/▼] to select a setting, then press [OK].



Your setting will be activated.

2 Screen Saver (Default : 10 minutes)

Set the time to activate the screen saver function on the TV screen.

Use [▲/▼] to select a setting, then press [OK].

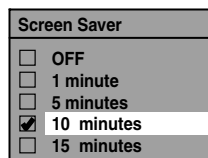

Your setting will be activated.

SETUPS

3 FL Dimmer (Default: Bright)

Set the front panel display brightness.

Use [▲/▼] to select a setting, then press [OK].

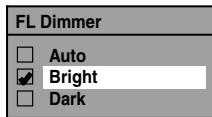

You can choose one from "Auto", "Bright" and "Dark". If "Auto" is selected, the display gets dark when the power is in the standby mode.

6 V-Chip

With the V-chip system in this unit, you can set the viewing limitation for the analog/digital TV programs received from the tuner or recorded on DVDs to prevent your children from watching inappropriate programs. If the unit detects a blocked program, a restriction message appears and you are not allowed to view or record the program.

1) Use [the Number buttons] to enter the access password.

If you have not set the password, first, use [the Number buttons] to set the access password, then press [OK]. The number you entered will be stored as the access password.



2) Use [▲/▼] to select a desired item, then press [OK].

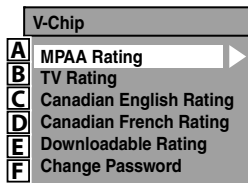

A MPAA Rating

B TV Rating

C Canadian English Rating

D Canadian French Rating

You can set the viewing limitation according to MPAA rating (US movie ratings), TV Rating (US TV program ratings), Canadian English Rating (Canadian English language Ratings), Canadian French Rating (Canadian French language Ratings).

1) Use [▲/▼] to select the desired rating, then press [OK] repeatedly to switch between view and block. When it is blocked a key icon will appear.

e.g.) MPAA rating

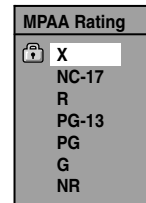

[MPAA Rating]

Rating	Category	
X	Mature audience only	higher
NC-17	No one under 17 admitted	↑
R	Restricted; under 17 requires accompanying parent or adult guardian	
PG-13	Unsuitable for children under 13	↓
PG	Parental guidance suggested	
G	General audience	lower
NR	No rating	

[TV Rating]

Rating	Category	
TV-MA	Mature audience only	higher
TV-14	Unsuitable for children under 14	↑
TV-PG	Parental guidance suggested	
TV-G	General audience	↓
TV-Y7	Appropriate for all children 7 and older	
TV-Y	Appropriate for all children	lower
None	No rating	

[Canadian English Rating]

Rating	Category	
18+	Adult audience only	higher
14+	Unsuitable for ages under 14	↑
PG	Parental guidance suggested	
G	General audience	↓
C8+	For children over 8	
C	For all children	lower
E	Exempt program	

Instructions continue on the next page.

SETUPS

[Canadian French Rating]

Rating	Category	
18ans+	Adult audience only	higher  lower
16ans+	Unsuitable for ages under 16	
13ans+	Unsuitable for ages under 13	
8ans+	Unsuitable for ages under 8	
G	General audience	
E	Exempt program	

As for TV Rating's TV-MA, TV-14, TV-PG, or TV-Y7, you can further set the sub ratings to block specific elements of programming. Press [**▲/▼**/**◀/▶**] to select the desired rating or sub rating, then press [**OK**] repeatedly to switch between view and block. Sub rating status will appear on the side of the main rating.

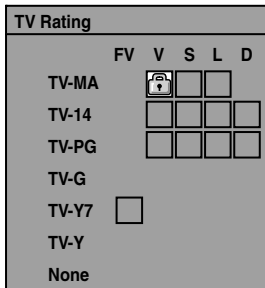

Sub Rating	Category	Rating
FV	Fantasy Violence	TV-Y7
V	Violence	TV-PG
S	Sexual Situation	TV-14
L	Coarse Language	TV-MA
D	Suggestive Dialogue	TV-PG, TV-14

Note

- Changing the main rating to block or view automatically changes all its sub ratings to the same (block or view).

E

Downloadable Rating

Set the rating system via digital broadcasting, or clear the downloaded ratings.

If the broadcasting signal does not have the downloadable rating information, the message below will appear.

Downloadable Rating is currently not available.

- This message will also appear when you try to access "Downloadable Rating" after you have cleared the downloadable rating information, and the new information has not been downloaded since.

To set the rating:

Use [**▲/▼**] to select "Block Setting" then press [**OK**] to show the various types of ratings. Use [**▲/▼**] to select a desired rating to set, then press [**OK**] to show the levels for the rating. Use [**▲/▼**] to select a level, then press [**OK**] to switch between view or block. If you set one level to block, a key icon will appear and all the higher levels will be blocked automatically.

To clear the downloadable rating information and its setting:

Use [**▲/▼**] to select "Clear Downloadable Rating", then press [**OK**].

F

Change Password

Change the current password.

Use [the Number Buttons] to enter new access password.

Note

- When you forget the access password (at step 1), enter 4737 using [**the Number buttons**] in the password input window. Password will be cleared.
- Depending on the type of rating system, you may set the levels individually.

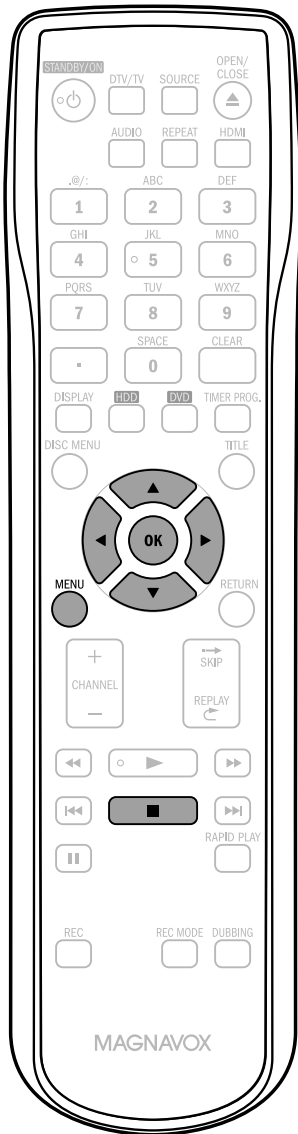

Press [STOP ■] if you are playing back a disc.

1 Press [MENU] and use [▲/▼] to select "General Setting", then press [OK].

2 Use [▲/▼] to select "Video", then press [OK].

3 Use [▲/▼] to select a desired item, then press [OK].

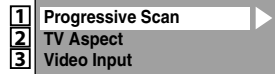

Submenu will appear.

4 Refer to **1** to **2** on page 112 and set the selected item.

• For **3** refer to page 55.

5 When you finish with setting, press [MENU] to exit.

Instructions continue on the next page.

SETUPS

1 Progressive Scan (Default : OFF)

This unit is compatible with the progressive scan system. The feature provides you with higher definition images than the traditional output system does. To utilize this feature, you must set progressive scan mode to "ON".

1) Use [▲ / ▼] to select "ON", then press [OK].

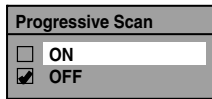

2) Use [◀ / ▶] to select "Yes", then press [OK].

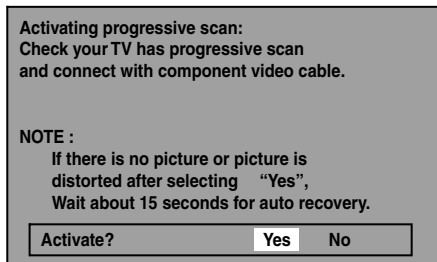

3) Use [▲ / ▼] to select "Yes" within 15 seconds, then press [OK].

Your setting will be activated.

Note

- If your TV is compatible with progressive scan (480p), you are recommended to use the HDMI or component video cable (commercially available) to connect this unit to the TV. (Refer to pages 17-18.) If not, use the RCA video cable and set the progressive scan to "OFF" or press and hold [MENU] for more than 3 seconds during HDD / DVD playback.
- When selecting "No" or not pressing any buttons on the unit or remote control within 15 seconds at step 3), progressive scan remains to be "OFF" (interlace scan).

2 TV Aspect (Default: 4:3 Letter Box)

Use this feature to adjust the aspect ratio of the video source which is different from your TV's ratio to fit your TV monitor without distorting the picture.

Use [▲ / ▼] to select a setting, then press [OK].

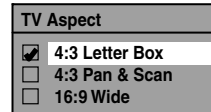

If you have a standard TV:

Select "4:3 Letter Box", so that black bars appear on the top and bottom of the TV screen when playing back a wide-screen picture. Select "4:3 Pan & Scan" for a full height picture with both sides trimmed when playing back wide-screen picture.

If you have a widescreen TV:

Select "16:9 Wide".

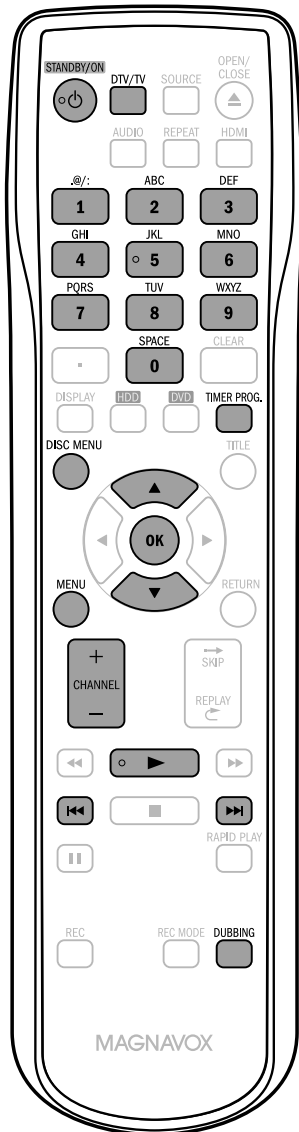

1 Press [MENU] in stop mode and use [▲/▼] to select "General Setting", then press [OK].

2 Use [▲/▼] to select "HDMI", then press [OK].



3 Use [▲/▼] to select a desired item, then press [OK].

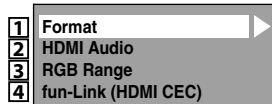

4 When you finish with the setting, press [MENU] to exit.

1 Format (Default : RGB)

You can select the color space for HDMI output. Set the appropriate color space for your display device.

Use [▲/▼] to select a setting, then press [OK].

- When the connected device is not compatible with the Y/Cb/Cr, HDMI signal is output as RGB regardless of the setting.

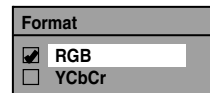

Your setting will be activated.

2 HDMI Audio (Default : ON)

If you do not want to output the audio through HDMI (Such as when you digitally output the audio through the COAXIAL DIGITAL AUDIO OUTPUT jack to your audio system, etc.), you can set the HDMI audio output off.

Use [▲/▼] to select a setting, then press [OK].

- Set to "OFF" when the HDMI sound is not output.

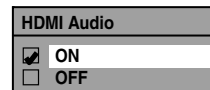

Your setting will be activated.

Instructions continue on the next page.

3 RGB Range (Default : Normal)

You can adjust the RGB range to make the dark areas of the HDMI images brighter.

Use **[▲ / ▼]** to select a setting, then press **[OK]**.

- Select "Enhanced" if the black-white contrast is not clear.
- This setting is effective only for HDMI RGB output.

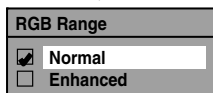

Your setting will be activated.

4 fun-Link (HDMI CEC) (Default : OFF)

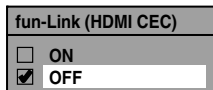

fun-Link (HDMI CEC) allows integrated system control over HDMI and is part of the HDMI standard.

When "fun-Link (HDMI CEC)" setting is set to "ON", functions listed below will be available.

One Touch Play

When this unit is turned on, the TV also is turned on and the appropriate external input channel will be selected automatically. The appropriate external input channel can also be selected on your TV automatically, when you press **[PLAY ▶]**, **[▶▶]**, **[◀◀]**, **[DISC MENU]**, **[TIMER PROG.]**, **[DTV/TV]**, **[MENU]**, **[CHANNEL + / -]**, **[the Number buttons]** or **[DUBBING]** when the unit's power is on.

Standby

When you press and hold **[STANDBY/ON ⏻]** for 2 seconds, it turns off the power to the standby mode of the TV first and then turns the power of this unit also.

System Information

Get & Set Menu Language



This unit recognizes the language set for the TV and automatically sets the same language as the player menu language for this unit.

TROUBLESHOOTING

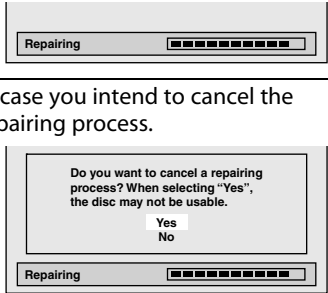
Before requesting service for this unit, check the table below for a possible cause of the problem you are experiencing. Some simple checks or a minor adjustment on your part may eliminate the problem and restore proper operation.

	Symptom	Remedy
POWER	The power does not turn on.	<ul style="list-style-type: none"> • Check that the AC power cord is connected securely. • Batteries of the remote control are weak.
	The unit turns on automatically without any operation.	<ul style="list-style-type: none"> • The unit turns on automatically 2 seconds before the timer recording.
	"Language" menu appears every time the power turns on.	<ul style="list-style-type: none"> • The unit may not have been turned off correctly. Finish up the language setting procedure by selecting a language in "Language" menu. Press [OK] to activate the setting, then press [STANDBY/ON ⏻] to turn the unit to the standby mode. Do not disconnect the AC power cord before placing the unit in the standby mode.
GENERAL	The unit does not function.	<ul style="list-style-type: none"> • "⊘" or error message appears if the operation is prohibited. • Batteries of the remote control are weak or exhausted.
	No picture, sound or menu appears on the screen.	<ul style="list-style-type: none"> • Check if the connections are made securely and correctly. • Check if the cables are damaged. • Check if a correct external input channel is selected on your TV. (Refer to page 22.) • Check if you have completed the channel setting. (Refer to pages 29-31.) • While the setup menu or timer programming display is shown, or while the screen saver is active, the audio is muted.
	Clock setting and channel setting cannot be performed.	<ul style="list-style-type: none"> • If a recording is in progress, these operations cannot be performed.
	Time jumps/Auto Clock set's incorrect time.	<ul style="list-style-type: none"> • Set the "Auto Clock Setting" to "OFF" on page 103 and try "Manual Clock Setting" on page 34.
	The unit does not operate properly.	<ul style="list-style-type: none"> • Moisture has condensed inside the unit. Remove the disc and leave the unit turned on for about 2 hours until the moisture evaporates. (Refer to page 3.)
	"Repairing" appears on the TV screen.	<ul style="list-style-type: none"> • If there is a power failure or unplugging during recording, finalizing, formatting or editing (even after "Repairing" disappears), a repairing process will begin automatically just after turning the unit on again. It may take several minutes up to several hours.
	In case you intend to cancel the repairing process.	<ul style="list-style-type: none"> • If you intend to cancel the repairing process, press [▲ OPEN/CLOSE] on the front panel, then select "Yes" and press [OK]. After that, press [OPEN/CLOSE ▲] to take out the disc. The disc canceled during the repairing process MAY NOT work.
		
	The clock display does not appear in the front panel display.	<ul style="list-style-type: none"> • Check that the AC power cord is connected securely. • (In case of power failure) Check the breaker and clock setting.
	When you forget the password for parental lock.	<ul style="list-style-type: none"> • Please cancel the password and the set level. (Refer to page 105.)
No analog TV closed captions are output.	<ul style="list-style-type: none"> • If you are using HDMI connection to watch the TV programs through this unit, analog TV closed caption cannot be output. Try using another output connection to the TV. 	
DV signal cannot be input.	<ul style="list-style-type: none"> • Before connection, turn on the power supplies for both this unit and the DVC, and make sure that these units have stopped. • Only a "DVC-SD" signal can be input from the DVC to this unit. Other types of signals are not supported. • Do not connect any device other than the DVC. Even if a recorder or PC with another DV terminal is connected, the DV function will not operate. • If the DVC is not recognized after connection, turn off the power supply for the unit and re-connect the DVC. 	
The DVC cannot be operated with this unit.	<ul style="list-style-type: none"> • Signal input or DVC operation from this unit may be disabled depending on the type of DVC. • If a DVC signal cannot be input, use an external input (L1/L2) for analog connection via audio/video cables. • DVC control may be disabled depending on the type of DVC, even in a mode other than camera mode. In this case, switch to HDD/DVD control and execute the normal recording procedure while operating the DVC. 	

TROUBLESHOOTING

	Symptom	Remedy	
GENERAL	Certain functions of the DVC cannot operate.	<ul style="list-style-type: none"> Some functions may not operate depending on the type of DVC. For example, if the DVC does not support slow playback mode, the slow playback function is disabled. With L3(DV-IN), the disc display menu does not appear unless disc playback is executed. 	
	DV audio signal cannot be switched.	<ul style="list-style-type: none"> For recording with the DVC, the recording audio signal can be set to 12 bits or 16 bits. However, when 16-bit recording mode is selected, audio signal cannot be switched. To record an audio signal, set it to 12 bits. 	
	No image from HDMI connection.	<ul style="list-style-type: none"> Check the HDMI connection. (Check the status of the HDMI related indications.) Check whether the connected monitor device or other device supports HDCP. (This unit will not output a video signal unless the other device supports HDCP.) Check the setting of HDMI. Check whether the output format of this unit (HDMI FORMAT) matches the supported input format of other connected device. 	
	Setup menu cannot be called up.	<ul style="list-style-type: none"> Setup menus cannot be called up during DVD recording. 	
CHANNEL	TV channels cannot be changed.	<ul style="list-style-type: none"> Check if the connections are made securely and correctly. Check if the cables are damaged. Try channel setting by following the steps on pages 29-31. 	
	Only specific channels do not appear.	<ul style="list-style-type: none"> The channels may be set to be skipped. (Refer to pages 30-31.) 	
	The external input channels (such as L1, L2 or L3) cannot be skipped.	<ul style="list-style-type: none"> This unit does not skip the external input channels. This is not a malfunction. 	
RECORDING	GENERAL	The image from the external device cannot be displayed or recorded.	<ul style="list-style-type: none"> Try pressing [SOURCE] repeatedly. Turn on all connected devices. Check if the connections are made securely and correctly.
		HDD / DVD	Recording is impossible.
	Timer recording cannot be performed.		<ul style="list-style-type: none"> The internal clock of the unit may have been stopped due to a power failure that lasted for more than 1 hour. Reset the clock. (Refer to pages 32-34.)
	The picture of the autostart recording disappears.		<ul style="list-style-type: none"> The contents of the autostart recording will be cleared in some cases (Changing input channel etc.). Refer to page 46.
	HDD	When playing back the title recorded from the autostart recording, the DTV program information is displayed and it cannot be disappeared.	<ul style="list-style-type: none"> In the autostart recording, when you display the DTV program information, the information will be recorded as the part of the picture.
	DVD	Recording is impossible.	<ul style="list-style-type: none"> Copy-once programs cannot be recorded on DVD. This is not a malfunction. Check if the disc is protected or finalized. Undo the protection or the finalization. DVD-RW once formatted on other unit cannot be recorded on this unit unless all the contents in the disc are erased. Check if the connections are made securely and correctly.
		The indication " Writing to Disc  100% "	<ul style="list-style-type: none"> " Writing to Disc  100% " may remain on screen for the maximum of 20 seconds even after it reached 100%. This is not a malfunction.
		does not disappear.	

TROUBLESHOOTING

	Symptom	Remedy	
GENERAL	TV aspect ratio does not match your TV screen.	<ul style="list-style-type: none"> • Check the TV aspect ratio. (Refer to page 112.) • A different aspect ratio will be used when the aspect ratio specified by the disc is not supported by this unit. 	
	Playback picture is distorted. Color of the picture is abnormal.	<ul style="list-style-type: none"> • During fast forward or fast reverse, playback picture may be distorted. This is not a malfunction. • Connect to TV directly. When you connect this unit with the television via VCR or other devices, the picture may be distorted due to the copy-protection signal. • Check if the cables are damaged. • Keep the equipment which may cause electrical disturbances, such as a cellular phone, away. 	
	There is no sound, or no subtitle.	<ul style="list-style-type: none"> • Turn on all connected devices. • Check if the external input channel is set correctly. • Check if the connections are made securely and correctly. • If using the HDMI connection, sound is not output when "HDMI Audio" is set to "OFF". • Check the RCA audio cable connection. If you are using HDMI-DVI conversion cable, you must connect the RCA audio cable, too. • If using the HDMI connection, check whether the output format of this unit (HDMI FORMAT) matches the supported input format of other connected device. 	
PLAYBACK	HDD/DVD	Playback does not start from the beginning.	<ul style="list-style-type: none"> • Resume function may be activated. Refer to page 73 to cancel the resume point.
	HDD	HDD playback suddenly stops.	<ul style="list-style-type: none"> • When DVD recording finishes during HDD playback, the unit will stop the HDD playback, and start writing data to the DVD. This is not a malfunction.
	DVD	Playback cannot be performed.	<ul style="list-style-type: none"> • Check if the playable disc is inserted. • Check if the disc is loaded correctly with the labeled side facing up. • Discs made on other devices or on personal computers cannot be played back on this unit unless it is finalized on the device. Even if it is finalized, the performance of those discs are not guaranteed on this unit. • The disc may be dirty or flawed. Clean the disc. • Check if all the connections are made correctly. • Check the parental lock setting. (Refer to page 105.) • Playback of DVD is prohibited from 2 minutes before the programmed start time of a timer recording when the recording media is DVD.
		There is no sound, or no subtitle.	<ul style="list-style-type: none"> • Check if "Disc Audio" is set correctly. (Refer to page 106.) • There is a possibility that the selected subtitle language is not supported by the disc.
		Digital audio setting cannot be changed to main audio (L), sub audio (R) or combination of both.	<ul style="list-style-type: none"> • If the audio source is in the Dolby Digital format, set the Dolby Digital Setting to "PCM" in "Playback" menu. (available only for DVD) (Refer to page 106.)
		Audio language or the subtitle language of the DVD cannot be changed.	<ul style="list-style-type: none"> • Multilingual subtitles are not supported by the disc. • Some audio languages or the subtitle languages can be changed only from the disc menu. Please refer to the disc's manual.
		Camera angles cannot be changed.	<ul style="list-style-type: none"> • Even though the multi-angle feature is supported by the disc, that does not mean all the scenes are shot from multi-angles. Changing angles are available only for those scenes shot from the multi-angle.
The disc cannot be played back on another player even though it is finalized properly.	<ul style="list-style-type: none"> • Some DVD players do not play back the disc made on another recorder. Refer to the manual of the unit. 		

Introduction

Connections

Basic Setup

Recording

Playback

Editing

Function Setup

Others

Español

TROUBLESHOOTING

		Symptom	Remedy
EDITING	HDD / DVD	Titles cannot be edited or deleted.	<ul style="list-style-type: none"> The titles or the disc itself may be protected. Cancel the protection by following the steps on page 94 for title protection and page 63 for disc protection.
		Dubbing cannot be executed.	<ul style="list-style-type: none"> When the number of the titles or the chapters exceeds the maximum recordable number, the dubbing will not be executed. Dubbing of a "copy-once only" program is not possible with this unit.
	DVD	Titles cannot be edited or deleted.	<ul style="list-style-type: none"> The titles in the DVD+R/-R cannot be edited or deleted if they are finalized. If it is DVD-RW, undo the finalization by following the steps on page 64.
		The capacity of the disc doesn't increase even if the recorded program is deleted.	<ul style="list-style-type: none"> With DVD+RW/-RW, the disc space will increase only when the last title is deleted. With DVD-R/+R, deleting a title will not increase the disc space.
		Dubbing cannot be executed.	<ul style="list-style-type: none"> Check if the disc is compatible for recording (refer to page 41).
REMOTE CONTROL		The remote control does not function.	<ul style="list-style-type: none"> No batteries in the remote or the batteries may be weak. Replace the batteries. Make sure there is no obstacle between the remote and the unit. Try getting closer to the unit. (Refer to page 12.) If above solutions do not solve the problem, please call an Authorized Service Center.

TROUBLESHOOTING

Error Message

Error message	Cause	Solution
Disc Error — Please eject the disc. — Playback feature may not be available on this Disc.	<ul style="list-style-type: none"> Unplayable disc is inserted in the unit. The disc is upside down. 	<ul style="list-style-type: none"> Insert the standardized disc which bear the marks on page 66. Insert the disc with the labeled side facing up.
Region Error — Please eject the disc. — Playback is not authorized in your region.	<ul style="list-style-type: none"> Playback is not authorized in the region of the DVD-video which you inserted in the unit. 	<ul style="list-style-type: none"> Insert the DVD-video with region codes 1 or ALL.
Parental Lock On The current selected parental level prohibits playback.	<ul style="list-style-type: none"> The current selected parental level prohibits playback. 	<ul style="list-style-type: none"> Check "Parental Lock" setting in "Playback" menu (page 105).
Recording Error This program is not allowed to be recorded.	<ul style="list-style-type: none"> The recording function encountered the copy prohibited program. 	<ul style="list-style-type: none"> You cannot record copy prohibited programs.
Recording Error This program is not recordable in +VR mode.	<ul style="list-style-type: none"> You are trying to record the copy-once program. 	<ul style="list-style-type: none"> You cannot record the copy-once program.
Recording Error Cannot record on this disc.	<ul style="list-style-type: none"> You are trying to record onto the disc which is unrecordable, or the disc status is unable to record. The disc is dirty. The disc is damaged. 	<ul style="list-style-type: none"> Insert the recordable disc, and ensure the disc status satisfies the recording requirements (page 41). Clean the disc with a cleaning cloth. Replace the disc.
Recording Error This disc is protected and not recordable.	<ul style="list-style-type: none"> You are trying to record on to the protected disc which is set in "Disc Edit" menu. 	<ul style="list-style-type: none"> Release the disc protect setting in "Disc Edit" menu (page 63).
Recording Error Disc is full. (No area for new recording)	<ul style="list-style-type: none"> You are trying to record onto the disc which has no space for recording. 	<ul style="list-style-type: none"> Insert the recordable disc with enough recording space.
Recording Error You cannot record more than 49 titles on one disc. (The maximum is 49)	<ul style="list-style-type: none"> You are trying to record onto the disc on which the number of recording titles comes up to the maximum (49). 	<ul style="list-style-type: none"> Delete unnecessary titles (pages 84-85).
Recording Error You cannot record more than 254 chapters on one disc. (The maximum is 254)	<ul style="list-style-type: none"> You are trying to record onto the DVD+RW or DVD-RW on which the number of recording chapters comes up to the maximum (254). 	<ul style="list-style-type: none"> Delete unnecessary chapter marks (pages 89-90).
Recording Error You cannot record on this disc as Power Calibration Area is full.	<ul style="list-style-type: none"> When recordings are performed repeatedly onto an unstable disc, this area may come up to be full. Every time you insert a disc for recording, the disc's working area will be taken up. And if you repeat this frequently, it will be used up sooner and you may not be able to record full 49 titles. 	<ul style="list-style-type: none"> Insert a new disc.
Recording Error This disc is already finalized.	<ul style="list-style-type: none"> You are trying to record onto the disc already finalized. 	<ul style="list-style-type: none"> Release the finalizing for this disc (page 64).
Recording Error The disc has no recording compatibility. Set "Make Recording Compatible" to "ON" to convert the disc.	<ul style="list-style-type: none"> You are trying to record onto the disc that had been recorded by other recorders. 	<ul style="list-style-type: none"> Set "Make Recording Compatible" to "ON" to rewrite the menu, after that you will record to disc (page 43).
Recording Error You cannot record more than 600 titles on HDD. (The maximum is 600).	<ul style="list-style-type: none"> You are trying to record onto the HDD when total title number is already at its limit. 	<ul style="list-style-type: none"> Delete unnecessary titles (pages 84-86).
Recording Error Cannot record on this HDD.	<ul style="list-style-type: none"> The internal HDD is dirty or damaged. There is not enough space on the internal HDD. 	<ul style="list-style-type: none"> Contact the customer service center. Delete unnecessary titles (pages 84-86).

* If you are still having trouble with the unit after checking "TROUBLESHOOTING", write down the error code and the error description for calling our help line mentioned on the front page to locate an Authorized Service Center.

LANGUAGE CODE

Language	Code
Abkhazian	4748
Afar	4747
Afrikaans	4752
Albanian	6563
Amharic	4759
Arabic	4764
Armenian	5471
Assamese	4765
Aymara	4771
Azerbaijani	4772
Bashkir	4847
Basque	5167
Bengali;Bangla	4860
Bhutani	5072
Bihari	4854
Bislama	4855
Breton	4864
Bulgarian	4853
Burmese	5971
Byelorussian	4851
Cambodian	5759
Catalan	4947
Chinese	7254
Corsican	4961
Croatian	5464
Czech	4965
Danish	5047
Dutch	6058
English	5160
Esperanto	5161
Estonian	5166
Faroese	5261
Fiji	5256
Finnish	5255
French	5264
Frisian	5271
Galician	5358
Georgian	5747
German	5051
Greek	5158
Greenlandic	5758
Guarani	5360
Gujarati	5367
Hausa	5447
Hebrew	5569
Hindi	5455

Language	Code
Hungarian	5467
Icelandic	5565
Indonesian	5560
Interlingua	5547
Interlingue	5551
Inupiak	5557
Irish	5347
Italian	5566
Japanese	5647
Javanese	5669
Kannada	5760
Kashmiri	5765
Kazakh	5757
Kinyarwanda	6469
Kirghiz	5771
Kirundi	6460
Korean	5761
Kurdish	5767
Laothian	5861
Latin	5847
Latvian; Lettish	5868
Lingala	5860
Lithuanian	5866
Macedonian	5957
Malagasy	5953
Malay	5965
Malayalam	5958
Maltese	5966
Maori	5955
Marathi	5964
Moldavian	5961
Mongolian	5960
Nauru	6047
Nepali	6051
Norwegian	6061
Occitan	6149
Oriya	6164
Oromo (Afan)	6159
Panjabi	6247
Pashto; Pushto	6265
Persian	5247
Polish	6258
Portuguese	6266
Quechua	6367
Rhaeto-Romance	6459
Romanian	6461

Language	Code
Russian	6467
Samoan	6559
Sangho	6553
Sanskrit	6547
Scots Gaelic	5350
Serbian	6564
Serbo-Croatian	6554
Sesotho	6566
Setswana	6660
Shona	6560
Sindhi	6550
Singhalese	6555
Siswat	6565
Slovak	6557
Slovenian	6558
Somali	6561
Spanish	5165
Sundanese	6567
Swahili	6569
Swedish	6568
Tagalog	6658
Tajik	6653
Tamil	6647
Tatar	6666
Telugu	6651
Thai	6654
Tibetan	4861
Tigrinya	6655
Tonga	6661
Tsonga	6665
Turkish	6664
Turkmen	6657
Twi	6669
Ukrainian	6757
Urdu	6764
Uzbek	6772
Vietnamese	6855
Volapuk	6861
Welsh	4971
Wolof	6961
Xhosa	7054
Yiddish	5655
Yoruba	7161
Zulu	7267

Analog Audio

An electrical signal that directly represents sound. Compare this to digital audio which can be an electrical signal, but is an indirect representation of sound. See also "Digital Audio".

Aspect Ratio

The width of a TV screen relative to its height. Conventional TVs are 4:3 (in other words, the TV screen is almost square); widescreen models are 16:9 (the TV screen is almost twice as wide as it is high).

Chapter (HDD/DVD)

Just as a book is split up into several chapters, a title on HDD/DVD is usually divided into chapters. See also "Title".

Component Video Output

Each signal of luminance (Y) and component (P_B/C_B, P_R/C_R) is independent to output so that you can experience picture color as it is.

Also, due to compatibility with progressive video (480p), you can experience higher-density picture than that in interlace (480i).

Digital Audio

An indirect representation of sound by numbers. During recording, the sound is measured at discrete intervals (44,100 times a second for CD audio) by an analog-to-digital converter, generating a stream of numbers. On playback, a digital-to-analog converter generates an analog signal based on these numbers. See also "Sampling Frequency" and "Analog Audio".

Dolby Digital

The system to compress digital sound developed by Dolby Laboratories. It offers you sound of stereo(2ch) or multi channel audio.

Finalize

To make DVD, which have been recorded on, possible to play back in DVD players. With this unit, it is possible to finalize DVD+R, DVD-RW, and DVD-R.

HDMI (high definition multimedia interface)

A digital interface between audio and video source. It can transmit component video, audio, and control signal with one cable connection.

JPEG (joint photographic experts group)

JPEG is a method of compressing still image files. You can copy JPEG files on CD-RW/-R from a computer and play back the files on this unit.

MP3 (MPEG audio layer 3)

MP3 is a method of compressing files. You can copy MP3 files on CD-RW/-R from the computer and play back the files on this unit.

PBC (playback control) (video CD only)

This function enables you to play back interactive software using a menu screen. See also "Video CD".

PCM (pulse code modulation)

The most common system of encoding digital audio, found on CD and DAT. Excellent quality, but requires a lot of data compared to formats such as Dolby Digital and MPEG audio. For compatibility with digital audio recorders (CD, MD and DAT) and AV amplifiers with digital inputs, this unit can convert Dolby Digital and MPEG audio to PCM. See also "Digital Audio".

Progressive Scan (480p)

A type of display that does not split each frame into fields, and instead scans directly through all the scan lines of each frame in order. Progressive scan provides less flickering and higher image resolution than traditional (480i) TV signals. Refer to page 112 for instructions on selective progressive scan mode.

Region Code

Regions associate discs and players with particular areas of the world. This unit will only play back discs that have compatible region codes. You can find the region code of your unit by looking on the rear panel. Some discs are compatible with more than one region (or all regions).

Sampling Frequency

The rate which sound is measured by a specified interval to turn into digital audio data. The numbers of sampling in one second defines as sampling frequency. The higher the rate, the better the sound quality.

SAP (secondary audio program)

Sub-audio channel which is delivered separately from main-audio channel. This audio channel is used as an alternate in bilingual broadcasting.

S-Video Output

It delivers independently each signal of color(C) and luminance(Y) to TV as video signals, so that higher-quality picture will be gained.

Title (HDD/DVD)

A collection of chapters on HDD/DVD. See also "Chapter".

Track

Audio CD use tracks to divide up the content of a disc. The DVD equivalent is called a chapter. See also "Chapter".

Video CD

A digital format for store video data in compact disc.

SPECIFICATIONS

General

HDD	Internal 3.5 inch HDD 500 GB
Power requirements	120V AC +/- 10%, 60Hz +/- 5%
Power consumption	33W (standby: 5.7W)
Dimensions (width x height x depth)	16.6 x 2.4 x 11.5 inches (420 x 59 x 290mm)
Weight	7.50 lbs. (3.40kg)
Operating temperature	41°F (5°C) to 104°F (40°C)
Operating humidity	Less than 80% (no condensation)
TV system	ATSC/NTSC-M TV standard

Recording

Recording format	+VR (video recording) format
Recording discs	DVD+Rewritable, DVD+Recordable DVD-Rewritable, DVD-Recordable (+VR mode only)

Video recording format

Sampling frequency	13.5 MHz
Compression format	MPEG 2

Audio recording format

Sampling frequency	48 kHz
Compression format	Dolby Digital

Tuner

Tuning system	Channel frequency synthesized tuning system
---------------	---

Channel coverage (ATSC / NTSC)

Terrestrial	VHF 2~13, UHF 14~69
Cable	2~13, A~W, W+1~W+94 (analog W+1~W+84), A-5~A1, 5A

Terminals

Front	Audio input			
	RCA jack x 2	2V rms (input impedance: more than 22kΩ)		
	Video input			
	RCA jack x 1	1Vp-p (75Ω)		
	S-video input			
	Mini DIN 4-pin x 1	Y: 1Vp-p (75Ω)	C: 286mVp-p (75Ω)	
	DV input			
	DV input jack (4 pin)	IEEE 1394		
Rear	VHF/UHF/Cable TV input and output			
	F-type	75Ω unbalanced		
	Audio input			
	RCA jack x 2	2V rms (input impedance: more than 22kΩ)		
	Audio output			
	RCA jack x 2	2V rms (output impedance: more than 1kΩ)		
	Video input			
	RCA jack x 1	1Vp-p (75Ω)		
	Video output			
	RCA jack x 1	1Vp-p (75Ω)		
	S-video input			
	Mini DIN 4-pin x 1	Y: 1Vp-p (75Ω)	C: 286mVp-p (75Ω)	
	S-video output			
Mini DIN 4-pin x 1	Y: 1Vp-p (75Ω)	C: 286mVp-p (75Ω)		
Component video output				
RCA jack x 3	Y: 1Vp-p (75Ω)	PB/CB: 700mVp-p (75Ω)	PR/CR: 700mVp-p (75Ω)	
Coaxial digital audio output				
RCA jack x 1	500mVp-p (75Ω)			
HDMI output				
HDMI jack x 1				

Note

- The specifications and design of this product are subject to change without notice.

Discos Reproducibles

Este aparato es compatible con la reproducción de los siguientes discos y archivos.

Discos reproducibles	Logotipos
DVD-video	
DVD+RW	
DVD+R	
DVD-RW (Sólo discos en modo de video finalizados)	
DVD-R (Sólo discos en modo de video finalizados)	
CD-DA (CD de audio)	
CD de video	 
CD-RW	 
CD-R	 
KODAK Picture CD	

Archivos reproducibles	Soportes
MP3	CD-RW/-R
JPEG	

 es una marca registrada de DVD Format/Logo Licensing Corporation.

Códigos de Región

El número presente en el interior del globo se refiere a una región del mundo. Este aparato puede reproducir discos DVD que estén rotulados para ALL las regiones o para la región 1.







Disco Grabable

Este aparato puede grabar a DVD+RW, DVD+R, DVD-RW y DVD-R.

Los discos DVD+R/DVD-R pueden ser grabados sólo una vez. Los discos DVD+RW/DVD-RW pueden ser grabados y borrados muchas veces.

En este aparato los discos DVD-RW/-R serán grabados automáticamente en el modo DVD+VR.

Logotipos	Atributos
 	Disco de 8 cm / 12 cm, un solo lado, una sola capa Tiempo de grabación máx. aprox. (modo SLP): 360 minutos (4,7 GB) (para 12 cm) 108 minutos (1,4 GB) (para 8 cm)
DVD+RW DVD+R	
 	Disco de 8 cm / 12 cm, un solo lado, una sola capa Tiempo de grabación máx. aprox. (modo SLP): 360 minutos (4,7 GB) (para 12 cm) 108 minutos (1,4 GB) (para 8 cm)
DVD-RW DVD-R	

- Los siguientes discos se recomiendan para obtener una buena calidad de grabación y han sido comprobados como compatibles con este aparato. Sin embargo, según sea la condición del medio el equipo podría no leer el disco correctamente.

Verbatim	DVD+R 8x, DVD-R 8x,	DVD+RW 4x, DVD-RW 2x
JVC	DVD-RW 4x	
Maxell	DVD+R 4x/8x/16x,	DVD-R 8x/16x
SONY	DVD+R 4x/8x/16x,	DVD+RW 4x
TDK	DVD+R 4x/8x/16x	

El comportamiento de cualquier otro disco no está garantizado.

- Usted puede reproducir discos DVD+RW en la mayoría de los reproductores de DVD sin finalizarlos. Sin embargo, si usted ha añadido o eliminado capítulos, u ocultado capítulos, debe ejecutar "Compatibilizar edic." antes de poder ver dichos efectos en otros equipos. (Consulte la página 99.) Para reproducir discos que no sean DVD+RW en otros reproductores de DVD, usted necesitará finalizarlos.**

Disco no Grabable

- Un DVD-RW grabado en un modo distinto de +VR no será grabable en este aparato a menos que usted borre todo el contenido del disco. (Consulte la página 98.)
- Un DVD-R grabado en un modo distinto de +VR no será grabable en este aparato.

Conexión Básica

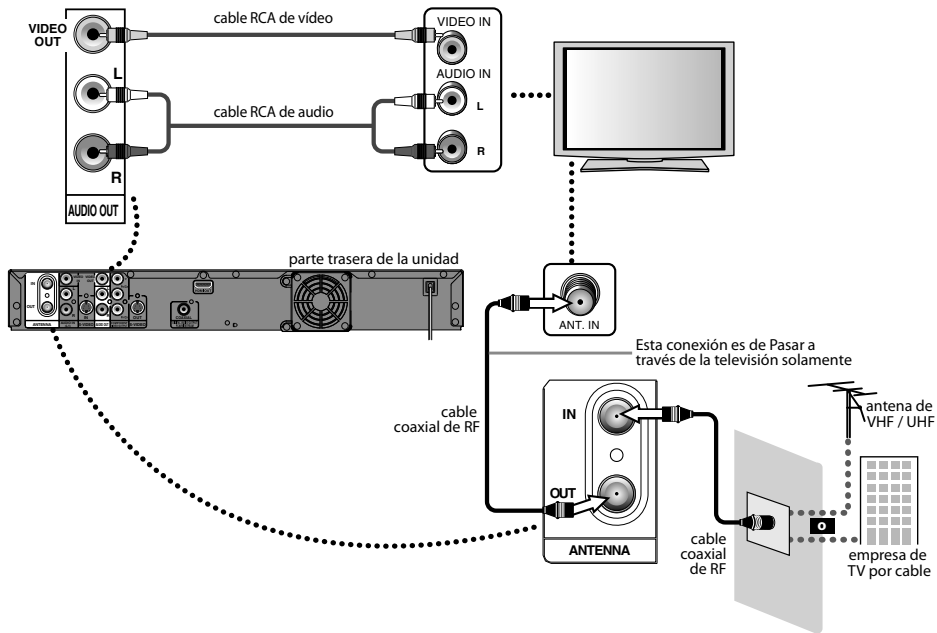

Cables suministrados:

- cable coaxial de RF x 1
 - cable RCA de audio (L/R) x 1
 - cable RCA de vídeo x 1
- Por favor, compre el resto de los cables necesarios en su tienda local.

Conexión a un Televisor con un Puerto Compatible con HDMI

- HDMI emite las señales de video / audio sin convertirlas en señales analógicas.
- No es necesaria una conexión de audio.

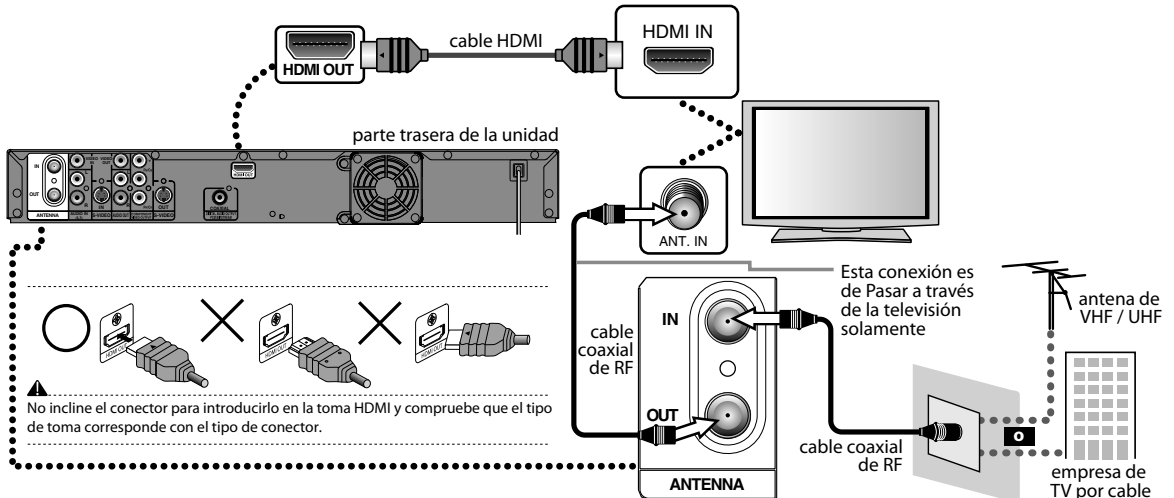

Cables suministrados:

- cable coaxial de RF x 1
- Por favor, compre el resto de los cables necesarios en su tienda local.

Modo HDMI y señales efectivas de salida

Presione **[HDMI]** para seleccionar el modo de salida HDMI. Cada vez que se presiona **[HDMI]** el modo de salida varía como sigue.

Pantalla del panel frontal	Señal de salida de video
480P	Progresivo de 480
Presione [HDMI] ↓	
720P	Progresivo de 720
Presione [HDMI] ↓	
1080i	1080 entrelazado
Presione [HDMI] ↓	
1080P	Progresivo de 1080
Presione [HDMI]	

- El modo HDMI que no esté admitido por el dispositivo de exhibición será pasado por alto.

Configuración Inicial

Cuando usted encienda este aparato por primera vez necesita seguir estos pasos.

1 Presione **[STANDBY/ON ⏻]**.
Encienda el televisor. Seleccione la entrada a la cual está conectado el aparato.

2 Utilice **[▲/▼]** para seleccionar su idioma deseado, y luego presione **[OK]** para establecerlo.

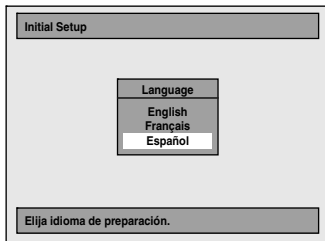

3 Utilice **[▲/▼]** para seleccionar el tipo de señal de emisión, y luego presione **[OK]**.

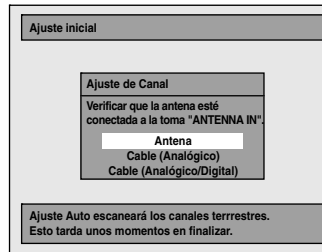

El equipo comenzará a obtener los canales disponibles en su región.

4 Utilice **[◀/▶]** para seleccionar un elemento a configurar, y utilice **[▲/▼]** para seleccionar el contenido de su preferencia, y luego presione **[OK]**.

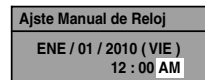

Reproducción Directa

Si usted está reproduciendo los títulos de una unidad de disco rígido, presione primero [HDD] y luego continúe al paso 2.
Si usted está reproduciendo los títulos de un DVD, presione primero [DVD].

- 1** Presione [OPEN/CLOSE ▲] para abrir la bandeja de discos e insertar su disco con el rótulo apuntando hacia arriba. Presione de nuevo [OPEN/CLOSE ▲] para cerrar la bandeja de discos.

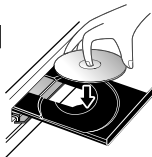

* Asegúrese de que el disco sea compatible con este aparato. (Para obtener la lista de discos compatibles consulte la página 123.)

- 2** Para iniciar una reproducción presione [PLAY ▶].

- 3** Para detener momentáneamente la reproducción presione [STOP ■] una vez.

• Consulte "Resume Playback" en la página 73.

Grabación Básica

Si usted está reproduciendo los títulos de una unidad de disco rígido, presione primero [HDD] y luego continúe al paso 2.
Si usted está reproduciendo los títulos de un DVD, presione primero [DVD].

- 1** Presione [OPEN/CLOSE ▲] para abrir la bandeja de discos e insertar su disco con el rótulo apuntando hacia arriba. Presione de nuevo [OPEN/CLOSE ▲] para cerrar la bandeja de discos.

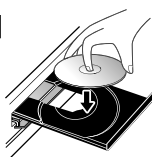

* Asegúrese de que el disco sea compatible con este aparato. (Para obtener la lista de discos compatibles consulte la página 123.)

- 2** Para seleccionar un modo de grabación presione repetidamente [REC MODE].

Modo de grabación	Tiempo de grabación			Calidad del video y el sonido
	Disco de 8 cm	Disco de 12 cm	HDD (interno)	
HQ	18 min	60 min	103 hrs	Buena ↑ ↓ Deficiente
SP	36 min	120 min	206 hrs	
SPP	45 min	150 min	258 hrs	
LP	54 min	180 min	310 hrs	
EP	72 min	240 min	413 hrs	
SLP	108 min	360 min	620 hrs	

- 3** Seleccione un canal externo de entrada adecuado presionando [SOURCE] o [CHANNEL +/-]. Presione [DTV/TV] para seleccionar TV analógica o TV digital, luego y utilice [CHANNEL +/-] o [los botones numéricos] y [•] (para canales de TV digital) para seleccionar un canal que se desee grabar.

Consulte "Switching Analog Mode/Digital Mode" y "Channel Selection" en la página 35.

- 4** Presione [REC] para iniciar la grabación.

Para configurar la grabación a un toque con temporizador (OTR)...

Esta es una manera sencilla de configurar el tiempo de grabación en bloques de 30 minutos. Presione [REC] repetidamente hasta que aparezca en la pantalla del televisor la longitud deseada de grabación (30 minutos a 6 horas).

Comenzará la grabación a un toque con temporizador.

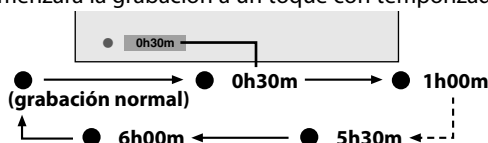

Para cambiar la duración de la grabación durante la grabación a un toque con temporizador:

Presione [REC] repetidamente hasta que aparezca la duración deseada.

Para cancelar la grabación a un toque con temporizador dentro del tiempo especificado:

Presione [STOP ■].

- 5** Para de tener la grabación presione [STOP ■].

Copiado Básica

Preparación para el copiado (unidad de disco rígido a DVD):

- Inserte un DVD grabable.

Preparación para el copiado (DVD a unidad de disco rígido):

- Inserte un disco a ser copiado.

1 Presione [MENU] en el modo de detención.

2 Utilice [▲/▼] para seleccionar "Doblaje", y luego presione [OK].

3 **Unidad de disco rígido a DVD**
Utilice [▲/▼] para seleccionar "HDD → DVD", y luego presione [OK].

DVD a Unidad de disco rígido

Utilice [▲/▼] para seleccionar "DVD → HDD", y luego presione [OK].

4 Utilice [▲/▼] para seleccionar "Añadir", y luego presione [OK].



5 Utilice [▲/▼/◀/▶] para seleccionar un título deseado, y luego presione [OK].

En la esquina superior de cada título aparece el número en el orden de selección.

6 Repita el paso 5 hasta que haya registrado todos los títulos que desea copiar; a continuación, pulse [DUBBING].



7 Luego de añadir todos los títulos que desea, utilice [▲/▼] para seleccionar "Inic de doblaje" en el menú de copiado, y luego presione [OK].

8 Utilice [◀/▶] para seleccionar un modo de grabación deseado, y luego presione [OK].

9 Utilice [▲/▼] para seleccionar "Sí", y luego presione [OK].

El copiado comenzará.

Para detener el copiado en curso:

Presione [■STOP] en el panel frontal.

Presione [STOP ■] en el control remoto durante 2 segundos.

A la hora de realizar una copia del HDD al DVD aparecerá un mensaje de confirmación; seleccione "Sí".

Copiado a un toque.....

Con el copiado a un toque, usted puede comenzar a copiar de inmediato con sólo un toque.

Para copiar el contenido de un DVD que está finalizado en otro equipo, utilice esta función.

Durante la reproducción del título que desea copiar, presione [DUBBING].

Si usted está reproduciendo un DVD, el copiado del DVD a la unidad de disco rígido comenzará de inmediato.

Si usted está reproduciendo una unidad de disco rígido, el copiado de la unidad de disco rígido al DVD comenzará de inmediato.

- El copiado comenzará desde el comienzo del título que está siendo reproducido.

- El aparato sólo copiará el título que está siendo reproducido.

- Cuando se copia de una unidad de disco rígido a un DVD, el modo de grabación será configurado automáticamente a "Alto" cada vez que se satisfagan las condiciones (consulte la página 54). De lo contrario, será aplicado automáticamente el último modo de grabación seleccionado.

Para detener el copiado en curso:

Presione [■STOP] en el panel frontal.

Presione [STOP ■] en el control remoto durante 2 segundos. A la hora de realizar una copia del HDD al DVD aparecerá un mensaje de confirmación; seleccione "Sí".

MAGNAVOX

LIMITED WARRANTY

FUNAI CORP. will repair this product, free of charge in the USA in the event of defect in materials or workmanship as follows:

DURATION:

PARTS: FUNAI CORP. will provide parts to replace defective parts without charge for one (1) year from the date of original retail purchase. Certain parts are excluded from this warranty.

LABOR: FUNAI CORP. will provide the labor without charge for a period of ninety (90) days from the date of original retail purchase.

LIMITS AND EXCLUSIONS:

THIS WARRANTY IS EXTENDED ONLY TO THE ORIGINAL RETAIL PURCHASER. A PURCHASE RECEIPT OR OTHER PROOF OF ORIGINAL RETAIL PURCHASE WILL BE REQUIRED TOGETHER WITH THE PRODUCT TO OBTAIN SERVICE UNDER THIS WARRANTY.

This warranty shall not be extended to any other person or transferee.

This warranty is void and of no effect if any serial numbers on the product are altered, replaced, defaced, missing or if service was attempted by an unauthorized service center. This limited warranty does not apply to any product not purchased and used in the United States.

This warranty only covers failures due to defects in material or workmanship which occur during normal use. It does not cover damage which occurs in shipment, or failures which are caused by repairs, alterations or products not supplied by FUNAI CORP., or damage, which results from accident, misuse, abuse, mishandling, misapplication, alteration, faulty installation, improper maintenance, commercial use such as hotel, rental or office use of this product, or damage which results from fire, flood, lightning or other acts of God.

THIS WARRANTY DOES NOT COVER PACKING MATERIALS, ANY ACCESSORIES (EXCEPT REMOTE CONTROL), ANY COSMETIC PARTS, COMPLETE ASSEMBLY PARTS, DEMO OR FLOOR MODELS.

FUNAI CORP. AND ITS REPRESENTATIVES OR AGENTS SHALL IN NO EVENT BE LIABLE FOR ANY GENERAL, INDIRECT OR CONSEQUENTIAL DAMAGES ARISING OUT OF OR OCCASIONED BY THE USE OF OR THE INABILITY TO USE THIS PRODUCT. THIS WARRANTY IS MADE IN LIEU OF ALL OTHER WARRANTIES, EXPRESS OR IMPLIED, AND OF ALL OTHER LIABILITIES ON THE PART OF FUNAI, ALL OTHER WARRANTIES INCLUDING THE WARRANTY OF MERCHANTABILITY AND FITNESS FOR A PARTICULAR PURPOSE, ARE HEREBY DISCLAIMED BY FUNAI AND ITS REPRESENTATIVES IN THE UNITED STATES.

ALL WARRANTY INSPECTIONS AND REPAIRS MUST BE PERFORMED BY AN AUTHORIZED SERVICE CENTER.

THIS WARRANTY IS ONLY VALID WHEN THE UNIT IS CARRIED-IN TO AN AUTHORIZED SERVICE CENTER.

THE PRODUCT MUST BE ACCOMPANIED BY A COPY OF THE ORIGINAL RETAIL PURCHASE RECEIPT. IF NO PROOF OF PURCHASE IS ATTACHED, THE WARRANTY WILL NOT BE HONORED AND REPAIR COSTS WILL BE CHARGED.

IMPORTANT:

THIS LIMITED WARRANTY GIVES YOU SPECIFIC LEGAL RIGHTS. YOU MAY HAVE OTHER RIGHTS THAT VARY FROM STATE TO STATE. IF, AT ANY TIME DURING THE WARRANTY PERIOD, YOU ARE UNABLE TO OBTAIN SATISFACTION WITH THE REPAIR OF THIS PRODUCT, PLEASE CONTACT FUNAI CORP.

ATTENTION:

FUNAI CORP. RESERVES THE RIGHT TO MODIFY ANY DESIGN OF THIS PRODUCT WITHOUT PRIOR NOTICE.

WARRANTY STATEMENT REGARDING NON AUTHORIZED REPAIRS:

To obtain warranty service, you must take the product, or deliver the product freight prepaid, in either its original packaging or packaging affording an equal degree of protection, to any AUTHORIZED SERVICE CENTER. FUNAI CORP. will not reimburse you for any service done by unauthorized service providers without prior written approval.

To locate your nearest AUTHORIZED SERVICE CENTER or for general service inquiries, please contact us at:

FUNAI SERVICE CORPORATION

Tel: 1-800-605-8610

www.magnavox.com/support

www.funaiservice.com/

2200 Spiegel Drive Groveport, OH 43125



Free Manuals Download Website

<http://myh66.com>

<http://usermanuals.us>

<http://www.somanuals.com>

<http://www.4manuals.cc>

<http://www.manual-lib.com>

<http://www.404manual.com>

<http://www.luxmanual.com>

<http://aubethermostatmanual.com>

Golf course search by state

<http://golfingnear.com>

Email search by domain

<http://emailbydomain.com>

Auto manuals search

<http://auto.somanuals.com>

TV manuals search

<http://tv.somanuals.com>