

DVD Player with Progressive Scan Output

- 1 Connect the DVD to the TV using Component Video cable.
- 2 For sound connect left (white) and right (red) audio cables.
- 3 Connect the 2 antenna cables for DVD Recording. After connecting all cables and devices switch on your TV.
- 4 Press **AV+** button on the remote control, then press **CURSOR V** (down) repeatedly to select **CV-1 (HDS/D)**.

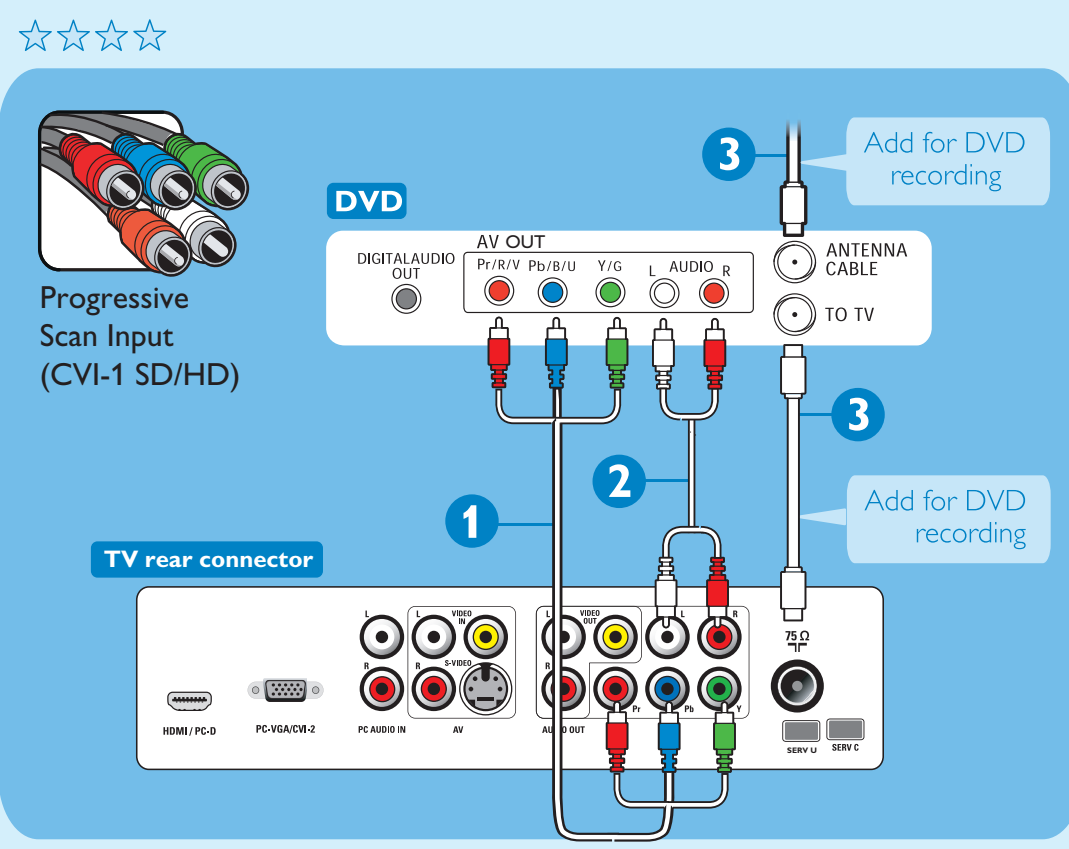

Other possible connections for DVD Player with Progressive Scan Output

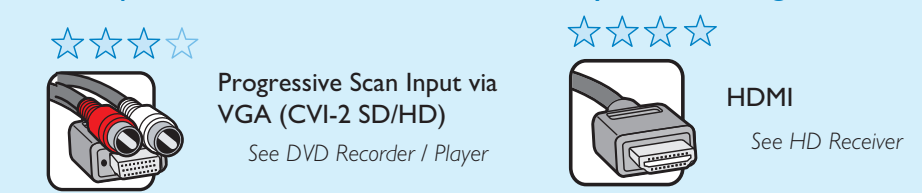

HD Receiver

- 1 Connect the component video cable from the HD receiver to the **HDMI / PC-D** of the TV using a **HDMI** cable.
- 2 Connect the antenna cables for recording on your HD receiver. After connecting all cables and devices switch on your TV.
- 3 Press **AV+** button on the remote control, then press **CURSOR V** (down) repeatedly to select **HDMI**.

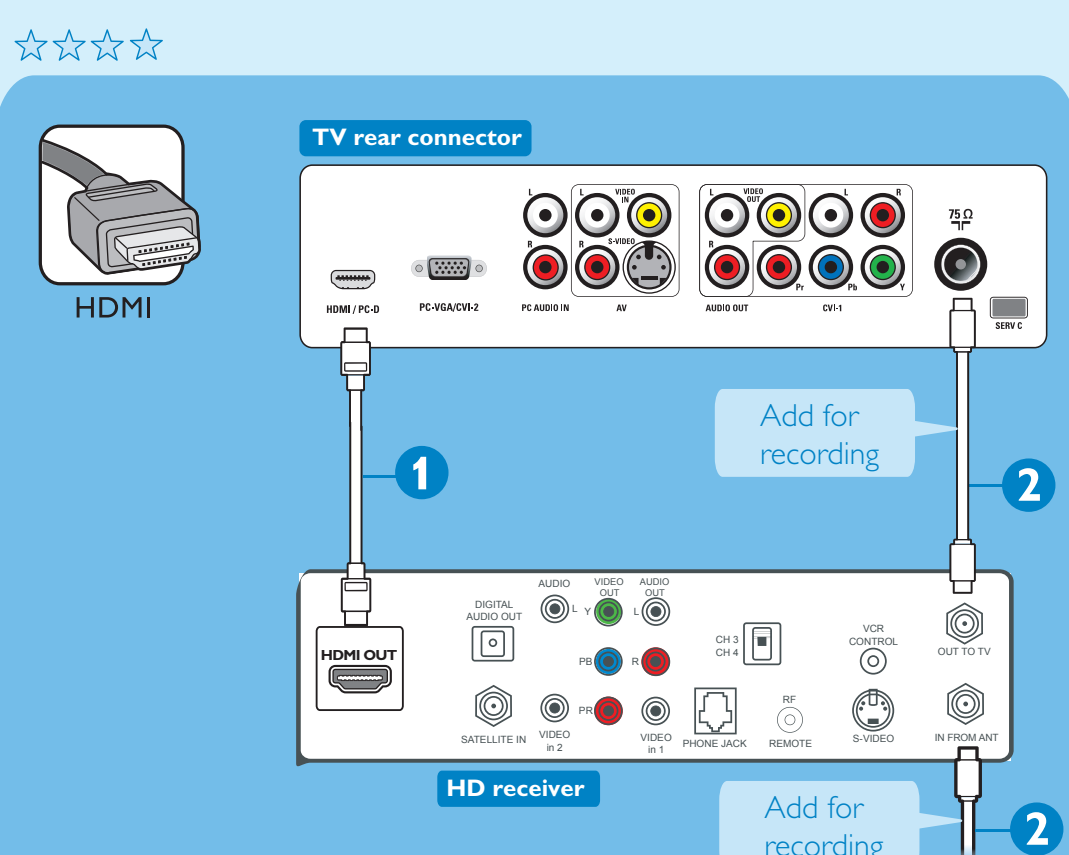

Other possible connections for HD receiver

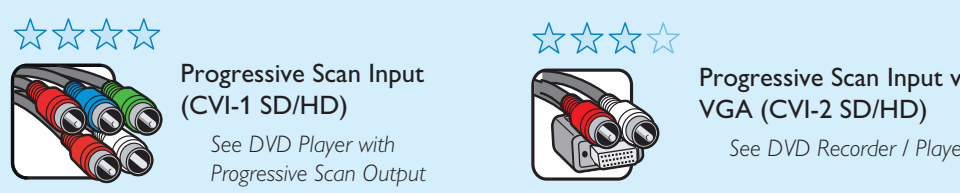

PC (Monitor)

- 1 Connect the Monitor (side) output on the PC to the **HDMI/PC-D Input** of the TV using a **HDMI to DVI** cable.
- 2 Connect the audio output on the PC to the **PC AUDIO In** of the TV using an audio cable as shown.
- 3 After connecting all cables and devices switch on your TV.
- 4 Press the **AV+** button on the remote control then press **CURSOR V** (down) to select **PC-D**.

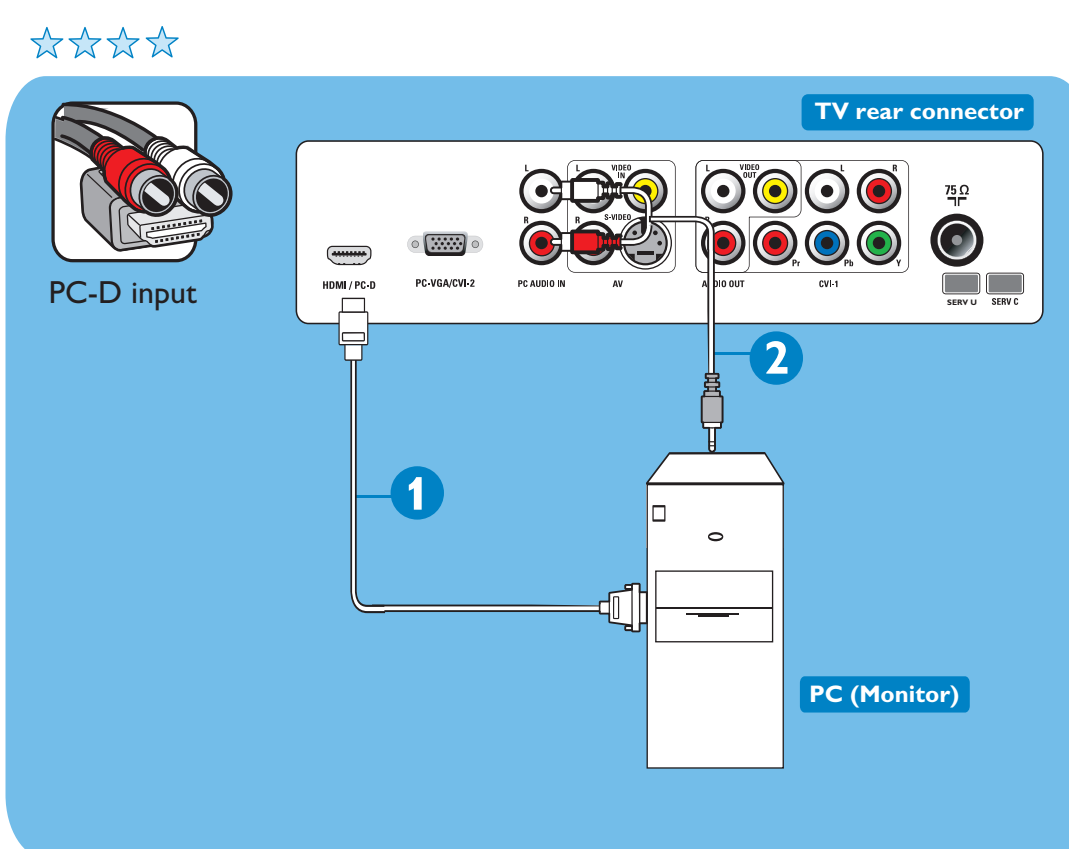

OR

- 1 Connect the Monitor (side) output on the PC to the **PC-VGA/ CV1-2 Input** of the TV using a **VGA** cable.
- 2 Connect the audio output on the PC to the **PC AUDIO In** of the TV using an audio cable.
- 3 After connecting all cables and devices switch on your TV.
- 4 Press the **AV+** button on the remote control then press **CURSOR V** (down) to select **PC-VGA**.

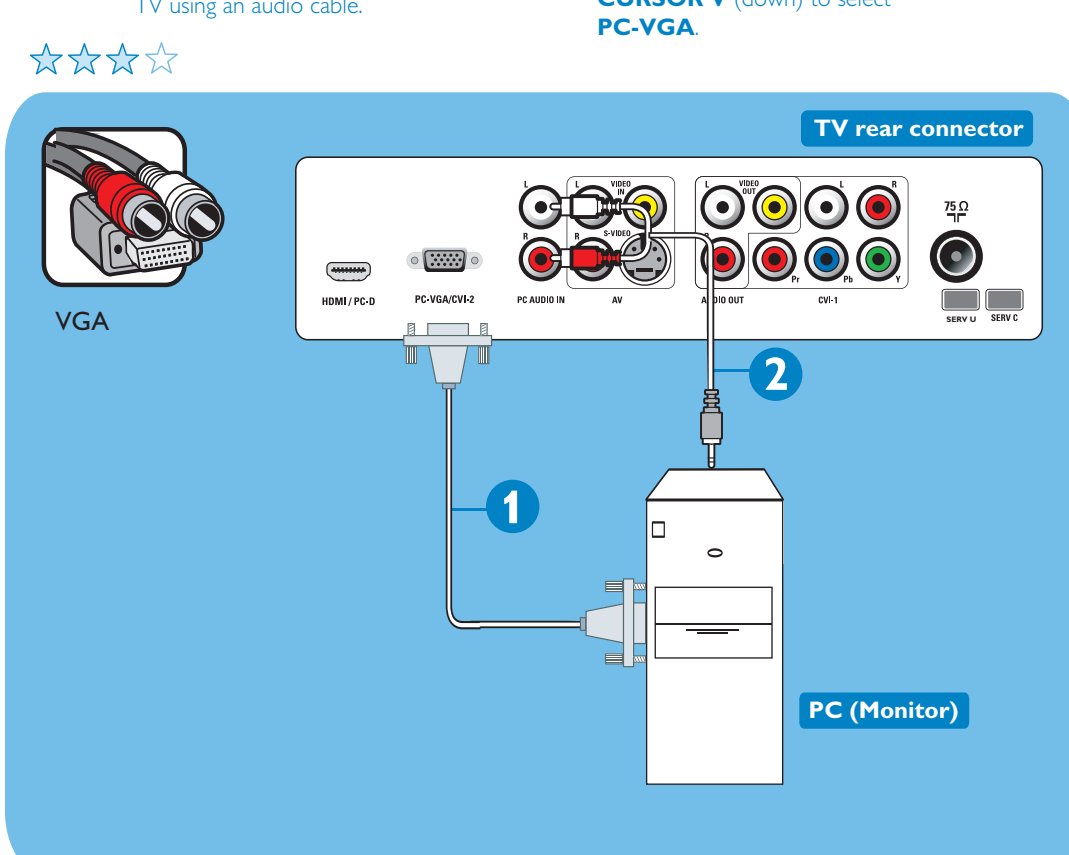

VCR

- 1 Connect the VCR to the TV using the S-Video cable.
- 2 Connect the left (white) and right (red) audio cables to the left (white) and right (red) audio input of your TV.
- 3 Connect the 2 antenna cables for VCR Recording. After connecting all cables and devices switch on your TV.
- 4 Press **AV+** button on the remote control, then press **CURSOR V** (down) repeatedly to select **SIDESVHS**.

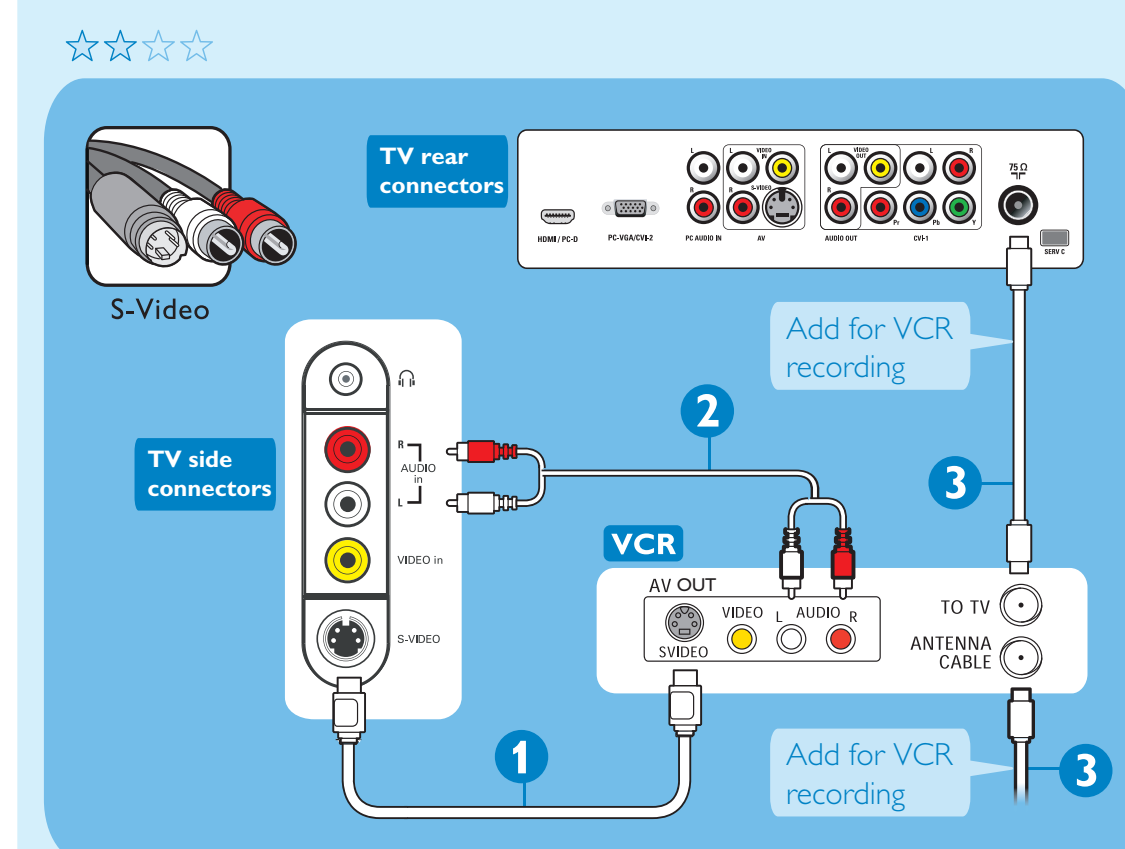

OR

- 1 Connect the VCR to the TV using Video cable (yellow).
- 2 Connect the left (white) and right (red) audio cables to the left (white) and right (red) audio input of your TV.
- 3 Press **AV+** button on the remote control, then press **CURSOR V** (down) until select **AVS/HVS**.

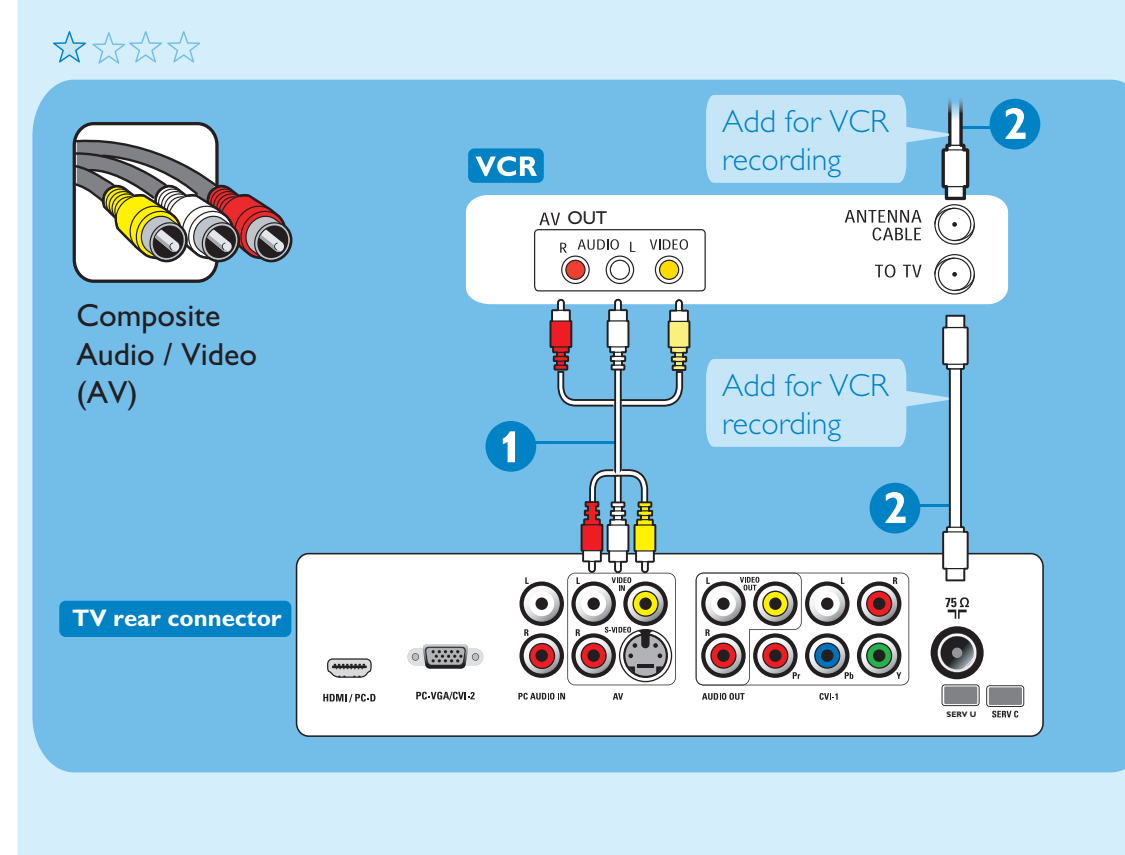

Other possible connections for VCR



Games/Camera / Headphone

- 1 Connect the Video cable from the Video output on your camera or game console to the video input located on the side of your TV. Connect the left (white) and right (red) audio cables for sound.
- 2 Press the **AV+** button on the remote control then press **CURSOR V** (down) to select **SVHS**.
Note: For headphone connection, please insert the plug into the headphone socket as shown.

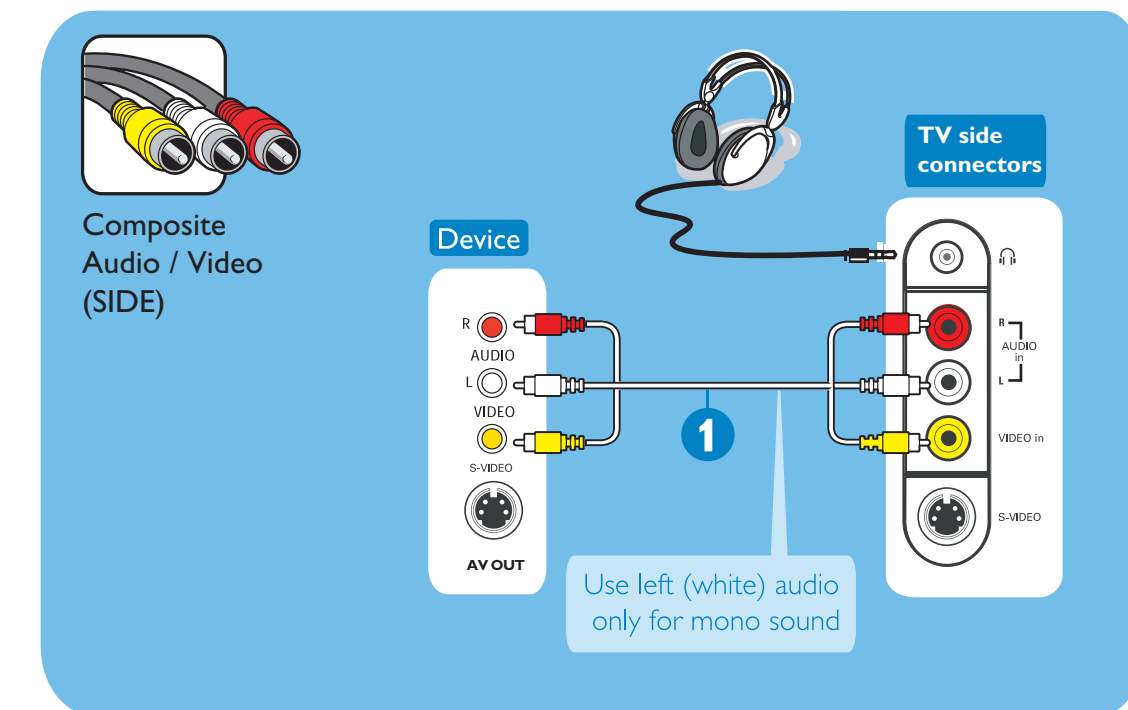

Other possible connections



4. How to perform programming for the first time

(Please skip this section if you have no cable connected to the Antenna input of the TV.)

- 1 When the TV is powered-on for the first time you will have to auto program the TV in order to receive the channels that are broadcasted locally.
- 2 Press the **MENU** button on the remote control to show the onscreen menu.
- 3 Press the **CURSOR DOWN** button repeatedly until **Install** is highlighted.
- 4 Press the **CURSOR RIGHT** button to enter the **Install** menu. Language will be highlighted.
- 5 Press the **CURSOR DOWN** button repeatedly until **Auto Program** is selected. "Start?" will appear.
- 6 Press the **CURSOR RIGHT** button to start the Auto Programming process.
- 7 Press the **STATUS/EXIT** button to remove the menu from the screen when the Auto programming process has finished.

Connect

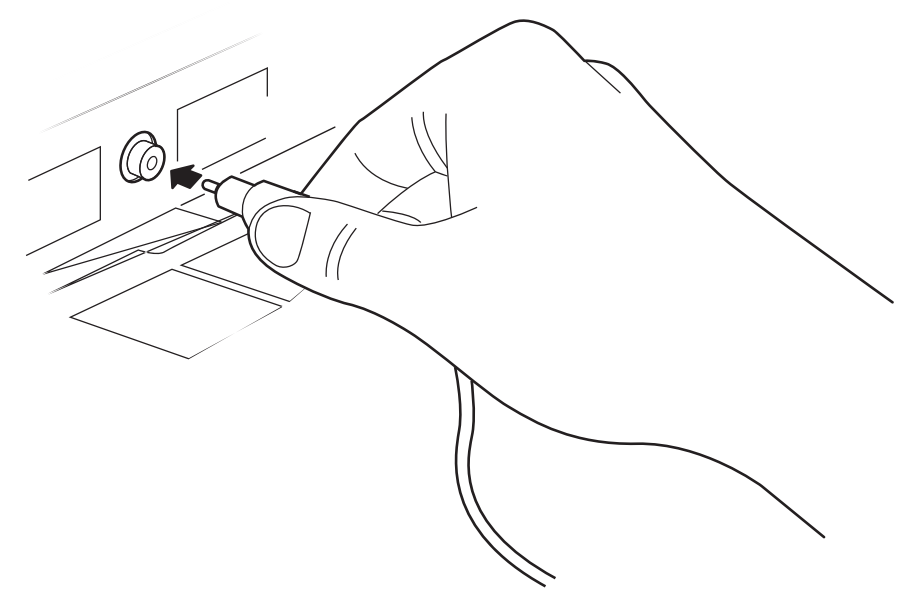

PHILIPS

100% RECYCLED

100% RECYCLED

100% RECYCLED

100% RECYCLED

100% RECYCLED

100% RECYCLED

100% RECYCLED

100% RECYCLED

100% RECYCLED

100% RECYCLED

100% RECYCLED

100% RECYCLED

100% RECYCLED

100% RECYCLED

100% RECYCLED

100% RECYCLED

100% RECYCLED

100% RECYCLED

100% RECYCLED

100% RECYCLED

100% RECYCLED

100% RECYCLED

100% RECYCLED

100% RECYCLED

100% RECYCLED

100% RECYCLED

100% RECYCLED

100% RECYCLED

100% RECYCLED

100% RECYCLED

100% RECYCLED

100% RECYCLED

100% RECYCLED

100% RECYCLED

100% RECYCLED

100% RECYCLED

100% RECYCLED

100% RECYCLED

100% RECYCLED

100% RECYCLED

100% RECYCLED

100% RECYCLED

100% RECYCLED

100% RECYCLED

100% RECYCLED

100% RECYCLED

100% RECYCLED

100% RECYCLED

100% RECYCLED

100% RECYCLED

100% RECYCLED

100% RECYCLED

100% RECYCLED

100% RECYCLED

100% RECYCLED

100% RECYCLED

100% RECYCLED

100% RECYCLED

100% RECYCLED

100% RECYCLED

100% RECYCLED

100% RECYCLED

100% RECYCLED

100% RECYCLED

100% RECYCLED

100% RECYCLED

100% RECYCLED

100% RECYCLED

100% RECYCLED

100% RECYCLED

100% RECYCLED

100% RECYCLED

100% RECYCLED

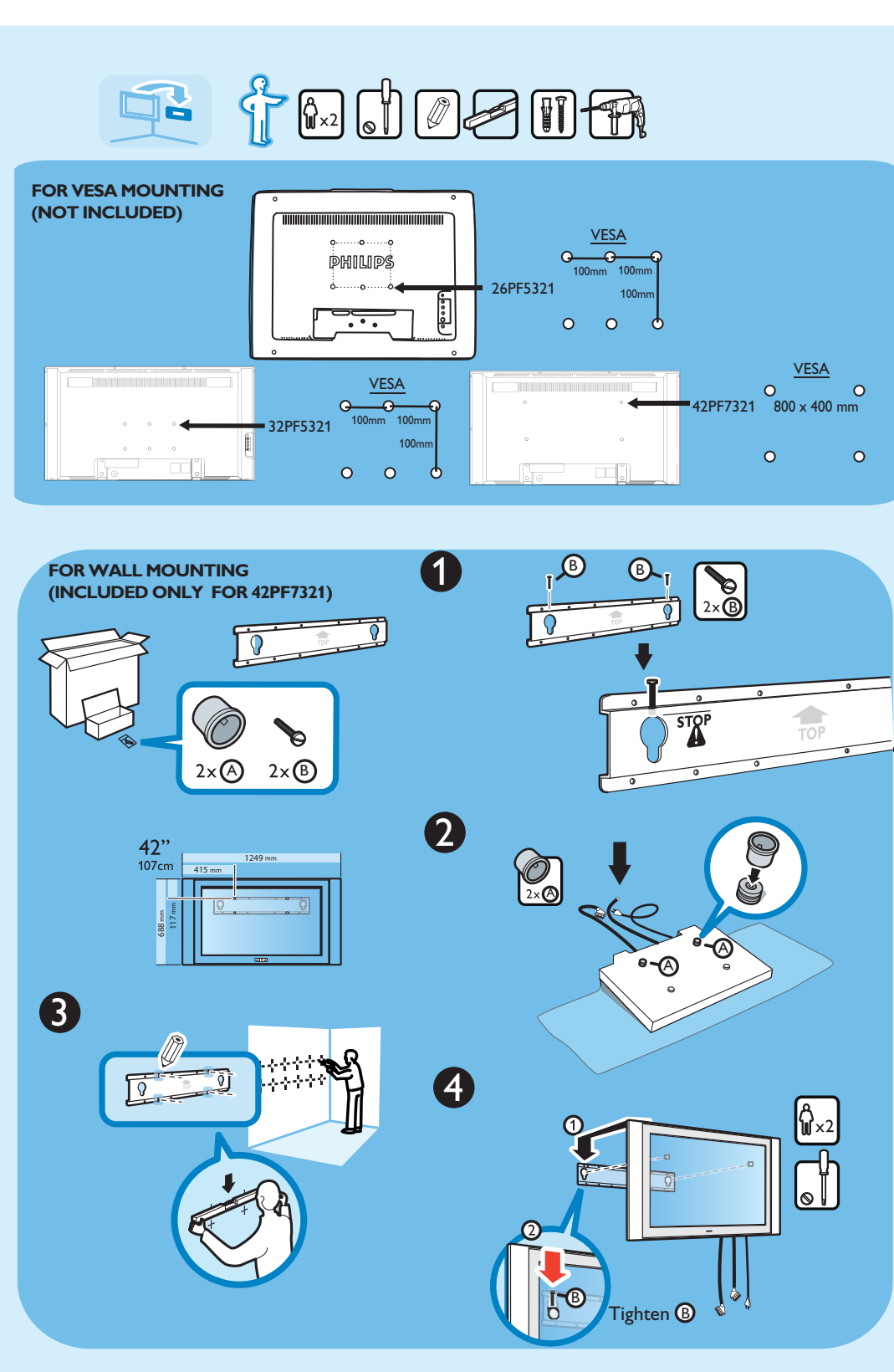
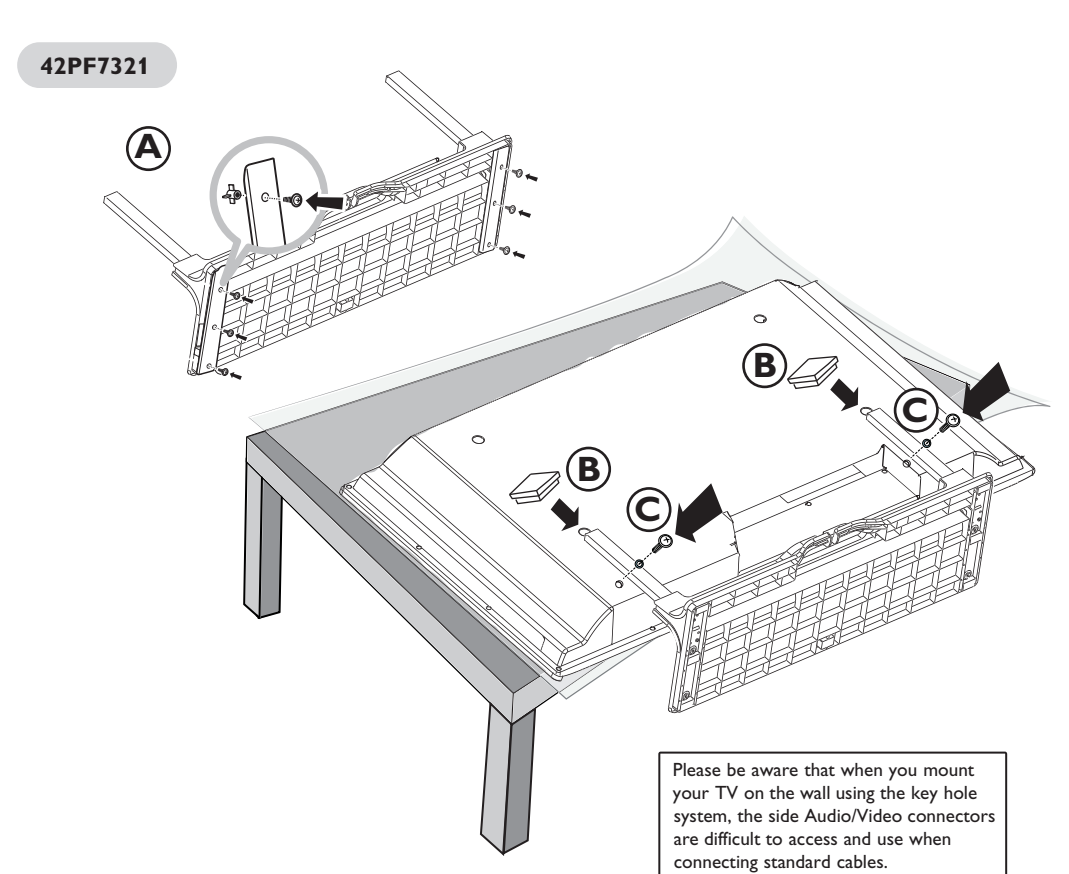
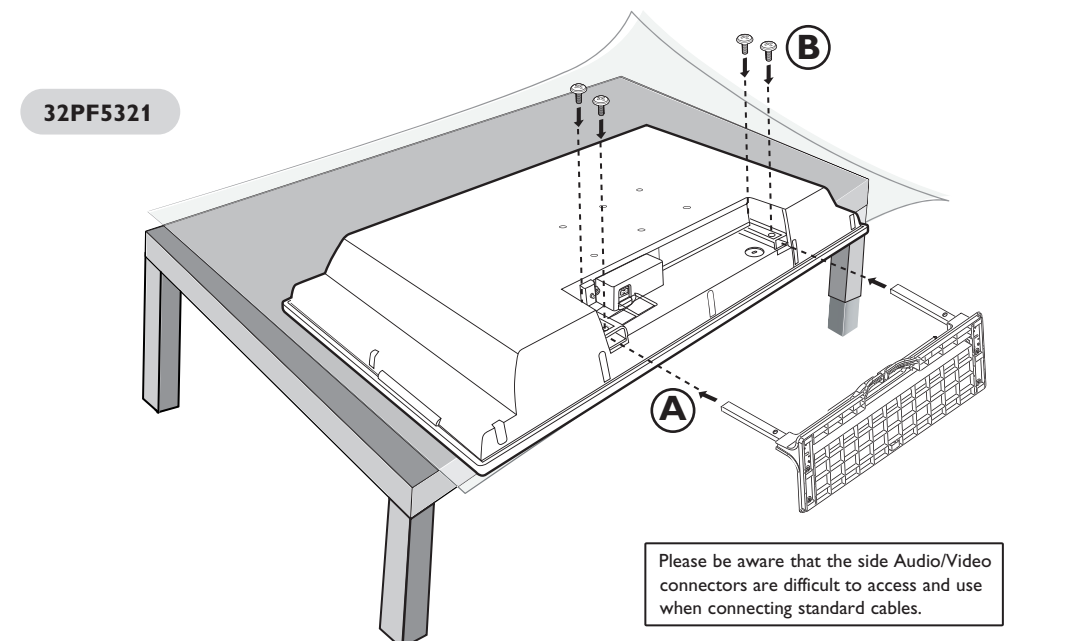
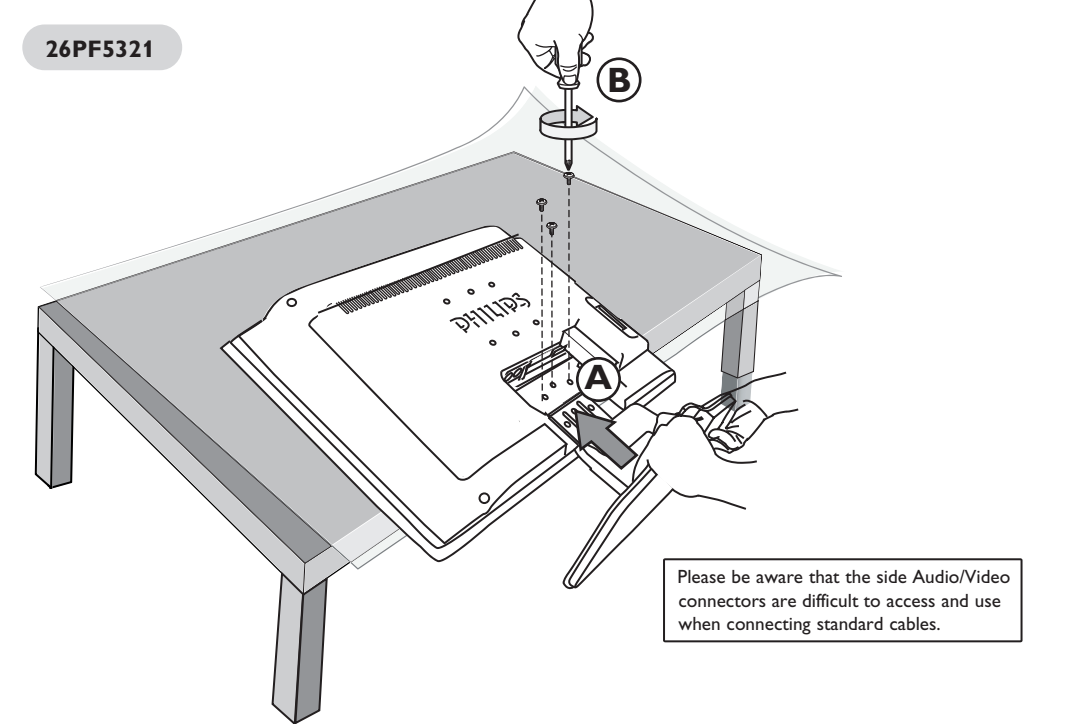
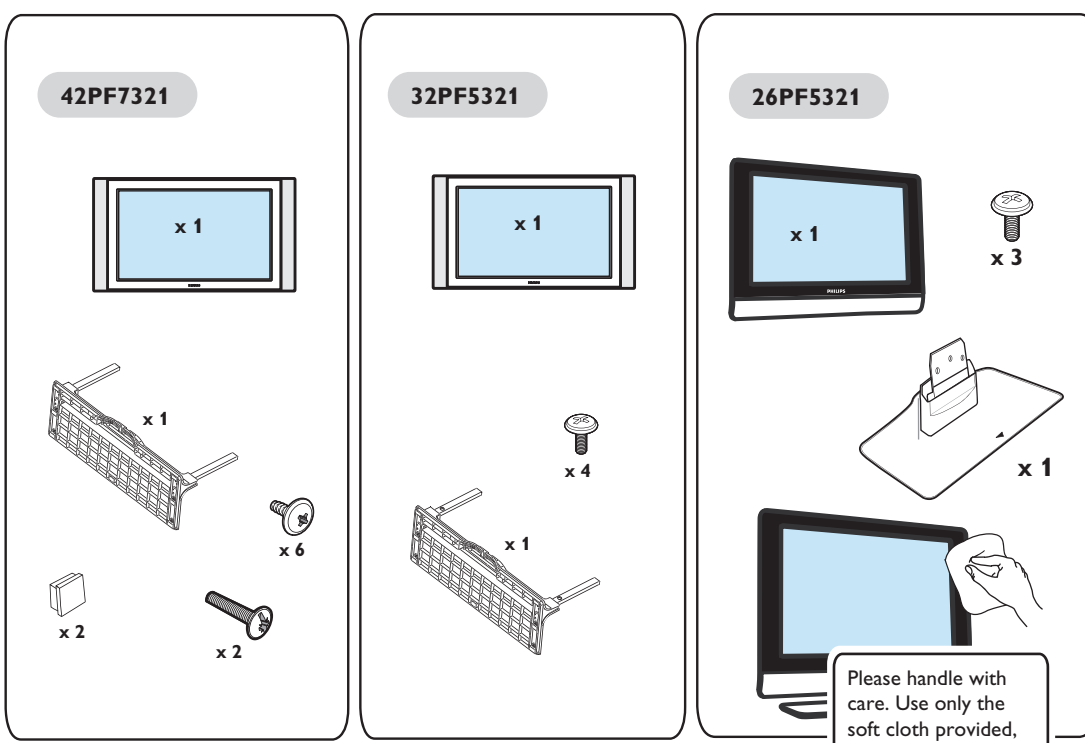

- ### Read this first for easy installation:
1. How to make the best connection
 2. Connect power and antenna / cable
 3. Connect your devices
 4. How to perform programming for the first time.

For detailed information, please see the User Manual.
Please keep your connection guide after you have completed connecting your TV to the various devices. Do not throw it away as you may need it for future connections.

1. How to make the best connection

Use this guide to achieve the optimal connection for each of your components devices. These cables are not provided with the set.



2. Connect power and antenna / cable

- 1 Connect the antenna or cable signal in the antenna/cable input.
- 2 Connect the power cord to your TV.
- 3 After connecting all cables and devices, plug in the power and switch on your TV.

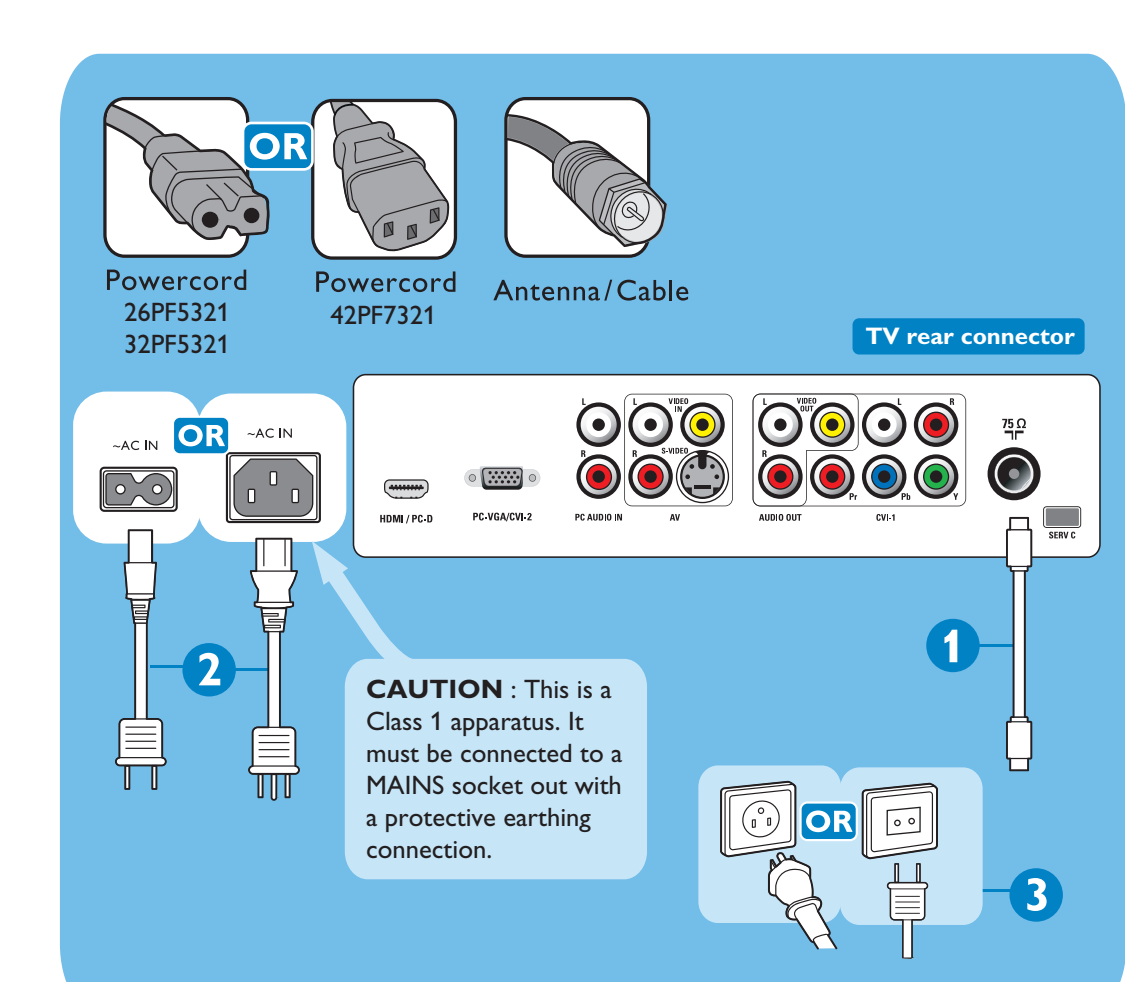

CAUTION: This is a Class 1 apparatus. It must be connected to a MAINS socket out with a protective earthing connection.

3. Connect your devices

Cable or Satellite set top box

- 1 Connect the antenna cable to the antenna input of the Set-Top Box.
- 2 Connect the Set-Top Box to the TV using an antenna cable.
- 3 After connecting all cables and devices, switch on your TV.
- 4 Tune in the TV the same channel selected in the Set-Top Box.

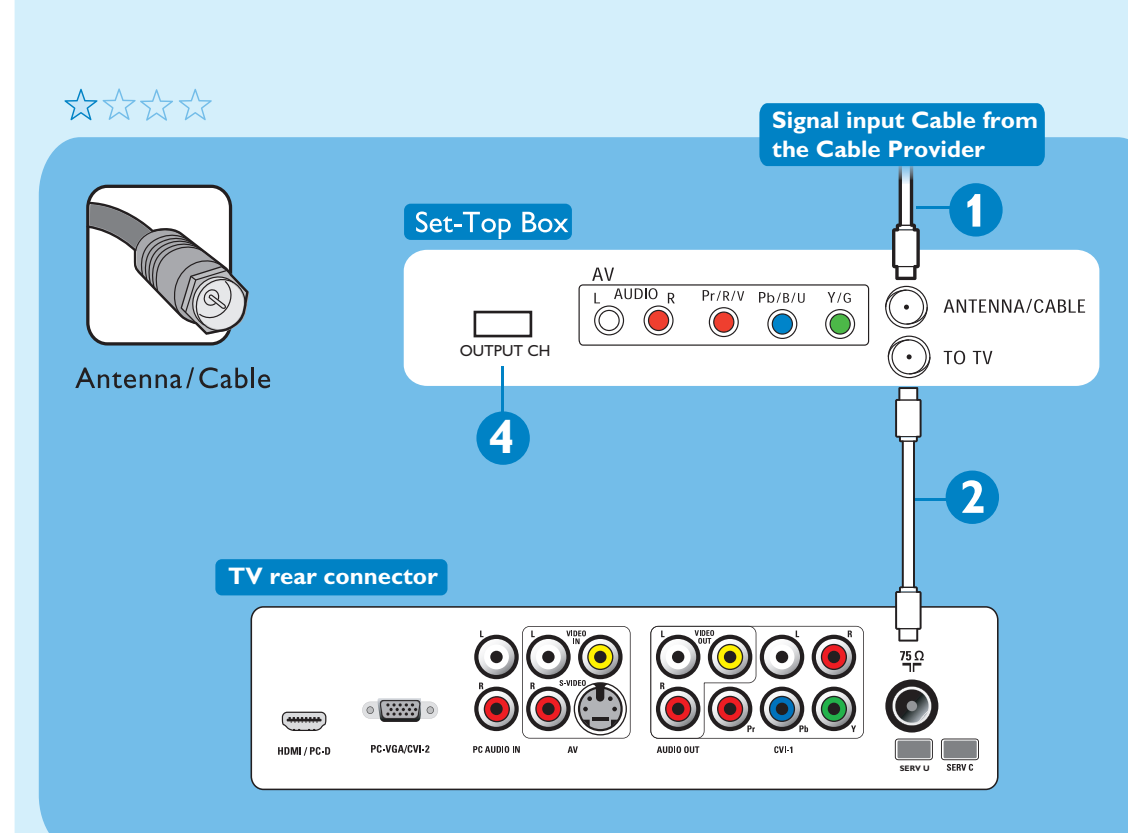

OR

- 1 Connect the antenna cable to the antenna input of the Set-Top Box.
- 2 Connect the Set-Top Box to the TV using Composite Video (AV) plug into their corresponding ports.
- 3 After connecting all cables and devices, switch on your TV.
- 4 Press **AV+** button on the remote control, then press **CURSOR V** (down) repeatedly to select **AVS/HVS**.

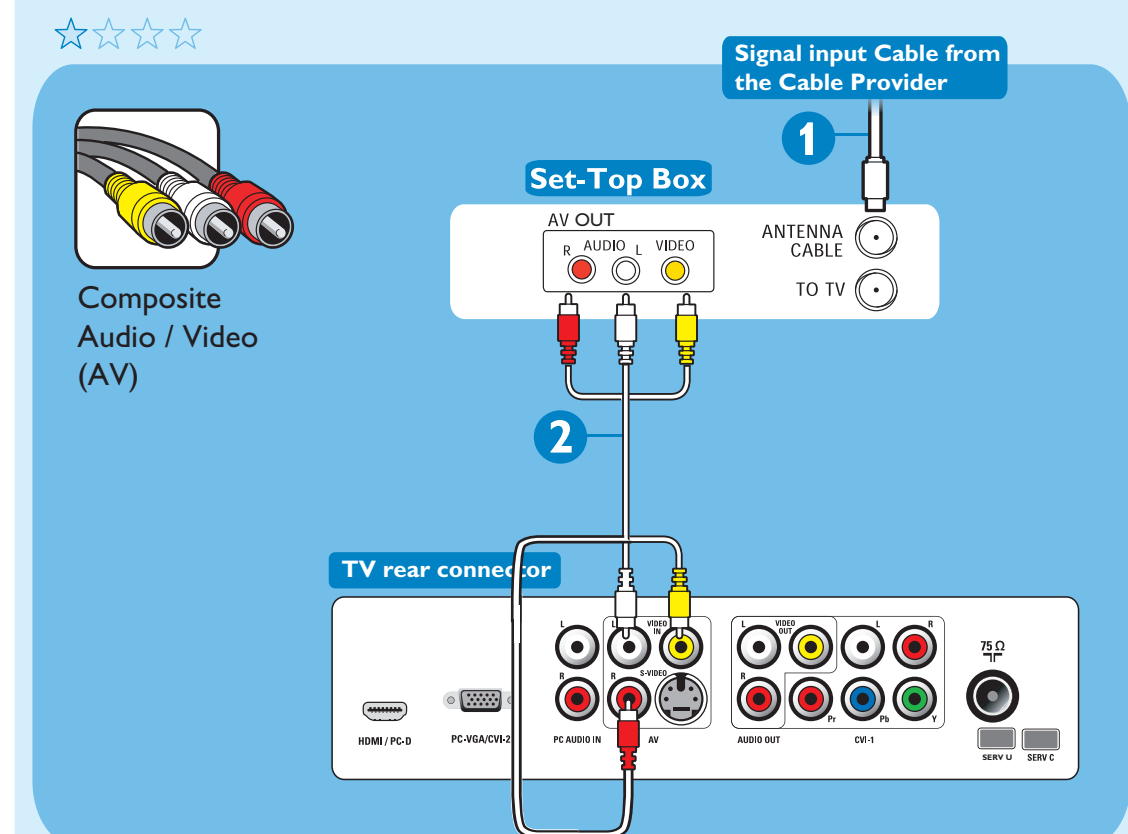

Other possible connections



DVD Recorder/Player

- 1 Connect the DVD to the TV using Component Video cable.
- 2 For sound connect left (white) and right (red) audio cables.
- 3 Connect the 2 antenna cables for DVD Recording. After connecting all cables and devices switch on your TV.
- 4 Press **AV+** button on the remote control, then press **CURSOR V** (down) repeatedly to select **CV-1 (HDS/D)**.

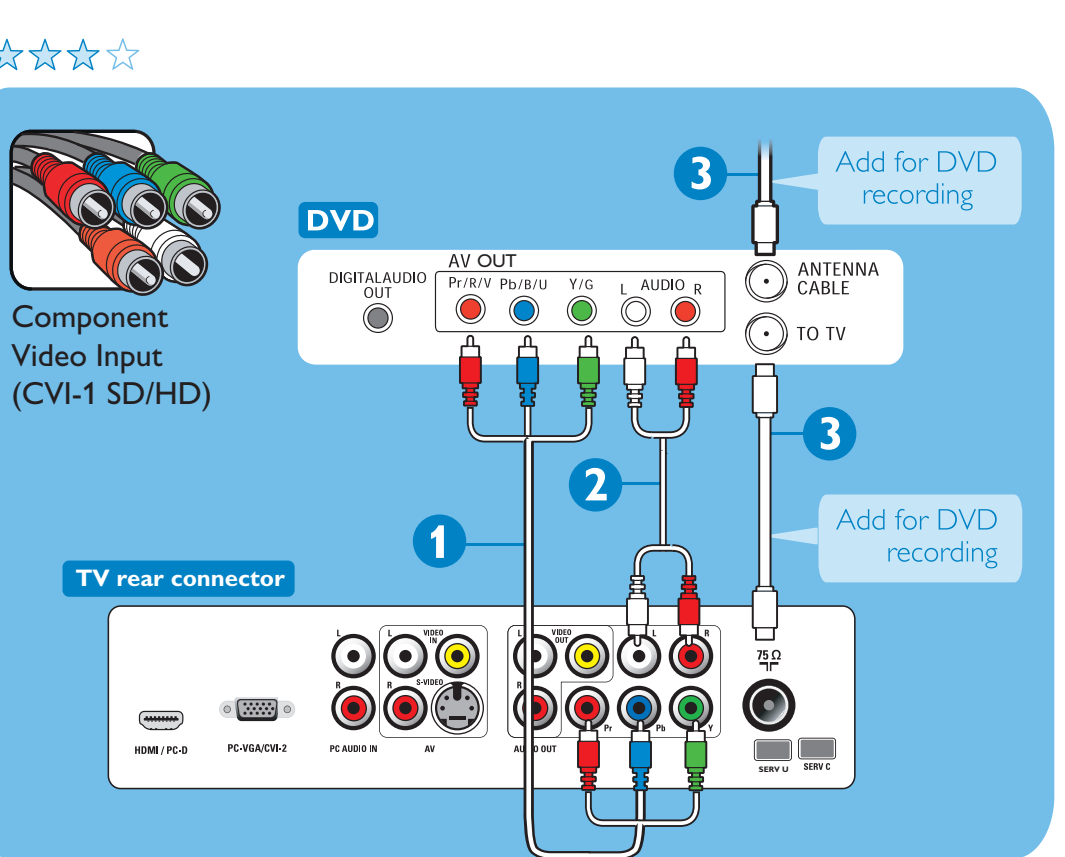

OR

- 1 Connect the DVD to the TV using **YPbPr - VGA** adapter.
- 2 For sound connect the left (white) and right (red) audio cables to the left (white) and right (red) audio input of your TV (**PC AUDIO IN**).
- 3 Connect the 2 antenna cables for DVD Recording. After connecting all cables and devices switch on your TV.
- 4 Press **AV+** button on the remote control, then press **CURSOR V** (down) repeatedly to select **CV1-2 (SD/H/D)**.

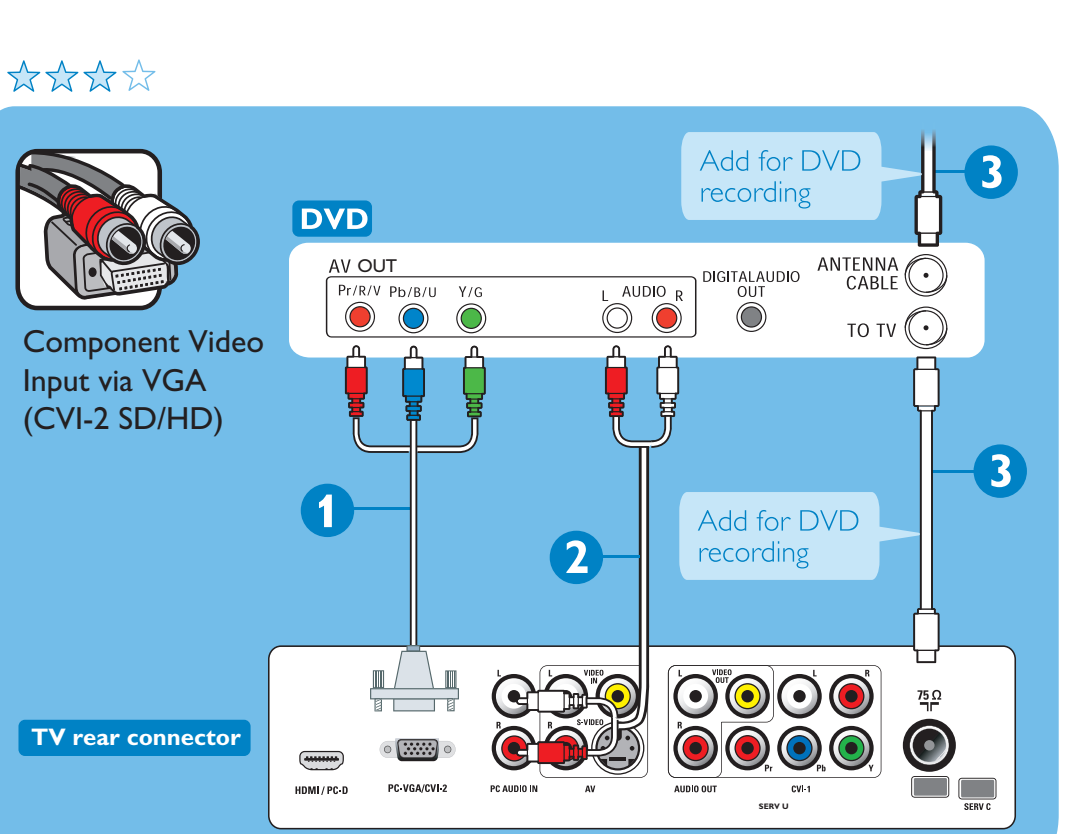

Other possible connections



Turn your page to see other connections.

Free Manuals Download Website

<http://myh66.com>

<http://usermanuals.us>

<http://www.somanuals.com>

<http://www.4manuals.cc>

<http://www.manual-lib.com>

<http://www.404manual.com>

<http://www.luxmanual.com>

<http://aubethermostatmanual.com>

Golf course search by state

<http://golfingnear.com>

Email search by domain

<http://emailbydomain.com>

Auto manuals search

<http://auto.somanuals.com>

TV manuals search

<http://tv.somanuals.com>