

DVD Recorder / VCR

DVDR3430V  
DVDR3432V

## User Manual

**Thank you for choosing Philips.**

### **Need help fast?**

*Read your Quick Use/Start Guide and/or User Manual first for quick tips that make using your Philips product more enjoyable.*

*If you have read your instructions and still need assistance, you may access our online help at **[www.philips.com/support](http://www.philips.com/support)***



**VIDEO** *Plus+*

**SHOWVIEW**

**PHILIPS**

### Important notes for users in U.K.

#### Mains plug

This apparatus is fitted with an approved 13 Amp plug. To change a fuse in this type of plug proceed as follows:

- 1 Remove fuse cover and fuse.
- 2 Fix new fuse which should be a BSI 362 5 Amp, A.S.T.A. or BSI approved type.
- 3 Refit the fuse cover.

If the fitted plug is not suitable for your socket outlets, it should be cut off and an appropriate plug fitted in its place.

If the mains plug contains a fuse, this should have a value of 5 Amp. If a plug without a fuse is used, the fuse at the distribution board should not be greater than 5 Amp.

*Note: The severed plug must be disposed off to avoid a possible shock hazard should it be inserted into a 13 Amp socket elsewhere.*

#### How to connect a plug

The wires in the mains lead are coloured with the following code: blue = neutral (N), brown = live (L).

- As these colours may not correspond with the colour markings identifying the terminals in your plug, proceed as follows:
  - Connect the blue wire to the terminal marked N or coloured black.
  - Connect the brown wire to the terminal marked L or coloured red.
  - Do not connect either wire to the earth terminal in the plug, marked E (or e) or coloured green (or green and yellow).

Before replacing the plug cover, make certain that the cord grip is clamped over the sheath of the lead - not simply over the two wires.

#### Copyright in the U.K.

Recording and playback of material may require consent. See Copyright Act 1956 and The Performer's Protection Acts 1958 to 1972.

### Italia

#### DICHIARAZIONE DI CONFORMITA'

Si dichiara che l'apparecchio DVDR3430V, DVDR3432V, Philips risponde alle prescrizioni dell'art. 2 comma 1 del D.M. 28 Agosto 1995 n. 548.

Fatto a Eindhoven

Philips Consumer Electronics  
Philips, Glaslaan 2  
5616 JB Eindhoven, The Netherlands

### Norge

Typeskilt finnes på apparatens underside.

**Observer: Nettbryteren er sekundert innkoplet. Den innebygde nettdelen er derfor ikke frakoplet nettet så lenge apparatet er tilsluttet nettkontakten.**

For å redusere faren for brann eller elektrisk støt, skal apparatet ikke utsettes for regn eller fuktighet.

#### For Customer Use:

Read carefully the information located at the bottom or rear of your DVD Recorder and enter below the Serial No. Retain this information for future reference.

Model No. DVDR/VCR RECORDER  
DVDR3430V, DVDR3432V

Serial No. \_\_\_\_\_

## DK

**Advarsel: Usynlig laserstråling ved åbning når sikkerhedsafbrydere er ude af funktion. Undgå udsættelse for stråling.**

**Bemærk: Netafbryderen er sekundært indkoblet og afbryder ikke strømmen fra nettet. Den indbyggede netdel er derfor tilsluttet til lysnettet så længe netstikket sidder i stikkontakten.**

## S

**Klass I laserapparat**

**Varning! Om apparaten används på annat sätt än i denna bruksanvisning specificerats, kan användaren utsättas för osynlig laserstrålning, som överskrider gränsen för laserklass I.**

**Observera! Stömbrytaren är sekundärt kopplad och bryter inte strömmen från nätet. Den inbyggda nätdelen är därför ansluten till elnätet så länge stickproppen sitter i vägguttaget.**

## SF

**Luokan I laserlaite**

**Varoitus! Laitteen käyttäminen muulla kuin tässä käyttöohjeessa mainitulla tavalla saattaa altistaa käyttäjän turvallisuusluokan I ylittävälle näkymättömälle lasersäteilylle.**

**Oikeus muutoksiin varataan. Laite ei saa olla alttiina tippu- ja roiskevedelle.**

**Huom. Toiminnanvalitsin on kytketty toisiopuolelle, eikä se kytke laitetta irti sähköverkosta. Sisäänrakennettu verkko-osa on kytkettynä sähköverkkoon aina silloin, kun pistoke on pistorasiassa.**

## CAUTION

VISIBLE AND INVISIBLE LASER RADIATION WHEN OPEN. AVOID EXPOSURE TO BEAM

## ADVARSEL

SYNLIG OG USYNLIG LASERSTRÅLING VED ÅBNING UNDGÅ UDSÆTTELSE FOR STRÅLING

## VARNING

SYNLIG OCH OSYNLIG LASERSTRÅLNING NÄR DENNA DEL ÄR ÖPPNAD BETRAKTA EJ STRÅLEN

## VARO!

AVATTAESSA OLET ALTTIINA NÄKYVÄLLE JA NÄKYMÄTTÖMÄLLE LASER SÄTEILYLLE. ÄLÄ KATSO SÄTEESEEN

## VORSICHT

SICHTBARE UND UNSICHTBARE LASERSTRAHLUNG WENN ABDECKUNG GEÖFFNET NICHT DEM STRAHL AUSSETZEN

## ATTENTION

RAYONNEMENT LASER VISIBLE ET INVISIBLE EN CAS D'OUVERTURE EXPOSITION DANGEREUSE AU FAISCEAU

### Disposal of your old product



Your product is designed and manufactured with high quality materials and components, which can be recycled and reused. When this crossed-out wheeled bin symbol is attached to a product it means the product is covered by the European Directive 2002/96/EC. Please inform yourself about the local separate collection system for electrical and electronic products.

Please act according to your local rules and do not dispose of your old products with your normal household waste. The correct disposal of your old product will help prevent potential negative consequences for the environment and human health.

Due to the inconsistency of disc formats provided by various disc manufacturers, your DVD system/ player/recorder may require a playability enhancement or upgrade. As DVD technology advances, these enhancement will become common and will be easy to complete. Go to [www.philips.com/support](http://www.philips.com/support) for software upgrade.

En raison de la diversité des formats utilisés par les fabricants, votre système DVD peut nécessiter l'ajout de périphériques ou une mise à niveau logicielle. Au fur et à mesure des progrès de la technologie DVD, ces périphériques se font de plus en plus courants et aisés à intégrer. Pour télécharger la mise à niveau logicielle, visitez le site [www.philips.com/support](http://www.philips.com/support).

Debido a los diferentes formatos de discos disponibles en el mercado, es posible que deba realizar mejoras o actualizaciones en el sistema de DVD relativas a las funciones de reproducción. Conforme la tecnología DVD avanza, estas mejoras estarán al alcance de todo tipo de usuarios y se podrán llevar a cabo fácilmente. Visite la página "[www.philips.com/support](http://www.philips.com/support)" para buscar información sobre actualizaciones de software.

Da das Disk-Format je nach Hersteller verschieden ist, ist für Ihr DVD-System möglicherweise die Erweiterung der Spielbarkeit oder eine Aktualisierung erforderlich. Da die DVD-Technologie sich ständig weiterentwickelt, werden sich diese Erweiterungen durchsetzen und einfach auszuführen sein. Gehen Sie zu für Ihre Software-Aktualisierung zu „[www.philips.com/support](http://www.philips.com/support)“.

Doordat fabrikanten verschillende schijfindeligen aanbieden, moet uw dvd-systeem mogelijk worden geüpgradet of uitgebreid. Naarmate de dvd-technologie zich verder ontwikkelt, zullen deze uitbreidingen normaal worden en zult u ze gemakkelijk kunnen uitvoeren. Ga naar "[www.philips.com/support](http://www.philips.com/support)" om uw software te upgraden.

A causa della differenza di formato tra i dischi forniti dai vari produttori, il sistema DVD potrebbe richiedere un potenziamento o aggiornamento della riproducibilità. Col progredire della tecnologia DVD, questi potenziamenti diverranno comuni e facili da implementare. Visitare "[www.philips.com/support](http://www.philips.com/support)" per scaricare gli aggiornamenti del software.

På grund af uoverensstemmelser mellem diskformater fra de forskellige diskproducenter, kan dit dvd-system kræve en afspilningsudvidelse eller en opgradering. Efterhånden som dvd-teknologien udvikles, vil disse udvidelser blive almindelige og vil være nemme at implementere. Gå til "[www.philips.com/support](http://www.philips.com/support)", hvis du ønsker softwareopgradering.

Koska eri levyvalmistajat käyttävät erilaisia levyformaatteja, DVD-järjestelmäsi toimintoja täytyy ehkä laajentaa tai päivittää. DVD-teknikaan kehittyessä nämä laajennukset yleistyvät ja ovat helposti toteutettavissa. Löydät ohjelmistopäivityksen sivustosta "[www.philips.com/support](http://www.philips.com/support)".

Devido à inconsistência dos formatos de disco disponibilizados por vários fabricantes de discos, a capacidade de reprodução do seu sistema de DVD pode necessitar de ser melhorada ou atualizada. À medida que a tecnologia do DVD avança, estes melhoramentos tornam-se comuns e fáceis de completar. Visite "[www.philips.com/support](http://www.philips.com/support)" para obter atualizações de software.

Λόγω της ασυνέπιας στην διαμόρφωση των δίσκων που παρέχονται από διάφορους κατασκευαστές δίσκων, το σύστημα DVD που χρησιμοποιεί νδεχται να απαιτεί βλιτίωση ή αναβάθμιση της δυνατότητας αναπαραγωγής. Καθώς ζλίσται η τεχνολογία των DVD, οι βλιτίωσις αυτές θα ίναι συνηθισμένεσ και θα ίναι ύκολο να ολοκληρωθούν. Μταβίτ στη διύθυνση "[www.philips.com/support](http://www.philips.com/support)" για αναβάθμιση λογισμικού.

Ze względu na niekompatybilność formatów płyt oferowanych przez rozmaitych producentów, Twój system DVD może wymagać rozbudowy lub aktualizacji oprogramowania. W miarę zaawansowania technologii DVD możliwości tego rodzaju rozbudowy staną się powszechne i proste w realizacji. Odwiedź stronę "[www.philips.com/support](http://www.philips.com/support)" aby pobrać aktualizację oprogramowania.

Из-за несовместимости форматов дисков различных производителей для вашей системы DVD может быть необходимо произвести обновления или улучшить воспроизводимость. С развитием технологии DVD эти улучшения станут широкоиспользуемыми и просто выполняемыми. Обновление программного обеспечения находится на вб-сайт "[www.philips.com/support](http://www.philips.com/support)".



This product incorporates copyright protection technology that is protected by US patents. Use of this copyright protection technology must be authorised by Macrovision, and is intended for home and other limited viewing uses only unless otherwise authorised by Macrovision. Reverse engineering or disassembly is prohibited.

U.S. Patent Number 4,631,603; 4,819,098; 4,907,093; 5,315,448; and 6,516,132



Manufactured under license from Dolby Laboratories. "Dolby" and the double-D symbol are trademarks of Dolby Laboratories.



SHOWVIEW®, VIDEO Plus+ are registered trademark of Gemstar Development Corporation. SHOWVIEW® is manufactured under license from Gemstar Development Corporation.



DivX®, DivX Certified, and associated logos are trademarks of DivX, Inc. and are used under license.

**This product complies with the radio interference requirements of the European Community.**



**This product complies with the requirements of the following directives and guidelines: 73/23/EEC + 89/336/EEC + 93/68/EEC**

<b>LASER</b>	
Type	Semiconductor laser InGaAlP (DVD) AlGaAs (CD)
Wave length	658 nm (DVD) 90 nm (CD)
Output Power	30 mW (DVD+RW write) 1.0 mW (DVD read) 1.0 mW (CD read)
Beam divergence	84 degrees (DVD) 61 degrees (CD)

# Table of Contents

## General

<b>Care and Safety Information .....</b>	<b>8</b>
Setup precautions.....	8
Cleaning discs .....	8
About recycling.....	8
<b>Product Information .....</b>	<b>9-10</b>
Introduction.....	9
Accessories supplied .....	9
Region codes.....	9
Copyright notice.....	9
Product features.....	10
Possible simultaneous operations .....	10

## Product Overview

<b>Main Unit .....</b>	<b>11</b>
<b>Remote Control .....</b>	<b>12-14</b>
Using the remote control .....	14

## Connections

<b>Step 1: Basic Recorder Connections.....</b>	<b>15-17</b>
Connecting the antenna cables .....	15
Connecting the video cables.....	16
Connecting the audio cables .....	17
<b>Step 2: Optional Connections.....</b>	<b>18-19</b>
Connecting to a Cable Box or Satellite Receiver .....	18
Connecting a DV camcorder .....	19
Connecting another video device.....	19
<b>Step 3: Installation and Setup.....</b>	<b>20-22</b>
Finding the correct viewing channel .....	20
Setting the OSD language .....	20
Select the country of your residence .....	21
Setting the TV channel programmes.....	21
Setting the date & time.....	22

## Recording

<b>Recording .....</b>	<b>23-28</b>
Recording media .....	23
Recording settings .....	24
RECORD settings .....	25
Recording from various sources .....	26-27
Instant time-off recording.....	28
Watching disc playback during VCR recording.....	28
Watching another source during recording .....	28
<b>Timer Recording.....</b>	<b>29-32</b>
About timer recording.....	29
Timer recording (SHOWVIEW® / VIDEO Plus+ System).....	29-30
Timer recording (manually).....	30-32
Changing/ Deleting a timer recording.....	32

# Table of Contents

## Dubbing

<b>Direct Dubbing (Disc ↔ Tape)</b> .....	<b>33</b>
Dubbing from VCR to DVD .....	33
Dubbing from DVD to VCR.....	33

## Playback

<b>DVD Playback</b> .....	<b>34-38</b>
Playable discs .....	34
Starting disc playback.....	35-38
<b>Additional Playback Features</b> .....	<b>39-42</b>
Changing to another title/chapter/track .....	39
Pausing playback .....	39
Searching forward/backward.....	39
Using the TOOLS options .....	40-42
<b>VCR Playback</b> .....	<b>43</b>
Starting VCR playback.....	43

## Edit Recordings

<b>Edit Recording - Recordable DVD</b> .....	<b>44-51</b>
About disc editing .....	44
Accessing disc editing menu .....	44-46
Playing your recordings (DVD±R) on other DVD players.....	46
About title editing.....	47
Accessing title editing menu.....	47-48
About video editing .....	49
Accessing video editing menu.....	49-51

## Others

<b>DVD Setup Menu Options</b> .....	<b>52-59</b>
Accessing the Setup Menu .....	52
GENERAL settings.....	53
PLAYBACK settings .....	54-55
DVD settings .....	55-56
CHANNEL SETUP settings .....	57-58
CLOCK settings.....	59
<b>Other Information</b> .....	<b>60</b>
Installing the latest software .....	60
<b>Specifications</b> .....	<b>61</b>
<b>Troubleshooting</b> .....	<b>62-65</b>
<b>Frequently Asked Questions</b> .....	<b>66-67</b>
<b>Glossary</b> .....	<b>68-69</b>
<b>Display panel symbols/ messages</b> .....	<b>70</b>
<b>TV System Guide</b> .....	<b>71-72</b>

## Care and Safety Information

### CAUTION!

**High voltage! Do not open the device. You run the risk of getting an electric shock.**

**The machine does not contain any user-serviceable parts. Please leave all maintenance work to qualified personnel.**

### Setup precautions

#### Finding a suitable location

- Place the set on a flat, hard and stable surface. Do not place the set on a carpet.
- Do not place the set on top of other equipment that might heat it up (e.g., receiver or amplifier).
- Do not put anything above or under the set (e.g., CDs, magazines).
- Install this unit near the AC outlet and where the AC power plug can be reached easily.

#### Space for ventilation

- Keep the distances 20 cm around apparatus of ventilation openings. Do not place the device on an unsteady base.
- The mains plug shall remain readily operable.

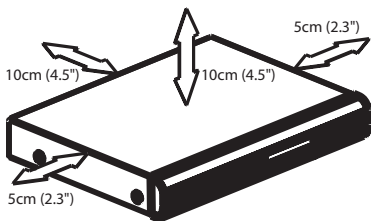

#### Avoid high temperature, moisture, water and dust

- Apparatus should not be exposed to dripping or splashing.
- Do not place any object or items that can damage the apparatus (e.g., liquid filled objects, lighted candles).

### Cleaning discs

Some problems occur (frozen picture, sound disruptions, picture distortions) because the disc in the apparatus is dirty. To avoid these problems, discs should be cleaned on a regular basis.

To clean a disc, use a micro fibre cleaning cloth and wipe the disc from centre to the edge in straight line movement.

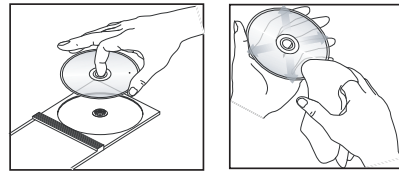

### CAUTION!

Do not use solvents such as benzene, thinner, commercially available cleaners, or anti-static sprays for discs.

Since the optical unit (laser) of the recorder operates at a higher power than regular DVD or CD players, Cleaning CD intended for DVD or CD players may damage the optical unit (laser). Therefore, refrain from using a Cleaning CD.

### About recycling

These operating instructions have been printed on non-polluting paper. This electronic equipment contains a large number of materials that can be recycled. If you are disposing off an old equipment, please take it to a recycling centre. Please observe the local regulations regarding disposal of packaging materials, exhausted batteries and old equipment.



## Product Information

### Introduction

Your Philips DVD recorder comes with a built-in VCR deck. It allows recording to DVD±RW, DVD±R, DVD+R DL and VHS tape. In addition, you can enjoy playback of DVD discs and VHS tapes. The DVD±R discs have to be finalised before they can be played on other DVD players.

Before you can start using this recorder, complete the basic connections and set-up in three simple steps.

#### Step 1: Basic recorder connections

#### Step 2: Optional connections for other devices

#### Step 3: Basic installation and set-up

Please take time to read this user manual before using your recorder. It contains important information and notes regarding operations of the recorder.

#### Helpful Hints:

- If you have questions or problems occur during operation, see chapter 'Troubleshooting'.
- If you need further assistance, please call the customer support service for your country. The corresponding telephone numbers and e-mail addresses are given in the guarantee booklet.
- Refer to the type plate on the rear or bottom of the product for identification and supply ratings.

### Accessories supplied

- Remote control and batteries
- RF coaxial cable
- Quick Start Guide

### Region codes

DVD movies are usually not released at the same time in all regions of the world, thus all DVD players are programmed to a specific region code.

This device will only play **Region 2** DVDs or DVDs manufactured to be played in all regions ('ALL'). DVDs from other regions cannot be played on this recorder.



### Copyright notice

The making of unauthorised copies of copy-protected material, including computer programmes, files, broadcasts and sound recordings, may be an infringement of copyrights and constitute a criminal offence. This equipment should not be used for such purposes.

## Product Information (continued)

### Product features

#### SHOWVIEW VIDEO *Plus+*

This is a simple programming system for recorders. To use it, enter the programming number associated with your television programme. You can find this number in your favourite listings magazine.

**Note:** In the UK and Ireland the ShowView system is called VIDEO Plus+ system and ShowView Programming Number is called PlusCode Programming Number.



i.Link is also known as 'FireWire' and 'IEEE1394'. This connection is used for transferring of high bandwidth digital signals used by digital video (DV) camcorders. It carries all audio and video signals via a single cable.



Philips DVD recorders support 'dual media' recording – the ability to create recordings on + and – discs (DVD+R/+RW, DVD+R DL, DVD-R/-RW).

#### Direct Dubbing

The built-in VCR deck makes it simple to copy your recordings from VHS tape to DVD or from DVD to VHS tape with a single press of a button.

### Possible simultaneous operations

Current Operation	DVD		VCR	
	Play	Record	Play	Record
Play DVD	—	✗	✗	✓
Record on DVD	✗	—	✗	✗
Play VCR	✗	✓	—	✗
Record on VCR	✓	✗	✗	—

- When you play a DVD disc, only dubbing from DVD disc to VCR is possible to operate simultaneously.
- When you record to a DVD recordable disc, no other operations can be carried out simultaneously.
- When you play a VHS tape, only dubbing from VCR to DVD is possible to operate simultaneously.
- When you record to a VHS tape, only DVD playback is possible to operate simultaneously.

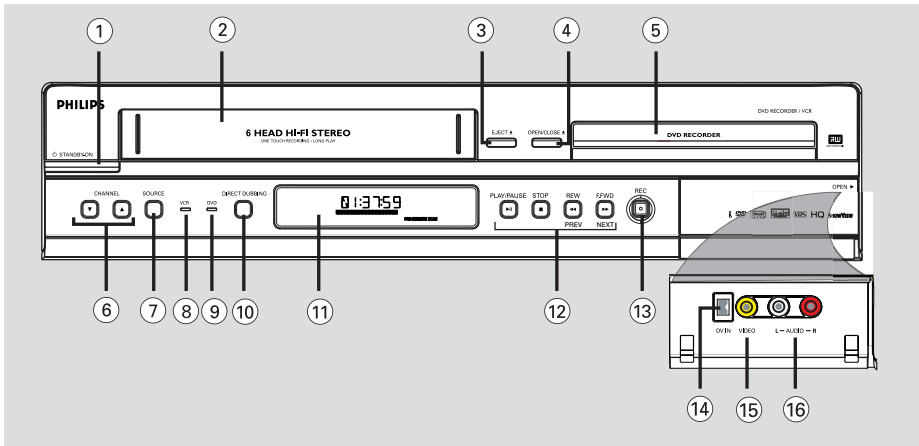

## ① STANDBY-ON

- Turns on the recorder or to standby mode.

## ② Tape deck

## ③ EJECT

- Ejects the VHS tape.

## ④ OPEN/CLOSE

- Opens/closes the disc tray.

## ⑤ Disc tray

## ⑥ CHANNEL

- While in tuner, selects the next or previous TV channel.

## ⑦ SOURCE

- Selects the recorder's input source (EXT1, EXT2, TUNER, CAM1, DV).

## ⑧ VCR indicator

- Lights up while in VCR mode.

## ⑨ DVD indicator

- Lights up while in DVD mode.

## ⑩ DIRECT DUBBING

- Copies from a VHS tape to a recordable DVD or vice-versa.

## ⑪ System display panel

- Shows information about the current status of the recorder.

## ⑫ PLAY/PAUSE

- Starts playback.
- Pauses the playback/recording/dubbing.

## STOP

- Stops playback/recording.

## REW / F.FWD (PREV / NEXT)

- Skips to the previous or next title/ chapter/track.
- Press and hold this button for fast forward and backward search.

## ⑬ REC

- Start recording the current TV channel or the current video input source.
- Press repeatedly to set up a One Touch Recording at 30, 60 or 90 minutes interval.

### Sockets behind the flap

Flip down the door as indicated by the **OPEN**  label at the right hand corner.

## ⑭ DV IN

- Input for digital camcorder or other suitable devices using this connector.

## ⑮ VIDEO

- Video input for camcorder or video recorder.

## ⑯ AUDIO L/R

- Audio input for camcorder or video recorder.

# Remote Control

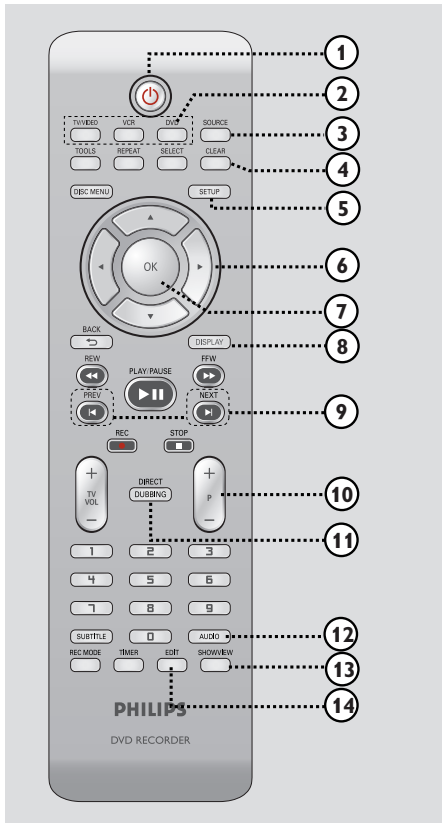

- ① **Power**
- Turns on the recorder or to standby mode.
- ② **TV/VIDEO**
- Switch between playback from additional devices (connected via EXT2 AUX I/O socket) and playback from the recorder.
- DVD**
- Switch to DVD mode.
- VCR**
- Switch to VCR mode.
- ③ **SOURCE**
- Selects the recorder's input source (EXT1, EXT2, TUNER, CAM1, DV).

- ④ **CLEAR**
- Clears a track/chapter/file in the selection playlist/copylist.
  - Clears a timer entry.
  - Resets tape counter to zero.
- ⑤ **SETUP**
- Enters/exits the system setup menu.
- ⑥ **Left/Right Arrow** : Cursor buttons for moving to the left or right, do a forward/reverse search.  
**Up/Down Arrow** : Cursor buttons for moving up/down or changing the recorder's TV tuner channel.
- ⑦ **OK**
- Stores/confirms an entry.
- ⑧ **DISPLAY**
- Displays/removes the status bar.
- ⑨ **PREV ◀ / NEXT ▶**
- Skips to previous or next chapter/track/index.
- ⑩ **P + / -**
- While in tuner, select the next or previous TV channel.
  - While in VCR mode, adjust the picture quality (tracking).
- ⑪ **DIRECT DUBBING**
- Copies from a VHS tape to a recordable DVD or vice-versa.
- ⑫ **AUDIO**
- Selects an audio language (DVD, VCD) or an audio channel (CD, VHS).
- ⑬ **SHOWVIEW**
- Enters/exits the SHOWVIEW menu.
- VIDEO Plus+ (for UK only)**
- Enters/exits the VIDEO PLUS+ menu.
- ⑭ **EDIT**
- Enters/exits the video editing menu.

## Remote Control (continued)

### 15 REPEAT

- Selects to repeat playback of title, chapter, track or disc in DVD mode.

### 16 TOOLS

- Enters/exits the tools or disc/title editing menu.

### 17 SELECT

- Selects a track/chapter/file in the programme menu.

### 18 DISC-MENU

- Accesses DVD disc menu or Index Picture screen of a DVD±R/±RW.
- Accesses VCD disc menu when PBC is turned on.

### 19 BACK ↵

- Returns to the previous menu of a video CD (VCD).

### 20 REW ◀◀ / FFW ▶▶

- Fast reverse or fast forward search.

### 21 PLAY/PAUSE ▶▶II

- Starts playback.
- Pauses the playback/recording/dubbing.

### REC ●

- Start recording the current TV channel or the current video input source.
- Press repeatedly to set up a One Touch Recording at 30, 60 or 90 minutes interval.

### STOP ■

- Stops playback/recording/dubbing.
- Press and hold the button to open/ close the disc tray.

### 22 TV VOL + / -

- Adjusts the volume of the TV (Philips TV only).

### 23 Numeric keypad

- Selects a chapter/track number to play.
- Selects the recorder's preset TV tuner channel.

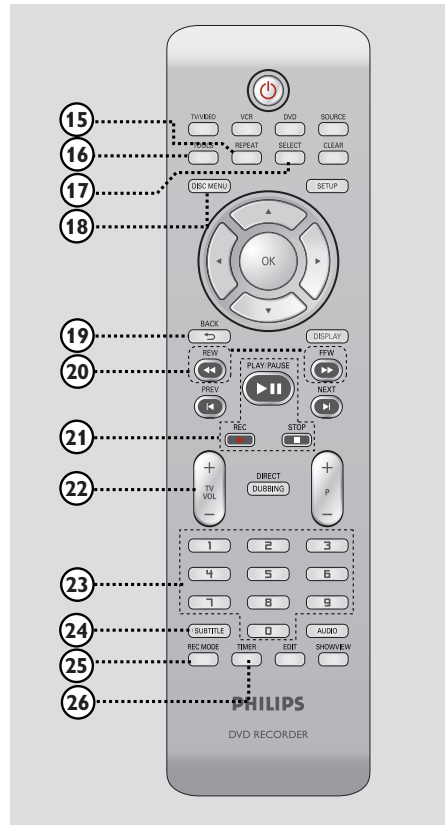

### 24 SUBTITLE

- Selects a DVD subtitle language.

### 25 REC MODE

- Toggles between recording modes: HQ, SP, SPP, LP, EP or SLP. VCR: SP & LP
- This determines the quality of recording and the amount/length of time you can record on a DVD±R/±RW.

### 26 TIMER

- Enters/exits the timer recording menu.

## Remote Control (continued)

### Using the remote control

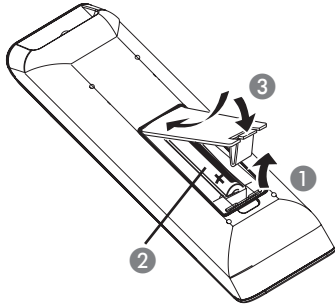

- 1 Open the battery compartment.
- 2 Insert two batteries type R03 or AAA, following the indications (+ -) inside the compartment.
- 3 Close the cover.
- 4 Point the remote control directly at the remote sensor (iR) on the front panel.

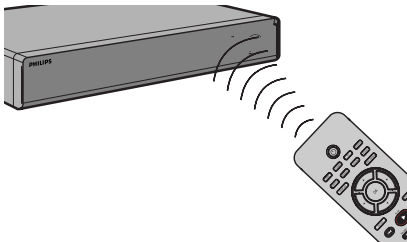

- 5 Select the source you wish to control by pressing the **DVD**, **VCR** or **SOURCE** button on the remote control.
- 6 Then select the desired function (for example ◀◀, ▶▶).

### CAUTION!

- Remove batteries if they are exhausted or if when the remote control is not to be used for a long time.
- Do not mix batteries (old and new or carbon and alkaline, etc.).
- Batteries contain chemical substances, so they should be disposed of properly.

# Step 1: Basic Recorder Connections

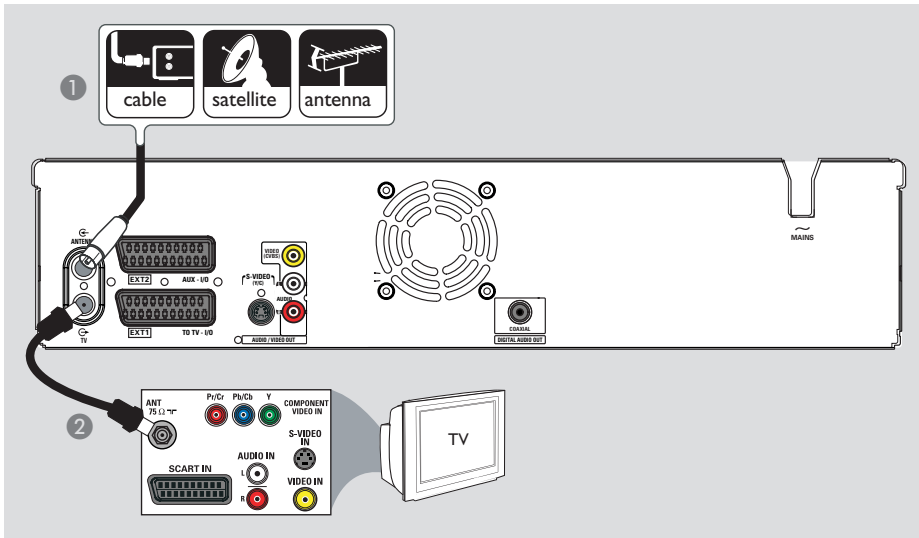

## Connecting the antenna cables

These connections enable you to watch and record TV programmes using the recorder. If the antenna signal is connected via Cable Box or Satellite Receiver, ensure that these devices are turned on in order to watch or record the cable programmes.

- **If you want to connect to a Cable Box/Satellite Receiver**, see the chapter “Step 2 : Optional Connections – Connecting to a Cable Box or Satellite Receiver” for the complete connections to your TV.

- 1 Connect the existing Antenna/Satellite Receiver/Cable TV signal (labelled as RF OUT or TO TV) to the **ANTENNA-IN** socket on the recorder.
- 2 Use the supplied RF coaxial cable to connect the **TV-OUT** socket on the recorder to the antenna input socket (or labelled as VHF/UHF RF IN) on your TV.

### Helpful Hint:

– Depending on how you have currently connected your TV channel (directly from an off-air antenna or Cable box or VCR), you may have to disconnect some of the cables before you make the antenna connection.

**TIPS:** Before making or changing any connections, make sure that all the devices are disconnected from the power outlet.

## Step I: Basic Recorder Connections (continued)

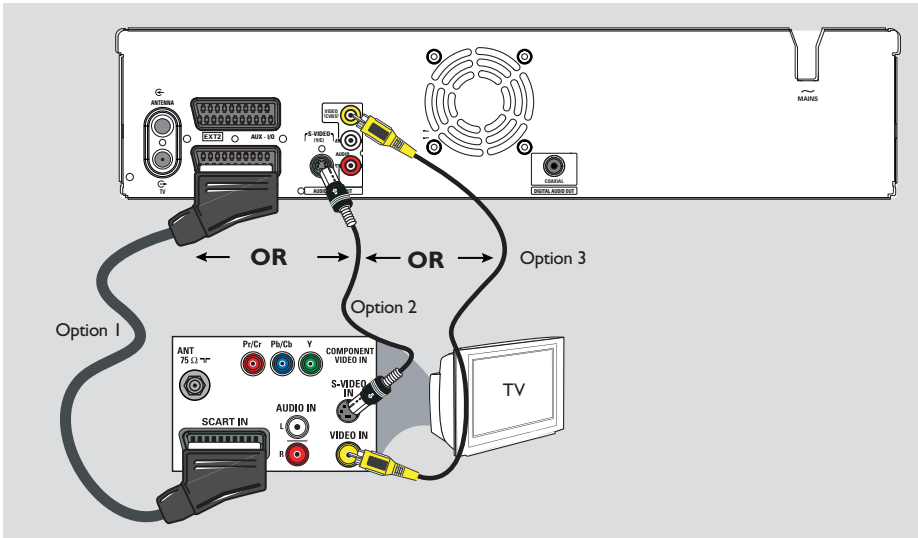

### Connecting the video cables

This connection enables you to view the disc playback from the recorder. You only need to choose **one** of the options below to make your video connection.

#### Option 1: Using a SCART cable

- Use a SCART cable (not supplied) to connect the **EXT1 TO TV-I/O** socket on the recorder to the corresponding SCART input socket on the TV.

#### Helpful Hints:

- If your TV has several SCART sockets, select the SCART socket that is suitable for both video output and video input.
- If your TV displays a selection for the SCART socket, select 'VCR' as the source for the SCART socket.
- The EXT2 AUX-I/O socket is intended only for additional devices.

#### Option 2: Using an S-Video cable

- Use an S-video cable (not supplied) to connect the **S-VIDEO OUTPUT** socket on the recorder to the S-Video input socket (or labelled as Y/C or S-VHS) on the TV.  
→ Audio connection is required in order to hear the sound, see next section "Connecting the audio cables".

#### Option 3: Using a Video (CVBS) cable

- Use a composite video cable (yellow end - not supplied) to connect the **VIDEO (CVBS) OUTPUT** socket on the recorder to the video input socket (or labelled as A/V In, Video In, Composite or Baseband) on the TV.  
→ Audio connection is required in order to hear the sound, see next section "Connecting the audio cables".

**TIPS:** Before making or changing any connections, make sure that all the devices are disconnected from the power outlet.



## Step 1: Basic Recorder Connections (continued)

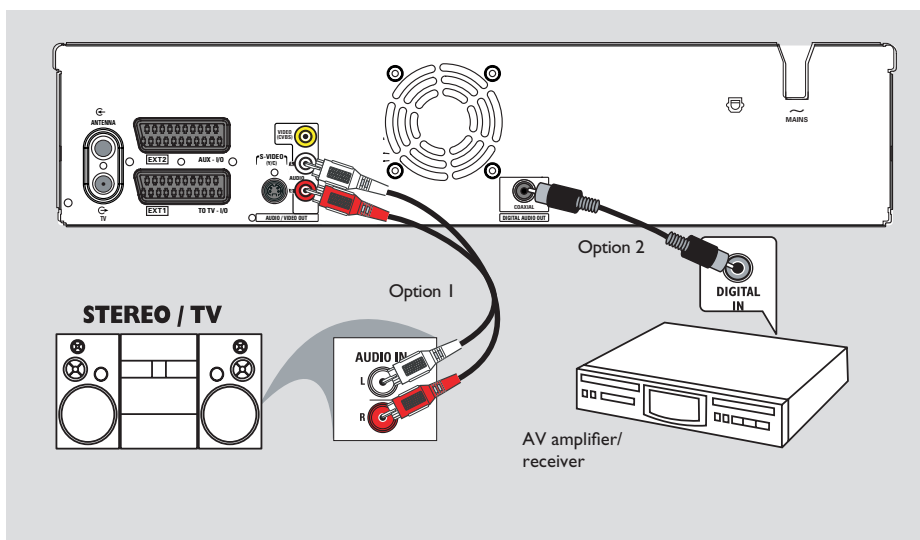

### Connecting the audio cables

This connection enables you to listen to the playback from the recorder. However, this connection is not required if the recorder is connected to the TV using the SCART cable.

#### Option 1: Using an audio cable

You can connect the recorder to a two channel stereo system (mini system, TV) or receiver in order to enjoy the stereo sound system.

- Use an audio cable (red/white ends - not supplied) to connect the **AUDIO L/R OUTPUT** sockets to the audio input sockets of the connected device.

#### Option 2: Using a coaxial cable

You can connect the recorder to an AV amplifier/receiver with a digital multi-channel sound decoder in order to enjoy multi-channel surround sound.

- Use a coaxial cable to connect the **COAXIAL (DIGITAL AUDIO)** socket on the recorder to the digital input socket on the amplifier/receiver.

Before you start operating, set the digital audio output settings accordingly (see the section “DVD Setup Menu Options – PLAYBACK settings – Digital Audio Output”).

If the setting does not match your stereo’s capabilities, the stereo may produce a strong, distorted sound or no sound at all.

**TIPS:** Before making or changing any connections, make sure that all the devices are disconnected from the power outlet.

## Step 2: Optional Connections

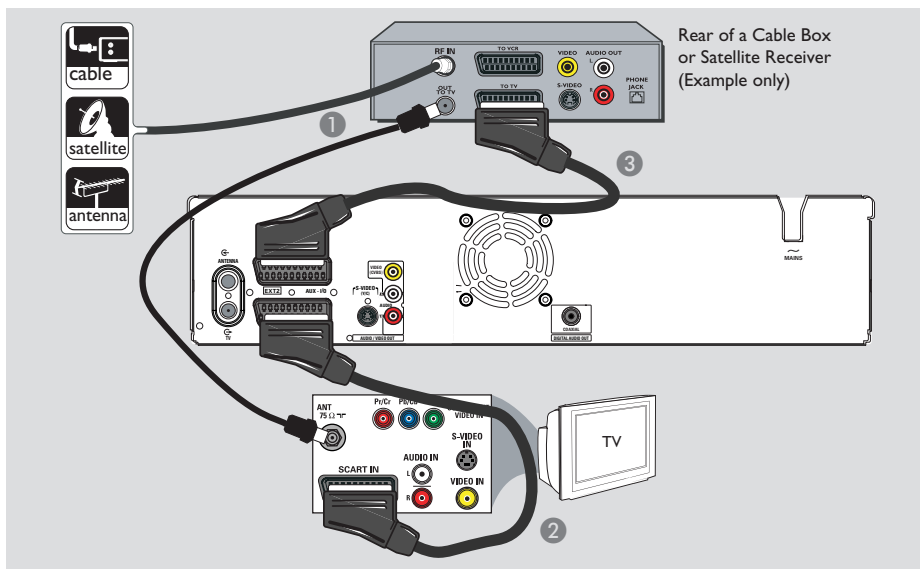

### Connecting to a Cable Box or Satellite Receiver

#### Option 1

**If your Cable Box/Satellite Receiver has only an antenna output socket (RF OUT or TO TV),**

see "Step 1: Basic Recorder Connections – Connecting the antenna cables" for the complete connections to your TV.

#### Option 2

**If your Cable Box/Satellite Receiver has a SCART output socket**

- 1 Keep the existing antenna connection from the Cable Box/Satellite Receiver to your TV.
- 2 Use the SCART cable to connect the **EXT1 TO TV-I/O** socket on the recorder to the corresponding SCART input socket on the TV.
- 3 Use another SCART cable to connect the **EXT2 AUX-I/O** socket on the recorder to the SCART output socket (or labelled as TV OUT or TO TV) on the Cable Box/Satellite Receiver.

To start playback, select the TV channel directly on the Cable Box/Satellite Receiver. To view picture from a connected external device, press the **TV/VIDEO** button on the remote control.

**TIPS:** Refer to the respective connected device's user manual for other possible connections.

## Step 2: Optional Connections (continued)

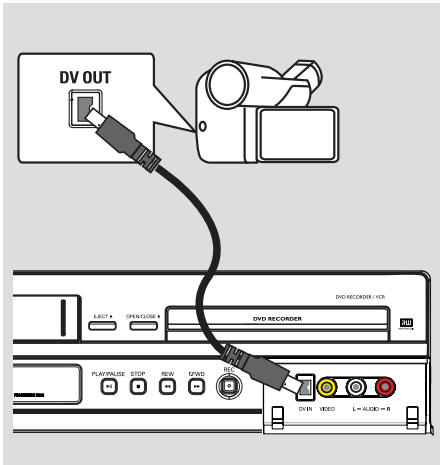

### Connecting a DV camcorder

Use this if you have a Digital Video or Digital 8 camcorder. The DV socket conforms to the i.LINK standard.

- Use an i.LINK 4-pin cable (not supplied) to connect the **DV IN** socket at the front panel of the recorder to the appropriate DV OUT socket on the camcorder.

Before you start operating, press **SOURCE** on the remote control repeatedly to select 'DV' as the input channel.

#### Helpful hints:

- The DV IN socket does not support connection to a Personal Computer.
- It is NOT possible to record from the recorder to your camcorder via the DV IN socket on your recorder.

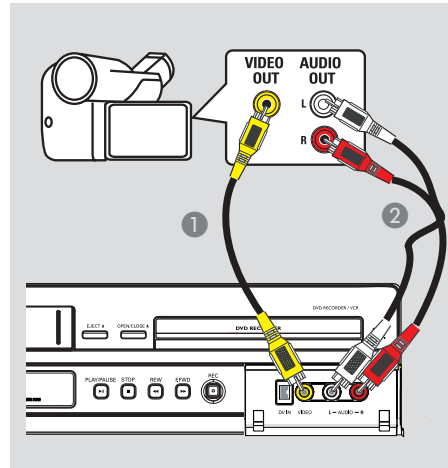

### Connecting another video device

You can use the front sockets connection to copy the playback from another video device (for example, camcorder, VCR or DVD player).

- 1 Use a video cable (not supplied) to connect the **VIDEO** socket from the front panel of the recorder to the Video output socket of the connected video device.
- 2 Use an audio cable (not supplied) to connect the **AUDIO L/R** sockets to the audio output sockets of the connected video device.

Before you start operating, press **SOURCE** on the remote control repeatedly to select 'CAM 1' as the input channel.

**TIPS:** Refer to the respective connected device's user manual for other possible connections.

## Step 3: Installation and Setup

### Before you start...

When you completed the connections and turn on the recorder for the first time, it is advisable that you perform several basic settings.

Please see the following pages on using the system setup menu features to programme TV channels, menu language and system clock settings. This will optimise the performance of this recorder.

### Finding the correct viewing channel



- 1 Press **STANDBY-ON** on the recorder to turn it on.
- 2 Turn on the TV and set it to the correct video-in channel. You should see the blue DVD background screen.
  - You may go to Channel 1 of your TV, then press the Channel Down button on your TV's remote control until you see the Video In channel.
  - You may press  button repeatedly on your TV's remote control.
  - Usually this channel is between the lowest and highest channels and may be called FRONT, A/V IN, VIDEO. See your TV manual for more details.

### Setting the OSD language

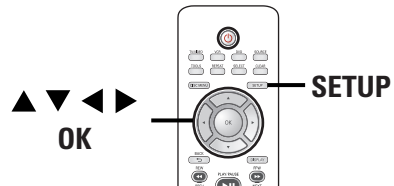

Select the menu language for this recorder's on-screen display. The language options are different depending on your country or region. It may not correspond to the illustrations shown on the user manual.

**Language settings can only be changed when the disc stops playing or there is no disc in the disc tray.**

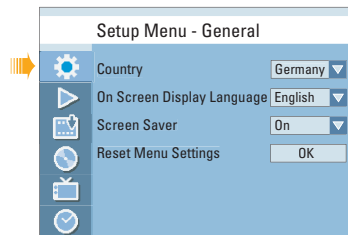

- 1 Press **SETUP**.
  - The system setup menu appears on the TV.
- 2 Use  keys to highlight  { **Setup Menu - General** } and press  to access the menu.



- 3 Use  keys to highlight { **On Screen Display Language** } and press **OK** to access its options.
- 4 Use  keys to highlight the desired language and press **OK** to confirm.

**TIPS:** Press  to access the options of an item in the menu. Press **SETUP** to exit the menu.

## Step 3: Installation and Setup (continued)

### Select the country of your residence

Select the country of your area for auto channel tuning.

- 1 Press **SETUP** on the remote control.  
→ The system setup menu appears on the TV.
- 2 Use ▲▼ keys to highlight  { **Setup Menu - General** } and press ►.

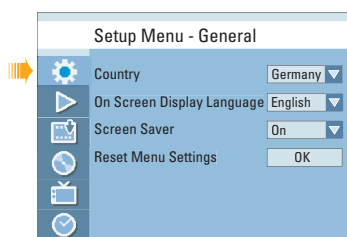

- 3 Select { **Country** } and press **OK**.
- 4 Use ▲▼ keys to select the country of your residence and press **OK** to confirm.

### Setting the TV channel programmes

Before the recorder is able to start recording the TV channel programmes, you need to search for the available TV channels and store them in the recorder.

**Language settings can only be changed when the disc stops playing or there is no disc in the disc tray.**

#### Before you start ...

Make sure you have successfully made all the required connections to the recorder, the TV and Satellite Receiver/ Cable Box (if any) and turned them on.

- 1 Press **SETUP** on the remote control.  
→ The system setup menu appears on the TV.
- 2 Use ▲▼ keys to highlight  { **Setup Menu - Channel Setup** } and press ►.

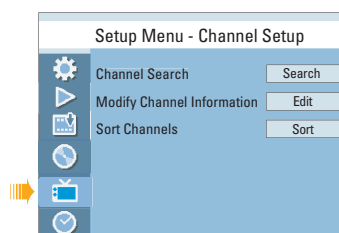

- 3 Select { **Channel Search** } and press **OK**.  
→ The automatic TV channel search starts. This process may take several minutes. Once complete, the total number of channels found and stored appears on the TV.

**To modify or sort the TV channels,** see the chapter “DVD Setup Menu Options - CHANNEL SETUP settings”.

**TIPS:** Press ► to access the options of an item in the menu.  
Press **SETUP** to exit the menu.

## Step 3: Installation and Setup (continued)

### Setting the date & time

This recorder has an automatic date and time setting feature. If the recorder has not set the time and date correctly, you can further adjust the clock settings

- 1 Press **SETUP**.  
→ The system setup menu appears.
- 2 Use ▲▼ keys to select  { **Setup Menu - Clock** } and press ► to confirm.

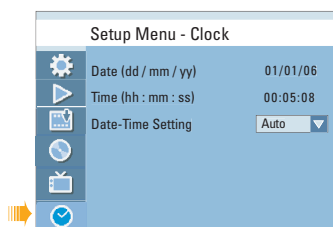

- 3 Select { **Date-Time Setting** } and press ►.  
→ Use ▲▼ keys to highlight { **Manual** } and press **OK**.
- 4 Select { **Date (dd/mm/yy)** } and press **OK** to edit the date fields.  
→ Use ▲▼ keys to change number and use ◀▶ keys to select different entry fields, then press **OK** to confirm.
- You can also use the **numeric keypad 0-9** on the remote control to key in the numbers.
- 5 Press **OK** to confirm.
- 6 To set { **Time (hh:mm:ss)** }, repeat steps 4~5.

**The basic installation is complete.**

**TIPS:** Press ► to access the options of an item in the menu.  
Press **SETUP** to exit the menu.

This recorder can be used to record TV programme or copy the content from an external device to a DVD recordable disc or VHS tape. The storage capacity of the disc and tape are depending on the recording mode selected. This recorder also incorporates timer recording function with which you can prepare a recording schedule before hand.

## Recording media

The recording media for this recorder are DVD±R/±RW/+R DL and VHS tape.



### DVD±RW (DVD Rewritable)

- Discs that are rewritable can be used for multiple recordings once the existing data is erased.



### DVD±R (DVD Recordable)

- Discs can only be used for a single recording. Each new recording is always added at the end of all previous recordings as existing recordings cannot be overwritten.
- Editing can be done on DVD±R discs as long as they have not been finalised.
- To playback a DVD±R on other DVD player, it must be finalised (see the chapter "Editing/ Finalising Recording – Playing your recordings (DVD±R) on other DVD players"). After this is done, no more data can be added to the disc.



### DVD+R DL (DVD+R Double Layer)

- It contains the same usage as DVD+R, the only difference is the capacity of 8.5 GB. It offers two recordable layers on a single DVD disc. The layers are accessible from the same side of the disc, so recording can occur completely uninterrupted.

### Supported disc type and media speeds

Disc	Media speeds
DVD+R	1x - 16x
DVD+RW	2.4x - 4x
DVD-R	1x - 16x
DVD-RW	2.4x - 4x
DVD+R DL	2.4x



### VHS Tape

- VHS tapes have record safety tabs to ensure that recordings will not be accidentally erased. To prevent recording, break off the tab. To allow recording, cover the hole of the tab with clear tape.
- Without the record safety tab, the VHS tape will start playback once your insert the VHS tape into the tape slot.
- The VCR automatically marks the tape with an index signal at the point where each recording begins.

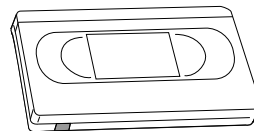

Record Safety Tab

## Recording (continued)

### IMPORTANT!

#### Unrecordable contents

Contents with copy protection cannot be recorded on this recorder. When the recorder receives a copy guard signal, recording will be paused.

### Recording settings

The default recording settings allow you to set the auto chapter markers, preferred recording input source and recording mode. Any changes made using the remote control will only apply to the current recording settings. The default recording settings will remain unchanged for the next recording.

- 1 Press **SETUP** on the remote control.  
→ The system setup menu appears on the TV.
- 2 Use ▲▼ keys to select  { **Setup Menu - Record** } and press ► to confirm.

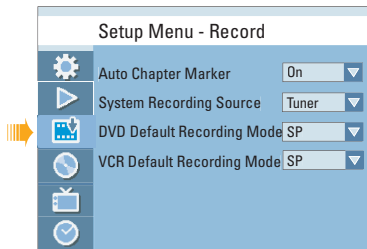

- 3 Use ▲▼ keys to select the setting you wish to change and press **OK** to confirm.  
→ Instructions and explanations of the options are provided in the following pages.
- 4 To exit, press **SETUP**.



## Recording (continued)

### **RECORD settings** (underlined options are the factory default settings)

#### **Auto Chapter Marker**

Automatically divides a recording (title) into chapters by inserting chapter markers at a specific interval. This enables you to access a specific point in the recording quickly.

- { On } – Chapter markers will automatically be inserted within the title during recording at every 5 (five) minutes interval.
- { Off } – No chapter marker will be inserted in the recording.

#### **Default Recording Source**

Define your frequent source of recording. The recorder will switch to the default source whenever it is turned on.

- { Tuner } – Input source from TV programmes.
- { CAMI } – Input source from the device connected to the VIDEO and AUDIO L/R sockets at the front panel.
- { DV } – Input source from the device connected to DV IN socket at the front panel.
- { EXT 1 } – Input source from the device connected to the EXT1 TO TV-I/O SCART socket at the rear panel.
- { EXT 2 } – Input source from the device connected to the EXT2 AUX-I/O SCART socket at the rear panel.

**Note:** To change the current recording source without changing the default setting, you can press the **SOURCE** button on the remote control.

#### **DVD Default Recording Mode**

The recording mode defines the picture quality of the DVD recordings and the maximum recording time on a disc. The factory default setting is **SP**.

Record Mode	Picture Quality	Maximum Recording Time per Disc (hours)
HQ	High Quality	1
SP	Standard Play	2
SPP	Standard Play Plus	2.5
LP	Long Play	3
EP	Extended Play	4
SLP	Super Long Play	6

#### **VCR Default Recording Mode**

The recording mode defines the picture quality of VCR recordings and the maximum recording time on a VHS tape. The available recording modes for VCR are **SP** and LP.

## Recording (continued)

### Recording from various sources

This recorder has various external input signal terminals that can be used to record or playback, including Tuner input, S-Video input, composite video input, DV input, Scart input and stereo audio input.

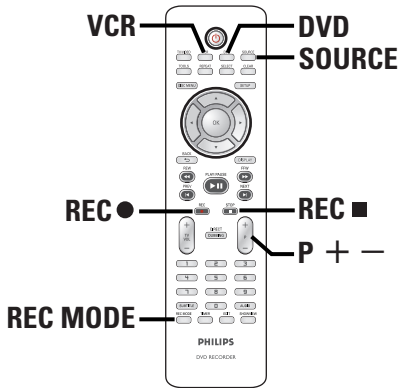

### Recording TV programmes

- 1 Turn on the TV to the correct viewing channel for the recorder (e.g. 'EXT', '0', 'AV').
- 2 Press **DVD** or **VCR** to select the destination of recording.
- 3 Insert a recordable DVD or VHS tape into the recorder.  
→ For VHS tape, locate the start point position for recording.
- 4 Press **SOURCE** on the remote control to select { **Tuner** }, then use **P + / -** keys to select the TV channel you wish to record.

- 5 Set a recording mode as necessary by pressing **REC MODE** repeatedly.
- 6 Press **REC ●** to start recording.  
→ If the disc has contained some recordings, the new recording will automatically start after the last recording on the disc.  
→ For VHS tape, it will start recording from the current stop position.
- To pause the recording, press **▶II**. To continue recording, press **REC ●**.  
→ You can use this function to avoid recording commercials.
- 7 To stop the recording, press **STOP ■**.  
→ Otherwise, recording continues until the disc or tape is full.

#### Helpful Hint:

– When recording onto a VHS tape, you can change the recording channel when the recording is in pause mode. However, you cannot change a recording channel in the DVD recording pause mode.

### Recording from an external device (Camcorder/VCR/DVD Player)

Record video directly from an external device.

- 1 Connect the external device to this recorder. See the chapter "Step 2: Optional Connections".
- 2 Turn on the TV to the correct viewing channel for the recorder (e.g. 'EXT', '0', 'AV').
- 3 Press **DVD** or **VCR** to select the destination of recording.
- 4 Insert a recordable DVD or VHS tape into the recorder.  
→ For VHS tape, locate the start point position for recording.

**TIPS:** Ensure that there is sufficient space available on the recordable DVD or VHS tape before recording. You have to finalise the DVD±R before it can be playback on other players.

## Recording (continued)

- 5 Press **SOURCE** repeatedly to select the correct input channel that matches the connected socket of the device.

{ **EXT 1** }

Input source from the device connected to the EXT1 TO TV-I/O SCART socket at the rear panel.

{ **EXT 2** }

Input source from the device connected to the EXT2 AUX-I/O SCART socket at the rear panel.

{ **CAM 1** }

Input source from the device connected to the VIDEO and AUDIO L/R sockets at the front panel.

- 6 Set a recording mode as necessary by pressing **REC MODE** repeatedly.
- 7 Press **REC** ● to start recording.  
→ You can press **REC** ● repeatedly to increase the recording time in 30-minute increments.
- 8 Start playback on the connected device.
- To pause the recording, press ►|| once. To continue recording, press **REC** ● again.  
→ You can use this function to avoid any unwanted recording.
- 9 To stop the recording, press **STOP** ■.  
→ Otherwise, recording continues until the disc or tape is full.

### Recording from an DV camcorder

Record video directly from a connected DV camcorder to a DVD recordable disc.

- 1 Connect the DV camcorder to **DV IN** socket at the front of the recorder.
- 2 Find the footage on the DV camcorder where you want to start recording and set the camcorder to pause mode.
- 3 Turn on the TV to the correct viewing channel for the recorder (e.g. 'EXT', '0', 'AV').
- 4 Press **DVD** or **VCR** to select the destination of recording.
- 5 Insert a recordable DVD or VHS tape into the recorder.  
→ For VHS tape, locate the start point position for recording.
- 6 Press **SOURCE** on the remote control to select { **DV** }.
- 7 Press **REC** ● to start recording and press the **PLAY** button on the DV camcorder to start playback.
  - To pause the recording, press ►||. To continue recording, press **REC** ● again.
- 8 To stop the recording, press **STOP** ■.  
→ A new title/index will be created when you begin another recording.

**TIPS:** Ensure that there is sufficient space available on the recordable DVD or VHS tape before recording. You have to finalise the DVD±R before it can be playback on other players.

## Recording (continued)

### Instant time-off recording

This function allows you to make a recording with a preset length easily without using the timer programming.

- 1 Press **P** + **-** to select the programme number to record, for example 'P01'.
  - 2 Press **DVD** or **VCR** to select the destination of recording.
  - 3 Insert a recordable DVD or VHS tape into the recorder.  
→ For VHS tape, locate the start point position for recording.
  - 4 Set a recording mode as necessary by pressing **REC MODE** repeatedly.
  - 5 Press **REC** ● repeatedly to select the recording time length. Each subsequent press increases the recording time by 30 minutes.
  - 6 The recorder will stop recording at the designated end time and turn off to standby mode automatically.
- If you wish to stop the recording before the scheduled time, press **STOP** ■.

### Watching disc playback during VCR recording

If you wish to watch the DVD playback during the VCR recording, press **DVD** to switch to DVD mode and perform the DVD playback. You cannot playback the VCR during DVD recording.

### Watching another source during recording

While recording is in progress, you can watch another TV channel or playback from other audio/video device which is connected to this recorder.



#### Watching playback from another device

This is only possible if the recorder is connected to the TV using the EXT1 TO TV-I/O socket.

- Press **TV/VIDEO** to view the picture from the device which is connected to the EXT2 AUX-I/O socket of this DVD recorder.

#### Watching another TV channel

If there is no device connected to the EXT2 AUX-I/O socket, pressing **TV/VIDEO** will switch to TV mode.

- Use the TV's remote control to change the channels.  
→ The message "TV/LOOP" will be displayed on the recorder's system display panel.
- To switch back to recorder mode, press **TV/VIDEO** on the remote control.

#### Helpful Hint:

– Remember to switch the TV back to its video input channel if you want to watch the TV channel through the recorder or playback the recorded disc.

**TIPS:** Ensure that there is sufficient space available on the recordable DVD or VHS tape before recording. You have to finalise the DVD±R before it can be playback on other players.

## Timer Recording

### About timer recording

Use the timer recording to automatically start and stop a recording at a later date/time. The recorder will tune to the right programme channel and begin recording at the specified time.

With this recorder, you can schedule up to **8 recordings** at a time. During timer recording, changing the recorder's channel is not possible.

#### There are two ways to programme a timer recording

- Using the ShowView / VIDEO Plus+ system.
- Using manual timer schedule.

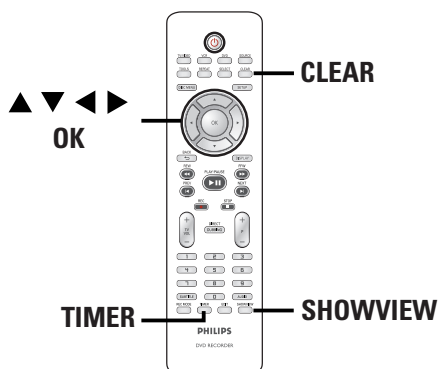

#### About 'VPS/PDC'

'VPS' (Video Programming System) or 'PDC' (Programme Delivery Control) is used to control the start and duration of TV channel recordings. If a TV programme starts earlier or ends later than was scheduled, the recorder will then turn on and off at the correct time.

VPS/PDC is intended to record the entire programme. To set a timer that is longer/shorter than the VPS/PDC broadcast time, you must switch off the VPS/PDC.

**TIPS:** Ensure that there is sufficient space available on the recordable DVD or VHS tape before recording. You have to finalise the DVD±R before it can be playback on other players.

### Timer recording (SHOWVIEW® / VIDEO Plus+ System)

This is a simple timer programming system. To use, enter the ShowView programming number / VIDEO Plus+ PlusCode number associated with your television programme. You can find this number in your TV listings magazine.

All the information needed by this recorder for programming is contained in the programming number.

- 1 Turn on the TV to the correct viewing channel for the recorder (e.g. 'EXT', '0', 'AV').
- 2 Press **SHOWVIEW** (or **VIDEO Plus+**) on the remote control.  
→ The **SHOWVIEW / VIDEO Plus+ System** menu appears.

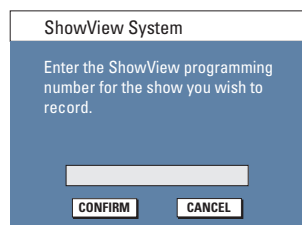

- 3 Use the **numeric keypad 0-9** to enter the ShowView / PlusCode programming number for the show you wish to record. (e.g. : 5-312-4 or 5,312 4, key in '53124').
- To clear the programming number, press **CLEAR** on the remote control.
  - To cancel the programme, move to **CANCEL** in the menu and press **OK**.

## Timer Recording (continued)

- 4 To confirm your entry, move to **CONFIRM** in the menu and press **OK**.  
 → The programme information will be shown on the timer editor menu.

Timer Editor		09 : 05 : 56
Source	Ch003	▼
Dest.	DVD	▼
Rec Mode	SP	▼
Mode	Once	▼
Date	01 / 01 / 06	
Start	10 : 33	
End	11 : 03	
VPS	Off	▼
<input type="button" value="OK"/> <input type="button" value="CANCEL"/>		

**Note:** You may have to manually key in channel number that is assigned to the SHOWVIEW® / VIDEO Plus+ code if it has not been assigned to the programming number. Follow the instructions on the TV screen.

- 5 Press **▼** to select { **Dest.** } in the menu and press **▶**.
- 6 Select the recording destination (DVD or VCR) and press **OK**.
- 7 Press **TIMER** to exit the menu.
- 8 Insert a recordable DVD or VHS tape into the recorder.  
 → For VHS tape, locate the start point position for recording.
- 9 Press **STANDBY-ON** to switch the recorder to standby mode.  
 → The **'TIMER'** icon will light up on the display panel if a timer recording is set.  
 → If the recorder is not in standby mode, a notification message will appear three minutes before the recording begins.  
 → The recorder will automatically power off when the timer recording ends.

## Timer recording (manually)

- 1 Turn on the TV to the correct viewing channel for the recorder (e.g. 'EXT', '0', 'AV').
- 2 Press **TIMER** on the remote control.  
 → The timer schedule list appears.

Timer Schedule							09 : 05 : 56
	Source	Rec Mode	Date	Start	End	VPS	▲▼
1	CH003	SP	05/01/06	14.00	15.30	On	
2	CH010	EP	25/01/06	02.00	06.30	Off	
3	CH008	SP	30/01/06	17.00	18.15	On	
4	CH005	SP	31/01/06	12.30	14.00	Off	
5							
6							▼

- 3 Select an empty field and press **OK**.  
 → The timer editor menu appears.

Timer Editor		09 : 05 : 56
Source	Ch003	▼
Dest.	DVD	▼
Rec Mode	SP	▼
Mode	Once	▼
Date	01 / 01 / 06	
Start	10 : 33	
End	11 : 03	
VPS	Off	▼
<input type="button" value="OK"/> <input type="button" value="CANCEL"/>		

- 4 Use **▲▼** keys or the **numeric keypad 0-9** to select or enter the recording information, then press **OK** to confirm.

**TIPS:** Ensure that there is sufficient space available on the recordable DVD or VHS tape before recording. You have to finalise the DVD±R before it can be playback on other players.

## Timer Recording (continued)

### { Source }

Select the TV channel or the correct input source (EXT1, EXT2 or CAM1) which you have used to connect the external device.

### { Dest. }

Select the recording destination, DVD or VCR.

### { Rec Mode }

Select the mode of recording. See the chapter "Recording – RECORD settings - Default Recording mode" for more information.

### { Mode }

Select a desired repeat recording mode (Once, Daily, Weekly, Mon-Fri, Mon-Sat or Weekend).

### { Date }

Enter the date for recording (Day/Month/Year).

### { Start }

Enter the start time of recording (hours : minutes).

### { End }

Enter the end time of recording (hours : minutes).

### { VPS/PDC }

Turn on or off the VPS/PDC setting.

**Note:** VPS/PDC setting is not available for external receiver.

- 5 Use ▲▼ keys to select **OK** in the menu and press **OK**.

→ The system will store the timer entry and return to the timer schedule list.

- To cancel the above timer setting, move to **CANCEL** in the menu and press **OK**.

- 6 Press **TIMER** to exit the menu.

- 7 Insert a recordable DVD or VHS tape into the recorder.

→ For VHS tape, locate the start point position for recording.

- 8 Press **STANDBY-ON** to switch the recorder to standby mode.

→ The 'TIMER' icon will light up on the display panel if a timer recording is set.

→ If the recorder is not in standby mode, a notification message will appear three minutes before the recording begins.

→ The recorder will automatically power off when the timer recording ends.

### Helpful Hints:

– Set the timer recording one minute ahead of the programme's start time. This helps ensure the entire programme is recorded as the disc requires about 30 seconds to prepare for recording.

– The interval time between two recording schedules is at least 5 (five) minutes.

Otherwise, the very beginning of the later programme may not be recorded.

– Only PAL/SECAM video signal is possible to record to a VHS tape on this recorder.

**TIPS:** Ensure that there is sufficient space available on the recordable DVD or VHS tape before recording. You have to finalise the DVD±R before it can be playback on other players.

## Timer Recording (continued)

### Setting a timer recording from an external Cable Box/ Satellite Receiver

If you have a Satellite Receiver/Cable Box connected to this recorder via the EXT2 AUX-I/O SCART connection (see "Step 2: Optional Connections"), follow the steps described below to programme the recordings.

- 1 Select the channel you want to record on the Satellite Receiver/Cable Box.
- 2 Programme the recording with the required information. Follow the steps ①~⑧ of "Timer Recording (manually)" on the previous page.  
**Note:** In { **Source** } entry, select { **EXT2** } as the input source for recording.
- 3 Leave the Satellite Receiver/Cable Box switched on for the recording.

### Changing/ Deleting a timer recording

- 1 Turn on the TV to the correct viewing channel for the recorder (e.g. 'EXT', '0', 'AV').
- 2 Press **TIMER** on the remote control.  
→ The timer schedule list appears.

Timer Schedule							09 : 05 : 56
	Source	Rec Mode	Date	Start	End	VPS	▲
1	CH003	SP	05/01/06	14.00	15.30	On	
2	CH010	EP	25/01/06	02.00	06.30	Off	
3	CH008	SP	30/01/06	17.00	18.15	On	
4	CH005	SP	31/01/06	12.30	14.00	Off	
5							
6							▼

- 3 Use ▲▼ keys to select a timer programme which you want to change/delete.
- 4 **To delete the timer entry**, press **CLEAR** on the remote control.
- 5 **To change the timer schedule**, press **OK** to enter the timer editor menu of the selected timer programme.

Timer Editor		09 : 05 : 56
Source	Ch003	▼
Dest	DVD	▼
Rec Mode	SP	▼
Mode	Once	▼
Date	01 / 01 / 06	
Start	10 : 33	
End	11 : 03	
VPS	Off	▼
<input type="button" value="OK"/> <input type="button" value="CANCEL"/>		

- 6 Select the entry field and make the necessary changes.
- 7 Once complete, move to  in the menu and press **OK** to save the changes.
- 8 Press **TIMER** to exit the menu.

**TIPS:** Ensure that there is sufficient space available on the recordable DVD or VHS tape before recording. You have to finalise the DVD±R before it can be playback on other players.



## Direct Dubbing (Disc ↔ Tape)

### Dubbing from VCR to DVD

This allows you to archive your VHS tapes to a recordable DVD.

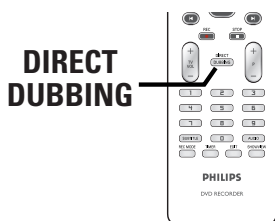

- 1 Insert a recordable DVD.
- 2 Insert a prerecorded VHS tape.
- 3 Press **VCR** on the remote control.
- 4 Press **▶||** to start tape playback. Find the place where you want to start recording and press **▶||** again to pause the playback.
- 5 Press **DIRECT DUBBING** on the remote control.  
→ The dubbing menu appears.

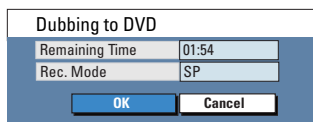

- 6 Select the desired recording mode.
- 7 Move to **OK** in the menu and press **OK** to start dubbing.
- 8 To stop the dubbing, press **STOP ■**.  
→ Otherwise, dubbing will stop automatically when the VHS tape ends.

### Dubbing from DVD to VCR

If the disc you are attempting to dub is copy-protected, you will not be able to copy the disc. It is not permitted to copy Macrovision encoded DVDs.

- 1 Insert a blank VHS tape in the tape deck.
- 2 Insert the disc you want to copy in the disc tray.
- 3 Press **DVD** on the remote control.
- 4 Press **▶||** to start disc playback. Find the place where you want to start recording and press **▶||** again to pause the playback.
- 5 Press **DIRECT DUBBING** on the remote control.  
→ The dubbing menu appears.

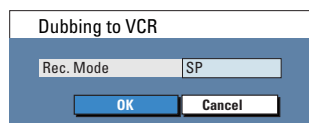

- 6 Select the desired recording mode.
- 7 Move to **OK** in the menu and press **OK** to start dubbing.
- 8 To stop the dubbing, press **STOP ■**.  
→ You must stop the copy process manually when the DVD movie ends. Otherwise, the disc may replay and record over and over again.

**TIPS:** Ensure that there is sufficient space available on the recordable DVD or VHS tape before recording.

## DVD Playback

### Playable discs

Using this recorder, you can playback and record on the following discs:

#### Recording and Playback

##### DVD±RW

(DVD Rewritable);  
can be recorded on  
over and over.



##### DVD±R

(DVD Recordable);  
can be recorded  
only once.



##### DVD+R DL

(DVD+R Double  
Layer); same as DVD±R.



#### Playback only:

**DVD Video** (Digital Versatile  
Disc)



**CD-RW** (CD-Rewritable)  
Audio/ MP3/ JPEG contents



**CD-R** (CD-Recordable)  
Audio/ MP3/ JPEG contents



**Audio CD** (Compact Disc  
Digital Audio)



**MP3/WMA-Disc**



**Video CD**

(Formats 1.0, 1.1, 2.0)



**Super Video CD**



**DivX Disc**

(DivX 3.11, 4.x, 5.x, 6.x)



#### IMPORTANT!

- If the inhibit icon (**Error**) appears on the TV screen when a button is pressed, it means the function is not available on the current disc or at the current time.
- DVD discs and players are designed with regional restrictions. Before playing a disc, make sure the disc is for the same region as your player.
- Do not push on the disc tray or put any objects other than discs on the disc tray. It may cause the disc player to malfunction.

**TIPS:** Some discs cannot be played on this recorder due to the configuration and characteristics of the disc, or due to the condition of recording and authoring software.

## DVD Playback (continued)

### Starting disc playback

- 1 Press **STANDBY-ON** to turn on the recorder.
- 2 Press **DVD** on the remote control.  
→ The DVD indicator lights up.
- 3 Press **OPEN/CLOSE ▲** at the front panel.  
→ The disc tray opens.
- You can also hold down the **STOP ■** button on the remote control to open and close the disc tray.
- 4 Place the disc onto the tray with the label facing up, then press **OPEN/CLOSE ▲**.  
→ For double-sided discs, load the side as indicated on the label.
- 5 Turn on the TV to the correct viewing channel for the recorder (e.g. 'EXT', '0', 'AV').
- 6 Playback may start automatically. Otherwise, press **▶||** to start playback.
- If the pin code entry dialogue appears on the TV, this means that the parental control was activated for the inserted disc. You have to enter your four-digit pint code (see "DVD Setup Menu Options – DVD Settings").
- For more playback features, see "Additional Playback Features".

#### Helpful Hints:

- If you want to return to tuner mode during DVD playback, press **SOURCE** button.
- If you wish to watch the VCR playback, press **VCR** to change to VCR mode before starting playback the tape. If you press **DVD** to watch the disc playback again, playback resumes from the point where playback was interrupted.

**TIPS:** Some discs cannot be played on this recorder due to the configuration and characteristics of the disc, or due to the condition of recording and authoring software.

### Playing a DVD video disc

The DVD disc is usually formatted with a disc menu. You may have to make your selection (e.g., subtitle or audio language) within the disc menu.

- 1 Insert a DVD disc.
- If the disc menu appears, use the **numeric keypad 0-9** to input your selection or use **▲▼** keys to select a play option and press **OK** to start playback.

#### To access the disc menu

- Press **DISC MENU** on the remote control.

#### To select the previous or next chapter

- During playback, press **◀** or **▶**.
- 2 To stop playback, press **STOP ■**.

### Playing an audio CD

- 1 Insert an audio CD.  
→ Playback starts automatically.  
→ The track number and elapsed playing time appear on the display panel.
- 2 To stop playback, press **STOP ■**.

## DVD Playback (continued)

### Playing a (Super) Video CD

(Super) Video CDs may feature 'PBC' (Play Back Control). This allows you to play the video CDs interactively by following the menu on the display.

- 1 Insert a (Super) Video CD.

**If the 'PBC' is on, the disc index menu will appear on the TV**

- 2 Use **numeric keypad 0-9** to input your selection or to select a play option.
  - To return to the previous menu, press **BACK** on the remote control.
  - To turn on/off the Playback Control mode, press **TOOLS** on the remote control during playback to access the VCD menu. Then use **▲▼** keys to select { **PBC On** } or { **PBC Off** }.
- 3 To stop playback, press **STOP** .

### Playing a DVD recordable disc

- 1 Insert a DVD recordable disc.
  - The Index Picture screen appears.
- 2 Use **▲▼** keys to select a title to play, then press **▶II**.
- 3 To stop playback, press **STOP** .

#### Helpful Hint:

– If the message 'BLANK' appears on the display panel, this means that there are no recordings on this disc.

### Playing a DivX disc

This recorder supports the playback of DivX movies which you can copy from your computer onto a CD-R/RW, DVD±R/±RW.

- 1 Insert a DivX disc.
  - The disc content menu appears.
- If the DivX movie contains external subtitles, you have to first select the subtitle file from the file list.
- 2 Press **▶II** to start playback.
- During playback, you can press **DISC MENU** to display the disc content menu.

#### To select another character set for the subtitle file,

- During playback, press **TOOLS** once to show the disc content menu. Press **TOOLS** again to access various settings for the slide show playback.

File Play		
Type	Video	
Mode	Normal	
Character	Standard Set	
Audio	Stereo	Western European
Time	0:01:31/ 0:41:35	Standard
LANG	Language 1	Central European
		Cyrillic
		Greek

- Use **▲▼** keys to select { **Character** } and press **▶** to access the options. Select the preferred subtitle set and press **OK** to confirm.

#### Helpful Hints:

– Subtitle files with the following file name extensions (.srt, .smi, .sub, .sami) are supported.

– It is normal to experience an occasional pixelation during DivX playback due to poor clarity of digital contents during internet downloading.

**TIPS:** Some discs cannot be played on this recorder due to the configuration and characteristics of the disc, or due to the condition of recording and authoring software.

## DVD Playback (continued)

### Playing an MP3/WMA disc

MP3 (MPEG1 Audio Layer-3) files are highly compressed music files. The MP3 format lets you store about ten times more data (music, pictures) on a single CD-ROM than a regular CD.

- 1 Insert an MP3/WMA CD.  
→ The disc content menu appears.

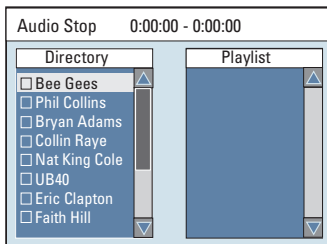

**Note:** It may require a longer time for the recorder to display the disc content menu on the TV due to the large number of songs/pictures compiled into one disc.

- 2 Use ▲▼ keys to navigate within the menu and press **OK** to access the folder/album.
- 3 Use ▲▼ keys to select the track/file to play.
  - To move up to the previous level, press **BACK** ⏪.
- 4 To create a playlist, highlight the track/file and press **SELECT**.  
→ The selected tracks/files will appear on the right screen.  
→ To remove the track/file from the playlist, press **CLEAR**.

- 5 To start playback, move the cursor to the right selection screen and press **▶||**.
- 6 During playback, you can press **⏮/⏭** to select the next/previous track.
- 7 To stop playback, press **STOP** ■.

#### Helpful Hints:

- Only the first session of a multi-session CD will playback.
- This recorder does not support MP3PRO audio format.

**TIPS:** Some discs cannot be played on this recorder due to the configuration and characteristics of the disc, or due to the condition of recording and authoring software.

## DVD Playback (continued)

### Playing a picture disc (or musical slide show)

You can display JPEG pictures in the selected roll automatically one after the other.

- 1 Insert a JPEG picture disc (CD, CD-R/RW, recordable DVD).  
→ The disc content menu appears.
- 2 Use ▲▼ keys to navigate within the menu and press **OK** to access the folder/ album.
- 3 To create a playlist, highlight the track/file and press **SELECT**.  
→ The selected tracks/files will appear on the right screen.  
→ To remove the track/file from the playlist, press **CLEAR**.
- 4 You can select to playback from the original disc content or from the playlist, just use ◀▶ keys to move to the correct screen before selecting the track/ file for playback.

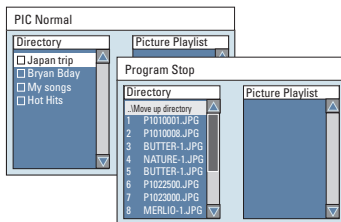

**If the disc contained MP3 music and JPEG picture files, you can start a musical slide show playback,**

- Select an MP3 file and press **OK** to start the playback, then select a picture file in the menu and press **OK** to start the musical slide show playback.

- 5 During playback, you can press **TOOLS** on the remote control to access various settings for the slide show playback.

File Play	
Type	PIC
Mode	Normal
Wipe	Top to bottom
Zoom	Fitscreen
Rotate	Clockwise 0

Top to bottom
Down to top
Left to right
Right to left
Extend center V.

- 6 To stop playback, press **STOP** ■.

### Playable JPEG picture disc File format:

- The file extension has to be '.JPG,' '.JPE' or '.JPEG.'
- It can only display DCF-standard still pictures or JPEG pictures e.g. TIFF.
- It cannot playback moving pictures, Motion JPEG, progressive JPEG, pictures in non-JPEG formats and including pictures associated with sound.

**TIPS:** Some discs cannot be played on this recorder due to the configuration and characteristics of the disc, or due to the condition of recording and authoring software.

## Additional Playback Features

### Changing to another title/ chapter/track

When a disc contains more than one track, title or chapter, you can change to a different track, title or chapter as follows.

During playback,

- Press ► (NEXT) to go to the next chapter/track.
- Press ◀ (PREV) to return to the start of the previous chapter/track.  
OR
- Use the **numeric keypad 0-9** to input the title/chapter/track number.  
OR
- Press **TOOLS** to enter the file play (DVD, VCD) menu and use ▲▼ keys to select { **Title** } or { **Chapter** } and use **numeric keypad 0-9** to input the title/chapter/track number.

### Pausing playback

- 1 During playback, press ►|| to pause playback.
- 2 To resume normal playback, press ►|| again.

### Searching forwards/ backwards

You can fast forward or fast reverse a disc at two, four, sixteen or thirty two times the normal playback speed.

- 1 During playback, press ◀◀ (REW) or ▶▶ (FFW) to switch to the search function.  
→ The search status bar appears.  
It displays the search speed.  
→ The sound will be muted.
- 2 Press ◀◀ (REW) or ▶▶ (FFW) to cycle through the search speeds.
- 3 To resume normal playback, press ►||.

**TIPS:** The operating features described here might not be possible for certain discs. Always refer to the instructions supplied with the discs.

## Additional Playback Features (continued)

### Using the TOOLS options

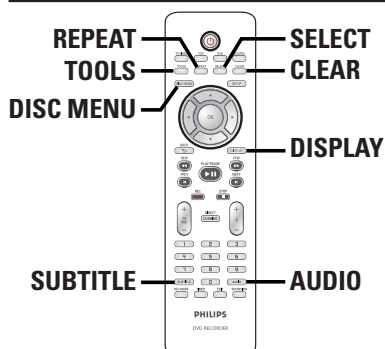

Menu options displayed may differ depending on the disc type.

- 1 During disc playback, press **TOOLS** on the remote control.  
→ The Tools menu appears.

DVD	00:22:03 / 01:30:26
Mode	Normal
Title	01/02
Chapter	03/12
Audio	01/02 - OTH
Subtitle	Off
Angle	01/03
Title	00:22:03 / 01:30:26

- 2 Use **▲▼** keys to select the setting you want to adjust.  
→ Instructions and explanations of the options are provided in the following pages.  
→ If the selection in the menu is greyed out, that means the feature is not available or cannot be changed in the current states.
- Press **DISPLAY** on the remote control to hide or show the DVD menu.
- 3 To exit, press **TOOLS**.

### Selecting various repeat/ shuffle functions

You can select various repeat play or random play mode during playback.

- During disc playback, press **REPEAT** repeatedly to toggle through the options on the disc.  
Or,
- 1 During disc playback, press **TOOLS** on the remote control.  
→ The Tools menu appears.
- 2 Use **▲▼** keys to select { **Mode** } and press **OK**.
- 3 Use **▲▼** keys to select one of the repeat options.

#### { Repeat A-B } (DVD/VCD)

Repeat the playback of a specific segment within a title/chapter/track. Press **OK** to mark the start and end of the segment you want to repeat.

#### { Repeat Chapter }

Repeat playback of the current chapter (DVD, DVD±R/±RW only).

#### { Repeat Track/Title }

Repeat playback of the current track/title.

#### { Repeat Directory }

Repeat playback of the current folder/ directory (MP3, JPEG, picture disc only).

#### { Repeat Disc }

Repeat playback of the entire disc.

#### { Shuffle }

Randomly playback all the tracks within the disc (MP3/DivX/WMA and audio CD only).

#### { Normal }

Cancel the repeat or programmed modes and return to normal playback.

- 4 To cancel repeat playback, press **STOP** ■ or select { **Normal** } and press **OK**.

**TIPS:** The operating features described here might not be possible for certain discs. Always refer to the instructions supplied with the discs.



## Additional Playback Features (continued)

### Creating a playlist

You can playback the contents of the disc in the order you want by creating a playlist.

- 1 During disc playback, press **TOOLS** on the remote control.  
→ The Tools menu appears.
- 2 Select { **Mode** } > { **Program** }.  
→ The programme menu appears.

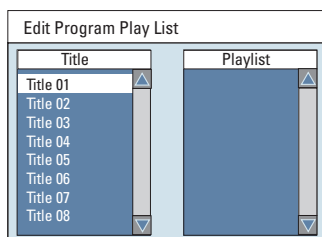

- 3 If the disc is recorded with Titles/Folders/ Albums, press **OK** to access the tracks/ files/chapters.
- 4 Use ▲▼ keys to select the track/file/ chapter and press **SELECT** on the remote control.  
→ The selected track/ file/ title will appear in the { **Playlist** } screen at the right.

### To remove from the playlist

- 5 Move to the right screen, select the item to remove and press **CLEAR** on the remote control.
- 6 To start playback from the playlist, move to the right screen and press **OK**.  
→ Playback will start from the selected track/ file/ chapter according to the order of the playlist.
- 7 To exit playlist play, press **STOP** ■.

### Changing the audio language

This operation works only on DVDs with multiple soundtrack language or VCDs with multiple audio channels.

- During disc playback, press **AUDIO** repeatedly to toggle through the audio channels on the disc.
- Or,
- 1 During disc playback, press **TOOLS** on the remote control.  
→ The Tools menu appears.
  - 2 Use ▲▼ keys to select { **Audio** } and press ► to access its options.
  - 3 Use ▲▼ keys to select the audio language and press **OK** to confirm.  
→ The languages may be numbered or abbreviated, such as “En” for English.  
→ If the language selected is not available on the disc, the disc’s default setting for language will be used instead.

### Helpful Hint:

– Some DVDs allow soundtrack language changes only via the DVD disc menu. To access the Disc Menu, press **DISC-MENU**.

**TIPS:** The operating features described here might not be possible for certain discs. Always refer to the instructions supplied with the discs.

## Additional Playback Features (continued)

### Changing subtitle languages

This operation works only on DVDs with multiple subtitle languages, you can change the language you want while playback the DVD.

- During disc playback, press **SUBTITLE** repeatedly to toggle through the language options on the disc.

Or,

- 1 During disc playback, press **TOOLS** on the remote control.  
→ The Tools menu appears.
- 2 Use ▲▼ keys to select { **Subtitle** } and press ► to access its options.
- 3 Use ▲▼ keys to select the language and press **OK** to confirm.  
→ The languages may be numbered or abbreviated, such as “En” for English.  
→ If the language selected is not available on the disc, the disc’s default setting language will be used instead.

#### Helpful Hint:

– Some DVDs discs allow subtitle language changes only via the DVD disc menu. To access the disc menu, press **DISC-MENU**.

### Switching camera angles

This option is only available with DVDs that contain sequences recorded from different camera angles. This allows you to view the picture from different angles.

- 1 During disc playback, press **TOOLS** on the remote control.  
→ The Tools menu appears.
- 2 Use ▲▼ keys to select { **Angle** } and press ► to enter its options.  
→ The camera angles available for selection appears.
- 3 Use ▲▼ keys to select the camera angle you want to switch to, and press **OK** to confirm.

### Searching by time

This option allows you to skip to a specific point on the current disc.

- 1 During disc playback, press **TOOLS** on the remote control.  
→ The Tools menu appears.
- 2 Use ▲▼ keys to select { **Search** } and press ► to time field (hours : minutes : seconds).
- 3 Use the **numeric keypad 0-9** to enter the time where playback should start and press **OK**.  
→ Playback skips to the time entered.

**TIPS:** The operating features described here might not be possible for certain discs. Always refer to the instructions supplied with the discs.

## Starting VCR playback

This VCR uses the VHS system.

- 1 Press **STANDBY-ON** to turn on the recorder.
- 2 Press **VCR** on the remote control.  
→ The VCR indicator lights up.
- 3 Insert a pre-recorded VHS tape into the tape deck with the window side facing up and the label side towards the front.
- 4 Playback will start automatically. Otherwise, press **▶▶**.

### To pause playback

- Press **▶▶**.
- To resume normal playback, press **▶▶**.

### For fast forward/backward search

- Press **◀◀** (REW) or **▶▶** (FFW).
- To resume normal playback, press **▶▶**.

### To search a specific recording (using index function)

- Press **PREV** **◀** / **NEXT** **▶** to search the previous or next index marking within the tape.
- 5 To stop playback, press **STOP** **■**.
  - 6 To eject the VHS tape, press **EJECT** **▲**.

### Helpful Hints:

- If you want to return to tuner mode during VCR playback, press **SOURCE** button.
- If you wish to watch the disc playback, press **DVD** to change to DVD mode before starting playback the disc. If you press **VCR** to watch the VCR playback again, playback resumes from the point where playback was interrupted.
- When playing back tapes recorded using the S-VHS system, the playback image may be distorted.

## Reset tape counter

- Press **CLEAR** on the remote control to set the counter to "0:00:00".  
→ When you insert a VHS tape in the recorder, the counter will automatically reset to "0:00:00".

## Manual tracking

This recorder has automatic tracking capability to reduce the picture and sound interference of a poor quality VHS tape. However, you may have to do a manual tracking if these cannot be completely filter out.

- 1 Press **P** + **—** on the remote control until you get a better picture/sound quality.
- 2 Press **STOP** **■** to confirm.  
→ Tracking is automatically reset to normal when the tape is ejected.

**TIPS:** The operating features described here might not be possible for certain VHS tapes.

## Edit Recordings - Recordable DVD

### About disc editing

This recorder offers various disc edit options for various disc types. You can change the disc content and settings of a recorded DVD from the disc editing menu. The edited contents may not be available when you play the disc on another DVD player.

The displayed options in the disc editing menu differ depending on the type of disc.

#### { Play }

Start playing from the beginning of the disc.

#### { Rename Disc }

Change the name of the disc.

#### { Erase Disc } - DVD±RW only

Erase all the recordings on the disc.

#### { Record New Title }

Start recording from the last empty title on the disc.

#### { Overwrite Disc } - DVD±RW only

Start a new recording from the beginning of the disc, all the recorded content will be overwritten.

#### { Make Compatible } - DVD±RW only

To ensure the edited changes remain when the disc is played back on another DVD player. (e.g., hidden chapters to remain hidden).

#### { Lock/Unlock Disc } - DVD±RW only

Lock or unlock a disc to prevent accidental erasure or changes being made.

#### { Finalise Disc } - DVD±R only

Finalise the disc to enable playback on other DVD players. Further recording and editing to the disc are not allowed. It is not possible to unfinalise the disc.

### Accessing disc editing menu

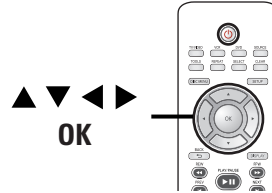

- 1 Insert a recorded disc into the recorder.  
→ The Index Picture screen appears on the TV.
- 2 Select the first title on the disc, press and hold ▲ on the remote control.  
→ The disc editing menu appears.
- 3 Press ► on the remote control to display the disc editing options.  
→ The available editing options are different for DVD±R and DVD±RW discs.

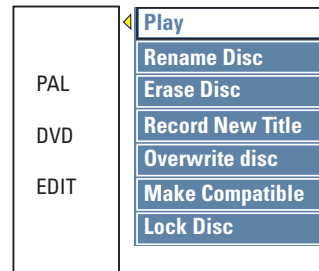

- 4 Use ▲▼ keys to access different options and **OK** to select.  
→ Instructions and explanations of the options are provided in the following pages.
- 5 To exit from the disc editing menu, press ◀ once to exit from the disc editing menu. Press ▼ to return to the disc Index Picture menu.

**TIPS:** No further recording and editing can be carried out on a full or finalised DVD±R. Press ◀ to go back to the previous menu. Press **DISC MENU** to exit.

## Edit Recordings - Recordable DVD (continued)

### Rename disc

The original disc name is generated automatically by the recorder. You can change the disc name by following the steps below.

- 1 In disc editing menu, use ▲▼ keys to select { **Rename Disc** } and press **OK**.  
→ The keyboard screen appears.
- 2 Use ◀▶▲▼ keys to highlight a character on the keyboard and press **OK** to select.  
→ The maximum input is up to 20 characters.
- You can use the following keys on the keyboard screen to edit your input:
  - : to remove the character to the left of the cursor.
  - : to remove the character to the right the cursor.
  - : to create a space between characters.
  - : to toggle between upper and lower case characters.
  - : to clear the entry field completely.
- 3 To confirm your entry, select  on the keyboard and press **OK**.  
→ The info panel is now updated.
- To cancel the changes, select  on the keyboard and press **OK**.

### Erase disc (DVD±RW only)

This erases the content of the DVD±RW. Once the existing content is erased, it can be used for recording.

- 1 In disc editing menu, use ▲▼ keys to select { **Erase Disc** } and press **OK**.  
→ A warning message will appear.
- 2 Select  in the menu to proceed or  to abort, then press **OK** to confirm.

### Record new title

This function allows you to start a new recording at the remaining empty space in the DVD±RW.

- 1 In disc editing menu, use ▲▼ keys to select { **Record New Title** } and press **OK**.
- 2 Select the source you want to record from and press **REC** ● to start recording.

### Overwrite disc (DVD±RW only)

This function allows you to start a new recording from the beginning of a DVD±RW regardless of the contents of the disc.

- 1 In disc editing menu, use ▲▼ keys to select { **Overwrite disc** } and press **OK**.
- 2 Select the source you want to record from and press **REC** ● to start recording.

**TIPS:** No further recording and editing can be carried out on a full or finalised DVD±R. Press ◀ to go back to the previous menu. Press **DISC MENU** to exit.

## Edit Recordings - Recordable DVD (continued)

### Make compatible (DVD±RW only)

The edited DVD±RW may still display the original titles or hidden scenes when played back on other DVD players. This function ensures that the edited changes of the DVD±RW remain when played back on other players.

- In disc editing menu, use ▲▼ keys to select { **Make Compatible** } and press **OK** to confirm.

#### Helpful Hint:

– If the option {Compatible} is not available for selection, it means that the disc is already compatible.

### Lock/Unlock disc (DVD±RW only)

You can choose to protect the recorded DVD±RW in order to prevent accidental loss of recordings.

- 1 In disc editing menu, use ▲▼ keys to select { **Lock Disc** } and press **OK**.
  - The disc is locked for this DVD recorder only.
  - When the disc is locked, the option in the disc editing menu will change to { **Unlock Disc** }.
- 2 If you want to overwrite or edit on the protected disc, select { **Unlock Disc** }.

### Playback your recordings (DVD±R) on other DVD players

It is necessary to finalise a DVD±R disc before you can play it on another DVD player. Otherwise, the DVD±R will only playback on this recorder.

**After a DVD±R disc has been finalised, no further recordings or editing can be made to it. Make sure that you have completed all the recordings and editing before finalising the disc.**

- 1 In disc editing menu, use ▲▼ keys to select { **Finalise Disc** } and press **OK**.
    - A warning message will appear.
  - 2 Select  **YES** in the menu and press **OK** to start the process.
    - Finalisation will take a few minutes, depending on the length of recordings.
    - Do not try to open the disc tray or switch off the power as this may render the disc unusable.
- Otherwise, move to  **NO** in the menu and press **OK** to abort the operation.

**TIPS:** No further recording and editing can be carried out on a full or finalised DVD±R. Press ◀ to go back to the previous menu. Press **DISC MENU** to exit.

## Edit Recordings - Recordable DVD (continued)

### About title editing

You can change the individual title information or delete a title (recording) in a recorded DVD. If a DVD±R has been finalised, it cannot be edited.

The displayed options in the title editing menu differ depending on the type of disc.

#### { Play Title }

Start playing a recording.

#### { Edit Title }

Access the video editing menu.

#### { Rename Title }

Change the name of the recording.

#### { Erase Title } - DVD±RW only

Delete the title (recording).

#### { Overwrite Title } - DVD±RW only

Start a new recording, the existing title (recording) will be overwritten.

#### { Overwrite Disc } - DVD±RW only

Overwrite from the existing selected title onwards to the end of the disc.

#### { Append Title }

Insert a new recording to the last existing recording.

### Accessing title editing menu

- 1 Insert a recorded DVD into the recorder.  
→ The Index Picture screen appears on the TV.
- 2 During playback, press **DISC MENU** to access the Index Picture screen.
- 2 Use **▲▼** keys to highlight a title (recording), and press **▶**.  
→ The title editing menu appears.

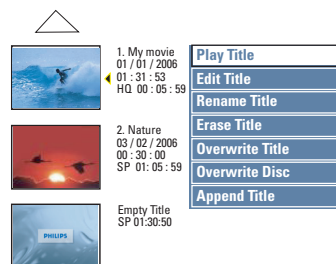

- 3 Use **▲▼** keys to access different options and **OK** to select.  
→ Instructions and explanation of the options are provided in the following pages.
- 4 To exit, press **◀**.

### Video editing

This feature allows access to the video editing menu. See the chapter “Editing/ Finalising Recording – About video editing” for more information.

- In title editing menu, use **▲▼** keys to select { **Edit Title** } and press **OK**.  
→ The video editing menu appears.  
→ The recorder will play the selected title.

**TIPS:** No further recording and editing can be carried out on a full or finalised DVD±R. Press **◀** to go back to the previous menu. Press **DISC MENU** to exit.

## Edit Recordings - Recordable DVD (continued)

### Rename title

The original title name is generated automatically by the recorder. You can give a new name to the title by following the steps below.

- In title editing menu, use ▲▼ keys to select { **Rename Title** } and press **OK**.  
→ The keyboard screen appears.
- Use ◀▶ ▲▼ keys to highlight a character and press **OK** to select.  
→ The maximum input is up to 9 characters.
- You can use the following keys on the keyboard screen to edit your input:
  - : to remove the character to the left of the cursor.
  - : to remove the character to the right the cursor.
  - : to create a space between characters.
  - : to toggle between upper and lower case characters.
  - : to clear the entry field completely.
- To confirm your entry, select  on the keyboard and press **OK**.  
→ The info panel is now updated.
- To cancel the changes, select  on the keyboard and press **OK**.

### Erase title

You can delete a specific title (recording) from the disc. However, for DVD±Rs, the deleted space cannot be used for further recording.

- In title editing menu, use ▲▼ keys to select { **Erase Title** } and press **OK**.  
→ A warning message will appear.
- Select  in the menu to proceed or  to abort, then press **OK**.

**TIPS:** No further recording and editing can be carried out on a full or finalised DVD±R. Press ◀ to go back to the previous menu. Press **DISC MENU** to exit.

### Overwrite title (DVD±RW only)

This function allows you to record a new title from the beginning of the current title in the DVD±RW. The other titles will not be affected.

- In title editing menu, use ▲▼ keys to select { **Overwrite Title** } and press **OK**.
- Select the source you want to record from and press **REC** ● to start recording.

### Overwrite from the selected title

You can select to overwrite only the recordings from the selected title to the end of the disc.

- In video editing menu, use ▲▼ keys to select { **Overwrite Disc** } and press **OK** to confirm.

### Append recording

This function allows you to append recording to the last existing title.

- In title editing menu, use ▲▼ keys to select { **Append Title** } and press **OK**.
- Press **SOURCE** to select the input channel to append.
- Press **REC** ● to start append recording.  
**Warning!** Once the recording has started, any prior recording from the point of the playback and onwards will be overwritten.
- To stop append recording, press **STOP** ■.



## Edit Recordings - Recordable DVD (continued)

### About video editing

After a recording has been made, this recorder allows you to edit the video content. You can add/delete chapter markers, hide unwanted scenes, change the picture in the index picture screen and split a title (recording) into two.

When you playback a recording in video edit mode, the entire recording will be played back including hidden scenes.

The edit functions available in the disc editing menu are:

#### { Title }

Select a title (recording) to play.

#### { Chapter }

Select a chapter within the selected title.

#### { Chapter Marker }

Insert a chapter marker in the recording or erase a chapter marker to combine two chapters.

#### { Hide Chapter }

Hide the unwanted scene in the recording.

#### { Index Picture }

Select a scene in the recording as the index picture screen.

#### { Split Title } – DVD±RW only

Divide the recording into two separate titles.

### Accessing video editing menu

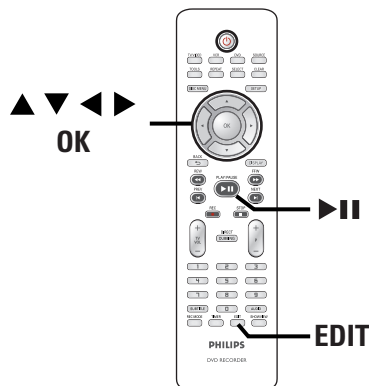

- 1 Insert a recorded DVD into the recorder.  
→ The Index Picture screen appears on the TV.
- 2 Use ▲▼ keys to select a title (recording).
- 3 Press ►|| to start playback.
- 4 Press **EDIT** on the remote control.  
→ The video editing menu appears.

Edit Mode	0:03:28
Title 02/06	
Chapter 01/10	▼
Chapter Marker	
Hide Chapter	
Index Picture	
Split Title	

- 5 Use ▲▼ keys to access different options and press **OK** to select.  
→ Instructions and explanations of the options are provided in the following pages.
- 6 To exit, press **EDIT**.

**TIPS:** No further recording and editing can be carried out on a full or finalised DVD±R. Press ◀ to go back to the previous menu.

## Edit Recordings - Recordable DVD (continued)

### Selecting a title

This option shows the current title and the total number of titles in the disc. It also allows you to select a specific title.

- 1 During playback, press **EDIT** to display the video editing menu.
- 2 Use **▲▼** keys to select { **Title** } and press **OK**.
- 3 Use the **numeric keypad 0-9** to key in a title and press **OK**.  
→ The recorder will play the selected title.

### Selecting a chapter

This option shows the current chapter and the total number of chapters in the title. It also allows you to select a specific chapter within the title.

- 1 During playback, press **EDIT** to display the video editing menu.
- 2 Use **▲▼** keys to select { **Chapter** } and press **OK**.
- 3 Use the **numeric keypad 0-9** to key in the chapter and press **OK**.  
→ The recorder will play the selected chapter.

### Creating chapter marker

You can create a chapter by inserting chapter marker at any point within a title during playback. This will allow you to access a specific point in the recording easily or set a chapter you wish to hide.

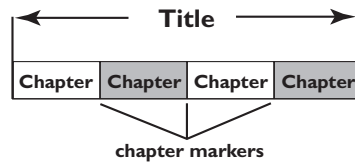

- 1 During playback, press **EDIT** to display the video editing menu.
- 2 Use **▲▼** keys to select { **Chapter Marker** } and press **OK**.
- 3 Use **▲▼** keys to select one of the options and press **OK** to confirm.

#### { **Insert Marker** }

Select this to insert a new chapter marker at the current point of playback.

#### { **Delete Marker** }

Select this to delete the current chapter marker (it refers to the closest marker before the current point of playback). The current chapter will then combine with the chapter before it.

#### { **Delete All Markers** }

Select this to delete all the chapter markers in the current title.

**TIPS:** No further recording and editing can be carried out on a full or finalised DVD±R. Press **◀** to go back to the previous menu.

## Edit Recordings - Recordable DVD (continued)

### Hiding/unhiding an unwanted chapter

You can choose to hide certain scenes from playback (e.g. skipping a commercial scene) or make it visible again.

- 1 Create a chapter marker at the start and end of the scene you want to hide. (See previous page on "Creating Chapter Marker").
- 2 Select the chapter you want to hide and start playback. (See previous page on "Selecting a chapter").
- 3 During playback, press **EDIT** to display the video editing menu.
- 4 Use **▲▼** keys to select { **Hide Chapter** } and press **OK**.  
→ The current chapter will be hidden.

### To unhide a chapter

- 1 Press **EDIT** on the remote control during playback.  
→ The video editing menu appears.  
→ While in editing mode, the hidden chapter/chapters will be played back.
- 2 Wait for the chapter you want to unhide to occur or use **◀▶** keys on the remote control to make a fast search.
- 3 Use **▲▼** keys to select { **Unhide Chapter** } and press **OK**.  
→ The current chapter will be visible during playback.

### Helpful Hints:

- All the hidden chapters will be played back while in video editing mode.
- To locate a specific frame during playback, press **▶||** and the **▶** key to forward search to the frame that you want.

### Changing Index Picture

The index picture is the picture of the title you will see when the recorder loads up the Index menu. Normally, the first frame of a recording is shown as the title's index picture.

- 1 During playback, press **EDIT** to display the video editing menu, then use **▲▼** keys to highlight { **Index Picture** }.
- 2 Press **▶||** to pause playback.
- 3 Press **▶** to search for the desired frame and press **OK** to select the current frame as the index picture for the title.

### Splitting a title (DVD±RW only)

You can divide the current title into two new titles. Each of these titles is characterised by its own index picture.

**Warning!** Once a title is divided, the process cannot be reversed.

- 1 During playback, press **EDIT** to display the video editing menu, then use **▲▼** keys to highlight { **Split Title** }.
- 2 Press **▶||** to pause playback.
- 3 Press **▶** to search for the desired frame, and press **OK** to divide the title at the current frame.  
→ A new title will be shown at the Index Picture screen.

**TIPS:** No further recording and editing can be carried out on a full or finalised DVD±R. Press **◀** to go back to the previous menu.

# DVD Setup Menu Options

## Accessing the Setup Menu

The system setup menu provides various options for you to adjust the recorder to suit your preferences.

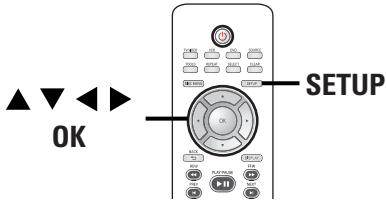

- 1 Press **SETUP** on the remote control.  
→ The system setup menu appears on TV.
- 2 Use ▲▼ keys to highlight a menu item and press ► to access its options.
- 3 Use ▲▼ keys to highlight the setting you wish to change and press **OK** to confirm and go back to the previous menu item.  
→ Instructions and explanations of the options are provided in the following pages.
- 4 To exit, press **SETUP**.

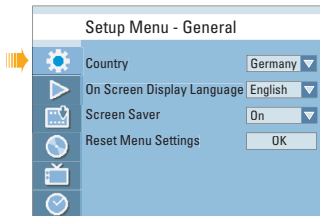

See this chapter – “GENERAL Settings”

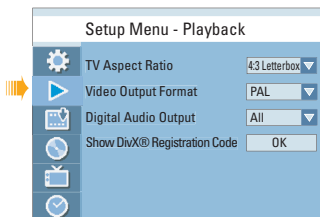

See this chapter – “PLAYBACK Settings”

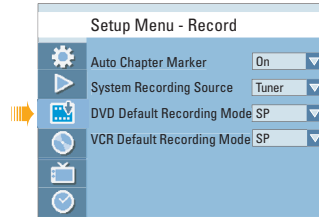

See Recording chapter – “RECORD Settings”



See this chapter – “DVD Settings”

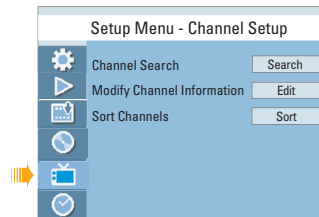

See this chapter “CHANNEL SETUP Settings”

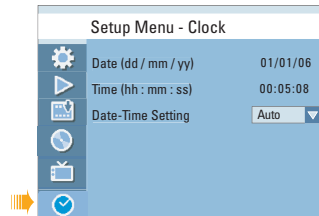

See this chapter “CLOCK Settings”

## DVD Setup Menu Options (continued)

### **GENERAL settings** (underlined options are the factory default settings)

**Country** Select the country of your area for auto channel tuning. (See section "Step 3: Installation and Setup - Select the country of your residence").

**On Screen Display Language** Select the menu language for this recorder on-screen display.

**Screen Saver** The screen saver prevents damage to the TV screen by avoiding exposure to a static image for too long.

- { On } – Switches to TV screen saver mode when playback has been stopped or paused for more than 15 minutes.
- { Off } – Turns off the screen saver function.

**Reset Menu Settings** Restore all the settings of this recorder, except for the PIN code. **Reset Menu Settings can only be changed when there is no disc in the disc tray.**



- 1) Press **OK** to confirm the default restore.
- 2) A warning message will appear. Select  in the menu to proceed or  to abort, then press **OK** to confirm.

## DVD Setup Menu Options (continued)

### **PLAYBACK settings** (underlined options are the factory default settings)

#### **TV Aspect Ratio**

Set the aspect ratio of the recorder according to the TV type you have connected.

- { **16:9** } – Select this for wide screen TV (frame ratio 16:9). 
- { **4:3 Letterbox** } – Select this for a 'wide screen' display with black bands on the upper and lower portions of the TV screen. 
- { **4:3 Panscan** } – Select this for a full-height picture with both side trimmed. 

#### **Video Output Format**

The colour system of the DVD system, DVD and TV should match. Only then will it be possible to play a DVD on this system. Before changing the TV system, determine the colour system of your TV.

- { **NTSC** } – Select this if the connected TV has the NTSC colour system. It will change the video signal of a PAL disc and output it to NTSC format.
- { **PAL** } – Select this if the connected TV has the PAL colour system. It will change the video signal of an NTSC disc and output it to PAL format.

**Note:** If a blank/distorted TV screen appears, wait for 15 seconds for the auto recovery.

#### **Digital Audio Output**

Adjust the digital output setting only if you have connected other devices to the coaxial socket on the recorder.

- { **ALL** } – Select this if you have used the COAXIAL socket on the recorder to connect to a stereo receiver that has a built in multichannel decoder.
- { **LPCM** } – Select this if the connected audio equipment is not capable of decoding multichannel audio Dolby Digital and MPEG-2 multi-channel signals are converted to PCM (Pulse Code Modulation).

## DVD Setup Menu Options (continued)

### PLAYBACK settings (underlined options are the factory default settings)

#### **Show DivX® Registration code**

Display the DivX® VOD (Video On Demand) registration code that allows you to rent and purchase videos using the DivX® VOD service. For more information, visit us at [www.divx.com/vod](http://www.divx.com/vod).

- 1) Press ► to display the registration code.
- 2) Use the registration code to purchase or rent videos from DivX® VOD service at [www.divx.com/vod](http://www.divx.com/vod). Follow the instructions and copy the video from your computer onto a CD-R/RW or recordable DVD disc for playback on this recorder.

### DVD settings (underlined options are the factory default settings)

#### **Default Disc Menu Language**

Select the preferred disc menu language for DVD playback.

#### **Default Subtitle Language**

Select the preferred subtitle language for DVD playback.

#### **Default Audio Language**

Select the preferred audio language for DVD playback.

#### **Notes:**

- If the selected audio/subtitle language is not available on the disc, the disc's default setting language will be used instead.
- For some DVDs, the subtitle/audio language can only be changed via the DVD disc menu.

## DVD Setup Menu Options (continued)

### DVD settings (underlined options are the factory default settings)

#### Parental Rating Level

Some DVDs may have a parental level assigned to the complete disc or to certain scenes on the disc. This feature lets you set a playback limitation level.

- 1) Use **▲▼** keys to select { **Parental Rating Level** } and press **OK**.
- 2) Use the **numeric keypad 0-9** to enter your four-digit pin code.

**Note:** When doing this for the first time or if you forget your four-digit pin code, enter the default password '3308'.

- 3) Move to **OK** in the menu and press **OK** on the remote control. The set rating level menu appears.
- 4) Use **▲▼** keys to select the desired parental level, then move to **OK** in the menu and press **OK** on the remote control to confirm.

#### Notes:

- The rating levels range from 1 to 8 and are country dependent. DVDs that are rated higher than the level you have selected will not play unless you enter your four-digit pin code.
- To disable parental controls and allow all discs to play, select { **Off** }.
- VCD, SVCD, CDs have no level indication, so parental control has no effect on these type of discs. This also applies to most illegal DVDs.
- Some DVDs are not coded with a rating though the movie rating may be printed on the disc cover. The rating level feature does not prohibit playback of such discs.

#### To change/ reset the password

- 1) Use **▲▼** keys to select { **Parental Rating Level** } and press **OK**.
- 2) Use the **numeric keypad 0-9** to enter your four-digit pin code.
- 3) Move to **OK** in the menu and press **OK** on the remote control. The set rating level menu appears.
- 4) Move to **New** in the menu and press **OK** to access new password menu.
- 5) Use the **numeric keypad 0-9** to enter your new four-digit pin code, then press **▼** to select the next entry field and enter the same pin code a second time.
- 6) Move to **OK** in the menu and press **OK** to confirm.

**Note:** To abort the change, select **CANCEL** and press **OK**. { **Off** }.



## DVD Setup Menu Options (continued)

### CHANNEL SETUP settings

#### Channel Search

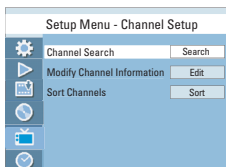

This option automatically scans all the receivable analogue local TV channels and stores these channels on the recorder. Press **OK** on the remote control to start the automatic TV channel search process and replace all previously stored analogue TV channels. This process may take several minutes.

#### Modify Channel Information

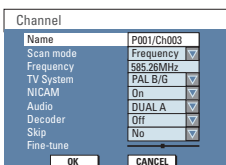

Adjust a stored TV channel to your preference and improve the reception and the sound quality of that TV channel.

- 1) Use **▲▼** keys to highlight { **Modify Channel Information** } and press **OK** to view the channel menu.
- 2) Use **▲▼** keys to select one of the options and press **OK**.

- { **Name** }
- Use the **numeric keypad 0-9** to select the channel preset number that you wish to change.
  - To rename the channel, press **▶**.
  - Use **◀▶ ▲▼** keys to highlight a character in the keyboard screen and press **OK** to select.
  - **Note:** The maximum input is up to 5 (five) characters.
  - Select **OK** on the keyboard to confirm your entry or select **EXIT** to abort, then press **OK** to exit.

- { **Scan Mode** }
- Select TV channel search mode based on channel allocation or frequency (Frequency, Channel or S-Channel) and press **OK** to confirm.

- { **Frequency** }
- Show the frequency of the current TV channel. If required, use **◀▶** keys to start the automatic frequency search and press **OK** to confirm.

- { **TV System** }
- Use **▲▼** keys to select a suitable TV system that produces the least distortion of picture and sound, then press **OK** to confirm. (See chapter “TV System Guide” at the back of this manual for more information).

## DVD Setup Menu Options (continued)

### CHANNEL SETUP settings

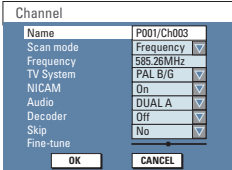

#### { NICAM }

- NICAM is a digital sound transmission system. It can transmit either one stereo channel or two separate mono channels.
- { **On** } – Improve the sound transmission of the TV channel.
- { **Off** } – Select this if the reception is poor and the sound is distorted.

#### { Audio }

- For bilingual TV programmes, you can switch between stereo (original) and additional audio language.
- { **DUAL A** } – Original broadcast language.
- { **DUAL B** } – Additional audio language.

#### { Decoder }

- If the current TV channel is transmitted by coded TV signals that can only be viewed properly with a decoder which is connected to the EXT2 AUX-I/O socket, you need to activate the connected decoder.
- { **On** } – Select this to allocate the connected decoder to this TV channel.
- { **Off** } – Turn off the decoder feature.

#### { Skip }

- Select this to set the channel to be skipped.
- { **No** } – The TV channel can be accessible using the **P + -** on the remote control.
- { **Yes** } – The TV channel can only be accessible by pressing the corresponding number button on the remote control.

#### { Fine-Tune }

- Select this to fine-tune the TV channel manually if the reception is poor. Use **◀▶** keys to adjust the frequency and press **OK** to confirm.

### Sort Channels

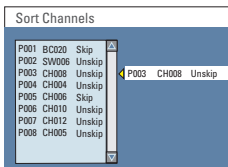

Rearrange the stored TV channels.

- 1) Use **▲▼** keys to highlight { **Sort Channels** } and press **OK** to show a list of TV channel programmes.
- 2) Use **▲▼** keys to highlight the channel you want to change and press **OK**.
- 3) Use **▲▼** keys to shift the TV channel to the desired position and press **OK** again. The selected channel will be inserted before the current position.

**Note:** Press **BACK** on the remote control to go back to the previous menu.

## DVD Setup Menu Options (continued)

### **CLOCK settings** (underlined options are the factory default settings)

- Date (dd/mm/yy)** Use ▲▼ keys to change the number and use ◀▶ keys to select different entry fields, then press **OK** to confirm.
- Time (hh/mm)** Use ▲▼ keys to change the number and use ◀▶ keys to select different entry fields, then press **OK** to confirm.
- Date-Time Setting** Enable/disable the automatic setting of date and time. This feature is dependent on your local broadcaster.
- { Auto } – Select this to activate automatic setting of date and time.
  - { **Manual** } – Select this to manually set the date and time.

## Other Information

---

### Installing the latest software

The software installed in your recorder is continuously being refined for greater stability and compatibility of the set. Periodically, Philips will issue upgrades for the software which you copy onto a CD and install the software of your recorder.

**Caution!** Power supply must not be interrupted during upgrade!

- 1 Get the version information of this recorder by pressing the number keypad '0009' and press **OK** on the remote control.  
→ Write down the information for your current software version.
- 2 Visit the Philips website 'www.philips.com/support' to check the availability of the latest software upgrade. Download the software to a CD-R.

**Note:** When checking for the latest software upgrade, please also check for any accompanying instructions on installing the software.

# Specifications

## Picture/Display

- Aspect ratio: 4:3, 16:9
- D/A converter: 10 bit, 54 MHz
- A/D converter: 10 bit, 27 MHz

## Sound

- D/A converter: 24 bit, 192 kHz
- A/D converter: 24 bit, 96 kHz

## Video Recording

- Recording system: PAL, SECAM
- Compression formats: MPEG2
- Recording modes:
  - High Quality : HQ
  - Standard Play : SP
  - Standard Play Plus : SPP
  - Long Play : LP
  - Extended Play : EP
  - Super Long Play : SLP
- Audio compression: Dolby Digital

## Video Playback

- Disc playback media: CD, CD-R/-RW, DVD, DVD-Video, DVD+R/+RW, DVD-R/-RW SVCD, Video CD, DVD+R DL
- Compression formats: MPEG2, MPEG1, MPEG4, DivX 3/4/5/6
- Video disc playback system: NTSC, PAL
- Video tape playback system: PAL, SECAM, ME-SECAM, NTSC

## Audio Playback

- Disc playback media: CD, CD-R/-RW, MP3-CD, MP3-DVD, WMA
- Compression formats: Dolby Digital, DTS, MP3, MPEG2 Multichannel, PCM
- MP3 bit rates: 32~256 kbps and VBR

## Still Picture Playback

- Disc formats: DVD+R/+RW, DVD-R/-RW, CD-R/RW
- Picture compression formats: JPEG
- Picture enhancement: Rotate, Zoom, Slideshow with music playback

## Storage Media

- Recording media: DVD+R, DVD+RW, DVD-R, DVD-RW, DVD+R DL, VHS tape

## Tuner/Reception/Transmission

- TV system: PAL, SECAM
- Aerial Input: 75 Ohm coaxial (IEC75)

## Connectivity

Rear Connections:

- EXT 1 Scart
- EXT 2 Scart
- S-Video Out
- Video (CVBS) Out
- Audio left/right Out
- Digital audio out (coaxial)
- RF antenna in
- RF TV out
- Mains

Front Connections:

- i.LINK DV in (IEEE 1394 4-pin)
- Video In (CAM1)
- Audio left/right In

## Convenience

- Programming/Timer Enhancements: Daily/Weekly, Repeat Programme, Manual Timer, One Touch Recording, SHOWVIEW®/VIDEO PLUS+
- Programmable events: 8

## Power

- Power supply: 220~240V; ~50 Hz
- Consumption: 32 W (typical)
- Standby power consumption: < 5W

## Cabinet

- Dimensions (wxhxd) : 435 x 100 x 344 mm
- Net Weight : 5.2 kg

## Troubleshooting

### WARNING

Under no circumstances should you try to repair the system yourself, as this will invalidate the warranty. Do not open the system as there is a risk of electric shock.

If a fault occurs, first check the points listed below before taking the system for repair. If you are unable to remedy a problem by following these hints, consult your dealer or Philips for help.

Problem (General)	Solution
<b>No power.</b>	<ul style="list-style-type: none"> <li>– Press STANDBY-ON button on the front of the recorder to turn on the system.</li> <li>– Make sure the AC outlet has power.</li> </ul>
<b>Remote control does not work.</b>	<ul style="list-style-type: none"> <li>– Aim the remote control directly at the sensor on the front of the DVD recorder (not towards TV).</li> <li>– Remove any obstacles between the recorder and the remote control. Aim the remote control towards the set at different angles and/or distances.</li> <li>– Batteries are weak, replace the batteries.</li> <li>– Press SOURCE on the remote control to select an input source.</li> </ul>
<b>No picture.</b>	<ul style="list-style-type: none"> <li>– Turn on your TV and set to the correct Video In channel. Switch the TV channel until you see the DVD screen. Read chapter “Step 3 - Installation and Setup – Finding the correct viewing channel” for details.</li> <li>– Check the video connection between the recorder and the TV.</li> </ul>
<b>No sound.</b>	<ul style="list-style-type: none"> <li>– Check the audio connections, the red and white sockets. Read chapters “Getting Started - Connecting the audio cables” for details.</li> <li>– Set the Digital output correctly, based on the equipment you connected to the DVD recorder. Read chapter “DVD Setup Menu Options – PLAYBACK settings – Digital Audio Output” for details.</li> </ul>
<b>No TV signal received from the recorder.</b>	<ul style="list-style-type: none"> <li>– Have your antenna or cable TV signal checked.</li> <li>– Install the TV channel. Read chapter “Step 3: Installation and Setup - Setting the TV channel programmes” for details.</li> </ul>

## Troubleshooting (continued)

Problem (General)	Solution
<b>TV channel is fuzzy or distorted.</b>	<ul style="list-style-type: none"><li>- Check the video connection between the DVD recorder and the TV.</li><li>- You can further fine-tune the signal of the TV channel. Read chapter on "DVD Setup Menu Options - CHANNEL SETUP Settings - Modify Channel Information".</li><li>- Press P + / - to search for the same TV channel which may have a clearer picture.</li></ul>
<b>Unable to eject disc tray.</b>	<ul style="list-style-type: none"><li>- Exit from any system or recording setup menu until you see the Philips wallpaper on the screen.</li><li>- Press STOP to stop any playback or recording. Then press OPEN/CLOSE to eject the disc tray.</li></ul>

# Troubleshooting (continued)

English

Problem (Playback)	Solution
<b>Disc does not play.</b>	<ul style="list-style-type: none"><li>- Insert the disc with the label facing up.</li><li>- Wrong region code. The DVD must be coded for ALL regions or Region 2 in order to play on this DVD recorder.</li><li>- There is no recording on the disc or wrong disc type. Read chapter "DVD Playback - Playable discs" for details.</li><li>- Make sure the disc is not scratched or warped. Clean the disc or replace a new one.</li><li>- Check if the disc is defective by trying another disc.</li></ul>
<b>Distorted sound coming from a connected hi-fi system or amplifier.</b>	<ul style="list-style-type: none"><li>- Do not connect any cables from the recorder to the 'Phono' input of your amplifier.</li><li>- If you are playing a DTS CD, you have to connect the COAXIAL socket of this recorder to a Hi-Fi system or amplifier.</li></ul>
<b>Unable to play DivX movies.</b>	<ul style="list-style-type: none"><li>- Ensure that the DivX file is encoded according to the 'Home Theatre Profile' with the DivX encoder.</li><li>- Check that the DivX movie downloaded is a complete file.</li></ul>
<b>The picture is distorted or black and white during playback.</b>	<ul style="list-style-type: none"><li>- The disc does not match with the TV colour system standard (PAL/NTSC). Change the { Video Output format } in { Setup Menu – General }.</li><li>- The disc is dirty, clean the disc.</li><li>- Sometimes a small amount of picture distortion may appear. This is not a malfunction.</li><li>- For VCR, clean the video heads. If the condition persists, the video heads may have to be replaced.</li><li>- Check if the VHS tape is defective by playing other VHS tapes.</li></ul>
<b>There is picture or sound interference with the TV reception.</b>	<ul style="list-style-type: none"><li>- Have your antenna or cable TV signal checked.</li><li>- Do not tie the cables of the connected devices together.</li><li>- Fine-tune your TV channel. Read chapter "Step 3: Installation and Setup - Setting the TV channel programmes" for details.</li></ul>
<b>The message 'UNKNOWN DISC' appears.</b>	<ul style="list-style-type: none"><li>- This message may appear if you insert a disc that may have encountered one of the following:<ul style="list-style-type: none"><li>- Error during recording: The title may be missing.</li><li>- Error while changing the title/index picture: The original title/index picture may be visible.</li><li>- Error while finalising or the disc has not been finalised.</li></ul></li></ul>



## Troubleshooting (continued)

Problem (Recording)	Solution
<b>The wrong TV channel was decoded (recorded) after you programmed a recording using the ShowView® / VIDEO Plus+ system.</b>	<ol style="list-style-type: none"><li>1) Press SHOWVIEW (or VIDEO Plus+) on the remote control, enter the programming or Plus code number of the desired TV channel.</li><li>2) Press OK to confirm.</li><li>3) Check the channel number in the {Program #} input field. If this does not correspond to the desired TV channel, select this entry field and change the channel number.</li><li>4) Press OK to confirm.</li></ol>
<b>Picture is fuzzy and brightness varies when copying DVD Video discs or prerecorded video tapes.</b>	<ul style="list-style-type: none"><li>– This happens if you try to copy DVDs or video tapes that have been copy-protected. Even though the picture on the TV is fine, but the recording on the DVD recordable disc is faulty. This interference is unavoidable with copy-protected DVDs or video tapes.</li><li>– The DVD recordable disc has a limited recording lifetime, please change a new disc for recording.</li></ul>
<b>Recordings are not occurring as scheduled. New recordings cannot be made.</b>	<ul style="list-style-type: none"><li>– The TV channel you want to record is not stored or you selected the wrong programme number. Check TV channels stored.</li><li>– If you adjust the clock after you set a timer recording, you have to reset the timer recording.</li><li>– If the recorder cannot read the disc, you cannot record.</li><li>– You cannot use the recorder to duplicate copyrighted materials (DVDs or videotapes) onto a DVD±R/±RW.</li><li>– A finalised DVD±R has been inserted. Change disc.</li></ul>
<b>A DVD±R/±RW recorded on this DVD recorder does not playback on a DVD player.</b>	<ul style="list-style-type: none"><li>– If a recording is too short, it is possible that a DVD player cannot detect it.</li><li>– You have to finalise the DVD±R. Refer to chapter “Playing your recordings (DVD±R) on other DVD players” for details.</li></ul>
<b>The picture on my decoder appears to be distorted during recording.</b>	<ul style="list-style-type: none"><li>– If you are recording a programme from your decoder box, you can view the same programme by pressing the TV/VIDEO on the recorder’s remote control.</li></ul>
<b>The VHS tape is ejected when you press REC button.</b>	<ul style="list-style-type: none"><li>– If the safety tab has been removed, cover the tab hole with clear tape.</li><li>– Make sure the VHS tape is not at its end.</li></ul>

## Frequently Asked Questions

### What kind of disc should I use for recording?

You can only record on DVD±R, DVD±RW or DVD+R DL discs. DVD±R/±RW is the most compatible recordable DVD format in the market today. They are fully compatible with most of the existing DVD-Video players and DVD-ROM drives in computers.

### What is the capacity of a DVD±R/+RW disc?

4.7GB, or equivalent to six CDs. You can store only one hour of recordings on a single disc at the highest quality (DVD standard) and about 6 hours recording at the lowest quality (VHS standard). The recording mode indicates the number of hours that will fit on a single disc.

### What is the difference between DVD±R and DVD±RW?

DVD±R is “recordable” and DVD±RW is “erasable” and “rewritable”. With a DVD±R, you can record multiple sessions on the same disc, but when the disc is full, you cannot record any more on the disc. The DVD±RW allows you to record over the same disc repeatedly.

### How do I check the remaining space available on a recordable DVD disc?

In disc menu mode, press REC MODE on the remote control repeatedly to display the remaining recording time in different recording mode.

### What is DV?

Using DV, also known as i.LINK, you can connect a DV-equipped camcorder to this recorder using a single DV cable for input and output of audio, video, data and control signals.

- This recorder is only compatible with DV-format (DVC-SD) camcorders. Digital satellite tuners and Digital VHS video recorders are not compatible.
- You cannot connect more than one DV camcorder at a time to this recorder.
- You cannot control this recorder from external equipment connected via the DV IN socket.

### Can I copy a VHS tape or DVD from an external player?

Yes, but only if the VHS tape or DVD is not copy protected.

### What are Titles and Chapters?

A DVD disc contains Titles and Chapters, which are similar to the Titles and Chapters of a book. A Title is often a complete movie and is broken down into Chapters, or individual scenes from the movies.

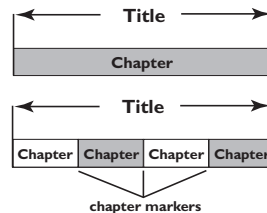

Programmes are recorded as a single title, it may consist of one chapter or a few chapters within a title, depending on the recording settings.

## Frequently Asked Questions (continued)

### How do I set up Titles and Chapters?

The recorder automatically creates a new Title every time you start a new recording. You can then add Chapters to these recordings manually or have them automatically inserted at 5-minute intervals.

### What does “finalising” a disc do?

Finalising a disc locks the disc so it can no longer be recorded, only required for DVD±R. It will then be compatible with any DVD player. To close a disc without finalising it, simply stop recording and eject the disc. You will still be able to record on the disc if there is room for more recordings.

### How good is the quality of the recording?

There are a few quality levels to choose from, ranging from “1 hour mode” (High Quality) to “6 hours mode” (Super Long Play). Press REC MODE button on the remote control to choose the quality level that best suits your purpose and the length of material.

Record Mode	Picture Quality	Maximum Recording Time per Disc (hours)
HQ	High Quality	1
SP	Standard Play	2
SPP	Standard Play Plus	2.5
LP	Long Play	3
EP	Extended Play	4
SLP	Super Long Play	6

### What is ‘index’ for VHS tape?

When you make a recording to a VHS tape, an index is automatically marked on the tape when recording starts. These index markings can help to locate a specific recording quickly and easily.

## Glossary

---

**Analogue:** Sound that has not been turned into numbers. Analogue sound varies, while digital sound has specific numerical values. These sockets send audio through two channels, the left and right.

**Aspect ratio:** The ratio of vertical and horizontal sizes of a displayed image. The horizontal vs. vertical ratio of conventional TVs. is 4:3, and that of wide-screens is 16:9.

**AUDIO OUT Sockets:** Red and white sockets on the back of the system that send audio to another system (TV, Stereo, etc).

**Chapter:** Sections of a picture or a music piece on a DVD that are smaller than titles. A title is composed of several chapters. Each chapter is assigned a chapter number enabling you to locate the chapter you want.

**Digital:** Sound that has been converted into numerical values. Digital sound is available when you use the DIGITAL AUDIO OUT COAXIAL. These sockets send audio through multiple channels, instead of just two channels as analogue does.

**Disc menu:** A screen display prepared for allowing selection of images, sounds, subtitles, multi-angles, etc recorded on a DVD.

**DivX:** The DivX code is a patent pending, MPEG-4 based video compression technology, developed by DivX Networks Inc., that can shrink digital video to sizes small enough to be transported over the internet, while maintaining high visual quality.

**Dolby Digital:** A surround sound system developed by Dolby Laboratories containing up to six channels of digital audio (front left and right, surround left and right, centre and subwoofer).

**DTS:** Digital Theatre Systems. This is a surround sound system, but it is different from Dolby Digital. The formats were developed by different companies.

**Index Picture Screen:** A screen that gives an overview of a DVD±RW or DVD±R. An Index Picture represents each recording.

**JPEG:** A very common digital still picture format. A still-picture data compression system proposed by the Joint Photographic Expert Group, which features small decrease in image quality in spite of its high compression ratio.

**MP3:** A file format with a sound data compression system. "MP3" is the abbreviation of Motion Picture Experts Group 1 (or MPEG-1) Audio Layer 3. By using the MP3 format, one CD-R or CD-RW can contain about 10 times more data than a regular CD.

**MPEG:** Motion Picture Experts Group. A collection of compression systems for digital audio and video.

**Multichannel:** DVDs are formatted to have each sound track constitute one sound field. Multichannel refers to a structure of sound tracks having three or more channels.

**PBC:** Playback Control. Refers to the signal recorded on video CDs or SVCDs for controlling playback. By using menu screens recorded on a Video CD or SVCD that supports PBC, you can enjoy interactive playback and searching.

**PCM:** Pulse Code Modulation. A digital audio encoding system.

**Parental control:** Limits disc play according to the age of the users or the limitation level in each country. The limitation varies from disc to disc; when it is activated, playback will be prohibited if the software's level is higher than the user-set level.

**Region code:** A system allowing discs to be played only in the region designated. This unit will only play discs that have compatible region codes. You can find the region code of your unit by looking on the product label. Some discs are compatible with more than one region (or ALL regions).

**S-Video:** Produces a clear picture by sending separate signals for the luminance and the colour. You can use S-Video only if your TV has an S-Video In socket.

**Surround:** A system for creating realistic three dimensional sound fields full of realism by arranging multiple speakers around the listener.

**Title:** The longest section of a movie or music feature on DVD. Each title is assigned a title number, enabling you to locate the title you want.

**VIDEO OUT socket:** Yellow socket on the back of the DVD system that sends the DVD picture video to a TV.

**WMA** : WMA is short for Windows Media Audio and refers to an audio compression technology developed by Microsoft Corporation. WMA data can be encoded by using Windows Media Player version 9 or Windows Media Player for Windows XP. Files are recognised by their file extension". wma" or ".WMA".

## Display panel symbols/ messages

The following symbols/ messages may appear on your recorder display:

- 00:00:00  
Multi-function display/ text line
  - Title/ track number
  - Total/ elapsed/remaining title/track time
  - Disc/title name
  - Additional information regarding the disc
  - TV channel number or source of video
  - Clock (This is displayed in Standby mode).
  - TV programme title
- BLANK  
There are no recordings in the disc on the tray.
- FULL  
Disc is full. There is no more storage space for new recordings.
- LOADING  
Disc is being recognised by the recorder.
- MENU  
The setup menu, disc menu, title menu or timer menu display is on.
- NO DISC  
No disc has been inserted. If a disc has been inserted, then it is possible that the disc cannot be read.
- OPEN  
Disc tray is opening or opened.
- PHOTO  
A picture disc has been inserted.
- STARTUP  
The recorder has been turned on.
- REGION  
When the DVD inserted is in a wrong region code as the recorder.
- STOP  
When playback / recording is stopped.
- ⌚ TIMER  
A timer recording has been programmed or is active.
- UPDATE  
The recorder is writing to the disc.
- UNKNOWN  
The recorder has encountered an error in handling the disc inserted.
- SET CLOCK  
The system clock has to be set.
- UNRECORDABLE DISC  
The disc inserted cannot be used for recording.
- COPY PROTECT  
The content is copy- protected.
- FINALIZED DISC  
The disc inserted has been finalised. No further recordings can be made on the disc.
- RECORDING  
A recording is in progress.



# TV System Guide

English

COUNTRY	VHF	UHF	DVD REGIONS
AFGHANISTAN	PAL/SECAM B		5
ALBANIA	PAL B	PAL G	2
ALGERIA	PAL B	PAL G	5
ANGOLA	PAL I		5
ARGENTINA	PAL N	PAL N	4
AUSTRALIA	PAL B	PAL H	4
AUSTRIA	PAL B	PAL G	2
AZORES	PAL B		
BAHAMAS	NTSC M		4
BAHRAIN	PAL B	PAL G	2
BANGLADESH	PAL B		5
BARBADOS	NTSC M		4
BELGIUM	PAL B	PAL H	2
BERMUDA	NTSC M		
BOLIVIA	NTSC M	NTSC M	4
BOTSWANA	PAL I		5
BRAZIL	PAL M	PAL M	4
BRUNEI	PAL B	PAL B	
BULGARIA	PAL B	PAL G	2
BURKINA FASO	SECAM K1		5
BURMA	NTSC M		
BURUNDI	SECAM K1		5
CAMBODIA	NTSC M		3
CAMEROON	PAL B	PAL G	5
CANADA	NTSC M	NTSC M	1
CANARY ISLANDS	PAL B		2
CHAD	SECAM K1		5
CHILE	NTSC M	NTSC M	4
CHINA	PAL D		6
COLOMBIA	NTSC M	NTSC M	4
COSTA RICA	NTSC M	NTSC M	4
CROATIA	PAL B	PAL G	2
CUBA	NTSC M	NTSC M	4
CYPRUS	PAL B	PAL G	
CZECH REPUBLIC	PAL D	PAL K	2
DAHOMY	SECAM K1		
DENMARK	PAL B	PAL G	2
DJIBOUTI	SECAM B	SECAM G	5
DOMINICAN REP	NTSC M	NTSC M	4
ECUADOR	NTSC M	NTSC M	4
EGYPT	SECAM B/PAL B	SECAM G/PAL G	2
EL SALVADOR	NTSC M	NTSC M	4
EQUAT. GUINEA	PAL B		5
ESTONIA	PAL B (was SECAM)	PAL D	5
ETHIOPIA	PAL B	PAL G	5
FIJI	PAL B		
FINLAND	PAL B	PAL G	2
FRANCE	SECAM L	SECAM L	2
FRENCH POLYNESIA	SECAM K1		
GABON	SECAM K1		5
GAMBIA	PAL I		5
GERMANY	PAL B	PAL G	2
GHANA	PAL B	PAL G	5
GIBRALTAR	PAL B	PAL H	2
GREECE	PAL B (was SECAM)	PAL G	2
GREENLAND	NTSC/PAL B		2
GUADELOUPE	SECAM K1		
GUAM	NTSC M		1
GUATEMALA	NTSC M	NTSC M	4
GUINEA	PAL K		5
GUYANA (FRENCH)	SECAM K1		4
HONDURAS	NTSC M	NTSC M	4



## TV System Guide (continued)

COUNTRY	VHF	UHF	DVD REGIONS
LIBYA	SECAM B	SECAM G	5
LITHUANIA	PAL D (was SECAM)	PAL K	5
LUXEMBOURG	PAL B/SECAM L	PAL G/SEC L	2
MADAGASCAR	SECAM K1		5
MADEIRA	PAL B		
MALAGASY	SECAM K1		
MALAWI	PAL B	PAL G	5
MALAYSIA	PAL B		3
MALI	SECAM K1		5
MALTA	PAL B	PAL H	2
MARTINIQUE	SECAM K1		
MAURITANIA	SECAM B		5
MAURITIUS	SECAM B		5
MEXICO	NTSC M	NTSC M	4
MONACO	SECAM L		2
MONGOLIA	SECAM D		5
MOROCCO	SECAM B		5
MOZAMBIQUE	PAL B		5
NAMIBIA	PAL I		5
NEPAL	PAL B		
NETHERLANDS	PAL B	PAL G	2
NETH. ANTILLES	NTSC M	NTSC M	
NEW CALEDONIA	SECAM K1		
NEW GUINEA	PAL B	PAL G	4
NEW ZEALAND	PAL B	PAL G	4
NICARAGUA	NTSC M	NTSC M	4
NIGER	SECAM K1		5
NIGERIA	PAL B	PAL G	5
NORWAY	PAL B	PAL G	2
OMAN	PAL B	PAL G	2
PAKISTAN	PAL B		5
PANAMA	NTSC M	NTSC M	4
PARAGUAY	PAL N	PAL N	4
PERU	NTSC M	NTSC M	4
PHILIPPINES	NTSC M	NTSC M	3
POLAND	PAL D	PAL K	2
PORTUGAL	PAL B	PAL G	2
PUERTO RICO	NTSC M	NTSC M	1
QATAR	PAL B		2
REUNION	SECAM K1		
RUMANIA	PAL D	PAL K	2
RUSSIA	SECAM D	SECAM K	5
RWANDA	SECAM K1		5
SABAH/SAWARA	PAL B		
ST. KITTS	NTSC M	NTSC M	
SAMOA (US)	NTSC M		1
SAUDI ARABIA	SECAM-B/PAL-B	SECAM G	2
SENEGAL	PAL		5
SEYCHELLES	PAL B	PAL G	5
SIERRA LEONE	PAL B	PAL G	5
SINGAPORE	PAL B	PAL G	
SLOVAK REPUBLIC	PAL	PAL	2
SOMALIA	PAL B	PAL G	5
SOUTH AFRICA	PAL I	PAL I	2
SPAIN	PAL B	PAL G	2
SRI LANKA	PAL B		5
SUDAN	PAL B	PAL G	5
SURINAM	NTSC M	NTSC M	4
SWAZILAND	PAL B	PAL G	
SWEDEN	PAL B	PAL G	2
SWITZERLAND	PAL B	PAL G	2
SYRIA	SECAM B		2

English

English

Meet Philips at the Internet  
<http://www.philips.com/support>

 Be responsible  
Respect copyrights

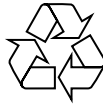

DVDR3430V  
DVDR3432V

**CLASS 1  
LASER PRODUCT**

3139 245 22162



Sgp-0624/05-1

## Free Manuals Download Website

<http://myh66.com>

<http://usermanuals.us>

<http://www.somanuals.com>

<http://www.4manuals.cc>

<http://www.manual-lib.com>

<http://www.404manual.com>

<http://www.luxmanual.com>

<http://aubethermostatmanual.com>

Golf course search by state

<http://golfingnear.com>

Email search by domain

<http://emailbydomain.com>

Auto manuals search

<http://auto.somanuals.com>

TV manuals search

<http://tv.somanuals.com>