

DIGITAL VIDEO DISC PLAYER & VIDEO CASSETTE RECORDER

DVP3050V/37

User manual



Thank you for choosing Philips.

Need help fast?

Read your Quick Use Guide and/or Owner's Manual first for quick tips that make using your Philips product more enjoyable.

If you have read your instructions and still need assistance, you may access our online help at

www.philips.com/support

or call

1-888-PHILIPS (744-5477)

while with your product.



Philips vous remercie de votre confiance.

Besoin d'une aide rapide?

Les Guide d'utilisation rapide et Manuel de l'utilisateur regorgent d'astuces destinées à simplifier l'utilisation de votre produit Philips.

Toutefois, si vous ne parvenez pas à résoudre votre problème, vous pouvez accéder à notre aide en ligne à l'adresse

www.philips.com/support

ou formez le

1-800-661-6162 (Francophone)

1-888-PHILIPS (744-5477) (English speaking)

Veillez à avoir votre produit à portée de main.



Gracias por escoger Philips

Necesita ayuda inmediata?

Lea primero la Guía de uso rápido o el Manual del usuario, en donde encontrará consejos que le ayudarán a disfrutar plenamente de su producto Philips.

Si después de leerlo aún necesita ayuda, consulte nuestro servicio de asistencia en línea en

www.philips.com/support

o llame al teléfono

1-888-PHILIPS (744-5477)

y tenga a mano el producto.



PHILIPS

Return your Product Registration Card today to get the very most from your purchase.

Registering your model with PHILIPS makes you eligible for all of the valuable benefits listed below, so don't miss out. Complete and return your Product Registration Card at once to ensure:

*Proof of Purchase

Returning the enclosed card guarantees that your date of purchase will be on file, so no additional paperwork will be required from you to obtain warranty service.

*Product Safety Notification

By registering your product, you'll receive notification - directly from the manufacturer - in the rare case of a product recall or safety defect.

*Additional Benefits of Product Ownership

Registering your product guarantees that you'll receive all of the privileges to which you're entitled, including special money-saving offers.

PHILIPS

Congratulations on your purchase, and welcome to the "family!"

Dear PHILIPS product owner:

Thank you for your confidence in PHILIPS. You've selected one of the best-built, best-backed products available today. We'll do everything in our power to keep you happy with your purchase for many years to come.

As a member of the PHILIPS "family," you're entitled to protection by one of the most comprehensive warranties and outstanding service networks in the industry. What's more, your purchase guarantees you'll receive all the information and special offers for which you qualify, plus easy access to accessories from our convenient home shopping network.

Most importantly, you can count on our uncompromising commitment to your total satisfaction.

All of this is our way of saying welcome - and thanks for investing in a PHILIPS product.

P.S. To get the most from your PHILIPS purchase, be sure to complete and return your Product Registration Card at once.

Know these safety symbols



This "bolt of lightning" indicates uninsulated material within your unit may cause an electrical shock. For the safety of everyone in your household, please do not remove product covering.



The "exclamation point" calls attention to features for which you should read the enclosed literature closely to prevent operating and maintenance problems.

WARNING: TO REDUCE THE RISK OF FIRE OR ELECTRIC SHOCK, THIS APPARATUS SHOULD NOT BE EXPOSED TO RAIN OR MOISTURE, AND OBJECTS FILLED WITH LIQUIDS, SUCH AS VASES, SHOULD NOT BE PLACED ON THIS APPARATUS.

CAUTION: To prevent electric shock, match wide blade of plug to wide slot, fully insert.

ATTENTION: Pour éviter les choc électriques, introduire la lame la plus large de la fiche dans la borne correspondante de la prise et pousser jusqu'au fond.

For Customer Use

Enter below the Serial No. which is located on the rear of the cabinet. Retain this information for future reference.

Model No. _____
Serial No. _____

PHILIPS Visit our World Wide Web Site at <http://www.philips.com/support>

Safety Information 3

English

Safety Precautions

Warning: To prevent fire or shock hazard, do not expose this equipment to rain or moisture.

Federal Communications Commission (FCC) Warning: Any unauthorized changes or modifications to this equipment void the user's authority to operate it.

- Do not stand the unit up vertically. Install the unit in a horizontal and stable position.
- Be sure to remove the disc and unplug the AC power cord from the output before carrying the unit.

Department of Health and Human Services (DHHS) Certification: Complies with 21 Center for Radiation (CFR) chapter 1 subchapter J applicable at time of manufacture.

Laser Safety: This unit employs a laser. Only a qualified service person should remove the cover or attempt to service this device, due to possible eye injury.

CAUTION: USE OF CONTROLS OR ADJUSTMENTS OR PERFORMANCE OF PROCEDURES OTHER THAN THOSE SPECIFIED HEREIN MAY RESULT IN HAZARDOUS RADIATION EXPOSURE.

CAUTION: VISIBLE AND INVISIBLE LASER RADIATION WHEN OPEN AND INTERLOCK DEFEATED. DO NOT STARE INTO BEAM. THE BEAM IS LOCATED INSIDE, NEAR THE DECK MECHANISM.

Special Information for Canadian Users: This Class B digital apparatus complies with Canadian ICES-003. Cet appareil numérique de la classe B est conforme à la norme NMB-003 du Canada.

Radio/TV Interference: This equipment has been tested and found to comply with the limits for a Class B digital device, pursuant to Part 15 of the FCC Rules. These limits are designed to provide reasonable protection against harmful interference in a residential installation. This equipment generates, uses, and can radiate radio frequency energy and, if not installed and used in accordance with the instructions, may cause harmful interference to radio communications. However, there is no guarantee that interference will not occur in a particular installation. If this equipment does cause harmful interference to radio or television reception, which can be determined by turning the equipment off and on, the user is encouraged to try to correct the interference by one or more of the following measures:

- 1) Reorient or relocate the receiving antenna.
- 2) Increase the separation between the equipment and the receiver.
- 3) Connect the equipment into an outlet on a circuit different from that to which the receiver is connected.
- 4) Consult the dealer or an experienced radio/TV technician for help.

Copyright Protection: Unauthorized copying, broadcasting, public performance, and lending of Discs are prohibited.

This product incorporates copyright protection technology that is protected by U.S. patents and other intellectual property rights. Use of this copyright protection technology must be authorized by Macrovision, and is intended for home and other limited viewing uses only unless otherwise authorized by Macrovision. Reverse engineering or disassembly is prohibited.

Notice for Progressive Scan Use: Consumers should note that not all high definition television sets are fully compatible with this product and may cause artifacts to be displayed in the picture. In case of picture problems with 525 and 625 progressive scan output, it is recommended that the user switch the connection to the 'standard definition' output. If there are questions regarding your TV set compatibility with this 525p and 625p DVD player, please contact our customer service center.

Note to the Cable TV System Installer: This reminder is provided to call the Cable TV system installer's attention to Article 820-40 of the National Electrical Code, which provides guidelines for proper grounding – in particular, specifying that the cable ground shall be connected to the grounding system of the building, as close to the point of cable entry as possible.

Declaration of Conformity

Model Number: DVP3050V/37
 Trade Name: Philips
 Responsible Party: Philips Consumer Electronics North America
 P.O. Box 671539
 Marietta, GA 30006-0026
 1-888-PHILIPS (744-5477)

Manufactured under license from Dolby Laboratories. "Dolby" and the double-D symbol are trademarks of Dolby Laboratories.

Copyright 2005 Philips. All rights reserved.

4 Safety Information (cont'd)

IMPORTANT SAFETY INSTRUCTIONS

Read before operating equipment

1. Read these instructions.
2. Keep these instructions.
3. Heed all warnings.
4. Follow all instructions.
5. Clean only with a dry cloth.
7. Do not block any of the ventilation openings. Install in accordance with the manufacturers instructions.
8. Do not install near any heat sources such as radiators, heat registers, stoves, or other apparatus (including amplifiers) that produce heat.
9. Do not defeat the safety purpose of the polarized or groundingtypeplug. A polarized plug has two blades with one wider than the other. A grounding type plug has two blades and third grounding prong. The wide blade or third prong are provided for your safety. When the provided plug does not fit into your outlet, consult an electrician for replacement of the obsolete outlet.
10. Protect the power cord from being walked on or pinched particularly at plugs, convenience receptacles, and the point where they exit from the apparatus.
11. Only use attachments/accessories specified by the manufacturer.
12.  Use only with a cart, stand, tripod, bracket, or table specified by the manufacturer, or sold with the apparatus. When a cart is used, use caution when moving the cart/apparatus combination to avoid injury from tip-over.
13. Unplug this apparatus during lightning storms or when unused for long periods of time.
14. Refer all servicing to qualified service personnel. Servicing is required when the apparatus has been damaged in any way, such as power-supply cord or plug is damaged, liquid has been spilled or objects have fallen into apparatus, the apparatus has been exposed to rain or moisture, does not operate normally, or has been dropped.
15. This product may contain lead and mercury. Disposal of these materials may be regulated due to environmental considerations. For disposal or recycling information, please contact your local authorities or the Electronic Industries Alliance: www.eiae.org
16. **Damage Requiring Service** - The appliance should be serviced by qualified service personnel when:
 - A. The power supply cord or the plug has been damaged; or
 - B. Objects have fallen, or liquid has been spilled into the appliance; or
 - C. The appliance has been exposed to rain; or
 - D. The appliance does not appear to operate normally or exhibits a marked change in performance; or
 - E. The appliance has been dropped, or the enclosure damaged.
17. **Tilt/Stability** - All televisions must comply with recommended international global safety standards for tilt and stability properties of its cabinet design.
 - Do not compromise these design standards by applying excessive pull force to the front, or top, of the cabinet which could ultimately overturn the product.
 - Also, do not endanger yourself, or children, by placing electronic equipment/toys on the top of the cabinet. Such items could unsuspectingly fall from the top of the set and cause product damage and/or personal injury.
18. **Wall or Ceiling Mounting** - The appliance should be mounted to a wall or ceiling only as recommended by the manufacturer.
19. **Power Lines** - An outdoor antenna should be located away from power lines.
20. **Outdoor Antenna Grounding** - If an outside antenna is connected to the receiver, be sure the antenna system is grounded so as to provide some protection against voltage surges and built up static charges. Section 810 of the National Electric Code, ANSI/NFPA No. 70-1984, provides information with respect to proper grounding of the mast and supporting structure, grounding of the lead-in wire to an antenna discharge unit, size of grounding connectors, location of antenna-discharge unit, connection to grounding electrodes, and requirements for the grounding electrode. See Figure below.
21. **Object and Liquid Entry** - Care should be taken so that objects do not fall and liquids are not spilled into the enclosure through openings.
 - a) **Warning:** To reduce the risk of fire or electric shock, this apparatus should not be exposed to rain or moisture and objects filled with liquids, such as vases, should not be placed on this apparatus.
22. **Battery Usage CAUTION** - To prevent battery leakage that may result in bodily injury, property damage, or damage to the unit:
 - Install all batteries correctly, with + and - aligned as marked on the unit.
 - Do not mix batteries (old and new or carbon and alkaline, etc.).
 - Remove batteries when the unit is not used for a long time.

Note to the CATV system installer: This reminder is provided to call the CATV system installer's attention to Article 820-40 of the NEC that provides guidelines for proper grounding and, in particular, specifies that the cable ground shall be connected to the grounding system of the building, as close to the point of cable entry as practical.

Example of Antenna Grounding as per NEC - National Electric Code

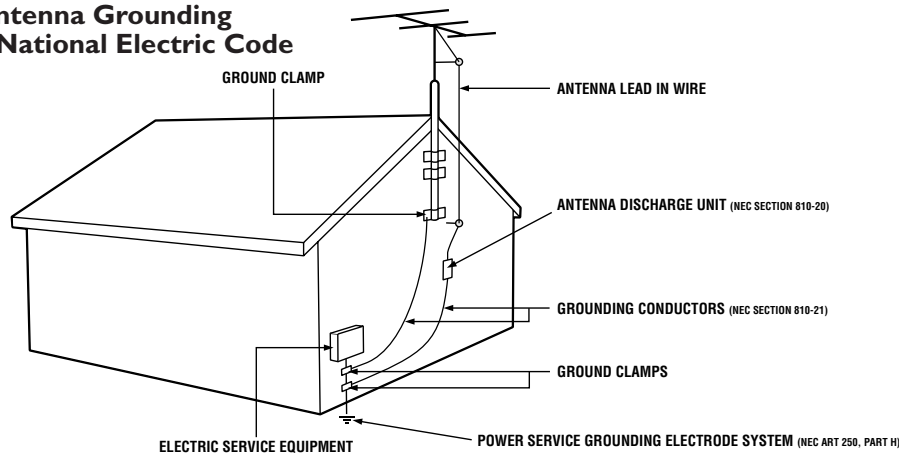

Table of Contents 5

General Information

Safety Information	3-4
Table of Contents	5
Introduction	6
Playable Discs and Video Cassettes	7

Initial DVD/VCR Setup

Hookups	8-14
Remote Control Setup	15
First-time DVD/VCR Setup	16

Basic Playback

Video Cassette Playback	17
Disc Playback	18

Basic DVD/VCR Controls

Display Panel	19
Front Panel, Rear Panel, and Remote Control	20

Additional VCR Setup

Channel Setup	21
Clock (VCR)	22
Language (VCR)	23
VCR Status Displays	23

VCR Recording Options

Videotape Recording	24
Recording One Channel/Watching Another	25
One-Touch Recording	26
Rerecording (Tape Duplication)	27
Timer Recording	28-29
DVD to Videotape Duplication	30

Video Cassette Playing Options

Repeat Playback	31
Tape Counter	31
Time Search, Index Search	32
Special Effects Playback	33
Automatic Operation Features	33

Additional VCR Features

Multi-Channel Television Sound/Hi-Fi Stereo	34
---	----

Disc Playback Features

Menus, Playback Control (PBC) Function	35
Fast Forward/Reverse Search	36
Title/Chapter Playback, Time Playback	37
Track Playback	38
Paused and Step-by-Step Playback, Resume On	39
Repeat, A-B Repeat	40
Markers	41
Subtitles, Camera Angles	42
Audio Language, Stereo Sound Mode	43
Slow Motion, Zoom	44
Program /Random Playback	45
MP3/Windows Media™ Audio/JPEG Playback	46-47
On-Screen Displays	48-49
Black Level, Virtual Surround	50
Initializing	50

DVD Player Setup Options

Language	51-52
Display	53-54
Progressive Scan	54
Audio	55
Parental Levels	56
Parental Password	57
Others	58-59

Information You May Need

Glossary	60
Helpful Hints	61-63
Care and Maintenance	64
Specifications	64
Limited Warranty	65
Information Index	66

6 Introduction

Welcome!

This DVD/VCR combines a Digital Video Disc (DVD) Player and a Hi-Fi Video Cassette Recorder (VCR) into one unit, letting you play DVDs, Audio Compact Discs (Audio CDs), and Video Cassettes on one piece of equipment.

Read this owner's manual carefully to learn how to use the features listed below.

VCR Features

- Automatic Head Cleaner
- Channel Setup
- English, French, and Spanish menus and displays
- Multi-Channel TV Sound
- 19 Micron head
- Recording: One-Touch and Timer
- Repeat Playback
- Searching: Time, Index, Forward, and Reverse
- Slow Motion
- Still Picture
- Tape Counter
- Tracking Adjustment

Disc Features

- Audio Language choices *
- Camera Angles *
- DVD Menus in a desired language *
- Markers
- MP3 Playback
- JPEG Playback
- Windows Media™ Audio Playback
- Dual Playback
- Parental control*
- Paused/Fast/Slow/Step-by-Step Playback
- Program Playback
- Progressive Scan
- Random Playback
- Repeat, A-B Repeat
- Resume On
- Specific Time/Title/Chapter/Track Playback
- Subtitles *
- Zoom
- * If available on the Disc

Package Contents

The following items are provided with your new DVD/VCR.

- Remote Control and two AA batteries
- One black RF coaxial cable, 75 ohm
- One set of Audio (red and white tips) and Video (yellow tips) cables
- This Owner's Manual and Quick-Use Guide

DVD Disc Menus...

Some explanations in this manual describe DVD Disc menus. DVD manufacturers set the menus, which vary among DVDs. Not all DVDs have menus. If the DVD has a menu, access it by pressing DVD, then DISC/VCR MENU on the remote control.

Details are on page 35.

DVD Player Setup Menu...

Some instructions explain how to use the DVD Player's Setup menu to set up features of the DVD Player or a DVD. Access the DVD Player menu by pressing SYSTEM/MENU on the remote control when playback is stopped. Even if a feature is set in the DVD Player's menu, it may not be available if the current DVD does not include that feature.

Available Disc Features...



All features described in this manual are not available on every Disc. If the feature is not available on the Disc, you cannot use the DVD/VCR to make it available. An "X" will appear in the top right corner of the TV screen if you try to access a feature that is not currently available.

Playable Discs and Video Cassettes 7

Playable Discs

The DVD Player will play Digital Video Discs (DVDs); Audio Compact Discs (CDs); finalized Digital Video Discs Rewritable (DVD+RW); finalized Compact Discs Rewritable (CD-RW) and Compact Discs Recordable (CD-R); and Video Compact Discs (VCDs).

To play a DVD, make sure it meets the requirements for Region Codes and Color Systems as described below. Discs that have the following logos will play on the DVD Player. Other Disc types are not guaranteed to play in the DVD/VCR.

On a Super Audio CD, only the sound on the normal CD layer can be heard. The sound on the high-density Super Audio CD layer cannot be heard.

- Do not stand the unit up vertically. Install the unit in a horizontal and stable position.
- Be sure to remove the disc and unplug the AC power cord from the output before carrying the unit.



DVD

Audio
CDCD-R
CD-RWMP3
FilesVideo
CD

DVD+R

DVD+RW

DVD is a trademark of DVD Format/Logo Licensing Corporation.

Windows Media is a trademark of Microsoft Corporation.

This unit is not compatible with Multiple Bit Rate (MBR: a file that contains the same content encoded at several different bit rates).

ABOUT THE PBC FUNCTION OF VIDEO CD

This unit can play Video CD 1.1 (without PBC) and 2.0 (with PBC).

With version 2.0 (with PBC), you can use interactive menu (e.g., playlists) on the TV screen.

When playing a Video CD with PBC, some operations cannot be performed unless the PBC function is cancelled temporarily. See page 35 for more details.

Region Codes

DVDs must be labeled for ALL regions or for Region 1 in order to play on this DVD Player. You cannot play DVDs that are labeled for other regions.

Look for the symbols below on your DVDs. If these region symbols do not appear on your DVD, you cannot play the DVD in this Player.



The number inside the globe refers to a region of the world. Region 1 represents the United States, Canada, upper regions of North America, Bermuda, the U.S. Virgin Islands, and small regions near Australia.

A Disc encoded in a specific region format can only play on DVD Players with the same region code. For example, if a Disc is labeled for Region 2, you cannot play the DVD on this Player.

Color Systems

Different color systems are available throughout the world. The most common color systems are NTSC, which is used primarily in the United States and North America, PAL, and SECAM.

This DVD Player will play both NTSC and PAL DVDs. You cannot play DVDs recorded in other formats. The color system of the DVD may be listed on the DVD or on the Disc case. Your TV must have the NTSC and/or PAL color system as well.

Playable Video Cassettes

The VCR of this DVD/VCR has a High Quality (HQ) system and is compatible with existing Video Home System (VHS) equipment. Use only video cassettes that have the **VHS** mark. The use of other tapes may result in poor picture quality and excessive deposits on the video heads, which may not be covered by the warranty if damage occurs.

The VCR also has a 19 micron head, which provides a better picture when you view tapes recorded in slow speed (SLP).

Unacceptable Discs

If you insert an unacceptable type of disc, a Disc Error message may appear on the TV screen. The following Discs will not play on this DVD Player.

- CD-ROM
- Video Single Disc (VSD)
- Unfinalized Disc
- Compact Disc-Interactive (CD-I)
- DVD-ROM
- DVD contains MP3, Windows Media™ Audio or JPEG Files
- DVD-RAM
- DVD-Audio

On the following disc, the sound may not be heard.

- Super Audio CD - Only the sound on the CD layer can be heard. The sound on the high-density Super Audio CD layer cannot be heard.

8 Hookups

Determining the best possible connection...

Your hookup will be determined primarily by your existing equipment, especially your TV. These guidelines describe which options have the best picture and sound quality. You will not use all the jacks on the DVD/VCR.

If your TV only has an RF-style jack, usually labelled Antenna In, RF In, or 75 ohm, use the ANT-OUT jack of the DVD/VCR to connect to the TV. This hookup provides both audio and video in a single cable. Set your TV to channel 3 or 4 - the output channel of the DVD/VCR. This connection allows you to use both the DVD and VCR features. See page 9.

★★★★ If your TV has Component Video In jacks (which could be labelled Y CR CB, Y PR PB, or YUV and may be green, blue, and red), use the Component Video jacks (Y CB/PB CR/PR) for the best picture quality. If you use only this video connection, only the DVD picture will be available. To see DVD features on the TV, set the TV to its Component Video In channel. Component Video provides the best picture quality. See page 12. Progressive Scan provides less flickering and higher image resolution than traditional (525i/480i or interlace) TV signals.

If your TV has Progressive Scan (525p/480p or progressive), connect the TV to the DVD/VCR's COMPONENT VIDEO OUT (Y CB/PB CR/PR) jacks. Set PROGRESSIVE to ON in the DVD/VCR's DISPLAY menu. See pages 53-54. P.SCAN will appear on the DVD/VCR's display panel. Set your TV to Progressive Scan also.

If your TV does not have Progressive Scan but has Component Video In jacks, connect them to the DVD/VCR's COMPONENT VIDEO OUT jacks (Y CB/PB CR/PR). Set PROGRESSIVE to OFF either in the DISPLAY menu or by pressing and holding PLAY ► (DVD) on the front of the DVD/VCR for more than 5 seconds. See pages 53-54.

★★★ If your TV has an S-Video In jack (which also may be labelled Y/C or S-VHS), use the S-VIDEO OUT jack for excellent picture quality. If you use only this video connection, only the DVD picture will be available. To see DVD features on the TV, set the TV to its S-Video In channel. See page 12.

★★ If your TV has a single yellow Video In jack (which also may be labelled CVBS, Composite, or baseband), use the yellow DVD/VCR VIDEO OUT jack for good picture quality. This connection provides a picture for both the DVD Player and the VCR. To see DVD or VCR features on the TV, set the TV to its Video In channel. See page 10.

★★★★ If you have a Stereo with a Coaxial Digital Audio In jack, this provides the clearest sound for the DVD Player. Connect the DVD/VCR's COAXIAL DIGITAL AUDIO OUT jack to your Stereo for the best sound quality. If you use only this audio connection, only Disc sound (no VCR) will be available. See page 14.

★★★ If digital audio connections are not possible, connect the DVD/VCR's red and white DVD/VCR AUDIO OUT jacks to the Audio In jacks of your Stereo or TV. This connection provides sound for both the DVD Player and the VCR. See pages 12-13.

Before you begin...

- Refer to the manuals of your TV, Cable Box, Stereo, or other devices as necessary. Note the style of jacks and connectors on the other equipment. Determine how to choose different Audio and Video In channels on your other equipment so you can see and hear the DVD/VCR material playing on the TV, Stereo, etc.
- Disconnect all equipment from the power outlets. Connect the equipment to power only after you have finished hooking up everything. Never make or change connections with equipment connected to power.

Remember...

- Set the TV to the correct Video In channel. Such channels may be called AUX or AUXILIARY IN, AUDIO/VIDEO or A/V IN, EXT1 or External In, etc. These channels often are located near channel zero (0). Or, your TV's remote may have a button or switch that selects the Video Input channel. See your TV manual for details. If you do not see the DVD or VCR playback on the TV, go to the lowest TV channel (01 or 02) and change channels downward until you see the DVD or VCR picture on the TV. Or, if your TV has only a single Antenna In jack and you are using the RF coaxial cable (as described on page 9), set the TV to channel 3 or 4. To help you find the right Audio/Video In channel, turn on the DVD/VCR. Press DVD to put the DVD/VCR in DVD mode. With no Disc in the Player, a large DVD Video logo will appear on the TV screen when you get the TV on the correct Audio/Video In channel or channel 3 or 4.
- Set the Stereo to the correct channel or "source" mode.
- Depending on your connection, you may need to purchase additional cables or adaptors. If your TV or monitor has BNC-type connectors, you will need an adaptor.
- **To use the VCR features, you must include a connection with the supplied yellow video cable and red/white audio cables or with the supplied RF coaxial cable.**

Once you determine the best option, find your choice on pages 9-14. Follow the steps for the hookup you choose. Then, go to page 16 to complete the first-time setup.

Hookups (cont'd) 9

English

DVD/VCR to TV only

Simplest connection using only the supplied black RF coaxial cable
This connection will let you use the features of both the VCR and the DVD Player.

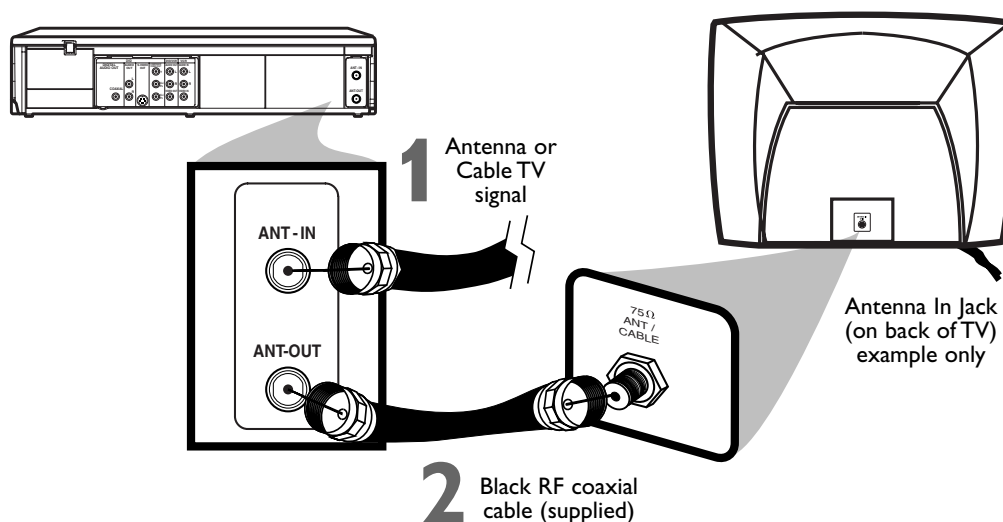

- 1** Disconnect the antenna or Cable TV signal from your TV and connect it to the **ANT-IN (Antenna In)** jack of your DVD/VCR.
- 2** Connect the supplied black RF coaxial cable to the **ANT-OUT (Antenna Out)** jack on the back of the DVD/VCR and to the **ANTENNA IN** jack on the TV. The ANTENNA IN jack on the TV may be labelled TV IN, RF IN, 75Ω (ohm), or ANT-IN. See your TV owner's manual for assistance.
- 3** Plug in the power cord of your TV. Turn on the TV and set it to channel 3 or 4.
- 4** Plug in the power cord of the DVD/VCR. You are ready to turn on the DVD/VCR. Go to page 16 before turning it on.
 The DVD/VCR's output channel is 3 when you purchase it. So, set your TV to channel 3 when the DVD/VCR is new.
 If you cannot use channel 3 at your TV, you can change the DVD/VCR's output channel to channel 4. To do so, press VCR to put the DVD/VCR in VCR mode. VCR light will be on the front of the DVD/VCR. Insert a videotape and press PLAY ► to start playback. **During playback, press and hold (VCR) PLAY ► on the front of the DVD/VCR for 3-5 seconds.** Each time you do this, the DVD/VCR's output channel switches between 3 and 5, and the selected channel number appears on the display panel. Change your TV to channel 3 or 4 accordingly. (You cannot change the DVD/VCR's output channel while adjusting tracking manually. Press STOP ■ to stop playback and cancel manual tracking, then press PLAY ► to resume playing and change the output channel.)
 There is not a channel 3/4 switch on the DVD/VCR (as customary with most VCRs).

10 Hookups (cont'd)

DVD/VCR to Cable Box or Satellite Receiver and TV

Using only basic RF coaxial cables

This connection will let you use the features of both the VCR and the DVD Player.

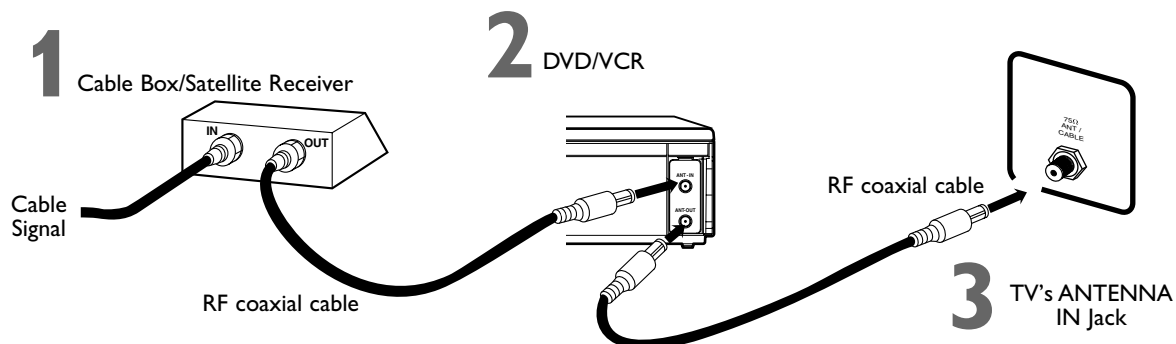

Connections

- 1** Connect a Cable TV or Satellite signal to the IN jack on the Cable Box/Satellite Receiver.
- 2** Use an RF coaxial cable (as the one supplied) to connect the OUT jack on the Cable Box/Satellite Receiver to the ANT-IN (Antenna In) jack on the DVD/VCR.
- 3** Use a second RF coaxial cable to connect the ANT-OUT (Antenna Out) jack on the DVD/VCR to the TV's Antenna In jack.
- 4** Plug in the power cord of your TV. Turn on the TV and set it to channel 3 or 4.
- 5** Plug in the power cord of the DVD/VCR. You are ready to turn on the DVD/VCR. Go to page 16 before turning it on.

Remember...

There are two ways to connect your Cable Box/Satellite Receiver to the DVD/VCR. With the connection on this page:

- Select TV channels at the Cable Box/Satellite Receiver, not the DVD/VCR. To record or view TV channels, follow these steps:
 - 1) Press VCR to put the DVD/VCR in VCR mode. VCR light will appear on the front of the DVD/VCR.
 - 2) Press SKIP ►/CH ▲ or SKIP ◀/CH ▼ to set the DVD/VCR to the Cable Box/Satellite Receiver output channel (03 or 04).
 - 3) Set the TV to the DVD/VCR's output channel (03 or 04). The DVD/VCR's output channel is channel 3 when the DVD/VCR is new. To change it from 3 to 4, press and hold (VCR) PLAY ► on the DVD/VCR for 3-5 seconds during tape playback. For more details, see step 4 on page 9.
 - 4) Select the channel you want to view/record at the Cable Box/Satellite Receiver.
- You may not view a channel other than the one you are recording.
- You can only program a timer recording for one channel at a time. Set your Cable Box/Satellite Receiver to the channel you want to record. When you enter the channel you want to record in a timer recording, select channel 03 or 04 (the Cable Box/Satellite Receiver output channel). (This is step 8 on page 28.) Leave the Cable Box/Satellite Receiver on for a timer recording.

Helpful Hint

- If your Cable Box or Satellite Receiver has Audio and Video Out jacks, use audio and video cables to connect them to the VCR AUDIO IN and VIDEO IN jacks on the rear of the DVD/VCR. You will not need the RF coaxial cable connection between the Cable Box/Satellite Receiver and the DVD/VCR as described at step 2.

Hookups (cont'd) 11

DVD/VCR to Cable Box or Satellite Receiver and TV

Using only basic RF coaxial cables

This connection will let you use the features of both the VCR and the DVD Player.

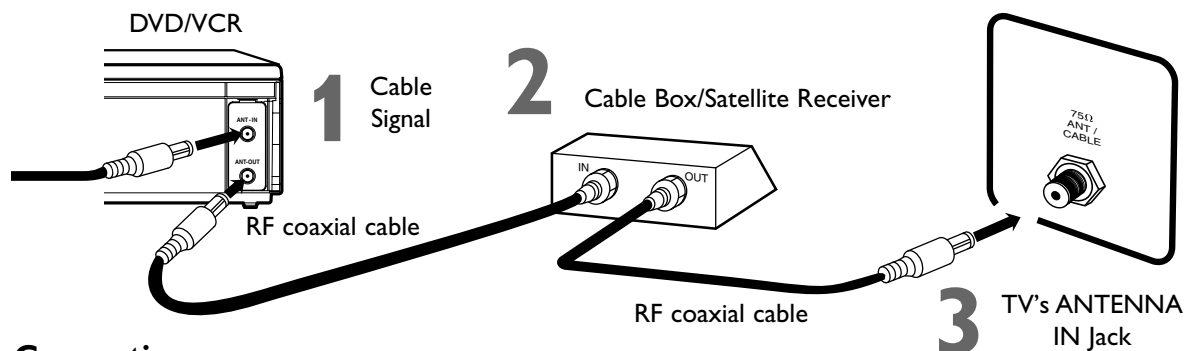

Connections

- 1** Connect a Cable TV or Satellite signal to the DVD/VCR's **ANT-IN (Antenna In)** jack.
- 2** Use an RF coaxial cable (as the one supplied) to connect the **ANT-OUT (Antenna Out)** jack on the DVD/VCR to the **IN** jack on the Cable Box/Satellite Receiver.
- 3** Use a second RF coaxial cable to connect the **OUT** jack on the Cable Box/Satellite Receiver to the **ANTENNA IN** jack on the TV.
- 4** Plug in the power cord of your TV. Turn on the TV and set it to channel 3 or 4.
- 5** Plug in the power cord of the DVD/VCR. You are ready to turn on the DVD/VCR. Go to page 16 before turning it on.

Remember...

There are two ways to connect your Cable Box/Satellite Receiver to the DVD/VCR. With the connection on this page:

- You may watch one channel while recording another. Follow these steps:
 - Put the Cable Box/Satellite Receiver on the same channel as the DVD/VCR's output channel (03 or 04). The DVD/VCR's output channel is channel 3 when the DVD/VCR is new. To alternate it between 3 and 4, press and hold (VCR) **PLAY** ► on the front of the DVD/VCR for 3-5 seconds during tape playback. For details, see step 4 on page 9. Set the TV to the Cable Box/Satellite Receiver output channel (03 or 04).
 - Press **VCR** to put the DVD/VCR in VCR mode. VCR light will appear on the front of the DVD/VCR.
 - Press **VCR/TV** on the remote to choose VCR position.
 - Press **SKIP** ►/CH ▲ or **SKIP** ◀/CH ▼ to select the channel you want to record at the DVD/VCR. Press **RECORD** ● to start the recording.
 - Press **VCR/TV** on the remote once to put the DVD/VCR in TV position.
 - Select the channel you want to watch at the Cable Box/Satellite Receiver.
- When you play a tape or Disc, make sure the Cable Box/Satellite Receiver is set to the DVD/VCR's output channel (03 or 04). Set the TV to the Cable Box/Satellite Receiver output channel (03 or 04).

12 Hookups (cont'd)

DVD/VCR to a TV that has Audio/Video, Component Video, or S-Video In jacks

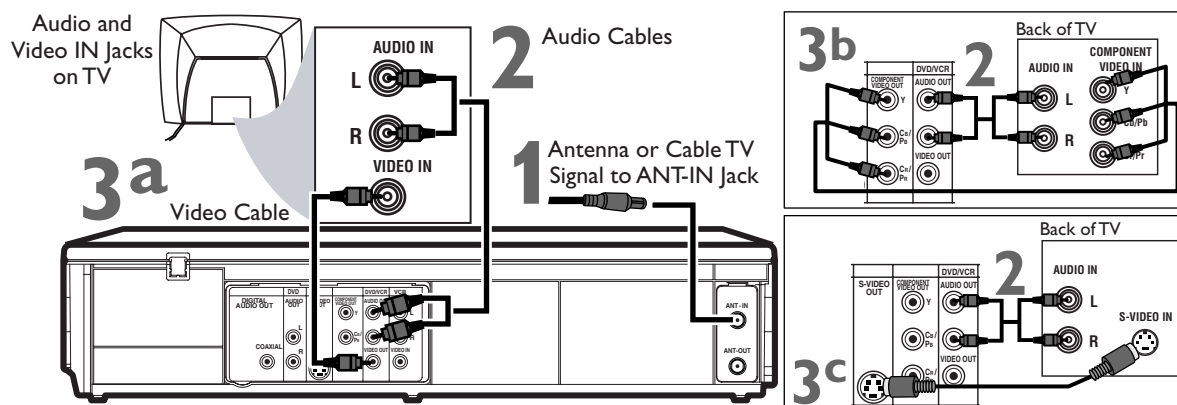

- 1** Connect the antenna or Cable TV signal to the **ANT-IN (Antenna In)** jack of your DVD/VCR.
- 2** Connect the red and white audio cables (supplied) to the red and white **DVD/VCR AUDIO OUT** jacks on the DVD/VCR and to the red and white **AUDIO IN** jacks on the TV. Match the cable colors to the jack colors. If the TV has a single **AUDIO IN** jack, use the white audio cable to connect the DVD/VCR's white **DVD/VCR AUDIO OUT** (left) jack to the TV's **AUDIO IN** jack. You will not use the red cable. Or, purchase a "splitter" audio cable to go from the left/right **AUDIO OUT** jacks of the DVD/VCR to the TV's single **AUDIO IN** jack.
- 3a** Connect the yellow video cable (supplied) to the **DVD/VCR VIDEO OUT** jack on the DVD/VCR and to the **VIDEO IN** jack on the TV. The **VIDEO IN** jack on the TV is usually yellow and may be labelled **CVBS**, **Composite**, or **Baseband** video.
- 3b** Connect component video cable (not supplied) to the **COMPONENT VIDEO OUT** jacks on the DVD/VCR and to the **COMPONENT VIDEO IN** jacks on the TV. The Component Video In jacks on the TV are usually red, blue, and green.
- 3c** Connect an **S-Video** cable (not supplied) to the **S-VIDEO OUT** jack on the DVD/VCR and to the **S-VIDEO IN** jack on the TV.

The connections 3b and 3c only supply video (picture) for the DVD Player of the DVD/VCR. Therefore, in order to use the VCR features or view TV channels at the DVD/VCR, you still need to either connect the RF coaxial cable between the **ANT-OUT** jack of the DVD/VCR and the TV's **Antenna In** jack, or connect the yellow video cable. To connect the supplied RF coaxial cable, see step 2 on page 9. To connect the supplied yellow video cable, see step 3a.

- 4** Connect the power cords of the TV and the DVD/VCR to a power outlet. Turn on the TV and set it to the correct Video In channel. If you are using the RF coaxial cable for VCR playback, choose channel 3 or 4 at the TV. If you are using the yellow video cable for VCR playback, choose the Video In channel at your TV. To find the correct Video In channel, go to your lowest TV channel and change channels downward until you see VCR playback on the TV screen. To help you find the right Video In channel, turn on the DVD/VCR. Press DVD to put the DVD/VCR in DVD mode. With no Disc in the Player, a large DVD Video logo will appear on the TV screen when you get the TV on the correct Video In channel.
- 5** You are ready to turn on the DVD/VCR. Go to page 16 to complete the first-time setup.

Hookups (cont'd) 13

DVD/VCR to a TV and a Stereo

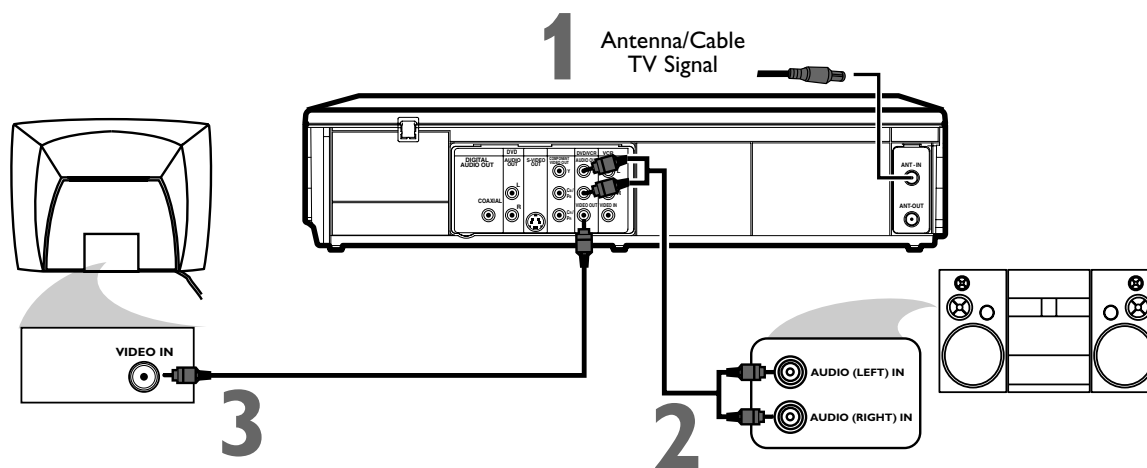

- 1** Connect the antenna or Cable TV signal to the **ANT-IN (Antenna In)** jack of your DVD/VCR.
- 2** Connect the supplied red and white audio cables to the red and white **DVD/VCR AUDIO OUT** jacks on the DVD/VCR and to the red and white **AUDIO IN** jacks on the Stereo. Match the cable colors to the jack colors.
- 3** Connect the supplied yellow video cable to the **DVD/VCR VIDEO OUT** jack on the DVD/VCR and to the **VIDEO IN** jack on the TV.
To use Component Video cable or S-Video cable instead for the DVD Player, see page 12. You will still need the yellow video cable or RF coaxial cable for VCR features.
- 4** Connect the power cords of the DVD/VCR, TV, and Stereo to a power outlet. Turn on the TV and set it to the **Video In** channel. Or, simply go to your TV's lowest channel (02 or 03) and continue changing channels downward at the TV until you see VCR or DVD playback on the TV screen.
To help you find the right Video In channel at the TV, turn on the DVD/VCR. Press DVD to put the DVD/VCR in DVD mode. With no Disc in the Player, a large DVD Video logo will appear on the TV screen when you get the TV on the correct Video In channel.
Turn on the Stereo and set it to the correct Auxiliary or Source mode. Check your Stereo manual for details.
- 5** You are ready to turn on the DVD/VCR. Go to page 16 before turning on the DVD/VCR.

14 Hookups (cont'd)

DVD/VCR to a TV and to a Stereo that is Dolby Digital-compatible Using Digital Audio connections

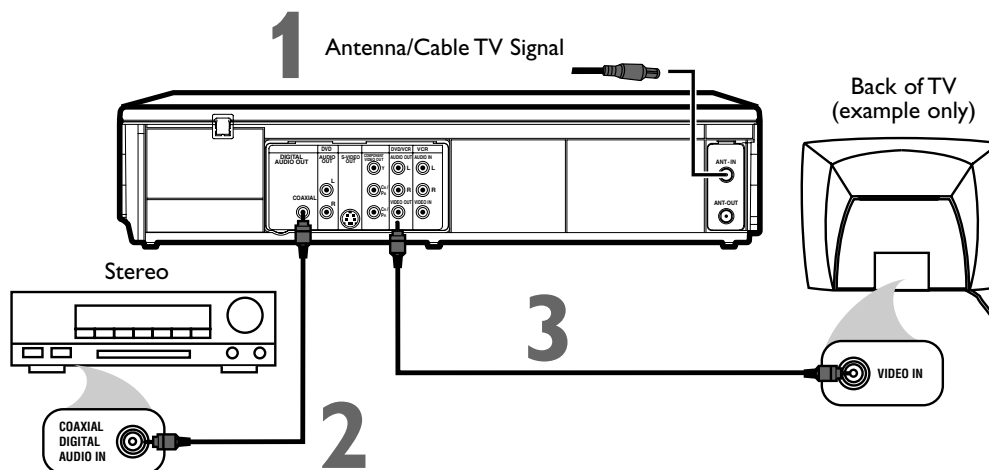

1 Connect the antenna or Cable TV signal to the **ANT-IN (Antenna In)** jack of your DVD/VCR.

2 Connect a coaxial digital audio cable (not supplied) to the DVD/VCR's **COAXIAL DIGITAL AUDIO OUT** jack and to the **COAXIAL DIGITAL AUDIO IN** jack on the Stereo.

This digital audio connection only provides sound for the DVD Player of the DVD/VCR. So, in order to use the VCR features or hear TV channels at the DVD/VCR, you still need to either connect the RF coaxial cable between the ANT-OUT jack of the DVD/VCR and the TV's Antenna In jack, or connect the supplied red/white audio cables. To connect the supplied RF coaxial cable, see step 2 on page 9. To connect the red/white audio cables, see step 2 on page 12.

3 Connect the supplied yellow video cable to the yellow **DVD/VCR VIDEO OUT** jack on the DVD/VCR and to the **VIDEO IN** jack on the TV. To use component video cable or S-Video cable instead for the DVD Player, see page 12. You will still need the yellow video cable or RF coaxial cable for VCR features.

4 Plug in the power cords of the Stereo, TV, and DVD/VCR. Turn on the Stereo and select its **Auxiliary IN** channel. Turn on the TV and set it to the correct **Video In** channel. Go to your TV's lowest channel (01 or 02) and change channels downward until you see DVD or VCR material on the TV screen. To help you find the right Video In channel on the TV, turn on the DVD/VCR. Press DVD to put the DVD/VCR in DVD mode. With no Disc in the Player, a large DVD Video logo will appear on the TV screen when you get the TV on the correct Video In channel.

Make sure **PROGRESSIVE** is OFF and **P.SCAN** does not appear on the DVD/VCR's display panel. Disable Progressive Scan either in the **DISPLAY** menu or by pressing and holding **PLAY ► (DVD)** on the front of the DVD/VCR for more than 5 seconds. *Details are on pages 8 and 53-54.*

5 You are ready to turn on the DVD/VCR. Go to page 16 before turning on the DVD/VCR.

Remember...

Some DVDs are recorded in Dolby Digital 5.1 channel Surround Sound. Select Dolby Digital 5.1 channel Surround Sound in the DVD Disc menu. If Dolby Digital Surround Sound is not recorded on the Disc, you will not have surround sound available.

If you connect the DVD/VCR to a Dolby Digital Stereo, set **DOLBY DIGITAL** to **BITSTREAM** in the DVD Player's Setup menu. *Details are on page 55.* If the DVD/VCR is not connected to a Dolby Digital-compatible Stereo, set **DOLBY DIGITAL** to **PCM**.

Incorrect settings may cause noise distortion and damage the speakers.



Remote Control Setup 15

Putting Batteries in the Remote Control

- 1** Remove the battery compartment lid on the bottom of the remote control by pressing the tab, then lifting the lid.
- 2** Place two AA batteries inside the battery compartment with their + and – ends aligned as indicated.
- 3** Replace the battery compartment lid.

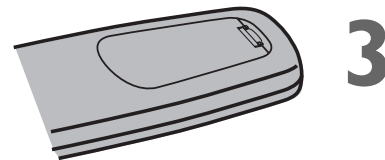
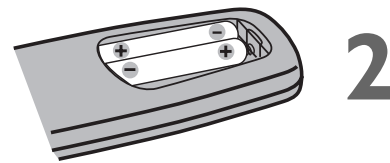
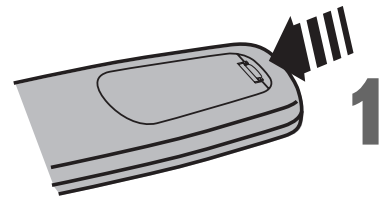

Using the Remote Control

- Point the remote control at the DVD/VCR's remote sensor (see page 20) when using the remote to operate the DVD/VCR. Do not point the remote at the TV.
- Do not put objects between the remote and the DVD/VCR.

Recycling Guidelines/Battery Safety

- Your new product and its packaging contain materials that can be recycled and reused. Specialized companies can recycle your product to increase the amount that needs to be properly disposed. Your product uses batteries that should not be thrown away when depleted but should be disposed of as small chemical waste. Please find out about the local regulations on disposal of your old product, batteries, and packaging whenever you replace existing equipment.
- Battery Usage CAUTION - To prevent battery leakage that may result in bodily injury, property damage, or damage to the unit:
 - Install ALL batteries correctly, with the + and – markings on the battery aligned as indicated on the unit.
 - Do not mix batteries, for example, old with new or carbon with alkaline.
 - Remove batteries when the unit will not be used for a long time.

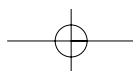
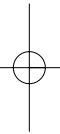
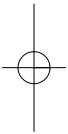

16 First-time DVD/VCR Setup

Before turning on your DVD/VCR, make sure batteries are in the remote control and the DVD/VCR and TV are connected correctly. You cannot program channels if you are using a Cable Box or a Satellite Receiver.

These menus may not appear if you have already turned on the DVD/VCR.

- 1 Turn on the TV. Set it to channel 3 or 4 or its AUDIO/VIDEO IN channel**, depending on how you connected the DVD/VCR to a TV.
- 2 Press VCR, then press STANDBY-ON** . VCR light will appear on the front of the DVD/VCR. The display shown below will appear. These menus may not appear if you have already turned on the DVD/VCR. You may have turned on the DVD/VCR before to find the Audio/Video In channel of the TV, for example. If so, follow the steps on page 21 to set up channels and page 23 to select a language for the VCR menus.

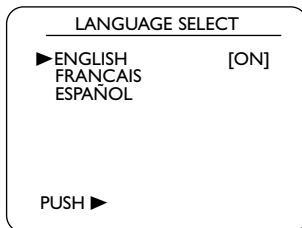

- 3 Press ▲ or ▼ to select ENGLISH, FRANCAIS (French), or ESPAÑOL (Spanish) as the language for VCR on-screen displays and menus. Then, press ►.** The display shown below will appear.

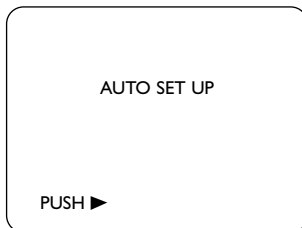

- 4 Press ► to begin channel programming.** AUTO SETUP will flash on the TV screen during the channel search. The DVD/VCR will memorize all available channels. When channel programming is complete, the lowest available channel will appear on the TV. These channels will be available when you want to watch TV while in VCR mode. To put the DVD/VCR in VCR mode, press VCR so VCR light appears. Use SKIP ►/CH ▲ or SKIP ◀/CH ▼ to select memorized channels. To select non-memorized channels, use the Number buttons.

- 1 Turn on the TV.**

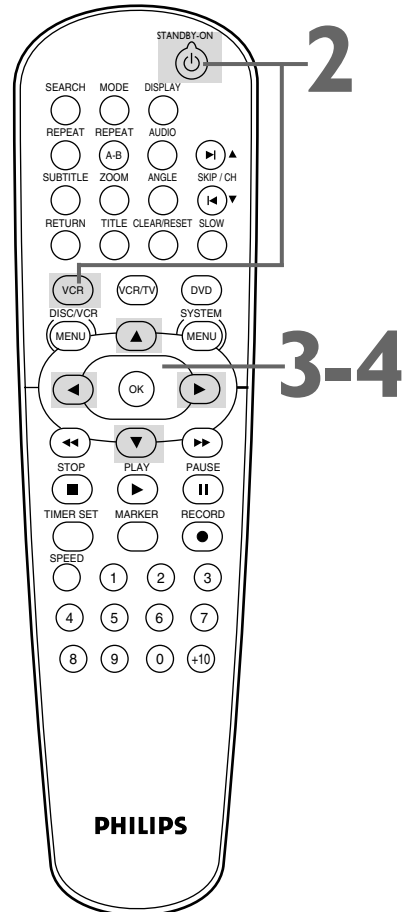

Helpful Hints

- To skip this feature and play a tape immediately, insert a tape with its record tab removed.
- If you like to skip step 4, press DISC/VCR MENU as soon as the search begins. The DVD/VCR will stop the channel search, and the VCR menus and displays will be in English.
- If you try to program channels when there is no antenna or Cable TV signal connected to the ANT-IN jack of the DVD/VCR, programming will stop. AUTO SET UP will stop flashing. Connect an antenna or Cable TV signal to the DVD/VCR's ANT-IN jack and press ► again.
- Repeat this process if the power fails.

Video Cassette Playback 17

Read and follow the steps below to play a tape.

- 1** Turn on the TV. Set it to channel 3 or 4 or its **AUDIO/VIDEO IN** channel. This depends on how you connected the DVD/VCR to a TV. *Details are on pages 8-14.*
- 2** With the DVD/VCR power off, insert a tape in the cassette compartment of the DVD/VCR. VCR light will appear on the front of the DVD/VCR. If the tape's record tab has been removed, playback will start automatically. If the DVD/VCR power is already on, press VCR to put the DVD/VCR in VCR mode if necessary. VCR light will appear on the front of the DVD/VCR.
- 3** If playback does not start automatically, press VCR, then press **PLAY** ►.
- 4** Press **STOP** ■ to stop playback.
- 5** Press ◀◀ to rewind the tape.
- 6** After the tape stops, press **STOP/EJECT** ■▲ on the front of the DVD/VCR to remove the tape.

- 1** Turn on the TV.
- 2** Insert a tape in the DVD/VCR.

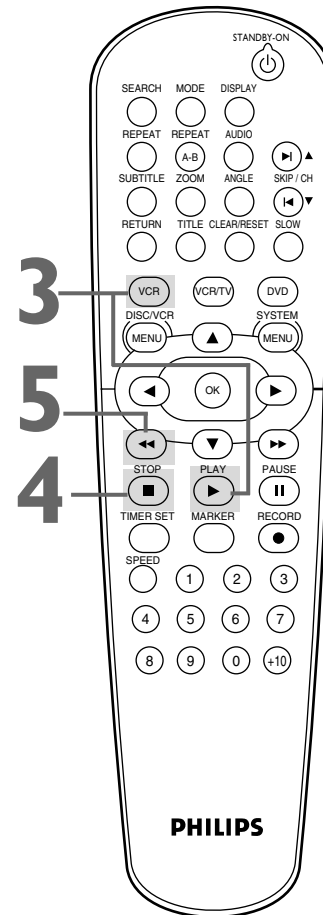

- 6** Press **STOP/EJECT** ■▲ on the DVD/VCR.







Helpful Hints

- Other tape playback features are on pages 31-34.
- If **AUTO REPEAT** is ON, playback will begin when you insert a tape, even when the record tab is intact. *Details are on page 31.*
- You must connect the DVD/VCR to a TV using the RF coaxial cable or the audio/video cables in order to use the VCR features. These hookups are explained on pages 9 and 12.

18 Disc Playback

Before you begin, turn on the TV, Stereo, and other equipment connected to the DVD/VCR. Make sure the TV and the Stereo (if applicable) are set to the correct channel.

Details are on pages 8-14.



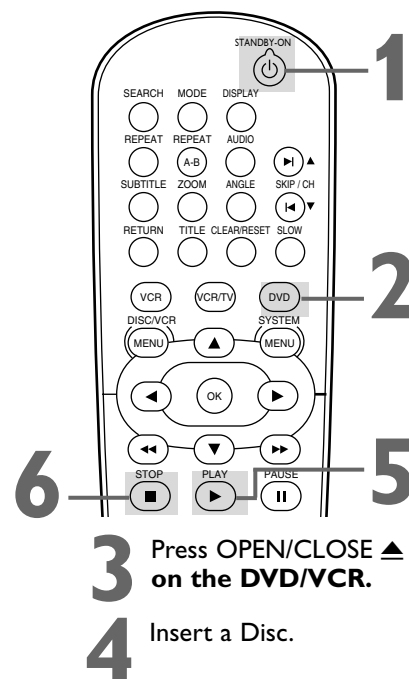

- 1** Press **STANDBY-ON**  to turn on the DVD/VCR.
- 2** Press **DVD** so DVD light appears on the front of the DVD/VCR.
- 3** Press **OPEN/CLOSE**  on the DVD/VCR to open the Disc tray.
- 4** Place a Disc into the tray. If the DVD is recorded on only one side, place the Disc in the tray with the label facing up and the shiny side facing down. Some DVDs are recorded on both sides. Make sure the label of the side you want to play is facing up.
- 5** Press **PLAY**  to close the tray. The tray will close and playback will begin. If playback does not start automatically, press **PLAY**  again.
If a DVD menu appears instead, see page 35.
To play MP3, Windows Media™ Audio or JPEG Files, see page 46-47.
You also can close the tray by pressing **OPEN/CLOSE** .
- 6** Press **STOP**  to stop playback.



3 Press **OPEN/CLOSE**  on the DVD/VCR.

4 Insert a Disc.

Helpful Hints

- An "X" may appear at the top right corner of the TV screen when you try a feature. Either the feature is not available on the Disc, or the DVD/VCR cannot access the feature at this time. This does not indicate a problem with the DVD/VCR.
- If a Disc is dirty or scratched, the picture may appear distorted or playback may stop. In such cases, remove the Disc and turn off the DVD/VCR. Disconnect the power cord, then reconnect it. Clean the Disc, then turn on the DVD/VCR again and reinsert the Disc for playback.
- If a Disc has multiple layers, the picture may freeze occasionally. This happens when the first layer switches to the second layer. This is not a malfunction.
- When the DVD or CD light appears on the display panel, the Disc is loaded and ready for playback.
- When you press **OPEN/CLOSE**  or **PLAY** (DVD) on the front of the DVD/VCR when the power is off, the DVD/VCR will turn on in DVD mode. Otherwise, the DVD/VCR will turn on in the mode in which it was turned off.
- If you use **PLAY**  to close the Disc tray, playback starts automatically. If you use **OPEN/CLOSE**  to close the Disc tray, you have to press **PLAY**  to start playback.

Remember, this DVD/VCR will play only certain Discs. See page 7 for details.

Display Panel 19

VCR light

This light appears when the DVD/VCR is in VCR mode. You can only watch videotapes or access VCR features and TV channels when VCR light is on. To make VCR light come on, press VCR on the remote control or SOURCE on the front of the DVD/VCR.

DVD light

This light appears when the DVD/VCR is in DVD mode. You can only watch DVDs when DVD light is on. To make DVD light come on, press SOURCE on the front of the DVD/VCR or DVD on the remote.

Cassette Compartment

Insert a video cassette here.

Display

Messages about current Disc operations appear here. See Display Messages below.

Disc tray

Insert a Disc here.

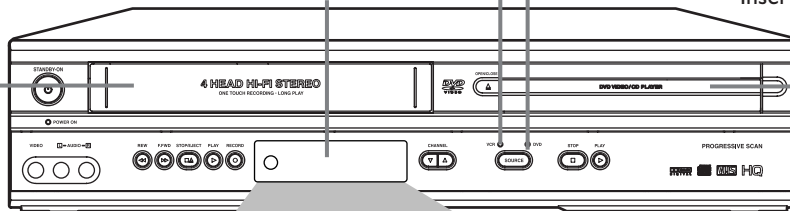

DVD Display Panel

Appears when a repeat function is active

Appears when A-B Repeat is on

Appears when ALL Repeat is on

Appears when Disc playback is paused

Appears during slow motion playback (DVD, Video CD)

Appears during Disc playback

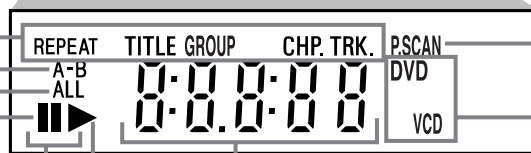

Displays the elapsed playing time of the current Title or Track; briefly displays a Track, Chapter, or Title number when playback begins.

Appears when Progressive Scan is active

Displays the current Disc type

- DVD: DVD
- CD: Audio CD, MP3, Windows Media™ Audio, JPEG
- VCD: Video CD

VCR Display Panel

Indicates a tape is in the DVD/VCR

Appears if Repeat Playback is active

Appears if tape playback is paused or during slow motion tape playback

Appears during tape playback

Indicates VCR position

Appears when a timer recording or an OTR has been set



Indicates the elapsed playing time of a tape; also displays a channel number, tape speed, remaining time for an OTR, or the current time

Appears during recording; flashes when recording is paused

Indicates current time is P.M. There is no A.M. indication.

Display Messages

- - - -	Appears after the disc tray closes if the tray is empty, if there is an error reading the disc, or if an unacceptable disc is installed.	CLOSE	Tray is closing.
OPEN	Tray is opening or is open.	Load	Disc is loading.
		Pbc	Appears when Playback Control is active (Video CD).

20 Front Panel, Rear Panel, and Remote Control

Front Panel

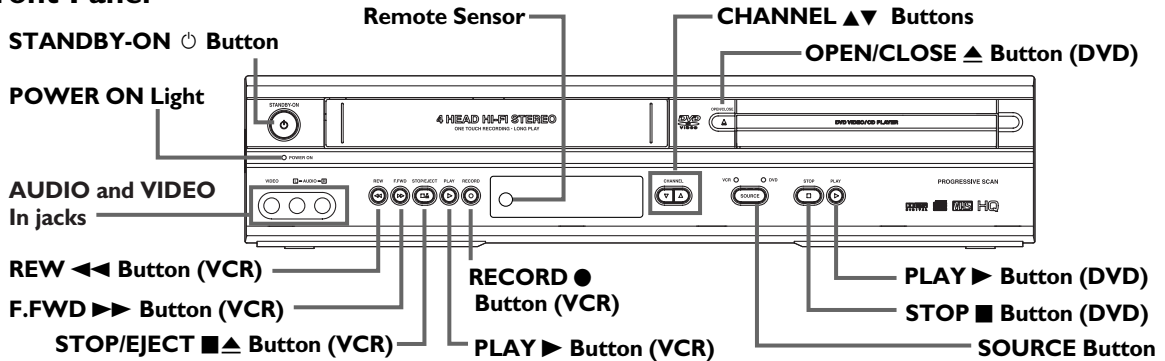

Rear Panel

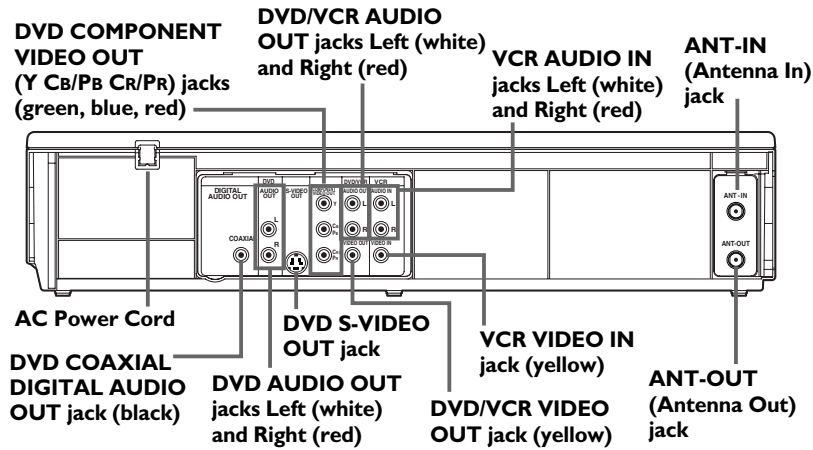

Helpful Hint

- The DVD S-VIDEO OUT, DVD COMPONENT VIDEO OUT, DVD AUDIO OUT and DVD COAXIAL DIGITAL AUDIO OUT jacks are only useful in DVD mode. To have sound and picture in VCR mode, you must connect either the RF coaxial cable or the audio/video cables supplied. *Details are on pages 9 and 12.*

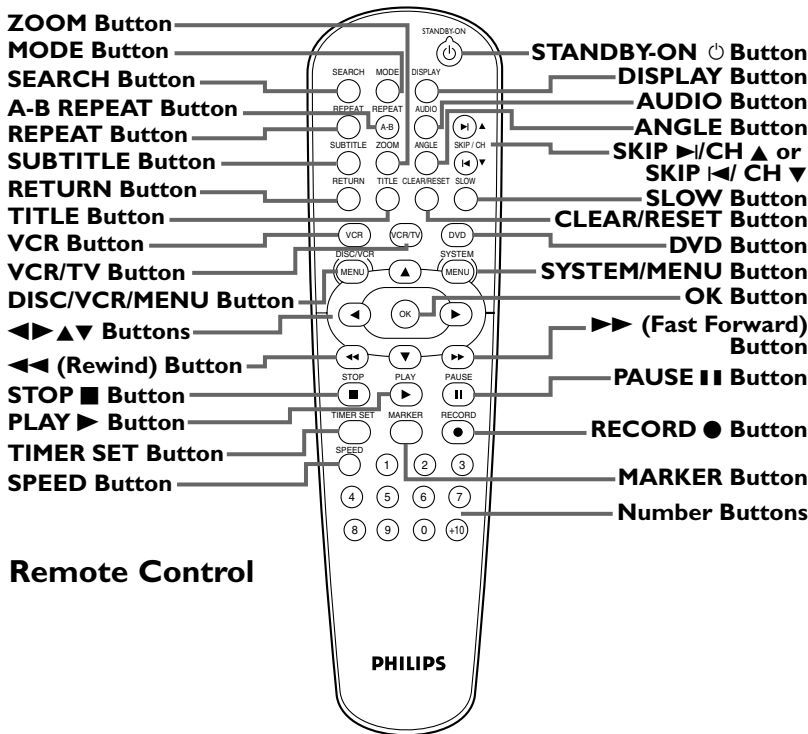

Remote Control

Helpful Hints

- For DVD Player features, press DVD before pressing other buttons. To put the DVD/VCR in DVD mode, press DVD or SOURCE so DVD light appears on the front of the DVD/VCR.
- For VCR features, press VCR before pressing any other buttons. To put the DVD/VCR in VCR mode, press VCR or SOURCE so VCR light appears on the front of the DVD/VCR.

Channel Setup 21

Although your DVD/VCR may automatically memorize the channels you receive when you turn it on for the first time, you can set up the channels again.

- 1 Press **VCR**, then press **DISC/VCR MENU** so MENU appears. If the clock has never been set, the **CLOCK SET** menu may appear when you press **DISC/VCR MENU**. If so, follow the instructions from step 3 on page 22.

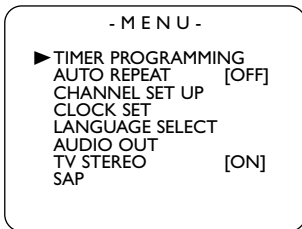

- 2 Press **▲** or **▼** to select **CHANNEL SET UP**. Then, press **▶**.
- 3 Press **▲** or **▼** to select **AUTO SET UP**. Then press **▶**.

- 4 **AUTO SET UP** will flash while the DVD/VCR sets up the available channels. When setup is complete, the lowest available channel will appear on the TV. Now when you press **SKIP ▶/CH ▲** or **SKIP ◀/CH ▼**, you will scan only through available channels. You still can select any channel using the Number buttons.

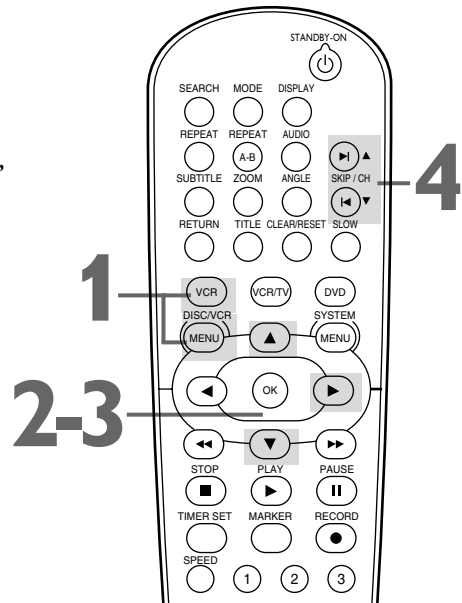

Adding/Deleting Channels

You may want to add or delete TV channels if your channel lineup changes or if you no longer watch some channels.

- 1 Follow the steps 1-2 above.
- 2 Press **▲** or **▼** to select **MANUAL SET UP**. Then press **▶**.
- 3 Press **▲** or **▼** until the channel number you want to add or delete appears on the screen.
- 4 Press **◀** or **▶** so **ADD** or **DELETE** flashes on the screen.

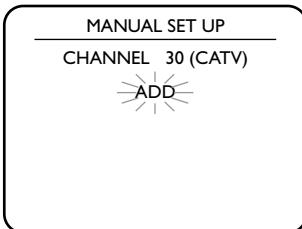

- 5 While your choice is flashing, press **CLEAR/RESET**. The channel you added or deleted will be the current channel. Added channels are available when you flip through channels using **SKIP ▶/CH ▲** and **SKIP ◀/CH ▼**. You still can select deleted channels with the Number buttons.

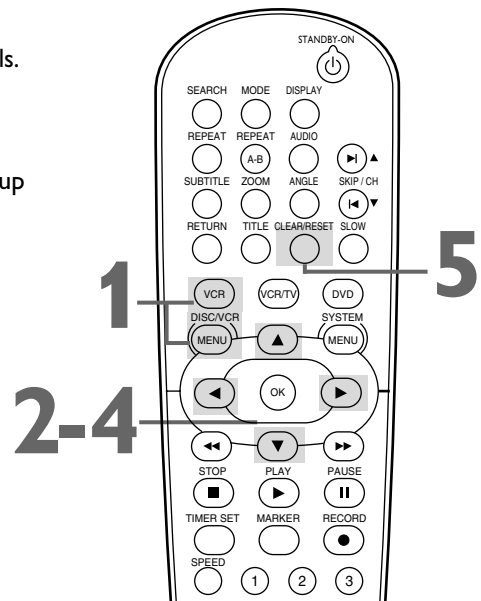

Helpful Hints

- You cannot program channels if you are using a Cable Box or Satellite Receiver.
- If you have an antenna, channels 2-69 will be possible. If you have Cable TV, channels 1-125 will be possible.
- To stop Channel Setup, press **DISC/VCR MENU** while **AUTO SET UP** is flashing.

22 Clock (VCR)

Follow these steps to set the VCR clock. Make sure:

1 Press **VCR**, then press **DISC/VCR MENU** so **MENU** appears. If the clock has never been set, the **CLOCK SET** menu may appear when you press **DISC/VCR MENU**. If so, follow the instructions from step 3 on this page.

2 Press **▲** or **▼** to select **CLOCK SET**. Then, press **▶**.

3 While the **MONTH** space is flashing, press **▲** or **▼** until the month appears. Then, press **▶**.

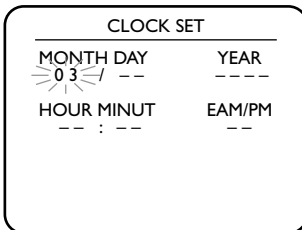

4 While the **DAY** space is flashing, press **▲** or **▼** until the day appears. Then, press **▶**.

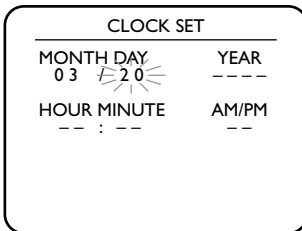

5 While the **YEAR** space is flashing, press **▲** or **▼** until the year appears. Then, press **▶**. The day of the week will appear automatically.

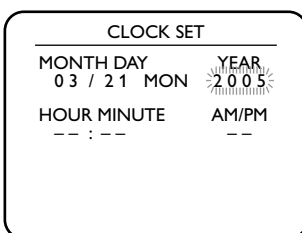

6 While the **HOUR** space is flashing, press **▲** or **▼** until the hour appears. Then, press **▶**.

7 While the **MINUTE** space is flashing, press **▲** or **▼** until the minute appears. Then, press **▶**.

8 While the **AM** or **PM** space is flashing, press **▲** or **▼** to point to **AM** or **PM**.

Your selection will flash on the screen in the **AM/PM** space.

9 Press **CLEAR/RESET** or **▶** to start the clock.

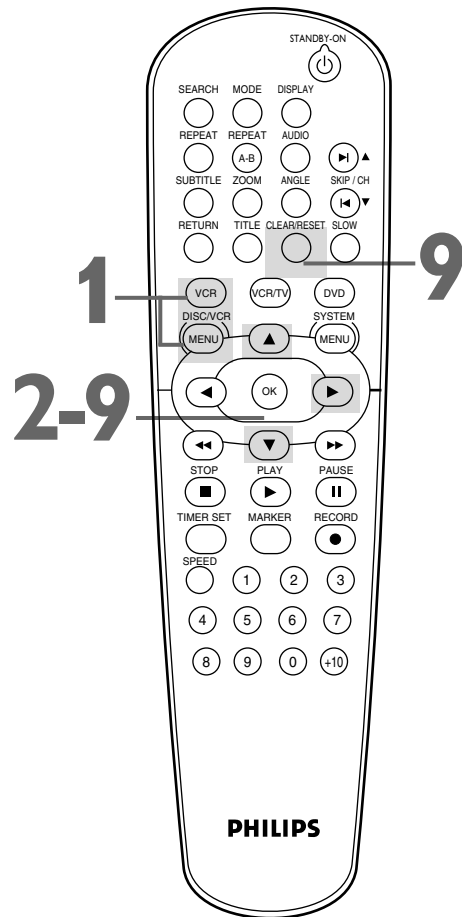

Helpful Hints

- If the clock has never been set, the **CLOCK SET** menu may appear when you press **DISC/VCR MENU**. If so, follow the instructions from step 3 above.
- Press **DISPLAY** until the time appears on the TV screen.
- Power failures of more than 30 seconds can erase the clock setting.
- To reset the clock, follow steps 1-2. Select the information you want to change using **◀** or **▶**. When the information is flashing, use **▲** or **▼** to enter the correct information. Press **CLEAR/RESET** to set the clock.

Language (VCR) 23

Follow the steps below to change the language of the VCR on-screen displays and menus.

- 1** Press **VCR**, then press **DISC/VCR MENU** so MENU appears.

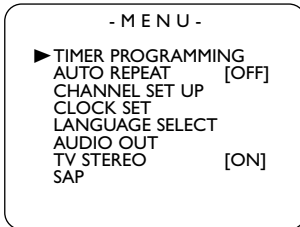

- 2** Press **▲** or **▼** to choose **LANGUAGE SELECT**, then press **▶**.

- 3** Press **▲** or **▼** to choose **ENGLISH, FRANCAIS (French), or ESPAÑOL (Spanish)**.

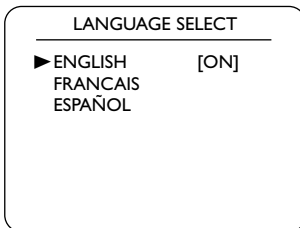

- 4** Press **CLEAR/RESET** to remove the menu.

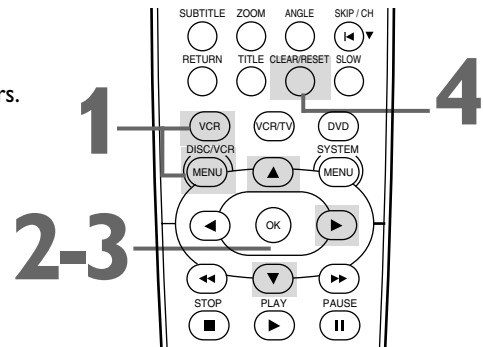

Helpful Hint

- If you select **FRANCAIS (French)**, or **ESPAÑOL (Spanish)** and need English:
 - 1) Press **DISC/VCR MENU** so **MENU** appears.
 - 2) Press **▼** to choose **SELECTION LANGUE** or **SELEC. IDIOMA**, then press **▶**.
 - 3) Press **▲** or **▼** to select **ENGLISH**.
 - 4) Press **CLEAR/RESET**.

VCR Status Displays

You may access status displays by pressing **DISPLAY**. The displays may include the current time, channel, and other information.

- 1** Press **DISPLAY**. The **COUNT** display will appear for 5 seconds. After 5 seconds, only the real-time tape counter will appear. This counter shows you the elapsed playing time of the tape (from the point at which the counter was set to 0). The counter also will appear on the display panel on the front of the DVD/VCR.

- 2** Press **DISPLAY** again. The **CLOCK** display will appear for 5 seconds. After 5 seconds, only the time will appear (the clock must be set). (If you are watching TV, the channel number and the availability of stereo or second audio will also appear.) The time also will appear on the display panel on the front of the DVD/VCR.

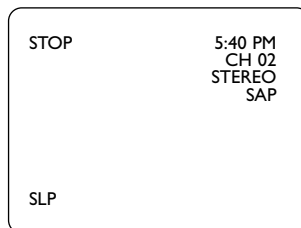
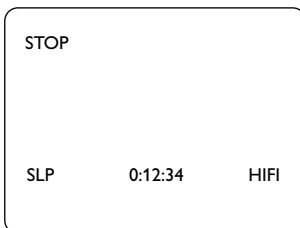

- 3** Press **DISPLAY** again to remove all the displays.

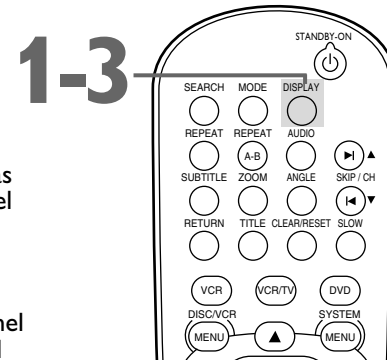

Helpful Hints

- If the channel you select has no broadcast, the screen will be solid blue.
- You cannot access a status display when viewing a still picture, during slow motion, or during forward and reverse searching.
- Channel numbers appear on the screen for a few seconds each time you change channels.

24 Videotape Recording

Read and follow the steps below to record a television program onto a videotape.

- Before you begin, make sure the DVD/VCR is in VCR mode. Press VCR so VCR light appears on the front of the DVD/VCR.

- 1 Turn on the TV and set it to channel 3 or 4 or the Video In channel.** If you connected the DVD/VCR to the TV using the supplied audio and video cables, select your TV's Video In channel. *Details are on page 12.*
If you connected the DVD/VCR to the TV using the supplied RF coaxial cable, choose channel 3 (or 4) at the TV. *Details are on pages 9-11.*
- 2 Insert a tape with its record tab intact into the cassette compartment of the DVD/VCR.** If tape playback begins, press STOP ■.
- 3 Press SPEED until the desired tape speed (SP or SLP) appears briefly on the screen.** *Details about tape speed are on page 60.*
- 4 Press SKIP ►/CH ▲ or SKIP ◀/CH ▼ or the Number buttons to select the TV channel to record.**
- 5 Press RECORD ● to start recording.** "REC" will appear on the DVD/VCR's display panel.
- 6 To pause the recording, press PAUSE || once.** "REC" will flash. **To resume recording, press RECORD ● or press PAUSE || again.** "REC" will reappear.
- 7 To stop recording, press STOP ■.**

Recording Prevention

Video cassettes have record tabs to ensure that recordings are not accidentally erased.

- 1 To prevent recording, break off the tab with a screwdriver.**
- 2 To allow recording, cover the hole with clear tape.**

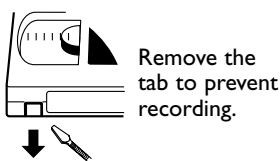

- 1** Turn on the TV.
- 2** Insert a tape in the DVD/VCR.

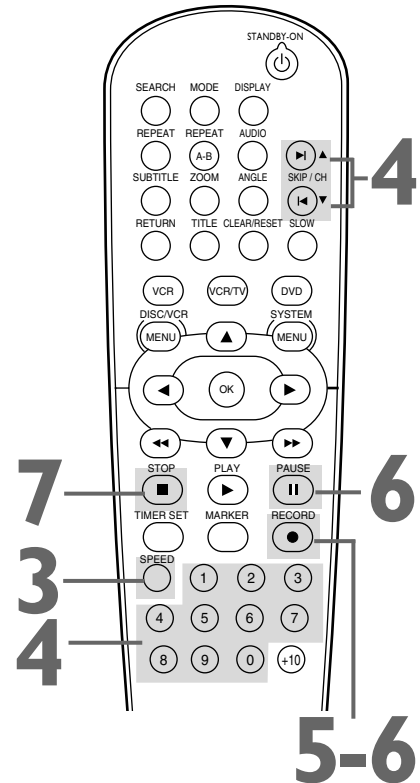

Helpful Hints

- Other recording options are on pages 25-30.
- The VCR will record in a preset volume.
- Pause will switch to Stop after 5 minutes to protect the VCR and the tape from damage. When a recording is paused, review the pause time remaining with the ■ marks on the screen. Each ■ mark equals 1 minute remaining. During the last minute of paused recording, the ■ mark will flash.
- If any menu is on the TV screen, RECORD ● on the remote does not function. Press CLEAR/RESET to remove the menu. Then, press RECORD ●. Or, use RECORD ● on the front of the DVD/VCR.

Recording One Channel/Watching Another 25

- 1** Press **VCR**, then press **RECORD** ● to record the current TV channel. Details are on page 24.
- 2** Press **VCR/TV** once to put the DVD/VCR in TV position. The VCR light will disappear from the DVD/VCR's display panel.
- 3** Use the TV remote control to select the channel you want to watch at the TV.
- 4** To return to the channel being recorded, use the TV remote control to return to channel 03 or 04 at the TV. Details are on page 9. Or, if you connected the DVD/VCR to the TV using audio and video cables, return to the TV's correct Video In channel. Details are on page 12.
- 5** Press **VCR/TV** on the DVD/VCR remote control to put the DVD/VCR in VCR position. (The VCR light will appear in the DVD/VCR's display panel again.) The channel being recorded will appear on the TV screen.
- 6** Press **STOP** ■ to stop the recording.

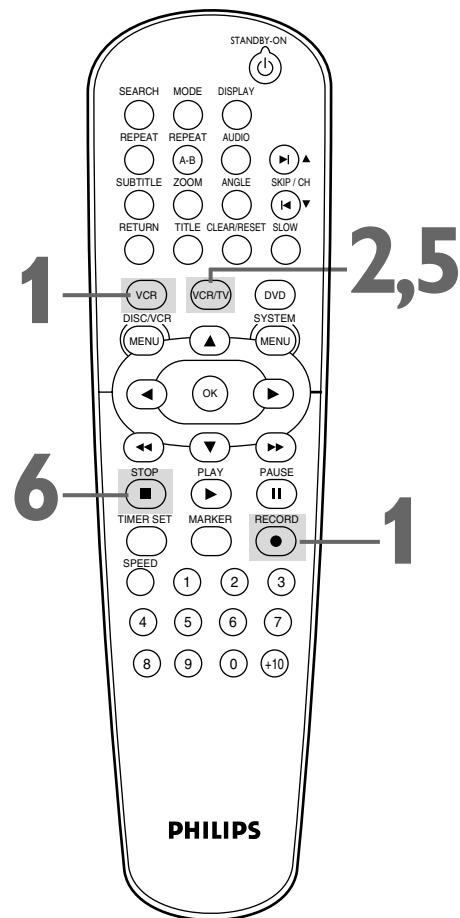

- 3** Select the channel you want to watch at the TV.
- 4** Reselect channel 03, 04, or Video In at the TV.

Helpful Hint

- If you use a Cable Box or Satellite Receiver, you may not be able to watch one channel while recording another. See pages 10-11 for details.

26 One-Touch Recording

One-Touch Recording (OTR) lets you set a timed recording 30 minutes to 8 hours long of the current TV channel. Before you begin:

- Place the DVD/VCR in VCR mode. Press VCR so VCR light appears on the front of the DVD/VCR.
- Select a recording speed (SP, SLP) with SPEED.
- Put a videotape in the cassette compartment. Make sure the tape's record tab is intact and the tape is long enough to record the program(s).

1 Press **VCR**, then press **SKIP ►/CH ▲** or **SKIP ◀/CH ▼** or the **Number** buttons to select the channel you want to record.

2 Press **RECORD ●** repeatedly until the desired recording length (30 minutes to 8 hours) appears on the TV screen. Recording will begin. "REC" and "☐" will appear on the DVD/VCR's display panel.

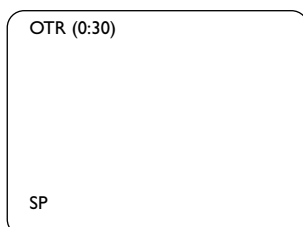

When an OTR ends

The DVD/VCR will turn off and "☐" on the DVD/VCR's display panel will flash indicating that the recording is complete, or it may switch to DVD mode automatically. Press **TIMER SET** to use the DVD/VCR as usual.

Stopping an OTR

To stop an OTR before recording is finished, press **STOP ■** on the remote control or **STOP/EJECT ■▲** (VCR) on the front of the DVD/VCR.

To cancel the OTR but continue recording, press **RECORD ●** repeatedly until REC appears in the upper left corner of the TV screen, and "☐" disappears.

When an OTR finishes, the DVD/VCR will either switch to DVD mode or turn itself off. If it changes to DVD mode, press **STANDBY-ON ⏻** to turn it off.

After an OTR, "☐" flashes because the VCR is still on standby for timer recordings. Press **TIMER SET** on the remote or **STOP/EJECT ■▲** (VCR) on the DVD/VCR to cancel timer standby and use the VCR normally again.

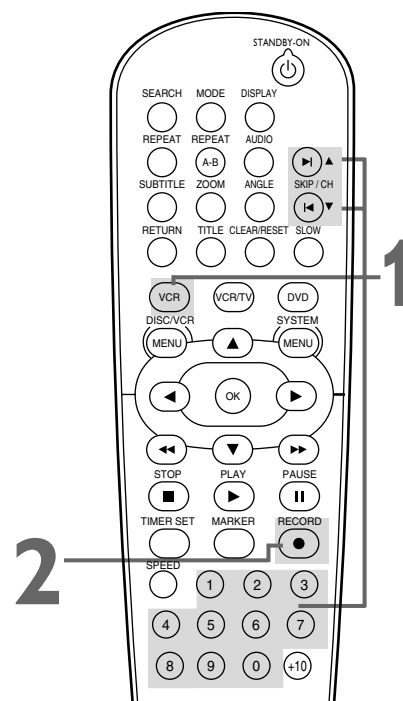

Helpful Hints

- The remaining recording time will appear on the display panel during an OTR. Press **DISPLAY** to see it on the TV screen.
- To change the recording length while an OTR is in progress, press **RECORD ●** repeatedly.
- You cannot pause an OTR.
- If the preset time for a timer recording comes up during an OTR, the OTR has priority. The timer recording will not take place.
- If the end of the tape is reached during an OTR, the VCR will stop recording, eject the tape, and switch to DVD mode or turn off.
- If one or more Timer recordings are on standby when one OTR ends, the DVD/VCR will turn off automatically and "☐" will appear on the DVD/VCR's display panel indicating that it is now ready for another timer recording.

Rerecording (Tape Duplication) 27

These instructions show you how to copy videotapes. The illustration uses two DVD/VCRs. Other VCRs or Camcorders may operate differently.

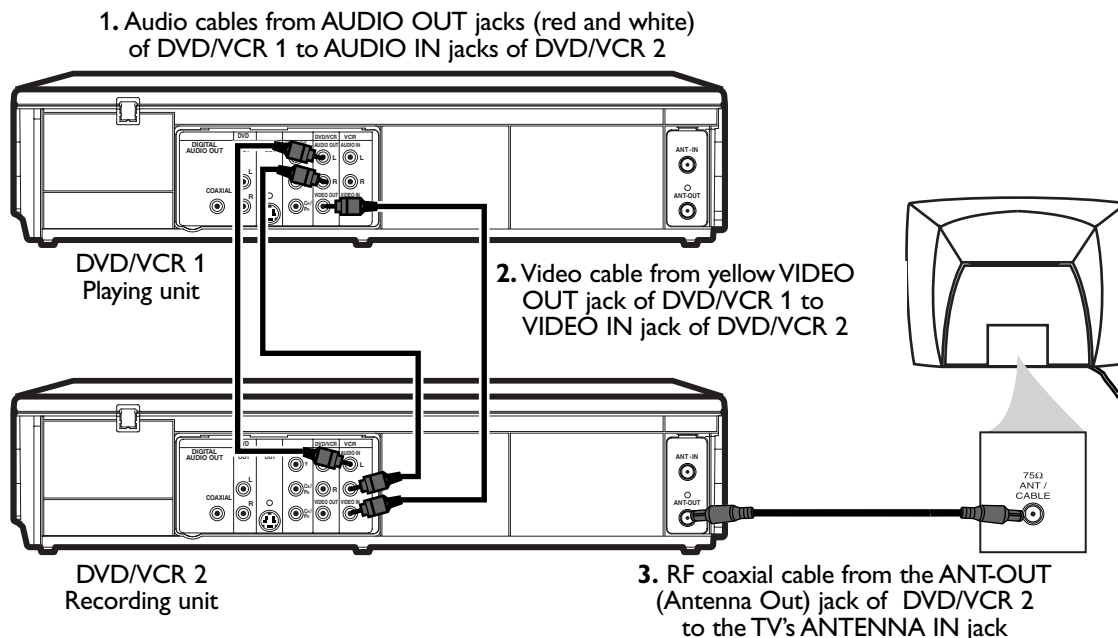

- 1** Make the connections shown above.
- 2** DVD/VCR 1 will play your tape. **Put a prerecorded tape into the cassette compartment of DVD/VCR 1.** Press VCR to put the unit in VCR mode if necessary.
- 3** DVD/VCR 2 will record your tape. **Insert a blank tape in the cassette compartment of DVD/VCR 2.** Press VCR to put the unit in VCR mode if necessary.
- 4** Turn on the TV and set it to channel **03** or **04** (the RF output channel of DVD/VCR 2). To determine the DVD/VCR's output channel, see step 4 on page 9.
- 5** Point the remote control at DVD/VCR 2. Press **Number buttons 0, 0, 1** or **0, 0, 2.** (See *Helpful Hints* to the right.)
- 6** Press **SPEED** to select **SP** or **SLP** at DVD/VCR 2.
- 7** Press **PLAY ► (VCR)** on the front of DVD/VCR 1 and **RECORD ●** on the front of DVD/VCR 2 at the same time.
To stop recording, press **STOP/EJECT ■▲ (VCR)** on DVD/VCR 1, then press **STOP/EJECT ■▲ (VCR)** on DVD/VCR 2.

Helpful Hints

- If you use the AUDIO and VIDEO IN jacks on the back of DVD/VCR 2, press Number buttons 0, 0, 1 at step 5. L1 will appear on the TV screen.
- If you use the AUDIO and VIDEO IN jacks on the front of DVD/VCR 2, press Number buttons 0, 0, 2 at step 5. L2 will appear on the TV screen.
- Unauthorized recording of copyrighted television programs, video tapes, or other materials may infringe on the rights of copyright owners and violate copyright laws.
- If a program has copyright protection, it may not be recorded clearly.

28 Timer Recording

Follow the steps below to program the VCR of the DVD/VCR to record TV programs while you're away from home. Before you begin:

- Set up the TV channels at the DVD/VCR. *Details are on page 21.*
- Set the clock. *Details are on page 22.*
- Put a tape in the cassette compartment of the DVD/VCR. Make sure the tape's record tab is intact and the tape is long enough to record the program(s).
- Press VCR so VCR light appears on the front of the DVD/VCR.

1 Press DISC/VCR MENU so MENU appears.

2 Press ▲ or ▼ to select TIMER PROGRAMMING. Then, press ►. Program numbers that do not have a timer recording stored will flash.

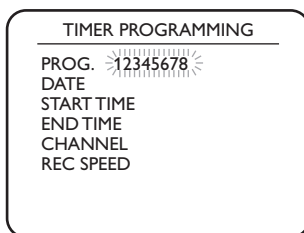

3 Press ▲ or ▼ to select an empty program. Then, press ►.

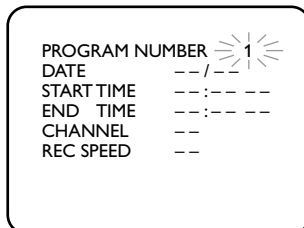

4 Press ▲ or ▼ to select ONCE, DAILY, or WEEKLY. Then, press ►.

- ONCE - The VCR will record a TV program on any day you choose, up to 12 months away.
- DAILY - The VCR will record a TV program at the same time on the same channel every day, Monday through Friday.
- WEEKLY - The VCR will record a TV program at the same time on the same channel every week, for example, every Monday.

5 To enter the recording date, press ▲ or ▼ until the month appears. Then, press ►.

Next, press ▲ or ▼ until the day appears. Then, press ►. The day of the week will appear. You cannot record more than one year in advance.

6 To enter the recording's start time, press ▲ or ▼ until the hour appears. Press ►. Press ▲ or ▼ until the minute appears. Press ►. Finally, press ▲ or ▼ to point to AM or PM. AM or PM will flash beside the start time. Press ►.

7 Repeat the procedure in step 6 to set the recording's end time.

8 Press ▲ or ▼ until the channel number appears. Then, press ►.

- If you are using a standard antenna/Cable TV hookup (as shown on page 9), select the channel of the TV program you want to record.

Instructions continue on page 29.

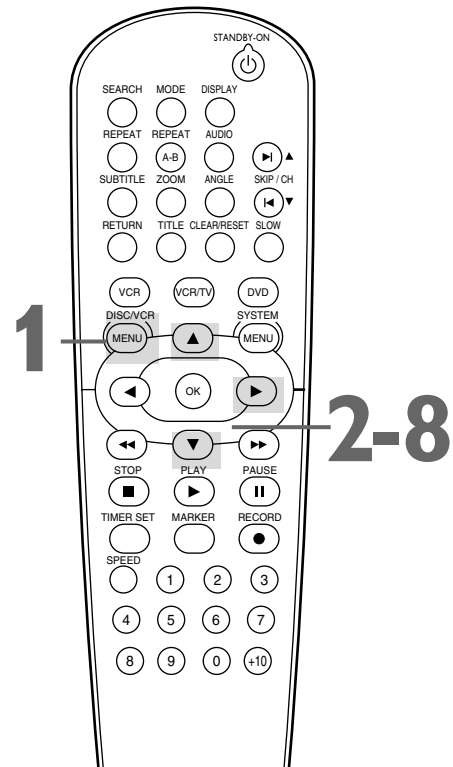

Helpful Hints

- You cannot access the **TIMER PROGRAMMING** menu at step 2 if the clock is not set. The **CLOCK SET** menu will appear. Follow the steps on page 22 to set the clock.
- Only programs that will air Monday-Friday can be recorded on a **DAILY** basis. If you select **DAILY** at step 4, then enter a Saturday or Sunday **DATE** at step 5, the correct program will not be recorded. The VCR will alter the recording date and record a different program than the one you intended.
- If you are recording from other equipment, set **CHANNEL** to L1 or L2 at step 8. If you connected the other equipment to the **AUDIO** and **VIDEO** In jacks on the front of the DVD/VCR, choose L2. If you connected the equipment to the **AUDIO IN** and **VIDEO IN** jacks on the back of the DVD/VCR, choose L1.
- Enter the information while the space is flashing.

Timer Recording (cont'd) 29

- If you are recording from other equipment, select L1 or L2. To determine L1 or L2, refer to the Helpful Hints.
- If you are using a Cable Box/Satellite Receiver, select the Cable Box/Satellite Receiver output channel (03 or 04). Then, at the Cable Box/Satellite Receiver, select the channel you want to record. Leave the Cable Box/Satellite Receiver on for the timer recording. Details are on page 10.

9 Press **▲** or **▼** to select a recording tape speed. The arrow will appear beside your choice. The selected speed will flash beside REC SPEED. Details about tape speed are on page 60.

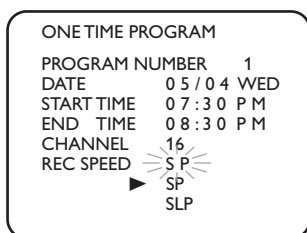

10 Press **CLEAR/RESET** to store the timer recording.

11 Press **TIMER SET**. The DVD/VCR will turn off and "⏻" will appear in the display panel. In some cases, the DVD/VCR will switch to DVD mode instead. You may use the DVD Player during a timer recording. If you want to use the VCR until time for the recording, don't press **TIMER SET** until a few minutes before the recording should start. Or, press **TIMER SET** only when you know you won't be using the VCR anymore (until after the recording). When "⏻" appears, you cannot put the DVD/VCR in VCR mode by pressing **VCR** or **SOURCE**. You must first press **TIMER SET** to cancel the timer recording temporarily. Then, you can use the VCR features again.

When a timer recording ends

The DVD/VCR will turn off and "⏻" on the DVD/VCR's display panel will flash indicating that the recording is complete. Or it may switch to DVD mode automatically. Press **TIMER SET** to use the DVD/VCR as usual.

Cancelling Timer Recordings

- 1** Press **VCR**, then press **DISC/VCR MENU** so **MENU** appears.
- 2** Press **▲** or **▼** to select **TIMER PROGRAMMING**, then press **▶**.
- 3** Press **▲** or **▼** to find the program you want to cancel.
- 4** While the program number is flashing, press **◀** to clear all the information for that program.
- 5** Press **CLEAR/RESET** to remove the menu.

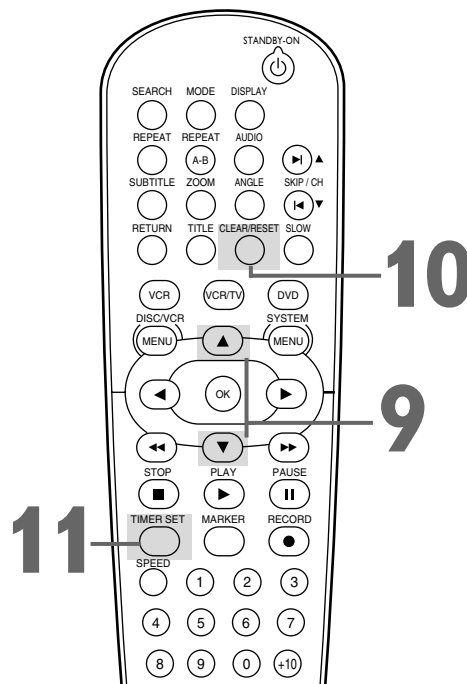

Helpful Hints

- To stop a started timer recording, press **STOP/EJECT** **■▲** (VCR) on the front of the DVD/VCR. (You cannot stop a started timer recording with **STOP** **■** on the remote.) **More Helpful Hints are on page 62.**
- To change incorrect information, press **◀** or **▶** to choose the item you want to change. Press **▲** or **▼** to adjust the information.
- While a timer recording is set and "⏻" is on, pressing **STOP/EJECT** **■▲** (VCR) will turn on the DVD/VCR and/or cancel the timer recording. The "⏻" will disappear. Press **STOP/EJECT** **■▲** (VCR) again to remove the tape. Insert a tape and press **TIMER SET** to reset the timer recording.
- If there is no tape in the VCR when you press **TIMER SET**, "⏻" will flash. Insert a tape.
- If one or more Timer recordings are on standby when one timer recording ends, the DVD/VCR will turn off automatically and "⏻" will appear on the DVD/VCR's display panel indicating that it is now ready for another timer recording.

30 DVD to Videotape Duplication

Follow the steps below to copy a DVD to a videotape. **This will be possible only if the DVD is not copy protected.**

Before you begin:

- Put a videotape in the cassette compartment. Make sure the tape's record tab is intact and the tape is long enough to record the DVD.
- Put the DVD you want to copy in the disc tray.
- Press VCR so VCR light appears on the front of the DVD/VCR.
- Turn on the TV and set it to channel 3, 4, or its Video Input.

- 1 Point the remote control at the DVD/VCR. **Press Number buttons 0, 0, 3.** DISC will appear on the TV screen.

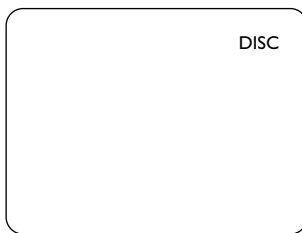

- 2 Press **SPEED** until the desired tape speed (**SP** or **SLP**) appears briefly on the screen. *Details about tape speed are on page 60.*

- 3 Press **RECORD** ● to start recording. "REC" will appear on the display panel.

- 4 Press **DVD**. Press **PLAY** ► to play the disc.

- 5 To pause the recording, press **VCR**, then press **PAUSE** || once. "REC" will flash. To resume recording, press **RECORD** ● or press **PAUSE** || again. "REC" will reappear.

- 6 To stop recording, press **VCR**, then press **STOP** ■.

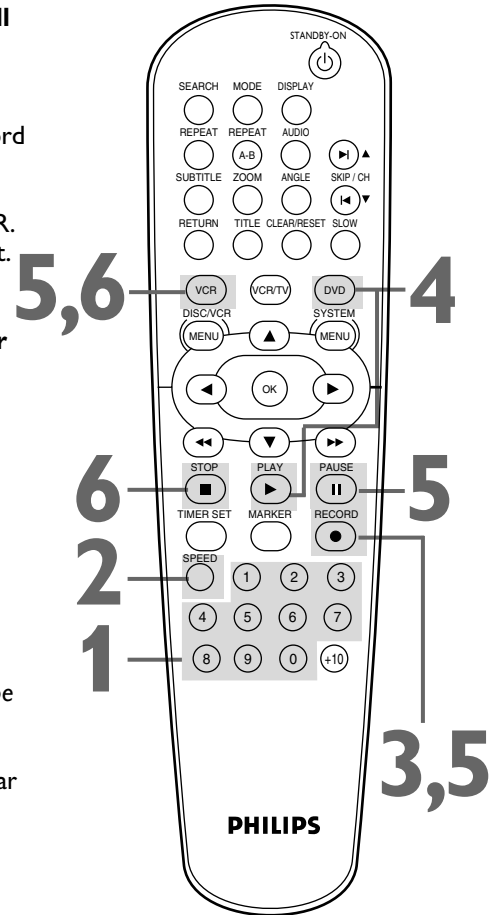

Helpful Hints

- A timer recording is not possible during DVD to videotape duplication.
- You cannot copy a DVD to a videotape if you are using Progressive Scan. *Details are on page 14.*

Repeat Playback 31

Follow the steps below to play a videotape repeatedly.

- 1** Press **VCR**, then press **DISC/VCR MENU** so MENU appears.
- 2** Press **▲** or **▼** to select **AUTO REPEAT**.
- 3** Press **▶** so **ON** appears next to **AUTO REPEAT**. Tape playback will begin immediately. **AUTO REPEAT ▶** will appear on the TV screen briefly. (If you are fast forwarding or rewinding the tape, press **CLEAR/RESET** to remove the menu, then press **PLAY ▶** to begin tape playback.) The tape will play to the end, rewind, then play again. (TV programming will appear on the screen while the tape is rewinding.)

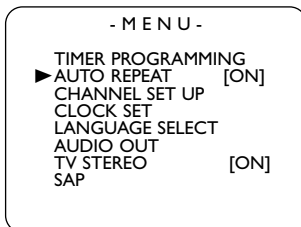
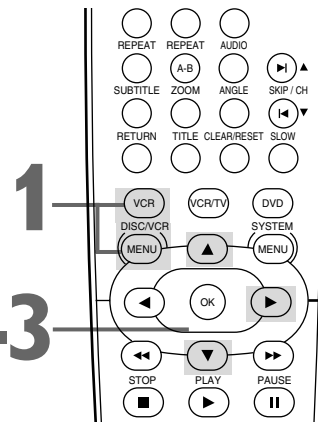

Helpful Hint

- To cancel Auto Repeat, follow steps 1-2. At step 3, press **▶** so **OFF** appears beside **AUTO REPEAT**. Press **CLEAR/RESET**.

Tape Counter

Follow the steps below to reset the VCR's real-time tape counter to 0 at a tape location you want to refer to later.

- 1** Press **VCR**, then play, fast forward, or rewind a tape to the location that you would like to refer to later. Press **STOP ■** to stop the tape.
- 2** Press **DISPLAY** to see the status display.
- 3** While the counter is on the screen, press **CLEAR/RESET** to reset the counter to 0.
- 4** When you later want to return to this point on the tape, press **DISPLAY** so you can see the counter (while tape playback is stopped). Press **◀◀** or **▶▶**. As the tape rewinds or forwards, watch the counter. When it reaches 0, press **PLAY ▶** to play the tape.

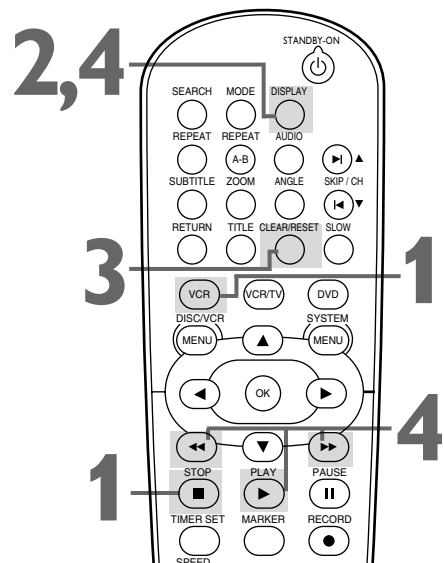
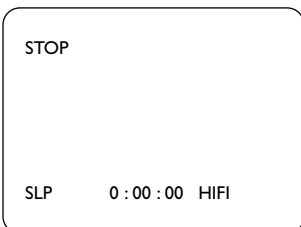
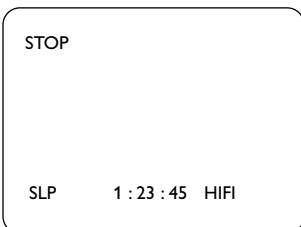

Helpful Hints

- You may only set the counter to 0 at one location at a time. Setting the counter to zero at a second location will erase the previous 0 setting.
- If you remove the tape, the counter will reset to 0 at the point at which you last stopped playback whenever you reinsert the tape.

32 Time Search, Index Search

Time Search

Follow the steps below to search forward or backward on a tape a specific length of time. There must be a tape in the cassette compartment.

- 1 Press **VCR**, then press **SEARCH** until the **TIME SEARCH** screen appears.

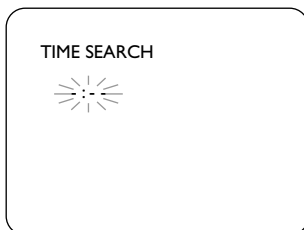

- 2 Within 30 seconds, press **▲** or **▼** until your desired length of time appears. Or, press and hold **▲** or **▼** until you reach the desired length of time. You can set a Time Search for up to 9 hours and 59 minutes (9:59).

- 3 Within 30 seconds, press **◀** (for a reverse search) or **▶** (for a forward search). The VCR begins rewinding or fast forwarding the tape. When the tape finishes rewinding or fast forwarding the time you specified, playback will begin. The time will count down beneath **TIME SEARCH** during the search. If the end of the tape is reached during the search, the search will stop and the tape may rewind. *Details are on page 33.*

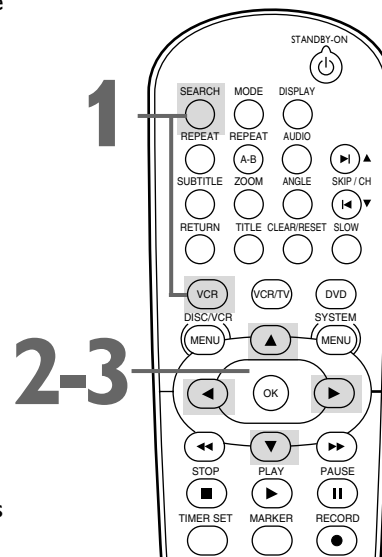

Index Search

An Index Mark is made automatically at the beginning of each recording. Essentially, an Index Mark is a "bookmark." Find the start of a recording by following these steps.

- 1 Press **VCR**, then press **SEARCH** until the **INDEX SEARCH** screen appears.

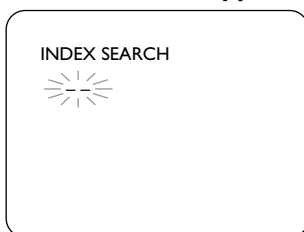

- 2 Within 30 seconds, press **▲** or **▼** until the number of programs you want to skip appears beneath **INDEX SEARCH**. Include the current program in your number.
- 3 Within 30 seconds, press **◀** (for a reverse search) or **▶** (for a forward search). When the tape finishes rewinding or forwarding, playback will start. The program numbers will count down beneath **INDEX SEARCH** during the search. If the end of the tape is reached during the search, the search will stop and the tape may rewind. *Details are on page 33.* Recordings should be at least 1 minute long in SP speed, 2 minutes in LP, and 3 minutes in SLP. Otherwise, the Index Mark will not be available. *Details on tape recording speeds are on page 60.*

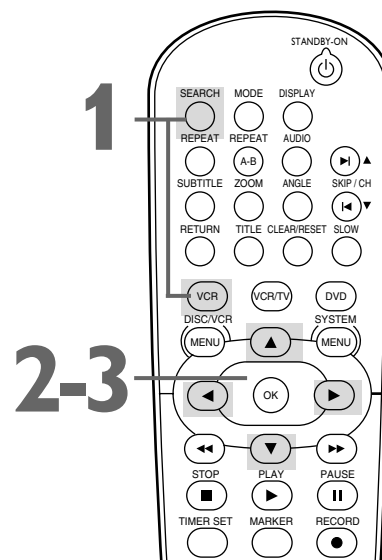

Helpful Hints

- Time Search and Index Search are not available during recording.
- To remove a Search display, press **CLEAR/RESET**.
- To cancel a search, press **STOP** ■.

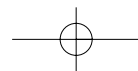

Special Effects Playback 33

- Before you begin, press VCR so VCR light appears on the front of the DVD/VCR.

Forward and Reverse Searching (SP/LP/SLP) / Super High Speed Searching (LP/SLP)

- 1** During tape playback, press and release **▶▶** or **◀◀**. A fast forward or reverse picture search will begin. Press **▶▶** or **◀◀**, then press again. The search speed will increase. Repeatedly pressing **▶▶** or **◀◀** will switch between regular and high speed searching.
- 2** To return to normal playback, press **▶**.

Viewing a Still Picture

- 1** During tape playback, press **⏸**. A still picture will appear on the screen.
- 2** To advance the still picture one frame at a time, press **⏸** repeatedly.
- 3** To release the still picture and return to playback, press **▶**.

Viewing a Slow Motion Picture

- 1** During tape playback, press **⏪**. The tape will play in slow motion.
- 2** To return to normal playback, press **▶**.

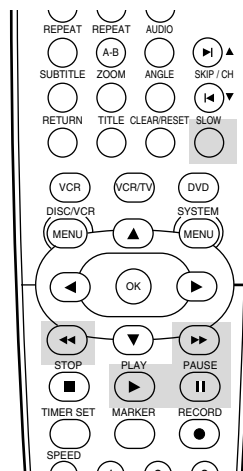

Helpful Hints

- Slow and Still modes will switch to Stop mode after 5 minutes to protect the DVD/VCR and the tape from damage.
- SP/LP/SLP means this feature will work with tapes recorded in Standard Playback, Long Playback, or Super Long Playback. LP/SLP means this feature will work with tapes recorded in Long Playback or Super Long Playback. Tape speed details are on page 60.

Automatic Operation Features

The following tape features are available in VCR mode. Press VCR so VCR light appears on the front of the DVD/VCR, if necessary.

Automatic Playback

When you put a tape in the DVD/VCR, the power will come on. If the tape's record tab is missing, playback will begin. If a timer recording is set and "⏸" is flashing in the display panel, the power will not come on automatically when you insert a tape with the record tab intact.

If a timer recording is set and "⏸" is flashing in the display panel, the DVD/VCR will eject the tape if the record tab is missing.

Automatic Rewind, Eject

When a tape is played, fast forwarded, or recorded to its end, the tape will rewind to the beginning, stop, and eject itself. This feature does not operate if AUTO REPEAT is ON. *Details are on page 31.*

Tape Eject

A tape can be ejected with the DVD/VCR power on or off (but the DVD/VCR must be plugged in). If a timer recording is set and "⏸" appears on the display panel, pressing STOP/EJECT **■▲** (VCR) will turn on the DVD/VCR and/or cancel the timer recording. Press STOP/EJECT **■▲** (VCR) again to remove the tape. Remember to insert a tape and press TIMER SET to reset the timer recording.

Automatic Tracking Adjustment

The VCR adjusts tracking automatically to give you the best possible picture quality. With some recordings, however, you may get a better picture using manual tracking.

Manual Tracking

To manually adjust the tracking during normal playback and slow motion playback of a videotape, press SKIP **▶/CH ▲** or SKIP **◀/CH ▼** on the remote. Tracking will return to Automatic Tracking when you press STOP **■** or insert a tape. You can also press SKIP **▶/CH ▲** or SKIP **◀/CH ▼** to remove vertical jitter in a Still picture.

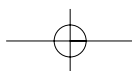

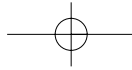

34 Multi-Channel Television Sound / Hi-Fi Stereo

Your DVD/VCR can play tapes recorded in Hi-Fi (high fidelity) stereo, which produces a crisp, clear sound from the left and right audio channels. Your DVD/VCR also can play tapes recorded in a second audio (usually, that means your program is recorded in a second language). Of course, your DVD/VCR will play tapes recorded in monaural (single-source) sound as well. Your DVD/VCR also will record on a video cassette in Hi-Fi stereo or in second audio, so when you play that tape on the DVD/VCR, it will be in stereo or second audio. Read the directions on this page to familiarize yourself with the stereo and second audio setups. Then follow the directions below to record in stereo or second audio, or to play tapes recorded in Hi-Fi stereo.

Understanding Displays

When you watch TV channels through the DVD/VCR, portions of the display shown below will appear when you press DISPLAY twice.

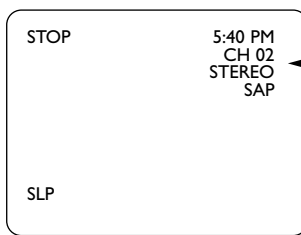

If SAP or STEREO appears, the program is available in second audio or stereo. Even though a program is available in second audio or stereo, you must program the DVD/VCR to receive or record the program. Follow the directions below. This display is not available during tape playback.

To play programs in stereo, connect the DVD/VCR to a Stereo or TV as described on pages 12-13. You will use the red and white AUDIO OUT jacks on the DVD/VCR.

Multi-Channel Television Sound

To set the DVD/VCR to receive programs in stereo or second audio, follow these steps.

- 1** Press **VCR**, then press **DISC/VCR MENU** so MENU appears.
- 2** Press **▲** or **▼** to select **TV STEREO** or **SAP** (Second Audio Program). Press **▶** so **ON** appears beside your selection.
- 3** Press **DISC/VCR MENU** to remove the menu.

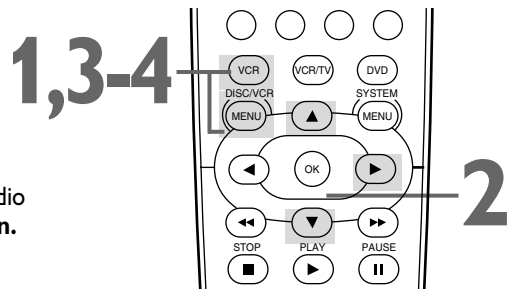

Hi-Fi Stereo

Multi-Channel Television Sound system broadcasts are recorded in Hi-Fi stereo. To play in Hi-Fi stereo the tapes recorded in Hi-Fi stereo, follow these steps.

- 1** Press **VCR**, then press **DISC/VCR MENU** so MENU appears.
- 2** Press **▲** or **▼** to select **AUDIO OUT**. Then, press **▶**.
- 3** Press **▲** or **▼** to select **HIFI**. ON will appear beside HIFI.

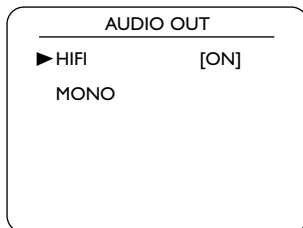

- 4** Press **DISC/VCR MENU** to remove the menu.

Helpful Hints

- You can only receive and record in stereo or second audio programs that are broadcast in stereo or second audio. You can only play a tape in Stereo or second audio if it was recorded in stereo or second audio. Please see above to determine if the program is in stereo or second audio.
- If SAP is ON but the program is not broadcast in Second Audio, you will hear and record the program in normal audio.
- Programs are recorded in both Hi-Fi stereo sound and in monaural (single-channel) sound.
- The audio level of a tape recorded in Hi-Fi stereo will differ from the audio level of a tape not recorded in Hi-Fi stereo.
- You can change to MONO if you want monaural audio playback. Follow steps 1-2, then press **▲** or **▼** to select MONO at step 3. Press DISC/VCR MENU. HIFI will disappear from the status display.
- If you play non-Hi-Fi tapes while AUDIO OUT is set to HIFI, HIFI will not appear on the status display. The tape will play in monaural sound. **Please see additional notes on page 63.**

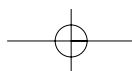

Menus, Playback Control (PBC) Function 35

DVD Disc Menus

Some DVDs contain menus that describe the contents of the Disc or allow you to customize Disc playback. For example, the menu may offer choices for subtitle languages, director's commentary, or Sound track playback. To use the DVD menu and select playback features, follow these steps.

- 1** Press **DVD** to put the DVD/VCR in DVD mode. DVD light will appear on the front of the DVD/VCR.
- 2** Press **DISC/VCR MENU**. The DVD's main Disc menu will appear.
- 3** Press **▲, ▼, ◀, or ▶** to select an item, then press **OK**. Continue this process to set up all the features you want.

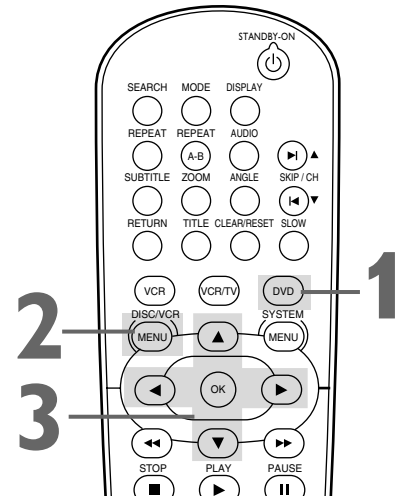

Using the Title Menu

Some DVDs have a Title Menu, which lists the Titles available on the DVD. Use the Title Menu to play a specific Title.

- 1** Press **DVD** to put the DVD/VCR in DVD mode. DVD light will appear on the front of the DVD/VCR.
- 2** Press **TITLE**. The Title menu will appear. If a Title menu is not available, the "X" may appear on the TV screen. Or, if the DVD only has a main Disc menu as described above, it may appear when you press TITLE.
- 3** Press **▲, ▼, ◀, or ▶** to select a Title, then press **OK**. Playback will begin at the Title you selected.

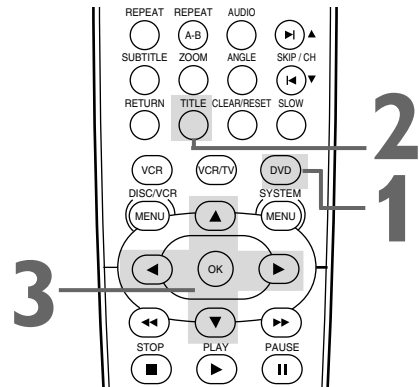

Playback Control (PBC) Function

When playing a Video CD with PBC (Playback Control), you can use interactive menu (e.g., playlists) on the TV screen. Refer to instructions accompanying your Video CD for more details on PBC.

Some operations cannot be performed unless the PBC function is cancelled temporarily.

Canceling and calling back the PBC function

- 1** While playback is stopped, press the **Number Buttons** to enter a **Track number**. PBC function is now cancelled and the playback of the Video CD will start.
 - 2** To call back the **PBC function**, press **STOP** ■ twice, then press **PLAY** ▶.
- The title menu will appear on the TV screen.

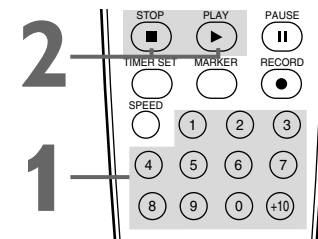

Helpful Hints

- Menus vary among Discs. Follow the literature accompanying the Disc for details.
- Not all DVDs have Disc or Title menus.
- Some DVDs may refer to Chapters as "scenes." Some DVDs may refer to the Title Menu as the "scene index."
- TITLE will not be active with all DVDs.

36 Fast Forward/Reverse Search

- 1 **Press DVD** to put the DVD/VCR in DVD mode. DVD light will appear on the front of the DVD/VCR.
- 2 **During playback, press SEARCH ►► or ◄◄ on the remote control.**
 - During DVD playback, pressing SEARCH ►► or ◄◄ will forward or reverse the picture at approximately 2, 8, 20, 50, or 100 times the normal speed. The speed may vary depending on the Disc. ►► 1, ►► 2, ►► 3, ►► 4, or ►► 5 will appear briefly on the TV screen to indicate forward searching. Or, ◄◄ 1, ◄◄ 2, ◄◄ 3, ◄◄ 4, or ◄◄ 5 will indicate reverse searching. For DVD playback, the sound will be mute during the search.
 - For Video CDs, Audio CDs, MP3 or Windows Media™ Audio playback, pressing SEARCH ►► or ◄◄ will forward or reverse the picture or sound at approximately 2, 8, or 30 times the normal speed. The speed may vary depending on the Disc. ►► 1, ►► 2, or ►► 3 will appear briefly on the TV screen to indicate forward searching. Or, ◄◄ 1, ◄◄ 2, or ◄◄ 3 will indicate reverse searching. For MP3, Windows Media™ Audio or Audio CD playback, the sound will be intermittent during the search.



Example: Playing a DVD in reverse at twice the normal playing speed.

- 3 **Press PLAY ► to return to normal playback.**

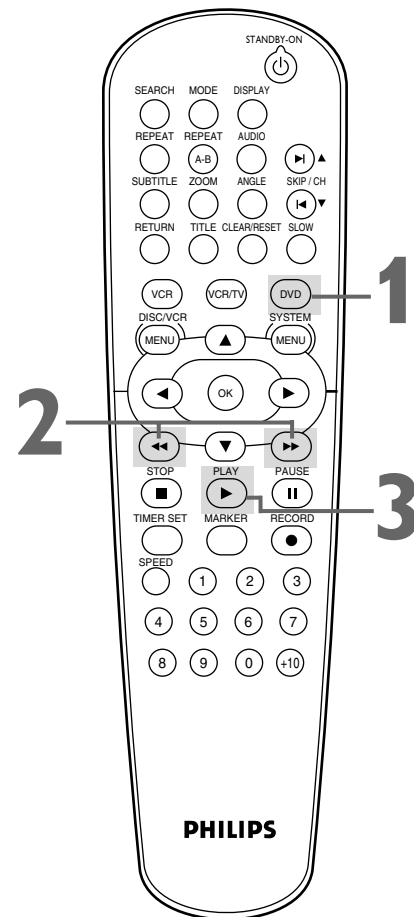

Helpful Hints

- If you use SEARCH ►► or ◄◄ during Dual Playback, JPEG playback will be paused.

Title/Chapter Playback, Time Playback 37

Title/Chapter Playback

- 1** Press **DVD** to put the DVD/VCR in DVD mode. DVD light will appear on the front of the DVD/VCR.
- 2** During DVD playback, press **SEARCH** until CH (for Chapter) or TT (for Title) appears on the TV. The number of available Titles or Chapters will appear at the right (/4, for example).
- 3** Enter the Title or Chapter number using the Number buttons. The Title or Chapter will play.
 - To select a single-digit Track number when there are more than 10 tracks, press OK to play the Track.
 - If you enter a Track number that is not available on the Disc, playback will not begin (or the current Track will continue to play).

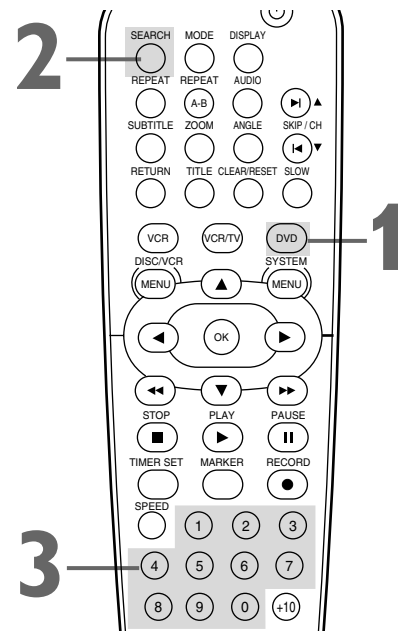
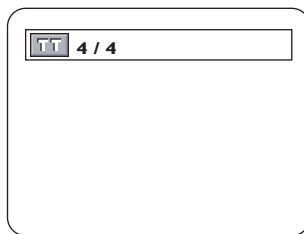
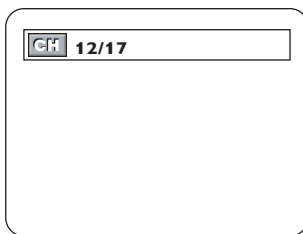

Time Playback

- 1** Press **DVD** to put the DVD/VCR in DVD mode. DVD light will appear on the front of the DVD/VCR.
- 2** During DVD, Audio CD, or Video CD (without PBC) playback, press **SEARCH** until the Time Search display appears.

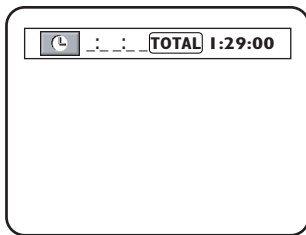

- 3** Within 30 seconds, use the Number buttons to enter the elapsed playing time (of the Track or Title) at which you want playback to begin. Enter the time in hours, minutes, and seconds. Within a few seconds, playback will start at the specified time.
 - Example: 1 hour, 23 minutes, and 30 seconds
1 → 2 → 3 → 3 → 0
 - Make sure the time you enter is within the total time of the current Title or Track. If it is not, the time space will clear and playback will continue at its current point. The total time available in the current Track or Title will appear in the Time Search display.
 - If you make a mistake entering the time, press CLEAR/RESET to clear the time area. Enter the correct information.

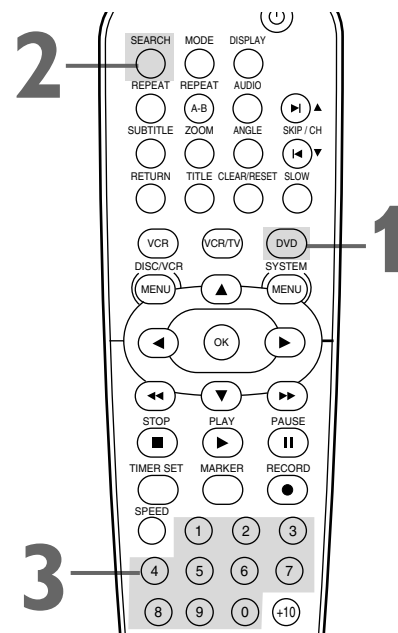

Helpful Hints

- When playback is stopped, use the Number buttons to select a Title for immediate playback. During playback, use the Number buttons to choose a Chapter for immediate playback.
- Title/Chapter playback is not available with some DVDs.

38 Track Playback

There are three ways to play a specific Audio CD, Video CD (without PBC), MP3, Windows Media™ Audio or JPEG Track: Use the Number buttons, the SEARCH button, or SKIP ►/CH ▲ and SKIP ◀/CH ▼.

- Before you begin, press DVD so DVD light appears on the front of the DVD/VCR.

A

Using the Number Buttons

Press the Number buttons to enter a Track number.

Playback will start at the selected Track.

For Tracks 10 and above, press the +10 button so the Search display (TR __ /12 - an example of total tracks) appears on the TV. Press the Number button of the first digit, then press the Number button of the second digit. For example, to play Track 26, press +10, then Number 2, then Number 6 (Each number must be pressed within 30 seconds of the previous number).

For single-digit Tracks (1-9), press a single Number button.

If you enter a Track number that is not available on the Disc, play will not begin (or the current Track will continue to play).

B

Using SEARCH

Press SEARCH so the Track Search display (TR) appears.

Within 30 seconds, press the Number buttons to select the Track number. Playback will begin at the selected Track. For a single-digit Track (1-9), enter 0 first. For example, to play Track 5, press 0, 5. You do not have to use the +10 button in Search Mode.

C

Using SKIP ►/CH ▲ or SKIP ◀/CH ▼

During playback, press SKIP ►/CH ▲ to skip the current Track and move to the next Track. The Track number will appear briefly on the DVD/VCR display panel.

Or, during playback, press SKIP ◀/CH ▼ to return to the beginning of the current Track. Press SKIP ◀/CH ▼ repeatedly to go to previous Tracks. The Track number will appear briefly on the DVD/VCR display panel.

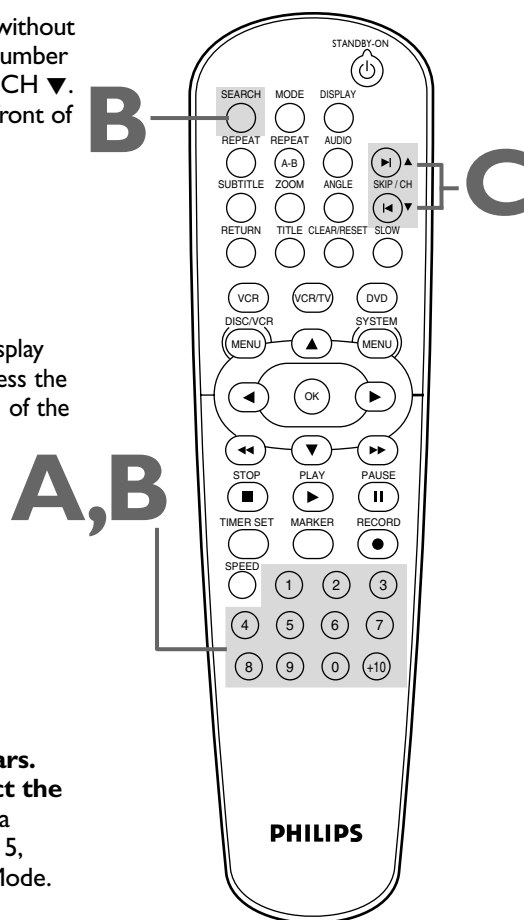

Helpful Hints

- SKIP ►/CH ▲ and SKIP ◀/CH ▼ does not function when playback is stopped.
- You cannot use SKIP ►/CH ▲ to go from the last Track on the Disc to the first Track.
- Using SKIP ►/CH ▲ or SKIP ◀/CH ▼ will only affect MP3 Files during Dual Playback.

Paused and Step-by-Step Playback, Resume On 39

Paused and Step-by-Step Playback

- 1** Press **DVD** to put the DVD/VCR in DVD mode. DVD light will appear on the front of the DVD/VCR.
- 2** During Disc Playback, press **PAUSE** **||**. Playback will pause and the sound will be mute.
 - Pressing **PAUSE** **||** once during Dual Playback will pause a JPEG File only. Pressing **PAUSE** **||** one more time will pause an MP3 track.
- 3** When playing a DVD or Video CD, press **PAUSE** **||** repeatedly to see the picture advance one frame (or step) at a time. The sound will remain mute. Pressing **PAUSE** **||** repeatedly during Audio CD, MP3, Windows Media™ Audio or JPEG playback will have no effect.
- 4** Press **PLAY** **▶** to resume play.

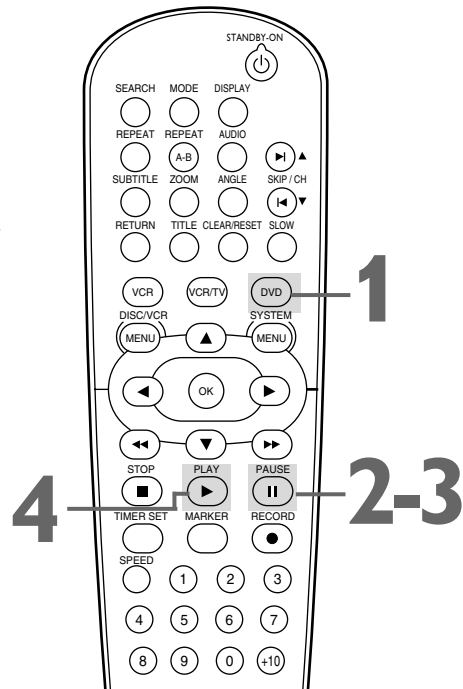

Resume On

- 1** Press **DVD** to put the DVD/VCR in DVD mode. DVD light will appear on the front of the DVD/VCR.
- 2** Press **STOP** **■** during playback. In a few seconds, the following Resume message will appear on the TV screen.

For DVD, AudioCD or VideoCD:

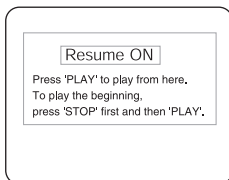

For MP3, Windows Media™ Audio or JPEG:

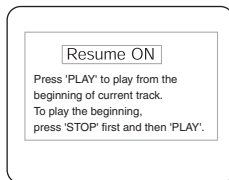

- 3** Press **PLAY** **▶**. In a few seconds, playback will resume from the point at which it stopped last. You can resume playing at the same point even if you turn off the DVD/VCR, then turn it on again later. However, opening the disc tray will cancel the Resume feature. Playback will start at the beginning the next time you insert the Disc. For MP3, Windows Media™ Audio and JPEG playback will resume from the beginning of the current Track. To cancel Resume and start playing the Disc from the beginning, press **STOP** **■** again while playback is stopped. The Stop symbol (■) will appear briefly on the TV screen. Press **PLAY** **▶** to start playing the Disc from the beginning.
 - For MP3, Windows Media™ Audio and JPEG Tracks, playback will resume from the beginning of the current track.
 - To resume playback of a Video CD with PBC function, you have to cancel the PBC function first. See page 35 on how to cancel the PBC function.

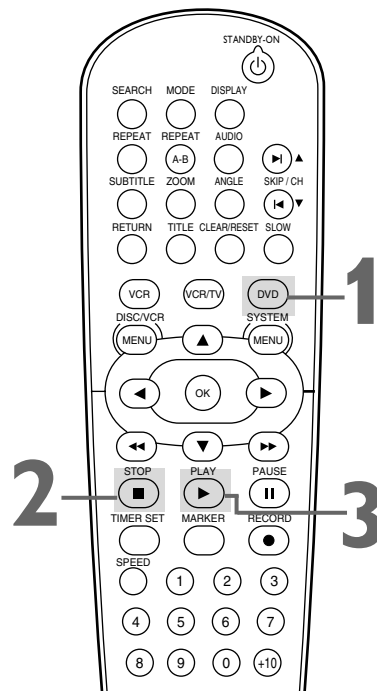

Helpful Hint

- Set STILL MODE to FIELD in the DISPLAY menu if paused images are blurry. Details are on pages 53-54.

40 Repeat Playback, A-B Repeat

Repeat Playback

- 1** Press **DVD** to put the DVD/VCR in DVD mode. DVD light will appear on the front of the DVD/VCR.
- 2** During DVD, Audio CD, MP3, Windows Media™ Audio, JPEG or Video CD (without PBC) playback, press **REPEAT** until the repeat mode you want appears on the TV. On a DVD, select CHAPTER, TITLE, or OFF. On an Audio CD and Video CD (without PBC), select TRACK, ALL (all Tracks on the Disc), or OFF. With MP3, Windows Media™ Audio or JPEG Tracks, select TRACK, GROUP (all Tracks in the current Folder), ALL, or OFF. Selecting a new Track, Chapter, or Title will cancel repeat playback.



Example: Repeat a DVD Chapter

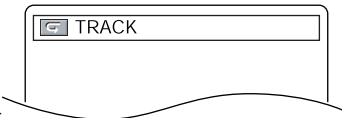

Example: Repeat an Audio CD or Video CD Track

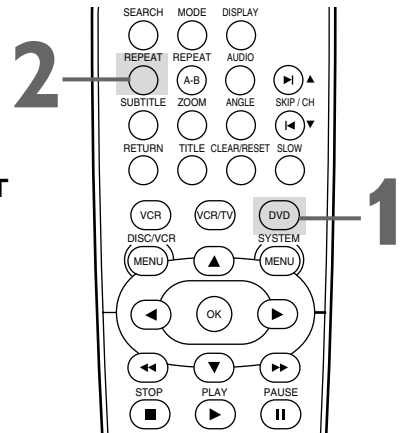

A-B Repeat

You can play a section of a DVD, Audio CD, or Video CD repeatedly. Follow these steps to set up the section you want to repeat.

- 1** Press **DVD** to put the DVD/VCR in DVD mode. DVD light will appear on the front of the DVD/VCR.
- 2** Press **PLAY** ► to play the Disc to the point at which you want repeated playback to begin.
- 3** Press **A-B REPEAT** to set the starting point (A). If you make a mistake, press **CLEAR**. This will erase point A and let you start over. OFF will appear briefly on the TV screen.

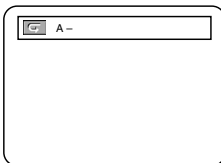

- 4** Play the Disc to the point at which you want repeated playback to end, then press **A-B REPEAT** again. Within a few seconds, the section will begin to play. The segment will play over and over until you cancel the A-B Repeat feature.

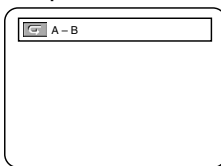

- 5** To cancel A-B Repeat, press **A-B REPEAT**. OFF will appear on the TV screen. Regular playback will resume.

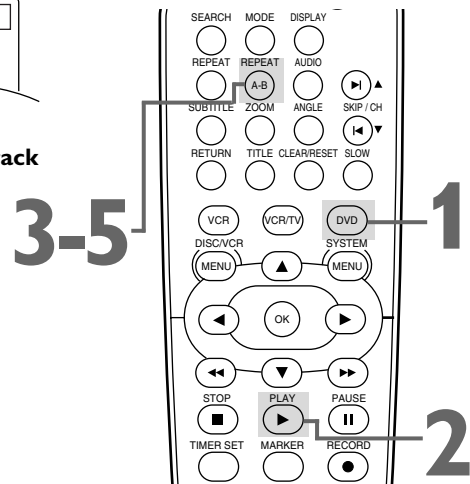

Helpful Hints

- Repeat playback and A-B Repeat are not available with all Discs.
- The entire A-B Repeat section must be within a single Title or Track. If you do not enter Point B before the end of the Track or Title is reached, the end of the Track or Title will become Point B automatically.
- Point B must be later on the Disc than Point A.
- A-B Repeat is not available with MP3, Windows Media™ Audio and JPEG files.
- If you choose GROUP Repeat during Dual Playback, all Tracks or Files in each Folder will play repeatedly. For example if you choose GROUP Repeat during Dual Playback of MP3 Folder A and JPEG Folder B, all MP3 Tracks in Folder A and all JPEG Files in Folder B will be repeated.

Markers 41

Use Markers to remember your favorite places on a DVD, Audio CD, or Video CD (without PBC).

- Before you begin, place the DVD/VCR in DVD mode. Press DVD so DVD light appears on the front of the DVD/VCR.

- 1 Play the Disc to within 30 seconds of the point at which you want to set the Marker. Press MARKER.**
The Markers will appear at the top of the TV screen.

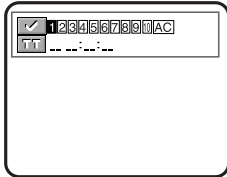

Example: DVD

- 2 Within 30 seconds, press ◀ or ▶ to select a Marker (1-10).** Make sure __:__:__ appears beneath the number.

- 3 When the playback reaches the point you want to remember, press OK.** The Title or Track number and its elapsed playing time will appear beneath the Markers. A checkmark will replace the Marker number. The Marker display will disappear in about 30 seconds, or press MARKER again to remove it.

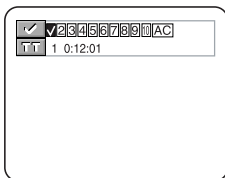

Example: DVD

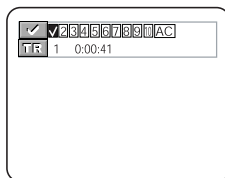

Example: Audio CD or Video CD

- 4 To return to a Marker during playback, press MARKER.** Press ◀ or ▶ to choose the Marker you want, then press OK. Disc playback will continue from the marked point.

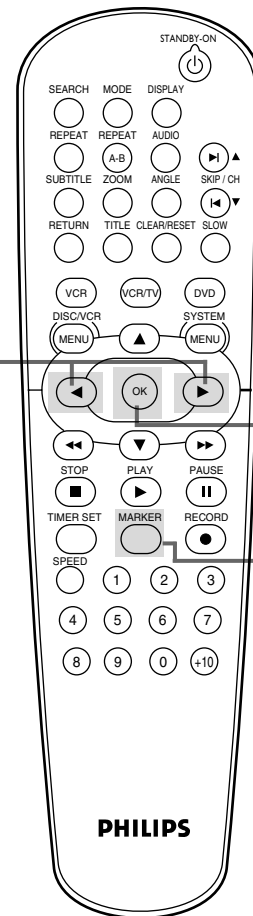

Helpful Hints

- Opening the disc tray or turning off the DVD/VCR will erase all the Markers.
- To erase a single Marker, press MARKER. Press ◀ or ▶ to select a Marker. Press CLEAR/RESET. Press RETURN or MARKER to remove the display.
- To erase all the Markers, press MARKER until you see the Markers. Press ▶ to select AC, then press OK. Press MARKER or RETURN to remove the display.

42 Subtitles, Camera Angles

Subtitles

The DVD/VCR allows you to select a language for subtitles during playback. You may select only languages that are available on the DVD.

- 1** Press **DVD** to put the DVD/VCR in DVD mode. DVD light will appear on the front of the DVD/VCR.
- 2** During playback, press **SUBTITLE** repeatedly to select a subtitle language. The number of available languages appears at the right of the subtitle display. In the example below, six languages are available (/6). After a few seconds, the subtitles will appear.
Or, press SUBTITLE repeatedly to turn off subtitles. When no subtitles are available, "NOT AVAILABLE" appears at the right of the subtitle display.



Example: English as first of six available subtitles

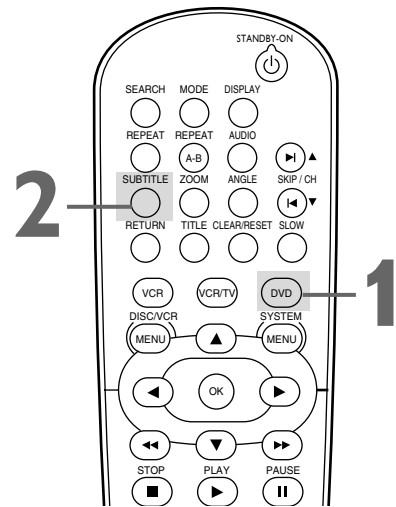

Camera Angles

Some DVDs contain scenes recorded from different angles or perspectives. The perspective will not change if the DVD does not contain sequences recorded from different camera angles.

- 1** Press **DVD** to put the DVD/VCR in DVD mode. DVD light will appear on the front of the DVD/VCR.
- 2** During playback, press **ANGLE** repeatedly to select a different perspective. The number of available angles appears at the right of the Angle display. In this example, eight angles are available (/8).

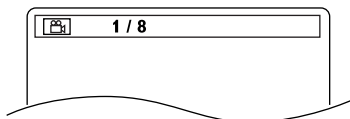

Example: Angle 1 of eight available angles

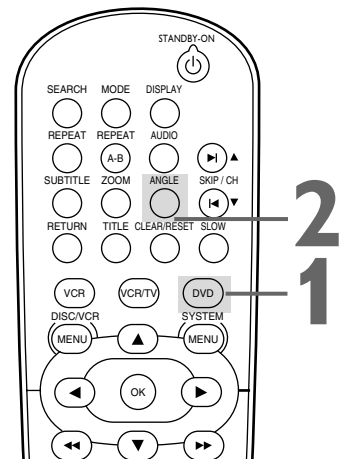

Helpful Hints

- With some DVDs, you must select a subtitle language in the Disc menu.
- If the desired language does not appear after pressing SUBTITLE several times, the Disc does not have subtitles in that language.
- Opening the disc tray will cancel your subtitle setting.
- If the ANGLE ICON setting is ON,  will appear on the TV screen when the current portion of the Disc has multiple camera angles. To set the ANGLE ICON ON or OFF, see pages 58-59.

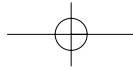

Audio Language, Stereo Sound Mode 43

Audio Language

You can select a language for DVDs during playback if multiple languages are available.

- 1** Press **DVD** to put the DVD/VCR in DVD mode. DVD light will appear on the front of the DVD/VCR.
- 2** During DVD playback, press **AUDIO** repeatedly to choose one of the available languages. Audio display appears at the top of the TV screen, and the new audio will be heard. The display will disappear after about 5 seconds. The Audio display may show the current settings for the Dolby Digital or multi-channel (5.1CH) sound, if they are available on the disc, and the sampling rate of the disc. The number of available languages appears after the “ / ” at the right of the display (/3, for example).

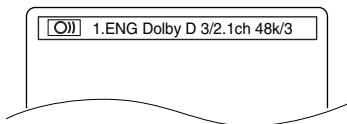

Example: English audio

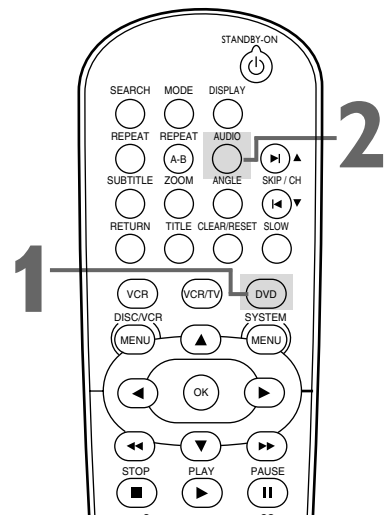

Stereo Sound Mode

Adjust Stereo Sound to determine whether you will hear the left channel, the right channel, or both channels (stereo) during Audio CD or Video CD playback.

If you connected the DVD/VCR to a Stereo using the COAXIAL DIGITAL AUDIO OUT jack as described on page 14, or if you connected to a TV with only the RF coaxial cable, you cannot adjust Stereo Sound Mode.

- 1** Press **AUDIO** repeatedly during Audio CD or Video CD playback to choose **STEREO**, **L-ch**, or **R-ch**.

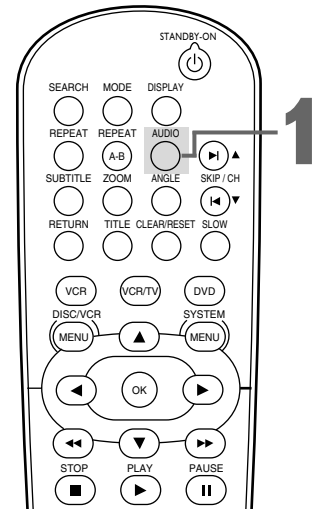
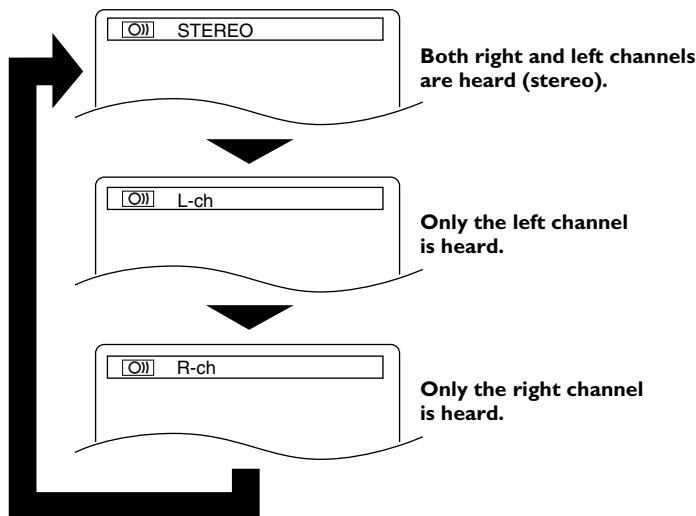

Helpful Hints

- If a language is not available after pressing **AUDIO** several times, the DVD does not have that language.
- Some DVDs only let you change the language in the Disc menu.
- Audio languages may be abbreviated (such as **ENG** for English). Or, three dashes (- - -) may appear instead of an abbreviation.

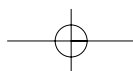

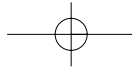

English

44 Slow Motion, Zoom

Slow Motion

- 1 Press **PAUSE** during **DVD or Video CD** playback.
- 2 Press **▶▶** or **◀◀**. Slow motion playback will begin. Press **▶▶** or **◀◀** repeatedly during slow motion playback to play a DVD forward or backward at approximately 1/16, 1/8, or 1/2 the normal speed. Reverse slow motion is not available on a Video CD.
An **▶▶ 1 (1/16)**, **▶▶ 2 (1/8)**, or **▶▶ 3 (1/2)** will appear briefly on the TV screen to indicate slow forward playback.
An **◀◀ 1 (1/16)**, **◀◀ 2 (1/8)**, or **◀◀ 3 (1/2)** will indicate slow reverse playback.

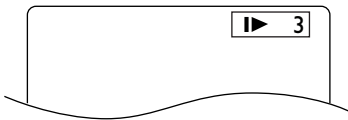

Example: Playing a DVD forward at half the normal speed.

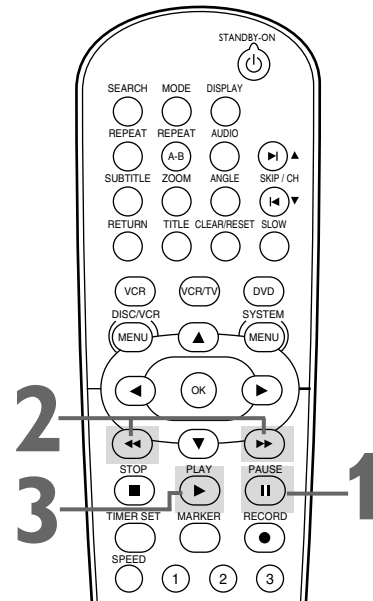

- 3 Press **PLAY** to return to normal playback.

Zoom

Zooming lets you enlarge the playback image of DVDs, Video CDs or JPEG CDs, and lets you pan through the enlarged image.

- 1 Press **ZOOM** during playback or when playback is paused. The picture will appear twice as large. Press **ZOOM** again to make the picture four times larger than normal. Either x2 or x4 will appear beside the zoom icon in the upper left corner of the TV screen.
- 2 While the picture is enlarged, press **▲**, **▼**, **◀**, or **▶** to move the zoomed image up, down, left, or right.
The gray box with an inner blue box that shows during Zoomed playback is the position guide. To remove it or show it, press **OK**. The position of the blue box inside the gray box indicates the position of the zoomed image within the overall picture.



- 3 To return the picture to normal, press **ZOOM** repeatedly.

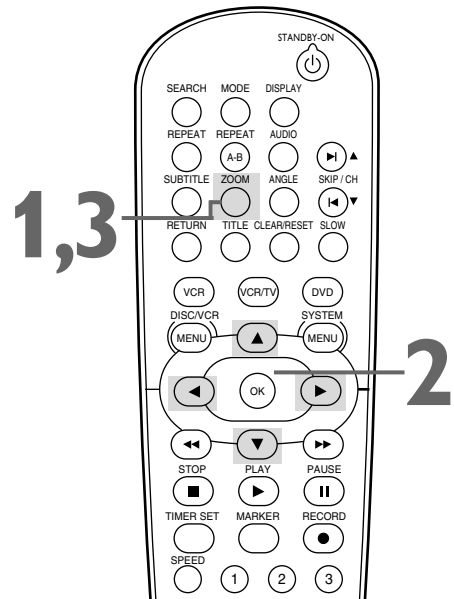

Helpful Hints

- Only slow forward is available for Video CDs.
- The sound will be mute during paused or slow motion playback.
- You cannot zoom a Disc menu.
- The x4 zooming is not active with some Discs. Only x2 zooming is available for Video CDs and JPEG CDs.
- Position guide is not available for JPEG playback.

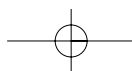

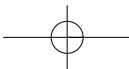

Program/Random Playback 45

Program Playback

You may determine the order in which Audio CD, MP3, Windows Media™ Audio or JPEG Tracks will play.

Random Playback

You may play the Tracks of an Audio CD in Random order instead of the order in which they are recorded (1,2,3...). You can also use this feature for MP3, Windows Media™ Audio and JPEG Tracks.

- 1 Press **DVD** to put the DVD/VCR in DVD mode. DVD light will appear on the front of the DVD/VCR.
- 2 While playback is stopped, press **MODE** repeatedly until the **PROGRAM/RANDOM** screen appears.

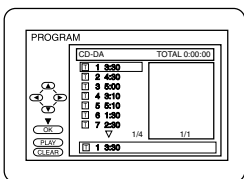

Example: Audio CD

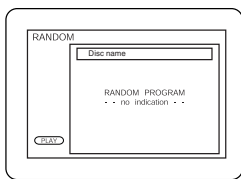

Example: MP3 (DUAL PLAYBACK - OFF)

Program Playback

- 3 Press **▲** or **▼** to select a Track you want to play, then press **OK**.

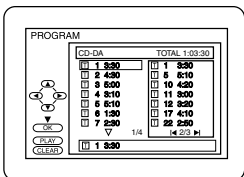

Example: Audio CD

Press **CLEAR** to erase the last Track in the Program if you make an error. Additional Tracks may be on other screens. Press **▼** to go on to the next page, and press **▲** to go back to the previous page. Repeat this step until you have selected all the Tracks you wish to play in the Program. To see Tracks in a Program when there are more than 8 tracks, use **SKIP ◀/CH▲**, **SKIP ▶/CH▼** to see all the Tracks. For MP3, Windows Media™ Audio or JPEG folders, press **◀** or **▶** to go to the previous or next level of folders. Press **TITLE** to return to the first item in the highest level.

- 4 Press **PLAY ▶**. The Tracks will play once in the order you set. Turning off the Player or opening the disc tray will erase the Program.

Random Playback

- 3 While the **RANDOM** screen appears, press **PLAY ▶**. The Tracks will play in random order. After all the Tracks play once, playback will stop.

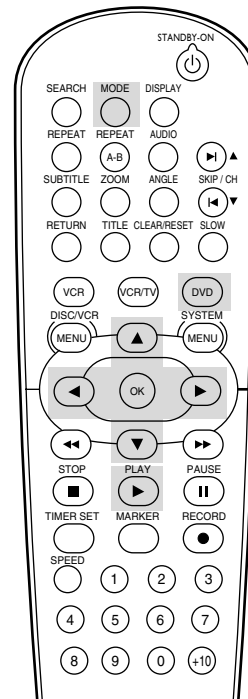

Helpful Hints

- You cannot use the Number buttons or **SEARCH** to select another Track while playing a Program. Use **SKIP ▶/CH▲** or **SKIP ◀/CH▼** to select other Tracks in a Program.
- You cannot combine Random playback with a Program.
- You may play a Program or a Track within a Program repeatedly. During Program playback, press **REPEAT** so **ALL** (all Tracks in the Program) or **TRACK** appears. The entire Program or the current Track will play over and over.
- You cannot alter a Program during playback.
- You can start Program playback only while in the **PROGRAM** screen.
- A Program can have a maximum of 99 Tracks.
- To erase all Tracks in the Program, select **ALL CLEAR** at step 3.
- Program/Random playback of MP3, Windows Media™ Audio or JPEG Tracks is not available while **DUAL PLAYBACK** is ON.

46 MP3/Windows Media™ Audio/JPEG Playback

The DVD/VCR will play MP3, Windows Media™ Audio and JPEG files that you record and finalize on a CD-RW (Compact Disc-Rewritable) or CD-R (Compact Disc-Recordable).

These Discs may contain pictures in a JPEG format or audio Tracks in an MP3 or Windows Media™ Audio format. For example, you may have photographic film developed by a retailer that places the pictures on a CD-R for you. These pictures may be in JPEG format. Or, you may copy or download MP3/Windows Media™ Audio music files from certain legal Internet sites, then copy those files onto a CD-R or CD-RW.

You cannot make or record such Discs using this DVD/VCR. See your computer manual for details on recording.

Keep these characteristics in mind when making Discs you intend to play on the DVD Player of this DVD/VCR.

- Record MP3 Tracks at a sampling frequency of 44.1 kHz or 48 kHz. Record in a constant bit rate between 32 kbps and 320 kbps.
- Record Windows Media™ Audio Tracks at a sampling frequency of 44.1kHz or 48kHz. Record in a constant bit rate between 48-192kbps.
- When recording JPEG Files, the size of the picture should be between 32 x 32 and 6300 x 5100 dots.



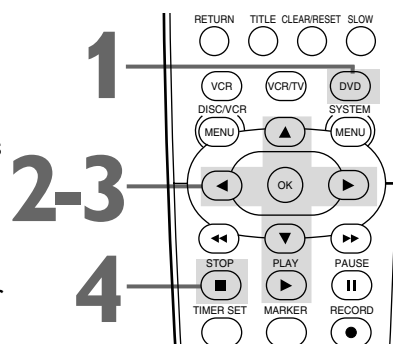

- 1 Press DVD** to put the DVD/VCR in DVD mode. DVD light will appear on the front of the DVD/VCR.
- When you put a CD-RW or CD-R with MP3, Windows Media™ Audio or JPEG files in the DVD/VCR, a File List will appear on the TV when you press DISC/VCR MENU. (If you use **PLAY ►** to close the Disc tray, Playback starts automatically.) **Press ▲ or ▼ to select a Folder, MP3, Windows Media™ Audio or JPEG File.**
- If you choose a Track or File, press PLAY ► or OK.** Starting with the Track or File you selected, the Tracks/Files will play in the order they were recorded, i.e. 1, 2, 3. **If you select a Folder and press OK, the Tracks or Files within that Folder will appear. Press ▲ or ▼ to select the Track or File you want to play, then press PLAY ► or OK.**

- Press TITLE to return to the first item in the highest level of folders or files. You also can press ◀ or ▶ to return to previous or next levels.
- To change the TRANSITION MODE for JPEG playback, press MODE repeatedly until TRANSITION MODE appears on top of the TV screen during playback. Then press ◀, ▶, or OK to switch CUT IN/OUT and FADE IN/OUT. If you choose CUT IN/OUT, the images will cut in and out sharply as playback progresses. If you choose FADE IN/OUT, the images will fade in and out as playback progresses.
- To change the size of the playback image, press MODE repeatedly until SIZE MODE appears on top of the TV screen during playback. Then press ◀, ▶, or OK to switch NORMAL(100%) and SMALL(95%).
- Press MODE to remove the display.
- During JPEG playback, press ◀ or ▶ to rotate a picture 90 degrees clockwise or counter-clockwise.

- 4 To stop play, press STOP ■.**



Helpful Hints

- JPEG images and MP3/Windows Media™ Audio Tracks are known as Files. Groups of Files are called Folders.
- Folders have the  icon, JPEG Files have the  icon, MP3 Files have the  icon, and Windows Media™ Audio Files have the  icon.
- A maximum of 255 Folders can be recognized. A maximum of 999 Files can be recognized.
- If you use **PLAY ►** to close the Disc tray, playback starts automatically. If you use **OPEN/CLOSE ▲** to close the Disc tray, you have to press **PLAY ►** to start playback.
- During playback, use the Number buttons or **SKIP ►/CH ▲** and **SKIP ◀/CH ▼** to change Tracks. If a Track is not available, "X" will appear on the TV screen, and playback may resume at an incorrect Track or may continue with its current Track.
- Specific Time playback is not possible with MP3 Tracks.
- To see the File List during playback, press DISC/VCR MENU. The current Track will be highlighted.
- Progressive JPEGs (JPEG files saved in the progressive format) will not play on this DVD player.
- Copyright protected Windows Media™ Audio Files will not play on this DVD player.
- High resolution JPEG Files takes longer to be displayed.
- SIZE CHANGE MODE may have no effect on some files (e.g. Files with a small picture size).

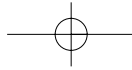

MP3/Windows Media™ Audio/JPEG Playback (cont'd) 47

Dual Playback

This feature lets you play MP3 Tracks and JPEG Files simultaneously.

Available only when DUAL PLAYBACK is ON.

See pages 58-59 on how to set the DUAL PLAYBACK ON or OFF.

- 1** Press **DVD** to put the DVD/VCR in DVD mode. **DVD** light will appear on the front of the DVD/VCR.
- 2** Press **DISC/VCR MENU** during MP3/JPEG playback. A File List will appear.
- 3** Press **▲** or **▼** to select a desired JPEG File/an MP3 Track from the List and press **PLAY ►** or **OK**.
- 4** To stop playback, press **STOP ■**.

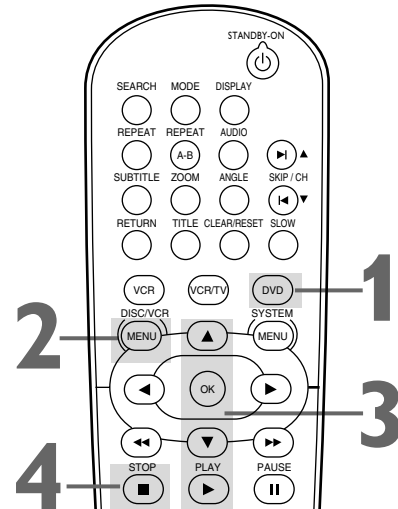

Folder Playback

You may select to play a Folder.

Available only when DUAL PLAYBACK is ON.

See pages 58-59 on how to set the DUAL PLAYBACK ON or OFF.

- 1** Press **DVD** to put the DVD/VCR in DVD mode. **DVD** light will appear on the front of the DVD/VCR.
- 2** While playback is stopped, press **MODE**. A Folder List will appear.
- 3** Press **▲** or **▼** to select a Folder, then press **PLAY ►** or **OK**.
 - MP3 Tracks and JPEG Files in the selected Folder will play simultaneously.

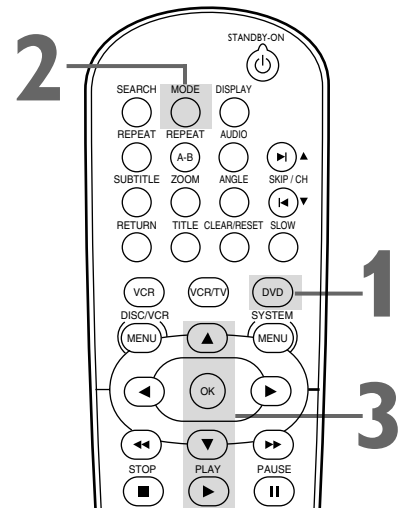
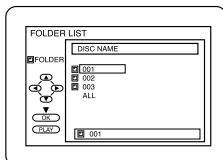

Helpful Hints

- If you press **PLAY ►** directly after you inserted a disc which contains both MP3 Tracks and JPEG Files and if the **DUAL PLAYBACK** setting is ON, Dual Playback will start automatically.
- You can not play Windows Media™ Audio and JPEG Files together at the same time. If you choose a Windows Media™ Audio File during Dual Playback, only Windows Media™ Audio File will play.
- Zooming or rotating a JPEG File during Dual Playback may cause an intermittent sound.
- Dual Playback may not function properly if MP3 and JPEG Files on the disc interfere each other due to the difference in their data size.

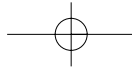

English

48 On-Screen Displays

DVD Displays

- 1** Press **DVD** to put the DVD/VCR in DVD mode. DVD light will appear on the front of the DVD/VCR.
- 2** Press **DISPLAY** repeatedly to see the following displays during DVD playback.

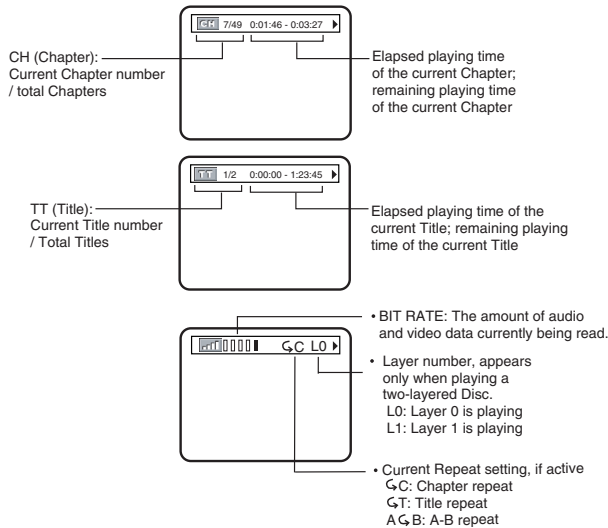

- 3** Press **DISPLAY** repeatedly or press **RETURN** to remove the display.

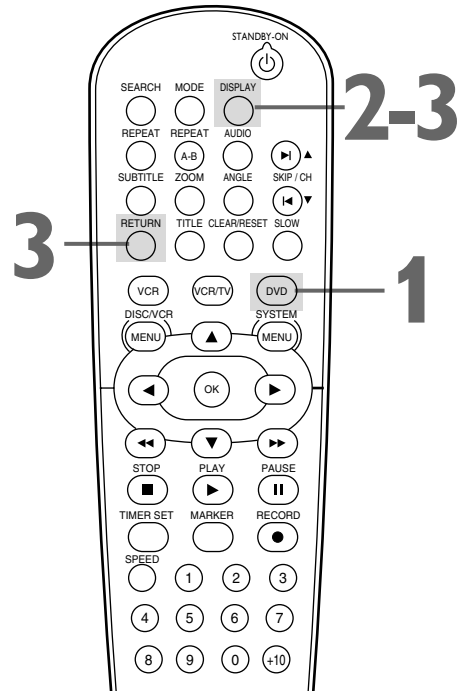

Audio CD and Video CD Displays

- 1** Press **DVD** to put the DVD/VCR in DVD mode. DVD light will appear on the front of the DVD/VCR.
- 2** Press **DISPLAY** repeatedly to see the following displays during Audio CD or Video CD (without PBC) play.

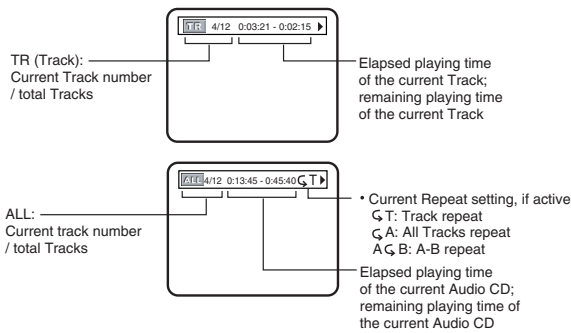

- 3** Press **DISPLAY** repeatedly or press **RETURN** to remove the display.

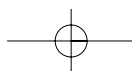
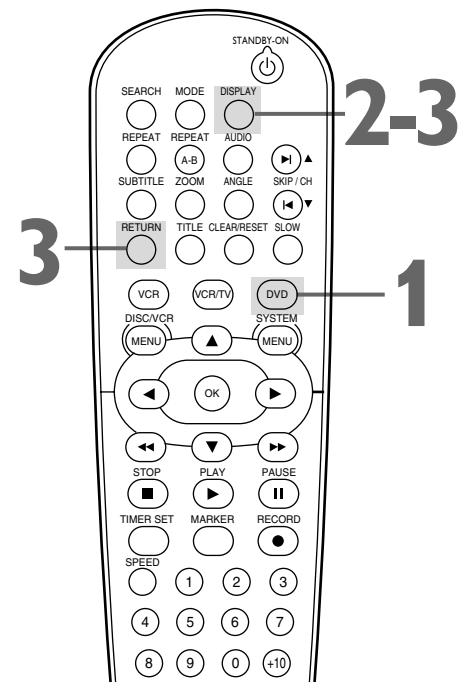

On-Screen Displays (cont'd) 49

MP3/Windows Media™ Audio/JPEG Displays

Review MP3 and JPEG Track information during playback.

- 1** Press **DVD** to put the DVD/VCR in DVD mode. DVD light will appear on the front of the DVD/VCR.
- 2** Press **DISPLAY** until the current Track or File information appears.

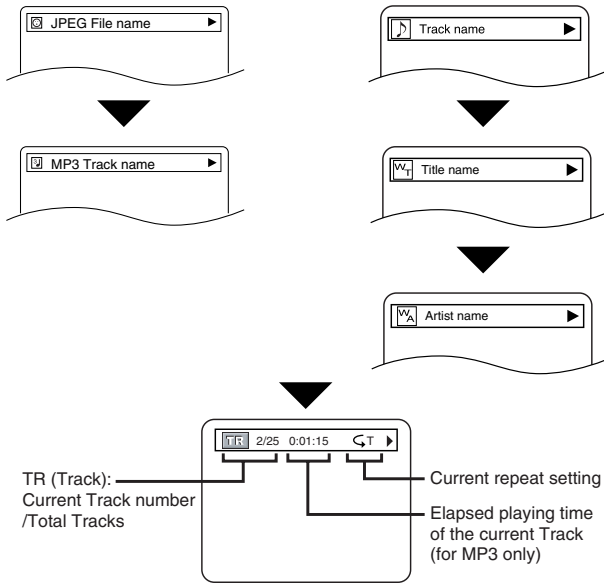

Example: MP3 Track

The following may appear to indicate Repeat playback.

- T: The current Track will play repeatedly.
- G: Tracks in the current Folder (Group) will play repeatedly.
- A: All Tracks will play repeatedly

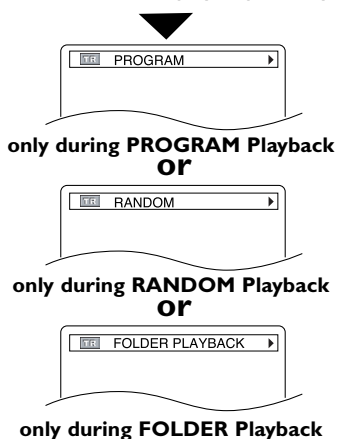

- Program and Random Playback is available only when DUAL PLAYBACK is OFF.
- Folder Playback is available only when DUAL PLAYBACK is ON.

- 3** Press **DISPLAY** again to remove the display.

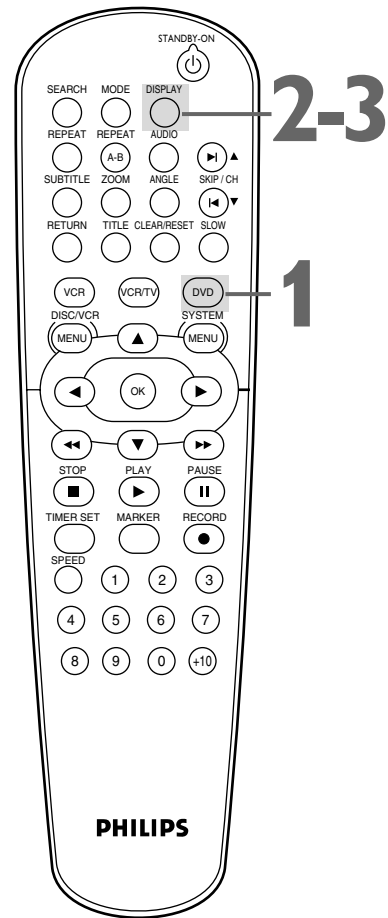

PHILIPS

Helpful Hint

- For MP3 files recorded with Variable Bit Rate (VBR), the elapsed time displayed on the screen may vary from the actual elapsed time.

50 Black Level, Virtual Surround

Black Level

Adjust Black Level to brighten the DVD or Video CD picture.

- 1 Press **DVD** to put the DVD/VCR in DVD mode. DVD light will appear on the front of the DVD/VCR.
 - 2 During DVD or Video CD playback, press **MODE** so the Black Level icon shows in the top left corner of the TV screen.
- 
- ON**
- 3 Within 10 seconds, press **◀**, **▶**, or **OK** repeatedly to choose **ON** or **OFF**. **ON** brightens the dark parts of the picture. **OFF** shows the original picture as recorded.

Virtual Surround

You can enjoy improved stereo sound when you play DVDs, Audio CDs, Video CDs, MP3 or Windows Media™ Audio files recorded in Dolby Digital or Pulse Code Modulation (PCM). Check the Disc case for details on availability.

- 1 Press **DVD** to put the DVD/VCR in DVD mode. DVD light will appear on the front of the DVD/VCR.
 - 2 During Disc playback, press **MODE** repeatedly until the Virtual Surround icon appears in the top left corner of the TV screen.
- 
- OFF**
- 3 While the Virtual Surround icon appears, press **◀**, **▶**, or **OK** to choose **1**, **2**, or **OFF**. The default setting is **OFF**. The icon will disappear after about 10 seconds.

Initializing

Use INITIALIZE to return all your DVD Player's SETUP menu items (except PARENTAL) to their default settings.

- 1 Press **DVD** to put the DVD/VCR in DVD mode. DVD light will appear on the front of the DVD/VCR.
- 2 While playback is stopped, press **SYSTEM/MENU**. The QUICK SETUP screen appears.

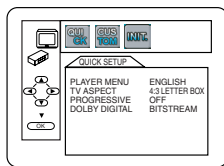

- 3 Press **◀** or **▶** to select **INIT. (INITIALIZE)** at the top of the menu, then press **OK**.

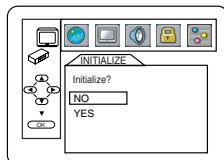

- 4 Press **▲** or **▼** to select **YES**. Then, press **OK** twice. To cancel the process, select **NO** instead.

- 5 Press **SYSTEM/MENU** to remove the menu.

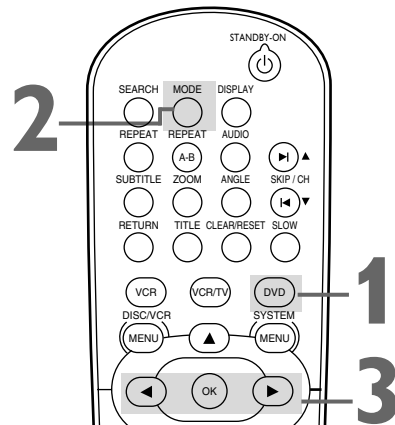

Helpful Hints

- Black Level is not available for a PAL DVD.
- Virtual Surround is available only when the Player is connected to a Stereo or TV using the red and white AUDIO OUT jacks on the Player.
- For Audio CDs and Video CDs, you can adjust Virtual Surround only if you set Stereo Sound to STEREO. Details are on page 43.
- The Black Level and Virtual Surround settings will be saved even if the Player is turned off.

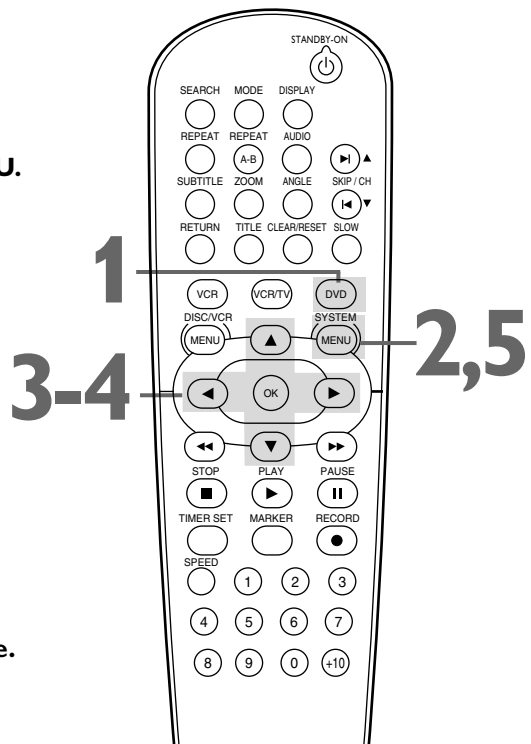

Language 51

English

You can select different languages for the Audio or Subtitles of DVDs, as well as languages for DVD Disc menus and the Setup menus of the DVD Player.

1 Press DVD to put the DVD/VCR in DVD mode. DVD light will appear on the front of the DVD/VCR.

2 While playback is stopped, press SYSTEM/MENU. The QUICK SETUP screen appears.

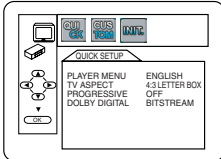

3 Press ◀ or ▶ to select CUSTOM at the top of the menu, then press OK.

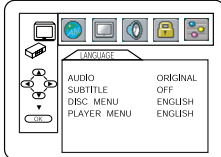

4 (LANGUAGE) will be selected. Press OK.

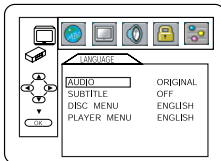

5 Press ▲ or ▼ to select AUDIO, SUBTITLE, DISC MENU, or PLAYER MENU. Press OK. The language options for the selected item will appear.



AUDIO: The DVD's audio plays in the selected language.



SUBTITLE: Subtitles appear in the chosen language.

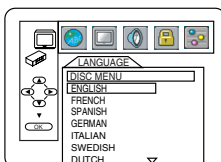

DISC MENU: A DVD's Disc menu appears in the chosen language.

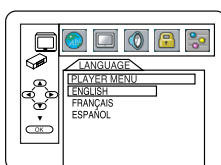

PLAYER MENU: The DVD Player's Setup menu can be in English, French, or Spanish only.

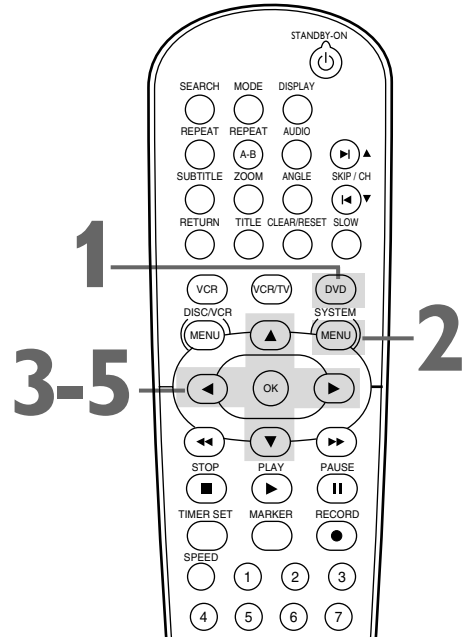

Helpful Hints

- If the DVD's default settings for Audio and Subtitle are the same language, the subtitles may not show unless you turn them on.
- Use the AUDIO and SUBTITLE buttons to select Audio and Subtitles available on the DVD. Details are on pages 42-43.
- If you set AUDIO to ORIGINAL, the default setting of the DVD Audio will play.
- If you set PLAYER MENU to FRANCAIS (French) or ESPAÑOL (Spanish) and need English: Follow steps 1-2. At step 3, the IDIOMA or LANGUE menu will appear. Press OK. Press ▼ to select MENU DU LECTEUR or MENÚ REPRODUC., then press OK. Press ▲ to select ENGLISH, then press OK. The menus will change to English. Press SETUP to remove the menus.
- You can change the PLAYER MENU language in the QUICK SETUP menu that appears when you first press SETUP. With QUICK selected, press OK. PLAYER MENU will be selected. Press OK. Press ▲ or ▼ to choose a language, then press OK. Press SETUP to remove the menu.
- The language settings may not take effect until you restart Disc playback from the beginning.

Instructions continue on the next page.

52 Language (cont'd)

- 6** Press **▲** or **▼** to select a language, then press **OK**. The language lists may continue on multiple screens. Press **▲** or **▼** to move to the other screens.
- If you select **OTHER** for **AUDIO**, **SUBTITLE**, or **DISC MENU**, press four **Number** buttons to enter the code for the language you desire. Use one of the Language Codes listed below. The language or language code you select will appear in the Language menu beside **AUDIO**, **SUBTITLE**, or **DISC MENU**.

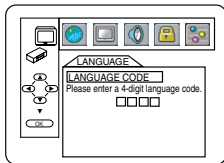

- You can select other languages for **AUDIO**, **SUBTITLE**, and **DISC MENU** only if the language is available on the Disc. If the language you select is not recorded on the DVD, changing these settings will have no effect.

- 7** Press **SYSTEM/MENU** to remove the menu.

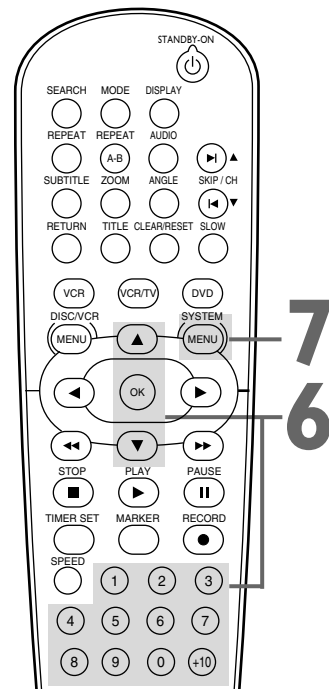

Language Codes

A-B	English	5160	Kannada	5760	Panjabi	6247	T		
Abkhazian	4748	Esperanto	5161	Kashmiri	5765	Pashto	6265	Tagalog	6658
Afar	4747	Estonian	5166	Kazakh	5757	Persian	5247	Tajik	6653
Afrikaans	4752	F-H		Kinyarwanda	6469	Polish	6258	Tamil	6647
Albanian	6563	Faroese	5261	Kirghiz	5771	Portuguese	6266	Tatar	6666
Amharic	4759	Fiji	5256	Kirundi	6460	Pushto	6265	Telugu	6651
Arabic	4764	Finnish	5255	Korean	5761	Quechua	6367	Thai	6654
Armenian	5471	French	5264	Kurdish	5767	Rhaeto-Romance	6459	Tibetan	4861
Assamese	4765	Frisian	5271	L-N		Romanian	6461	Tigrinya	6655
Aymara	4771	Gaelic (Scots)	5350	Laothian	5861	Russian	6467	Tonga	6661
Azerbaijani	4772	Galician	5358	Latin	5847	S		Tsonga	6665
Bangla	4860	Georgian	5747	Latvian	5868	Samoan	6559	Turkish	6664
Bashkir	4847	German	5051	Lettish	5868	Sangho	6553	Turkmen	6657
Basque	5167	Greek	5158	Lingala	5860	Sanskrit	6547	Twì	6669
Bengali	4860	Greenlandic	5758	Lithuanian	5866	Serbian	6564	U-Z	
Bhutani	5072	Guarani	5360	Macedonian	5957	Serbo-Croatian	6554	Ukrainian	6757
Bihari	4854	Gujarati	5367	Malagasy	5953	Sesotho	6566	Urdu	6764
Bislama	4855	Hausa	5447	Malay	5965	Setswana	6660	Uzbek	6772
Breton	4864	Hebrew	5569	Malayalam	5958	Shona	6560	Vietnamese	6855
Bulgarian	4853	Hindi	5455	Maltese	5966	Sindhi	6550	Volapuk	6861
Burmese	5971	Hungarian	5467	Maori	5955	Singhalese	6555	Welsh	4971
Byelorussian	4851	I-K		Marathi	5964	Slovak	6557	Wolof	6961
C-E		Icelandic	5565	Moldavian	5961	Slovenian	6558	Xhosa	7054
Cambodian	5759	Indonesian	5560	Mongolian	5960	Somali	6561	Yiddish	5655
Catalan	4947	Interlingua	5547	Nauru	6047	Spanish	5165	Yoruba	7161
Chinese	7254	Interlingue	5551	Nepali	6051	Sundanese	6567	Zulu	7267
Corsican	4961	Inupiak	5557	Norwegian	6061	Swahili	6569		
Croatian	5464	Irish	5347	O-R		Swedish	6568		
Czech	4965	Italian	5566	Occitan	6149				
Danish	5047	Japanese	5647	Oriya	6164				
Dutch	6058	Javanese	5669	Oromo (Afan)	6159				

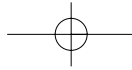

Display 53

English

You may adjust the TV Aspect ratio and Still Mode clarity, and Progressive Scan compatibility.

- 1** Press **DVD** to put the **DVD/VCR** in **DVD** mode. DVD light will appear on the front of the DVD/VCR.
- 2** When playback is stopped, press **SYSTEM/MENU**. The **QUICK SETUP** screen will appear.

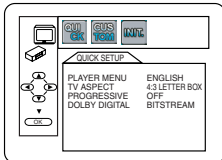

- 3** Press **◀** or **▶** to select **CUSTOM** at the top of the menu, then press **OK**.

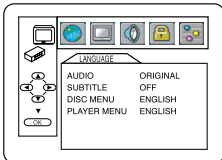

- 4** Press **◀** or **▶** to select **DISPLAY**, then press **OK**.

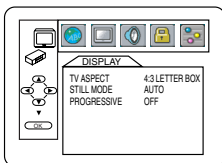

- 5** Press **▲** or **▼** to select an item, then press **OK**.

- If you selected **TV ASPECT**, press **▲** or **▼** to select a setting, then press **OK**.
Choose **4:3 LETTER BOX** if you want to see the entire, widened picture with black bars at the top and bottom of the screen. This looks like the picture you see when watching movies in a theater. This setting is possible only if the DVD was recorded in the letterbox or widescreen format.

- Choose **4:3 PAN & SCAN** for a full height picture, with both sides trimmed. Some companies refer to this as reformatting the picture to fit your TV screen and may call it the regular or normal format.

- Choose **16:9 WIDE** if you connected a widescreen TV to the DVD Player.

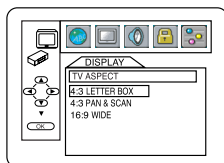

TV ASPECT

Instructions continue on the next page.

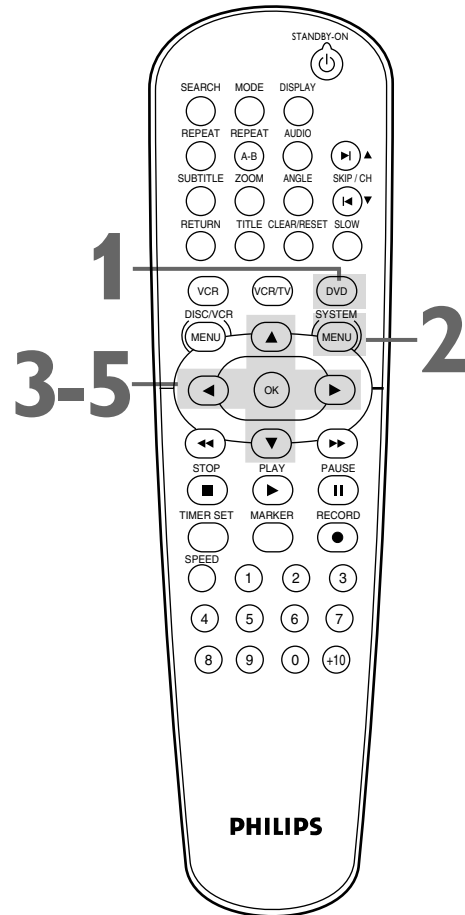

Helpful Hints

- Selecting a different **TV ASPECT** setting is only effective if it is available on the DVD. Check the DVD Disc menu or case for details.
- You also can adjust **TV ASPECT** in the **QUICK SETUP** menu that appears when you first press the **SYSTEM/MENU**. With **QUICK** selected, press **OK**. Press **▼** to select **TV ASPECT**, then press **OK**. Press **▲** or **▼** to choose a setting, then press **OK**. Press **SYSTEM/MENU** to remove the menu.

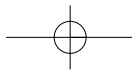

54 Display (cont'd)

Instructions continued from previous page

- If you selected **STILL MODE**, press **▲** or **▼** to select a setting, then press **OK**. This determines the quality of an image in still mode. **AUTO** is the default setting. If you select **FIELD**, still images will be stabilized but coarse due to the small amount of data. If you select **FRAME**, the images will be highly defined due to the simultaneous output of two fields.

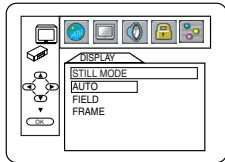

STILL MODE

- 6** Press **SYSTEM/MENU** to remove the menu.

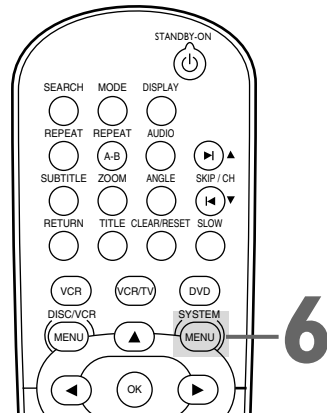

Progressive Scan

You may adjust the Progressive Scan compatibility.

- 1** Follow the steps 1-4 in the Display setup on page 53.

- 2** ● Press **▲** or **▼** to select **PROGRESSIVE**, then press **OK** repeatedly to turn **PROGRESSIVE ON** or **OFF**. The default setting is **OFF**. Choose **ON** if your TV has Progressive Scan and if the TV is connected to the Player's **COMPONENT VIDEO OUT** jacks. Choose **OFF** otherwise.

- 3** Press **SYSTEM/MENU** to remove the menu.

- If **PROGRESSIVE** is **ON**, this message appears:

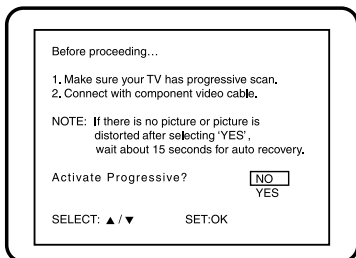

Press **▲** or **▼** to make a selection, then press **OK**. If you select **NO**, the menu disappears and **PROGRESSIVE** is **OFF**. If you select **YES**, this appears:

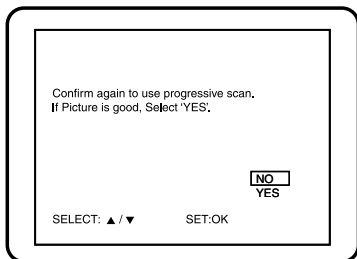

Confirm your setting, then press OK. The menu will disappear and **PROGRESSIVE** will be **ON**. If you do not press any buttons for 15 seconds, Progressive Scan will switch to **OFF**.

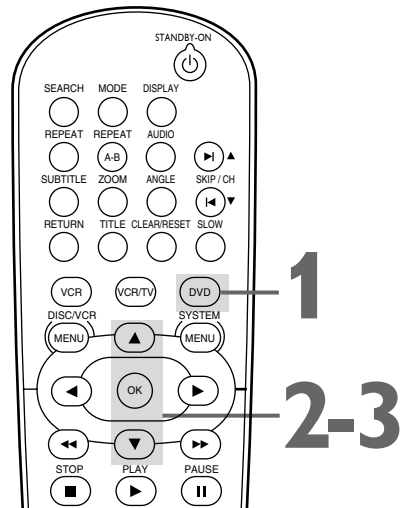

Helpful Hints

- You can set **PROGRESSIVE** to **OFF** either in the **DISPLAY** menu or by pressing and holding **PLAY** ► on the front of the Player for more than 5 seconds.
- You can adjust **PROGRESSIVE** in the **QUICK SETUP** menu that appears when you first press **SETUP**. With **QUICK** selected, press **OK**. Press **▼** to select **PROGRESSIVE**. Press **OK** to choose **OFF** or **ON**. Press **SETUP** to remove the menu.

Audio 55

Change Audio settings based on other equipment you connected to the DVD Player or according to your Disc sound features. These setting only affect the Audio from the DVD Player of the DVD/VCR.

1 Press DVD to put the DVD/VCR in DVD mode. DVD light will appear on the front of the DVD/VCR.

2 While playback is stopped, press SYSTEM/MENU. The QUICK SETUP screen will appear.

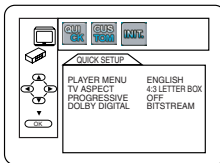

3 Press ◀ or ▶ to select CUSTOM at the top of the menu, then press OK.

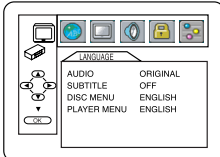

4 Press ◀ or ▶ to select AUDIO at the top of the menu, then press OK.

5 Press ▲ or ▼ to select DRC, DOWN SAMPLING, or DOLBY DIGITAL, then follow step 6 accordingly.

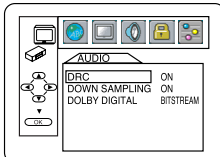

- 6**
- If you selected DRC, **press OK** repeatedly to turn Dynamic Range Control (DRC) ON or OFF. Choosing ON compresses the range of volume by suppressing loud sounds and raising low sounds. DRC is available only on Discs recorded in the Dolby Digital format.
 - If you selected DOWN SAMPLING, **press OK** repeatedly to choose ON or OFF. Choose ON to set downsampling to 48 kHz. Choose OFF to set downsampling to 96 kHz. DOWN SAMPLING is available only when the Player is connected to a Stereo using the COAXIAL DIGITAL AUDIO OUT jack as described on page 14.
 - If you selected DOLBY DIGITAL, **press OK** repeatedly to select BITSTREAM or PCM. Select BITSTREAM if you used the COAXIAL DIGITAL AUDIO OUT jack to connect the DVD Player to a stereo that is Dolby Digital compatible. Details are on page 14. Otherwise, choose PCM.

7 Press SYSTEM/MENU to remove the menu.

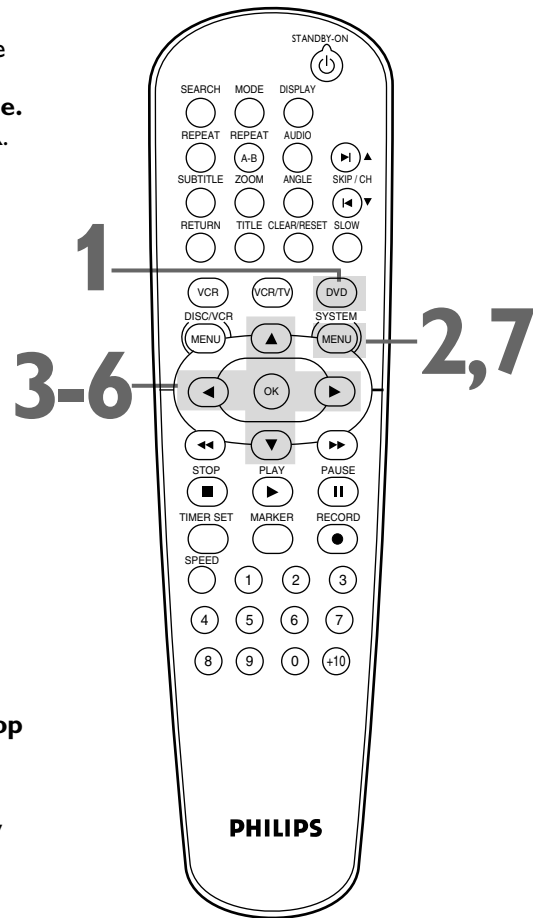

Helpful Hints

- Dolby Digital sound must be available on the DVD.
- You can adjust DOLBY DIGITAL in the QUICK SETUP menu that appears when you first press SYSTEM/MENU. With QUICK selected, press OK. Press ▼ to select DOLBY DIGITAL. Press OK to choose BITSTREAM or PCM. Press SYSTEM/MENU to remove the menu.
- When you play a Disc that has copyright protection, downsampling will be at 48 kHz, even if you set DOWN SAMPLING to OFF.

56 Parental Levels

Follow these steps to set the rating level for your DVDs. DVDs whose ratings exceed the level you set will not play.

- 1 Press DVD to put the DVD/VCR in DVD mode.**
DVD light will appear on the front of the DVD/VCR.
- 2 While playback is stopped, press SYSTEM/MENU.**
The QUICK SETUP screen appears.

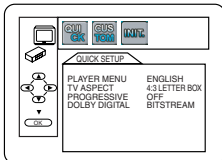

- 3 Press ◀ or ▶ to select CUSTOM at the top of the menu, then press OK.**

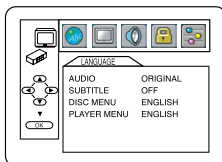

- 4 Press ◀ or ▶ to select PARENTAL, at the top of the menu, then press OK.**

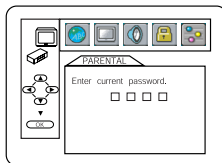

- 5 Press the Number buttons to enter your 4-digit password.**

- 6 Press ▲ or ▼ to select PARENTAL LEVEL, then press OK.**

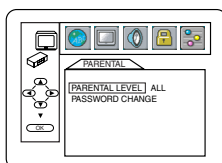

- 7 Press ▲ or ▼ to select a level, then press OK.**
The rating levels continue on two menu screens. Press ▲ or ▼ repeatedly to move to the next or previous screen to find the rating level you want.
After making your selection, the previous menu will appear. The level you selected will appear beside PARENTAL LEVEL.

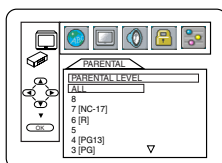

- 8 Press SYSTEM/MENU to remove the menu.**

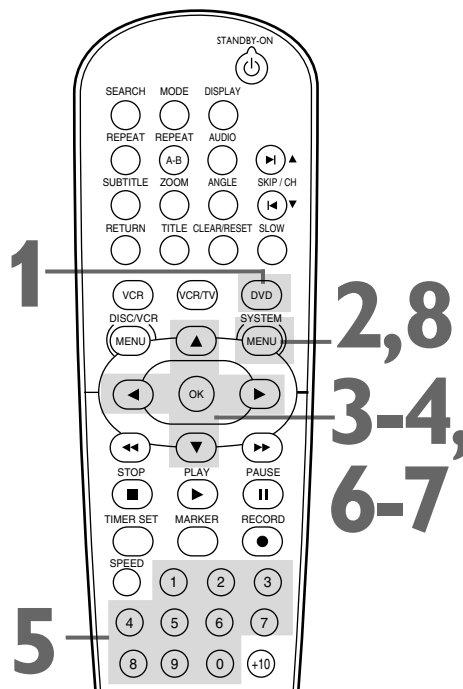

RATING EXPLANATIONS	
• ALL - Parental Controls is inactive; all discs can play.	• 4 - PG13 - Unsuitable for children under 13
• 8 - Adult material	• 3 - PG - Parental Guidance suggested.
• 7 - NC-17 - Not appropriate for children under 17	• 1- G - General Audience; recommended for all ages.
• 6 - R - Restricted; parental approval required for viewers under 18.	

Helpful Hints

- When you try to play a DVD whose rating exceeds the level you set, an on-screen message will indicate the DVD cannot play. Remove the DVD, then set PARENTAL LEVEL to ALL. Reload the DVD and begin playback. Some DVDs may let you enter your 4-digit password to begin playback. Follow the on-screen messages as prompted.
- You cannot use the default password (4737) to play a DVD.

Parental Password 57

Parental Controls prevents viewing of DVDs that exceed your rating limits. This feature will not limit viewing if the DVD is not rated or coded. Check your DVDs and settings before letting children access the DVD/VCR. You will need a password to change the Parental settings or to play a blocked Disc. Follow these steps to change your password.

- 1** Press **DVD** to put the DVD/VCR in DVD mode. DVD light will appear on the front of the DVD/VCR.
- 2** While playback is stopped, press **SYSTEM/MENU**. The QUICK SETUP screen appears.

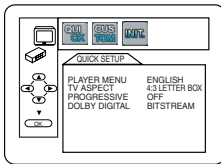

- 3** Press **◀** or **▶** to select **CUSTOM**, then press **OK**.

- 4** Press **◀** or **▶** to select **🔒 (PARENTAL)**, then press **OK**. The first time you set a password, this menu will appear.

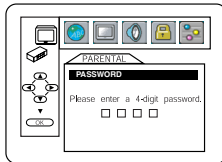

Press the **Number** buttons to enter a **4-digit password**. The password will appear on the screen. Write it down so you will not forget it.

Press **OK**, and proceed to step 7.

If you have set a password before, this menu will appear.

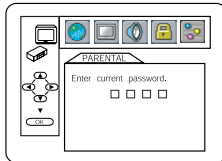

Press the **Number** buttons to enter your **current four-digit password**. Asterisks (*) will appear instead of your password. This protects its identity.

- 5** Press **▼** to select **PASSWORD CHANGE**, then press **OK**.

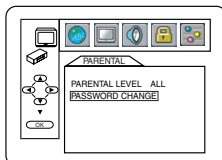

- 6** Press the **Number** buttons to enter a **4-digit password**. The password numbers will appear on the screen. Write down the password so you will not forget it. Press **OK**. The previous menu will reappear.

- 7** Press **SYSTEM/MENU** to remove the menu.

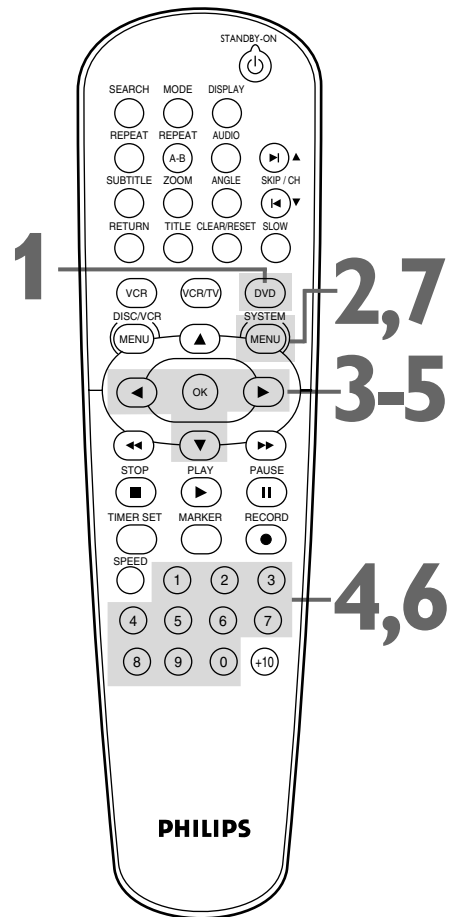

Helpful Hints

- The default password is 4737. If you forget your password, press Number buttons 4, 7, 3, 7 at step 4. You will be prompted to enter a new 4-digit password. Use the Number buttons to enter a new 4-digit password, then press OK. PARENTAL LEVEL will reset to ALL. See page 56 to reset PARENTAL LEVEL as you desire.
- A power failure will not erase your password.

58 Others

You may adjust the Angle Icon availability, Automatic Power Off, and the brightness of the Player's display panel.

- 1** Press **DVD** to put the **DVD/VCR** in **DVD** mode. DVD light will appear on the front of the DVD/VCR.
- 2** While playback is stopped, press **SYSTEM/MENU**. The **QUICK SETUP** screen appears.

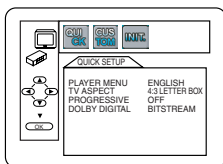

- 3** Press **◀** or **▶** to select **CUSTOM** at the top of the menu, then press **OK**.

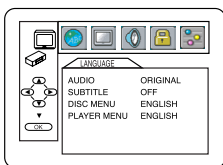

- 4** Press **◀** or **▶** to select **OTHERS**, then press **OK**.

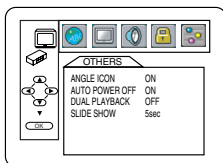

- 5** Press **▲** or **▼** to select an item, then press **OK**.

- If you selected **ANGLE ICON**, press **OK** repeatedly to select **ON** or **OFF**. The default setting is **ON**. Choose **ON** to see the Angle icon when multiple camera angles are available during DVD play. Details are on page 42. Choose **OFF** to disable the Angle icon.

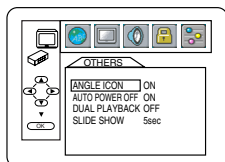

ANGLE ICON

Instructions continue on the next page.

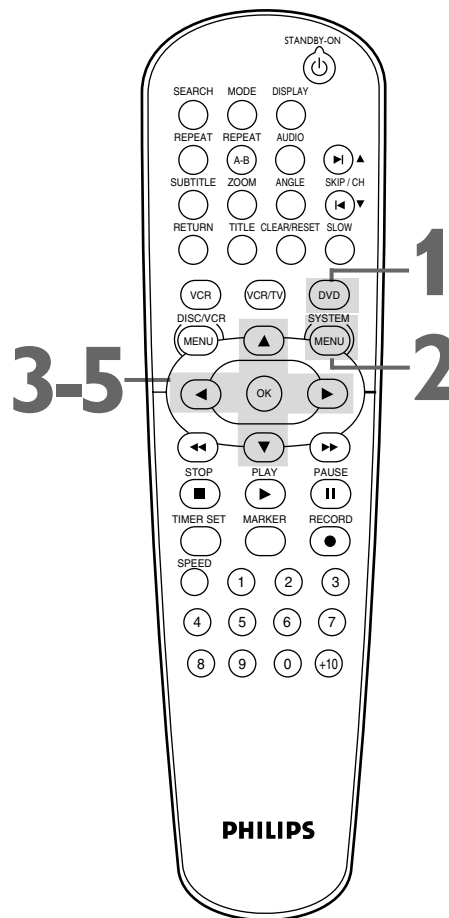

Others (cont'd) 59

Instructions continued from previous page

- If you selected **AUTO POWER OFF**, press **OK** repeatedly to choose **ON** or **OFF**. The default setting is **ON**. Choose **ON** if you want the Player to turn off when there is no activity at the Player or its remote for 30 minutes.

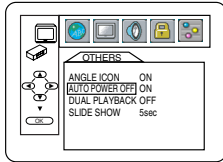

AUTO POWER OFF

- If you selected **DUAL PLAYBACK**, press **OK** to choose **ON** or **OFF**. This feature lets you play **MP3 Tracks and JPEG Files simultaneously**.

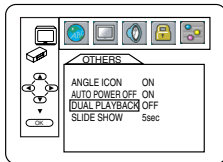

DUAL PLAYBACK

- If you selected **SLIDE SHOW**, press **▲** or **▼** to choose **5sec**, **10sec**, or **MUSIC**, then press **OK**. This adjusts the playback speed of the **SLIDE SHOW**. The default setting is 5 sec. Choose 5 sec to display each image for 5 seconds. Choose 10 sec to display each image for 10 seconds. Choose **MUSIC** to display an image for each MP3 sound file playback when **DUAL PLAYBACK** is **ON**.

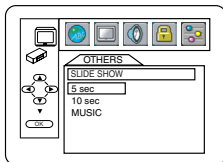

SLIDE SHOW

6 Press **SYSTEM/MENU** to remove the menus.

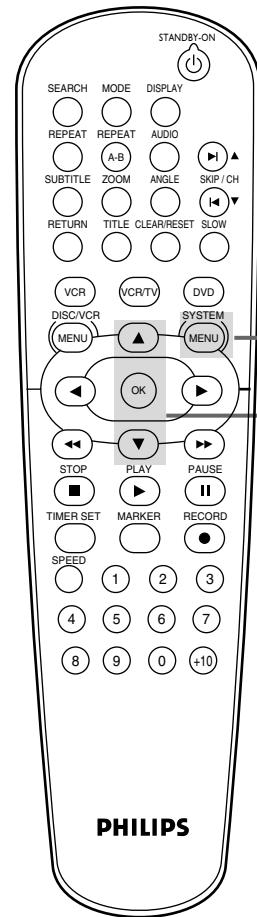

Helpful Hint

- If you select **MUSIC** when **DUAL PLAYBACK** is **OFF**, the playback speed will be set to 5 seconds automatically.

60 Glossary

AUDIO IN/OUT Jacks: jacks on the front and back of the DVD/VCR that receive audio from another source (IN) or send audio to another system (OUT). These jacks are red (right) and white (left).

Automatic Channel Setup: process in which the VCR memorizes all available TV channels. Then, when you press SKIP ►/CH ▲ or SKIP ◀/CH ▼ in VCR mode, you only scan through channels you receive.

Bands: settings that allow you to tune channels.

- **Antenna** – VHF (very high frequency; channels 2-13) and UHF (ultra high frequency; channels 14-69).
- **Cable** – standard channels 1-125 can be available without a Cable Box.

Cable Box/Satellite Receiver Output Channel: 03 or 04.

COAXIAL DIGITAL AUDIO OUT jack: Sends digital audio to a Stereo, allowing you to adjust the volume at the Stereo. This connection provides the 5.1 channel surround sound as heard in movie theaters. This jack on the DVD/VCR is black.

COMPONENT VIDEO OUT (Y C_B/P_B C_R/P_R) Jacks: jacks on the back of the DVD/VCR that send high-quality DVD video to a TV with Component Video In jacks. This connection provides the best picture quality for the DVD Player of the DVD/VCR.

Dolby Digital: A surround sound system that provides 5.1 channel sound as used in movie theaters.

Dubbing: copying a video cassette using another VCR.

HQ: high quality; a feature in the VCR circuitry which provides enhanced picture detail.

Line Input: The channel to which you set your DVD/VCR during video cassette copying. If you connected the other video equipment to the AUDIO and VIDEO In jacks on the front of the DVD/VCR, select L2. If you used the AUDIO and VIDEO IN jacks on the back of the DVD/VCR, select L1. If you accidentally enter Line Input mode, press SKIP ►/CH ▲ or SKIP ◀/CH ▼ or the Number buttons to select another channel.

OTR: One-Touch Recording; a timed recording on the VCR that starts immediately and records for 30 minutes to 8 hours.

RF coaxial cable: A black cable supplied with your DVD/VCR. Use it to connect your DVD/VCR to your TV, Cable Box, or Satellite Receiver.

S-Video: Produces a clearer DVD picture by sending separate signals for the luminance and the color. S-Video only provides a picture for the DVD Player of the DVD/VCR.

Tape Speeds: how fast the video cassette travels during a recording or playback. The faster the tape speed, the better the picture quality. Slower tape speeds affect picture quality, but you can record more onto a videotape.

- **SP** (standard playback) – fastest tape speed (recording time for a T120 tape is approximately 2 hours); best picture quality.
- **LP** (long playback) – average tape speed. You cannot record in LP with this VCR. If tapes were recorded on a different VCR in LP speed, the tape will play in LP on the DVD/VCR.
- **SLP** (super long playback) – slowest tape speed (recording time for a T120 tape is approximately 6 hours). This speed allows the maximum recording on a single videotape.

VIDEO IN/OUT Jacks: jacks on the front and back of the DVD/VCR that receive video from another source (IN) or send video to other video equipment or a TV (OUT). These jacks are yellow.

Helpful Hints 61

If you are having problems with your product, check this list of problems and possible solutions before requesting service. You may be able to solve the problem yourself.

If you need to call a customer service representative, please know the model number and serial number of your product before you call. This information is displayed on the back of the product. Also, please take a moment to identify the problem you are having, and be prepared to explain this to the representative. If you believe the representative will need to help you with operations, please stay near the product. Our representatives will be happy to assist you.

For online reference, please visit our web site at <http://www.philips.com/support>

The DVD/VCR has no power.

- Make sure the power cord is connected completely to an AC (alternating current) outlet.
- Press STANDBY-ON  to turn on the DVD/VCR. The DVD/VCR usually turns on in the mode it was in when you turned it off. If there has been a power failure, it will turn on in VCR mode. Press DVD to put the unit in DVD mode. Press VCR to put the unit in VCR mode. Or, press SOURCE on the front of the DVD/VCR to switch between the two modes.

The remote control will not operate the DVD/VCR.

- Aim the remote control directly at the remote sensor on the front of the DVD/VCR, not toward the TV. *Details are on page 20.*
- Remove all obstacles between the remote control and the DVD/VCR.
- Inspect and/or replace the batteries in the remote control. *Details are on page 15.*
- Use the remote control within 23 feet of the DVD/VCR.
- When using the DVD Player, press the DVD button, then try the other DVD feature buttons. Press DVD so DVD light appears on the front of the DVD/VCR. This means the DVD/VCR is in DVD mode.
- To use the VCR, press VCR, then try the other VCR feature buttons. Press VCR so VCR light appears on the front of the DVD/VCR. This means the DVD/VCR is in VCR mode.

There is no picture in DVD mode.

- Make sure the video cable is connected correctly. You may connect either the yellow video cable (supplied), an optional S-Video cable, or optional component video cables. Make sure the TV is set to the correct Video In channel (usually the AUX IN, A/V IN, Auxiliary In, EXT or External In, Component Video In, or S-Video In channel). Check your TV owner's manual for details. *Details are on pages 8 and 12-14.*
- If you only used the supplied black RF coaxial cable, *details are on pages 9-11.* Make sure the TV is set to channel 3 or 4 (the output channel of the DVD/VCR). Or, if you have a Cable Box/Satellite Receiver, make sure the TV is set to the Cable Box/Satellite Receiver output channel (usually 03 or 04).
- Insert a DVD that is playable on this DVD/VCR. *Details are on page 7.*
- Make sure the DVD/VCR is in DVD mode. Press DVD or SOURCE so DVD light appears on the front of the DVD/VCR.
- Check if Progressive Scan is set correctly according to your connection to a TV. *Details are on page 8.* Enable Progressive Scan at the DVD Player only if you used the Component Video connection to a TV that has Progressive Scan. *Details are on pages 8, 12, and 54.*

Disc cannot be played.

- Insert a playable Disc. *Details are on page 7.*
- Place the Disc correctly in the Disc tray. If the Disc is one-sided, place the Disc in the tray with the label facing up. If the Disc is two-sided, make sure the label of the side you want to play is facing up.
- Clean the Disc. Make sure the Disc is not scratched or warped.
- Cancel the Parental Controls, enter the password, or change the control level. *Details are on pages 56-57.*
- Make sure the Disc is labelled for use in Region 1 or ALL regions and is NTSC or PAL compatible. *Details are on page 7.*

There is no sound.

- Connect the audio cables firmly. Make sure the cables are connected to the AUDIO IN jacks on the TV or Stereo. *Details are on pages 12-13.*
- Check the audio settings of the DVD Player. *Details are on page 55.*
- Check the audio settings of the DVD. For example, you may have selected "soundtrack" playback or an unavailable sound setting (such as Dolby Digital). *Details are on pages 43 and 55.* Try other sound options provided in the DVD Disc menu.
- If you used audio cables (instead of only using the supplied black RF coaxial cable) make sure the TV or Stereo is set to the correct Audio In channel (usually the AUX IN, Auxiliary In, A/V IN, Audio In, or External In channel). See your TV or Stereo owner's manual for details.

The picture is distorted.

- Connect the DVD/VCR directly to the TV. *Details are on pages 8-14.* Do not connect the DVD/VCR to a VCR, then connect the VCR to the TV. Copyright protection systems in the VCR could distort the picture playing on the DVD/VCR.
- There are some cases where a Disc or videotape picture may be distorted slightly because of the quality in which it was recorded. This is not a malfunction of the DVD/VCR.
- Make sure the Disc is compatible with the DVD Player of the DVD/VCR. *Details are on page 7.*
- If your TV is not PAL compatible, DVDs recorded in the PAL color system may play only in black and white, the picture may roll continuously, or the picture may appear distorted.

62 Helpful Hints (cont'd)

You cannot change the camera angle of a DVD.

- The DVD might not contain segments recorded from different camera angles. See if multiple angles are available by referring to the Disc case or DVD Disc menu. *Details are on page 42.*

You cannot change the audio or subtitle language of a DVD.

- The DVD does not contain audio or subtitles in the desired language. Not all DVDs contain audio or subtitles in multiple languages. See if other languages are available by referring to the Disc case or DVD Disc menu. *Details are on pages 42-43.*

An X appears in the top right corner of the TV screen when you try a DVD feature.

- The operation is not available at the current time or the feature is not available on the Disc. Some features are only available during playback. Others can be accessed only if playback is stopped. Try stopping or playing the Disc, then try the feature again.

The DVD/VCR switches from DVD mode to VCR mode after 30 minutes of no activity.

- When AUTO POWER OFF is set to ON, the DVD/VCR switches itself from DVD mode to VCR mode if Disc playback stops for more than 30 minutes and you press no buttons on the remote or the DVD/VCR. *Details are on pages 58-59.* This prevents possible damage to your TV's picture tube that can occur if a still image is left on too long.

A screen saver appears on the TV screen during DVD mode.

- The DVD logo will appear on the TV screen when you stop Disc playback. You cannot remove it.

You want to use the DVD Player during a VCR timer recording or while "⏏" appears on the display panel.

- Press STANDBY-ON  to turn on the DVD/VCR. Press DVD to choose DVD mode, then continue with other DVD features as described in this manual.

A maximum of 999 MP3/JPEG Files can be recognized.

Power Failure

- Clock setting, language selection, and channel setup may be lost if the power fails. See pages 21-23 to set up the channels, clock, and language again.

The VCR will not record a TV program.

- Put the DVD/VCR in VCR mode. Press VCR or SOURCE so VCR light appears on the front of the DVD/VCR.
- Check the connections between the DVD/VCR, TV, antenna/Cable TV signal, and Cable Box/Satellite Receiver (if applicable). *Details are on pages 9-14.* For VCR features, you must connect the DVD/VCR to a TV with the RF coaxial cable or the yellow video cable as described on pages 9-12.
- Make sure the video cassette has a record tab. *Details are on page 24.*

The VCR will not perform a timer recording.

- Make sure the recording start and stop times are set correctly. *Details are on pages 28-29.*
- Make sure a tape is in the VCR and the tape has a record tab. *Details are on page 24.* If, after programming a timer recording, you press TIMER SET without putting a tape in the DVD/VCR, "⏏" will blink on the display panel.
- If the record tab on a tape is missing, the DVD/VCR will eject the tape. "⏏" will blink.
- Press TIMER SET to put the DVD/VCR in standby mode for the timer recording.
- Make sure the VCR clock is set. *Details are on page 22.*
- The VCR may not perform or continue a timer recording if the power fails.
- If you have a Cable Box/Satellite Receiver, set timer recordings differently. *Details are on page 10.*
- Finish programming a timer recording at least 5 minutes before it is set to begin.
- 12 p.m. is noon; 12 a.m. is midnight.

There is no picture or the picture is noisy or has streaks during video cassette playback.

- Put the DVD/VCR in VCR mode. Press VCR or SOURCE so VCR light appears on the front of the DVD/VCR.
- If you used the supplied RF coaxial cable to connect the DVD/VCR to the TV, make sure the TV is on the same channel as the DVD/VCR's output channel (03 or 04). The DVD/VCR's output channel is channel 3 when you receive it. To change it to channel 4, see page 9. Make sure channel 03 or 04 is properly adjusted at the TV.
Or, if you connected the DVD/VCR to the TV using audio and video cables, select the correct Video In channel at the TV. *Details are on pages 8 and 12.*
- Adjust the tracking. *Details are on page 33.*
- TVs placed too close to the DVD/VCR can cause interference during tape playback. Move the DVD/VCR away from the TV.

The Number buttons won't work for TV channels above 69.

- Enter channel numbers as a 2-digit number. If you want to select channels 100 and above, enter channel numbers as a 3-digit number. If you do not have Cable TV, only channels 2-69 are available.

TV programs cannot be watched normally.

- Check the connections between the DVD/VCR, TV, antenna/Cable TV signal, and Cable Box/Satellite Receiver (if applicable). *Details are on pages 9-14.*

Poor reception

- You may need to tune your TV again. Or, reset channels at the VCR using CHANNEL SET UP. *Details are on page 21.*

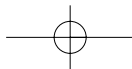

Helpful Hints (cont'd) 63

You cannot insert a video cassette.

- Insert the tape, window side up, with the record tab facing you.
- Make sure a tape isn't already in the VCR by pressing STOP/EJECT ■▲ (VCR) on the front of the DVD/VCR.
- Gently push on the center of the tape when putting it in the VCR. Never force the tape into the VCR.
- If a timer recording is set, you cannot insert a tape without a record tab.

You cannot remove the tape.

- Make sure the power plug is completely connected to a power outlet.
- If you have set a timer recording, press TIMER SET to delay the recording. "□" will disappear from the display panel. Then, press STOP/EJECT ■▲ (VCR) on the front of the DVD/VCR to eject the tape. Insert another tape and press TIMER SET to reset the timer recording.
- Unplug the DVD/VCR power cord for 5 minutes. Then, plug in the power cord again and press STANDBY-ON ○ on the DVD/VCR. Press STOP/EJECT ■▲ (VCR) on the DVD/VCR 3 to 5 times. If the tape still does not eject, you may need to have an authorized servicer remove the tape.

DVD/VCR ejects the tape when you press RECORD ● or TIMER SET.

- Make sure the tape has a record tab. *Details are on page 24.*

Satellite Receiver Hookups

- Watching one TV channel while recording another may not be possible if you have a Satellite Receiver. Set your TV to channel 03 or 04, then make your channel selections at the Satellite Receiver.
- With many Satellite Receiver hookups, if you use audio and video cables to connect your DVD/VCR to your TV, you will have to put your DVD/VCR in Line Input mode (L1 or L2).

Line Input mode

- If you accidentally enter Line Input mode (L1 or L2 will appear on your TV screen briefly), press SKIP ►/CH ▲ or SKIP ◀/CH ▼ or the Number buttons to select another channel.

Hi-Fi Stereo Sound

- During playback, Hi-Fi audio may normally revert to normal audio when you adjust tracking.
- When connecting the DVD/VCR to a TV with the red and white audio cables, you will only get stereo sound if you connect the DVD/VCR AUDIO OUT jacks on the DVD/VCR to the AUDIO IN jacks on your TV, and if the TV is on its Audio/Video In channel. See your TV owner's manual for details.
- When you connect the DVD/VCR AUDIO OUT jacks on the DVD/VCR to the AUDIO IN jacks on your TV, the stereo light on the TV might not glow. If the status display indicates you are receiving stereo, you are. *Details are on page 34.*
- Only tapes recorded in Hi-Fi audio will play in Hi-Fi audio. Tapes recorded in normal audio will play in monaural (single-channel) audio.

Cleaning the Video Heads

- Your DVD/VCR automatically cleans the video heads of the VCR each time you insert a tape. However, the heads may become dirty. If so, have an authorized servicer clean the video heads. Eventually, the heads may need to be replaced.

The playback picture is too dim, too bright, or fluctuates in brightness.

- Some programs may be broadcast with copyright protection technology in order to protect the rights of copyright owners. This technology is used on programs that are recorded on video cassettes or DVDs, as well as some programs broadcast by antenna/cable/satellite television channels. Programs broadcast with copyright protection may not record clearly. Likewise, if you play a tape that is a recording of a copyright protected program, the picture may not be clear. Tapes of copyright protected programs may have a picture that is dark or dim, or the brightness of the picture may fluctuate. Therefore, avoid recording or playing copies of copyright protected programs.
- This DVD/VCR incorporates copyright protection technology that is protected by method claims of certain U.S. patents and other intellectual property rights owned by Macrovision Corporation and other rights owners. Use of this copyright protection technology must be authorized by Macrovision Corporation and is intended for home and other limited viewing uses only, unless otherwise authorized by Macrovision Corporation. Reverse engineering or disassembly is prohibited.

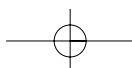

64 Care and Maintenance

Cleaning the DVD/VCR

- Wipe the front panel and other exterior surfaces of the DVD/VCR with a soft, slightly damp cloth.
- Never use a solvent, thinner, benzene, or alcohol to clean the DVD/VCR. Do not spray insecticide liquid near the DVD/VCR. Such chemicals may discolor the surface or damage the DVD/VCR.

Cleaning a Disc

- Use a soft, dry cloth to wipe the Disc.
- Wipe the Disc in a straight line from the center to the edge. Never wipe the Disc in a circular motion.
- Do not use detergent or abrasive cleaning agents.
- Handle the Discs so fingerprints and dust do not adhere to the Discs.
- Always store the Disc in its protective case when it is not in use.

Checking the Laser

- If the DVD/VCR does not operate as described in this manual, the DVD Player's laser may be dirty. Consult an Authorized Service Center for inspection and cleaning of the laser.

Caring for Video Cassettes

- Use only cassettes with the **VHS** mark.
- Remove any light adhesive stick-on notes from the video cassette before putting the cassette in the VCR. Removable labels can jam the VCR.

Caring for the VCR's Video Heads

- Periodic maintenance is required to maintain your DVD/VCR's excellent performance. The VCR has an Automatic Head Cleaner. However, the video heads will require replacement eventually. Only an authorized service center should perform this service.

Specifications

VCR Video Heads

4 heads - Hi-Fi

Antenna

VHF/UHF – 75 ohm external antenna terminal

VHF Output Signal

Channel 03 or 04
75 ohms unbalanced

DVD Color System

NTSC

Frequency Response

DVD (linear sound):
20 Hz to 22 kHz (sample rate: 48 kHz)
20 Hz to 44 kHz (sample rate: 96 kHz)
Audio CD: 20 Hz to 20 kHz

Signal-to-Noise Ratio

Audio CD: 100 dB JEITIA
(Japan Electronics and Information Technology Industries Association)

Dynamic Range

DVD (linear sound): 90 dB
Audio CD: 85 dB (JEITIA)

Total Distortion Factor

Audio CD: 0.008% (JEITIA)
DVD: 0.008%

Wow and Flutter

Below the measurement limitation
(±0.001% W PEAK) (JEITIA)

Power Requirement

120V AC +/- 10%, 60 Hz +/- 0.5%

Power Consumption

Power on: 21 W
Power off: 3.8 W

Operating Temperature

41°F (5°C) to 104°F (40°C)

Relative Humidity

30% to 80%

Dimensions

17-3/16" (W) x 3-3/4" (H) x 9-3/16" (D)
(435mm x 94mm x 233mm)

Weight

6.0 lbs. (2.7 kg.)

NOTE: Designs and specifications are subject to change without notice.

Limited Warranty 65

English

PHILIPS LIMITED WARRANTY

Ninety (90) Days Free Product Exchange Ninety-One (91) Days-One (1) Year Reduced-Cost Exchange

PHILIPS CONSUMER ELECTRONICS warrants this product against defect in material or workmanship, subject to any conditions set forth as follows:

PROOF OF PURCHASE:

You must have proof of the date of purchase to exchange the product. A sales receipt or other document showing the product and the date that you purchased the product as well as the authorized retailer included, is considered such proof.

COVERAGE:

Warranty coverage begins the day you buy your product. For a period of ninety (90) days from the date of purchase, if the product is determined to be defective, Philips will exchange the defective product with a new or renewed product, at its option, at no charge.

From ninety-one (91) days to one year from the date of purchase, you will pay a preset exchange fee to obtain a new or renewed product. Contact the Customer Care Center for limited exchange pricing. This exchange opportunity ends one year after the date of purchase. The replacement product is covered only for the warranty period of the original product. When the warranty on the original product expires, the warranty on all replaced products also expires. When it is necessary for you to ship the product to Philips for exchange, you will pay the shipping cost for shipment to Philips. Philips will pay the shipping costs when returning a product to you.

Note: The exchange model supplied will be the most comparable one in Philips current inventory. Shipping of your product to Philips implies intent to follow the specified requirements of the warranty and exchange program. Product received by Philips cannot be returned. Replacement product can only be sent if all warranty requirements are met. Failure to follow all requirements can result in delay of exchange process.

EXCLUDED FROM WARRANTY COVERAGE

Your warranty does not cover:

- Shipping charges to return defective product.
- Labor charges for installation or setup of the product, adjustment of customer controls on the product, and installation or repair of antenna systems outside of the product.
- Product repair and/or part replacement because of improper installation, connections to improper voltage supply, abuse, neglect, misuse, accident, unauthorized repair or other cause not within the control of Philips.
- Damage occurring to product during shipping when improperly packaged or cost associated with packaging.

- A product that requires modification or adaptation to enable it to operate in any country other than the country for which it was designed, manufactured, approved and/or authorized, or repair of products damaged by these modifications.
- A product used for commercial or institutional purposes (including but not limited to rental purposes).
- Product lost in shipment and no signature verification receipt can be provided.
- Products sold AS IS or RENEWED.

WHERE WARRANTY EXCHANGE IS AVAILABLE:

Exchange is available in all countries where Philips officially distributes the product. In countries where Philips does not distribute the product, the local Philips organization will attempt to exchange the product, although there may be a delay if the appropriate product is not readily available, or special customs processes are implied.

FOR EXCHANGE IN THE U.S.A., PUERTO RICO, OR U.S. VIRGIN ISLANDS...

Contact Philips Customer Care Center at:
1-888-PHILIPS (1-888-744-5477)

FOR EXCHANGE IN CANADA...

1-800-661-6162 (French Speaking)
1-888-PHILIPS (1-888-744-5477) - (English or Spanish Speaking)

REPLACEMENT AS PROVIDED UNDER THIS WARRANTY IS THE EXCLUSIVE REMEDY FOR THE CONSUMER. PHILIPS SHALL NOT BE LIABLE FOR ANY INCIDENTAL OR CONSEQUENTIAL DAMAGES FOR BREACH OF ANY EXPRESS OR IMPLIED WARRANTY ON THIS PRODUCT. EXCEPT TO THE EXTENT PROHIBITED BY APPLICABLE LAW, ANY IMPLIED WARRANTY OF MERCHANTABILITY OR FITNESS FOR A PARTICULAR PURPOSE ON THIS PRODUCT IS LIMITED IN DURATION TO THE DURATION OF THIS WARRANTY.

Some states do not allow the exclusions or limitation of incidental or consequential damages, or allow limitations on how long an implied warranty lasts, so the above limitations or exclusions may not apply to you. In addition, if you enter into a service contract agreement with the PHILIPS partnership within ninety (90) days of the date of sale, the limitation on how long an implied warranty lasts does not apply.

This warranty gives you specific legal rights. You may have other rights which vary from state/province to state/province.

Philips, P.O. Box 671539, Marietta, GA. 30006-0026

(Warranty: 4835 710 27475)

66 Information Index

- ac power cord20
- angle button20, 42
- angle icon42, 58
- ant-in (antenna in) jack9-14, 20
- ant-out (antenna out) jack9-11, 20
- arrow buttons20
- audio button20, 43
- audio in/out jacks12-13, 20, 27
- audio settings55
- auto power off58-59
- auto repeat31
- automatic
 - tape playback33
 - tape rewind, eject33
- a-b repeat40
- a-b repeat button20, 40

- batteries15
- bit-rate display48
- black level50

- camera angle42
- cassette compartment19
- channel
 - adding21
 - deleting21
 - selection20
 - setup16, 21
- chapters37
- clear/reset button20, 31
- clock22
- coaxial digital audio out jack14, 20
- component video out jacks12, 20
- connections8-14
- contents, table of5
- controls
 - dvd/vcr20
 - remote20
- copyright protection3, 27, 63
- counter23, 31

- disc menus35, 51
- disc tray19
- disc/vcr menu button20, 35
- display button20, 23, 48
- display messages19
- display panel19
- displays23, 48-49
- dual playback47
- dolby digital55
- down sampling55
- drc (dynamic range control)55
- duplication (dvd to videotape)30
- duplication (tape)27
- dvd button20
- dvd light19

- ejecting a tape20, 33, 63

- fast forward33, 36
- ▶▶ (fast forward) button20
- folder playback47
- front panel20

- glossary60

- head cleaner63
- helpful hints61-63
- hi-fi stereo sound34

- hookups
 - cable box/satellite receiver10-11
 - component video12
 - S-video12
 - stereo13-14
 - tv9-14

- index search32
- initializing50

- jpeg display49
- jpeg playback46-47

- language (dvd)51-52
- language (vcr)23
- line input mode27, 63
- long playback60
- lp60

- markers41
- menus6, 35
- mode button20, 45
- mp3 display49
- mp3 playback46-47

- number buttons20

- ok button20
- on-screen status displays (vcr)23
- one-touch recording26
- open/close ▲ button18, 20

- parental controls56-57
- password57
- pause button20, 33, 39, 44
- play button17-18, 20
- player menu51
- playing discs18
- playing tapes17
- power
 - cord20
 - on light20
- program45
- progressive scan54

- quick setup51-55

- random45
- rear panel20
- record ● button20, 24, 26
- recording
 - basic24
 - one channel/watching another25
 - prevention24
 - timer28-29
- remote control
 - batteries15
 - buttons20
 - sensor20
- repeat button20, 40
- repeat (discs)40
- repeat (tape)31
- rerecording27
- resume on39
- return button20
- reverse searching33, 36
- ◀◀ (rewind) button20, 33, 36
- rf coaxial cable9-11
- safety precautions4

- sap (second audio program)34
- search button20, 32, 37-38
- searching33, 36
- sensor (remote)20
- skip ▶/ch ▲, skip ◀/ch ▼20, 38
- slow button20, 33
- slow motion33, 44
- slp60
- source button20
- sp60
- specifications64
- speed button20, 24
- standard playback60
- standby-on ⏻ button20
- status display (vcr)23
- step-by-step playback39
- stereo broadcast
 - hookups13-14
 - receiving/recording34
- stereo sound43
- stereo TV hookups13-14
- still mode54
- still picture33, 39
- stop ■ button20
- stop/eject ■▲ (vcr) button20
- subtitle button20, 42
- super high speed searching33
- super long playback60
- s-video out jack12, 20

- table of contents5
- tape
 - duplication27
 - eject20, 33, 63
 - speed60
 - time search32
 - timer recording
 - cancelling29
 - setting28-29
 - timer set button20, 29
 - title button20, 35
 - titles35
 - tracking33
 - tracks38
 - tv aspect53-54
 - tv hookups9-14

- vcr
 - button20
 - light19
 - vcr/tv button20
 - video in/out jacks12-14, 20
 - virtual surround50

- warranty65
- Windows Media™ Audio display49
- Windows Media™ Audio playback46-47

- zoom44
- zoom button20, 44



This owner's manual is made of recyclable materials. Remember to recycle!

Free Manuals Download Website

<http://myh66.com>

<http://usermanuals.us>

<http://www.somanuals.com>

<http://www.4manuals.cc>

<http://www.manual-lib.com>

<http://www.404manual.com>

<http://www.luxmanual.com>

<http://aubethermostatmanual.com>

Golf course search by state

<http://golfingnear.com>

Email search by domain

<http://emailbydomain.com>

Auto manuals search

<http://auto.somanuals.com>

TV manuals search

<http://tv.somanuals.com>