

**DVD VIDEO PLAYER /
VIDEO CASSETTE RECORDER**



**Owner's Manual
Manuel de l'utilisateur
Bedienungsanleitung
Gebruiksaanwijzingen
Istruzioni per l'uso
Manual del usuario
Εγχειρίδιο χρήσης
Manual proprietário**

PHILIPS

Safety Precautions



CAUTION
 RISK OF ELECTRIC SHOCK
 DO NOT OPEN



CAUTION: TO REDUCE THE RISK OF ELECTRIC SHOCK

DO NOT REMOVE COVER (OR BACK)
 NO USER-SERVICEABLE PARTS INSIDE
 REFER SERVICING TO QUALIFIED SERVICE PERSONNEL.



This lightning flash with arrowhead symbol within an equilateral triangle is intended to alert the user to the presence of uninsulated dangerous voltage within the product's enclosure that may be of sufficient magnitude to constitute a risk of electric shock to persons.



The exclamation mark within an equilateral triangle is intended to alert the user to the presence of important operating and maintenance (servicing) instructions in the literature accompanying the product.

WARNING: TO REDUCE THE RISK OF FIRE OR ELECTRIC SHOCK, DO NOT EXPOSE THIS PRODUCT TO RAIN OR MOISTURE.

WARNING: Do not install this equipment in a confined space such as a book case or similar unit.

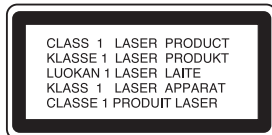

CAUTION:

This Digital Video Disc Player employs a Laser System.

VISIBLE AND INVISIBLE LASER RADIATION WHEN OPEN AND INTERLOCKS DEFEATED.

To ensure proper use of this product, please read this owner's manual carefully and retain for future reference, should the unit require maintenance, contact an authorized service location-see service procedure.

Use of controls, adjustments or the performance of procedures other than those specified herein may result in hazardous radiation exposure.

To prevent direct exposure to laser beam, do not try to open the enclosure. Visible laser radiation when open. DO NOT STARE INTO BEAM.

CAUTION: The apparatus shall not be exposed to water, dripping or splashing and that no objects filled with liquids, such as vases, shall be placed on the apparatus.

 This product is manufactured to comply with the radio interference requirements of EEC DIRECTIVE 89/336/EEC, 93/68/EEC and 73/23/EEC.

Notes on copyrights:

It is forbidden by law to copy, broadcast, show, broadcast via cable, play in public, or rent copyright material without permission.

This product features the copy protection function developed by Macrovision. Copy protection signals are recorded on some discs.

This product incorporates copyright protection technology that is protected by method claims of certain U.S. patents and other intellectual property rights owned by Macrovision Corporation and other rights owners. Use of this copyright protection technology must be authorized by Macrovision Corporation, and is intended for home and other limited viewing uses only unless otherwise authorized by Macrovision Corporation. Reverse engineering or disassembly is prohibited.

"The making of unauthorized copies of copy-protected material, including computer programmes, files, broadcasts and sound recordings, may be an infringement of copyrights and constitute a criminal offence. This equipment should not be used for such purposes."

SERIAL NUMBER: The serial number is found on the back of this unit. This number is unique to this unit and not available to others. You should record requested information here and retain this guide as a permanent record of your purchase.

Model No. _____
 Serial No. _____

CONSUMERS SHOULD NOTE THAT NOT ALL HIGH DEFINITION TELEVISION SETS ARE FULLY COMPATIBLE WITH THIS PRODUCT AND MAY CAUSE ARTIFACTS TO BE DISPLAYED IN THE PICTURE. IN CASE OF 625 PROGRESSIVE SCAN PICTURE PROBLEMS, IT IS RECOMMENDED THAT THE USER SWITCH THE CONNECTION TO THE 'STANDARD DEFINITION' OUTPUT. IF THERE ARE QUESTIONS REGARDING OUR TV SET COMPATIBILITY WITH THIS MODEL 625p DVD PLAYER, PLEASE CONTACT OUR CUSTOMER SERVICE CENTER.

Features:

- Complete versatility to play DVD, VCDs, audio CDs or VHS Tapes.
- Watch a DVD while recording a TV show to the VCR.
- Remote controls DVD and VCR decks.
- Records from DVD to VHS (unless DVD is copy protected with Macrovision).
- Hi-Fi Stereo VCR.

Index

English 4

English

Français38

Français

Deutsch73

Deutsch

Nederlands108

Nederlands

Italiano.....143

Italiano

Español177

Español

Ελληνικά212

Ελληνικά



Português247

Português

Contents

Introduction	
Safety Precautions	2
Index	3
Contents	4
Before Use	5-6
Playable Discs	5
Remote Control Operation Range	5
Precautions	6
Notes on Discs	6
About Symbols	6
Selecting the Viewing Source	6
Front Panel and Display Window	7
Remote Control	8
Rear Panel	9
Preparation	
Connections	10-11
Connecting to a TV & Decoder	10
Connecting to Optional Equipment	11
Before Operation - VCR part	12-16
Tuning in a video channel on your TV	12
Using your DVD+VCR for the very first time	12
Setting the clock Manually	13
To set the colour system	13
How to using the main menu	14
Tuning in TV stations Automatically	14
Tuning in TV stations Manually	15
Changing the other of TV stations	16
Deleting TV stations	16
Before Operation - DVD part	17-20
General Explanation	17
On-Screen Display	17
Initial Settings	18-20
● General Operation	18
● Language	18
● Display	18
● Audio	19
● Others	19
● LOCK (Parental Control)	20
Operation	
Operation with Tape	21-23
Playing a tape	21
● OPR (Optimum Picture Response)	21
Instant Timer Recording (ITR)	22
Timer recording using On Screen Display	23
Operation with DVD and Video CD	24-26
Playing a DVD and Video CD	24
General Features	24
● Moving to another TITLE	24
● Moving to another CHAPTER/TRACK	24
● Search	24
● Still Picture and Frame-by-Frame Playback	24
● Slow Motion	25
● Repeat	25
● Repeat A-B	25
● Time Search	25
● Screen Saver	25
● Zoom	26
● Marker Search	26
Special DVD Features	26
● Title Menu	26
● Disc Menu	26
● Camera Angle	26
● Changing the Audio Language	26
● Changing the Audio Channel	26
● Subtitles	26
Operation with Audio and MP3/Windows Media™	
Audio Disc	27-28
Playing an Audio CD and MP3/Windows Media™ Audio Disc	27-28
● Notes on MP3/Windows Media™ Audio Recordings	27
● Pause	28
● Moving to another Track	28
● Repeat Track/All/Off	28
● Search	28
● Shuffle	28
● Repeat A-B	28
Operation with JPEG Disc	29
Viewing a JPEG disc	29
● Moving to another File	29
● Still Picture	29
● Zoom	29
● To rotate Picture	29
● Notes on JPEG Recordings	29
Programmed Playback	30
Programmed Playback with Audio CD and MP3/Windows Media™ Audio Disc	30
● Repeat Programmed Tracks	30
● Erasing a Track from Program list	30
● Erasing the Complete Program list	30
Maintenance and Service	30
● Handling the unit	30
Additional Operation	31-32
On Screen Display	31
Tape Counter Memory Stop	31
Child Lock	31
Video Doctor (Self-Diagnosis)	31
Hi-Fi Stereo Sound System	32
Wide Screen Compatibility 16:9	32
To set the decoder	32
Last Condition Memory	32
Special Recording	33
Copying from DVD to VCR	33
Recording from another video recorder	33
Reference	
Troubleshooting	34
Language Code List	35
Country/Area Code list	36
Specification	37

Playable Discs

	DVD (8 cm / 12 cm disc)
	Video CD (VCD) (8 cm / 12 cm disc)
	Audio CD (8 cm / 12 cm disc)

In addition, this unit can play DVD±R, DVD±RW, SVCD, and CD-R or CD-RW that contains audio titles, MP3/Windows Media™ Audio and/or JPEG files.

RW COMPATIBLE This indicates a product feature that is capable of playing DVD-RW discs recorded with Video Recording format.

Notes

- Depending on the conditions of the recording equipment or the CD-R/RW (or DVD±R/±RW) disc itself, some CD-R/RW (or DVD±R/±RW) discs cannot be played on the unit.
- Do not attach any seal or label to either side (the labeled side or the recorded side) of a disc.
- Do not use irregular shaped CDs (e.g., heart-shaped or octagonal). It may result in malfunctions.

Notes on DVDs and Video CDs

Some playback operations of DVDs and Video CDs may be intentionally fixed by software manufacturers. As this unit plays DVDs and Video CDs according to disc content designed by the software manufacturer, some playback features of the unit may not be available, or other functions may be added.

Refer also to the instructions applied with the DVDs and Video CDs. Some DVDs made for business purposes may not be played on the unit.

Regional code of the DVD player and DVDs

This DVD player is designed and manufactured for playback of region "2" encoded DVD software.



The region code on the labels of some DVD discs indicates which type of player can play those discs. This unit can play only DVD discs labeled "2" or "ALL". If you try to play any other discs, the message "Check Regional Code" will appear on the TV screen. Some DVD discs may not have a region code label even though their playback is prohibited by area limits.

Disc-related terms

Title (DVD only)

The main film content or accompanying feature content or additional feature content, or music album. Each title is assigned a title reference number enabling you to locate it easily.

Chapter (DVD only)

Sections of a picture or a musical piece that are smaller than titles.

A title is composed of one or several chapters. Each chapter is assigned a chapter number, enable you to locate the chapter you want. Depending on the disc, no chapters may be recorded.

Track

Sections of a picture or a musical piece on a video CD or an audio CD. Each track is assigned a track number, enabling you to locate the track you want.

Scene

On a video CD with PBC (Playback control) functions, moving pictures and still pictures are divided into sections called "Scenes". Each scene is displayed in the menu screen and assigned a scene number, enabling you to locate the scene you want. A scene is composed of one or several tracks.

Types of video CDs

There are two types of video CDs:

Video CDs equipped with PBC (Version 2.0)

PBC (Playback control) functions allow you to interact with the system via menus, search functions, or other typical computer-like operations. Moreover, still pictures of high resolution can be played if they are included in the disc.

Video CDs not equipped with PBC (Version 1.1)

Operated in the same way as audio CDs, these discs allow playback of video pictures as well as sound, but they are not equipped with PBC.

Remote Control Operation Range

Point the remote control at the remote sensor and press the buttons.

- **Distance:** About 23 ft (7 m) from the front of the remote sensor
- **Angle:** About 30° in each direction of the front of the remote sensor

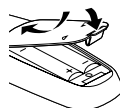

Remote control battery installation

Detach the battery cover on the rear of the remote control, and insert two (size AA) batteries with + and - aligned correctly.

Caution

Do not mix old and new batteries. Never mix different types of batteries (standard, alkaline, etc.).

Before Use (Cont'd)

Precautions

Handling the unit

When shipping the unit

The original shipping carton and packing materials come in handy. For maximum protection, re-pack the unit as it was originally packed at the factory.

When setting the unit

The picture and sound of a nearby TV or radio may be distorted during playback. In this case, position the unit away from the TV or radio, or turn off the unit after removing the disc.

To keep the surface clean

Do not use volatile liquids, such as insecticide spray, near the unit. Do not leave rubber or plastic products in contact with the unit for a long period of time. They will leave marks on the surface.

Cleaning the unit

To clean the cabinet

Use a soft, dry cloth. If the surfaces are extremely dirty, use a soft cloth lightly moistened with a mild detergent solution. Do not use strong solvents, such as alcohol, benzene, or thinner, as these might damage the surface of the unit.

To obtain a clear picture

The DVD player is a high-tech, precision device. If the optical pick-up lens and disc drive parts are dirty or worn down, the picture quality will be poor. Regular inspection and maintenance are recommended after every 1,000 hours of use. (This depends on the operating environment.) For details, please contact your nearest dealer.

Notes on Discs

Handling discs

Do not touch the playback side of the disc.
Hold the disc by the edges so that fingerprints will not get on the surface.
Do not stick paper or tape on the disc.



Storing discs

After playing, store the disc in its case.
Do not expose the disc to direct sunlight or sources of heat, or leave it in a parked car exposed to direct sunlight, as there may be a considerable temperature increase inside the car.

Cleaning discs

Fingerprints and dust on the disc can cause poor picture quality and sound distortion. Before playing, clean the disc with a clean cloth. Wipe the disc from the center out.

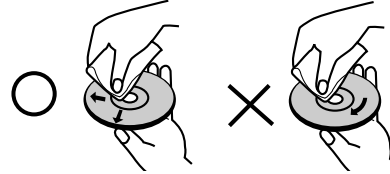

Do not use strong solvents such as alcohol, benzene, thinner, commercially available cleaners, or anti-static spray intended for older vinyl records.







About Symbols

About the symbol display

“” may appear on the TV screen during operation. This icon means the function explained in this owner's manual is not permitted by the DVD+VCR or is not available on that specific DVD video disc.

About the disc symbols for instructions

A section whose title has one of the following symbol is applicable only to the disc represented by the symbol.

-  DVD
-  Video CDs with the PBC (playback control) function.
-  Video CDs without the PBC (playback control) function.
-  Audio CDs.
-  MP3 disc.
-  JPEG disc.

Selecting the Viewing Source

You must select one of your output sources (DVD or VCR) to view on the TV screen.

- **If you want to view DVD deck output source:**
Press DVD on the remote or SOURCE on the front panel and output source of DVD deck is viewed on the TV screen.
- **If you want to view VCR deck output source:**
Press VCR on the remote or SOURCE on the front panel and output source of VCR deck is viewed on the TV screen.

Notes

- If you insert a disc while the DVD+VCR is in the VCR mode, the DVD+VCR will switch to DVD mode automatically.
- If you insert a cassette tape without prevention tab while the DVD+VCR is in the DVD mode, the DVD+VCR will switch to VCR mode automatically.

Front Panel and Display Window

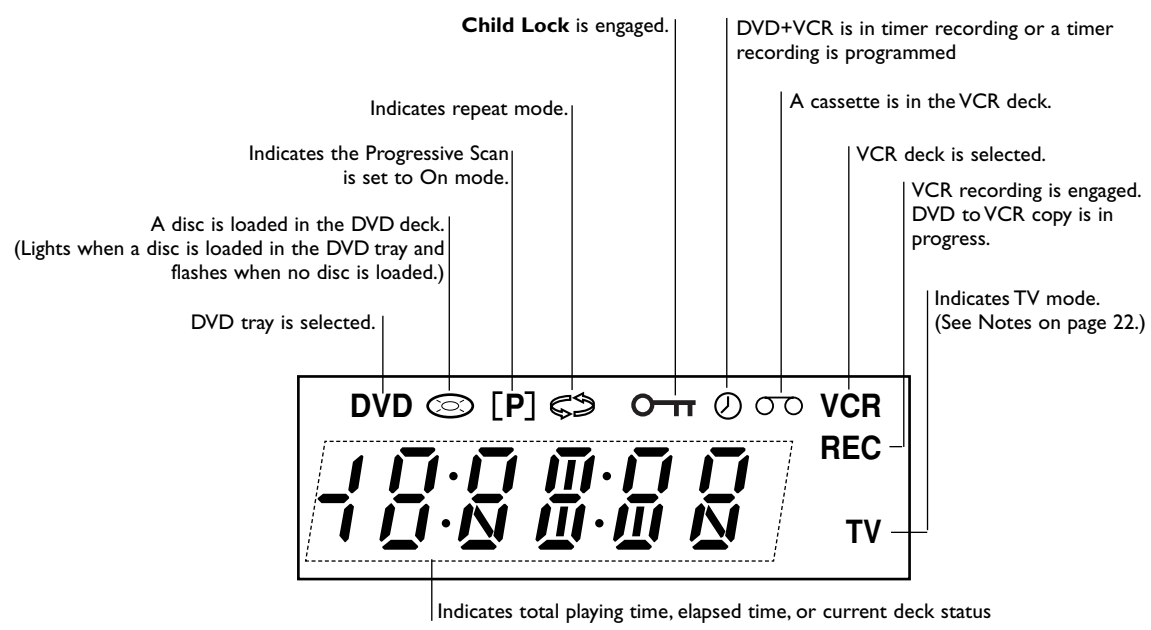
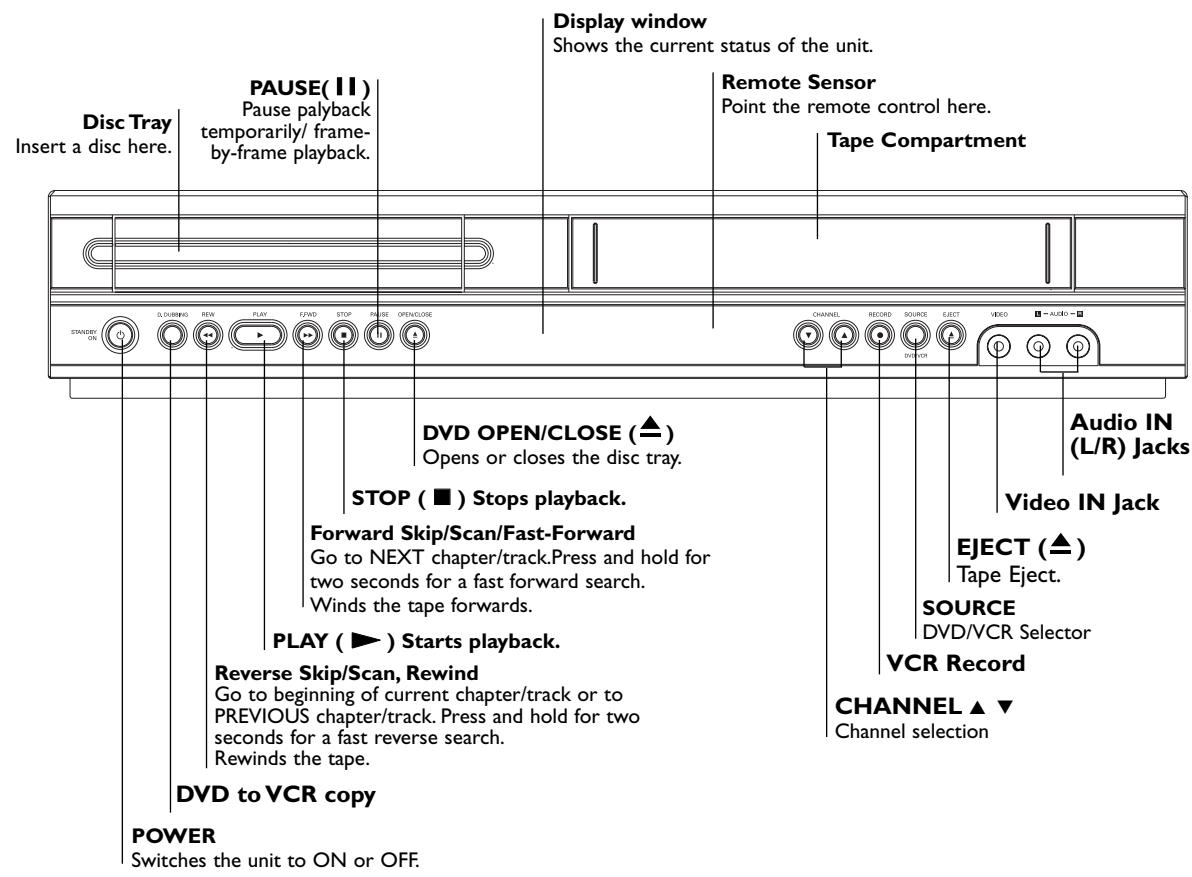

Remote Control

DVD/VCR select button
Select the output source (DVD or VCR) to view on the TV screen.

TV/VIDEO
To view channels selected by the VCR tuner or by the TV tuner.

0-9 numerical buttons
Selects numbered options in a menu.

DISC MENU
Accesses menu on a DVD disc.

SYSTEM MENU
Accesses or removes DVD setup menu and VCR menu.

SKIP ◀◀/REW
Skip to beginning of current chapter or track, press twice in quick successions to go to previous chapter or track.
Press and hold button for about two seconds to search backward. (For DVD only)
Rewinds the tape during the STOP mode or for fast reverse picture search.

SKIP ▶▶/FWD
Skip to next chapter or track.
Press and hold button for about two seconds to search forward. (For DVD only)
Advances the tape during the STOP mode or for fast forward picture search.

MARKER
Marks any point during playback.

SEARCH
Displays MARKER SEARCH menu.

INPUT
To select the VCR deck's source (Tuner, AV1, AV2 or AV3).

RECORD
Records normally or activates Instant Timer
Recording with repeated presses.

REPEAT
Repeat chapter, track, title, all.

REPEAT A-B
Repeats sequence.

PROGRAM
Accesses or removes Program menu.

CLEAR
- Resets tape counter to M 0:00:00
- Removes a track number on the program menu or a mark on the MARKER SEARCH menu.

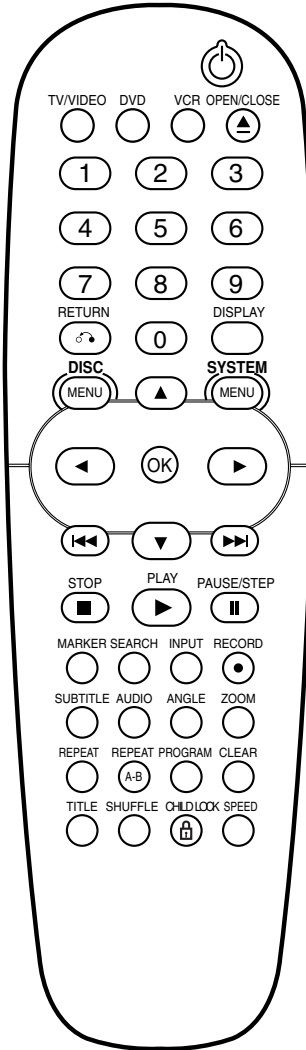

POWER
Switches DVD+VCR ON and OFF.

EJECT, OPEN/CLOSE
- Opens and closes the disc tray.
- Ejects the tape in the VCR deck.

RETURN
Displays the menu of a Video CD with PBC.

DISPLAY
Accesses On-Screen display.
Switches among the clock, tape counter and tape remaining modes.

◀▶/▲▼ (left/right/up/down)
- Selects an option in the menu
- ▲/▼: Selects channel of VCR. Adjusts manually the tape's picture onscreen.

OK
- Acknowledges menu selection.
- Displays functions on the TV screen.

STOP
Stops playback.

PLAY
Starts playback.

PAUSE/STEP
Pause playback or recording
Press repeatedly for frame-by-frame playback during pause.

SUBTITLE
Selects a subtitle language.

AUDIO
Selects an audio language (DVD).

ANGLE
Selects a DVD camera angle if available.

ZOOM
Enlarges DVD/VCD video image.

TITLE
Displays the disc's Title menu, if available.

SHUFFLE
- Plays tracks in random order.

CHILD LOCK
Switch the Child Lock on and off.

SPEED
Selects recording speed.

Note

This remote control use the same buttons for VCR and DVD functions (ex. PLAY).

When using a VCR, first press the VCR button.

When using a DVD, first press the DVD button.

Rear Panel

English

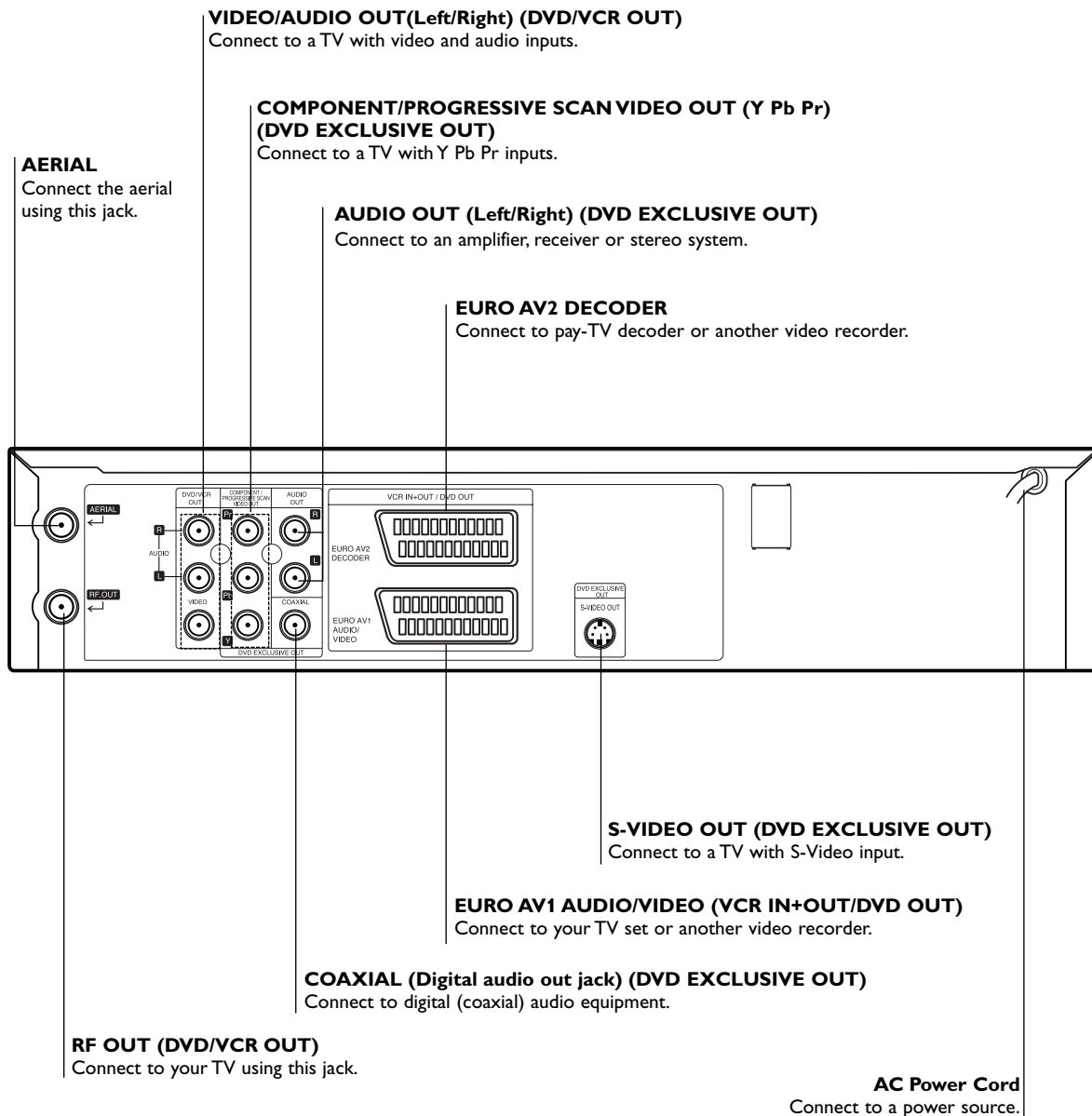

Caution

Do not touch the inner pins of the jacks on the rear panel. Electrostatic discharge may cause permanent damage to the unit.

Connections

Tips

- Depending on your TV and other equipment you wish to connect, there are various ways you could connect the unit.
- Please refer to the manuals of your TV, Stereo System or other devices as necessary to make the best connections.
- For better sound reproduction, connect this unit's AUDIO OUT jacks to the audio in jacks of your amplifier, receiver, stereo or audio/video equipment. See "Connecting to optional equipment" on page 11.

Caution

- Make sure this unit is connected directly to the TV. Set the TV to the correct video input channel.
- Do not connect this unit's AUDIO OUT jack to the phono in jack (record deck) of your audio system.

Connecting to a TV & Decoder

- Make one of the following connections, depending on the capabilities of your existing equipment.

Basic connection (AV)

1 Connect the **EURO AV1 AUDIO/VIDEO** on the rear panel of this unit to the **SCART** input socket on the TV using a SCART lead.

2 Some TV broadcasters transmit encoded television signals which you can only see with a purchased or rented decoder. You can connect such a decoder (descrambler) to the DVD+VCR.

Basic connection (RF)

1 Connect the RF antenna cable from your indoor/ outdoor antenna to **AERIAL** jack on the rear panel of this unit.

2 Connect the supplied RF antenna cable from the **RF OUT** jack on the rear panel of this unit to your television's Antenna Input.

DVD exclusive out connection

- **Component Video (Color Stream®) connection**

1 Connect the **COMPONENT/PROGRESSIVE SCAN VIDEO OUT** jacks on the DVD Player to the corresponding in jacks on the TV using the Y Pb Pr cable.

2 Connect the Left and Right **AUDIO OUT** jacks of the DVD Player to the audio left/right in jacks on the TV using the audio cables.

- **S-Video connection**

1 Connect the **S-VIDEO OUT** jack on this unit to the S-Video input jack on the TV using the S-Video cable.

2 Connect the Left and Right **AUDIO OUT** jacks of the DVD Player to the audio left/right in jacks on the TV using the audio cables.

Progressive Scan (ColorStream®Pro) connection

- If your television is a high-definition or "digital ready" television, you may take advantage of the DVD Player's progressive scan output for the highest video resolution possible.

- If your TV does not accept the Progressive Scan format, the picture will appear scrambled if you try Progressive Scan on the DVD Player.

1 Connect the **COMPONENT/ PROGRESSIVE SCAN VIDEO OUT** jacks on the DVD Player to the corresponding in jacks on the TV using the Y Pb Pr cable.

2 Connect the Left and Right **AUDIO OUT** jacks of the DVD Player to the audio left/right in jacks on the TV using the audio cables.

Notes

- Set the Progressive to "On" on the setup menu for progressive signal, see page 18.
- Progressive scan does not work with the analog video connections (yellow VIDEO OUT jack) or S-VIDEO connection.

Rear of this unit (DVD exclusive out connection)

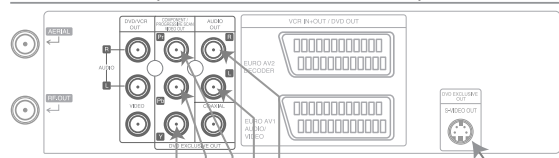

Rear of TV

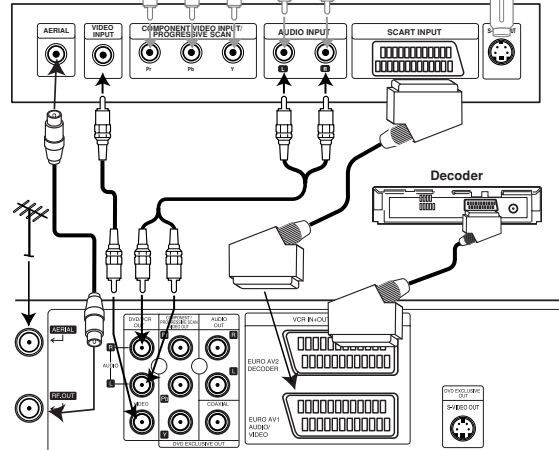

Rear of this unit (Basic connection)

Note

- If the TV has an S-video input, connect the DVD player with the S-video cable. When using an S-video cable, do not connect the yellow video cable.

Connecting to Optional Equipment

Connecting to an amplifier equipped with two channel analog stereo or Dolby Pro Logic II/ Pro Logic

Connect the Left and Right **DVD/VCR AUDIO OUT** or **AUDIO OUT (DVD EXCLUSIVE OUT)** jacks on this unit to the audio left and right in jacks on your amplifier, receiver or stereo system, using the audio cables.

Connecting to an amplifier equipped with two channel digital stereo (PCM) or to an Audio/ Video receiver equipped with a multi-channel decoder (Dolby Digital™ or MPEG 2)

- 1 Connect one of this unit's **DIGITAL AUDIO OUT** jack (**COAXIAL**) to the corresponding in jack on your amplifier. Use an optional digital (coaxial) audio cable.
- 2 You will need to activate this unit's digital output. (See "Audio" on page 19).

Digital Multi-channel sound

A digital multi-channel connection provides the best sound quality. For this you need a multi-channel Audio/Video receiver that supports one or more of the audio formats supported by your unit (MPEG 2 and Dolby Digital). Check the receiver manual and the logos on the front of the receiver.

Notes

- If the audio format of the digital output does not match the capabilities of your receiver, the receiver will produce a strong, distorted sound or no sound at all.
- To see the audio format of the current DVD in the On-Screen Display, press **AUDIO**.

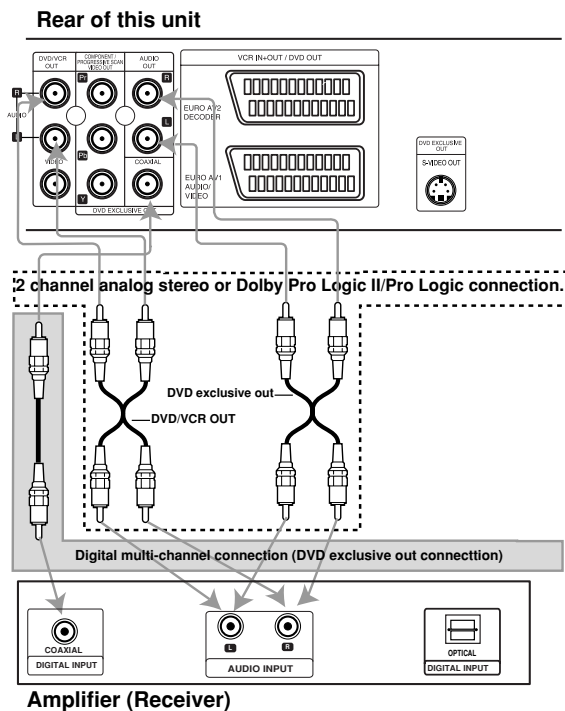

Before Operation - VCR part

Tuning in a video channel on your TV

Video channel (RF output channel) is the channel on which your TV receives picture and sound signals from the DVD+VCR through the RF cable.

If you have used a **SCART** lead you will not have to tune your TV, simply select the **AV** channel. The **AV** channel is already pre-tuned for optimum video playback on your TV.

Perform the following steps only if interference appears in the TV picture after you have moved to a different area or a new station has started broadcasting in your area, or if you change the connection from RF connection to AV connection, or vice versa.

- 1** Turn on DVD+VCR and TV.
- 2** Set the vacant position **36** on your TV.
- 3** Press **⏻** on the remote control to enter the standby mode (the clock indicator will be dimmed).
- 4** Press and hold **CHANNEL ▲** or **▼** on the DVD+VCR for more than 4 secs.

RF 36 will appear in the DVD+VCR display. The following picture will be displayed on the TV screen.

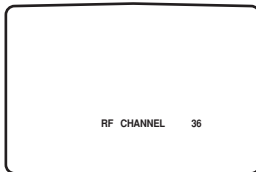

If the picture is snowy, move to step 5. If the picture is clean, press **⏻** on the DVD+VCR to finish.

- 5** Press **CHANNEL ▲** or **▼** on the DVD+VCR to set the video channel to a vacant position between **22** and **68** which is not occupied by any local station in your area.

Note

The RF channel will not change until step 6 has been executed.

- 6** Press **⏻** to store the new RF video channel into the DVD+VCR memory.

Now tune your TV set to the new DVD+VCR RF channel.

Note

If the TV picture was clear in step 4, do not retune your TV.

Using your DVD+VCR for the very first time

For the following steps we assume that you have just connected your DVD+VCR for the very first time. To make tuning TV stations an easy task your DVD+VCR incorporates the **Automatic Channel Memory System (ACMS)**. This system will automatically tune, store TV channels and set the clock (date & time) in your DVD+VCR.

- 1** Make sure that you have correctly installed your DVD+VCR.

Press **⏻** to turn on your DVD+VCR.

If the initial Menu Screen doesn't appear on screen, make sure that you have tuned your TV to a video channel. Or if this is correct it may mean that your DVD+VCR is already tuned.

- 2** Press **◀** or **▶** to select the desired country. (A: Austria, B: Belgium, CH: Switzerland, D: Germany, DK: Denmark, E: Spain, F: France, I: Italy, N: Norway, NL: Netherlands, P: Portugal, S: Sweden, SF: Finland, OTHERS)

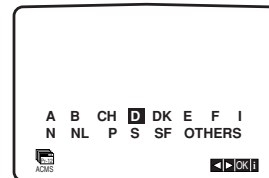

- 3** Press **OK** to start the automatic tuning process.

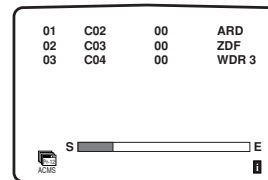

Programme number	TV Station
PR01	ARD
PR02	ZDF
PR03	WDR 3
PR04	BR3
PR05	HR3
PR06	NDR3

The TV station shown above may vary according to the area you live in.

- 4** Press **SYSTEM MENU** to remove the menus from the TV screen.

Setting the clock Manually

The clock in your DVD+VCR controls time and date settings for your DVD+VCR.

The clock is set automatically during **ACMS** (Automatic Channel Memory System) when you DVD+VCR detects a channel that broadcasts a Teletext signal. If the broadcast signal is weak the clock will not be set and will require setting manually.

- 1 Press **SYSTEM MENU**.
Press ◀ or ▶ to select **SET**.
Press **OK**.
The auto adjust mode can be set to 'OFF' by pressing **OK** if you want to set the time manually.

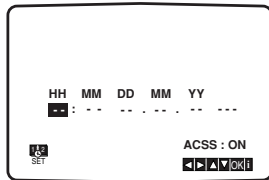

- 2 Use ▲ or ▼ on the remote control to alter the **HOURS, MINUTES, DAY, MONTH** and **YEAR**. Please note your DVD+VCR uses a 24 hour clock. e.g. 1pm will be displayed as 13:00. The day of the week will appear automatically when you enter the year.

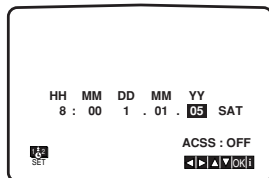

- 3 If you make a mistake press ◀ or ▶ and enter the correct details.
- 4 Press **SYSTEM MENU**.

To set the colour system

- 1 Press **SYSTEM MENU**.
- 2 The main menu will appear on the TV screen.
- 3 Press ◀ or ▶ to select the **SYS** and press **OK**.
- 4 Press ▲ or ▼ to select according to the **COLOUR** system used.

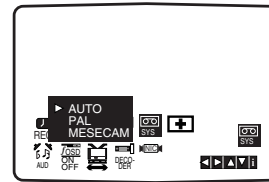

- 5 Press ▶ to select the **RF AUDIO**. Press ▲ or ▼ to select according to the **RF AUDIO** used.

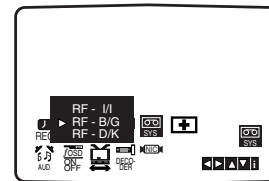

- 6 Press **SYSTEM MENU** to remove the menus from the TV screen.

Before Operation - VCR part

How to using the main menu

This VCR can easily be programmed by using the menus displayed on screen.

The menus are controlled from the Remote Control Handset.



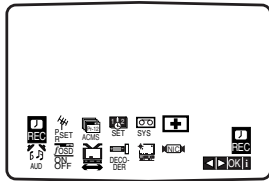

- 1 Switch on your TV set and video recorder by pressing the  button.
- 2 Press **SYSTEM MENU** button.
The main menu will appear on the TV screen.



- **REC** - Timer recording setting (see p. 23).
- **PR SET** - Manual tuning setting (see p. 15).
- **ACMS** - ACMS (Automatic Channel Memory System) (see p. 14).
- **SET** - Date & clock setting (see p. 13).
- **SYSTEM** - To set the Colour TV System (see p. 13).
- **Dr.** - To check a problem with your VCR (see p. 31).
- **AUDIO** - To select the channel for audio output (see p. 32).
- **F.OSD ON/OFF** - To display the operational mode of your VCR (see p. 31).
- **16:9/4:3** - To select the aspect ratio of your TV (see p. 32).
- **DECODER** - To use a pay-TV decoder (or Satellite) with your VCR (see p. 32).
- **OPR** - To improve the playback picture (see p. 21).
- **NIC** - To activate or deactivate the NICAM digital sound (see p. 32).



Tip

You can change the menu language on the DVD setup menu. (See the Menu Language on page 18.)



- 3 Press  and  to select the desired menu.
Press **OK** and use  or  to select.
- 4 Press **SYSTEM MENU** to return to a TV picture.

Tuning in TV Stations Automatically

If the TV broadcast signal is weak your VCR may not detect the necessary information and will not be able to store them correctly. To overcome this problem please turn to the MANUAL TUNING section on page 15.

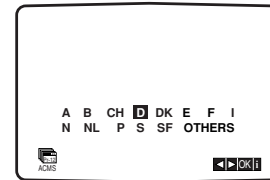
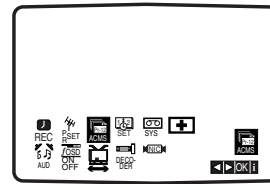
- 1 Press  to turn on your VCR.
- 2 Press **SYSTEM MENU** button.
The main menu will appear on the TV screen.
Press  or  to select the **ACMS**.
Press **OK**.





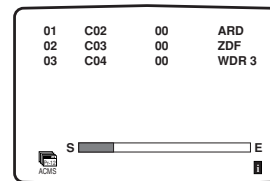

- 3 Press  or  to select **COUNTRY**.
(**A**:Austria, **B**:Belgium, **CH**:Switzerland, **D**:Germany, **DK**:Denmark, **E**:Spain, **F**:France, **I**:Italy, **N**:Norway, **NL**:Netherlands, **P**:Portugal, **S**:Sweden, **SF**:Finland, **OTHERS**)
Press **OK** again to start the automatic tuning process.
The VCR's clock will be set automatically when automatic tuning has finished. If the clock is wrong, see "Setting the clock manually" on page 13).



- 4 The **TV STATION TABLE** will appear when tuning is complete.
Press **SYSTEM MENU** to save your settings.

01	C02	00	ARD
02	C03	00	ZDF
03	C04	00	WDR 3
04	C05	00	BR3
05	C06	00	HR3
06	C07	00	N 3
07	C08	00	NDR3
08	C09	00	SWF3

MOVE: 
DELETE:   

Before Operation - VCR part

Tuning in TV Stations Manually

In certain areas of the country broadcast signals may be too weak for your VCR's automatic tuning process to find or assign TV stations correctly.

You must tune in these weaker broadcast stations manually in order for your VCR to store them.

- 1 Press **SYSTEM MENU**.
The main menu will appear on the TV screen.
Press ◀ or ▶ to select the **PR SET**.
Press **OK**.

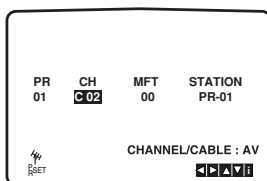
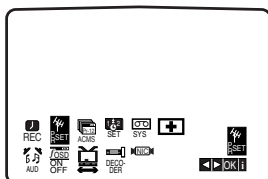

- 2 Press **SYSTEM MENU**.
The station table will appear.
Press ▲ or ▼ to select the programme number that you want to tune (for example, PR 09).

01	C02	00	PR-01
02	C03	00	PR-02
03	C04	00	PR-03
04	C05	00	PR-04
05	C06	00	PR-05
06	C07	00	PR-06
07	C08	00	PR-07
08	C09	00	PR-08

MOVE: [Up/Down] [OK]
DELETE: [Left/Right] [OK]

- 3 Press **OK**.
Press **INPUT** to select **C** (Standard stations) or **S** (Cable stations): C02 - C69, S01 - S41.
Enter the channel number of station that you want to tune with ▲ or ▼ to find the required station.

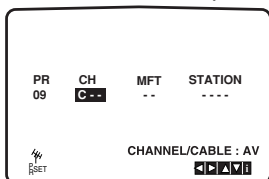

- 4 Searching will stop when it locates a stations.
Press ▶ to select **MFT**.
Control the fine tuning of the station by using ▲ or ▼.

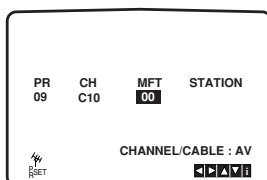

- 5 Press ▶ to select **STATION** so that you may name your TV station.
Press **OK**.

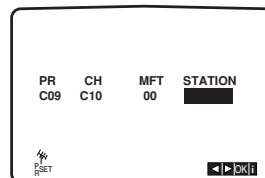

- 6 Use ▲ or ▼ to select **letters** and **numbers** for the new station name.
Use ◀ or ▶ to move back and forth between characters.
Press **OK**.

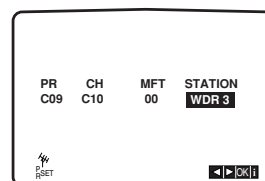

- 7 Press **SYSTEM MENU**, confirm the station placement.
Press **SYSTEM MENU** again.
Your new TV station has now been tuned into your VCR.
If you wish to manually tune other stations repeat stages 1 - 7.

09	C10	00	WDR 3
10	--	--	----
11	--	--	----
12	--	--	----
13	--	--	----
14	--	--	----
15	--	--	----
16	--	--	----

MOVE: [Up/Down] [OK]
DELETE: [Left/Right] [OK]

Before Operation - VCR part

Changing the order of TV Stations

After tuning TV stations into your VCR you may wish to change the order in which they are stored without having to retune them again. The instructions given on this page will show you how you can simply move them into your desired order.

- 1 Press **SYSTEM MENU**.
The main menu will appear on the TV screen.
Press ◀ or ▶ to select the **PR SET**.
Press **OK**.

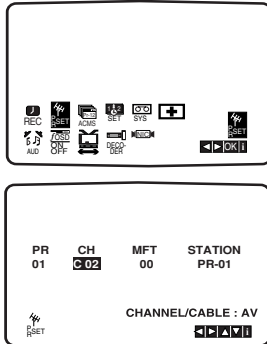

- 2 Press **SYSTEM MENU**.
Use ▲ or ▼ to select the **programme number** you want to move (for example, PR 03).
Press ▶.

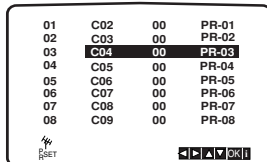
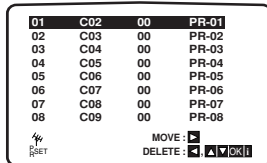

- 3 Use ▲ or ▼ to select the **programme number** you want to move to (for example, PR 05).

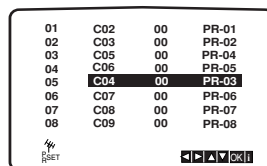

- 4 Press **OK**.
The selected **programme** will be moved to the **new programme number**.
If you wish to move other TV stations repeat stages 1 - 4.
Press **SYSTEM MENU** to remove the menus from the TV screen.

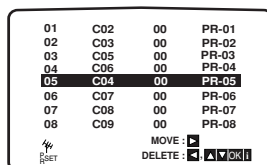

Deleting TV Stations

After tuning TV stations into your VCR you may wish to delete a station.

The instructions given on this page will show you how you can easily delete any unwanted TV stations.

- 1 Press **SYSTEM MENU**.
The main menu will appear on the TV screen.
Use ◀ or ▶ to select the **PR SET**.
Press **OK**.

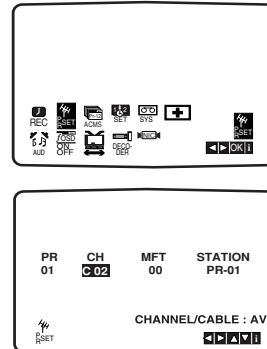

- 2 Press **SYSTEM MENU**.
Press ▲ or ▼ to select the **programme number** you want to delete. (for example, PR 03)

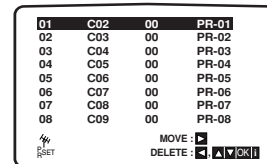

- 3 Press ◀.
After a short while, the selected station will be deleted.

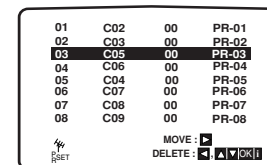

- 4 Press **SYSTEM MENU** to remove the menus from the TV screen.
If you wish to delete other TV stations repeat stages 1 - 3.

How to select Stored TV stations:

Stored TV stations can be selected in either of two ways.
Use ▲ or ▼ to select different stations that are tuned into your DVD+VCR.

You may also directly select stations using the **numbered buttons** on the remote control.

Before Operation - DVD part

General Explanation

This manual gives the basic instructions for operating the DVD+VCR. Some DVDs require specific operation or allow only limited operation during playback. When this occurs, the symbol  appears on the TV screen, indicating that the operation is not permitted by the DVD+VCR or is not available on the disc.









On-Screen Display

The general playback status can be displayed on the TV screen. Some options can be changed on the menu.

On-screen display operation

- 1** Press **DISPLAY** during playback.
- 2** Use **▲/▼** to select an item. The selected option will be highlighted.
- 3** Use **◀/▶** to change the setting of an item. The number buttons can also be used for setting numbers (e.g., title number). For some functions, press **OK** to execute the setting.

Temporary Feedback Field Icons

-  **Repeat Title**
-  **Repeat Chapter**
-  **Repeat Track (non-PBC Video CDs and Audio CD only)**
-  **Repeat Disc (non-PBC Video CDs and Audio CD only)**
-  **Repeat A-B**
-  **Repeat Off**
-  **Resume play from this point**
-  **Action prohibited or not available**

Notes

- Some discs may not provide all of the features on the on-screen display example shown below.
- If no button is pressed for 10 seconds, the on-screen display disappears.

DVD

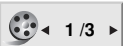
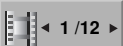
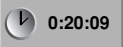
Options	Function (Use ▲/▼ to select desired option)	Selection Method
Title Number 	Shows the current title number and total number of titles, and skips to the desired title number.	◀/▶, or Numeric, OK
Chapter Number 	Shows the current chapter number and total number of chapters, and skips to the desired chapter number.	◀/▶, or Numeric, OK
Time search 	Shows the elapsed playing time, and searches the point by the elapsed time directly.	Numeric, OK

VCD2.0 VCD1.1

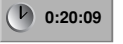
Items	Function (Use ▲/▼ to select desired option)	Selection Method
Track Number 	Shows the current track number, total number of tracks and PBC On mode, and skips to the desired track number.	◀ / ▶, or Numbers, OK
Time search 	Shows the elapsed playing time, and searches the point by the elapsed time directly	Numeric, OK

Before Operation (Continued) - DVD part

Initial Settings

You can set your own Personal Preferences on the player.

To display and exit the Menu:

Press **SYSTEM MENU** to display the menu. Press **SYSTEM MENU** again to return to the initial screen.

To go to the next level:

Press **▶** on the remote control.

To go back to the previous level:

Press **◀** on the remote control.

General Operation

- 1 Press **SYSTEM MENU**.
The setup menu appears.
- 2 Use **▲/▼** to select the desired option then press **▶** to move to the second level.
The screen will show the current setting for the selected option, as well as alternate setting(s).
- 3 Use **▲/▼** to select the second desired option then press **▶** to move to the third level.
- 4 Use **▲/▼** to select the desired setting then press **OK** to confirm your selection.
Some items require additional steps.
- 5 Press **SYSTEM MENU** or **PLAY ▶** to exit the setup menu.

LANGUAGE

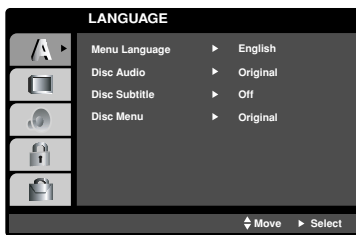

Menu Language

Select a language for the setup menu and on-screen display.

Disc Audio / Subtitle / Menu **DVD**

Select a language you prefer for the audio track (disc audio), subtitles, and the disc menu.

Original : The original language set for the disc is selected.

Other : To select another language, press number buttons to enter the corresponding 4-digit number according to the language code list on page 35. If you enter the wrong language code, press **CLEAR**.

DISPLAY

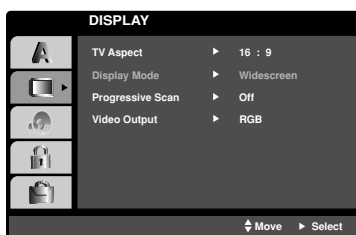

TV Aspect **DVD**

4:3 : Select when a standard 4:3 TV is connected.

16:9 : Select when a 16:9 wide TV is connected.

Display Mode **DVD**

Display Mode settings is only available when the TV Aspect mode is set to "4:3".

Letterbox: Displays a wide picture with bands on the upper and lower portions of the screen.

Panscan: Automatically displays the wide picture on the entire screen and cuts off the portions that do not fit.

Progressive Scan

Progressive Scan Video provides the highest quality pictures with less flickering. If you are using the Component Video jacks for connection to a TV or monitor that is compatible with a progressive scan signal, set Progressive Scan to On.

To turn on progressive scan:

Connect component out of this unit to the input of your monitor/television, set your television or monitor to component Input.

- 1 Select "Progressive Scan" on the "DISPLAY" menu then press **▶**.

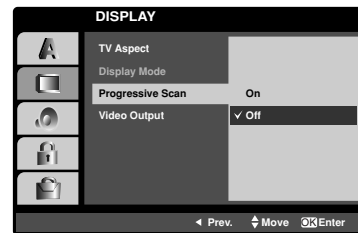

- 2 Select "On" using the **▲ / ▼** buttons.
- 3 Press **OK** to confirm your selection. The confirm menu will appear.
- 4 When the confirm menu appears on your screen "Cancel" is highlighted as default. Use the **◀** button to highlight "Enter".
- 5 Press **OK** to set to progressive scan mode.

Caution

If you set Progressive Scan to On in error, you must reset the unit.

- 1 Press and hold **STOP** for five seconds.
The video output will be restored to the standard setting and a picture appear again on TV screen.
- 2 Do not turn off this unit while the "PROGRESSIVE SCAN MODE" message is displayed on the TV screen.

Video Output

Set this unit's Video Output options according to the TV connection type.

YPbPr: When your TV is connected with the COMPONENT/PROGRESSIVE SCAN VIDEO OUT jacks on this unit.

RGB: When your TV is connected with the SCART (RGB signal) jack.

Before Operation (Continued) - DVD part

AUDIO

Each DVD disc has a variety of audio output options. Set the DVD+VCR's AUDIO according to the type of audio system you use.

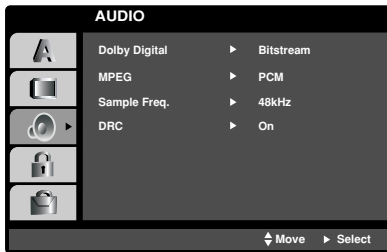

Dolby Digital / MPEG **DVD**

Bitstream: Select "Bitstream" if you connected the DVD+VCR's DIGITAL AUDIO OUT jack to an amplifier or other equipment with a Dolby Digital decoder or MPEG decoder.

PCM : Select when connected to a 2 channel digital stereo amplifier. DVD discs encoded in Dolby Digital or MPEG will automatically downmixed to two-channel PCM audio.

Sample Freq. (Frequency) **DVD**

To change the Sample Frequency setting, first select the desired Digital Audio Output as indicated as above.

If your receiver or amplifier is NOT capable of handling 96KHz signals, select 48KHz. When this choice is made, this unit will automatically convert any 96KHz signals to 48KHz so your system can decode them.

If your receiver or amplifier is capable of handling 96KHz signals, select 96KHz. When this choice is made, this unit will pass each type of signal through without any further processing.

Dynamic Range Control (DRC) **DVD**

With the DVD format, you can hear a program's soundtrack in the most accurate and realistic presentation possible, thanks to digital audio technology. However, you may wish to compress the dynamic range of the audio output (the difference between the loudest sounds and the quietest ones). Then, you may listen to a movie at a lower volume without losing clarity of sound. Set DRC to On for this effect.

OTHERS

The PBC and Auto Play settings can be changed.

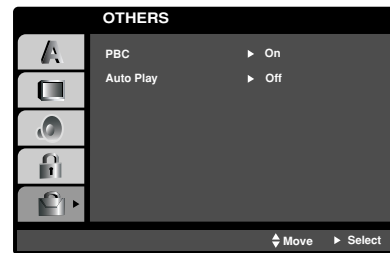

PBC **VCD 2.0**

Set Playback Control (PBC) to On or Off.

On: Video CDs with PBC are played according to the PBC.

Off: Video CDs with PBC are played the same way as Audio CDs.

Auto Play **DVD**

You can set up the DVD Player so a DVD disc automatically starts playing whenever the DVD is inserted. If Auto Play mode is set to On, this DVD player will search a title that playback time is long most and then play back the title automatically.

On: Auto Play function is activated.

Off: Auto Play function is not activated.

Note

The Auto Play function may not work for some DVDs.

Before Operation (Continued) - DVD part

LOCK (Parental Control)

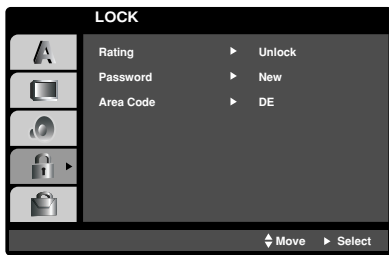

Rating **DVD**

Movies on DVDs may contain scenes not suitable for children. Therefore, discs may contain Parental Control information that applies to the complete disc or to certain scenes on the disc. These scenes are rated from 1 to 8, and alternatively, more suitable scenes are available for selection on some discs. Ratings are country dependent. The Parental Control feature allows you to prevent discs from being played by your children or to have certain discs played with alternative scenes.

- 1** Select "Rating" on the "LOCK" menu then press **▶**.
- 2** To access the Rating, Password and Area Code features, you must input the 4-digit security code you created. If you have not yet entered a security code you are prompted to do so. Input a 4-digit code and press **OK**. Enter it again and press **OK** to verify. If you make a mistake before pressing **OK**, press **CLEAR** and enter 4-digit security password again.
- 3** Select a rating from 1 to 8 using **▲/▼** buttons. **Rating 1-8:** Rating one (1) has the most restrictions and rating eight (8) is the least restrictive. **Unlock:** If you select Unlock, Parental Control is not active. The disc will play in full.

Note:

If you set a rating for the DVD+VCR, all disc scenes with the same rating or lower will be played. Higher rated scenes will not be played unless an alternative scene is available on the disc. The alternative must have the same rating or a lower one. If no suitable alternative is found, playback will stop. You must enter the 4-digit password or change the rating level in order to play the disc.

- 4** Press **OK** to confirm your rating selection, then press **SYSTEM MENU** to exit the menu.

Password (Security Code)

You can enter or change password.

- 1** Select "Password" on the "LOCK" menu then press **▶**.
- 2** Follow step 2 of "Rating" on left. "Change" or "New" is highlighted.
- 3** Enter the new 4-digit code, then press **OK**. Input it again to verify.
- 4** Press **SYSTEM MENU** to exit the menu.

If you forget your Security Code

If you forget your security code you can clear it using the following steps:

- 1** Press **SYSTEM MENU** to display the Setup menu.
- 2** Input the 6-digit number "210499" and the security code is cleared.
- 3** Enter a new code as described above.

Area Code **DVD**

Enter the code of a country/area whose standards were used to rate the DVD video disc, referring to the list (See "Country/Area Code List", page 36).

- 1** Select "Area Code" on the "LOCK" menu then press **▶**.
- 2** Follow step 2 of "Rating" on left.
- 3** Select the first character using the **▲/▼** buttons.
- 4** Shift the cursor using **▶** button and select the second character using **▲/▼** buttons.
- 5** Press **OK** to confirm your country code selection.

Operation with tape

Playing a tape

You will only be able to load and eject video cassettes when your VCR is plugged into the mains.
Your VCR may also playback recordings from NTSC tapes (on PAL TV).

Getting a better picture

When a cassette is inserted and playback started, the automatic tracking function works to get the best possible picture automatically. If the quality of the recording is poor, repeatedly press ▲ or ▼ on the remote control to manually adjust the tracking until any distortions have been removed.



Press numbered 0 on the remote control to switch automatic tracking back on again.

- 1 Make sure that you have correctly connected your VCR as described earlier in this book.
Turn on your TV.
Press  to turn on your DVD+VCR.
Insert the video cassette into your DVD+VCR.
The video cassette should have the window side facing up and the arrow facing away from you.



- 2 Press **PLAY**  to start playing your tape.
If you load a video cassette which has had its record protection tab removed, playback of the cassette will start automatically.

AUTO TRACKING



Your DVD+VCR will automatically adjust the tracking to give the best picture quality.

- 3 Press **PAUSE/STEP II** to still a picture.
Press **PAUSE/STEP II** repeatedly to advance the tape frame by frame.
If you press , the picture will be slowed down at about 1/19 times the normal playback.
Tapes can be paused for up to 5 minutes. After 5 minutes your DVD+VCR will stop the tape to prevent damaging the tape or your DVD+VCR.
Still picture quality can be improved slightly by using ▲ or ▼.
- 4 Press **PLAY**  to continue playing your tape.



Picture search:

During playing back press either  or  to this will enable you to rapidly wind the tape (7 times normal playback) see where you are on the tape.

Logic search:

During fast forwarding or rewinding press and hold  or  the picture will be played back at 7 times normal playback speed.

5 Slow motion playback, Shuttle :

During playing back or still picture press  or .
You can reach the following playback speeds. (-7xplay, -5xplay, -play, still, 1/19 slow, play, 2xplay, 7xplay)
To switch off the slow motion and shuttle, press the desired function.

During slow motion and shuttle, the noise bars may appear on the picture according to the status of tape.
If distortions can be seen in the picture, reduce them with ▲ or ▼.

6 Press STOP to end playback.



Press .
If the end of the tape is reached, your DVD+VCR will stop playback automatically, rewind, stop, eject the tape.

OPR (Optimum Picture Response)

This feature automatically improves playback picture quality by adjusting your DVD+VCR to the condition of the tape.

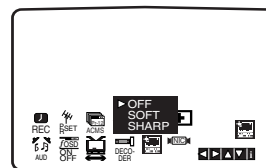
- 1 Press **SYSTEM MENU**.



- 2 Press  or  to select .
- 3 Press **OK**.
- 4 Press ▲ or ▼ repeatedly to select: **OFF**, **SOFT** or **SHARP**.
Please note you may only set OPR when playing a tape.
- 5 Press **SYSTEM MENU** return to screen.

Operation with tape (Continued)

Instant Timer Recording (ITR)

Your VCR allows you to make recordings using a variety of simple methods:

Instant Timer Recording (ITR) start recording immediately for a set period of time or until the video cassette runs out.

Your DVD+VCR incorporates Long Play (LP) which enables you to record up to twice the amount of time on a video cassette. For example an E-180 will record up to 180 minutes using Standard Play (SP); using LP you will be able to record up to 360 minutes. Please note there will be a slight loss in picture and sound quality when using LP.

- 1** Make sure that you have correctly connected your VCR as described earlier in this book.
Press  to turn on your VCR.
- 2** Insert a video cassette with protection tab into your VCR.
The video cassette should have the window side facing up and the arrow facing away from you.
- 3** Press **▲** or **▼** to select the **programme number** you wish to record.
You may also directly select programme number using the **numbered buttons** on the remote control.
- 4** If you wish to record directly from the SCART or RCA sockets repeatedly press **INPUT** until the socket you wish to record from is displayed.

AV 1 for recording from EURO AV1 SCART socket on the rear of your unit.

AV 2 for recording from EURO AV2 SCART socket on the rear of your unit.

AV 3 for recording from VIDEO IN and AUDIO IN (Left & Right) sockets on the front of your unit.

- 5** Press **SPEED** if you wish to record in Long Play or Standard Play.

SP will produce improved picture and sound quality, however LP will provide twice as much recording time as SP.

- 6** Press **RECORD** on the remote to start recording. **RECORD** will appear on the TV screen.
Press **RECORD** on your unit or press **RECORD** on the remote several times. Each successive press will increase the record time by 30 minutes until you reach a maximum of 9 hours.

- 7** Press **PAUSE/STEP II** to avoid recording unwanted scenes.

Press **PAUSE/STEP II** to continue recording.

If you press **PAUSE/STEP II** during ITR, the DVD/VCR will enter the record pause mode and ITR is cancelled.

Tapes can be paused for up to 5 minutes; RECP will be displayed when a tape is paused. After 5 minutes your DVD+VCR will stop recording to prevent damaging the tape or your DVD+VCR.

- 8** Press **STOP** to end recording.
STOP will appear on the TV screen for a few seconds.

Notes

- If you do not wish to record on a tape (this can happen quite easily by accident!) remove the protection tab on the back edge of the video cassette.
- It is possible to record on a video cassette with the record protection tab removed by covering the hole with self adhesive tape.
- Remember you can record one programme while watching another by starting your instant recording, press **TV/VIDEO** to appear **TV** indicator in the display window and then selecting a different channel on your TV.

Operation with tape

Timer recording using On Screen Display

You may set up to seven timer record events within one month of the current date.

Note

Before setting the timer make sure that you have set the DVD+VCR clock correctly and you know which PR numbers have been assigned to the TV stations you have tuned on your DVD+VCR.

Timer Recording function will only active if the DVD+VCR is in Standby mode.

- 1 Insert a video cassette with protection tab into your DVD+VCR.
The video cassette should have the window side facing up and the arrow facing away from you.
- 2 Ensure that the set is in VCR mode.
- 3 Press **SYSTEM MENU**.
Press ◀ or ▶ to select **REC**.
Press **OK**.
- 4 Press **OK** to start setting the timer record event.
If all timer record events are full press ▲ or ▼ to select the event that you wish to remove and replace.
Press ◀ to delete the event.

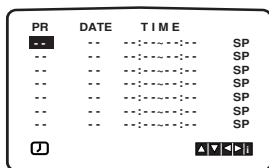

- 5 Press ▲ or ▼ to enter the station that you wish to record.
Once selected press ▶.
You may also press ▲ or ▼.
If you wish to record from AUDIO IN (L/R) and VIDEO IN on the front or from the EURO SCART sockets on the back of your unit, See Notes (AV1, AV2 or AV3).

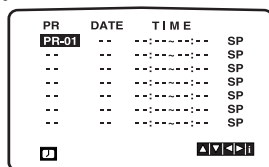

- 6 Press ▲ or ▼ to enter the date of the programme.
If you press **OK** before entering the date you may select one of the following automated recording features. Use ◀ or ▶ to select, then press **OK** to confirm.
DLY To record every day (except Saturday and Sunday) at the same time.
SU ~ SA To record at the same time every week.

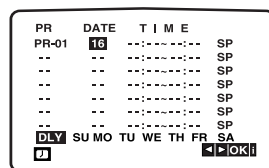

- 7 Press ▲ or ▼ to enter the recording start and end times of the programme that you wish to record.

Please note your DVD+VCR uses a 24 hour clock. e.g. 1pm will be displayed as 13:00.
You may also select the start and end times by using ▲ or ▼.

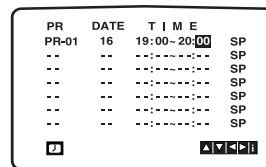

- 8 Press ▲ or ▼ to switch VPS/PDC on or off.
Press ▶ to select the recording speed.
Press ▲ or ▼ to select the desired tape speed (SP, IP, or LP).
IP mode determines how much tape is left and switches speed from SP to LP, if necessary, to complete recording the program. IP mode cannot be selected when VPS/PDC is ON.

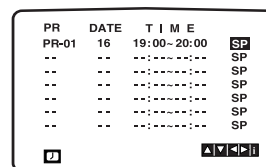

Press **SYSTEM MENU** to set another timer record event and follow steps 4 to 8.

- 9 Check that the timer event details are correct.
Press **SYSTEM MENU** twice.
If **PLEASE CHECK** is displayed, you have entered incorrect and will need to re-enter the data.
Press ⏻ to switch your DVD+VCR Standby mode.
⏻ will appear in the display window while your DVD+VCR waits to make the recording.
To watch a DVD during timer recording standby mode, press **POWER** and **DVD** to switch to DVD mode.

- 10 Press **STOP** to end recording.

Notes

- You can obtain the PR number assigned to each station by pressing **DISPLAY** when you are watching the respective channel.
- If at a later date you wish to **delete** or **change** any of the settings in timer event memory you may do so without having to enter all the timer event information again. Simply display the timer event screen. Use ▲ or ▼ to select the event that you wish to **delete** or **change**. Press ◀ to delete the event...or Press **OK** to change; then press ◀ or ▶ to select; Station, Date, Start and End times and LP. Press ▲ or ▼ to enter the correct information.
- **If Timer record events Overlap...**
Make sure that the preset times of the timer recording events do not overlap. If they do, the earlier programme will always be given priority.

Example:

Programme 1 is programmed to start at 16:00 and end at 17:00.
Programme 2 is programmed to start at 16:30 and end at 17:30.
(In this case, Programme 1 will be recorded in its entirety, but only the last 30 minutes of Programme 2 will be recorded.)

Operation with DVD and Video CD

Playing a DVD and Video CD

Playback Setup **DVD** **VCD2.0** **VCD1.1**

- Turn on the TV and select the video input source connected to the DVD player.
- Audio system: Turn on the audio system and select the input source connected to the DVD player.

- 1 Press **OPEN/CLOSE** to open the disc tray.
- 2 Load your chosen disc in the tray, with the playback side down.
When a double-sided DVD is inserted, make sure the side you want to play is facing down.
- 3 Press **OPEN/CLOSE** to close the tray.
Playback starts automatically. If playback does not start, press **PLAY** ▶.
In some cases, the disc menu might appear instead.

If a menu screen is displayed

The menu screen may be displayed first after loading a DVD or Video CD which offer a menu.

DVD

Use the ◀▶ ▲▼ buttons to select the title/chapter you want to view, then press **OK** to start playback.
Press **TITLE** or **DISC MENU** to return to the menu screen.

VCD2.0

- Use the number buttons to select the track you want to view.
Press **RETURN** to return to the menu screen.
- Menu setting and the exact operating procedures for using the menu may differ depending on the disc. Follow the instructions on the each menu screen.
You also may set PBC to Off under setup. See page 19.

Notes

- If Parental Control is set and the disc is not within the Rating settings (not authorized), the 4-digit code must be entered and/or the disc must be authorized (see "LOCK (Parental Control)", on page 20).
- DVDs may have a region code.
Your player will not play discs that have a region code different from your player. The region code for this player is 2 (two).
- To watch a DVD during timer recording standby mode, press **POWER** and **DVD** to switch to DVD mode.

General Features

Note

Unless stated otherwise, all operations described use the remote control. Some features may also be available on the Setup menu.

Moving to another TITLE **DVD** 1/3

When a disc has more than one title, you can move to another title as follows:

- Press **DISPLAY**, then press the appropriate numbered button (0-9) to select a title number.

Moving to another CHAPTER/TRACK

DVD **VCD1.1** 1/12 1/3

When a title on a disc has more than one chapter or a disc has more than one track, you can move to another chapter/track as follows:

- Press ◀◀ or ▶▶ briefly during playback to select the next chapter/track or to return to the beginning of the current chapter/track.
- Press ◀◀ twice briefly to step back to the previous chapter/track.
- To go directly to any chapter during DVD playback, press **DISPLAY**. Then, press ▲/▼ to select chapter/track icon. Then, enter the chapter/track number using the numbered buttons (0-9).

Note

For two-digit numbers, press the numbered buttons (0-9) in rapid succession.

Search **DVD** **VCD2.0** **VCD1.1**

- 1 Press ◀◀ or ▶▶ for about two seconds during playback.
The player will now go into SEARCH mode.
- 2 Press ◀◀ or ▶▶ repeatedly for about two seconds to select the required speed:
◀◀X2, ◀◀X4, ◀◀X16, ◀◀X100 (backward) or ▶▶X2, ▶▶X4, ▶▶X16, ▶▶X100 (forward).
With a Video CD, the Search speed changes:
◀◀X2, ◀◀X4, ◀◀X8 (backward) or ▶▶X2, ▶▶X4, ▶▶X8 (forward).
- 3 To return to playback, press **PLAY** ▶.

Still Picture and Frame-by-frame playback

DVD **VCD2.0** **VCD1.1**

- 1 Press **PAUSE/STEP** during playback.
The player will now go into PAUSE mode.
- 2 You can advance the picture frame-by-frame by pressing **PAUSE/STEP** repeatedly on the remote control.

Operation with DVD and Video CD

General Features (continued)

Slow Motion **DVD VCD2.0 VCD1.1**

- 1 Press **▶▶** during still mode.
The player will enter SLOW mode.
- 2 Press **▶▶** repeatedly to select the required speed :
▶▶ 1/7, **▶▶ 1/6**, **▶▶ 1/4** or **▶▶ 1/2** (forward).
- 3 To exit slow motion mode, press **PLAY ▶**.

Note

- Slow motion playback in reverse is not applicable.

Repeat **DVD VCD2.0 VCD1.1**



DVD Video Discs - Repeat Chapter/Title/Off

- 1 To repeat the currently playing chapter, press **REPEAT**.
The Repeat Chapter icon appears on the TV screen.
- 2 To repeat the title currently playing, press **REPEAT** a second time.
The Repeat Title icon appears on the TV screen.
- 3 To exit Repeat mode, press **REPEAT** a third time.
The Repeat Off icon appears on the TV screen.

Video CDs, - Repeat Track/All/Off

- 1 To repeat the track currently playing, press **REPEAT**.
The Repeat Track icon appears on the TV screen.
- 2 To repeat the disc currently playing, press **REPEAT** a second time.
The Repeat All icon appears on the TV screen.
- 3 To exit Repeat mode, press **REPEAT** a third time.
The Repeat Off icon appears on the TV screen.

Note

On a Video CD with PBC, you must set PBC to Off on the setup menu to use the Repeat function. See page 19.

Repeat A-B **DVD VCD2.0 VCD1.1**



To repeat a sequence in a title:

- 1 Press **REPEAT A-B** at your chosen starting point.
A * appears briefly on the TV screen.
- 2 Press **REPEAT A-B** again at your chosen end point.
A B appears briefly on the TV screen, and the repeat sequence begins.
- 3 To cancel the sequence, press **REPEAT A-B**.

Time Search **DVD VCD2.0 (PBC:Off) VCD1.1**



- The Time Search function allows you to start playing at any chosen time on the disc.
- 1 Press **DISPLAY** during playback. The on-screen display appears on the screen.
The Time Search box shows the elapsed playing time of the current disc.
 - 2 Within 10 seconds, press **▲/▼** to select the Time Search icon in the on-screen display.
The “-:-:-” appears in the Time Search box.
 - 3 Within 10 seconds, use the number buttons to enter the required start time. Enter hours, minutes, and seconds from left to right in the box.
If you enter the wrong numbers, press **CLEAR** to remove the numbers you entered. Then enter the correct numbers.
 - 4 Within 10 seconds, press **OK** to confirm the start time.
Playback starts from the selected time on the disc. If you enter an invalid time, playback will continue from the current point.

Screen Saver

A screen saver image appears when you leave the DVD Player in stop mode for about fifteen minutes.

Operation with DVD and Video CD

General Features (continued)

Zoom **DVD** **VCD2.0** **VCD1.1**

The Zoom function allows you to enlarge the video image and to move through the enlarged image.

- 1 Press **ZOOM** during playback or still playback to activate the Zoom function.
The square frame appears briefly in the right bottom of the picture.
- 2 Pressing **ZOOM** each time will change the TV screen in the sequence: 100% size → 150% size → 200% size → 300% size → 400% size → 100% size
- 3 Use the ◀▶ ▲ ▼ buttons to move through the zoomed picture.
- 4 To resume normal playback, press **ZOOM** repeatedly or **CLEAR** button.

Note

- The zoom function may not work for some DVDs.

Marker Search **DVD** **VCD2.0** **VCD1.1**

You can start playback from a memorized point. Up to nine points can be memorized.

To enter a mark, follow these steps.

- 1 During disc playback, press **MARKER** when playback reaches the spot that you want to memorize.
The Marker icon will appear on the TV screen briefly.
- 2 Repeat step 1 to enter up to nine Marker points on a disc.

To Recall a Marked Scene

- 1 During disc playback, press **SEARCH**.
The MARKER SEARCH menu will appear on the screen.
- 2 Within 10 seconds, press ◀▶ to select a Marker number that you want to recall.
- 3 Press **OK**.
Playback will start from the Marked scene.
- 4 To remove the MARKER SEARCH menu, press **SEARCH**.

To clear a Marked Scene

- 1 During disc playback, press **SEARCH**.
The MARKER SEARCH menu will appear on the screen.
- 2 Within 10 seconds, press ◀▶ to select a Marker number that you want to erase.
- 3 Press **CLEAR**.
The Marker number will be erased from the list.
- 4 Repeat steps 2 and 3 to erase additional Marker numbers.
- 5 To remove the MARKER SEARCH menu, press **SEARCH**.

Special DVD Features **DVD**

Checking the contents of DVD Video discs: Menus

DVDs may offer menus that allow you to access special features. To use the disc menu, press **DISC MENU**.

Then, press the appropriate number button to select an option. Or, use the ◀▶/▲/▼ buttons to highlight your selection, then press **OK**.

Title Menu **DVD**

- 1 Press **TITLE**.
If the current title has a menu, the menu will appear on the screen. Otherwise, the disc menu may appear.
- 2 The menu can list camera angles, spoken language and subtitle options, and chapters for the title.
- 3 To remove the title menu, press **TITLE** again.

Disc Menu **DVD**

- 1 Press **DISC MENU**.
The disc menu is displayed.
- 2 To remove the disc menu, press **DISC MENU** again.

Camera Angle **DVD**



If the disc contains sequences recorded from different camera angles, the angle icon blinks on the TV screen. You can then change the camera angle if you wish.

- Press **ANGLE** repeatedly during playback to select a desired angle.
The number of the current angle appears on the display.

Changing the Audio Language **DVD**



Press **AUDIO** repeatedly during playback to hear a different audio language or audio track.

Changing the Audio Channel **VCD2.0** **VCD1.1**

Press **AUDIO** repeatedly during playback to hear a different audio channel (STEREO, LEFT or RIGHT).

Subtitles **DVD**



Press **SUBTITLE** repeatedly during playback to see the different subtitle languages.

Operation with Audio and MP3/Windows Media™ Audio Disc

Playing an Audio CD and MP3/Windows Media™ Audio Disc

CD MP3

The DVD Player can play MP3/Windows Media™ Audio formatted recordings on CD-ROM, CD-R or CD-RW discs. Before playing MP3/Windows Media™ Audio recordings, read the notes on MP3/Windows Media™ Audio Recordings on right.

Audio CD

Once you insert an audio CD a menu appears on the TV screen. Press ▲/▼ to select a track then press **PLAY** or **OK** and playback starts.



MP3/Windows Media™ Audio

- 1 Press ▲/▼ to select a folder, and press **OK** to see the folder contents.
- 2 Press ▲/▼ to select a track then press **PLAY** or **OK**. Playback starts.



Tips

- If you are in a file list on the “MUSIC” menu and want to return to the Folder list, use the ▲/▼ to highlight **⏪** and press **OK**.
- On a CD with MP3/Windows Media™ Audio and JPEG you can switch MP3/Windows Media™ Audio and JPEG. Press **TITLE** and “MUSIC” or “PHOTO” word on top of the menu is highlighted.
- When playing a file containing information such as track titles, you can see the information by pressing **DISPLAY**.

Notes

- File name displayed is shorter in length than 31 characters.
- Title and artist information is less than 32 characters.

Notes on MP3/Windows Media™ Audio Recordings

MP3/Windows Media™ Audio Disc compatibility with this player is limited as follows:

- 1 Sampling Frequency / within 8 - 48 kHz (MP3)
within 32 - 48 kHz (Windows Media™ Audio)
- 2 Bit rate / within 32 - 320 kbps (MP3)
within 48 - 384 kbps (Windows Media™ Audio)
- 3 The player cannot read an MP3 file that has a file extension other than “.mp3”.
- 4 CD-R physical format should be “ISO 9660”
- 5 If you record MP3/Windows Media™ Audio files using the software which cannot create a file system, for example “Direct-CD” etc., it is impossible to playback MP3/Windows Media™ Audio files. We recommend that you use “Easy-CD Creator”, which creates an ISO9660 file system.
- 6 File names should be named using 8 letters or less and must incorporate “.mp3” or “.wma” extension.
- 7 Do not use special letters such as “/ : * ? “ < > ” etc.
- 8 The total number of contents on the disc should be less than 1500 files and 300 folders.
- 9 Multi session CD containing Windows Media™ Audio may not be supported.

This DVD player requires discs/recordings to meet certain technical standards in order to achieve optimal playback quality. Pre-recorded DVDs are automatically set to these standards. There are many different types of recordable disc formats (including CD-R containing MP3 or Windows Media™ Audio files). That require certain pre-existing conditions (see above) to insure compatible playback.

Customers should also note that permission is required in order to download MP3/Windows Media™ Audio files and music from the Internet. Our company has no right to grant such permission. Permission should always be sought from the copyright owner.

Operation with Audio and MP3/Windows Media™ Audio Disc (Continued)

Pause **CD** **MP3**

- 1 Press **PAUSE/STEP** during playback.
- 2 To return to playback, press **PLAY ►**, **OK** or press **PAUSE/STEP** again.

Moving to another Track **CD** **MP3**

- Press **◀◀** or **▶▶** briefly during playback to go to the next track or to return to the beginning of the current track.
- Press **◀◀** twice briefly to step back to the previous track.
- You can play any track by inputting its number.

Repeat Track/All/Off **CD** **MP3**

- 1 To repeat the track currently playing, press **REPEAT**.
The Repeat icon and "Track" appears on the menu screen.
- 2 To repeat all tracks on a disc, press **REPEAT** a second time.
The Repeat icon and "All" appears on the menu screen.
- 3 To cancel Repeat mode, press **REPEAT** a third time.

Search **CD** **MP3**

- 1 Press **◀◀** or **▶▶** for about two seconds during playback.
The player will now go into SEARCH mode.
- 2 Press **◀◀** or **▶▶** repeatedly for about two seconds to select the required speed: **◀◀X2**, **◀◀X4**, **◀◀X8** (backward) or **▶▶X2**, **▶▶X4**, **▶▶X8** (forward).
Search speed and direction are indicated on the menu screen.
- 3 To exit SEARCH mode, press **PLAY ►**.

Shuffle **CD** **MP3**

- 1 Press **SHUFFLE** during playback or when playback is stopped.
The unit automatically begins Random Playback and "Random" appears on the menu screen.
- 2 To return to normal playback, press **SHUFFLE**.
"Random" disappears on the menu screen.

Note

By pressing **▶▶** during shuffle playback, the unit selects another track and resumes shuffle playback.

Repeat A-B **CD**

To repeat a sequence.

- 1 During disc playback, press **REPEAT A-B** at your chosen starting point.
The Repeat icon and "A-" appears on the menu screen.
- 2 Press **REPEAT A-B** again at your chosen end point.
The Repeat icon and "A-B" appears on the menu screen, and the sequence begins to play repeatedly.
- 3 To exit the sequence and return to normal play, press **REPEAT A-B** again.

Operation with JPEG Disc

Viewing a JPEG disc **JPEG**

This DVD+VCR can play discs with JPEG files. Before playing JPEG recordings, read the notes on JPEG Recordings on right.

- 1 Insert a disc and close the tray.**
The PHOTO menu appears on the TV screen.

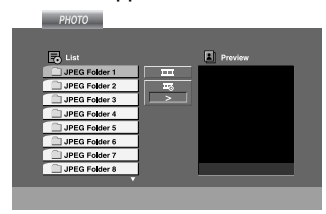

- 2** Press ▲/▼ to select a folder then press **OK**.
A list of files in the folder appears. If you are in a file list and want to return to the Folder list, use the ▲/▼ buttons on the remote to highlight “⋮” and press **OK**.
- 3** If you want to view a particular file, press ▲/▼ to highlight a file and press **OK** or **PLAY ▶**.
Viewing the file proceeding starts.
While viewing a file, you can press **STOP** to move to the previous menu (PHOTO menu).

Slide Show **JPEG**

Use ◀▶▲▼ to highlight the **SS** (Slide Show) then press **OK**.

Tips

- There are three Slide Speed options **SS** : >>> (Fast), >> (Normal) and > (Slow).
- On a disc with MP3/Windows Media™ Audio and JPEG you can switch MP3/Windows Media™ Audio and JPEG. Press **TITLE** and **MUSIC** or **PHOTO** word on top of the menu is highlighted.
- Press **RETURN**, information of file is hidden.

Moving to another File

Press |◀◀ or ▶▶| once during viewing a picture to advance to the next file or to the previous file.

Still Picture

- 1** Press **PAUSE/STEP** during slide show.
The player will now go into PAUSE mode.
- 2** To return to the slide show, press **PLAY ▶** or press **PAUSE/STEP** again.

Zoom **JPEG**

Use zoom to enlarge the photo image. (see 26 page)

To rotate picture

Press ▲/▼ during showing a picture to rotate the picture clockwise or counter clockwise.

Notes on JPEG Recordings

- Depending upon the size and number of the JPEG files, it could take a long time for the DVD+VCR to read the disc's contents. If you don't see an on-screen display after several minutes, some of the files are too big — reduce the resolution of the JPEG files to less than 5760 (Horizontal)x4608 (Vertical) pixels and burn another disc.
- The total number of contents on the disc should be less than 1500 files and 300 folders.
- Some disc may be incompatible due to different recording format or condition of disc.
- Ensure that all the selected files have the “.jpg” extensions when copying into the CD layout.
- If the files have “.jpe” or “.jpeg” extensions, please rename them as “.jpg” files.
- File names without “.jpg” extension will not be able to be read by this DVD+VCR. Even though the files are shown as JPEG image files in windows explorer.

Programmed Playback

Programmed Playback with Audio CD and MP3/Windows Media™ Audio Disc

The Program function enables you to store your favorite tracks from any disc in the player memory. Program can contain 30 tracks.

1 Press **PROGRAM** during playback or in the stop mode to enter the Program Edit mode.

The  mark will appear to the right of the word "Program" on the right side of the menu screen.

Note

Press **PROGRAM** to exit the Program Edit mode; the  mark will disappear.

2 Select a track, then press **OK** to place the selected track on the Program list.

3 Repeat step 2 to place additional tracks on the Program list.

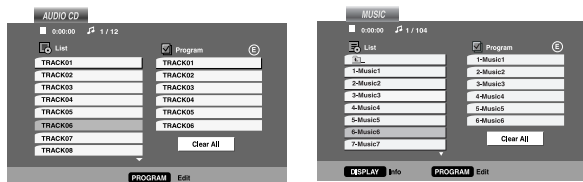

Audio CD menu

MP3/Windows Media™ Audio menu

4 Press **▶**.

The programmed track you selected last is highlighted on the program list.

5 Use **▲/▼** to select the track you want to start playing.

6 Press **PLAY ▶** to start.

Playback begins in the order in which you programmed the tracks. Playback stops after all of the tracks on the Program list have played once.

7 To resume normal playback from programmed playback, then select a track of Audio CD (or MUSIC) list and then press **PLAY**.

Repeat Programmed Tracks

- To repeat the track currently playing, press **REPEAT**. The Repeat icon and "Track" appears on the menu screen.
- To repeat all tracks on the program list, press **REPEAT** a second time. The Repeat icon and "All" appears on the menu screen.
- To cancel Repeat mode, press **REPEAT** a third time.

Note

If you press **▶▶** once during Repeat Track playback, the repeat playback cancels.

Erasing a Track from Program List

- 1 Press **PROGRAM** in the stop mode to enter the Program Edit mode.
- 2 Press **▶** to move to the Program list.
- 3 Use **▲/▼** to select the track that you wish to erase from the Program list.
- 4 Press **CLEAR**. The track will be erased from the Program list.

Erasing the Complete Program List

- 1 Follow steps 1-2 of "Erasing a Track from Program List" as above.
- 2 Use **▲/▼** to select "Clear All", then press **OK**. The complete Program for the disc will be erased. The programs are also cleared when the disc is removed.

Maintenance and Service

Refer to the information in this chapter before contacting a service technician.

Handling the Unit

When shipping the unit

Please save the original shipping carton and packing materials. If you need to ship the unit, for maximum protection, re-pack the unit as it was originally packed at the factory.

Keeping the exterior surfaces clean

- Do not use volatile liquids such as insecticide spray near the unit.
- Do not leave rubber or plastic products in contact with the unit for a long period of time since they leave marks on the surface.

Cleaning the unit

To clean the player, use a soft, dry cloth. If the surfaces are extremely dirty, use a soft cloth lightly moistened with a mild detergent solution.

Do not use strong solvents such as alcohol, benzene, or thinner, as these might damage the surface of the unit.

Maintaining the Unit

The DVD player is a high-tech, precision device. If the optical pick-up lens and disc drive parts are dirty or worn, the picture quality could be diminished.

Depending on the operating environment, regular inspection and maintenance are recommended after every 1,000 hours of use.

For details, please contact your nearest authorized service center.

On Screen Display

You may easily display the current time or tape counter, amount of tape left, day, month, year, day of week, programme channel, tape speed and operational mode of your VCR on the TV screen. If a recording is taking place these On Screen Displays will not be recorded onto the tape.

- 1 Press **DISPLAY** to display.
Press **DISPLAY** repeatedly to cycle through the display options. The tape counter and amount of tape left will appear if there is a tape loaded.
- 2 After 3 seconds the majority of the On Screen Displays will clear leaving only the clock or tape counter and the amount of tape left on the screen.
Press **DISPLAY** again to remove all displays from the TV screen.

Tape Counter Memory Stop

The **Digital Tape Counter** can be displayed on the display window instead of the time by pressing **DISPLAY** on the remote control. The Digital Tape Counter indicates the relative positions of recordings on the tape.

- 1 Press **DISPLAY**.
Press **CLEAR** to set the counter to 0:00:00.
Press **PLAY** ► or start recording.
The tape counter will display the actual play time in hours, minutes and seconds.
- 2 Press **STOP** ■ when playback or recording is complete.
Press ◀◀.
The tape will rewind and automatically stop when the counter returns to 0:00:00.

Child Lock

The control buttons on the front of the unit can be switched off so that your unit can only be operated using the remote control.

- 1 Press **CHILD LOCK**.
ON and **SAFE** will appear in the display window.
None of the buttons on the front of your unit will work.
If any buttons on the front of your unit are pressed **SAFE** will appear in the display window for a few seconds.
- 2 Press **CHILD LOCK** again to switch off the child lock.
OFF will appear in the display window.

Note

- **CHILD LOCK** is not available on the DVD mode.

Video Doctor (Self-Diagnosis)

This feature informs you that there is a problem with your VCR. These error messages will appear on the TV screen.

- 1 Press **SYSTEM MENU**.
Press ◀ or ▶ to select [E].
Press **OK**.

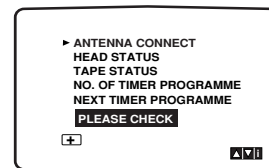
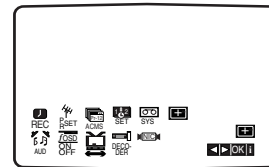

- 2 Press ▲ or ▼ to check a problem.
 - ANTENNA CONNECT**
 - **PLEASE CHECK:**
Connect the aerial into the jack securely.
 - HEAD STATUS**
 - **PLEASE CLEAN:**
Clean your video heads.
 - TAPE STATUS**
 - **NOT RECORDABLE:**
Insert a tape with its protection tab in place
 - NO. OF TIMER PROGRAMME**
 - 2
Shows the number of timer recording.
 - NEXT TIMER PROGRAMME**
 - **PR-01 26 10:00~11:00 SP**
Shows the current status of timer recording.

- 3 Press **SYSTEM MENU**.

Additional Operation (Continued)

Hi-Fi Stereo Sound System

Your VCR will record and playback Hi-Fi stereo sound. In addition it has a stereo NICAM digital stereo sound decoder. This allows you to record and playback the sound in several different ways. Video cassettes recorded on your VCR will have a normal mono audio track and two VHS Hi-Fi stereo audio tracks. These stereo tracks allow you to make audio recordings in Hi-Fi stereo or bilingual mode from a TV broadcast, stereo audio system, video disc or another Hi-Fi VCR.

- 1 Your VCR's NICAM digital sound decoder allows you to enjoy broadcasts with NICAM sound, as well as standard stereo, bilingual and mono sound. The particular type of sound received or that recorded will be briefly displayed on the TV screen for a couple of seconds:

STEREO NICAM

Sound is automatically recorded on the Hi-Fi stereo and mono tracks of the video tape.

BIL NICAM

Both audio channels will be recorded on the Hi-Fi stereo tracks. The primary language channel (left) will be recorded on the mono track of the video tape.

MONO

The sound is recorded on the Hi-Fi tracks and the mono track of the video tape without any separation.

- 2 Press **SYSTEM MENU**. Press ◀ or ▶ to select **AUD**.
- 3 Press ▲ or ▼ to select **STEREO, LEFT, RIGHT** and **MONO**.

In **BIL NICAM** playback the primary language is output on the left channel and the secondary channel is output simultaneously from the right channel when audio output is set to **STEREO**. The primary language will be output from both channels when the audio setting is **MONO**.

Please note that when adjusting the tracking control Hi-Fi stereo sound may revert to **MONO**.

Changing TV Audio Channel

Som TV programs are broadcast with a bilingual audio program (BIL). Press ▲ or ▼ to select **STEREO/MAIN**, **STEREO/SUB** and **MONO/MAIN**.

Wide Screen Compatibility 16:9

Your VCR can record and play back wide screen aspect ratio programmes (16:9). To record a wide screen format programme successfully the correct type of wide screen signal must be broadcast by the TV station.

- 1 Switch on your VCR.
Press **SYSTEM MENU**.
Press ◀ or ▶ to select 
Press **OK**.

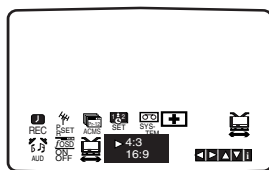
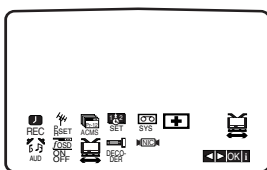

- 2 Press ▲ or ▼ repeatedly to select: **AUTO, 4:3** or **16:9**.
AUTO (Playback mode only):
Automatically plays back Wide-Screen programmes as Wide-Screen and Normal programmes as normal.
4:3
Only for playing back and recording Normal format recordings (4:3).
16:9:
Only for playing back and recording Wide-Screen format recordings (16:9).

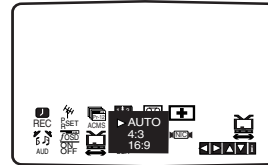

- 3 Press **SYSTEM MENU** to remove the menus from the TV screen.
To enjoy Wide-Screen playback you must connect your VCR to the TV using a SCART cable.

To set the decoder

We have already described, how to connect a decoder for pay-TV station as **CANAL+** or **PREMIERE** on page 10. For the recording of an encoded station you do not have to control anything. You just select the station and wait shortly until the decoding will start.

- 1 Press **SYSTEM MENU**.
The main menu will appear on the TV screen.
Press ◀ or ▶ to select the **DECODER**.
Press **OK**.
- 2 Press ▲ or ▼ to select.
ON: When the decoder is connected to the AV2 socket.
OFF: When another VCR is connected to the AV2 socket.
Press **SYSTEM MENU** to return to a TV picture.

Last Condition Memory

VCD1.1

This player memorizes the last condition for the last disc you have watched. Settings remain in memory even if you remove the disc from the player or switch off the player. If you load a disc that has its settings memorized, the latest stop position is automatically recalled.

Notes

- Settings are stored in memory for use any time.
- This player does not memorize settings of a disc if you switch off the player before commencing to play it.

Copying from DVD To VCR

This unit allows you to copy the contents of a DVD to a VHS tape with a press of the **D.DUBBING** button.

Notes

- Be sure to set 'Progressive Scan' to "Off" on the setup menu.
- If the DVD you are attempting to copy is copy protected, you may not be able to copy the disc.

1 Insert Disc

Insert the disc you wish to copy in the DVD deck and close the disc tray.

2 Insert VHS Tape

Insert a blank VHS videotape into the VCR deck.

3 Copy the DVD to VHS Tape

Press the **D.DUBBING** button or **RECORD** on the unit front panel.

- The DVD will go into Play mode and the VCR will go into Record mode.
- If the DVD disc menu appears, you may need to press the Play button manually to begin copying.

Note

If you press **RECORD** button, make sure the player is in DVD mode.

4 Stop the Copy Process.

When the DVD is finished playing, press the **STOP** button to end the copy.

- You must stop the Copy process manually when the DVD movie ends, or the unit may replay and record over and over again.

Recording from another video recorder

With this video recorder you can make recordings from an external source, such as copying from another video recorder or a camcorder.

Note

In the following description, this video recorder will be one used for recording and will be referred to as VCR B. The other appliance will be used for playback and will be referred to as VCR A.

1 VCR A should be connected to the SCART socket on the rear panel of your unit or the AV sockets on the front panel of your unit.

2 Insert the recorded tape into VCR A and a blank tape into VCR B.

3 Press **INPUT** until the socket you wish to record from is displayed. (VCR B).

AV 1 for recording from EURO AV1 SCART socket on the rear of your unit.

AV 2 for recording from EURO AV2 SCART socket on the rear of your unit.

AV 3 for recording from VIDEO IN and AUDIO IN (Left & Right) sockets on the front of your unit.

4 To start recording, press the **RECORD** on VCR B and **PLAY ►** on VCR A.

5 When you want to finish copying, press the **STOP ■** on both video recorders.

Troubleshooting

Check the following guide for the possible cause of a problem before contacting service.

Symptom	Cause	Correction
DVD or VCR do not work properly.	● DVD or VCR button is not switched properly.	● Refer to page 6.
No power.	● The power cord is disconnected.	● Plug the power cord into the wall outlet securely.
The power is on, but the DVD player does not work.	● No disc is inserted.	● Insert a disc.
No picture.	● The TV is not set to receive DVD signal output.	● Select the appropriate video input mode on the TV so the picture from the DVD player appears on the TV screen.
	● The video cable is not connected securely.	● Connect the video cable into the jacks securely.
No sound.	● The equipment connected with the audio cable is not set to receive DVD signal output.	● Select the correct input mode of the audio receiver so you can listen to the sound from the DVD player.
	● The audio cables are not connected securely.	● Connect the audio cable into the jacks securely.
	● The power of the equipment connected with the audio cable is turned off.	● Turn on the equipment connected with the audio cable.
	● The Digital Audio Output is set to the wrong position.	● Set the Digital Audio Output to the correct position, then turn on the DVD player again by pressing POWER.
The picture is poor.	● The disc is dirty.	● Clean the disc.
	● The TV channels are not tuned in properly.	● Check tuning, carry out tuning again.
The DVD player does not start playback.	● An unplayable disc is inserted.	● Insert a playable disc. (Check the disc type and Regional code.)
	● The disc is placed upside down.	● Place the disc with the playback side down.
	● The disc is not placed within the guide.	● Place the disc on the disc tray correctly inside the guide.
	● The disc is dirty.	● Clean the disc.
	● The Rating level is set.	● Cancel the Rating function or change the rating level.
The remote control does not work properly.	● There is an obstacle in the path of the remote control and this unit.	● Remove the obstacle.
	● The batteries in the remote control are exhausted.	● Replace the batteries with new ones.
Video tape cannot be inserted.	● Is the cassette compartment empty?	● Eject the tape in.
No Hi-Fi sound	● Audio mode is not set properly.	● Switch 'AUDIO' in the main menu to 'STEREO'.
No NICAM sound recording	● NICAM mode is not set properly.	● Make sure NICAM in the menu is set to AUTO for the station to be recorded.

Language Code List

Enter the appropriate code number for the initial settings "LANGUAGE" (See page 18).

English

Code	Language	Code	Language	Code	Language	Code	Language
6566	Abkhazian	7074	Fiji	7678	Lingala	8373	Singhalese
6565	Afar	7073	Finnish	7684	Lithuanian	8375	Slovak
6570	Afrikaans	7082	French	7775	Macedonian	8376	Slovenian
8381	Albanian	7089	Frisian	7771	Malagasy	8379	Somali
6577	Ameharic	7176	Galician	7783	Malay	6983	Spanish
6582	Arabic	7565	Georgian	7776	Malayalam	8385	Sudanese
7289	Armenian	6869	German	7784	Maltese	8387	Swahili
6583	Assamese	6976	Greek	7773	Maori	8386	Swedish
6588	Aymara	7576	Greenlandic	7782	Marathi	8476	Tagalog
6590	Azerbaijani	7178	Guarani	7779	Moldavian	8471	Tajik
6665	Bashkir	7185	Gujarati	7778	Mongolian	8465	Tamil
6985	Basque	7265	Hausa	7865	Nauru	8484	Tatar
6678	Bengali; Bangla	7387	Hebrew	7869	Nepali	8469	Telugu
6890	Bhutani	7273	Hindi	7879	Norwegian	8472	Thai
6672	Bihari	7285	Hungarian	7982	Oriya	6679	Tibetan
6682	Breton	7383	Icelandic	8065	Panjabi	8473	Tigrinya
6671	Bulgarian	7378	Indonesian	8083	Pashto, Pushto	8479	Tonga
7789	Burmese	7365	Interlingua	7065	Persian	8482	Turkish
6669	Byelorussian	7165	Irish	8076	Polish	8475	Turkmen
7577	Cambodian	7384	Italian	8084	Portuguese	8487	Twi
6765	Catalan	7465	Japanese	8185	Quechua	8575	Ukrainian
9072	Chinese	7487	Javanese	8277	Rhaeto-Romance	8582	Urdu
6779	Corsican	7578	Kannada	8279	Rumanian	8590	Uzbek
7282	Croatian	7583	Kashmiri	8285	Russian	8673	Vietnamese
6783	Czech	7575	Kazakh	8377	Samoan	8679	Volapük
6865	Danish	7589	Kirghiz	8365	Sanskrit	6789	Welsh
7876	Dutch	7579	Korean	7168	Scots Gaelic	8779	Wolof
6978	English	7585	Kurdish	8382	Serbian	8872	Xhosa
6979	Esperanto	7679	Laothian	8372	Serbo-Croatian	7473	Yiddish
6984	Estonian	7665	Latin	8378	Shona	8979	Yoruba
7079	Faroese	7686	Latvian, Lettish	8368	Sindhi	9085	Zulu

Country/Area Code List

Enter the appropriate code number for the initial setting "Area Code" (See page 20).

Code	Country/Area	Code	Country/Area	Code	Country/Area	Code	Country/Area
AD	Andorra	ER	Eritrea	LC	Saint Lucia	SC	Seychelles
AE	United Arab Emirates	ES	Spain	LI	Liechtenstein	SD	Sudan
AF	Afghanistan	ET	Ethiopia	LK	Sri Lanka	SE	Sweden
AG	Antigua and Barbuda	FI	Finland	LR	Liberia	SG	Singapore
AI	Anguilla	FJ	Fiji	LS	Lesotho	SH	Saint Helena
AL	Albania	FK	Falkland Islands	LT	Lithuania	SI	Slovenia
AM	Armenia	FM	Micronesia	LU	Luxembourg	SJ	Svalbard and Jan Mayen Islands
AN	Netherlands Antilles	FO	Faroe Islands	LV	Latvia	SK	Slovak Republic
AO	Angola	FR	France	LY	Libya	SL	Sierra Leone
AQ	Antarctica	FX	France (European Territory)	MA	Morocco	SM	San Marino
AR	Argentina	GA	Gabon	MD	Moldavia	SN	Senegal
AS	American Samoa	GB	Great Britain	MG	Madagascar	SO	Somalia
AT	Austria	GD	Grenada	MH	Marshall Islands	SR	Suriname
AU	Australia	GE	Georgia	MK	Macedonia	ST	Saint Tome and Principe
AW	Aruba	GF	French Guyana	ML	Mali	SU	Former USSR
AZ	Azerbaijan	GH	Ghana	MM	Myanmar	SV	El Salvador
BA	Bosnia-Herzegovina	GI	Gibraltar	MN	Mongolia	SY	Syria
BB	Barbados	GL	Greenland	MO	Macau	SZ	Swaziland
BD	Bangladesh	GM	Gambia	MP	Northern Mariana Islands	TC	Turks and Caicos Islands
BE	Belgium	GN	Guinea	MQ	Martinique (French)	TD	Chad
BF	Burkina Faso	GP	Guadeloupe (French)	MR	Mauritania	TF	French Southern Territories
BG	Bulgaria	GQ	Equatorial Guinea	MS	Montserrat	TG	Togo
BH	Bahrain	GR	Greece	MT	Malta	TH	Thailand
BI	Burundi	GS	S. Georgia & S. Sandwich Isls.	MU	Mauritius	TJ	Tadjikistan
BJ	Benin	GT	Guatemala	MV	Maldives	TK	Tokelau
BM	Bermuda	GU	Guam (USA)	MW	Malawi	TM	Turkmenistan
BN	Brunei Darussalam	GW	Guinea Bissau	MX	Mexico	TN	Tunisia
BO	Bolivia	GY	Guyana	MY	Malaysia	TO	Tonga
BR	Brazil	HK	Hong Kong	MZ	Mozambique	TP	East Timor
BS	Bahamas	HM	Heard and McDonald Islands	NA	Namibia	TR	Turkey
BT	Bhutan	HN	Honduras	NC	New Caledonia (French)	TT	Trinidad and Tobago
BV	Bouvet Island	HR	Croatia	NE	Niger	TV	Tuvalu
BW	Botswana	HT	Haiti	NF	Norfolk Island	TW	Taiwan
BY	Belarus	HU	Hungary	NG	Nigeria	TZ	Tanzania
BZ	Belize	ID	Indonesia	NI	Nicaragua	UA	Ukraine
CA	Canada	IE	Ireland	NL	Netherlands	UG	Uganda
CC	Cocos (Keeling) Islands	IL	Israel	NO	Norway	UK	United Kingdom
CF	Central African Republic	IN	India	NP	Nepal	UM	USA Minor Outlying Islands
CG	Congo	IO	British Indian Ocean Territory	NR	Nauru	US	United States
CH	Switzerland	IQ	Iraq	NU	Niue	UY	Uruguay
CI	Ivory Coast	IR	Iran	NZ	New Zealand	UZ	Uzbekistan
CK	Cook Islands	IS	Iceland	OM	Oman	VA	Vatican City State
CL	Chile	IT	Italy	PA	Panama	VC	Saint Vincent & Grenadines
CM	Cameroon	JM	Jamaica	PE	Peru	VE	Venezuela
CN	China	JO	Jordan	PF	Polynesia (French)	VG	Virgin Islands (British)
CO	Colombia	JP	Japan	PG	Papua New Guinea	VI	Virgin Islands (USA)
CR	Costa Rica	KE	Kenya	PH	Philippines	VN	Vietnam
CS	Former Czechoslovakia	KG	Kyrgyzstan	PK	Pakistan	VU	Vanuatu
CU	Cuba	KH	Cambodia	PL	Poland	WF	Wallis and Futuna Islands
CV	Cape Verde	KI	Kiribati	PM	Saint Pierre and Miquelon	WS	Samoa
CX	Christmas Island	KM	Comoros	PN	Pitcairn Island	YE	Yemen
CY	Cyprus	KN	Saint Kitts & Nevis Anguilla	PR	Puerto Rico	YT	Mayotte
CZ	Czech Republic	KP	North Korea	PT	Portugal	YU	Yugoslavia
DE	Germany	KR	South Korea	PW	Palau	ZA	South Africa
DJ	Djibouti	KW	Kuwait	PY	Paraguay	ZM	Zambia
DK	Denmark	KY	Cayman Islands	QA	Qatar	ZR	Zaire
DM	Dominica	KZ	Kazakhstan	RE	Reunion (French)	ZW	Zimbabwe
DO	Dominican Republic	LA	Laos	RO	Romania		
DZ	Algeria	LB	Lebanon	RU	Russian Federation		
EC	Ecuador			RW	Rwanda		
EE	Estonia			SA	Saudi Arabia		
EG	Egypt			SB	Solomon Islands		
EH	Western Sahara						

Specification

General

Power requirements	AC 220-230V, 50Hz
Power consumption	17W
Dimensions (approx.)	430 X 78.5 X 265 mm (w/h/d)
Mass (approx.)	4.06 kg
Operating temperature	5°C to 35°C (41°F to 95°F)
Operating humidity	5 % to 90 %
Timer	24 hours display type
RF Modulator	UHF 22-68 (Adjustable)

System

Laser	Semiconductor laser; wavelength 650 nm
Video Head system	Double azimuth 6 heads, helical scanning.
Signal system	PAL
Frequency response	DVD (PCM 96 kHz): 8 Hz to 44 kHz DVD (PCM 48 kHz): 8 Hz to 22 kHz CD: 8 Hz to 20 kHz
Signal-to-noise ratio	More than 100dB (ANALOG OUT connectors only)
Harmonic distortion	Less than 0.008%
Dynamic range	More than 100 dB (DVD) More than 95 dB (CD)

Inputs (VCR)

Audio	-6.0dBm, more than 10 kohms (SCART) -6.0dBm, more than 47 kohms (RCA)
Video	1.0Vp-p, 75 ohms, unbalanced (SCART/RCA)

Outputs (DVD)

VIDEO OUT	1 Vp-p 75 ohms, sync. negative
S-VIDEO OUT	(Y) 1 Vp-p 75 ohms, negative sync., Mini Din 4-pin x 1 (C) 0.3 Vp-p 75 ohms
COMPONENT VIDEO OUT (Progressive Scan)	(Y) 1 Vp-p 75 ohms, negative sync., RCA jack x 1 (Pb)/(Pr) 0.7 Vp-p 75 ohms, RCA jack x 2
RGB output	0.7 Vp-p 75 ohms
Audio output (digital audio)	0.5 V (p-p), 75 ohms, RCA jack x 1
Audio output (analog audio)	2.0 Vrms (1 kHz, 0 dB), 600 ohms, RCA jack (L, R) x 2/SCART (TO TV)

Outputs (VCR)

Audio	-6.0dBm, less than 1 kohms (SCART)
Video	1.0Vp-p, 75 ohms, unbalanced (SCART)
RGB output	0.7 Vp-p 75 ohms

Design and specifications are subject to change without notice.

Manufactured under license from Dolby Laboratories. "Dolby" and the double-D symbol are trademarks of Dolby Laboratories.

P/NO: 3834RV0032Z

Free Manuals Download Website

<http://myh66.com>

<http://usermanuals.us>

<http://www.somanuals.com>

<http://www.4manuals.cc>

<http://www.manual-lib.com>

<http://www.404manual.com>

<http://www.luxmanual.com>

<http://aubethermostatmanual.com>

Golf course search by state

<http://golfingnear.com>

Email search by domain

<http://emailbydomain.com>

Auto manuals search

<http://auto.somanuals.com>

TV manuals search

<http://tv.somanuals.com>