

# DIGITAL VIDEO DISC PLAYER & VIDEO CASSETTE RECORDER

DVP3345V

## User Manual



Thank you for choosing Philips.

### Need help fast?

Read your Quick Start Guide and/or User Manual first for quick tips that make using your Philips product more enjoyable.

**Register your product and get support at [www.philips.com/welcome](http://www.philips.com/welcome)**



Philips vous remercie de votre confiance.

### Besoin d'une aide rapide?

Le Guide rapide de début et Manuel de l'utilisateur regorgent d'astuces destinées à simplifier l'utilisation de votre produit Philips.

**Enregistrez votre produit et accédez à l'assistance sur [www.philips.com/welcome](http://www.philips.com/welcome)**



Gracias por escoger Philips

### Necesita ayuda inmediata?

Lea primero la Guía rápida del comienzo o el Manual del usuario, en donde encontrará consejos que le ayudarán a disfrutar plenamente de su producto Philips.

**Visite [www.philips.com/welcome](http://www.philips.com/welcome) para registrar su producto y obtener información de contacto y asistencia.**



# PHILIPS

**Return your Product Registration Card or register online at [www.philips.com/welcome](http://www.philips.com/welcome) today to get the very most from your purchase.**

Registering your model with PHILIPS makes you eligible for all of the valuable benefits listed below, so don't miss out. Complete and return your Product Registration Card at once, **or register online at [www.philips.com/welcome](http://www.philips.com/welcome)** to ensure:

### \*Proof of Purchase

Returning the enclosed card guarantees that your date of purchase will be on file, so no additional paperwork will be required from you to obtain warranty service.

### \*Product Safety Notification

By registering your product, you'll receive notification - directly from the manufacturer - in the rare case of a product recall or safety defect.

### \*Additional Benefits

Registering your product guarantees that you'll receive all of the privileges to which you're entitled, including special money-saving offers.

## PHILIPS

**Congratulations on your purchase, and welcome to the "family!"**

**Dear PHILIPS product owner:**

Thank you for your confidence in PHILIPS. You've selected one of the best-built, best-backed products available today. We'll do everything in our power to keep you happy with your purchase for many years to come.

As a member of the PHILIPS "family," you're entitled to protection by one of the most comprehensive warranties and outstanding service networks in the industry. What's more, your purchase guarantees you'll receive all the information and special offers for which you qualify, plus easy access to accessories from our convenient home shopping network.

Most importantly, you can count on our uncompromising commitment to your total satisfaction.

All of this is our way of saying welcome - and thanks for investing in a PHILIPS product.

**P.S. To get the most from your PHILIPS purchase, be sure to complete and return your Product Registration Card at once, or register online at:**

**[www.philips.com/welcome](http://www.philips.com/welcome)**

Know these  
**safety symbols**

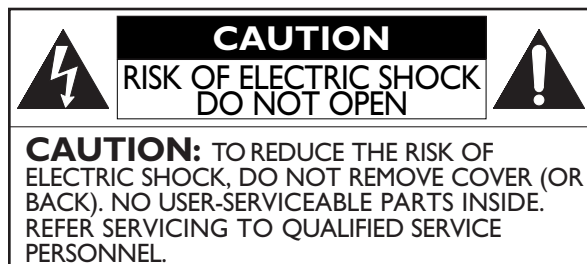

This "bolt of lightning" indicates uninsulated material within your unit may cause an electrical shock. For the safety of everyone in your household, please do not remove product covering.



The "exclamation point" calls attention to features for which you should read the enclosed literature closely to prevent operating and maintenance problems.

**WARNING:** To reduce the risk of fire or electric shock, this apparatus should not be exposed to rain or moisture, and objects filled with liquids, such as vases, should not be placed on this apparatus.

**CAUTION:** To prevent electric shock, match wide blade of plug to wide slot, fully insert.

**ATTENTION:** Pour éviter les choc électriques, introduire la lame la plus large de la fiche dans la borne correspondante de la prise et pousser jusqu'au fond.

### For Customer Use

Enter below the Model and Serial numbers which are located on the rear of the cabinet. Retain this information for future reference.

Model No. \_\_\_\_\_  
Serial No. \_\_\_\_\_

**PHILIPS** Visit our World Wide Web Site at <http://www.philips.com/welcome>

## Safety Information 3

English

# IMPORTANT SAFETY INSTRUCTIONS

## Read before operating equipment

1. Read these instructions.
2. Keep these instructions.
3. Heed all warnings.
4. Follow all instructions.
5. Do not use this apparatus near water.
6. Clean only with a dry cloth.
7. Do not block any of the ventilation openings. Install in accordance with the manufacturers instructions.
8. Do not install near any heat sources such as radiators, heat registers, stoves, or other apparatus (including amplifiers) that produce heat.
9. Do not defeat the safety purpose of the polarized or grounding type plug. A polarized plug has two blades with one wider than the other. A grounding type plug has two blades and a third grounding prong. The wide blade or third prong are provided for your safety. When the provided plug does not fit into your outlet, consult an electrician for replacement of the obsolete outlet.
10. Protect the power cord from being walked on or pinched particularly at plugs, convenience receptacles, and the point where they exit from the apparatus.
11. Only use attachments/accessories specified by the manufacturer.
12.  Use only with a cart, stand, tripod, bracket, or table specified by the manufacturer, or sold with the apparatus. When a cart is used, use caution when moving the cart/apparatus combination to avoid injury from tip-over.
13. Unplug this apparatus during lightning storms or when unused for long periods of time.
14. Refer all servicing to qualified service personnel. Servicing is required when the apparatus has been damaged in any way, such as power-supply cord or plug is damaged, liquid has been spilled or objects have fallen into apparatus, the apparatus has been exposed to rain or moisture, does not operate normally, or has been dropped.
15. This product may contain lead and mercury. Disposal of these materials may be regulated due to environmental considerations. For disposal or recycling information, please contact your local authorities or the Electronic Industries Alliance: [www.eiae.org](http://www.eiae.org)
16. **Damage Requiring Service** - The appliance should be serviced by qualified service personnel when:
  - A. The power supply cord or the plug has been damaged; or
  - B. Objects have fallen, or liquid has been spilled into the appliance; or
  - C. The appliance has been exposed to rain; or
  - D. The appliance does not appear to operate normally or exhibits a marked change in performance; or
  - E. The appliance has been dropped, or the enclosure damaged.
17. **Tilt/Stability** - All televisions must comply with recommended international global safety standards for tilt and stability properties of its cabinet design.

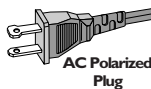

- Do not compromise these design standards by applying excessive pull force to the front, or top, of the cabinet which could ultimately overturn the product.
- Also, do not endanger yourself, or children, by placing electronic equipment/toys on the top of the cabinet. Such items could unsuspectingly fall from the top of the set and cause product damage and/or personal injury.

18. **Wall or Ceiling Mounting** - The appliance should be mounted to a wall or ceiling only as recommended by the manufacturer.
19. **Power Lines** - An outdoor antenna should be located away from power lines.
20. **Outdoor Antenna Grounding** - If an outside antenna is connected to the receiver, be sure the antenna system is grounded so as to provide some protection against voltage surges and built up static charges. Section 810 of the National Electric Code, ANSI/NFPA No. 70-1984, provides information with respect to proper grounding of the mast and supporting structure, grounding of the lead-in wire to an antenna discharge unit, size of grounding connectors, location of antenna-discharge unit, connection to grounding electrodes, and requirements for the grounding electrode. See Figure below.
21. **Object and Liquid Entry** - Care should be taken so that objects do not fall and liquids are not spilled into the enclosure through openings.
  - a) **Warning:** To reduce the risk of fire or electric shock, this apparatus should not be exposed to rain or moisture and objects filled with liquids, such as vases, should not be placed on this apparatus.
22. **Battery Usage CAUTION** - To prevent battery leakage that may result in bodily injury, property damage, or damage to the unit:
  - Install all batteries correctly, with + and - aligned as marked on the unit.
  - Do not mix batteries (old and new or carbon and alkaline, etc.).
  - Remove batteries when the unit is not used for a long time.
23. **Overloading** - Do not overload wall outlets, extension cords, or integral convenience receptacles as this can result in a risk of fire or electric shock.
24. **Object and Liquid Entry** - Never push objects of any kind into this product through openings as they may touch dangerous voltage points or short-out parts that could result in a fire or electric shock. Never spill liquid of any kind on the product.
25. **Replacement Parts** - When replacement parts are required, be sure the service technician has used replacement parts specified by the manufacturer or have the same characteristics as the original part. Unauthorized substitutions may result in fire, electric shock, or other hazards.
26. **Safety Check** - Upon completion of any service or repairs to this product, ask the service technician to perform safety checks to determine that the product is in proper operating condition.

**Note to the CATV system installer:** This reminder is provided to call the CATV system installer's attention to Article 820-40 of the NEC that provides guidelines for proper grounding and, in particular, specifies that the cable ground shall be connected to the grounding system of the building, as close to the point of cable entry as practical.

### Example of Antenna Grounding as per NEC - National Electric Code

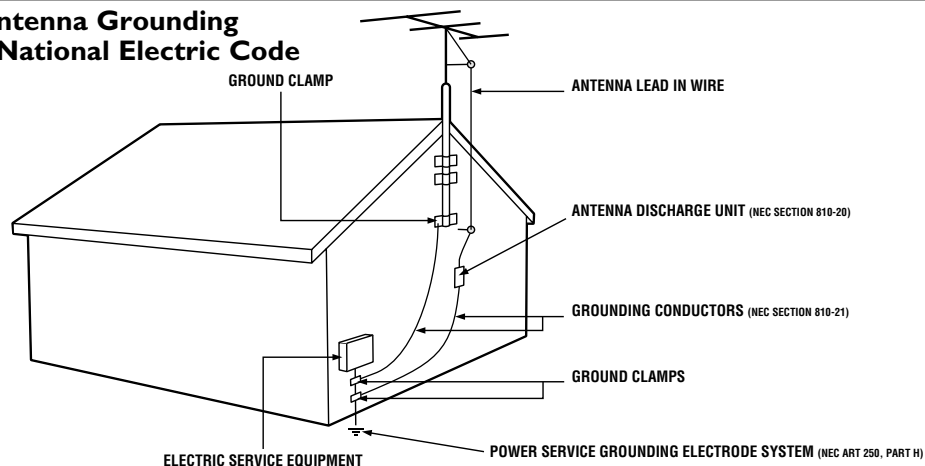

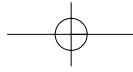

## 4 Safety Information (cont'd)

### Safety Precautions

**Warning:** To prevent fire or shock hazard, do not expose this equipment to rain or moisture.

**Federal Communications Commission (FCC) Warning:** Any unauthorized changes or modifications to this device void the user's authority to operate it.

- Do not stand the unit up vertically. Install the unit in a horizontal and stable position.
- Be sure to remove the disc and unplug the AC power cord from the outlet before carrying the unit.

**Department of Health and Human Services (DHHS) Certification:** Complies with 21 Center for Radiation (CFR) chapter 1 subchapter J applicable at time of manufacture.

**Laser Safety:** This unit employs a laser. Only a qualified service person should remove the cover or attempt to service this device, due to possible eye injury.

CAUTION: USE OF CONTROLS OR ADJUSTMENTS OR PERFORMANCE OF PROCEDURES OTHER THAN THOSE SPECIFIED HEREIN MAY RESULT IN HAZARDOUS RADIATION EXPOSURE.

CAUTION: VISIBLE AND INVISIBLE LASER RADIATION WHEN OPEN AND INTERLOCK DEFEATED. DO NOT STARE INTO BEAM. THE BEAM IS LOCATED INSIDE, NEAR THE DECK MECHANISM.

**Special Information for Canadian Users:** This Class B digital apparatus complies with Canadian ICES-003. Cet appareil numérique de la classe B est conforme à la norme NMB-003 du Canada.

**Radio/TV Interference:** This device has been tested and found to comply with the limits for a Class B digital device, pursuant to Part 15 of the FCC Rules. These limits are designed to provide reasonable protection against harmful interference in a residential installation. This device generates, uses, and can radiate radio frequency energy and, if not installed and used in accordance with the instructions, may cause harmful interference to radio communications.

However, there is no guarantee that interference will not occur in a particular installation. If this device does cause harmful interference to radio or television reception, which can be determined by turning the device off and on, the user is encouraged to try to correct the interference by one or more of the following measures:

- 1) Reorient or relocate the receiving antenna.
- 2) Increase the separation between the device and the receiver.
- 3) Connect the device into an outlet on a circuit different from that to which the receiver is connected.
- 4) Consult the dealer or an experienced radio/TV technician for help.

**Copyright Notice:** The making of unauthorized copies of copy-protected material, including computer programs, files, broadcasts and sound recordings, may be an infringement of copyrights and constitute a criminal offence. This equipment should not be used for such purposes.

**Copyright Protection:** Unauthorized copying, broadcasting, public performance, and lending of Discs are prohibited.

This product incorporates copyright protection technology that is protected by U.S. patents and other intellectual property rights. Use of this copyright protection technology must be authorized by Macrovision, and is intended for home and other limited viewing uses only unless otherwise authorized by Macrovision. Reverse engineering or disassembly is prohibited.

**Notice for Progressive Scan Use:** Consumers should note that not all high definition television sets are fully compatible with this product and may cause artifacts to be displayed in the picture. In case of picture problems with 525 (480) progressive scan output, it is recommended that the user switch the connection to the 'standard definition' output. If there are questions regarding your TV set compatibility with this 525p (480p) DVD player, please contact our customer service center.

### Declaration of Conformity

Model Number: DVP3345V  
 Trade Name: Philips  
 Responsible Party: P&F USA, Inc.  
 P.O. Box 672768 Marietta, Georgia 30006  
 1-866-771-4018

Manufactured under license from Dolby Laboratories. "Dolby" and the double-D symbol are trademarks of Dolby Laboratories.

Copyright 2009 Philips. All rights reserved.

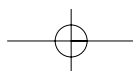

# Table of Contents 5

## General Information

Safety Information	3-4
Table of Contents	5
Introduction	6
Playable Discs and Video Cassettes	7

## Initial DVD/VCR Setup

Hookups	8-12
Remote Control Setup	13
First-time DVD/VCR Setup	14

## Basic Playback

Video Cassette Playback	15
Disc Playback	16

## Basic DVD/VCR Controls

Display Panel	17
Front Panel, Rear Panel and Remote Control	18

## Additional VCR Setup

Clock (VCR)	19
Language (VCR)	20
VCR Status Displays	20

## VCR Recording Options

Videotape Recording	21
One-Touch Recording	22
Rerecording (Tape Duplication)	23
Timer Recording	24-25
Satellite Link	26-27
DVD to Videotape Duplication	28

## Video Cassette Playing Options

Repeat Playback	29
Tape Counter	29
Time Search, Index Search	30
Special Effects Playback	31
Automatic Operation Features	31

## Additional VCR Features

Hi-Fi Stereo	32
--------------	----

## Disc Playback Features

Menus, Playback Control (PBC) Function	32
Fast Forward/Fast Reverse	33
x1.3 and x0.8 Rapid Play with Voice	33
Title/Chapter/Time Search	34
Track Search	35
Paused and Step-by-Step Playback, Resume On	36
Repeat, A-B Repeat	37
Markers	38
Subtitles, Camera Angles	39
Audio Language, Stereo Sound Mode	40
Slow Motion, Zoom	41
Program /Random Playback	42
MP3/Windows Media™ Audio/JPEG Playback	43-44
On-Screen Displays	45-46
Black Level, Virtual Surround	47
Initializing	47

## DVD Player Setup Options

Language	48-49
Display	50-51
Progressive Scan	51
Audio	52
Parental Password	53
Parental Levels	54
Others	55-56

## Information You May Need

Glossary	57
Helpful Hints	58-60
Care and Maintenance	61
Specifications	61
Limited Warranty	62
Information Index	63

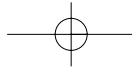

## 6 Introduction

### Welcome!

This DVD/VCR combines a Digital Video Disc (DVD) player and a Hi-Fi Video Cassette Recorder (VCR) into one unit, letting you play DVDs, Audio Compact Discs (Audio CDs), and Video Cassettes on one piece of equipment.

Read this owner's manual carefully to learn how to use the features listed below.

### VCR Features

- Automatic Head Cleaner
- English, French and Spanish Menus and Displays
- 19 Micron head
- Recording: One-Touch and Timer
- Repeat Playback
- Satellite Link
- Searching: Time, Index, Forward and Reverse
- Slow Motion
- Still Picture
- Tape Counter
- Tracking Adjustment

### Disc Features

- Audio Language choices \*
  - Camera Angles \*
  - DVD menus in a desired language \*
  - Markers
  - MP3 Playback
  - JPEG Playback
  - Windows Media™ Audio Playback
  - Dual Playback
  - Parental Control \*
  - Paused/Fast/Slow/Step-by-Step Playback
  - Program Playback
  - Progressive Scan
  - Random Playback
  - Repeat, A-B Repeat
  - Resume On
  - Specific Time/Title/Chapter/Track Search
  - Subtitles \*
  - Zoom
- \* If available on the disc

### Package Contents

The following items are provided with your new DVD/VCR.

- Remote Control and two AA batteries
- One set of Audio (red and white tips) and Video (yellow tips) cables
- This Owner's Manual and Quick Start Guide

### DVD Disc Menus...

Some explanations in this manual describe DVD Disc Menus. DVD manufacturers set the menus, which vary among DVDs. Not all DVDs have menus. If the DVD has a menu, access it by pressing DVD, then DISC MENU on the remote control.

*Details are on page 32.*

### DVD Player Setup Menu...

Some instructions explain how to use the DVD player's Setup Menu to set up features of the DVD player or a DVD. Access the DVD player menu by pressing SETUP on the remote control when playback is stopped. Even if a feature is set in the DVD player's menu, it may not be available if the current DVD does not include that feature.

### Available Disc Features...



All features described in this manual are not available on every disc. If the feature is not available on the disc, you cannot use the DVD/VCR to make it available. An "X" will appear in the top right corner of the TV screen if you try to access a feature that is not currently available.

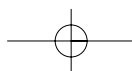



## Playable Discs and Video Cassettes 7

### Playable Discs

The DVD player will play Digital Video Discs (DVDs); finalized Digital Video Discs Recordable (DVD+R, DVD-R); finalized Digital Video Discs Rewritable (DVD+RW, DVD-RW); Video Compact Discs (VCDs); Audio Compact Discs (CDs); finalized Compact Discs Recordable (CD-R) and Compact Discs Rewritable (CD-RW).

To play a DVD, make sure it meets the requirements for Region Codes and Color Systems as described below. Discs that have the following logos will play on the DVD player. Other disc types are not guaranteed to play in the DVD/VCR.

- Do not stand the unit up vertically. Install the unit in a horizontal and stable position.
- Be sure to remove the disc and unplug the AC power cord from the outlet before carrying the unit.



DVD DVD+R DVD+RW DVD-R DVD-RW Video CD Audio CD CD-R CD-RW MP3 files

**DOLBY** DIGITAL. Manufactured under license from Dolby Laboratories. "Dolby" and the double-D symbol are trademarks of Dolby Laboratories.

is a trademark of DVD Format/Logo Licensing Corporation.

Windows Media is a trademark of Microsoft Corporation.

This unit is not compatible with Multiple Bit Rate (MBR: a file that contains the same content encoded at several different bit rates).

### ABOUT THE PBC FUNCTION OF VIDEO CD

This unit can play Video CD 1.1 (without PBC) and 2.0 (with PBC).

With version 2.0 (with PBC), you can use interactive menu (e.g., playlists) on the TV screen.

When playing a Video CD with PBC, some operations cannot be performed unless the PBC function is cancelled temporarily. See page 32 for more details.

### Region Codes

DVDs must be labeled for ALL regions or for Region 1 in order to play on this DVD player. You cannot play DVDs that are labeled for other regions.

Look for the symbols below on your DVDs. If these region symbols do not appear on your DVD, you cannot play the DVD in this player.



The number inside the globe refers to a region of the world. Region 1 represents the United States, Canada, upper regions of North America, Bermuda, the U.S. Virgin Islands, and small regions near Australia.

A disc encoded in a specific region format can only play on DVD players with the same region code. For example, if a disc is labeled for Region 2, you cannot play the DVD on this player.

### Color Systems

Different color systems are available throughout the world. The most common color systems are NTSC, which is used primarily in the United States and North America, PAL, and SECAM.

This DVD player will play both NTSC and PAL DVDs. You cannot play DVDs recorded in other formats.

The color system of the DVD may be listed on the DVD or on the disc case. Your TV must have the NTSC and/or PAL color system as well.

### Playable Video Cassettes

The VCR of this DVD/VCR has a High Quality (HQ) system and is compatible with existing Video Home System (VHS) equipment. Use only video cassettes that have the mark. The use of other tapes may result in poor picture quality and excessive deposits on the video heads, which may not be covered by the warranty if damage occurs.

The VCR also has a 19 micron head, which provides a better picture when you view tapes recorded in slow speed (SLP).

### Unacceptable Discs

If you insert an unacceptable type of disc, a Disc Error message may appear on the TV screen. The following discs will not play on this DVD player:

- CD-ROM
- Video Single Disc (VSD)
- Unfinalized disc
- Non-compatible recording mode
- Compact Disc-Interactive (CD-I)
- DVD-ROM
- DVD contains MP3, Windows Media™ Audio or JPEG files
- DVD-RAM
- DVD-Audio

On the following disc, the sound may not be heard.

- Super Audio CD - Only the sound on the CD layer can be heard. The sound on the high-density Super Audio CD layer cannot be heard.

## 8 Hookups

### Determining the best possible connection...

Your hookup will be determined primarily by your existing equipment, especially your TV. These guidelines describe which options have the best picture and sound quality. You will not use all the jacks on the DVD/VCR.

- ★★★★ If your TV has Component Video In jacks (which could be labeled Y CR CB, Y PR PB or YUV and may be green, blue and red), use the Component Video jacks (Y CB/PB CR/PR) for the best picture quality. If you use only this video connection, only the DVD picture will be available. To see DVD features on the TV, set the TV to its Component Video In channel. Component Video provides the best picture quality. See page 10. Progressive Scan provides less flickering and higher image resolution than traditional (525i/480i or interlace) TV signals.  
**If your TV has Progressive Scan (525p/480p or progressive)**, connect the TV to the DVD/VCR's COMPONENT VIDEO OUT (Y CB/PB CR/PR) jacks. Set Progressive Scan (PROG. SCAN) to ON in the DVD/VCR's DISPLAY Menu. See pages 50-51. PSCAN will appear on the DVD/VCR's display panel. Set your TV to Progressive Scan also.  
**If your TV does not have Progressive Scan but has Component Video In jacks**, connect them to the DVD/VCR's COMPONENT VIDEO OUT jacks (Y CB/PB CR/PR). Set Progressive Scan (PROG. SCAN) to OFF either in the DISPLAY Menu or by pressing and holding PLAY ► (DVD) on the front of the DVD/VCR for more than 5 seconds. See pages 50-51.
- ★★★ If your TV has an S-Video In jack (which also may be labeled Y/C or S-VHS), use the S-VIDEO OUT jack for excellent picture quality. If you use only this video connection, only the DVD picture will be available. To see DVD features on the TV, set the TV to its S-Video In channel. See page 10.
- ★★ If your TV has a single yellow Video In jack (which also may be labeled CVBS, Composite or baseband), use the yellow DVD/VCR VIDEO OUT jack for good picture quality. This connection provides a picture for both the DVD player and the VCR. To see DVD or VCR features on the TV, set the TV to its Video In channel. See page 9
- ★★★★ If you have a Stereo with a Coaxial Digital Audio In jack, this provides the clearest sound for the DVD player. Connect the DVD/VCR's COAXIAL DIGITAL AUDIO OUT jack to your Stereo for the best sound quality. If you use only this audio connection, only disc sound (no VCR) will be available. See page 12.
- ★★★ If digital audio connections are not possible, connect the DVD/VCR's red and white DVD/VCR AUDIO OUT jacks to the Audio In jacks of your Stereo or TV. This connection provides sound for both the DVD player and the VCR. See pages 10-11.

### Before you begin...

- Refer to the manuals of your TV, Cable Box, Stereo or other devices as necessary. Note the style of jacks and connectors on the other equipment. Determine how to choose different Audio and Video In channels on your other equipment so you can see and hear the DVD/VCR material playing on the TV, Stereo, etc.
- Disconnect all equipment from the power outlets. Connect the equipment to power only after you have finished hooking up everything. Never make or change connections with equipment connected to power.

### Remember...

- Set the TV to the correct Video In channel. Such channels may be called AUX or AUXILIARY IN, AUDIO/VIDEO or A/V IN, EXT1 or External In, etc. These channels often are located near channel zero (0). Or, your TV's remote may have a button or switch that selects the Video Input channel. See your TV manual for details. If you do not see the DVD or VCR playback on the TV, go to the lowest TV channel (01 or 02) and change channels downward until you see the DVD or VCR picture on the TV.  
To help you find the right Audio/Video In channel, turn on the DVD/VCR. Press DVD to put the DVD/VCR in DVD mode. With no disc in the player, a large DVD Video logo will appear on the TV screen when you get the TV on the correct Audio/Video In channel.
- Set the Stereo to the correct channel or "source" mode.
- Depending on your connection, you may need to purchase additional cables or adaptors. If your TV or monitor has BNC-type connectors, you will need an adaptor.

**Once you determine the best option, find your choice on pages 9-12. Follow the steps for the hookup you choose. Then, go to page 14 to complete the first-time setup.**



## Hookups (cont'd) 9

### DVD/VCR to An External Tuner

This DVD/VCR does not have a tuner input jack. To record TV programs on your DVD/VCR, you need to connect this DVD/VCR to an external tuner device (e.g., set top box, cable box or satellite receiver) that has audio/video output jacks.

e.g.)

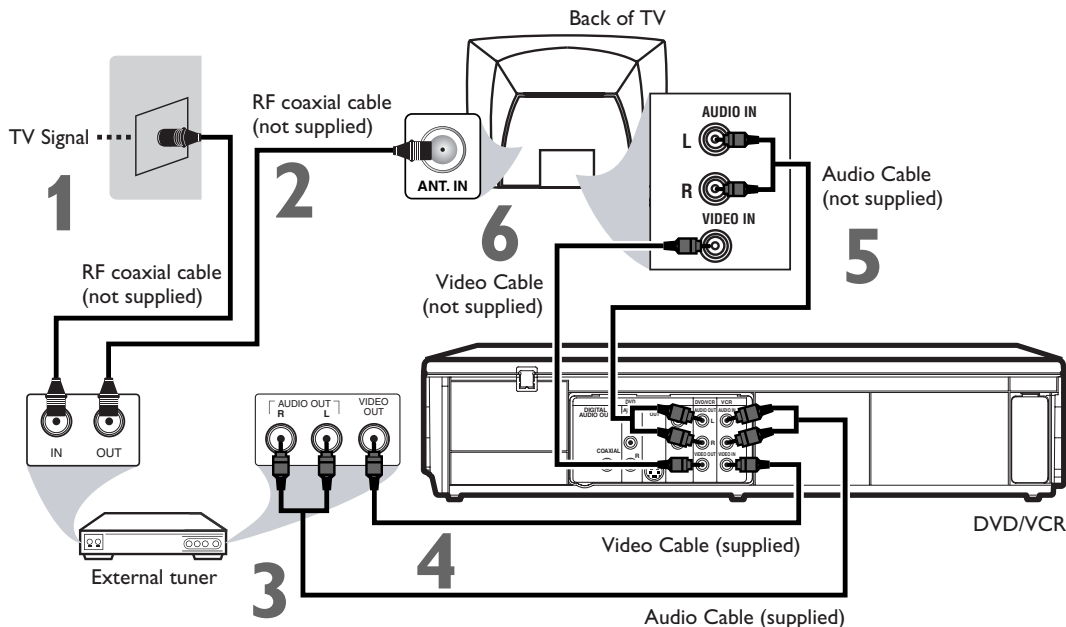

#### Connections

- 1** Connect a TV signal to the IN jack on the external tuner.
  - 2** Use an RF coaxial cable (not supplied) to connect the OUT jack on the external tuner to the ANT. IN jack on the TV.
  - 3** Connect the red and white audio cable (supplied) to the red and white AUDIO OUT jacks on the external tuner and to the red and white VCR AUDIO IN jacks on the DVD/VCR.
  - 4** Connect the yellow video cable (supplied) to the yellow VIDEO OUT jack on the external tuner and to the VCR VIDEO IN jack on the DVD/VCR.
  - 5** Connect another red and white audio cable (not supplied) to the red and white DVD/VCR AUDIO OUT jacks on the DVD/VCR and to the red and white AUDIO IN jacks on the TV.
  - 6** Connect another yellow video cable (not supplied) to the DVD/VCR VIDEO OUT jack on the DVD/VCR and to the VIDEO IN jack on the TV.
  - 7** Connect the power cords of the TV and the DVD/VCR to a power outlet. Turn on the TV and set it to the correct Video In channel.
  - 8** You are ready to turn on the DVD/VCR. Go to page 14 to complete the first-time setup.
- You can record any unscrambled channel by selecting the channel on the external tuner. Be sure that the external tuner is turned on.
  - Signal from the external tuner can be output only on CVBS output even when the power of the DVD/VCR is off.
  - **You cannot record one channel while watching another channel.**

#### Helpful Hints

- If your TV has antenna in jack only, it is still possible to connect this unit to your TV by using a commercially available stereo audio/video RF modulator. Refer to the manual accompanying the modulator for more information.
- Required cables and connecting methods differ depending on the external tuner. For more information, please contact your external tuner provider.
- **Line through output**  
When an external device, such as cable/satellite box, is connected to L1(Rear) jacks of this DVD/VCR, the signal from the external device can be output even when the power of the DVD/VCR is off.
- Instead of using video out jack of this DVD/VCR, you can also use S-video out jack or component video output jack for connecting to your TV.
- Refer to the manual accompanying external devices for more information.

## 10 Hookups (cont'd)

### DVD/VCR to a TV that has Audio/Video, Component Video or S-Video In jacks

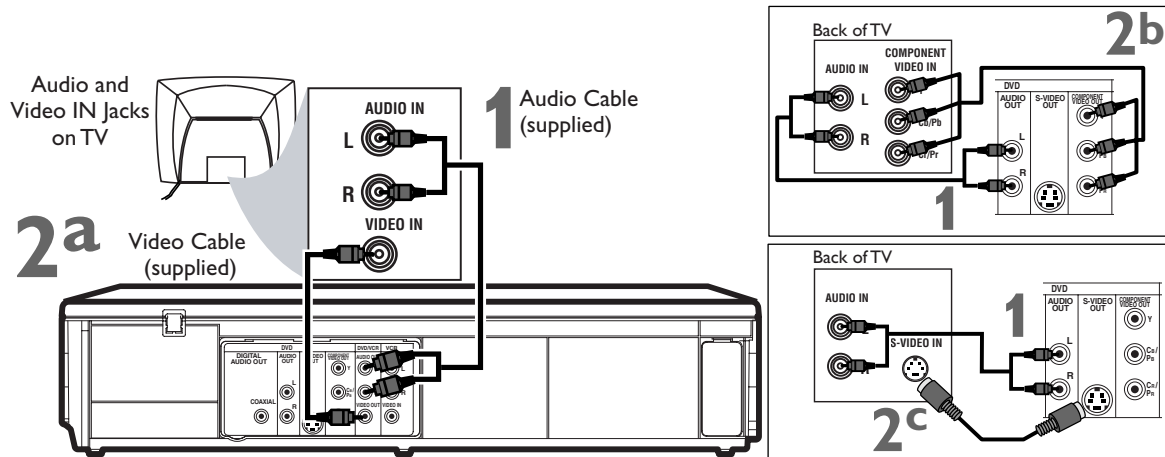

- 1** Connect the red and white audio cable (supplied) to the red and white DVD or DVD/VCR AUDIO OUT jacks on the DVD/VCR and to the red and white AUDIO IN jacks on the TV.

  - If you are using DVD/VCR AUDIO OUT jacks for your audio connection, use 2a method for your video connection. If you are using DVD AUDIO OUT jacks for your audio connection, use 2b or 2c method for your video connection.
- 2a** Connect the yellow video cable (supplied) to the DVD/VCR VIDEO OUT jack on the DVD/VCR and to the VIDEO IN jack on the TV. The VIDEO IN jack on the TV is usually yellow and may be labeled CVBS, Composite or Baseband video.
- 2b** Connect component video cable (not supplied) to the COMPONENT VIDEO OUT jacks on the DVD/VCR and to the COMPONENT VIDEO IN jacks on the TV. The Component Video In jacks on the TV are usually red, blue and green.
- 2c** Connect an S-Video cable (not supplied) to the S-VIDEO OUT jack on the DVD/VCR and to the S-VIDEO IN jack on the TV.
- 3** Connect the power cords of the TV and the DVD/VCR to a power outlet. Turn on the TV and set it to the correct Video In channel.

If you are using the yellow video cable for VCR playback, choose the Video In channel at your TV. To find the correct Video In channel, go to your lowest TV channel and change channels downward until you see VCR playback on the TV screen. To help you find the right Video In channel, turn on the DVD/VCR. Press DVD to put the DVD/VCR in DVD mode. With no disc in the player, a large DVD Video logo will appear on the TV screen when you get the TV on the correct Video In channel.
- 4** You are ready to turn on the DVD/VCR. Go to page 14 to complete the first-time setup.

#### Helpful Hint

- Match the cable colors to the jack colors. If the TV has a single AUDIO IN jack, use the white audio cable to connect the DVD/VCR's white AUDIO OUT (left) jack to the TV's AUDIO IN jack. You will not use the red cable. Or, purchase a "splitter" audio cable to go from the left/right AUDIO OUT jacks of the DVD/VCR to the TV's single AUDIO IN jack.

## Hookups (cont'd) 11

### DVD/VCR to a TV and a Stereo

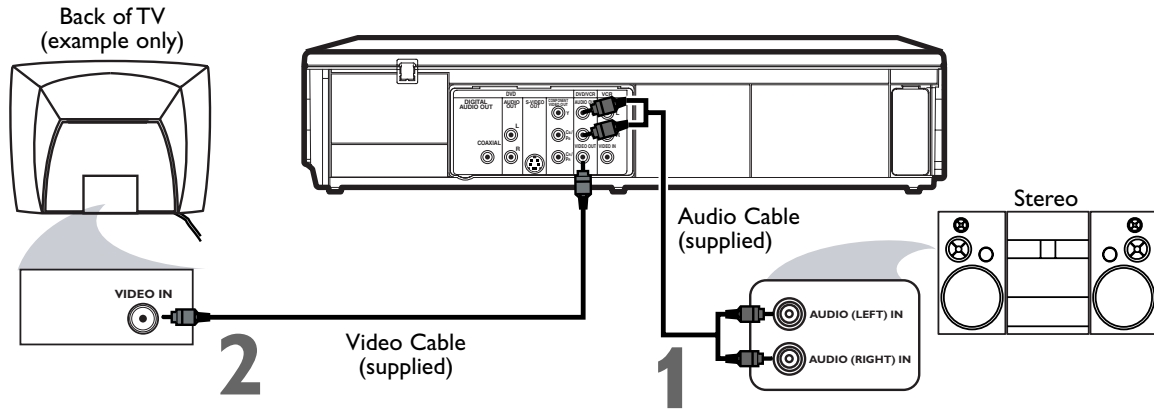

- 1** Connect the supplied red and white audio cable to the red and white **DVD/VCR AUDIO OUT** jacks on the **DVD/VCR** and to the red and white **AUDIO IN** jacks on the **Stereo**. Match the cable colors to the jack colors.
- 2** Connect the supplied yellow video cable to the **DVD/VCR VIDEO OUT** jack on the **DVD/VCR** and to the **VIDEO IN** jack on the **TV**. To use Component Video cable or S-Video cable instead for the DVD player, see page 10. You will still need the yellow video cable for VCR features.
- 3** Connect the power cords of the **DVD/VCR**, **TV** and **Stereo** to a power outlet. Turn on the **TV** and set it to the **Video In** channel. Or, simply go to your TV's lowest channel (01 or 02) and continue changing channels downward at the TV until you see VCR or DVD playback on the TV screen.  
To help you find the right Video In channel at the TV, turn on the DVD/VCR. Press DVD to put the DVD/VCR in DVD mode. With no disc in the player, a large DVD Video logo will appear on the TV screen when you get the TV on the correct Video In channel.  
**Turn on the Stereo** and set it to the correct auxiliary or source mode. Check your Stereo manual for details.
- 4** You are ready to turn on the **DVD/VCR**. Go to page 14 before turning on the **DVD/VCR**.

## 12 Hookups (cont'd)

### DVD/VCR to a TV and to a Stereo that is Dolby Digital-compatible Using Digital Audio connections

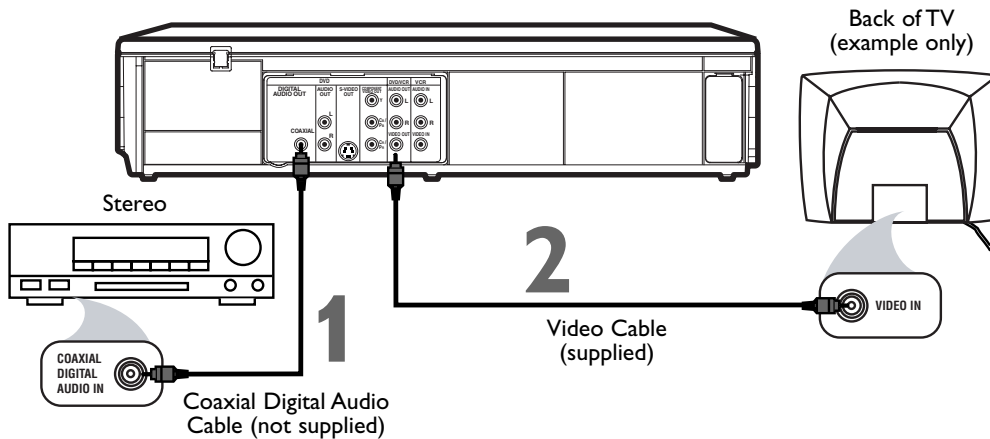

- 1** Connect a coaxial digital audio cable (not supplied) to the DVD/VCR's **COAXIAL DIGITAL AUDIO OUT** jack and to the **COAXIAL DIGITAL AUDIO IN** jack on the Stereo.

This digital audio connection only provides sound for the DVD player of the DVD/VCR. So, in order to use the VCR features, connect the supplied red/white audio cable. To connect the red/white audio cable, see step 5 on page 9.
- 2** Connect the supplied yellow video cable to the yellow **DVD/VCR VIDEO OUT** jack on the DVD/VCR and to the **VIDEO IN** jack on the TV. To use component video cable or S-Video cable instead for the DVD player, see page 10. You will still need the yellow video cable for VCR features.
- 3** Plug in the power cords of the Stereo, TV and DVD/VCR. Turn on the Stereo and select its **Auxiliary IN** channel. Turn on the TV and set it to the correct **Video In** channel. Go to your TV's lowest channel (01 or 02) and change channels downward until you see DVD or VCR material on the TV screen. To help you find the right Video In channel on the TV, turn on the DVD/VCR. Press DVD to put the DVD/VCR in DVD mode. With no disc in the player, a large DVD Video logo will appear on the TV screen when you get the TV on the correct Video In channel.

Make sure Progressive Scan (PROG. SCAN) is OFF and PSCAN does not appear on the DVD/VCR's display panel. Disable Progressive Scan either in the DISPLAY Menu or by pressing and holding **PLAY ► (DVD)** on the front of the DVD/VCR for more than 5 seconds. Details are on pages 8 and 51.
- 4** You are ready to turn on the DVD/VCR. Go to page 14 before turning on the DVD/VCR.

#### Remember...

Some DVDs are recorded in Dolby Digital Multi-channel Surround Sound. Select Dolby Digital Multi-channel Surround Sound in the DVD Disc Menu. If Dolby Digital Surround Sound is not recorded on the disc, you will not have surround sound available. If you connect the DVD/VCR to a Dolby Digital Stereo, set DOLBY DIGITAL to BITSTREAM in the DVD player's Setup Menu. Details are on page 52. If the DVD/VCR is not connected to a Dolby Digital-compatible Stereo, set DOLBY DIGITAL to PCM. Incorrect settings may cause noise distortion and damage the speakers.

## Remote Control Setup 13

### Putting Batteries in the Remote Control

- 1** Remove the battery compartment lid on the bottom of the remote control by pressing the tab, then lifting the lid.
- 2** Place two AA batteries inside the battery compartment with their + and – ends aligned as indicated.
- 3** Replace the battery compartment lid.

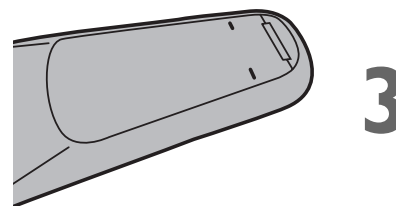
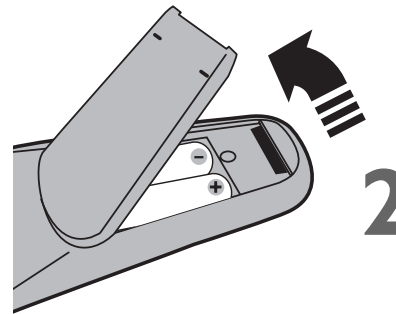
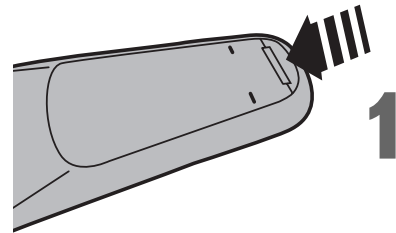

### Using the Remote Control

- Point the remote control at the DVD/VCR's remote sensor (see page 18) when using the remote to operate the DVD/VCR. Do not point the remote at the TV.
- Do not put objects between the remote and the DVD/VCR.

### Recycling Guidelines/Battery Safety

- Your new product and its packaging contain materials that can be recycled and reused. Specialized companies can recycle your product to increase the amount that needs to be properly disposed. Your product uses batteries that should not be thrown away when depleted but should be disposed of as small chemical waste. Please find out about the local regulations on disposal of your old product, batteries and packaging whenever you replace existing equipment.
- Battery Usage CAUTION - To prevent battery leakage that may result in bodily injury, property damage or damage to the unit:
  - Install ALL batteries correctly, with the + and – markings on the battery aligned as indicated on the unit.
  - Do not mix batteries, for example, old with new or carbon with alkaline.
  - Remove batteries when the unit will not be used for a long time.

## 14 First-time DVD/VCR Setup

Before turning on your DVD/VCR, make sure batteries are in the remote control and the DVD/VCR and TV are connected correctly. **These menus may not appear if you have already turned on the DVD/VCR.**

- 1 Turn on the TV. Set it to the correct Video In channel.** (Check your TV owner's manual for details.)
- 2 Press  $\odot$ .** VCR light will appear on the front of the DVD/VCR. The display shown below will appear. These menus may not appear if you have already turned on the DVD/VCR. You may have turned on the DVD/VCR before to find the Audio/Video In channel of the TV, for example. If so, follow the steps on page 20 to select a language for the VCR menu.

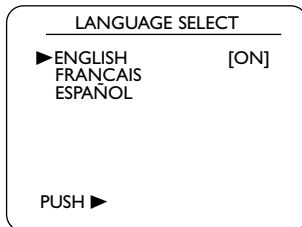

- 3 Press  $\blacktriangle$  or  $\blacktriangledown$  to select ENGLISH, FRANCAIS (French) or ESPAÑOL (Spanish) as the language for VCR On-Screen Displays and menus. Then, press  $\blacktriangleright$ .**
  - To put the DVD/VCR in VCR mode, press VCR so VCR light appears.

- 1 Turn on the TV.**

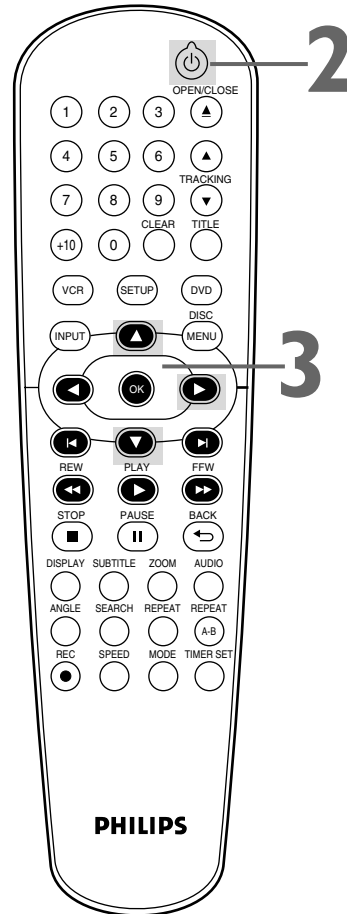

### Helpful Hints

- To skip this feature and play a tape immediately, insert a tape with its record tab removed.
- Repeat this process if the power fails.



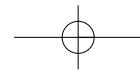

## Video Cassette Playback 15

Read and follow the steps below to play a tape.

- 1 Turn on the TV. Set it to the correct Video In channel.** (Check your TV owner's manual for details.)  
*Details are on page 8.*
- 2 Insert a tape in the cassette compartment of the DVD/VCR.** VCR light will appear on the front of the DVD/VCR. If the tape's record tab has been removed, playback will start automatically.  
If the DVD/VCR power is already on, press VCR to put the DVD/VCR in VCR mode if necessary. VCR light will appear on the front of the DVD/VCR.
  - If playback does not start automatically, press VCR, then press PLAY ►.
  - Press STOP ■ to stop playback.
  - Press REW ◀◀ to rewind the tape.
  - After the tape stops, press STOP/EJECT ■▲ on the front of the DVD/VCR to remove the tape.

- 1** Turn on the TV.
- 2** Insert a tape in the DVD/VCR.

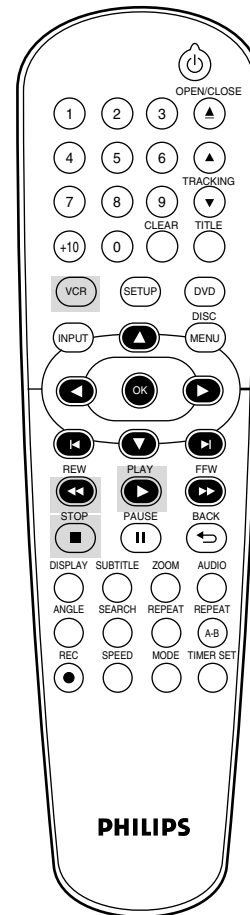







### Helpful Hints

- Other tape playback features are on pages 29-32.
- If AUTO REPEAT is ON, playback will begin when you insert a tape, even when the record tab is intact. *Details are on page 29.*
- You must connect the DVD/VCR to a TV using the audio/video cables in order to use the VCR features. These hookups are explained on pages 9 and 11.

## 16 Disc Playback

Before you begin, turn on the TV, Stereo and other equipment connected to the DVD/VCR. Make sure the TV and the Stereo (if applicable) are set to the correct channel.



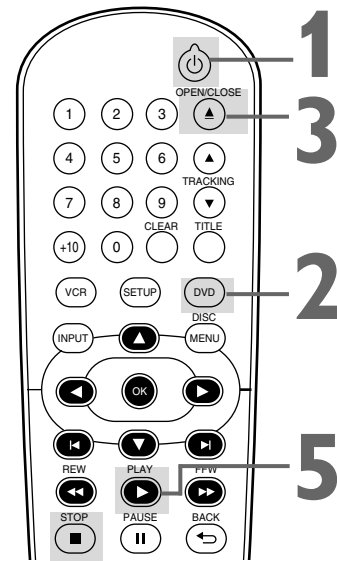

Details are on pages 8-12.

- 1** Press  to turn on the DVD/VCR.
  - 2** Press DVD so DVD light appears on the front of the DVD/VCR.
  - 3** Press OPEN/CLOSE  to open the disc tray.
  - 4** Place a disc onto the tray. If the DVD is recorded on only one side, place the disc on the tray with the label facing up and the shiny side facing down. Some DVDs are recorded on both sides. Make sure the label of the side you want to play is facing up.
  - 5** Press PLAY  to close the tray. The tray will close and playback will begin. If playback does not start automatically, press PLAY  again.  
If a DVD Menu appears instead, see page 32.  
To play MP3, Windows Media™ Audio or JPEG files, see pages 43-44.  
You also can close the tray by pressing OPEN/CLOSE .
- Press STOP  to stop playback.



- 4** Insert a disc.

### Helpful Hints

- An "X" may appear at the top right corner of the TV screen when you try a feature. Either the feature is not available on the disc, or the DVD/VCR cannot access the feature at this time. This does not indicate a problem with the DVD/VCR.
- If a disc is dirty or scratched, the picture may appear distorted or playback may stop. In such cases, remove the disc and turn off the DVD/VCR. Disconnect the power cord, then reconnect it. Clean the disc, then turn on the DVD/VCR again and reinsert the disc for playback.
- If a disc has multiple layers, the picture may freeze occasionally. This happens when the first layer switches to the second layer. This is not a malfunction.
- When the DVD or CD light appears on the display panel, the disc is loaded and ready for playback.
- When you press OPEN/CLOSE  or PLAY  (DVD) on the front of the DVD/VCR when the power is off, the DVD/VCR will turn on in DVD mode. Otherwise, the DVD/VCR will turn on in the mode in which it was turned off.
- If you use PLAY  to close the disc tray, playback starts automatically. If you use OPEN/CLOSE  to close the disc tray, you have to press PLAY  to start playback.

**REMINDER: This DVD/VCR will play only certain discs. See page 7 for details.**

# Display Panel 17

## VCR light

This light appears when the DVD/VCR is in VCR mode. You can only watch videotapes or access VCR features when VCR light is on. To make VCR light come on, press VCR on the remote control or SOURCE on the front of the DVD/VCR.

## DVD light

This light appears when the DVD/VCR is in DVD mode. You can only watch DVDs when DVD light is on. To make DVD light come on, press SOURCE on the front of the DVD/VCR or DVD on the remote control.

## Cassette Compartment

Insert a video cassette here.

## Display

Messages about current disc operations appear here. See Display Messages below.

## Disc tray

Insert a disc here.

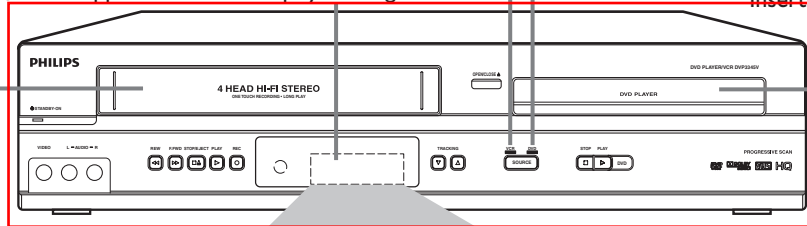

## DVD Display Panel

Appears when a repeat function is active.

Appears when A-B Repeat is on.

Appears when ALL Repeat is on. (Video CD, CD, MP3, Windows Media™ Audio and JPEG)

Appears when disc playback is paused.

Appears during Slow Motion Playback (DVD, Video CD).

Appears during disc playback.

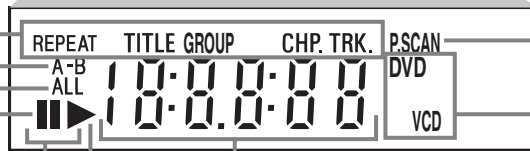

Appears when Progressive Scan is active.

Displays the elapsed time of the title or track. The number of a new title, chapter, or track is displayed for 3 seconds when a chapter or track is switched, or DISPLAY is pressed during playback.

Displays the current disc type.  
 • DVD: DVD  
 • VCD: Video CD  
 • CD: Audio CD, MP3, Windows Media™ Audio, JPEG

## VCR Display Panel

Indicates a tape is in the DVD/VCR.

Appears during playback when the Auto Repeat function is on.

Appears if tape playback is paused.

Appears during Slow Motion Playback.

Appears during tape playback.

Appears when an OTR, Timer Recording, or Satellite Link has been set.

Appears during recording; flashes when recording is paused.

Indicates current time is P.M. There is no A.M. indication.

Indicates the elapsed playing time of a tape; also displays a selected external input channel, tape speed, remaining time for an OTR or the current time.

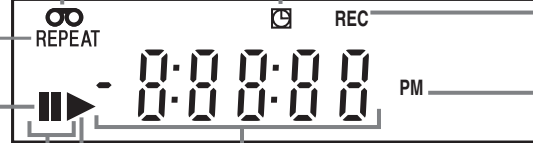

## Display Messages

- - - -	Appears after the disc tray closes if the tray is empty, if there is an error reading the disc, or if an unacceptable disc is installed.	CLOSE	Tray is closing.
OPEN	Tray is opening or is open.	Load	Disc is loading.
		Pbc	Appears when Playback Control is active (Video CD).

# 18 Front Panel, Rear Panel and Remote Control

## Front Panel

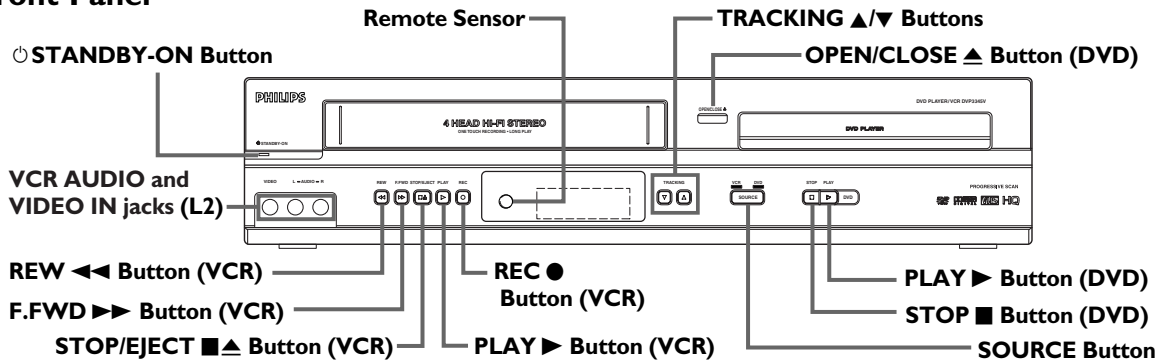

## Rear Panel

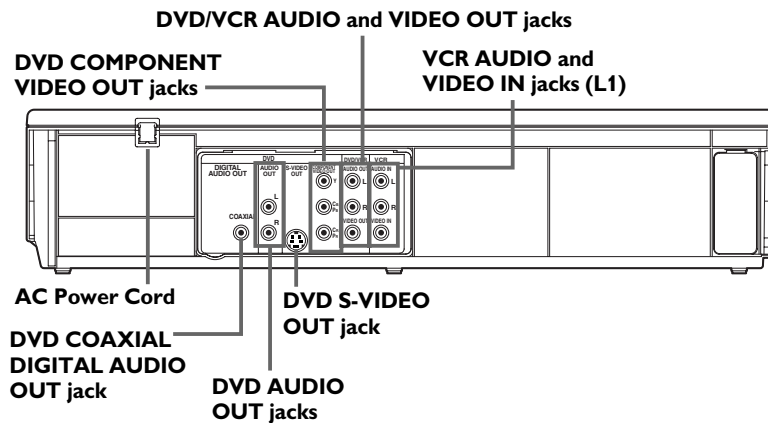

**Helpful Hint**

- The DVD S-VIDEO OUT, DVD COMPONENT VIDEO OUT, DVD AUDIO OUT and DVD COAXIAL DIGITAL AUDIO OUT jacks are only useful in DVD mode. To have sound and picture in VCR mode, you must connect the audio/video cables supplied. Details are on pages 9-11.

## Remote Control

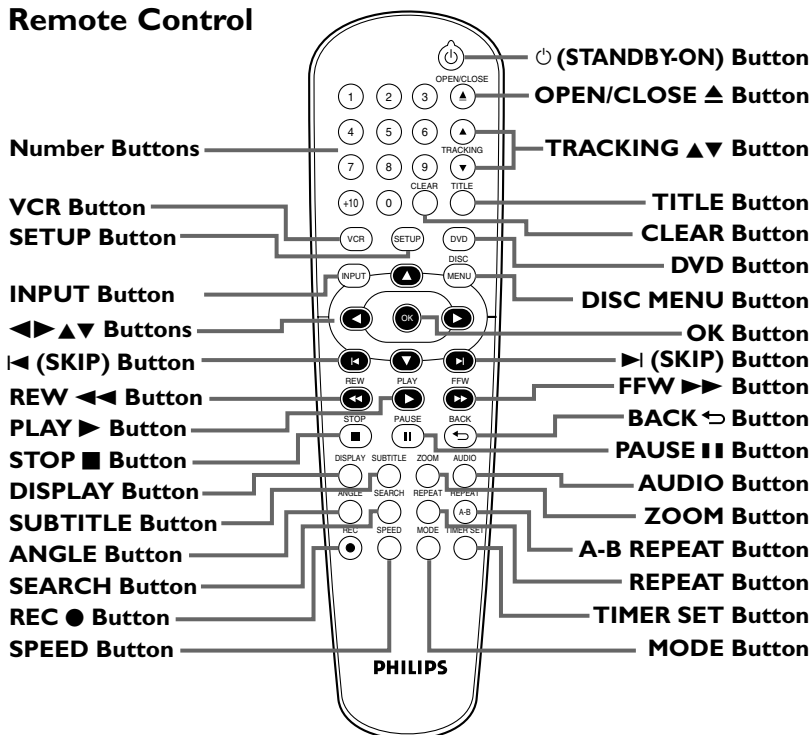

**Helpful Hints**

- For DVD player features, press DVD before pressing other buttons. To put the DVD/VCR in DVD mode, press DVD or SOURCE so DVD light appears on the front of the DVD/VCR.
- For VCR features, press VCR before pressing other buttons. To put the DVD/VCR in VCR mode, press VCR or SOURCE so VCR light appears on the front of the DVD/VCR.

## Clock (VCR) 19

Follow these steps to set the VCR clock. Make sure:

- 1 Press **VCR**, then press **SETUP** so MENU appears. If the clock has never been set, the **CLOCK SET** Menu may appear when you press **SETUP**. If so, follow the instructions from step 3 on this page.

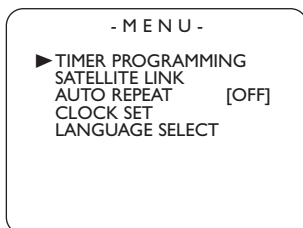

- 2 Press **▲** or **▼** to select **CLOCK SET**. Then, press **▶**.

- 3 While the **MONTH** space is flashing, press **▲** or **▼** until the month appears. Then, press **▶**.

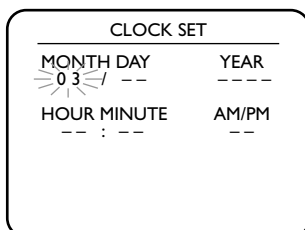

- 4 While the **DAY** space is flashing, press **▲** or **▼** until the day appears. Then, press **▶**.

- 5 While the **YEAR** space is flashing, press **▲** or **▼** until the year appears. Then, press **▶**. The day of the week will appear automatically.

- 6 While the **HOUR** space is flashing, press **▲** or **▼** until the hour appears. Then, press **▶**.

- 7 While the **MINUTE** space is flashing, press **▲** or **▼** until the minute appears. Then, press **▶**.

- 8 While the **AM** or **PM** space is flashing, press **▲** or **▼** to point to **AM** or **PM**. Your selection will flash on the screen in the AM/PM space.

- 9 Press **CLEAR** or **▶** to start the clock.

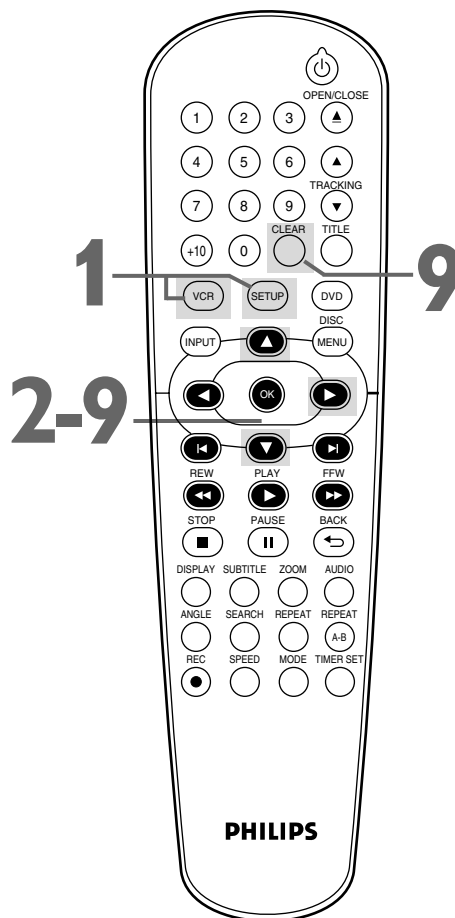

### Helpful Hints

- If the clock has never been set, the **CLOCK SET** Menu may appear when you press **SETUP**. If so, follow the instructions from step 3 above.
- Press **DISPLAY** repeatedly to show the time on the TV screen.
- Power failures of more than 30 seconds can erase the Clock Setting.
- To reset the clock, follow steps 1-2. Select the information you want to change using **◀** or **▶**. When the information is flashing, use **▲** or **▼** to enter the correct information. Press **CLEAR** to set the clock.

## 20 Language (VCR)

Follow the steps below to change the language of the VCR On-Screen Displays and menus.

- 1** Press **VCR**, then press **SETUP** so MENU appears.

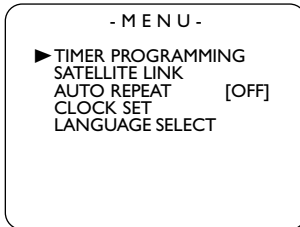

- 2** Press **▲** or **▼** to choose **LANGUAGE SELECT**, then press **▶**.

- 3** Press **▲** or **▼** to choose **ENGLISH**, **FRANCAIS** (French) or **ESPAÑOL** (Spanish).

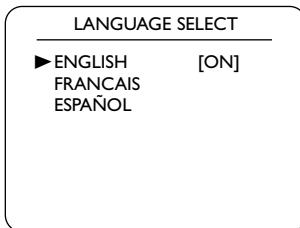

- 4** Press **CLEAR** to remove the menu.

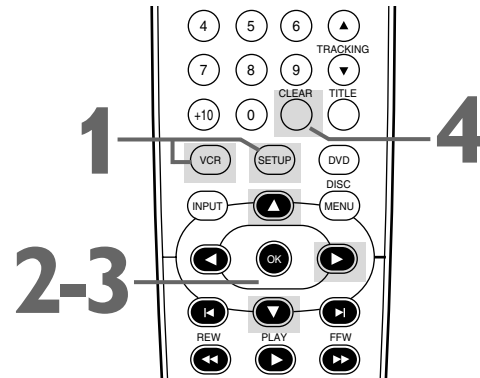

### Helpful Hint

- If you select FRANCAIS (French), or ESPAÑOL (Spanish) and need English:
  - 1) Press **SETUP** so **MENU** appears.
  - 2) Press **▼** to choose **SELECTION LANGUE** or **SELEC. IDIOMA**, then press **▶**.
  - 3) Press **▲** or **▼** to select **ENGLISH**.
  - 4) Press **CLEAR**.

## VCR Status Displays

You may access Status Displays by pressing **DISPLAY**. The displays may include the current time, external input channel and other information.

- 1** Press **DISPLAY**. The **COUNT** Display will appear for 5 seconds. After 5 seconds, only the real-time tape counter will appear. This counter shows you the elapsed playing time of the tape (from the point at which the counter was set to 0). The counter also will appear on the display panel on the front of the DVD/VCR.

- 2** Press **DISPLAY** again. The **CLOCK** Display will appear for 5 seconds. After 5 seconds, only the time will appear. The time also will appear on the display panel on the front of the DVD/VCR.

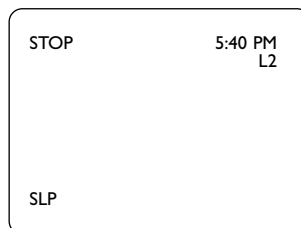
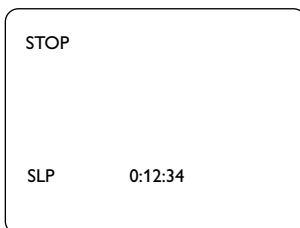

- 3** Press **DISPLAY** again to remove all the displays.

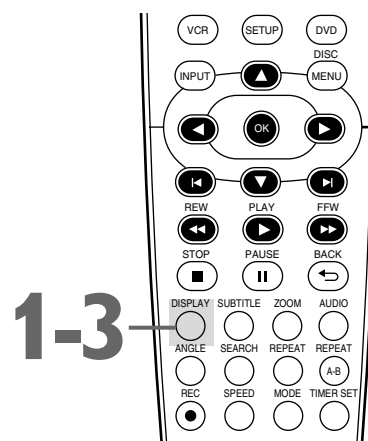

### Helpful Hint

- You cannot access a Status Display when viewing a still picture, during slow motion, or during Forward and Reverse Searching.



## Videotape Recording 21

Read and follow the steps below to record a television program onto a videotape.

Before you begin:

- **This DVD/VCR does not have a tuner input jack. To record TV programs on your DVD/VCR, you need to connect this DVD/VCR to an external tuner device (e.g., set top box, cable box or satellite receiver) that has audio/video output jacks.** See page 9 on how to connect the DVD/VCR to the external tuner.
- Make sure the DVD/VCR is in VCR mode. Press VCR so VCR light appears on the front of the DVD/VCR.

- 1 Turn on your external tuner, and turn on the TV and set it to the correct Video In channel.** (Check your TV owner's manual for details.)
- 2 Insert a tape with its record tab intact into the cassette compartment of the DVD/VCR.** If tape playback begins, press STOP ■.
- 3 Press SPEED repeatedly until the desired tape speed (SP or SLP) appears briefly on the screen.** Details about tape speed are on page 57.
- 4 Press INPUT to select the appropriate external input channel (L1/L2) to which your external tuner is connected. Then select the desired channel to record on the external tuner.**
- 5 Press REC ● to start recording.** "REC" will appear on the DVD/VCR's display panel.
  - To pause the recording, press PAUSE ■■ once. "REC" will flash. To resume recording, press REC ● or press PAUSE ■■ again. "REC" will reappear.
  - To stop recording, press STOP ■.

### Recording Prevention

Video cassettes have record tabs to ensure that recordings are not accidentally erased.

- To prevent recording, break off the tab with a screwdriver.
- To allow recording, cover the hole with clear tape.



- 1** Turn on the TV.
- 2** Insert a tape in the DVD/VCR.

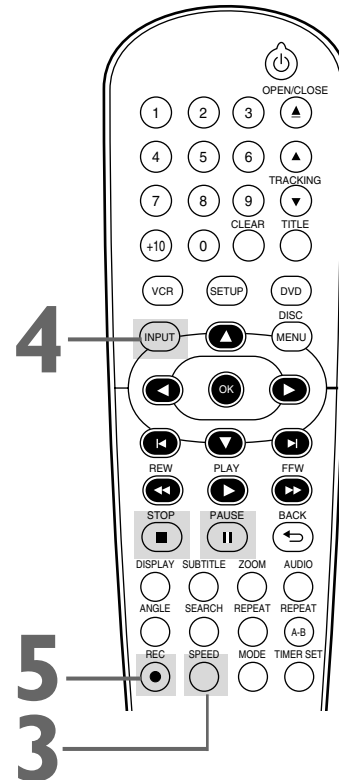

### Helpful Hints

- Other recording options are on pages 22-28.
- The VCR will record in a preset volume.
- Pause will switch to stop after 5 minutes to protect the VCR and the tape from damage. When a recording is paused, review the pause time remaining with the ■ marks on the screen. Each ■ mark equals 1 minute remaining. During the last minute of paused recording, the ■ mark will flash.
- If any menu is on the TV screen, REC ● on the remote does not function. Press CLEAR to remove the menu. Then, press REC ●. Or, use REC ● on the front of the DVD/VCR.

## 22 One-Touch Recording

One-Touch Recording (OTR) lets you set a timed recording 30 minutes to 8 hours long.

Before you begin:

- **This DVD/VCR does not have a tuner input jack. To record TV programs on your DVD/VCR, you need to connect this DVD/VCR to an external tuner device (e.g., set top box, cable box or satellite receiver) that has audio/video output jacks.** See page 9 on how to connect the DVD/VCR to the external tuner.
- Place the DVD/VCR in VCR mode. Press VCR so VCR light appears on the front of the DVD/VCR.
- Select a recording speed (SP, SLP) by pressing SPEED.
- Put a videotape in the cassette compartment. Make sure the tape's record tab is intact and the tape is long enough to record the program(s).

- 1 Press INPUT to select the appropriate external input channel (L1/L2) to which your external tuner is connected. Then select the desired channel to record on the external tuner.**
- 2 Press REC ● repeatedly until the desired recording length (30 minutes to 8 hours) appears on the TV screen.** Recording will begin. "REC" and "☐" will appear on the DVD/VCR's display panel.

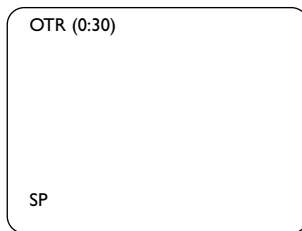

### When an OTR ends

The DVD/VCR will turn off and "☐" on the DVD/VCR's display panel will flash indicating that the recording is complete, then goes into the timer standby mode again. (It may switch to DVD mode automatically.) At this point, you cannot use the VCR unless you release the DVD/VCR from the timer standby mode.

### To release the DVD/VCR from timer standby mode

- If the DVD component is active and no more Timer Recordings are on standby, you can cancel the timer standby mode by pressing TIMER SET or VCR on the remote control or by pressing SOURCE or STOP/EJECT ■▲ on the front panel.
- If the DVD component is not active, or the "☐" is not flashing but lit indicating there are more Timer Recordings on standby, you can cancel the timer standby mode only by pressing TIMER SET on the remote control or by pressing STOP/EJECT ■▲ on the front panel.
- After releasing the DVD/VCR from timer standby mode, you can use it as usual.

### Stopping an OTR

- To stop an OTR before recording is finished, press STOP ■ on the remote control or STOP/EJECT ■▲ on the front of the DVD/VCR.
- To cancel the OTR but continue recording, press REC ● repeatedly until REC appears in the upper left corner of the TV screen, and "☐" disappears.

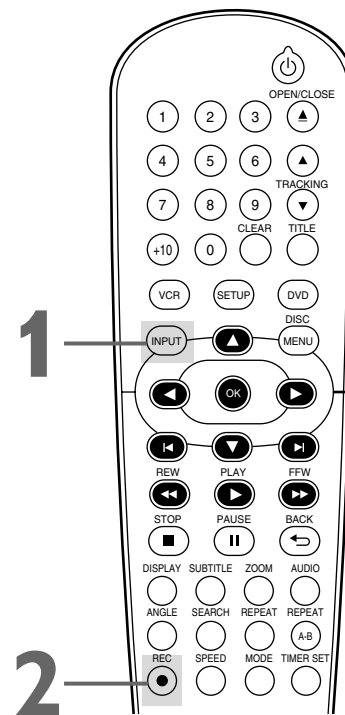

### Helpful Hints

- The remaining recording time will appear on the display panel during an OTR. Press DISPLAY to see it on the TV screen.
- To change the recording length while an OTR is in progress, press REC ● repeatedly.
- You cannot pause an OTR.
- If the preset time for a Timer Recording comes up during an OTR, the OTR has priority. The Timer Recording will not take place.
- If the end of the tape is reached during an OTR, the VCR will stop recording, eject the tape, and switch to DVD mode or turn off.
- If one or more Timer Recordings are on standby when one OTR ends, the DVD/VCR will turn off automatically and "☐" will appear on the DVD/VCR's display panel indicating that it is now ready for another Timer Recording.

## Rerecording (Tape Duplication) 23

These instructions are made on the premise that the DVD/VCR 1 is already connected to the TV. The instructions show you how to copy videotapes. The illustration uses two DVD/VCRs. Other VCRs or Camcorders may operate differently.

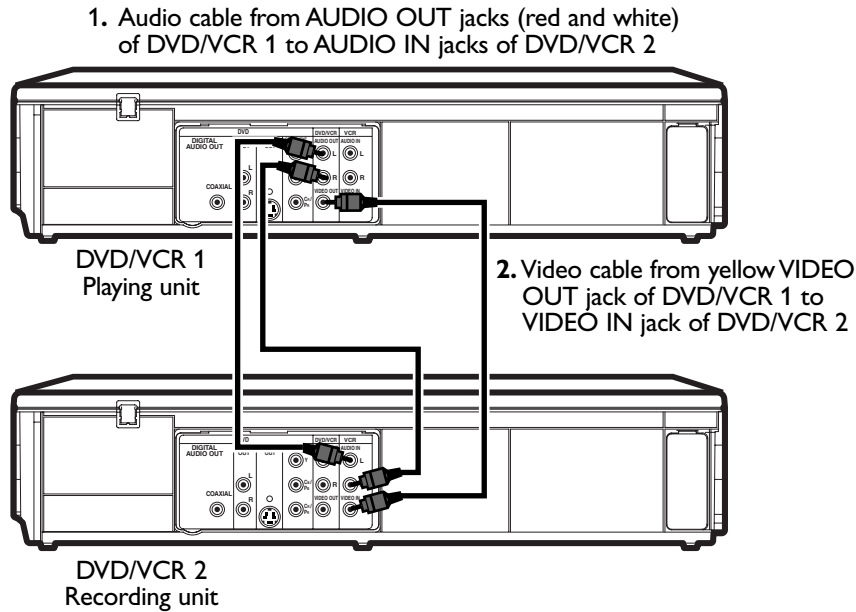

- 1** Make the connections shown above.
- 2** DVD/VCR 1 will play your tape. **Put a prerecorded tape into the cassette compartment of DVD/VCR 1.** Press VCR to put the unit in VCR mode if necessary.
- 3** DVD/VCR 2 will record your tape. **Insert a blank tape in the cassette compartment of DVD/VCR 2.** Press VCR to put the unit in VCR mode if necessary.
- 4** Turn on the TV and set it to the correct Video In channel. (Check your TV owner's manual for details.)
- 5** Point the remote control at DVD/VCR 2. Press **INPUT** to select the appropriate external input channel. (See *Helpful Hints* to the right.)
- 6** Press **SPEED** to select **SP** or **SLP** at DVD/VCR 2. Details about tape speed are on page 57.
- 7** Press **PLAY ► (VCR)** on the front of DVD/VCR 1 and **REC ●** on the front of DVD/VCR 2 at the same time.
  - To stop recording, press **STOP/EJECT ■▲** on DVD/VCR 2, then press **STOP/EJECT ■▲** on DVD/VCR 1.

### Helpful Hints

- If you use the AUDIO and VIDEO IN jacks on the back of DVD/VCR 2, select L1 at step 5.
- If you use the AUDIO and VIDEO IN jacks on the front of DVD/VCR 2, select L2 at step 5.
- Unauthorized recording of copyrighted television programs, video tapes or other materials may infringe on the rights of copyright owners and violate copyright laws.
- If a program has copyright protection, it may not be recorded clearly.

## 24 Timer Recording

Follow the steps below to program the VCR of the DVD/VCR to record TV programs while you're away from home. Before you begin:

- **This DVD/VCR does not have a tuner input jack. To record TV programs on your DVD/VCR, you need to connect this DVD/VCR to an external tuner device (e.g., set top box, cable box or satellite receiver) that has audio/video output jacks.** See page 9 on how to connect the DVD/VCR to the external tuner.
- Set the clock. *Details are on page 19.*
- Put a tape in the cassette compartment of the DVD/VCR. Make sure the tape's record tab is intact and the tape is long enough to record the program(s).
- Press VCR so VCR light appears on the front of the DVD/VCR.
- Turn on your external tuner.

**1** Press **SETUP** so **MENU** appears.

**2** Press **▲** or **▼** to select **TIMER PROGRAMMING**. Then, press **▶**. Program numbers that do not have a Timer Recording stored will flash.

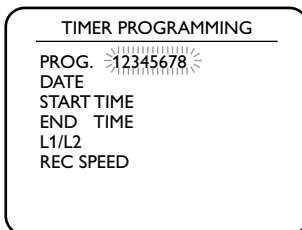

**3** Press **▲** or **▼** to select an empty program. Then, press **▶**.

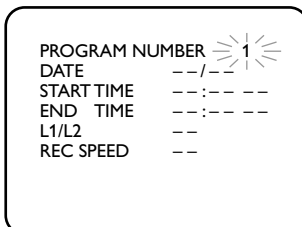

**4** Press **▲** or **▼** to select **ONCE**, **DAILY** or **WEEKLY**. Then, press **▶**.

- **ONCE** - The VCR will record a TV program on any day you choose, up to 12 months away.
- **DAILY** - The VCR will record a TV program at the same time on the same channel every day, Monday through Friday.
- **WEEKLY** - The VCR will record a TV program at the same time on the same channel every week, for example, every Monday.

**5** To set the recording date and time, press **▲** or **▼** until the desired setting appears, then press **▶**.

**6** Press **▲** or **▼** to select the appropriate external input channel (**L1/L2**) to which your external tuner is connected. Then select the desired channel to record on the external tuner.

- Leave the external tuner on for the Timer Recording. *Details are on page 9.*

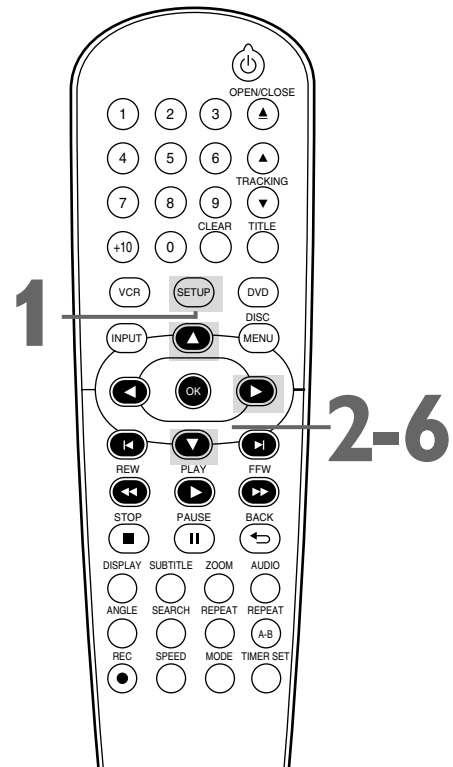

### Helpful Hints

- You cannot access the **TIMER PROGRAMMING** Menu at step 2 if the clock is not set. The **CLOCK SET** Menu will appear. Follow the steps on page 19 to set the clock.
- Only programs that will air Monday-Friday can be recorded on a **DAILY** basis. If you select **DAILY** at step 4, then enter a Saturday or Sunday **DATE** at step 5, the correct program will not be recorded. The VCR will alter the recording date and record a different program than the one you intended.
- If you connected the external tuner to the **AUDIO** and **VIDEO** IN jacks on the front of the DVD/VCR, choose **L2**. If you connected the external tuner to the **AUDIO IN** and **VIDEO IN** jacks on the back of the DVD/VCR, choose **L1**.
- Enter the information while the space is flashing.
- You cannot program more than one year in advance.

## Timer Recording (cont'd) 25

- 7** Press **▲** or **▼** to select a recording tape speed. The arrow will appear beside your choice. The selected speed will flash beside REC SPEED. *Details about tape speed are on page 57.* You must select the recording speed to complete the timer programming.

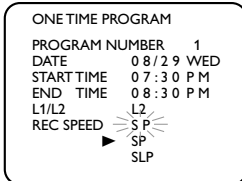

- 8** Press **CLEAR** to remove the menu.

**9** Press **TIMER SET**.

- In some cases, the DVD/VCR will switch to DVD mode instead.
- You may use the DVD player during a Timer Recording.
- If you want to use the VCR until time for the recording, don't press **TIMER SET** until a few minutes before the recording should start. Or, press **TIMER SET** only when you know you won't be using the VCR anymore (until after the recording).
- When "☐" is lit (not flashing), you cannot put the DVD/VCR in VCR mode by pressing **VCR** or **SOURCE**. You must first press **TIMER SET** on the remote control or **STOP/EJECT** **■▲** on the front panel to cancel the Timer Recording temporarily. Then, you can use the VCR features again.

### When a Timer Recording ends

The DVD/VCR will turn off and "☐" on the DVD/VCR's display panel will flash indicating that the recording is complete, then goes into the timer standby mode again. (It may switch to DVD mode automatically.) At this point, you cannot use the VCR unless you release the DVD/VCR from the timer standby mode.

### To release the DVD/VCR from timer standby mode

- If the DVD component is active and no more Timer Recordings are on standby, you can cancel the timer standby mode by pressing **TIMER SET** or **VCR** on the remote control or by pressing **SOURCE** or **STOP/EJECT** **■▲** on the front panel.
- If the DVD component is not active, or the "☐" is not flashing but lit indicating there are more Timer Recordings on standby, you can cancel the timer standby mode only by pressing **TIMER SET** on the remote control or by pressing **STOP/EJECT** **■▲** on the front panel.
- After releasing the DVD/VCR from timer standby mode, you can use it as usual.

### Canceling a Timer Recording Before the Recording Starts

- 1** Press **VCR**, then press **SETUP** so **MENU** appears.
- 2** Press **▲** or **▼** to select **TIMER PROGRAMMING**, then press **▶**.
- 3** Press **▲** or **▼** to find the program you want to cancel.
- 4** While the program number is flashing, press **◀** to clear all the information for that program.
- 5** Press **CLEAR** to remove the menu.

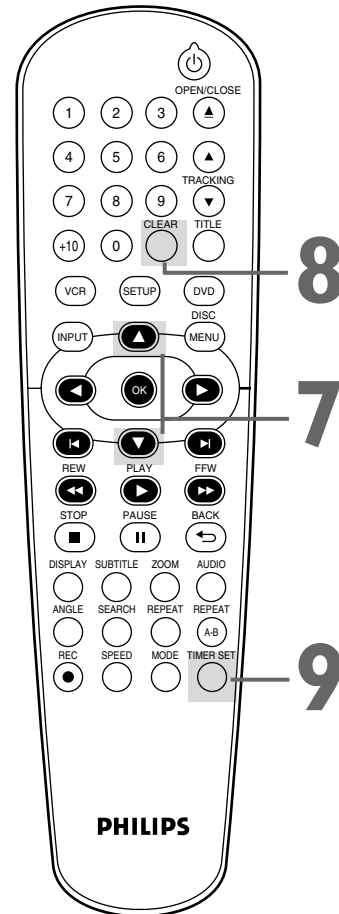

### Helpful Hints

- To stop a started Timer Recording, press **STOP/EJECT** **■▲** on the front of the DVD/VCR. (You cannot stop a started Timer Recording with **STOP** **■** on the remote.)
- To change incorrect information, press **◀** or **▶** to choose the item you want to change. Press **▲** or **▼** to adjust the information.
- If there is no tape in the VCR when you press **TIMER SET**, "☐" will flash. Insert a tape.
- If one or more Timer Recordings are on standby when one Timer Recording ends, the DVD/VCR will turn off automatically and "☐" will appear on the DVD/VCR's display panel indicating that it is now ready for another Timer Recording.

## 26 Satellite Link

You can set the DVD/VCR to start recording whenever it detects a video signal from the external tuner.

Before you begin:

- Set the clock. Details are on page 19.
- Put a tape in the cassette compartment of the DVD/VCR. Make sure the tape's record tab is intact and the tape is long enough to record the program(s).
- Press VCR so VCR light appears on the front of the DVD/VCR.
- Turn on the external tuner.
- Use the VCR AUDIO and VIDEO IN jacks on the rear (L1) to connect the DVD/VCR to the external tuner. VCR AUDIO and VIDEO jacks on the front (L2) cannot read any signal from the external tuner.
- If the external tuner is equipped with some kind of timer function, set it to output audio/video signals when it comes to the time you want to start recording and stop when it comes to the time you want to stop recording. Refer to the tuner's manual on how to set the timer.
- If the external tuner is not equipped with timer function, leave it on for Satellite Link Recording.

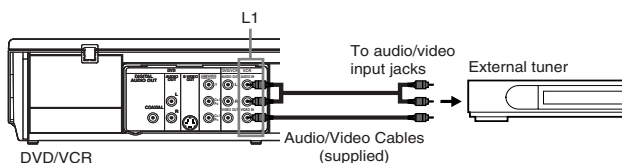

- 1 Press SPEED repeatedly until the desired tape speed (SP or SLP) appears briefly on the screen.**  
*Details about tape speed are on page 57.*
- 2 In stop mode, press SETUP.**
- 3 Press ▲ or ▼ to select SATELLITE LINK, then press ►.**

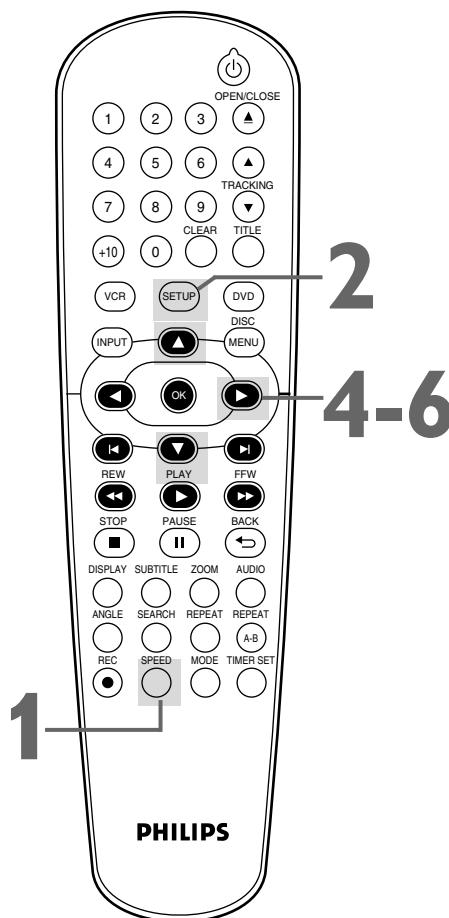
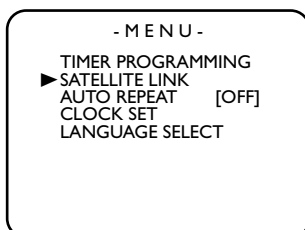



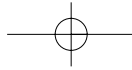

## Satellite Link (cont'd) 27

### 4 Press ▲ or ▼ to set the desired start hour, then press ►.

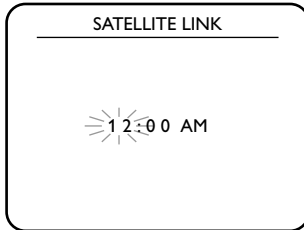

- The hour can be selected from 1-12 with AM or PM.
- When the external tuner signal is stopped, recording will be stopped also.

### 5 Press ▲ or ▼ to set the desired start minutes. If you wish to go back to the left, press ◀.

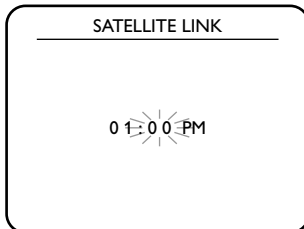

### 6 Press ► to set Satellite Link standby mode.

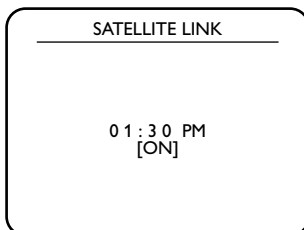

- “” on the DVD/VCR’s display panel lights up and the DVD/VCR goes to the DVD mode. If you do not use DVD function, turn off the DVD/VCR.
- If the external tuner is not equipped with timer function, leave it on for Satellite Link Recording.
- To cancel the Satellite Link function in standby mode: Press TIMER SET on the remote control or STOP/EJECT on this DVD/VCR.
- To cancel the Satellite Link function while the Satellite Link Recording is in progress: Press STOP/EJECT on the DVD/VCR.

### Helpful Hints

- If you have not set the clock, CLOCK SET menu will appear at step 3. Refer to “Clock (VCR)” on page 19.
- You cannot set the ending time for the Satellite Link Timer Recording on this DVD/VCR.
- Recording picture will be distorted if the copy protection signal is being detected during Satellite Link Timer Recording.
- When a regular Timer Recording and the Satellite Link Timer Recording are overlapped, those recordings are recorded as illustrated below.

e.g.) In case of the Satellite Link Timer Recording is overlapped on the existing Timer Recording.

Timer Recording	
Satellite Link	
recording result	

e.g.) In case of the Timer Recording is programmed in the middle of the Satellite Link Timer Recording.

Timer Recording	
Satellite Link	
recording result	

e.g.) In case of the Timer Recording is overlapped on the existing Satellite Link Timer Recording.

Timer Recording	
Satellite Link	
recording result	

## 28 DVD to Videotape Duplication

Follow the steps below to copy a DVD to a videotape. **This will be possible only if the DVD is not copy protected.**

Before you begin:

- Put a videotape in the cassette compartment. Make sure the tape's record tab is intact and the tape is long enough to record the DVD.
- Put the DVD you want to copy in the disc tray.
- Press VCR so VCR light appears on the front of the DVD/VCR.
- Turn on the TV and set it to the correct Video In channel. (Check your TV owner's manual for details.)

- 1 Press INPUT repeatedly until "DISC" appears on the TV screen.**

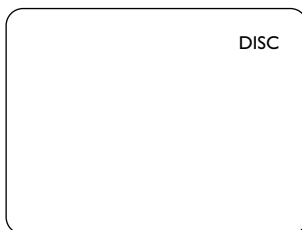

- 2 Press SPEED repeatedly until the desired tape speed (SP or SLP) appears briefly on the screen.**  
*Details about tape speed are on page 57.*

- 3 Press REC ● to start recording.** "REC" will appear on the display panel.

- 4 Press DVD. Press PLAY ► to play the disc.**
  - To pause the recording, press VCR, then press PAUSE ■■ once. "REC" will flash.
  - To resume recording, press REC ● or press PAUSE ■■ again. "REC" will reappear.
  - To stop recording, press VCR, then press STOP ■.

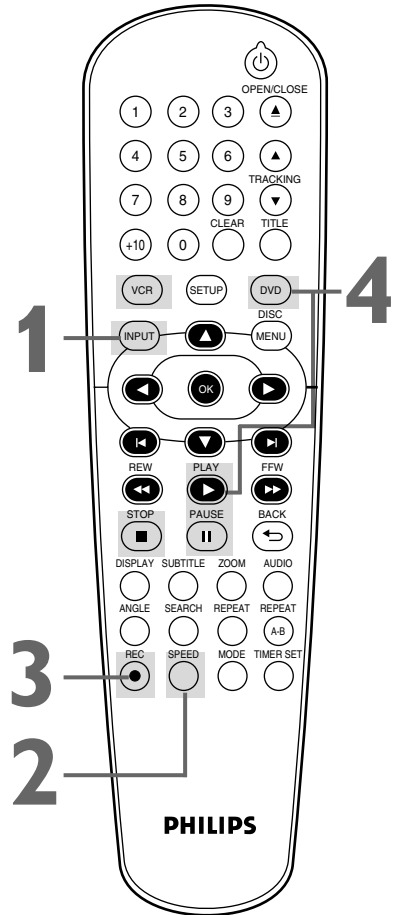

### Helpful Hints

- A Timer Recording or Satellite Link is not available during DVD to videotape duplication.
- You cannot copy a DVD to a videotape if you are using Progressive Scan.

## Repeat Playback 29

Follow the steps below to play a videotape repeatedly.

- 1** Press **VCR**, then press **SETUP** so MENU appears.
- 2** Press **▲** or **▼** to select **AUTO REPEAT**.
- 3** Press **▶** so **ON** appears next to **AUTO REPEAT**.  
Tape playback will begin immediately. **AUTO REPEAT** will appear on the TV screen briefly. (If you are fast forwarding or rewinding the tape, press **CLEAR** to remove the menu, then press **PLAY ▶** to begin tape playback.) The tape will play to the end, rewind, then play again.

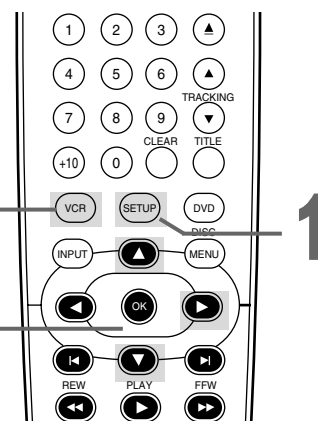
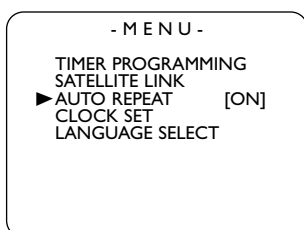

### Helpful Hint

- To cancel Auto Repeat, follow steps 1-2. At step 3, press **▶** so **OFF** appears beside **AUTO REPEAT**. Press **CLEAR**.

## Tape Counter

Follow the steps below to reset the VCR's real-time tape counter to 0 at a tape location you want to refer to later.

- 1** Press **VCR**, then play, fast forward or rewind a tape to the location that you would like to refer to later. Press **STOP ■** to stop the tape.
- 2** Press **DISPLAY** to see the Status Display.
- 3** While the counter is on the screen, press **CLEAR** to reset the counter to 0.

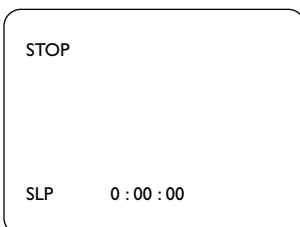
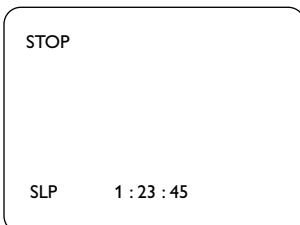

- 4** When you later want to return to this point on the tape, press **DISPLAY** so you can see the counter (while tape playback is stopped). Press **REW ◀◀** or **FFW ▶▶**.  
As the tape rewinds or forwards, watch the counter. When it reaches 0, press **PLAY ▶** to play the tape.

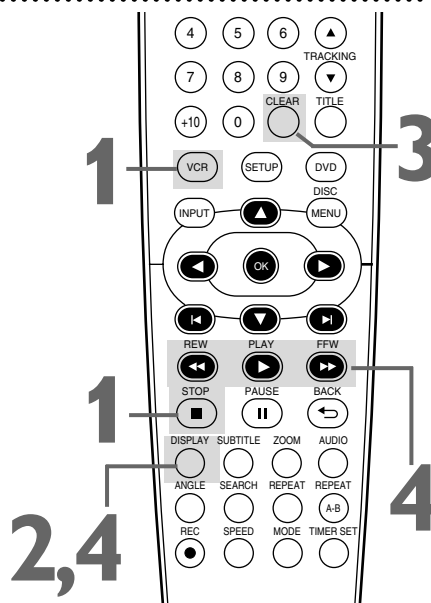

### Helpful Hints

- You may only set the counter to 0 at one location at a time. Setting the counter to zero at a second location will erase the previous 0 setting.
- If you remove the tape, the counter will reset to 0 at the point at which you last stopped playback whenever you reinsert the tape.

## 30 Time Search, Index Search

### Time Search

Follow the steps below to search forward or backward on a tape a specific length of time. There must be a tape in the cassette compartment.

- 1 Press **VCR**, then press **SEARCH** repeatedly until the **TIME SEARCH** Screen appears.

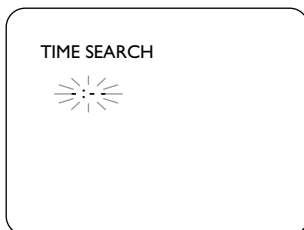

- 2 Within 30 seconds, press **▲** or **▼** until your desired length of time appears. Or, press and hold **▲** or **▼** until you reach the desired length of time. You can set a Time Search for up to 9 hours and 59 minutes (9:59).

- 3 Within 30 seconds, press **◀** (for a reverse search) or **▶** (for a forward search). The VCR begins rewinding or fast forwarding the tape. When the tape finishes rewinding or fast forwarding the time you specified, playback will begin. The time will count down beneath TIME SEARCH during the search. If the end of the tape is reached during the search, the search will stop and the tape may rewind. *Details are on page 31.*

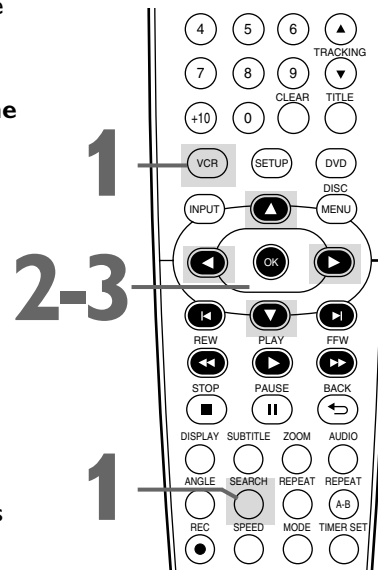

### Index Search

An Index Mark is made automatically at the beginning of each recording. Essentially, an Index Mark is a "bookmark." Find the start of a recording by following these steps.

- 1 Press **VCR**, then press **SEARCH** repeatedly until the **INDEX SEARCH** Screen appears.

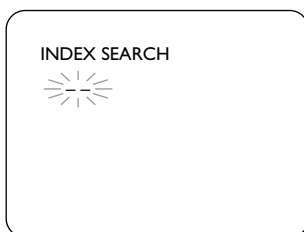

- 2 Within 30 seconds, press **▲** or **▼** until the number of programs you want to skip appears beneath INDEX SEARCH. Include the current program in your number.
- 3 Within 30 seconds, press **◀** (for a reverse search) or **▶** (for a forward search). When the tape finishes rewinding or forwarding, playback will start. The program numbers will count down beneath INDEX SEARCH during the search. If the end of the tape is reached during the search, the search will stop and the tape may rewind. *Details are on page 31.* Recordings should be at least 1 minute long in SP speed and 3 minutes in SLP. Otherwise, the Index Mark will not be available. *Details on tape recording speeds are on page 57.*

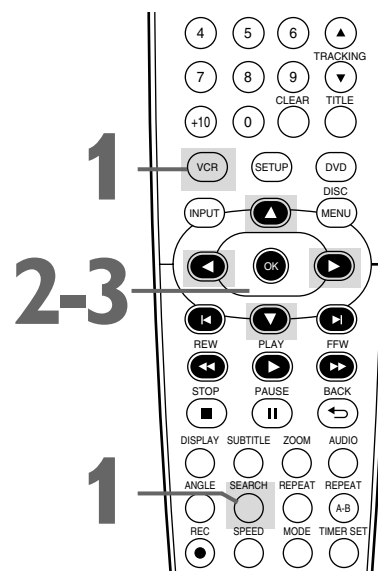

#### Helpful Hints

- Time Search and Index Search are not available during recording.
- To remove a Search Display, press CLEAR.
- To cancel a search, press STOP ■.

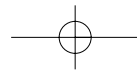

## Special Effects Playback 31

- Before you begin, press VCR so VCR light appears on the front of the DVD/VCR.

### Forward and Reverse Searching (SP/LP/SLP) / Super High Speed Searching (LP/SLP)

**1** During tape playback, press and release **FFW** ►► or **REW** ◄◄. A fast forward or reverse picture search will begin. Press **FFW** ►► or **REW** ◄◄, then press again. The search speed will increase. Repeatedly pressing **FFW** ►► or **REW** ◄◄ will switch between Regular and High Speed Searching.

**2** To return to normal playback, press **PLAY** ►.

### Viewing a Still Picture

**1** During tape playback, press **PAUSE** ■■. A still picture will appear on the screen.

- To advance the still picture one frame at a time, press **PAUSE** ■■ repeatedly.
- To release the still picture and return to playback, press **PLAY** ►.

### Viewing a Slow Motion Picture

**1** During tape playback, press **PAUSE** ■■, then press **FFW** ►►. The tape will play in slow motion.

- To change the playback speed, press **FFW** ►► or **REW** ◄◄.
- To return to normal playback, press **PLAY** ►.

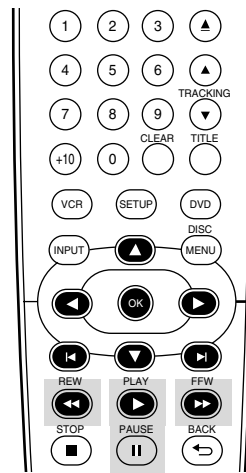

#### Helpful Hints

- Slow and still modes will switch to stop mode after 5 minutes to protect the DVD/VCR and the tape from damage.
- SP/LP/SLP means this feature will work with tapes recorded in Standard Playback, Long Playback or Super Long Playback. LP/SLP means this feature will work with tapes recorded in Long Playback or Super Long Playback. Tape speed details are on page 57.

## Automatic Operation Features

The following tape features are available in VCR mode. Press VCR so VCR light appears on the front of the DVD/VCR, if necessary.

### Automatic Playback

When you put a tape in the DVD/VCR, the power will come on. If the tape's record tab is missing, playback will begin. If a Timer Recording is set and "⏸" is flashing in the display panel, the power will not come on automatically when you insert a tape with the record tab intact.

If a Timer Recording is set and "⏸" is flashing in the display panel, the DVD/VCR will eject the tape if the record tab is missing.

### Automatic Rewind, Eject

When a tape is played, fast forwarded or recorded to its end, the tape will rewind to the beginning, stop and eject itself. This feature does not operate if AUTO REPEAT is ON. *Details are on page 29.*

### Tape Eject

A tape can be ejected with the DVD/VCR power on or off (but the DVD/VCR must be plugged in).

If a Timer Recording is set and "⏸" is shown on the display panel, press **TIMER SET** on the remote control or **STOP/EJECT** ■▲ on the front panel to cancel the timer standby mode, and then press **STOP/EJECT** ■▲ to remove the tape. Remember to insert a tape and press **TIMER SET** to reset the Timer Recording.

### Automatic Tracking Adjustment

The VCR adjusts tracking automatically to give you the best possible picture quality. With some recordings, however, you may get a better picture using manual tracking.

### Manual Tracking

To manually adjust the tracking during normal playback and Slow Motion Playback of a videotape, press **TRACKING** ▲/▼. Tracking will return to Automatic Tracking when you press **STOP** ■ or insert a tape. You can also press **TRACKING** ▲/▼ to remove vertical jitter in a Still picture.

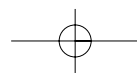

## 32 Hi-Fi Stereo

### Hi-Fi Stereo

To play in Hi-Fi stereo the tapes recorded in Hi-Fi stereo, press AUDIO to switch Hi-Fi or MONO.

#### Helpful Hint

- The audio level of a tape recorded in Hi-Fi stereo will differ from the audio level of a tape not recorded in Hi-Fi stereo.

## Menus, Playback Control (PBC) Function

### DVD Disc Menus

Some DVDs contain menus that describe the contents of the disc or allow you to customize disc playback. For example, the menu may offer choices for subtitle languages, director's commentary or Sound Track Playback. To use the DVD Menu and select playback features, follow these steps.

- Press **DVD** to put the DVD/VCR in DVD mode. DVD light will appear on the front of the DVD/VCR.
- Press **DISC MENU**. The DVD's main Disc Menu will appear.
- Press **▲, ▼, ◀ or ▶** to select an item, then press **OK**. Continue this process to set up all the features you want.

### Using the Title Menu

Some DVDs have a Title Menu, which lists the titles available on the DVD. Use the Title Menu to play a specific title.

- Press **DVD** to put the DVD/VCR in DVD mode. DVD light will appear on the front of the DVD/VCR.
- Press **TITLE**. The Title Menu will appear. If a Title Menu is not available, the "X" may appear on the TV screen. Or, if the DVD only has a main Disc Menu as described above, it may appear when you press TITLE.
- Press **▲, ▼, ◀ or ▶** to select a title, then press **OK**. Playback will begin at the title you selected.

### Playback Control (PBC) Function

When playing a Video CD with PBC (Playback Control), you can use interactive menu (e.g., playlists) on the TV screen. Refer to instructions accompanying your Video CD for more details on PBC.

Some operations cannot be performed unless the PBC function is cancelled temporarily.

#### Canceling and calling back the PBC function

- While playback is stopped, press the **Number Buttons** to enter a track number. PBC function is now cancelled and the playback of the Video CD will start.
- To call back the **PBC** function, press **STOP** ■ twice, then press **PLAY** ▶. The Title Menu will appear on the TV screen.

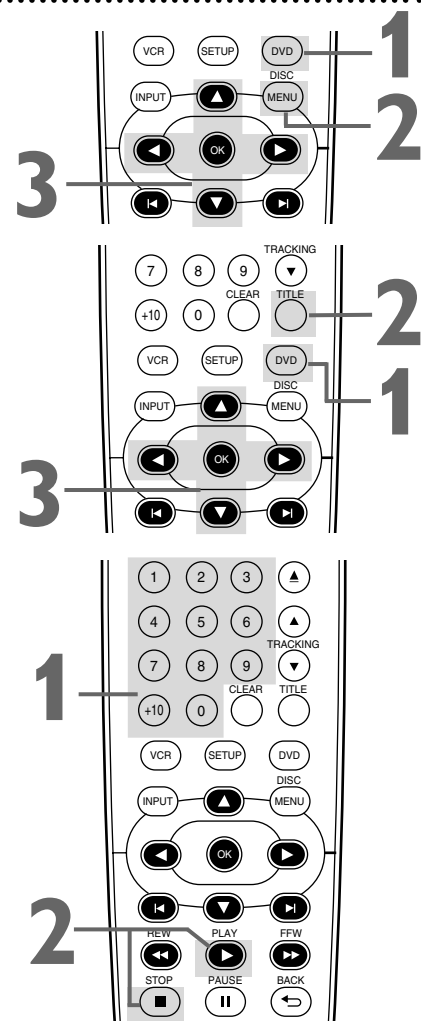

#### Helpful Hints

- Menus vary among discs. Follow the literature accompanying the disc for details.
- Not all DVDs have Disc or Title Menus.
- Some DVDs may refer to chapters as "scenes." Some DVDs may refer to the Title Menu as the "scene index."
- TITLE will not be active with all DVDs.

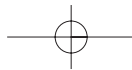

## Fast Forward/Fast Reverse 33

- 1** Press **DVD** to put the DVD/VCR in DVD mode. DVD light will appear on the front of the DVD/VCR.
- 2** During playback, press **FFW** or **REW** on the remote control.
  - During DVD playback, pressing **FFW** or **REW** will forward or reverse the picture at approximately 2, 8, 20, 50 or 100 times the normal speed. The speed may vary depending on the disc. 1, 2, 3, 4 or 5 will appear briefly on the TV screen to indicate Forward Searching. Or, 1, 2, 3, 4 or 5 will indicate fast reverse. For DVD playback, the sound will be mute during the search.
  - For Video CDs, Audio CDs, MP3 or Windows Media™ Audio playback, pressing **FFW** or **REW** will forward or reverse the picture or sound at approximately 2, 8 or 30 times the normal speed. The speed may vary depending on the disc. 1, 2 or 3 will appear briefly on the TV screen to indicate Forward Searching. Or, 1, 2 or 3 will indicate fast reverse. For Audio CD, MP3 or Windows Media™ Audio playback, the sound will be intermittent during the search.



Example: Playing a DVD in reverse at twice the normal playing speed.

- 3** Press **PLAY** to return to normal playback.

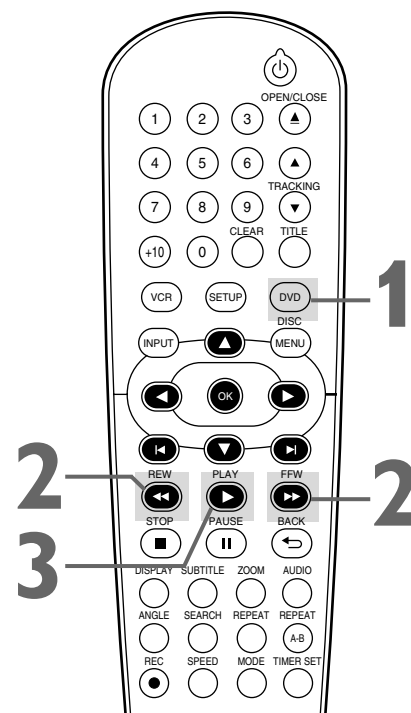

### Helpful Hint

- If you use **FFW** or **REW** during Dual Playback, JPEG playback will be paused.

## x1.3 and x0.8 Rapid Play with Voice

Rapid Play with Voice is available only during playback on the discs recorded in the Dolby Digital format. Rapid Play with Voice plays back in slightly faster/slower speed while keeping the sound quality as in the normal playback.

- 1** During playback, press **MODE**. The current setting appears.
- 2** Press **OK** to switch among (x1.3), (x0.8) and **OFF**.
  - : Plays back approximately at 1.3 times of normal playback.
  - : Plays back approximately at 0.8 times of normal playback.
  - OFF : No effects.
  - To resume normal playback, press **PLAY** .

### Helpful Hint

- During Rapid Play with Voice;
  - Audio Language Setting, Black Level Setting and Virtual Surround Setting cannot be changed.
  - Virtual Surround does not function.
  - the PCM sound will be output if using the digital audio connection (COAXIAL).
  - depending on the scenes you are playing, Rapid Play with Voice may be unavailable.





## 34 Title/Chapter/Time Search

### Title/Chapter Search

- 1** Press **DVD** to put the DVD/VCR in DVD mode. DVD light will appear on the front of the DVD/VCR.
- 2** During DVD playback, press **SEARCH** repeatedly until CH (for chapter) or TT (for title) appears on the TV screen. The number of available titles or chapters will appear at the right ( /4, for example).
- 3** Enter the title or chapter number using the **Number buttons**. The title or chapter will play.
  - To select a single-digit track number when there are more than 10 tracks, press **OK** to play the track.
  - If you enter a track number that is not available on the Disc, playback will not begin (or the current track will continue to play).

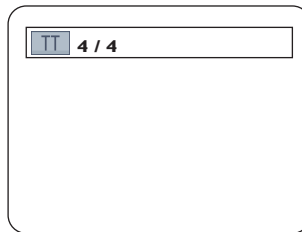
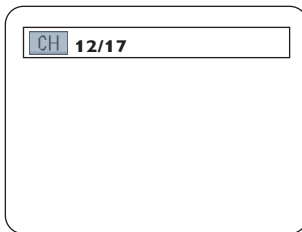

### Time Search

- 1** Press **DVD** to put the DVD/VCR in DVD mode. DVD light will appear on the front of the DVD/VCR.
- 2** During DVD, Video CD (without PBC) or Audio CD playback, press **SEARCH** repeatedly until the Time Search Display appears.

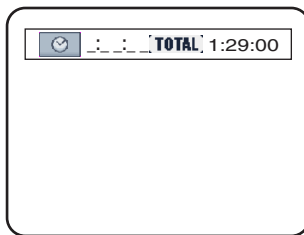

- 3** Within 30 seconds, use the **Number buttons** to enter the elapsed playing time (of the track or title) at which you want playback to begin. Enter the time in hours, minutes and seconds. Within a few seconds, playback will start at the specified time.
  - Example: 1 hour, 23 minutes and 30 seconds  
1 → 2 → 3 → 3 → 0
  - Make sure the time you enter is within the total time of the current title or track. If it is not, the time space will clear and playback will continue at its current point. The total time available in the current track or title will appear in the Time Search Display.
  - If you make a mistake entering the time, press **CLEAR** to clear the time area. Enter the correct information.

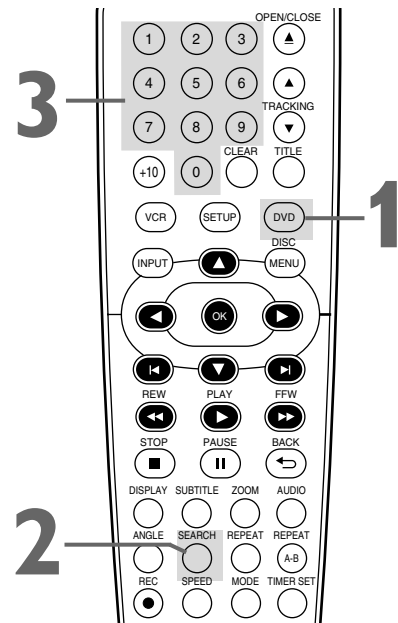
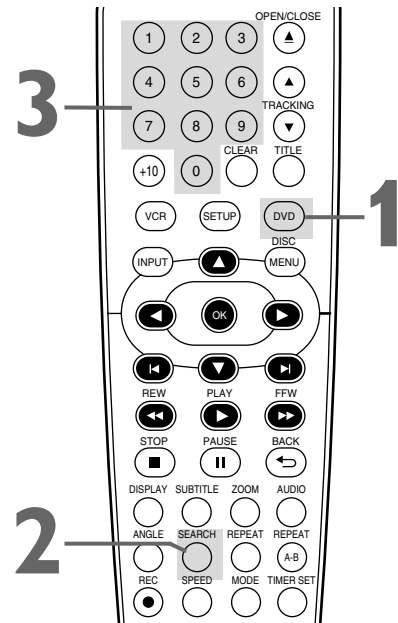

### Helpful Hints

- When playback is stopped, use the **Number buttons** to select a title for immediate playback. During playback, use the **Number buttons** to choose a chapter for immediate playback.
- Title/Chapter Search is not available with some DVDs.
- Time Search is not available for MP3, Windows Media™ Audio and JPEG files.

## Track Search 35

There are three ways to play a specific Video CD (without PBC), Audio CD, MP3, Windows Media™ Audio or JPEG track: Use the Number buttons, the SEARCH button or ► and ◀.

- Before you begin, press DVD so DVD light appears on the front of the DVD/VCR.

### A

#### Using the Number Buttons

**Press the Number buttons to enter a track number.**

Playback will start at the selected track.

For tracks 10 and above, press the +10 button so the Search Display (TR \_\_ /12 - an example of total tracks) appears on the TV screen. Press the Number button of the first digit, then press the Number button of the second digit. For example, to play track 26, press +10, then Number 2, then Number 6 (Each number must be pressed within 30 seconds of the previous number).

For single-digit tracks (1-9), press a single Number button.

If you enter a track number that is not available on the disc, play will not begin (or the current track will continue to play).

### B

#### Using SEARCH

**Press SEARCH so the Track Search Display (TR) appears.**

**Within 30 seconds, press the Number buttons to select the track number.** Playback will begin at the selected track. For a single-digit track (1-9), enter 0 first. For example, to play track 5, press 0, 5. You do not have to use the +10 button in search mode.

### C

#### Using ► or ◀

**During playback, press ► to skip the current track and move to the next track.** The track number will appear briefly on the DVD/VCR display panel.

**Or, during playback, press ◀ to return to the beginning of the current track. Press ◀ repeatedly to go to previous tracks.** The track number will appear briefly on the DVD/VCR display panel.

A, B

C

B

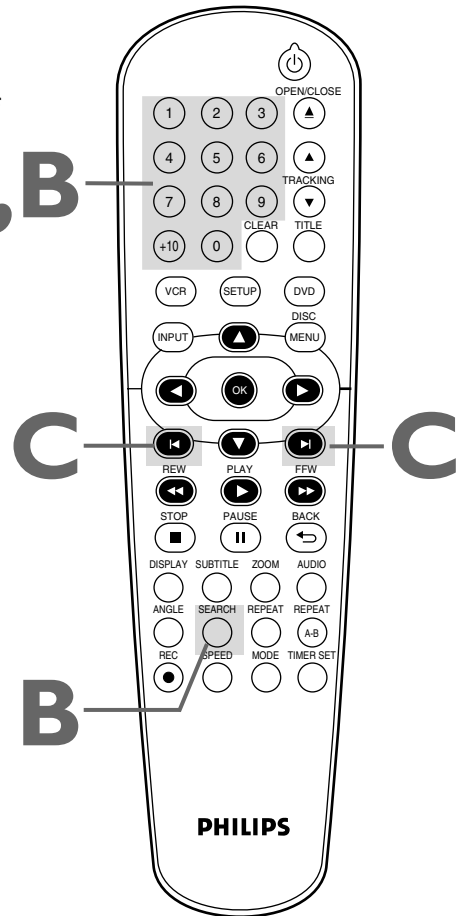

#### Helpful Hints

- ► and ◀ does not function when playback is stopped.
- You cannot use ► to go from the last track on the disc to the first track.
- Using ► or ◀ during Dual Playback will only affect MP3 files. If you want to skip JPEG files during Dual Playback, press ◀ or ►. Please note that pressing ► or ◀ will affect both MP3 and JPEG files if SLIDE SHOW is set to MUSIC.

## 36 Paused and Step-by-Step Playback, Resume On

### Paused and Step-by-Step Playback

- 1** Press **DVD** to put the DVD/VCR in DVD mode. DVD light will appear on the front of the DVD/VCR.
- 2** During disc playback, press **PAUSE** **||**. Playback will pause and the sound will be mute.
  - Pressing **PAUSE** **||** once during Dual Playback will pause a JPEG file only. Pressing **PAUSE** **||** one more time will pause an MP3 playback.
- 3** When playing a DVD or Video CD, press **PAUSE** **||** repeatedly to see the picture advance one frame (or step) at a time. The sound will remain mute. Pressing **PAUSE** **||** repeatedly during Audio CD, MP3, Windows Media™ Audio or JPEG playback will have no effect.
- 4** Press **PLAY** **▶** to resume playback.

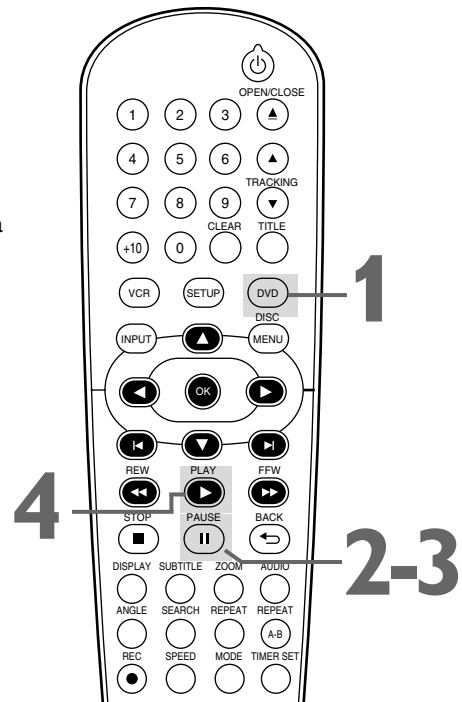

### Resume On

- 1** Press **DVD** to put the DVD/VCR in DVD mode. DVD light will appear on the front of the DVD/VCR.
- 2** Press **STOP** **■** during playback. In a few seconds, the following Resume message will appear on the TV screen.

For DVD, VideoCD or AudioCD:

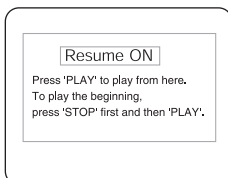

For MP3, Windows Media™ Audio or JPEG:

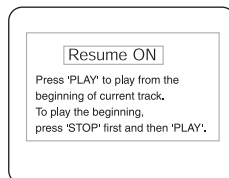

- 3** Press **PLAY** **▶**. In a few seconds, playback will resume from the point at which it stopped last. You can Resume Playing at the same point even if you turn off the DVD/VCR, then turn it on again later. However, opening the disc tray will cancel the Resume feature. Playback will start at the beginning the next time you insert the disc. For MP3, Windows Media™ Audio and JPEG playback will resume from the beginning of the current track. To cancel Resume and start playing the disc from the beginning, press **STOP** **■** again while playback is in the resume stop mode. As for MP3, Windows Media™ Audio and JPEG playback, File List will appear when you cancel Resume. Press **PLAY** **▶** to start playing the disc from the beginning.
  - To resume playback of a Video CD with PBC function, you have to cancel the PBC function first. See page 32 on how to cancel the PBC function.
  - The resume information will be cleared if you change the parental level when the resume information is on.

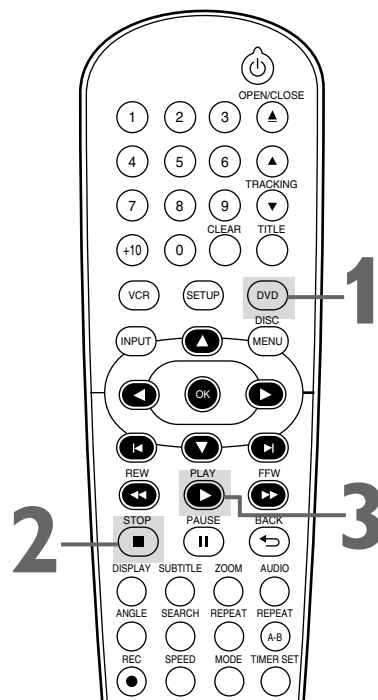

#### Helpful Hint

- Set STILL MODE to FIELD in the DISPLAY Menu if paused images are blurry. Details are on pages 50-51.

## Repeat, A-B Repeat 37

### Repeat

- 1** Press **DVD** to put the DVD/VCR in DVD mode. DVD light will appear on the front of the DVD/VCR.
- 2** During **DVD, Video CD (without PBC), Audio CD, MP3, Windows Media™ Audio or JPEG playback, press REPEAT repeatedly until the repeat mode you want appears on the TV screen.**  
On a DVD, select **CHAPTER, TITLE** or **OFF**. On a Video CD (without PBC) and Audio CD, select **TRACK, ALL** (all tracks on the disc) or **OFF**.  
With MP3, Windows Media™ Audio or JPEG tracks, select **TRACK, GROUP** (all tracks in the current folder), **ALL** or **OFF**.  
Selecting a new track, chapter or title will cancel Repeat Playback.



Example: Repeat a DVD chapter



Example: Repeat a Video CD or Audio CD track

### A-B Repeat

You can play a specified section of a DVD, Video CD or Audio CD repeatedly. Follow these steps to set up the section you want to repeat.

- 1** Press **DVD** to put the DVD/VCR in DVD mode. DVD light will appear on the front of the DVD/VCR.
- 2** Press **PLAY ►** to play the disc to the point at which you want repeated playback to begin.
- 3** Press **A-B REPEAT** to set the starting point (A). If you make a mistake, press **CLEAR**. This will erase point A and let you start over. **OFF** will appear briefly on the TV screen.

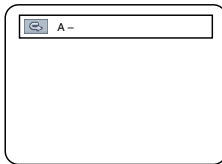

- 4** Play the disc to the point at which you want repeated playback to end, then press **A-B REPEAT** again. Within a few seconds, the A-B section will begin to play repeatedly. The segment will play over and over until you cancel the A-B Repeat feature.

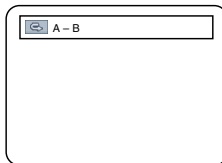

- To cancel A-B Repeat, press **A-B REPEAT**. **OFF** will appear on the TV screen. Regular playback will resume.

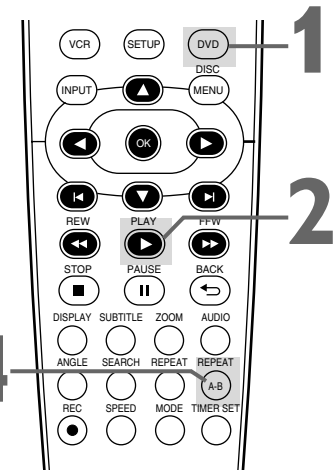
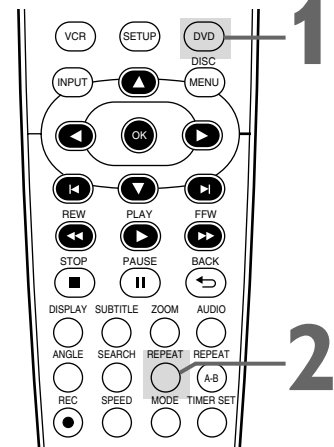

### Helpful Hints

- Repeat Playback and A-B Repeat are not available with some discs.
- The entire A-B Repeat section must be within a single title or track. If you do not enter Point B before the end of the track or title is reached, the end of the track or title will become Point B automatically.
- Point B must be later on the disc than Point A.
- A-B Repeat is not available with MP3, Windows Media™ Audio and JPEG files.
- If you choose **GROUP Repeat** during Dual Playback, all tracks or files in each folder will play repeatedly. For example if you choose **GROUP Repeat** during Dual Playback of MP3 folder A and JPEG folder B, all MP3 files in folder A and all JPEG files in folder B will be repeated.

## 38 Markers

Use Markers to remember your favorite places on a DVD, Video CD (without PBC) or Audio CD.

- Before you begin, place the DVD/VCR in DVD mode. Press DVD so DVD light appears on the front of the DVD/VCR.

- 1 Play the disc to within 30 seconds of the point at which you want to set the Marker. Press SEARCH repeatedly until Marker Display appears.**



Example: DVD

- 2 Within 30 seconds, press ◀ or ▶ to select a Marker (1-10). Make sure \_\_:\_\_:\_\_ appears beneath the number.**

- 3 When the playback reaches the point you want to remember, press OK. The title or track number and its elapsed playing time will appear beneath the Markers. A checkmark will replace the Marker number. The Marker Display will disappear in about 30 seconds, or press BACK ↵ to remove it.**

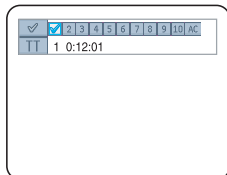

Example: DVD

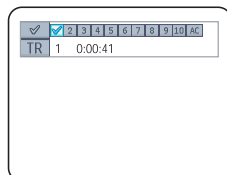

Example: Video CD  
or Audio CD

- 4 To return to a Marker during playback, press SEARCH repeatedly until Marker Display appears. Press ◀ or ▶ to choose the Marker you want, then press OK. Disc playback will continue from the marked point.**

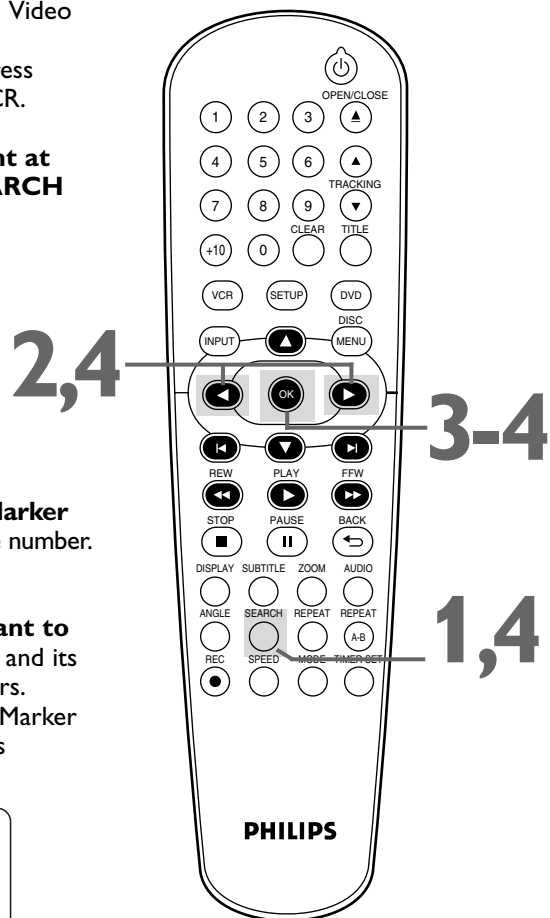

PHILIPS

### Helpful Hints

- Opening the disc tray or turning off the DVD/VCR will erase all the Markers.
- To erase a single Marker, press SEARCH repeatedly until Marker Display appears. Press ◀ or ▶ to select a Marker. Press CLEAR. Press BACK ↵ to remove the display.
- To erase all the Markers, press SEARCH repeatedly until Marker Display appears. Press ▶ to select AC, then press OK. Press BACK ↵ to remove the display.

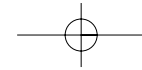

## Subtitles, Camera Angles 39

### Subtitles

The DVD/VCR allows you to select a language for subtitles during playback. You may select only languages that are available on the DVD.

- 1** Press **DVD** to put the DVD/VCR in DVD mode. DVD light will appear on the front of the DVD/VCR.
- 2** During playback, press **SUBTITLE** repeatedly to select a subtitle language. The number of available languages appears at the right of the Subtitle Display. In the example below, six languages are available ( /6). After a few seconds, the subtitles will appear. Or, press **SUBTITLE** repeatedly to turn off subtitles. When no subtitles are available, "NOT AVAILABLE" appears at the right of the Subtitle Display.



Example: English as first of six available subtitles

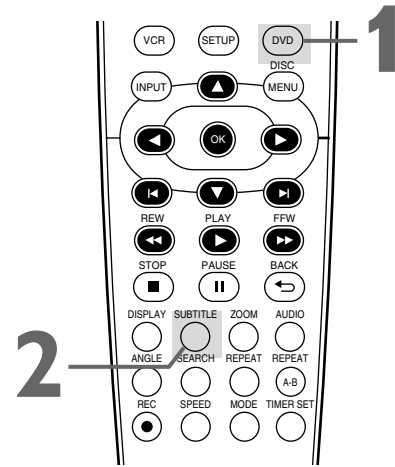

### Camera Angles

Some DVDs contain scenes recorded from different angles or perspectives. The perspective will not change if the DVD does not contain sequences recorded from different camera angles.

- 1** Press **DVD** to put the DVD/VCR in DVD mode. DVD light will appear on the front of the DVD/VCR.
- 2** During playback, press **ANGLE** repeatedly to select a different perspective. The number of available angles appears at the right of the Angle Display. In this example, eight angles are available ( /8).

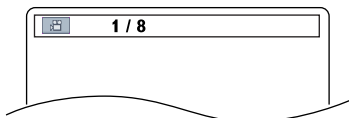

Example: Angle 1 of eight available angles

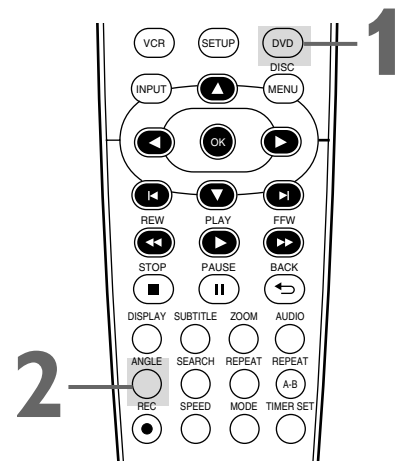

### Helpful Hints

- With some DVDs, you must select a subtitle language in the Disc Menu.
- If the desired language does not appear after pressing **SUBTITLE** several times, the disc does not have subtitles in that language.
- Opening the disc tray will cancel your Subtitle Setting.
- If the **ANGLE ICON** Setting is **ON**,  will appear on the TV screen when the current portion of the disc has multiple camera angles. To set the **ANGLE ICON ON** or **OFF**, see page 55-56.

## 40 Audio Language, Stereo Sound Mode

### Audio Language

You can select a language for DVDs during playback if multiple languages are available.

- 1 Press **DVD** to put the DVD/VCR in DVD mode. DVD light will appear on the front of the DVD/VCR.
- 2 During DVD playback, press **AUDIO** repeatedly to choose one of the available languages. Audio Display appears at the top of the TV screen, and the new audio will be heard. The display will disappear after about 5 seconds. The Audio Display may show the current settings for the Dolby Digital or Multi-channel sound, if they are available on the disc, and the sampling rate of the disc. The number of available languages appears after the “ / ” at the right of the display ( /3, for example).

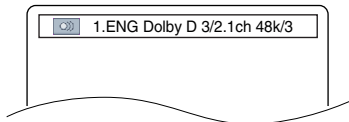

Example: English audio

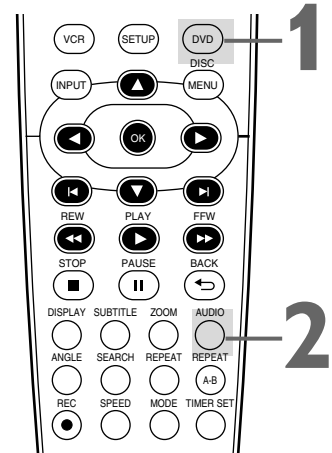

### Stereo Sound Mode

Adjust Stereo Sound to determine whether you will hear the left channel, the right channel or both channels (stereo) during Video CD or Audio CD playback.

If you connected the DVD/VCR to a Stereo using the COAXIAL DIGITAL AUDIO OUT jack as described on page 12, you cannot adjust stereo sound mode.

- 1 Press **AUDIO** repeatedly during Video CD or Audio CD playback to choose **STEREO**, **L-ch** or **R-ch**.

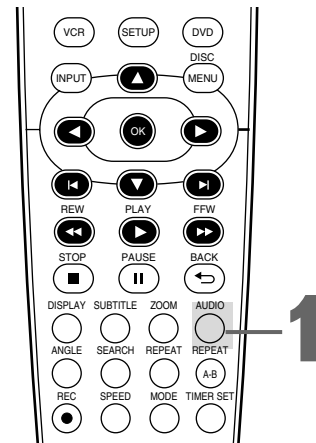
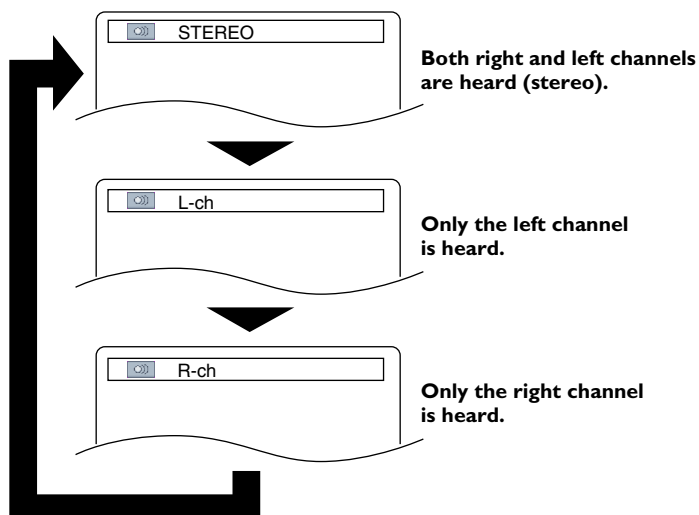

### Helpful Hints

- If a language is not available after pressing AUDIO several times, the DVD does not have that language.
- Some DVDs only let you change the language in the Disc Menu.
- Audio languages may be abbreviated (such as ENG for English). Or, three dashes ( - - - ) may appear instead of an abbreviation.
- Audio language selection cannot be made during Rapid Play with Voice. (Refer to page 33.)



## Slow Motion, Zoom 41

### Slow Motion

- 1** Press **PAUSE** **||** during DVD or Video CD playback.
- 2** Press **FFW** **▶▶** or **REW** **◀◀**. Slow Motion Playback will begin. Press **FFW** **▶▶** or **REW** **◀◀** repeatedly during Slow Motion Playback to play a DVD forward or backward at approximately 1/16, 1/8 or 1/2 the normal speed. Reverse slow motion is not available on a Video CD. An **▶▶ 1 (1/16)**, **▶▶ 2 (1/8)** or **▶▶ 3 (1/2)** will appear briefly on the TV screen to indicate Slow Forward Playback. An **◀◀ 1 (1/16)**, **◀◀ 2 (1/8)** or **◀◀ 3 (1/2)** will indicate Slow Reverse Playback.

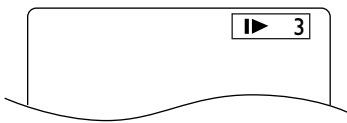

Example: Playing a DVD forward at half the normal speed.

- 3** Press **PLAY** **▶** to return to normal playback.

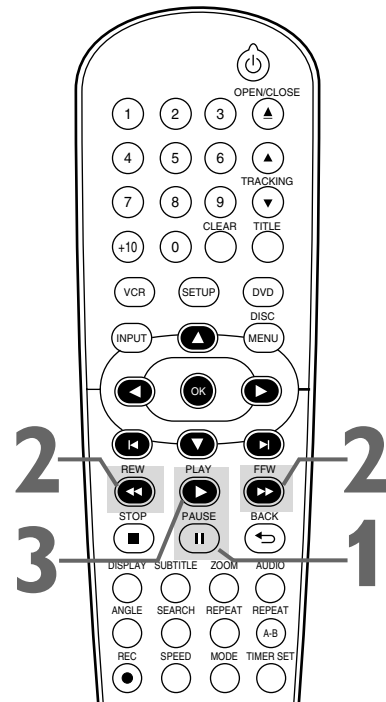

### Zoom

Zooming lets you enlarge the playback image of DVDs, Video CDs or JPEG files, and lets you pan through the enlarged image.

- 1** Press **ZOOM** during playback or when playback is paused. The picture will appear twice as large. Press **ZOOM** again to make the picture four times larger than normal. Either x2 or x4 will appear beside  icon in the upper left corner of the TV screen.
- 2** While the picture is enlarged, press **▲**, **▼**, **◀** or **▶** to move the zoomed image up, down, left or right. The gray box with an inner blue box that shows during Zoomed Playback is the position guide. To remove it or show it, press **OK**. The position of the blue box inside the gray box indicates the position of the zoomed image within the overall picture.



- To return the picture to normal, press **ZOOM** repeatedly.

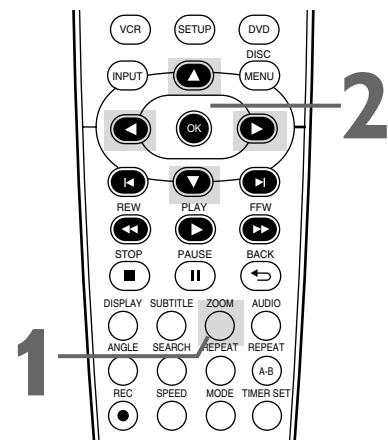

#### Helpful Hints

- Only slow forward is available for Video CDs.
- The sound will be mute during Paused or Slow Motion Playback.
- You cannot zoom a Disc Menu.
- The x4 zooming is not active with some discs. Only x2 zooming is available for Video CDs and JPEG files.
- Position guide is not available for JPEG playback.

## 42 Program/Random Playback

### Program Playback

You may determine the order in which Audio CD, MP3, Windows Media™ Audio or JPEG tracks will play.

### Random Playback

You may play the tracks of an Audio CD in Random order instead of the order in which they are recorded (1, 2, 3...). You can also use this feature for MP3, Windows Media™ Audio and JPEG tracks.

- 1 Press **DVD** to put the DVD/VCR in DVD mode. DVD light will appear on the front of the DVD/VCR.
- 2 While playback is stopped, press **MODE** repeatedly until the **PROGRAM/RANDOM** Screen appears.

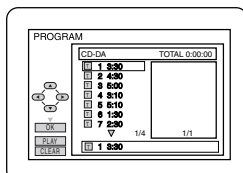

Example: Audio CD

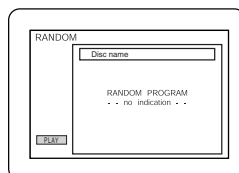

Example: MP3  
(DUAL PLAYBACK - OFF)

### Program Playback

- 3 Press **▲** or **▼** to select a track you want to play, then press **OK**.

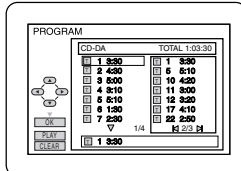

Example: Audio CD

Press **CLEAR** to erase the last track in the program if you make an error. Additional tracks may be on other screens. Press **▼** to go on to the next page, and press **▲** to go back to the previous page. Repeat this step until you have selected all the tracks you wish to play in the program. To see tracks in a program when there are more than 8 tracks, use **▶|**, **|◀** to see all the tracks. For MP3, Windows Media™ Audio or JPEG folders, press **◀** or **▶** to go to the previous or next level of folders. Press **TITLE** to return to the first item in the highest level.

- 4 Press **PLAY ▶**. The tracks will play once in the order you set. Turning off the player or opening the disc tray will erase the program.

### Random Playback

- 3 While the **RANDOM** Screen appears, press **PLAY ▶**. The tracks will play in random order. After all the tracks play once, playback will stop.

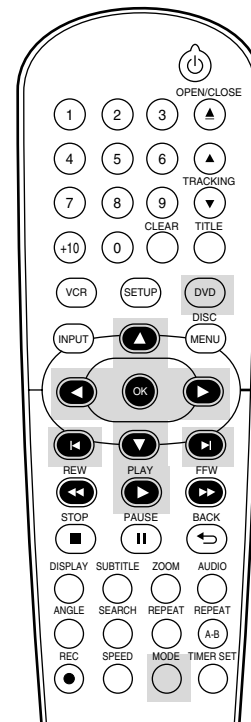

### Helpful Hints

- You cannot use the Number buttons or **SEARCH** to select another track during Program/Random Playback. Use **▶|** or **|◀** to select other tracks.
- You cannot combine Random Playback with a program.
- You may play a program or a track within a program repeatedly. During Program Playback, press **REPEAT** so **ALL** (all tracks in the program) or **TRACK** appears. The entire program or the current track will play over and over.
- You cannot alter a program during playback.
- You can start Program Playback only while in the **PROGRAM** Screen.
- A program can have a maximum of 99 tracks.
- To erase all tracks in the program, select **ALL CLEAR** at step 3.
- Program/Random Playback of MP3, Windows Media™ Audio or JPEG tracks is not available while **DUAL PLAYBACK** is **ON**.

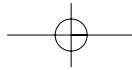

## MP3/Windows Media™ Audio/JPEG Playback 43

The DVD/VCR will play MP3, Windows Media™ Audio and JPEG files that you record and finalize on a CD-R (Compact Disc-Recordable) or CD-RW (Compact Disc-Rewritable).

These discs may contain pictures in a JPEG format or audio tracks in an MP3 or Windows Media™ Audio format. For example, you may have photographic film developed by a retailer that places the pictures on a CD-R for you. These pictures may be in JPEG format. Or, you may copy or download MP3/Windows Media™ Audio music files from certain legal Internet sites, then copy those files onto a CD-R or CD-RW.

You cannot make or record such discs using this DVD/VCR. See your computer manual for details on recording.

Keep these characteristics in mind when making discs you intend to play on the DVD player of this DVD/VCR.



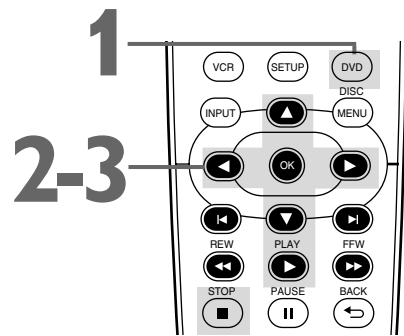

- Record MP3 files at a sampling frequency of 44.1 kHz or 48 kHz. Record in a constant bit rate between 32 kbps and 320 kbps.
- Record Windows Media™ Audio tracks at a sampling frequency of 44.1kHz or 48kHz. Record in a constant bit rate between 48 kbps and 192kbps.
- When recording JPEG files, the size of the picture should be between 32 x 32 and 6300 x 5100 dots.

- 1 Press DVD** to put the DVD/VCR in DVD mode. DVD light will appear on the front of the DVD/VCR.
- 2** When you put a CD-R or CD-RW with MP3, Windows Media™ Audio or JPEG files in the DVD/VCR, a File List will appear automatically. Or if the disc is already in the DVD/VCR and you want to call up the File List, press DISC MENU. (If you use PLAY ► to close the disc tray, Playback starts automatically.) **Press ▲ or ▼ to select a folder, MP3, Windows Media™ Audio or JPEG file.**
- 3 If you choose a track or file, press PLAY ► or OK.** Starting with the track or file you selected, the tracks/files will play in the order they were recorded, i.e. 1, 2, 3. **If you select a folder and press OK, the tracks or files within that folder will appear. Press ▲ or ▼ to select the track or file you want to play, then press PLAY ► or OK.**

- Press TITLE to return to the first item in the highest level of folders or files. You also can press ◀ or ▶ to return to previous or next levels.
- To change the Transition Mode for JPEG playback, press MODE repeatedly until Transition Mode appears on top of the TV screen during playback. Then press ◀, ▶ or OK to switch CUT IN/OUT and FADE IN/OUT. If you choose CUT IN/OUT, the images will cut in and out sharply as playback progresses. If you choose FADE IN/OUT, the images will fade in and out as playback progresses.
- To change the size of the playback image, press MODE repeatedly until SIZE MODE appears at the top of the TV screen during playback. Then press ◀, ▶ or OK to switch NORMAL(100%) and SMALL(95%).
- Press MODE or BACK ↵ to remove the display.
- During JPEG playback, press ANGLE to rotate a picture 90 degrees clockwise.
- To stop playback, press STOP ■.



### Helpful Hints

- MP3/Windows Media™ Audio tracks and JPEG images are known as files. Groups of files are called folders.
- Folders have the  icon, MP3 files have the  icon, Windows Media™ Audio files have the  icon, and JPEG files have the  icon.
- A maximum of 255 folders can be recognized. A maximum of 999 files can be recognized.
- If you use PLAY ► to close the disc tray, playback starts automatically. If you use OPEN/CLOSE ▲ to close the disc tray, you have to press PLAY ► to start playback.
- During playback, use the Number buttons or ▶ and ◀ to change tracks. If a track is not available, "X" will appear on the TV screen, and playback may resume at an incorrect track or may continue with its current track.
- To see the File List during playback, press DISC MENU. The current track will be highlighted.
- Progressive JPEGs (JPEG files saved in the progressive format) will not play on this DVD/VCR.
- Copyright protected Windows Media™ Audio files will not play on this DVD/VCR.
- High resolution JPEG files takes longer to be displayed.
- SIZE MODE may have no effect on some files (e.g. files with a small picture size).

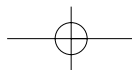
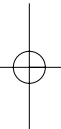
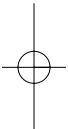

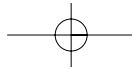

## 44 MP3/Windows Media™ Audio/JPEG Playback (cont'd)

### Dual Playback

This feature lets you play MP3 and JPEG files simultaneously. Available only when DUAL PLAYBACK is ON. See pages 55-56 on how to set the DUAL PLAYBACK ON or OFF.

- 1** Press **DVD** to put the DVD/VCR in DVD mode. DVD light will appear on the front of the DVD/VCR.
- 2** Press **DISC MENU** during MP3/JPEG playback. A File List will appear.
- 3** Press **▲** or **▼** to select a desired MP3/JPEG file from the list and press **PLAY ►** or **OK**.
  - To stop playback, press **STOP ■**.

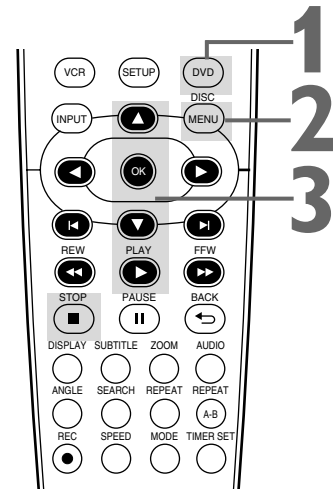

### Folder Playback

You may select to play a folder containing MP3 and JPEG files. Available only when DUAL PLAYBACK is ON. See pages 55-56 on how to set the DUAL PLAYBACK ON or OFF.

- 1** Press **DVD** to put the DVD/VCR in DVD mode. DVD light will appear on the front of the DVD/VCR.
- 2** While playback is stopped, press **MODE**. A Folder List will appear.
- 3** Press **▲** or **▼** to select a folder, then press **PLAY ►** or **OK**.
  - MP3 and JPEG files in the selected folder will play simultaneously.

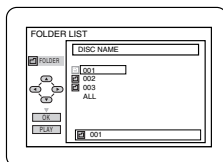

- If Windows Media™ Audio files are in the folder, those files will be skipped during Folder Playback.

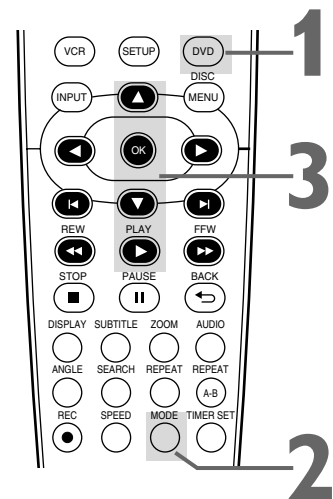

### Helpful Hints

- If you press **PLAY ►** directly after you inserted a disc which contains both MP3 and JPEG files and if the **DUAL PLAYBACK** Setting is **ON**, Dual Playback will start automatically.
- You can not play Windows Media™ Audio and JPEG files together at the same time. If you choose a Windows Media™ Audio file during Dual Playback, only Windows Media™ Audio file will play.
- Dual Playback may not function properly if MP3 and JPEG files on the disc interfere each other due to the difference in their data size.

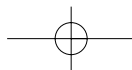

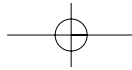

# On-Screen Displays 45

## DVD Displays

- 1 Press DVD** to put the DVD/VCR in DVD mode. DVD light will appear on the front of the DVD/VCR.
- 2 Press DISPLAY repeatedly** to see the following displays during DVD playback.

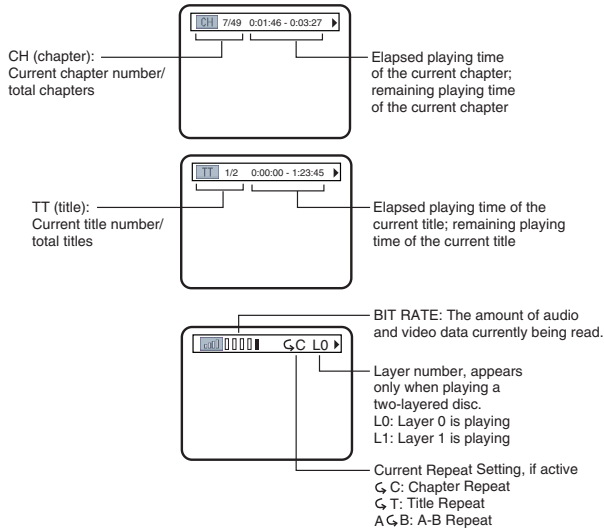

- 3 Press DISPLAY repeatedly** or press BACK to remove the display.

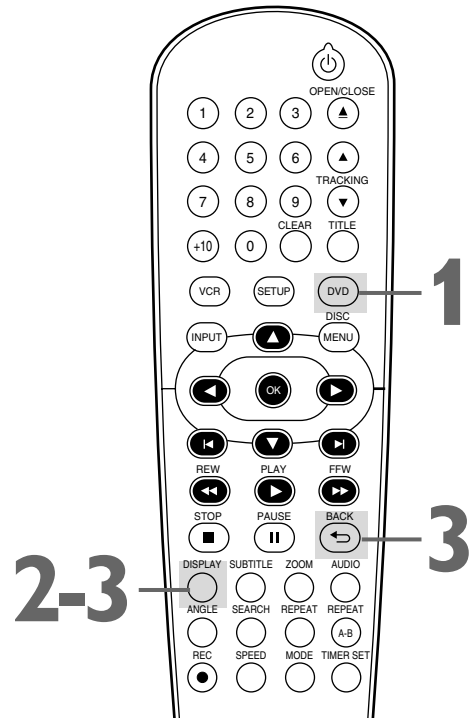

## Video CD and Audio CD Displays

- 1 Press DVD** to put the DVD/VCR in DVD mode. DVD light will appear on the front of the DVD/VCR.
- 2 Press DISPLAY repeatedly** to see the following displays during Video CD (without PBC) or Audio CD playback.

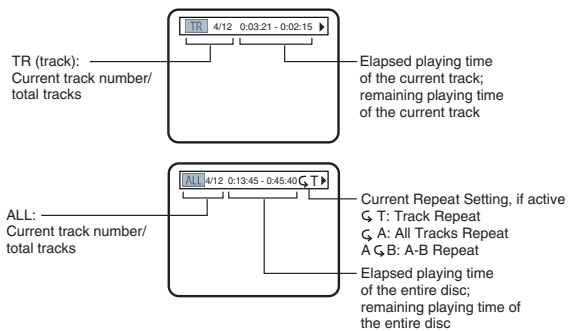

- 3 Press DISPLAY repeatedly** or press BACK to remove the display.

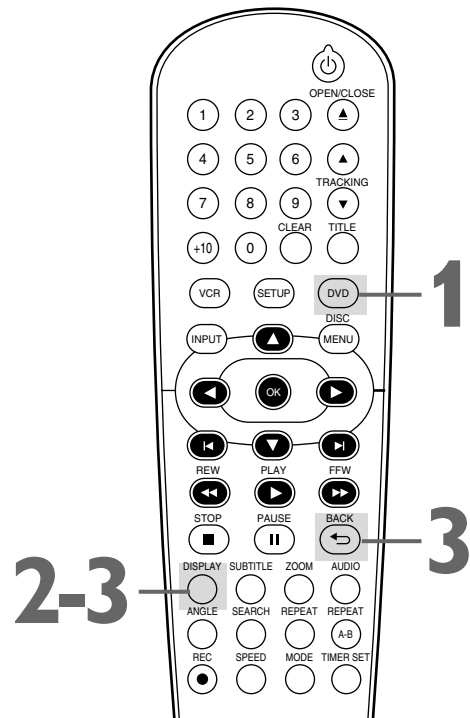

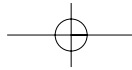

English

# 46 On-Screen Displays (cont'd)

## MP3/Windows Media™ Audio/JPEG Displays

- 1** Press **DVD** to put the DVD/VCR in DVD mode. DVD light will appear on the front of the DVD/VCR.
- 2** Press **DISPLAY** repeatedly until the current track or file information appears.

**During JPEG playback**

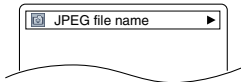

or

**During MP3 playback**

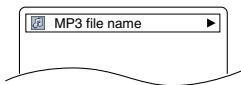

**During Windows Media™ Audio playback**

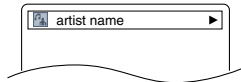
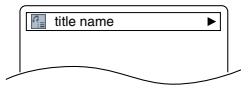
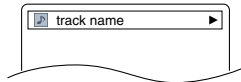

- If Dual Playback is on, MP3 file name will be displayed after JPEG file name.

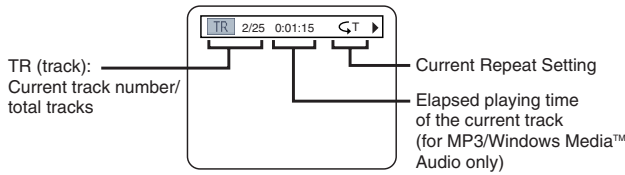

**Example: MP3 playback**

The following may appear to indicate Repeat Playback.

- T: The current track will play repeatedly.
- G: Tracks in the current folder (group) will play repeatedly.
- A: All tracks will play repeatedly.

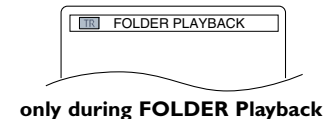
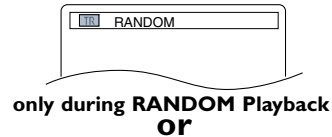
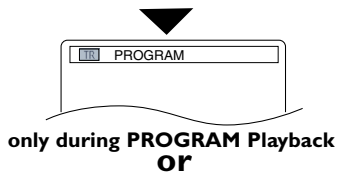

- Program and Random Playback is available only when DUAL PLAYBACK is OFF.
- Folder Playback is available only when DUAL PLAYBACK is ON.

- 3** Press **DISPLAY** or **BACK** to remove the display.

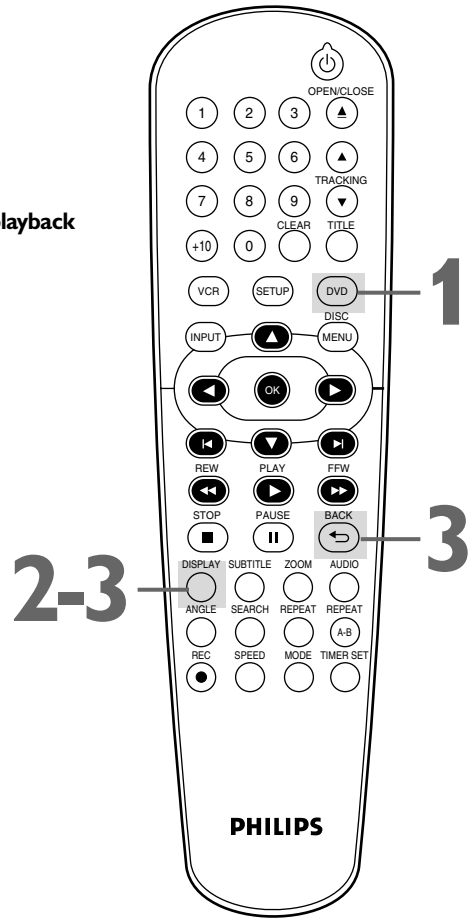

### Helpful Hint

- For MP3 files recorded with Variable Bit Rate (VBR), the elapsed time displayed on the screen may vary from the actual elapsed time.

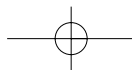



## Black Level, Virtual Surround 47

### Black Level

Adjust Black Level to brighten the DVD or Video CD picture.

- 1** Press **DVD** to put the DVD/VCR in DVD mode. DVD light will appear on the front of the DVD/VCR.
- 2** During DVD or Video CD playback, press **MODE** so the Black Level icon shows in the top left corner of the TV screen.  
 **ON**
- 3** While the Black Level icon is shown, press **◀, ▶** or **OK** repeatedly to choose **ON** or **OFF**. **ON** brightens the dark parts of the picture. **OFF** shows the original picture as recorded. The icon will disappear after about 10 seconds.

### Virtual Surround

You can enjoy improved stereo sound when you play DVDs, Video CDs, Audio CDs, MP3 or Windows Media™ Audio files recorded in Dolby Digital or Pulse Code Modulation (PCM). Check the disc case for details on availability.

- 1** Press **DVD** to put the DVD/VCR in DVD mode. DVD light will appear on the front of the DVD/VCR.
- 2** During disc playback, press **MODE** repeatedly until the Virtual Surround icon appears in the top left corner of the TV screen.  
 **OFF**
- 3** While the Virtual Surround icon is shown, press **◀, ▶** or **OK** to choose **1 (Natural)**, **2 (Emphasized)** or **OFF**. The icon will disappear after about 10 seconds. The default setting is **OFF**.

### Helpful Hints

- Black Level is not available for a PAL DVD.
- If you want to enjoy Dolby Digital in Virtual Surround through coaxial cable connection, set Dolby Digital to PCM.
- For Video CDs and Audio CDs, you can adjust Virtual Surround only if you set Stereo Sound to STEREO. *Details are on page 40.*
- The Black Level and the Virtual Surround Settings will be saved even if the player is turned off.
- When the Virtual Surround function is active, 96 kHz sound source will be down sampled at 48 kHz, and output as 48 kHz sound.
- The Black Level and Virtual Surround Settings cannot be used during x1.3 and x0.8 Rapid Play with Voice (refer to page 33).

## Initializing

Use INITIALIZE to return all your DVD player's Setup Menu items (except PARENTAL) to their default settings.

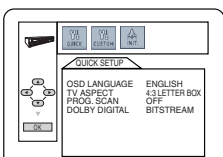
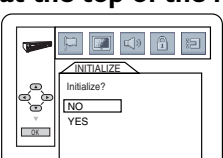
- 1** Press **DVD** to put the DVD/VCR in DVD mode. DVD light will appear on the front of the DVD/VCR.
- 2** While playback is stopped, press **SETUP**. The QUICK SETUP Screen appears.  

- 3** Press **◀** or **▶** to select **INIT. (INITIALIZE)** at the top of the menu, then press **OK**.  

- Press **▲** or **▼** to select **YES**. Then, press **OK** twice. To cancel the process, select **NO** instead.

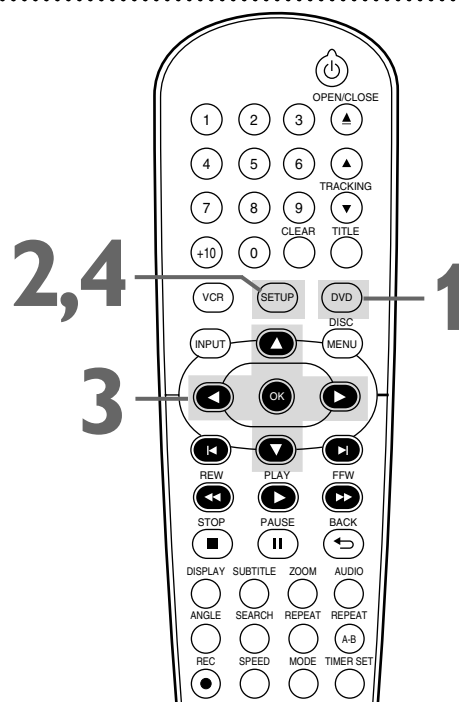
- 4** Press **SETUP** to remove the menu.





## 48 Language

You can select different languages for the Audio or Subtitles of DVDs, as well as languages for DVD Disc Menus and the Setup Menus of the DVD player.

- 1** Press **DVD** to put the DVD/VCR in DVD mode. DVD light will appear on the front of the DVD/VCR.
- 2** While playback is stopped, press **SETUP**. The QUICK SETUP Screen appears.
- 3** Press **◀** or **▶** to select **CUSTOM** at the top of the menu, then press **OK**.

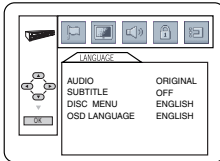

- 4** With **LANGUAGE** selected, press **OK**.

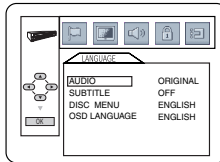

- 5** Press **▲** or **▼** to select **AUDIO**, **SUBTITLE**, **DISC MENU** or **OSD LANGUAGE**. Press **OK**. The language options for the selected item will appear.

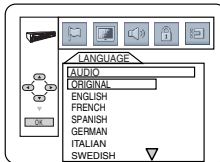

**AUDIO:** The DVD's audio plays in the selected language. The default setting is **ORIGINAL**.

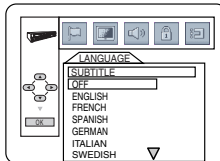

**SUBTITLE:** Subtitles appear in the selected language. The default setting is **OFF**.

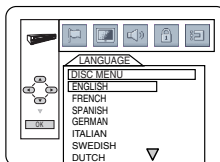

**DISC MENU:** A DVD's Disc Menu appears in the selected language. The default setting is **ENGLISH**.

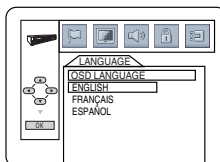

**OSD LANGUAGE:** The DVD player's Setup Menu can be in English, French or Spanish only. The default setting is **ENGLISH**.

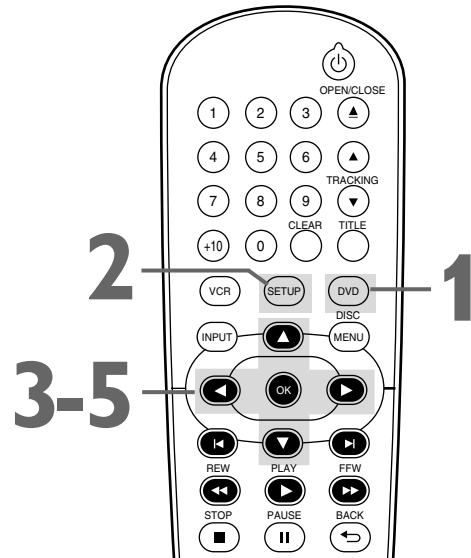

### Helpful Hints

- If the DVD's default settings for Audio and Subtitle are the same language, the subtitles may not show unless you turn them on.
- Use the **AUDIO** and **SUBTITLE** buttons to select Audio and Subtitles available on the DVD. *Details are on pages 39-40.*
- If you set **AUDIO** to **ORIGINAL**, the default setting of the DVD Audio will play.
- If you set **OSD LANGUAGE** to **FRANÇAIS** (French) or **ESPAÑOL** (Spanish) and need English: Follow steps 1-2. At step 3, the **IDIOMA** or **LANGUE** Menu will appear. Press **OK**. Press **▼** to select **LANGUE OSD** or **IDIOMA PANT.**, then press **OK**. Press **▲** to select **ENGLISH**, then press **OK**. The menu will change to English. Press **SETUP** to remove the menus.
- You can change the **OSD LANGUAGE** in the **QUICK SETUP** Menu that appears when you first press **SETUP**. With **QUICK** selected, press **OK**. **OSD LANGUAGE** will be selected. Press **OK**. Press **▲** or **▼** to choose a language, then press **OK**. Press **SETUP** to remove the menu.
- The Language Settings may not take effect until you restart disc playback from the beginning.

# Language (cont'd) 49

**6** Press **▲** or **▼** to select a language, then press **OK**. The language lists may continue on multiple screens. Press **▲** or **▼** to move to the other screens.

- If you select **OTHER** for **AUDIO**, **SUBTITLE**, or **DISC MENU**, press four **Number** buttons to enter the code for the language you desire. Use one of the Language Codes listed below. The language or language code you select will appear in the Language Menu beside **AUDIO**, **SUBTITLE**, or **DISC MENU**.

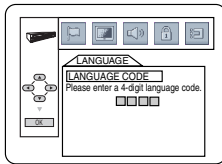

- You can select other languages for **AUDIO**, **SUBTITLE** and **DISC MENU** only if the language is available on the disc. If the language you select is not recorded on the DVD, changing these settings will have no effect.

**7** Press **SETUP** to remove the menu.

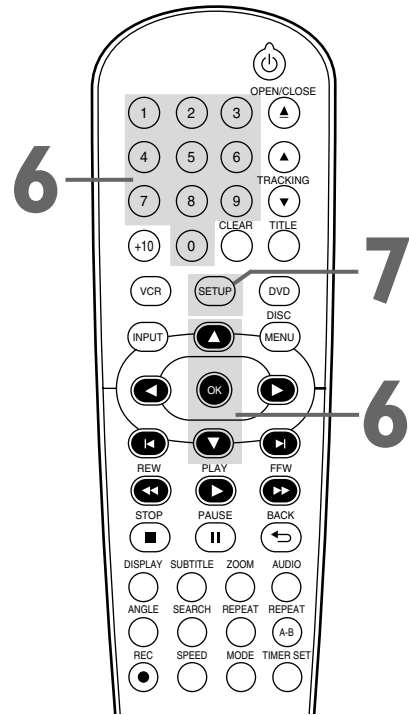

## Language Codes

<b>A-B</b>	English	5160	Kannada	5760	Panjabi	6247	<b>T</b>		
Abkhazian	4748	Esperanto	5161	Kashmiri	5765	Pashto	6265	Tagalog	6658
Afar	4747	Estonian	5166	Kazakh	5757	Persian	5247	Tajik	6653
Afrikaans	4752	<b>F-H</b>		Kinyarwanda	6469	Polish	6258	Tamil	6647
Albanian	6563	Faroese	5261	Kirghiz	5771	Portuguese	6266	Tatar	6666
Amharic	4759	Fiji	5256	Kirundi	6460	Pushto	6265	Telugu	6651
Arabic	4764	Finnish	5255	Korean	5761	Quechua	6367	Thai	6654
Armenian	5471	French	5264	Kurdish	5767	Rhaeto-Romance	6459	Tibetan	4861
Assamese	4765	Frisian	5271	<b>L-N</b>		Romanian	6461	Tigrinya	6655
Aymara	4771	Gaelic (Scots)	5350	Laothian	5861	Russian	6467	Tonga	6661
Azerbaijani	4772	Galician	5358	Latin	5847	<b>S</b>		Tsonga	6665
Bangla	4860	Georgian	5747	Latvian	5868	Samoan	6559	Turkish	6664
Bashkir	4847	German	5051	Lettish	5868	Sangho	6553	Turkmen	6657
Basque	5167	Greek	5158	Lingala	5860	Sanskrit	6547	Twi	6669
Bengali	4860	Greenlandic	5758	Lithuanian	5866	Serbian	6564	<b>U-Z</b>	
Bhutani	5072	Guarani	5360	Macedonian	5957	Serbo-Croatian	6554	Ukrainian	6757
Bihari	4854	Gujarati	5367	Malagasy	5953	Sesotho	6554	Urdu	6764
Bislama	4855	Hausa	5447	Malay	5965	Setswana	6660	Uzbek	6772
Breton	4864	Hebrew	5569	Malayalam	5958	Shona	6560	Vietnamese	6855
Bulgarian	4853	Hindi	5455	Maltese	5966	Sindhi	6550	Volapuk	6861
Burmese	5971	Hungarian	5467	Maori	5955	Singhalese	6555	Welsh	4971
Byelorussian	4851	<b>I-K</b>		Marathi	5964	Siswat	6565	Wolof	6961
<b>C-E</b>		Icelandic	5565	Moldavian	5961	Slovak	6557	Xhosa	7054
Cambodian	5759	Indonesian	5560	Mongolian	5960	Slovenian	6558	Yiddish	5655
Catalan	4947	Interlingua	5547	Nauru	6047	Somali	6561	Yoruba	7161
Chinese	7254	Interlingue	5551	Nepali	6051	Spanish	5165	Zulu	7267
Corsican	4961	Inupiak	5557	Norwegian	6061	Sundanese	6567		
Croatian	5464	Irish	5347	<b>O-R</b>		Swahili	6569		
Czech	4965	Italian	5566	Occitan	6149	Swedish	6568		
Danish	5047	Japanese	5647	Oriya	6164				
Dutch	6058	Javanese	5669	Oromo (Afan)	6159				

## 50 Display

You may adjust the TV Aspect ratio and still mode clarity, and Progressive Scan compatibility.

- 1 Press DVD to put the DVD/VCR in DVD mode.**  
DVD light will appear on the front of the DVD/VCR.
- 2 When playback is stopped, press SETUP.**  
The QUICK SETUP Screen will appear.

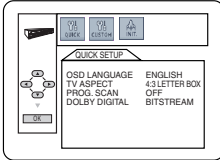

- 3 Press ◀ or ▶ to select CUSTOM at the top of the menu, then press OK.**

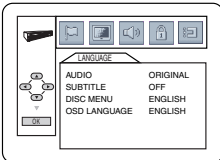

- 4 Press ◀ or ▶ to select [DISPLAY], then press OK.**

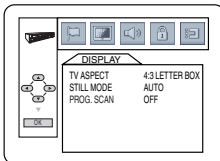

- 5 Press ▲ or ▼ to select an item, then press OK.**  
• If you selected TV ASPECT, press ▲ or ▼ to select a setting, then press OK.

Choose 4:3 LETTER BOX if you want to see the entire, widened picture with black bars at the top and bottom of the screen. This looks like the picture you see when watching movies in a theater. This setting is possible only if the DVD was recorded in the letterbox or widescreen format.

Choose 4:3 PAN & SCAN for a full height picture, with both sides trimmed. Some companies refer to this as reformatting the picture to fit your TV screen and may call it the regular or normal format.

Choose 16:9 WIDE if you connected a widescreen TV to the DVD player.

The default setting is 4:3 LETTER BOX.

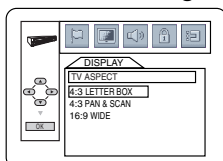

**TV ASPECT**

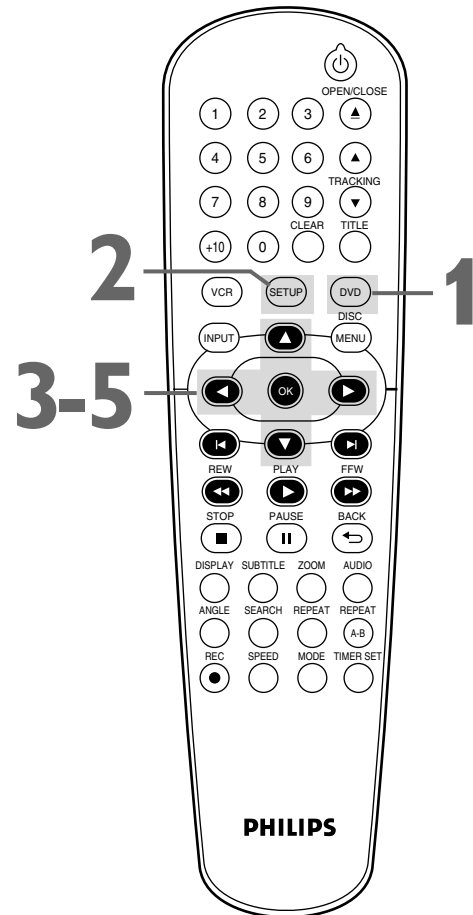

### Helpful Hints

- Selecting a different TV ASPECT Setting is only effective if it is available on the DVD. Check the DVD Disc Menu or case for details.
- You also can adjust TV ASPECT in the QUICK SETUP Menu that appears when you first press SETUP. With QUICK selected, press OK. Press ▼ to select TV ASPECT, then press OK. Press ▲ or ▼ to choose a setting, then press OK. Press SETUP to remove the menu.
- This unit does not set the TV aspect automatically.

## Display (cont'd) 51

- If you selected **STILL MODE**, press **▲** or **▼** to select a setting, then press **OK**. This determines the quality of an image in still mode. If you select **FIELD**, still images will be stabilized but coarse due to the small amount of data. If you select **FRAME**, the images will be highly defined due to the simultaneous output of two fields. The default setting is **AUTO**.

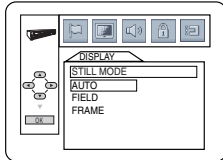

STILL MODE

- 6** Press **SETUP** to remove the menu.

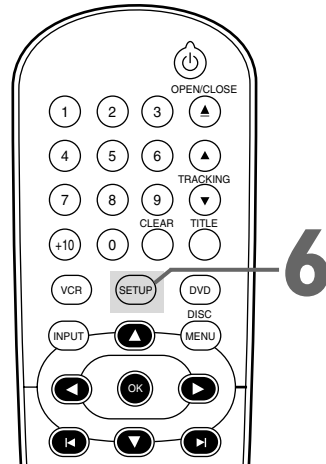

## Progressive Scan

You may adjust the Progressive Scan compatibility.

- 1** Follow the steps 1-4 in the Display setup on page 50.
- 2** Press **▲** or **▼** to select **PROG. SCAN**, then press **OK** repeatedly to turn **PROG. SCAN ON** or **OFF**. Choose **ON** if your TV has Progressive Scan and if the TV is connected to the player's **COMPONENT VIDEO OUT** jacks. Choose **OFF** otherwise. The default setting is **OFF**.
- 3** Press **SETUP** to remove the menu.
  - If **PROG. SCAN** is **ON**, this message appears:

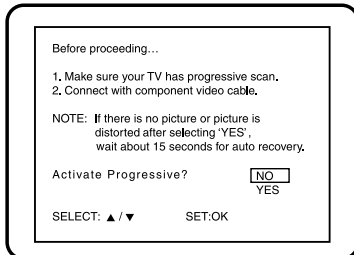

- Press **▲** or **▼** to make a selection, then press **OK**. If you select **NO**, the menu disappears and **PROG. SCAN** is **OFF**. If you select **YES**, this appears:

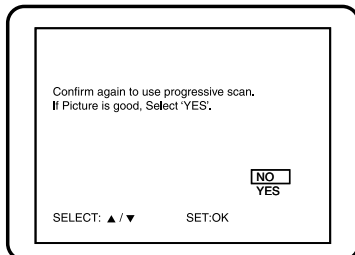

- Confirm your setting, then press **OK**. The menu will disappear and the Progressive Scan function will be activated. If you do not press any buttons for 15 seconds, Progressive Scan will switch to **OFF**.

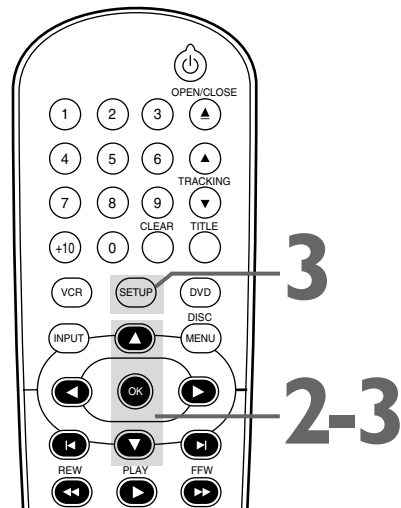

### Helpful Hints

- You can set **PROG. SCAN** to **OFF** either in the **DISPLAY** Menu or by pressing and holding **PLAY ►** (DVD) on the front of the player for more than 5 seconds.
- You can adjust Progressive Scan Setting in the **QUICK SETUP** Menu that appears when you first press **SETUP**. With **QUICK** selected, press **OK**. Press **▼** to select **PROG. SCAN**. Press **OK** to choose **OFF** or **ON**. Press **SETUP** to remove the menu.

## 52 Audio

Change Audio Settings based on other equipment you connected to the DVD player or according to your disc sound features. These setting only affect the Audio from the DVD player of the DVD/VCR.

**1 Press DVD to put the DVD/VCR in DVD mode.**  
DVD light will appear on the front of the DVD/VCR.

**2 While playback is stopped, press SETUP.**  
The QUICK SETUP Screen will appear.

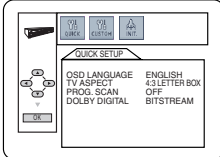

**3 Press ◀ or ▶ to select CUSTOM at the top of the menu, then press OK.**

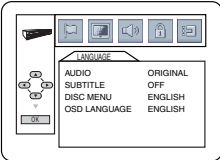

**4 Press ◀ or ▶ to select AUDIO (AUDIO) at the top of the menu, then press OK.**

**5 Press ▲ or ▼ to select DRC, DOWN SAMPLING, or DOLBY DIGITAL, then follow step 6 accordingly.**

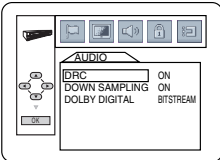

**6**

- If you selected **DRC**, press **OK** repeatedly to turn **Dynamic Range Control (DRC) ON or OFF**. Choosing **ON** compresses the range of volume by suppressing loud sounds and raising low sounds. DRC is available only on discs recorded in the Dolby Digital format. The default setting is **ON**.

- If you selected **DOWN SAMPLING**, press **OK** repeatedly to choose **ON or OFF**. Choose **ON** to down sample the 96 kHz sound source to 48 kHz. Choose **OFF** to output the sound source without any down sampling. **DOWN SAMPLING** is available only when the player is connected to a Stereo using the **COAXIAL DIGITAL AUDIO OUT** jack as described on page 12. The default setting is **ON**.

- If you selected **DOLBY DIGITAL**, press **OK** repeatedly to select **BITSTREAM or PCM**. Select **BITSTREAM** if you used the **COAXIAL DIGITAL AUDIO OUT** jack to connect the DVD player to a stereo that is Dolby Digital compatible. *Details are on page 12.* Otherwise, choose **PCM**. The default setting is **BITSTREAM**.

**7 Press SETUP to remove the menu.**

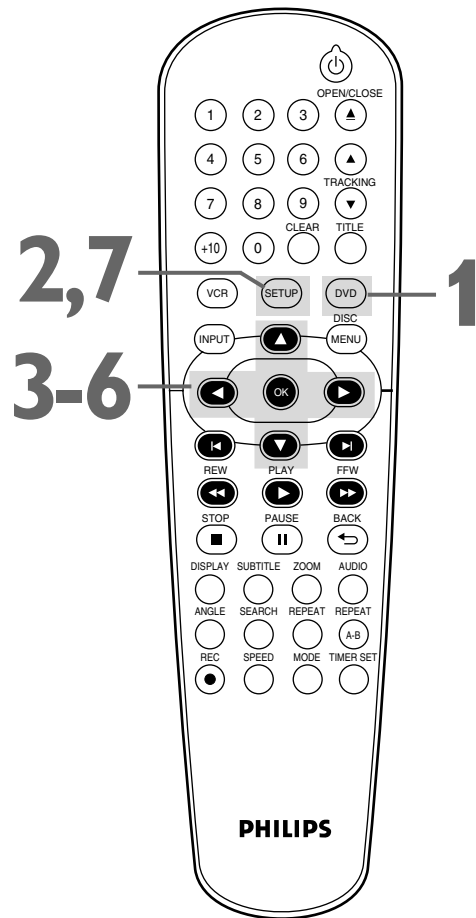

### Helpful Hints

- Dolby Digital sound must be available on the DVD.
- You can adjust **DOLBY DIGITAL** in the **QUICK SETUP** Menu that appears when you first press **SETUP**. With **QUICK** selected, press **OK**. Press ▼ to select **DOLBY DIGITAL**. Press **OK** to choose **BITSTREAM** or **PCM**. Press **SETUP** to remove the menu.
- When you play a disc that has copyright protection, downsampling will be at **48 kHz**, even if you set **DOWN SAMPLING** to **OFF**.

## Parental Password 53

Parental Controls prevents viewing of DVDs that exceed your rating limits. This feature will not limit viewing if the DVD is not rated or coded. Check your DVDs and settings before letting children access the DVD/VCR. You will need a password to change the Parental Settings or to play a blocked disc. Follow these steps to change your password.

**1 Press DVD to put the DVD/VCR in DVD mode.**  
DVD light will appear on the front of the DVD/VCR.

**2 While playback is stopped, press SETUP.**  
The QUICK SETUP Screen appears.

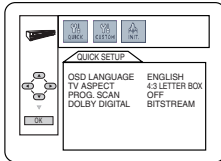

**3 Press ◀ or ▶ to select CUSTOM, then press OK.**

**4 Press ◀ or ▶ to select (PARENTAL), then press OK.**  
● If this is the first time you set a password, this menu will appear.

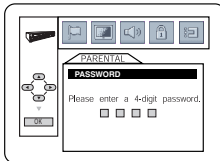

**Press the Number buttons to enter a 4-digit password.**  
The password will appear on the screen. Write it down so you will not forget it.

**Press OK, and proceed to step 7.**

● If you have set a password before, this menu will appear.

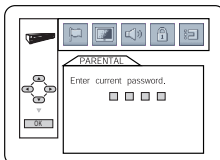

**Press the Number buttons to enter your current 4-digit password.** Asterisks (\*) will appear instead of your password. This protects its identity. **Press OK, and proceed to step 7.**

**5 If you like to change the password, press ▲ or ▼ to select PASSWORD CHANGE, then press OK.**

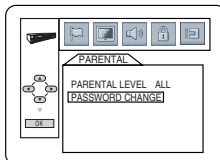

**6 Press the Number buttons to enter a 4-digit password.**  
The password numbers will appear on the screen. Write down the password so you will not forget it. **Press OK.** The previous menu will reappear.

**7 Press SETUP to remove the menu.**

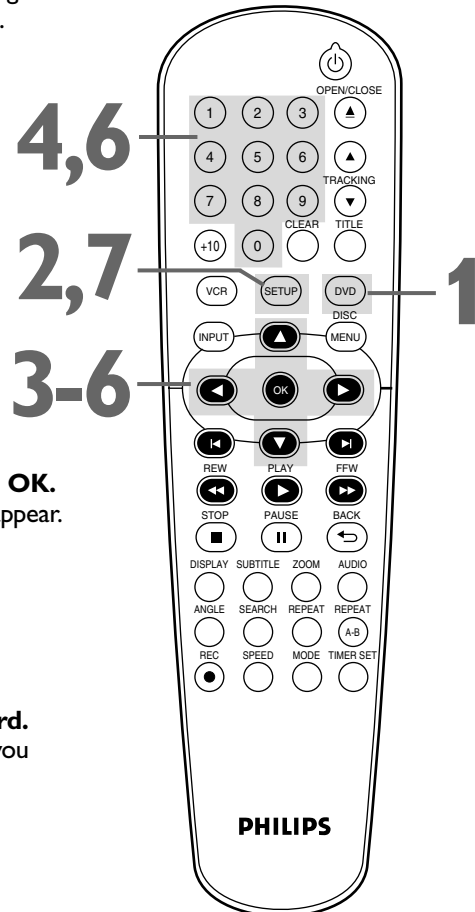

### Helpful Hints

- The default password is 4737. If you forget your password, press Number buttons 4, 7, 3, 7 at step 4. You will be prompted to enter a new 4-digit password. Use the Number buttons to enter a new 4-digit password, then press OK. PARENTAL LEVEL will reset to ALL. See page 54 to reset PARENTAL LEVEL as you desire.
- A power failure will not erase your password.



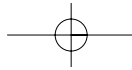

## 54 Parental Levels

Follow these steps to set the rating level for your DVDs.  
DVDs whose ratings exceed the level you set will not play.

**1 Press DVD to put the DVD/VCR in DVD mode.**  
DVD light will appear on the front of the DVD/VCR.

**2 While playback is stopped, press SETUP.**  
The QUICK SETUP Screen appears.

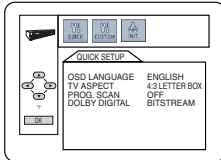

**3 Press ◀ or ▶ to select CUSTOM at the top of the menu, then press OK.**

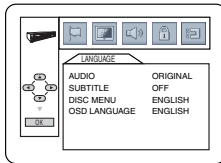

**4 Press ◀ or ▶ to select (PARENTAL), at the top of the menu, then press OK.**

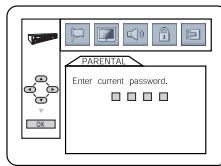

**5 Press the Number buttons to enter your 4-digit password.**

**6 Press ▲ or ▼ to select PARENTAL LEVEL, then press OK.**

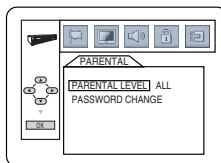

**7 Press ▲ or ▼ to select a level, then press OK.**  
The rating levels continue on two menu screens. Press ▲ or ▼ repeatedly to move to the next or previous screen to find the rating level you want.  
After making your selection, the previous menu will appear. The level you selected will appear beside PARENTAL LEVEL.

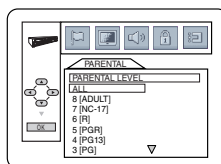

**8 Press SETUP to remove the menu.**

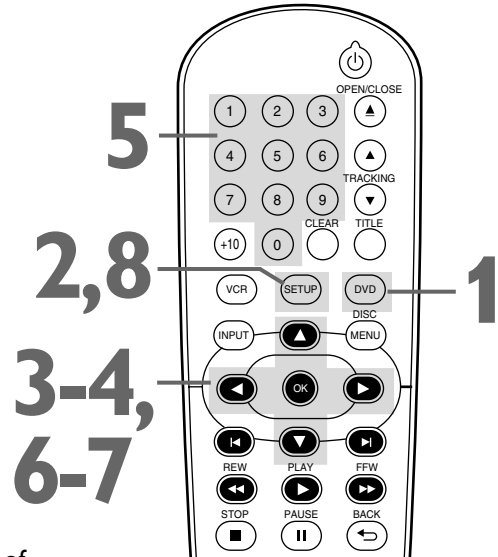

### RATING EXPLANATIONS

- ALL : Parental Control is inactive; all discs can play.
- 8 [ADULT]: DVD softwares of any grades (adult/general/children) can be played back.
- 7 [NC-17]: No one under 17 admitted
- 6 [R]: Restricted; under 17 requires accompanying parent or adult guardian
- 5 [PGR]: Parental Guidance Recommended
- 4 [PG13]: Unsuitable for children under 13
- 3 [PG]: Parental Guidance suggested
- 2 [G]: General Audience
- 1 [KID SAFE]: Suitable for children

### Helpful Hints

- When you try to play a DVD whose rating exceeds the level you set, an on-screen message will indicate the DVD cannot play. Remove the DVD, then set PARENTAL LEVEL to ALL. Reload the DVD and begin playback. Some DVDs may let you enter your 4-digit password to begin playback. Follow the on-screen messages as prompted.
- You cannot use the default password (4737) to play a DVD.
- The resume information will be cleared if you change the parental level when the resume information is on.



You may adjust the Angle Icon, Automatic Power Off, Dual Playback and Slide Show Settings.

- 1** Press **DVD** to put the DVD/VCR in DVD mode. DVD light will appear on the front of the DVD/VCR.
- 2** While playback is stopped, press **SETUP**. The QUICK SETUP Screen appears.

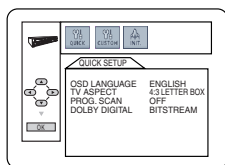

- 3** Press **◀** or **▶** to select **CUSTOM** at the top of the menu, then press **OK**.

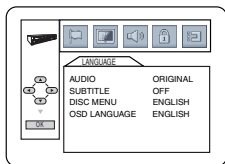

- 4** Press **◀** or **▶** to select **OTHERS**, then press **OK**.

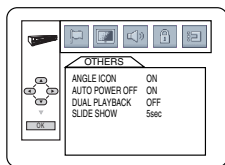

- 5** Press **▲** or **▼** to select an item, then press **OK**.

- If you selected **ANGLE ICON**, press **OK** repeatedly to select **ON** or **OFF**. Choose **ON** to see the Angle icon when multiple camera angles are available during DVD playback. *Details are on page 39.* Choose **OFF** to disable the Angle icon.

The default setting is **ON**.

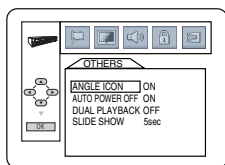

#### ANGLE ICON

Instructions continue on the next page.

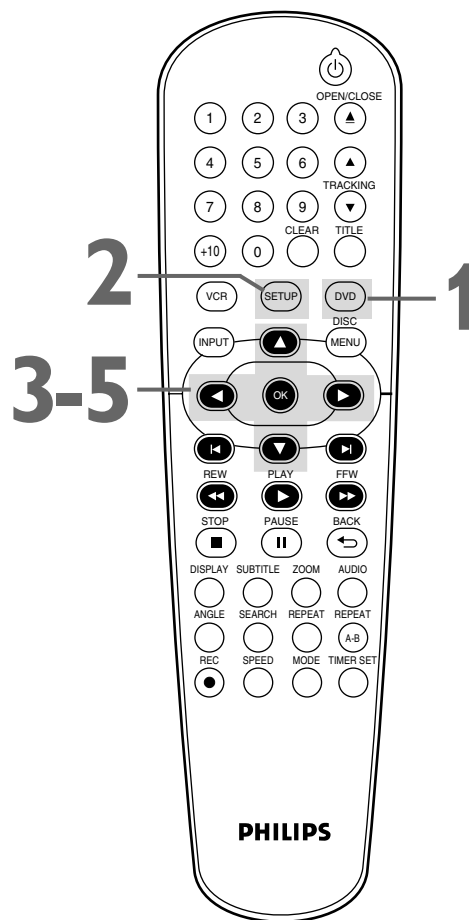

## 56 Others (cont'd)

Instructions continued from the previous page.

- If you selected **AUTO POWER OFF**, press **OK** repeatedly to choose ON or OFF. Choose ON if you want the player to turn off when there is no activity at the player or its remote for 30 minutes. The default setting is ON.

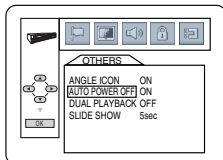

**AUTO POWER OFF**

- If you selected **DUAL PLAYBACK**, press **OK** to choose ON or OFF. This feature lets you play MP3 and JPEG files simultaneously. The default setting is OFF.

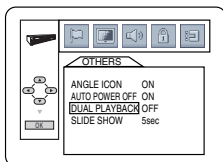

**DUAL PLAYBACK**

- If you selected **SLIDE SHOW**, press **▲** or **▼** to choose 5sec, 10sec or MUSIC, then press **OK**. This adjusts the playback speed of the SLIDE SHOW. Choose 5 sec to display each image for 5 seconds. Choose 10 sec to display each image for 10 seconds. Choose MUSIC to display an image for each MP3 sound file playback when DUAL PLAYBACK is ON. The default setting is 5 sec.

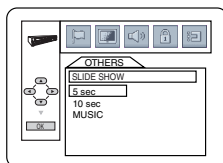

**SLIDE SHOW**

## 6 Press **SETUP** to remove the menu.

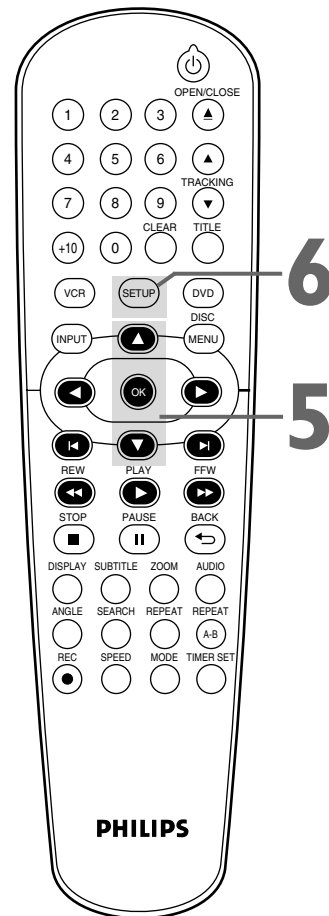

### Helpful Hint

- When MUSIC is selected, the playback speed of the SLIDE SHOW will be set to 5 seconds under the conditions listed below:
  - When DUAL PLAYBACK is OFF.
  - When DUAL PLAYBACK is ON, but only the JPEG files are playing.

## Glossary 57

**AUDIO IN/OUT Jacks:** jacks on the front and back of the DVD/VCR that receive audio from another source (IN) or send audio to another system (OUT). These jacks are red (right) and white (left).

**COAXIAL DIGITAL AUDIO OUT Jack:** sends digital audio to a Stereo, allowing you to adjust the volume at the Stereo. This connection provides the Multi-channel surround sound as heard in movie theaters. This jack on the DVD/VCR is black.

**COMPONENT VIDEO OUT (Y C<sub>B</sub>/P<sub>B</sub> C<sub>R</sub>/P<sub>R</sub>) Jacks:** jacks on the back of the DVD/VCR that send high-quality DVD video to a TV with Component Video In jacks. This connection provides the best picture quality for the DVD player of the DVD/VCR.

**Dolby Digital:** a surround sound system that provides Multi-channel sound as used in movie theaters.

**Dubbing:** copying a video cassette using another VCR.

**HQ:** high quality; a feature in the VCR circuitry which provides enhanced picture detail.

**External Input Channel:** the channel to which you set your DVD/VCR to receive the signal from the external tuner. If you connected the external tuner to the AUDIO and VIDEO In jacks on the front of the DVD/VCR, select L2. If you used the AUDIO and VIDEO IN jacks on the back of the DVD/VCR, select L1.

**OTR:** One-Touch Recording; a timed recording on the VCR that starts immediately and records for 30 minutes to 8 hours.

**S-Video:** produces a clearer DVD picture by sending separate signals for the luminance and the color. S-Video only provides a picture for the DVD player of the DVD/VCR.

**Tape Speeds:** how fast the video cassette travels during a recording or playback. The faster the tape speed, the better the picture quality. Slower tape speeds affect picture quality, but you can record more onto a videotape.

- **SP** (Standard Playback) – fastest tape speed (recording time for a T120 tape is approximately 2 hours); best picture quality.
- **LP** (Long Playback) – average tape speed. You cannot record in LP with this VCR. If tapes were recorded on a different VCR in LP speed, the tape will play in LP on the DVD/VCR.
- **SLP** (Super Long Playback) – slowest tape speed (recording time for a T120 tape is approximately 6 hours). This speed allows the maximum recording on a single videotape.

**VIDEO IN/OUT Jacks:** jacks on the front and back of the DVD/VCR that receive video from another source (IN) or send video to other video equipment or a TV (OUT). These jacks are yellow.

## 58 Helpful Hints

If you are having problems with your product, check this list of problems and possible solutions before requesting service. You may be able to solve the problem yourself.

If you need to call a customer service representative, please know the model number and serial number of your product before you call. This information is displayed on the back of the product. Also, please take a moment to identify the problem you are having, and be prepared to explain this to the representative. If you believe the representative will need to help you with operations, please stay near the product. Our representatives will be happy to assist you. For online reference, please visit our web site at <http://www.philips.com/welcome>

### The DVD/VCR has no power.

- Make sure the power cord is connected completely to an AC (alternating current) outlet.
- Press  $\odot$  to turn on the DVD/VCR. The DVD/VCR usually turns on in the mode it was in when you turned it off. If there has been a power failure, it will turn on in VCR mode. Press DVD to put the unit in DVD mode. Press VCR to put the unit in VCR mode. Or, press SOURCE to switch between the two modes.

### The remote control will not operate the DVD/VCR.

- Aim the remote control directly at the remote sensor on the front of the DVD/VCR, not toward the TV. *Details are on page 18.*
- Remove all obstacles between the remote control and the DVD/VCR.
- Inspect and/or replace the batteries in the remote control. *Details are on page 13.*
- Use the remote control within 23 feet (7m) of the DVD/VCR.
- When using the DVD player, press DVD, then try the other DVD feature buttons. Press DVD so DVD light appears on the front of the DVD/VCR. This means the DVD/VCR is in DVD mode.
- To use the VCR, press VCR, then try the other VCR feature buttons. Press VCR so VCR light appears on the front of the DVD/VCR. This means the DVD/VCR is in VCR mode.

### There is no picture in DVD mode.

- Make sure the video cable is connected correctly. You may connect either the yellow video cable (supplied), an optional S-Video cable, or optional component video cables. Make sure the TV is set to the correct Video In channel (usually the AUX IN, A/V IN, Auxiliary In, EXT or External In, Component Video In or S-Video In channel). Check your TV owner's manual for details. *Details are on page 8.*
- Insert a DVD that is playable on this DVD/VCR. *Details are on page 7.*
- Make sure the DVD/VCR is in DVD mode. Press DVD or SOURCE so DVD light appears on the front of the DVD/VCR.
- Check if Progressive Scan is set correctly according to your connection to a TV. *Details are on page 8.* Enable Progressive Scan at the DVD player only if you used the Component Video connection to a TV that has Progressive Scan. *Details are on pages 8, 10 and 51.*

### Disc cannot be played.

- Insert a playable disc. *Details are on page 7.*
- Place the disc correctly in the disc tray. If the disc is one-sided, place the disc in the tray with the label facing up. If the disc is two-sided, make sure the label of the side you want to play is facing up.
- Clean the disc. Make sure the disc is not scratched or warped.
- Cancel the Parental Controls, enter the password or change the control level. *Details are on pages 53-54.*
- Make sure the disc is labeled for use in Region 1 or ALL regions and is NTSC or PAL compatible. *Details are on page 7.*

### There is no sound.

- Connect the audio cable firmly. Make sure the cables are connected to the AUDIO IN jacks on the TV or Stereo. *Details are on pages 9-12.*
- Check the Audio Settings of the DVD player. *Details are on page 52.*
- Check the Audio Settings of the DVD. For example, you may have selected "soundtrack" playback or an unavailable Sound Setting (such as Dolby Digital). *Details are on pages 40 and 52.* Try other sound options provided in the DVD Disc Menu.

### The picture is distorted.

- Connect the DVD/VCR directly to the TV. *Details are on pages 8-12.* Do not connect the DVD/VCR to a VCR, then connect the VCR to the TV. Copyright protection systems in the VCR could distort the picture playing on the DVD/VCR.
- There are some cases where a disc or videotape picture may be distorted slightly because of the quality in which it was recorded. This is not a malfunction of the DVD/VCR.
- Make sure the disc is compatible with the DVD player of the DVD/VCR. *Details are on page 7.*
- In case of picture problems with 525 (480) progressive scan output, it is recommended that the user switch the connection to the 'standard definition' output. If there are questions regarding your TV set compatibility with this 525p (480p) DVD player, please contact our customer service center.
- If your TV is not PAL compatible, DVDs recorded in the PAL color system may play only in black and white, the picture may roll continuously, or the picture may appear distorted.

### You cannot change the camera angle of a DVD.

- The DVD might not contain segments recorded from different camera angles. See if multiple angles are available by referring to the disc case or DVD Disc Menu. *Details are on page 39.*

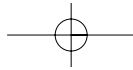

## Helpful Hints (cont'd) 59

### You cannot change the audio or subtitle language of a DVD.

- The DVD does not contain audio or subtitles in the desired language. Not all DVDs contain audio or subtitles in multiple languages. See if other languages are available by referring to the disc case or DVD Disc Menu. *Details are on pages 39-40.*

### An X appears in the top right corner of the TV screen when you try a DVD feature.

- The operation is not available at the current time or the feature is not available on the disc. Some features are only available during playback. Others can be accessed only if playback is stopped. Try stopping or playing the disc, then try the feature again.

### The DVD/VCR switches from DVD mode to VCR mode after 30 minutes of no activity.

- When AUTO POWER OFF is set to ON, the DVD/VCR switches itself from DVD mode to VCR mode if disc playback stops for more than 30 minutes and you press no buttons on the remote or the DVD/VCR. *Details are on pages 55-56.* This prevents possible damage to your TV's picture tube that can occur if a still image is left on too long.

### A screen saver appears on the TV screen during DVD mode.

- The screen saver appears when you leave the DVD/VCR in stop mode for about five minutes to protect the TV screen from burn-in.

### You want to use the DVD player during a VCR Timer Recording or while "⏏" appears on the display panel.

- Press to turn on the DVD/VCR. Press DVD to choose DVD mode, then continue with other DVD features as described in this manual.

### A maximum of 999 MP3/Windows Media™ Audio/JPEG files can be recognized.

#### Power Failure

- Clock and language setting will be lost after 30 seconds of power failure. See pages 19-20 to set up the clock and language again.

### The VCR will not record a TV program.

- This DVD/VCR does not have a tuner to receive TV broadcasting.
- You must connect this DVD/VCR to an external tuner to record TV programs.
- Check the connections between the DVD/VCR and the external tuner. *Details are on page 9.*
- Put the DVD/VCR in VCR mode. Press VCR or SOURCE so VCR light appears on the front of the DVD/VCR.
- Make sure the video cassette has a record tab. *Details are on page 21.*

### The VCR will not perform a Timer Recording.

- Make sure the recording start and stop times are set correctly. *Details are on pages 24-25.*
- Make sure a tape is in the VCR and the tape has a record tab. *Details are on page 21.* If, after programming a Timer Recording, you press TIMER SET without putting a tape in the DVD/VCR, "⏏" will blink on the display panel.
- If the record tab on a tape is missing, the DVD/VCR will eject the tape. "⏏" will blink.
- Press TIMER SET to put the DVD/VCR in standby mode for the Timer Recording.
- Make sure the VCR clock is set. *Details are on page 19.*
- The VCR may not perform or continue a Timer Recording if the power fails.
- Finish programming a Timer Recording at least 5 minutes before it is set to begin.
- 12 p.m. is noon; 12 a.m. is midnight.

### There is no picture or the picture is noisy or has streaks during video cassette playback.

- Put the DVD/VCR in VCR mode. Press VCR or SOURCE so VCR light appears on the front of the DVD/VCR.
- Select the correct Video In channel at the TV. *Details are on page 8.*
- Adjust the tracking. *Details are on page 31.*
- TVs placed too close to the DVD/VCR can cause interference during tape playback. Move the DVD/VCR away from the TV.

### TV programs cannot be watched normally.

- Check the connections between the DVD/VCR and the external tuner. *Details are on page 9.*

### You cannot insert a video cassette.

- Insert the tape, window side up, with the record tab facing you.
- Make sure that there is no tape on the VCR by pressing STOP/EJECT on the front of the DVD/VCR.
- Gently push on the center of the tape when putting it in the VCR. Never force the tape into the VCR.
- If a Timer Recording is set, you cannot insert a tape without a record tab.

### You cannot remove the tape.

- Make sure the power plug is completely connected to a power outlet.
- If a Timer Recording has been set, press TIMER SET on the remote control or STOP/EJECT on the front panel to cancel the timer standby mode temporarily. "⏏" will disappear from the display panel. Then, press STOP/EJECT on the front of the DVD/VCR to eject the tape. Insert another tape and press TIMER SET to reset the Timer Recording.
- Unplug the DVD/VCR power cord for 5 minutes. Then, plug in the power cord again and press on the DVD/VCR. Press STOP/EJECT on the DVD/VCR 3 to 5 times. If the tape still does not eject, you may need to have an authorized servicer remove the tape.

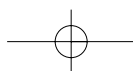

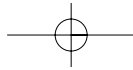

## 60 Helpful Hints (cont'd)

---

### **DVD/VCR ejects the tape when you press REC ● or TIMER SET.**

- Make sure the tape has a record tab. *Details are on page 21.*

### **Hi-Fi Stereo Sound**

- During playback, Hi-Fi audio may normally revert to normal audio when you adjust tracking.
- When connecting the DVD/VCR to a TV with the red and white audio cable, you will only get stereo sound if you connect the DVD/VCR AUDIO OUT jacks on the DVD/VCR to the AUDIO IN jacks on your TV, and if the TV is on its Audio/Video In channel. See your TV owner's manual for details.
- When you connect the DVD/VCR AUDIO OUT jacks on the DVD/VCR to the AUDIO IN jacks on your TV, the stereo light on the TV might not glow.
- Only tapes recorded in Hi-Fi audio will play in Hi-Fi audio. Tapes recorded in normal audio will play in monaural (single-channel) audio.

### **Cleaning the video heads**

- Your DVD/VCR automatically cleans the video heads of the VCR each time you insert a tape. However, the heads may become dirty. If so, have an authorized servicer clean the video heads. Eventually, the heads may need to be replaced.

### **The playback picture is too dim, too bright or fluctuates in brightness.**

- Some programs may be broadcast with copyright protection technology in order to protect the rights of copyright owners. This technology is used on programs that are recorded on video cassettes or DVDs, as well as some programs broadcast by antenna/cable/satellite television channels. Programs broadcast with copyright protection may not record clearly. Likewise, if you play a tape that is a recording of a copyright protected program, the picture may not be clear. Tapes of copyright protected programs may have a picture that is dark or dim, or the brightness of the picture may fluctuate. Therefore, avoid recording or playing copies of copyright protected programs.

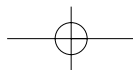
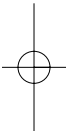

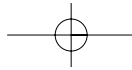

## Care and Maintenance 61

### Cleaning the DVD/VCR

- Wipe the front panel and other exterior surfaces of the DVD/VCR with a soft, slightly damp cloth.
- Never use a solvent, thinner, benzene or alcohol to clean the DVD/VCR. Do not spray insecticide liquid near the DVD/VCR. Such chemicals may discolor the surface or damage the DVD/VCR.

### Cleaning a Disc

- Use a soft, dry cloth to wipe the disc.
- Wipe the disc in a straight line from the center to the edge. Never wipe the disc in a circular motion.
- Do not use detergent or abrasive cleaning agents.
- Handle the discs so fingerprints and dust do not adhere to the discs.
- Always store the disc in its protective case when it is not in use.

### Checking the Laser

- If the DVD/VCR does not operate as described in this manual, the DVD player's laser may be dirty. Consult an Authorized Service Center for inspection and cleaning of the laser.

### Caring for Video Cassettes

- Use only cassettes with the **VHS** mark.
- Remove any light adhesive stick-on notes from the video cassette before putting the cassette in the VCR. Removable labels can jam the VCR.

### Caring for the VCR's Video Heads

- Periodic maintenance is required to maintain your DVD/VCR's excellent performance. The VCR has an Automatic Head Cleaner. However, the video heads will require replacement eventually. Only an authorized service center should perform this service.

## Specifications

### VCR Video Heads

4 heads - Hi-Fi

### DVD Color System

NTSC

### Frequency Response

DVD (linear sound):

20 Hz to 22 kHz (sample rate: 48 kHz)

20 Hz to 44 kHz (sample rate: 96 kHz)

Audio CD: 20 Hz to 20 kHz

### Signal-to-Noise Ratio

Audio CD: 100 dB JEITIA

(Japan Electronics and Information Technology Industries Association)

### Dynamic Range

DVD (linear sound): 90 dB

Audio CD: 85 dB (JEITIA)

### Total Distortion Factor

Audio CD: 0.03% (JEITIA)

DVD: 0.03%

### Wow and Flutter

Below the measurement limitation

(±0.001% W PEAK) (JEITIA)

### Power Requirement

120V AC +/- 10%, 60 Hz +/- 0.5%

### Power Consumption

Power on: 21 W

Power off: 3.8 W

### Operating Temperature

41°F (5°C) to 104°F (40°C)

### Relative Humidity

30% to 80%

### Dimensions

17.1" (W) x 3.7" (H) x 9.2" (D)

(435mm x 94mm x 233mm)

### Weight

5.8 lbs. (2.6 kg.)

*NOTE: Designs and specifications are subject to change without notice.*

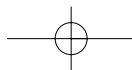
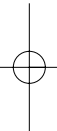
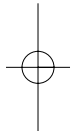



# 62 Limited Warranty

## 90 DAY LIMITED WARRANTY

### WARRANTY COVERAGE:

This warranty obligation is limited to the terms set forth below.

### WHO IS COVERED:

This product is warranted to the original purchaser or the person receiving the product as a gift against defects in materials and workmanship as based on the date of original purchase ("Warranty Period") from an Authorized Dealer. The original sales receipt showing the product name and the purchase date from an authorized retailer is considered such proof.

### WHAT IS COVERED:

This warranty covers new products if a defect in material or workmanship occurs and a valid claim is received within the Warranty Period. At its option, the company will either (1) repair the product at no charge, using new or refurbished replacement parts, or (2) exchange the product with a product that is new or which has been manufactured from new, or serviceable used parts and is at least functionally equivalent or most comparable to the original product in current inventory, or (3) refund the original purchase price of the product.

The Company warrants replacement products or parts provided under this warranty against defects in materials and workmanship from the date of the replacement or repair for ninety (90) days or for the remaining portion of the original product's warranty, whichever provides longer coverage for you. When a product or part is exchanged, any replacement item becomes your property and the replaced item becomes the company's property. When a refund is given, your product becomes the company's property. Note: Any product sold and identified as refurbished or renewed carries a ninety (90) day limited warranty.

Replacement product can only be sent if all warranty requirements are met. Failure to follow all requirements can result in delay.

### WHAT IS NOT COVERED - EXCLUSIONS AND LIMITATIONS:

This Limited Warranty applies only to the new products that can be identified by the trademark, trade name, or logo affixed to it. This Limited Warranty does not apply to any non-Philips hardware product or any software, even if packaged or sold with the product. Non-Philips manufacturers, suppliers, or publishers may provide a separate warranty for their own products packaged with the bundled product.

The Company is not liable for any damage to or loss of any programs, data, or other information stored on any media contained within the product, or any non-Philips product or part not covered by this warranty. Recovery or reinstallation of programs, data or other information is not covered under this Limited Warranty.

This warranty does not apply (a) to damage caused by accident, abuse, misuse, neglect, misapplication, or non-Philips product, (b) to damage caused by service performed by anyone other than an Authorized Service Location, (c) to product or

a part that has been modified without written permission, or (d) if any serial number has been removed or defaced, or (e) product, accessories or consumables sold "AS IS" without warranty of any kind by including refurbished Philips product sold "AS IS" by some retailers.

This Limited Warranty does not cover:

- Shipping charges to return defective product.
- Labor charges for installation or setup of the product, adjustment of customer controls on the product, and installation or repair of antenna/signal source systems outside of the product.
- Product repair and/or part replacement because of improper installation or maintenance, connections to improper voltage supply, power line surge, lightning damage, retained images or screen markings resulting from viewing fixed stationary content for extended periods, product cosmetic appearance items due to normal wear and tear, unauthorized repair or other cause not within the control of the company.
- Damage or claims for products not being available for use, or for lost data or lost software.
- Damage from mishandled shipments or transit accidents when returning product.
- A product that requires modification or adaptation to enable it to operate in any country other than the country for which it was designed, manufactured, approved and/or authorized, or repair of products damaged by these modifications.
- A product used for commercial or institutional purposes (including but not limited to rental purposes).
- Product lost in shipment and no signature verification receipt can be provided.
- Failure to operate per Owner's Manual.

### TO OBTAIN ASSISTANCE IN THE U.S.A., PUERTO RICO, OR U.S. VIRGIN ISLANDS...

Contact Philips Customer Care Center at:  
1-866-771-4018

### TO OBTAIN ASSISTANCE IN CANADA...

1-800-661-6162 (French Speaking)  
1-866-771-4018 (English or Spanish Speaking)

REPAIR OR REPLACEMENT AS PROVIDED UNDER THIS WARRANTY IS THE EXCLUSIVE REMEDY FOR THE CONSUMER. PHILIPS SHALL NOT BE LIABLE FOR ANY INCIDENTAL OR CONSEQUENTIAL DAMAGES FOR BREACH OF ANY EXPRESS OR IMPLIED WARRANTY ON THIS PRODUCT. EXCEPT TO THE EXTENT PROHIBITED BY APPLICABLE LAW, ANY IMPLIED WARRANTY OF MERCHANTABILITY OR FITNESS FOR A PARTICULAR PURPOSE ON THIS PRODUCT IS LIMITED IN DURATION TO THE DURATION OF THIS WARRANTY.

Some states do not allow the exclusions or limitation of incidental or consequential damages, or allow limitations on how long an implied warranty lasts, so the above limitations or exclusions may not apply to you.

This warranty gives you specific legal rights. You may have other rights which vary from state/province to state/province.

P&F USA, INC  
P.O.Box 672768 Marietta, Georgia 30006

# Information Index 63

- ac power cord ..... 18
- angle button ..... 18, 39
- angle icon ..... 39, 55-56
- arrow buttons ..... 18
- audio button ..... 18, 40
- audio in/out jacks ..... 9-12, 18, 23
- audio settings ..... 52
- auto power off ..... 55-56
- auto repeat ..... 29
- automatic
  - tape playback ..... 31
  - tape rewind, eject ..... 31
- a-b repeat ..... 37
- a-b repeat button ..... 18, 37
  
- back button ..... 18
- batteries ..... 13
- bit-rate display ..... 45
- black level ..... 47
  
- camera angle ..... 39
- cassette compartment ..... 17
- chapters ..... 34
- clear button ..... 18, 19
- clock ..... 22
- coaxial digital audio out jack ..... 12, 18
- component video out jacks ..... 10, 18
- connections ..... 8-12
- contents, table of ..... 5
- controls
  - dvd/vcr ..... 18
  - remote ..... 18
- copyright protection ..... 4, 23, 60
- counter ..... 20, 29
  
- disc menu button ..... 18, 32
- disc menus ..... 32, 48-49
- disc tray ..... 17
- display button ..... 18, 20, 45-46
- display messages ..... 17
- display panel ..... 17
- displays ..... 20, 45-46
- dolby digital ..... 52
- down sampling ..... 52
- drc (dynamic range control) ..... 52
- dual playback ..... 44
- duplication (dvd to videotape) ..... 28
- duplication (tape) ..... 23
- dvd button ..... 18
- dvd light ..... 17
  
- ejecting a tape ..... 15, 31, 60
  
- fast forward ..... 31, 33
- ffw ►► button ..... 18
- folder playback ..... 44
- front panel ..... 17
  
- glossary ..... 57
  
- head cleaner ..... 60
- helpful hints ..... 58-60
- hi-fi stereo sound ..... 32
- hookups
  - cable box/satellite receiver ..... 9
  - component video ..... 10
  - S-video ..... 10
  - stereo ..... 11-12
  - tv ..... 9-12
- index search ..... 30
- initializing ..... 47
- input button ..... 18, 21
  
- jpeg display ..... 46
- jpeg playback ..... 43-44
  
- language (dvd) ..... 48-49
- language (vcr) ..... 20
- line input mode ..... 24
- long playback ..... 57
- lp ..... 57
  
- markers ..... 38
- menus ..... 6, 32
- mode button ..... 18, 42
- mp3 display ..... 46
- mp3 playback ..... 43-44
  
- number buttons ..... 18
  
- ok button ..... 18
- on-screen status displays (vcr) ..... 20
- one-touch recording ..... 22
- open/close ▲ button ..... 16, 18
- osd language ..... 48-49
  
- parental ..... 53-54
- parental password ..... 53
- pause button ..... 18, 31, 36, 41
- play button ..... 15-16, 18
- playing discs ..... 16
- playing tapes ..... 15
- power
  - cord ..... 18
  - on light ..... 18
- program ..... 42
- progressive scan ..... 51
  
- quick setup ..... 48-52
  
- random ..... 42
- rapid play with voice ..... 33
- rear panel ..... 18
- rec ● button ..... 18, 21-22
- recording
  - basic ..... 21
  - prevention ..... 21
  - timer ..... 24-25
- remote control
  - batteries ..... 13
  - buttons ..... 18
  - sensor ..... 18
- repeat button ..... 18, 37
- repeat (discs) ..... 37
- repeat (tape) ..... 29
- rerecording ..... 23
- resume on ..... 36
- reverse searching ..... 31, 33
- rew ◀◀ button ..... 18, 31, 33
  
- safety precautions ..... 4
- satellite link ..... 26-27
- search button ..... 18, 30, 34-35
- searching ..... 31, 33
- sensor (remote) ..... 18
- setup button ..... 18
- skip ►I, skip I◀ ..... 18, 35
- slow motion ..... 31, 41
- slp ..... 57
- source button ..... 18
- sp ..... 57
- specifications ..... 61
- speed button ..... 18, 21
- standard playback ..... 57
- standby-on ☺ button ..... 18
- status display (vcr) ..... 20
- step-by-step playback ..... 36
- stereo sound ..... 40
- stereo TV hookups ..... 11-12
- still mode ..... 50-51
- still picture ..... 31, 36
- stop ■ button ..... 18
- stop/eject ■▲ (vcr) button ..... 18
- subtitle button ..... 18, 39
- super high speed searching ..... 31
- super long playback ..... 57
- s-video out jack ..... 10, 18
  
- table of contents ..... 5
- tape
  - duplication ..... 23
  - eject ..... 18, 31, 59
  - speed ..... 57
  - time search ..... 30
- timer recording
  - canceling ..... 25
  - setting ..... 24-25
- timer set button ..... 18, 25
- title button ..... 18, 32
- titles ..... 32
- tracking ..... 31
- tracks ..... 35
- tv aspect ..... 50-51
- tv hookups ..... 8-12
  
- vcr
  - button ..... 18
  - light ..... 17
  - video in/out jacks ..... 9-12, 18
  - virtual surround ..... 47
  
- warranty ..... 62
- Windows Media™ Audio display ..... 46
- Windows Media™ Audio playback ..... 43
  
- zoom ..... 41
- zoom button ..... 18, 41



This owner's manual is made of recyclable materials. Remember to recycle!

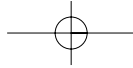

**P&F USA, Inc.**  
P.O. Box 672768 Marietta, Georgia 30006

Meet Philips at the Internet  
<http://www.philips.com/welcome>



DVP3345V



Printed In China  
JpnHF-0910/F7-3  
1VMN27293 ★★★★★  
E8E21UD

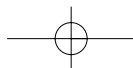

## Free Manuals Download Website

<http://myh66.com>

<http://usermanuals.us>

<http://www.somanuals.com>

<http://www.4manuals.cc>

<http://www.manual-lib.com>

<http://www.404manual.com>

<http://www.luxmanual.com>

<http://aubethermostatmanual.com>

Golf course search by state

<http://golfingnear.com>

Email search by domain

<http://emailbydomain.com>

Auto manuals search

<http://auto.somanuals.com>

TV manuals search

<http://tv.somanuals.com>