

**Digital Video Disc Player &
Video Cassette Recorder**

DVP620VR/17

Owner's Manual



THANK YOU FOR CHOOSING PHILIPS.

NEED HELP FAST?

READ YOUR QUICK-USE GUIDE AND/OR OWNER'S MANUAL FIRST FOR QUICK TIPS THAT MAKE USING YOUR PHILIPS PRODUCT MORE ENJOYABLE. IF YOU HAVE READ YOUR INSTRUCTIONS AND STILL NEED ASSISTANCE, YOU MAY ACCESS OUR ONLINE HELP AT WWW.P4C.PHILIPS.COM OR CALL 1-800-531-0039 WHILE WITH YOUR PRODUCT.

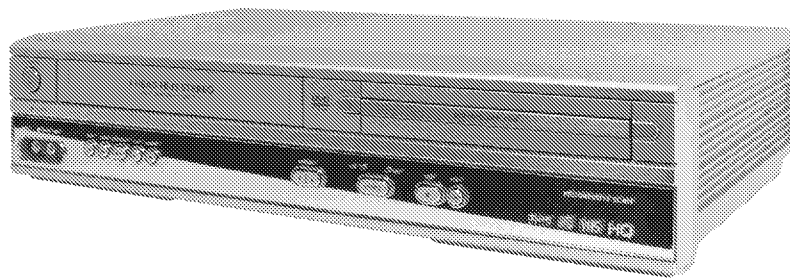

PHILIPS

Return your Product Registration Card today to get the very most from your purchase.

Registering your model with PHILIPS makes you eligible for all of the valuable benefits listed below, so don't miss out. Complete and return your Product Registration Card at once to ensure:

*Proof of Purchase

Returning the enclosed card guarantees that your date of purchase will be on file, so no additional paperwork will be required from you to obtain warranty service.

*Product Safety Notification

By registering your product, you'll receive notification - directly from the manufacturer - in the rare case of a product recall or safety defect.

*Additional Benefits of Product Ownership

Registering your product guarantees that you'll receive all of the privileges to which you're entitled, including special money-saving offers.

PHILIPS

Congratulations on your purchase, and welcome to the "family!"

Dear PHILIPS product owner:

Thank you for your confidence in PHILIPS. You've selected one of the best-built, best-backed products available today. We'll do everything in our power to keep you happy with your purchase for many years to come.

As a member of the PHILIPS "family," you're entitled to protection by one of the most comprehensive warranties and outstanding service networks in the industry. What's more, your purchase guarantees you'll receive all the information and special offers for which you qualify, plus easy access to accessories from our convenient home shopping network.

Most importantly, you can count on our uncompromising commitment to your total satisfaction.

All of this is our way of saying welcome - and thanks for investing in a PHILIPS product.

P.S. To get the most from your PHILIPS purchase, be sure to complete and return your Product Registration Card at once.

Know these safety symbols



This "bolt of lightning" indicates uninsulated material within your unit may cause an electrical shock. For the safety of everyone in your household, please do not remove product covering.

The "exclamation point" calls attention to features for which you should read the enclosed literature closely to prevent operating and maintenance problems.

WARNING: To reduce the risk of fire or electric shock, this apparatus should not be exposed to rain or moisture, and objects filled with liquids, such as vases, should not be placed on this apparatus.

CAUTION: To prevent electric shock, match wide blade of plug to wide slot, fully insert.

ATTENTION: Pour éviter les choc électriques, introduire la lame la plus large de la fiche dans la borne correspondante de la prise et pousser jusqu'au fond.

For Customer Use

Enter below the Serial No. which is located on the rear of the cabinet. Retain this information for future reference.

Model No. _____
Serial No. _____

PHILIPS

Visit our World Wide Web Site at <http://www.philips.com>

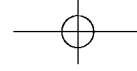

Safety and General Information 3

Safety Precautions

Warning: To prevent fire or shock hazard, do not expose this equipment to rain or moisture.

Federal Communications Commission (FCC) Warning: Any unauthorized changes or modifications to this equipment void the user's authority to operate it.

Department of Health and Human Services (DHHS) Certification: Complies with 21 Center for Radiation (CFR) chapter 1 subchapter J applicable at time of manufacture.

Laser Safety: This unit employs a laser. Only a qualified service person should remove the cover or attempt to service this device, due to possible eye injury.

CAUTION: USE OF CONTROLS OR ADJUSTMENTS OR PERFORMANCE OF PROCEDURES OTHER THAN THOSE SPECIFIED HEREIN MAY RESULT IN HAZARDOUS RADIATION EXPOSURE.

CAUTION: VISIBLE AND INVISIBLE LASER RADIATION WHEN OPEN AND INTERLOCK DEFEATED. DO NOT STARE INTO BEAM. THE BEAM IS LOCATED INSIDE, NEAR THE DECK MECHANISM.

Special Information for Canadian Users: This Class B digital apparatus complies with Canadian ICES-003. Cet appareil numérique de la classe B est conforme à la norme NMB-003 du Canada.

Radio/TV Interference: This equipment has been tested and found to comply with the limits for a Class B digital device, pursuant to Part 15 of the FCC Rules. These limits are designed to provide reasonable protection against harmful interference in a residential installation. This equipment generates, uses, and can radiate radio frequency energy and, if not installed and used in accordance with the instructions, may cause harmful interference to radio communications. However, there is no guarantee that interference will not occur in a particular installation. If this equipment does cause harmful interference to radio or television reception, which can be determined by turning the equipment off and on, the user is encouraged to try to correct the interference by one or more of the following measures:

- 1) Reorient or relocate the receiving antenna.
- 2) Increase the separation between the equipment and the receiver.
- 3) Connect the equipment into an outlet on a circuit different from that to which the receiver is connected.
- 4) Consult the dealer or an experienced radio/TV technician for help.

Copyright Protection: Unauthorized copying, broadcasting, public performance, and lending of Discs are prohibited. This product incorporates copyright protection technology that is protected by method claims of certain U.S. patents and other intellectual property rights owned by Macrovision Corporation and other rights owners. Use of this copyright protection technology must be authorized by Macrovision Corporation and is intended for home and other limited viewing uses only unless otherwise authorized by Macrovision Corporation. Reverse engineering or disassembly is prohibited.

Notice for Progressive Scan Use: Consumers should note that not all high definition television sets are fully compatible with this product and may cause artifacts to be displayed in the picture. In case of 525 progressive scan picture problems, it is recommended that the user switch the connection to the 'standard definition' output. If there are questions regarding your TV set compatibility with this model 525p DVD player, please contact our customer service center.

Note to the Cable TV System Installer: This reminder is provided to call the Cable TV system installer's attention to Article 820-40 of the National Electrical Code, which provides guidelines for proper grounding – in particular, specifying that the cable ground shall be connected to the grounding system of the building, as close to the point of cable entry as possible.

Declaration of Conformity

Model Number: DVP620VR/17
 Trade Name: Philips
 Responsible Party: Philips Consumer Electronics North America
 P.O. Box 14810
 Knoxville, TN 37914-1810
 (865) 521-4316

Manufactured under license from Dolby Laboratories. "Dolby" and the double-D symbol are trademarks of Dolby Laboratories.

Copyright 2004 Philips. All rights reserved.

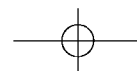

4 Table of Contents

General Information

Safety and General Information	3
Table of Contents	4
Introduction	5
Playable Discs and Video Cassettes	6

Initial DVD/VCR Setup

Hookups	7-15
Remote Control Setup	16
First-time DVD/VCR Setup	17

Basic Playback

Video Cassette Playback	18
Disc Playback	19

Basic DVD/VCR Controls

Display Panel (DVD)	20
Display Panel (VCR)	21
Front Panel	22
Rear Panel	23
Remote Control	24-25

Additional VCR Setup

Channel Setup	26-27
Clock (VCR)	28-29
Language (VCR)	30
VCR Status Displays	31

VCR Recording Options

Videotape Recording	32
Recording One Channel/Watching Another	33
One-Touch Recording	34
Rerecording (Tape Duplication)	35
Timer Recording	36-38
DVD to Videotape Duplication	39

Video Cassette Playing Options

Repeat Play	40
Tape Counter	41
Time Search, Index Search	42
Special Effects Playback	43
Automatic Operation Features	44

Additional VCR Features

Multi-Channel Television Sound	45-46
Hi-Fi Stereo	47

Disc Playback Features

DVD Disc Menus	48
Fast Forward/Reverse Search	49
Title/Chapter Playback, Specific Time Playback	50
Track Playback	51
Paused and Step-by-Step Playback, Resume On	52
Repeat, A-B Repeat	53
Markers	54
Subtitles, Camera Angles	55
Parental Controls Password	56
Parental Levels	57
Audio Language, Stereo Sound Mode	58
Slow Motion, Zoom	59
Programmed Playback	60
Random Playback	61
MP3/JPEG Playback	62
MP3/JPEG Displays	63

DVD Player Setup Options

Display	64-65
Language	66-67
Audio	68
On-Screen Displays	69
Black Level, Virtual Surround	70
Initializing	71

Information You May Need

Glossary	72
Specifications	73
Helpful Hints	74-77
Care and Maintenance	78
Limited Warranty	79
Information Index	80

Introduction 5

Welcome!

This DVD/VCR combines a Digital Video Disc (DVD) Player and a Hi-Fi Video Cassette Recorder (VCR) into one unit, letting you play DVDs, Audio Compact Discs (Audio CDs), and Video Cassettes on one piece of equipment.

Read this owner's manual carefully to learn how to use the features listed below.

VCR Features

- Automatic Head Cleaner
- Channel Setup
- English, French, and Spanish menus and displays
- Multi-Channel TV Sound
- 19 Micron head
- Recording: One-Touch and Timer
- Repeat Play
- Searching: Time, Index, Forward, and Reverse
- Slow Motion
- Still Picture
- Tape Counter
- Tracking Adjustment

Disc Features

- Audio Language choices*
- Bit Rate display
- Camera Angle*
- Dolby Digital Sound*
- DVD to Videotape Duplication
- Dynamic Range Control
- Fast/Paused/Slow/Step-by-Step Playback
- Markers
- Parental Controls*
- Program Playback
- Progressive Scan
- Random Playback
- Repeat, Repeat A-B
- Screen Saver
- Search (Title/Chapter, Time, Track)
- Subtitles*
- Virtual Surround
- Zoom

* If available on the DVD

Package Contents

The following items are provided with your new DVD/VCR.

- Remote Control and two AA batteries
- One black RF coaxial cable, 75 ohm
- One set of Audio (red and white tips) and Video (yellow tips) cables
- This Owner's Manual and Quick-Use Guide

DVD Disc Menus...

Some explanations in this manual describe DVD Disc menus. DVD manufacturers set the menus, which vary among DVDs. Not all DVDs have menus. If the DVD has a menu, access it by pressing DVD, then DISC/VCR/MENU on the remote control.

Details are on page 48.

DVD Player Setup Menu...

Some instructions explain how to use the DVD Player's Setup menu to set up features of the DVD Player or a DVD. Access the DVD Player menu by pressing SYSTEM/MENU on the remote control when playback is stopped. Even if a feature is set in the DVD Player's menu, it may not be available if the current DVD does not include that feature.

Available Disc Features...

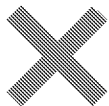

All features described in this manual are not available on every Disc. If the feature is not available on the Disc, you cannot use the DVD/VCR to make it available. An "X" will appear in the top right corner of the TV screen if you try to access a feature that is not currently available.

6 Playable Discs and Video Cassettes

Playable Discs

The DVD Player will play Digital Video Discs (DVDs); Audio Compact Discs (CDs); finalized Digital Video Discs Rewritable (DVD+RW); finalized Compact Discs Rewritable (CD-RW) and Compact Discs Recordable (CD-R); and Video Compact Discs (VCDs).

To play a DVD, make sure it meets the requirements for Region Codes and Color Systems as described below. Discs that have the following logos will play on the DVD Player. Other Disc types are not guaranteed to play in the DVD/VCR.

On a Super Audio CD, only the sound on the normal CD layer can be heard. The sound on the high-density Super Audio CD layer cannot be heard.



DVD



Audio CD



CD-RW/CD-R



Video CD



DVD+RW

Region Codes

This DVD/VCR has a Region One (1) DVD Player. DVDs must be labeled for ALL regions or for Region 1 in order to play on the DVD Player. You cannot play DVDs that are labeled for other regions. Look for the symbols below on your DVDs. If these region symbols do not appear on your DVD, you cannot play the DVD in this DVD Player.



The number inside the globe refers to a region of the world. Region 1 represents the United States, Canada, upper regions of North America, Bermuda, the U.S. Virgin Islands, and small regions near Australia.

A DVD labelled for a specific region can only play on DVD Players with the same region code.

Color Systems

DVDs are recorded in different color systems throughout the world. The most common color systems are NTSC (which is used primarily in the United States and North America), PAL, and SECAM.

This DVD Player will play both NTSC and PAL DVDs. You cannot play DVDs recorded in other formats. The color system of the DVD may be listed on the DVD or on the Disc case. Your TV must have the NTSC and/or PAL color system as well.

Playable Video Cassettes

The VCR of this DVD/VCR has a High Quality (HQ) system and is compatible with existing Video Home System (VHS) equipment. Use only video cassettes that have the **VHS** mark. The use of other tapes may result in poor picture quality and excessive deposits on the video heads, which may not be covered by the warranty if damage occurs.

The VCR also has a 19 micron head, which provides a better picture when you view tapes recorded in slow speed (SLP).

Hookups 7

Determining the best possible connection...

Your hookup will be determined primarily by your existing equipment, especially your TV. These guidelines describe which options have the best picture and sound quality. You will not use all the jacks on the DVD/VCR.

If your TV only has an RF-style jack, usually labelled Antenna In, RF In, or 75 ohm, use the ANT-OUT jack of the DVD/VCR to connect to the TV. This hookup provides both audio and video in a single cable. Set your TV to channel 3 or 4 - the output channel of the DVD/VCR. This connection allows you to use both the DVD and VCR features. See page eight.

- ★★★★ If your TV has Component Video In jacks (which could be labelled Y CR CB, Y PR PB, or YUV and may be green, blue, and red), use the Component Video jacks (Y Cb/Pb Cr/Pr) for the best picture quality. If you use only this video connection, only the DVD picture will be available. To see DVD features on the TV, set the TV to its Component Video In channel. Component Video provides the best picture quality. See page 12. Progressive Scan provides less flickering and higher image resolution than traditional (525i/480i or interlace) TV signals. If your TV has Progressive Scan (525p/480p or progressive), connect the TV to the DVD/VCR's COMPONENT VIDEO OUT (Y Cb/Pb Cr/Pr) jacks. Set PROGRESSIVE to ON in the DVD/VCR's DISPLAY menu. See pages 64-65. PSCAN will appear on the DVD/VCR's display panel. Set your TV to Progressive Scan also. If your TV does not have Progressive Scan but has Component Video In jacks, connect them to the DVD/VCR's COMPONENT VIDEO OUT jacks (Y Cb/Pb Cr/Pr). Set PROGRESSIVE to OFF either in the DISPLAY menu or by pressing and holding the PLAY ► (DVD) button on the front of the DVD/VCR for more than five seconds. See pages 12 and 64-65.
- ★★★ If your TV has an S-Video In jack (which also may be labelled Y/C or S-VHS), use the S-VIDEO OUT jack for excellent picture quality. If you use only this video connection, only the DVD picture will be available. To see DVD features on the TV, set the TV to its S-Video In channel. See page 13.
- ★★ If your TV has a single yellow Video In jack (which also may be labelled CVBS, Composite, or baseband), use the yellow DVD/VCR VIDEO OUT jack for good picture quality. This connection provides a picture for both the DVD Player and the VCR. To see DVD or VCR features on the TV, set the TV to its Video In channel. See page 11.
- ★★★★ If you have a Stereo with a Coaxial Digital Audio In jack, this provides the clearest sound for the DVD Player. Connect the DVD/VCR's COAXIAL DIGITAL AUDIO OUT jack to your Stereo for the best sound quality. If you use only this audio connection, only Disc sound (no VCR) will be available. See page 15.
- ★★★ If digital audio connections are not possible, connect the DVD/VCR's red and white DVD/VCR AUDIO OUT jacks to the Audio In jacks of your Stereo or TV. This connection provides sound for both the DVD Player and the VCR. See pages 11-14.

Before you begin...

- ☞ Refer to the manuals of your TV, Cable Box, Stereo, or other devices as necessary. Note the style of jacks and connectors on the other equipment. Determine how to choose different Audio and Video In channels on your other equipment so you can see and hear the DVD/VCR material playing on the TV, Stereo, etc.
- ☞ Disconnect all equipment from the power outlets. Connect the equipment to power only after you have finished hooking up everything. Never make or change connections with equipment connected to power.

Remember...

- ☞ Set the TV to the correct Video In channel. Such channels may be called AUX or AUXILIARY IN, AUDIO/VIDEO or A/V IN, EXT1 or External In, etc. These channels often are located near channel zero (0). Or, your TV's remote may have a button or switch that selects the Video Input channel. See your TV manual for details. If you do not see the DVD or VCR playback on the TV, go to the lowest TV channel (01 or 02) and change channels downward until you see the DVD or VCR picture on the TV. Or, if your TV has only a single Antenna In jack and you are using the RF coaxial cable (as described on page eight), set the TV to channel 3 or 4. To help you find the right Audio/Video In channel, turn on the DVD/VCR. Press DVD to put the DVD/VCR in DVD mode. With no Disc in the Player, a large DVD Video logo will appear on the TV screen when you get the TV on the correct Audio/Video In channel or channel 3 or 4.
- ☞ Set the Stereo to the correct channel or "source" mode.
- ☞ Depending on your connection, you may need to purchase additional cables or adaptors. If your TV or monitor has BNC-type connectors, you will need an adaptor.
- ☞ If you set Progressive Scan on or off when the power is on, the DVD/VCR will turn off. When you turn on the DVD Player again, the last selected scanning system will be active.
- ☞ **To use the VCR features, you must include a connection with the supplied yellow video cable and red/white audio cables or with the supplied RF coaxial cable.**

Once you determine the best option, find your choice on pages 8-15. Follow the steps for the hookup you choose. Then, go to page 17 to complete the first-time setup.

8 Hookups (cont'd)

DVD/VCR to TV only

Simplest connection using only the supplied black RF coaxial cable
This connection will let you use the features of both the VCR and the DVD Player.

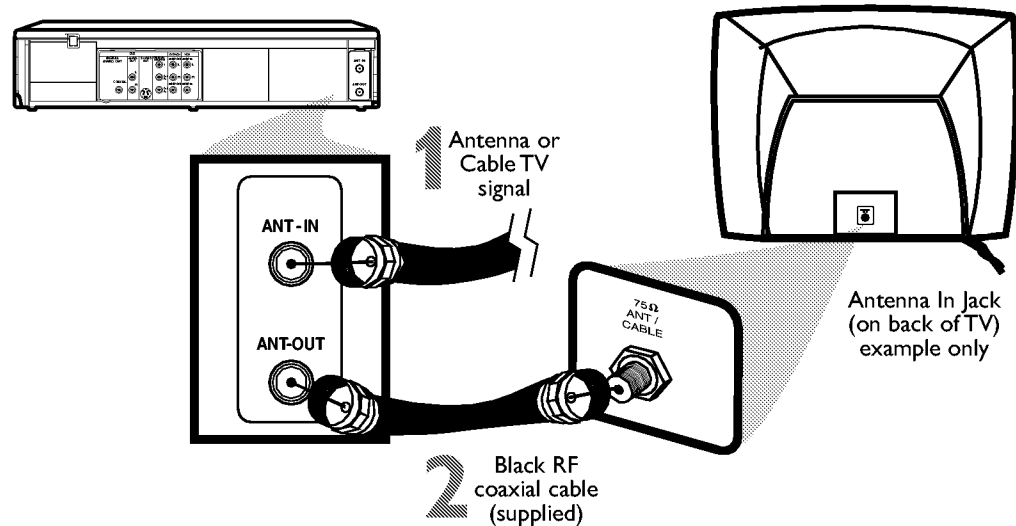

- 1 **Disconnect the antenna or Cable TV signal from your TV and connect it to the ANT-IN (Antenna In) jack of your DVD/VCR.**
- 2 **Connect the supplied black RF coaxial cable to the ANT-OUT (Antenna Out) jack on the back of the DVD/VCR and to the ANTENNA IN JACK on the TV.** The ANTENNA IN jack on the TV may be labelled TV IN, RF IN, 75Ω (ohm), or ANT-IN. See your TV owner's manual for assistance.
- 3 **Plug in the power cords of the TV and the DVD/VCR.**
- 4 **Set your TV to channel 3 or 4.** The DVD/VCR's output channel is 3 when you purchase it. So, set your TV to channel 3 when the DVD/VCR is new. If you cannot use channel 3 at your TV, you can change the DVD/VCR's output channel to channel 4. To do so, press the VCR button to put the DVD/VCR in VCR mode. The VCR light will be on the front of the DVD/VCR. Insert a videotape and press PLAY ► to start playback. **During playback, press and hold the (VCR) PLAY ► button on the front of the DVD/VCR for three to five seconds.** Each time you do this, the DVD/VCR's output channel switches between 3 and 4, and the selected channel number appears on the display panel. Change your TV to channel 3 or 4 accordingly. (You cannot change the DVD/VCR's output channel while adjusting tracking manually. Press STOP ■ to stop play and cancel manual tracking, then press PLAY ► to resume playing and change the output channel.) There is not a channel 3/4 switch on the DVD/VCR (as customary with most VCRs).
- 5 **You are ready to turn on the DVD/VCR. Go to page 17 before turning on the DVD/VCR.**

Hookups (cont'd) 9

DVD/VCR to Cable Box or Satellite Receiver and TV

Using only basic RF coaxial cables

This connection will let you use the features of both the VCR and the DVD Player.

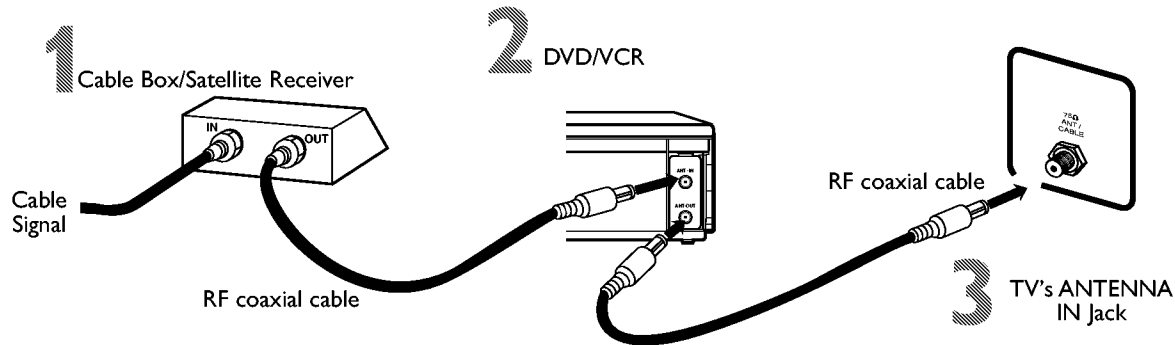

Connections

- 1** Connect a **Cable TV or Satellite** signal to the **IN** jack on the **Cable Box/Satellite Receiver**.
- 2** Use an **RF coaxial cable** (as the one supplied) to connect the **OUT** jack on the **Cable Box/Satellite Receiver** to the **ANT-IN (Antenna In)** jack on the **DVD/VCR**.
- 3** Use a second **RF coaxial cable** to connect the **ANT-OUT (Antenna Out)** jack on the **DVD/VCR** to the **TV's Antenna In** jack.

Remember...

There are two ways to connect your Cable Box/Satellite Receiver to the DVD/VCR. With the connection on this page:

- Select TV channels at the Cable Box/Satellite Receiver, not the DVD/VCR. To record or view TV channels, follow these steps:
 - 1) Press **VCR** to put the DVD/VCR in VCR mode. The VCR light will appear on the front of the DVD/VCR.
 - 2) Press **SKIP▶|/CH▲** or **SKIP◀|/CH▼** to set the DVD/VCR to the Cable Box/Satellite Receiver output channel (03 or 04).
 - 3) Set the TV to the DVD/VCR's output channel (03 or 04). The DVD/VCR's output channel is channel 3 when the DVD/VCR is new. To change it from 3 to 4, press and hold the **(VCR) PLAY▶** button on the DVD/VCR for 3-5 seconds during tape playback. For more details, see step 4 on page 8.
 - 4) Select the channel you want to view/record at the Cable Box/Satellite Receiver.
- You may not view a channel other than the one you are recording.
- You can only program a timer recording for one channel at a time. Set your Cable Box/Satellite Receiver to the channel you want to record. When you enter the channel you want to record in a timer recording, select channel 03 or 04 (the Cable Box/Satellite Receiver output channel). (This is step 8 on page 37.) Leave the Cable Box/Satellite Receiver on for a timer recording.

Helpful Hint

- If your Cable Box or Satellite Receiver has Audio and Video Out jacks, use audio and video cables to connect them to the VCR AUDIO IN and VIDEO IN jacks on the rear of the DVD/VCR. You will not need the RF coaxial cable connection between the Cable Box/Satellite Receiver and the DVD/VCR as described at step 2.

10 Hookups (cont'd)

DVD/VCR to Cable Box or Satellite Receiver and TV

Using only basic RF coaxial cables

This connection will let you use the features of both the VCR and the DVD Player.

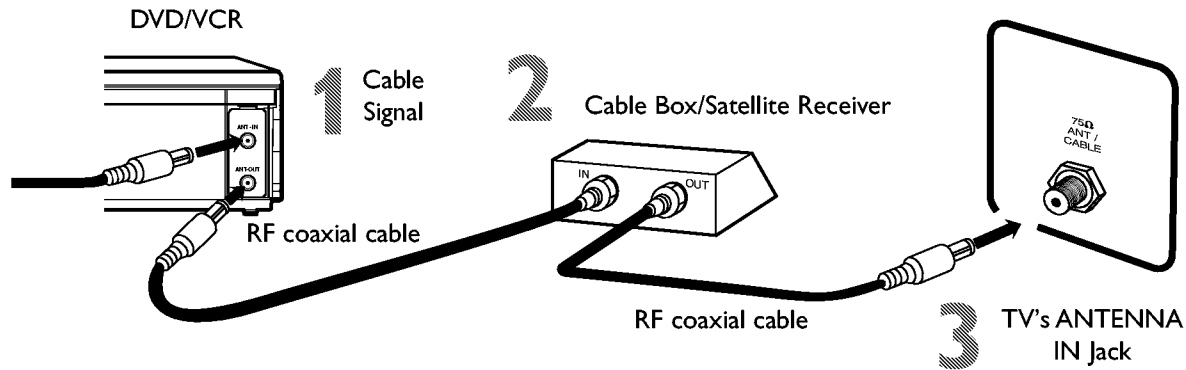

Connections

- 1 Connect a Cable TV or Satellite signal to the DVD/VCR's ANT-IN (Antenna In) jack.
- 2 Use an RF coaxial cable (as the one supplied) to connect the ANT-OUT (Antenna Out) jack on the DVD/VCR to the IN jack on the Cable Box/Satellite Receiver.
- 3 Use a second RF coaxial cable to connect the OUT jack on the Cable Box/Satellite Receiver to the ANTENNA IN jack on the TV.

Remember...

There are two ways to connect your Cable Box/Satellite Receiver to the DVD/VCR. With the connection on this page:

- You may watch one channel while recording another. Follow these steps:
 - 1) Put the Cable Box/Satellite Receiver on the same channel as the DVD/VCR's output channel (03 or 04). The DVD/VCR's output channel is channel 3 when the DVD/VCR is new. To alternate it between 3 and 4, press and hold the (VCR) PLAY ► button on the front of the DVD/VCR for 3-5 seconds during tape playback. For details, see step 4 on page eight. Set the TV to the Cable Box/Satellite Receiver output channel (03 or 04).
 - 2) Press VCR to put the DVD/VCR in VCR mode. The VCR light will appear on the front of the DVD/VCR.
 - 3) Press VCR/TV on the remote to choose VCR position.
 - 4) Press SKIP►/CH ▲ or SKIP◄/CH ▼ to select the channel you want to record at the DVD/VCR. Press RECORD ● to start the recording.
 - 5) Press VCR/TV on the remote once to put the DVD/VCR in TV position.
 - 6) Select the channel you want to watch at the Cable Box/Satellite Receiver.
- When you play a tape or Disc, make sure the Cable Box/Satellite Receiver is set to the DVD/VCR's output channel (03 or 04). Set the TV to the Cable Box/Satellite Receiver output channel (03 or 04).

Hookups (cont'd) 11

DVD/VCR to a TV that has Audio and Video In jacks

Using the supplied red, white, and yellow cables

This connection will let you use the features of both the VCR and the DVD Player.

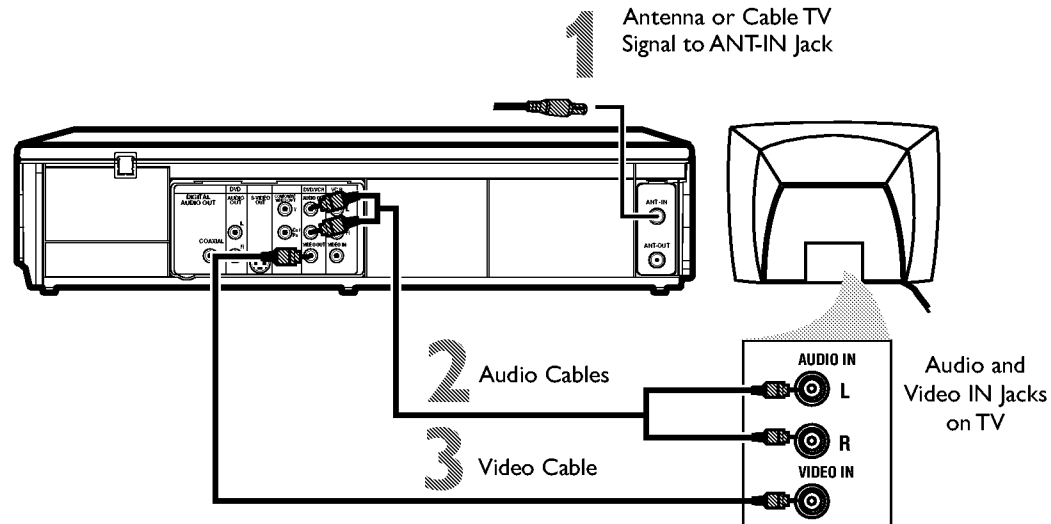

- 1 **Connect the antenna or Cable TV signal to the ANT-IN (Antenna In) jack of your DVD/VCR.**
- 2 **Connect the red and white audio cables (supplied) to the red and white DVD/VCR AUDIO OUT jacks on the DVD/VCR and to the red and white AUDIO IN jacks on the TV.** Match the cable colors to the jack colors. If the TV has a single AUDIO IN jack, use the white audio cable to connect the DVD/VCR's white DVD/VCR AUDIO OUT (left) jack to the TV's AUDIO IN jack. You will not use the red cable. Or, purchase a "splitter" audio cable to go from the left/right AUDIO OUT jacks of the DVD/VCR to the TV's single AUDIO IN jack.
- 3 **Connect the yellow video cable (supplied) to the DVD/VCR VIDEO OUT jack on the DVD/VCR and to the VIDEO IN jack on the TV.** The VIDEO IN jack on the TV is usually yellow and may be labelled CVBS, Composite, or Baseband video.
- 4 **Connect the power cords of the TV and the DVD/VCR to a power outlet. Turn on the TV and set it to the correct Audio/Video In channel.** Go to your lowest TV channel (01 or 02), then change channels downward until you see VCR or DVD playback on the TV screen. To help you find the right Audio/Video In channel, turn on the DVD/VCR. Press DVD to put the DVD/VCR in DVD mode. With no Disc in the Player, a large DVD Video logo will appear on the TV screen when you get the TV on the correct Audio/Video In channel. Make sure PROGRESSIVE is OFF and PSCAN does not appear on the DVD/VCR's display panel. Disable Progressive Scan either in the DISPLAY menu or by pressing and holding PLAY ► (DVD) on the front of the DVD/VCR for more than five seconds. *Details are on pages seven and 64-65.*
- 5 **You are ready to turn on the DVD/VCR. Go to page 17 to complete the first-time setup.**

12 Hookups (cont'd)

DVD/VCR to a TV that has Component Video In jacks

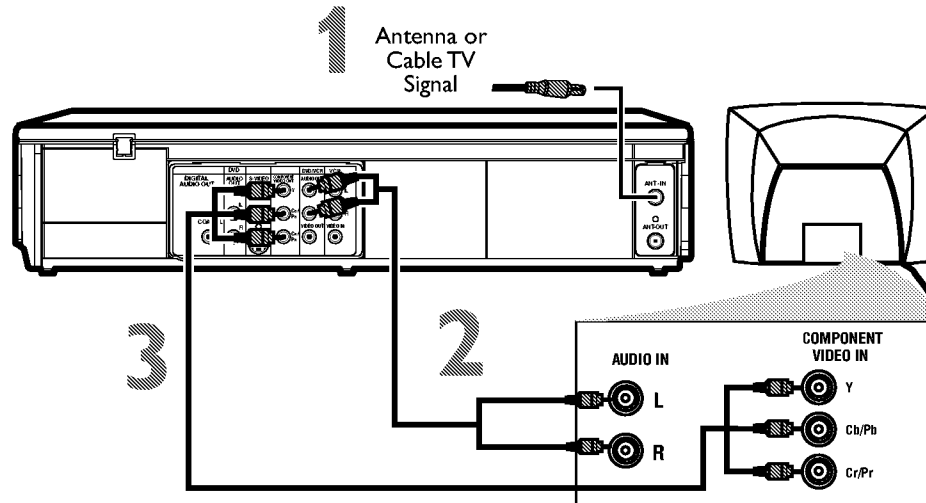

1 Connect the antenna or Cable TV signal to the **ANT-IN (Antenna In)** jack of your DVD/VCR.

2 Connect the supplied red and white audio cables to the red and white **DVD/VCR AUDIO OUT** jacks on the DVD/VCR and to the red and white **AUDIO IN** jacks on the TV. Match the cable colors to the jack colors.

3 Connect component video cable (not supplied) to the **COMPONENT VIDEO OUT** jacks on the DVD/VCR and to the **COMPONENT VIDEO IN** jacks on the TV. The Component Video In jacks on the TV are usually red, blue, and green.

The Component Video connection only supplies video (picture) for the DVD Player of the DVD/VCR. Therefore, in order to use the VCR features or view TV channels at the DVD/VCR, you still need to either connect the RF coaxial cable between the ANT-OUT jack of the DVD/VCR and the TV's Antenna In jack, or connect the yellow video cable. To connect the supplied RF coaxial cable, see step 2 on page eight. To connect the supplied yellow video cable, see step 3 on page 11.

If your TV is compatible with Progressive Scan (525p/480p), set PROGRESSIVE to ON in the DISPLAY menu so P. SCAN appears on the display panel. Details are on pages 64-65.

If your TV is not compatible with Progressive Scan, disable Progressive Scan either in the DISPLAY menu or by pressing and holding PLAY ► (DVD) on the front of the DVD/VCR for more than five seconds so P. SCAN does not appear on the display panel. Details are on pages 64-65.

4 Connect the power cords of the DVD/VCR and TV to a power outlet. Turn on the TV and set it to the Component Video In channel for DVD Player features.

If you are using the RF coaxial cable for VCR playback, choose channel 3 or 4 at the TV. If you are using the yellow video cable for VCR playback, choose the Video In channel at your TV.

Go to your lowest TV channel and change channels down until you see VCR or DVD playback on the TV screen, or try channel 3 or 4 at the TV.

To help you find the right Audio/Video In channel, turn on the DVD/VCR. Press DVD to put the DVD/VCR in DVD mode. With no Disc in the Player, a large DVD Video logo will appear on the TV screen when you get the TV on the correct Component Video In channel.

5 You are ready to turn on the DVD/VCR. Go to page 17 before turning on the DVD/VCR.

Hookups (cont'd) 13

DVD/VCR to a TV that has an S-Video In jack

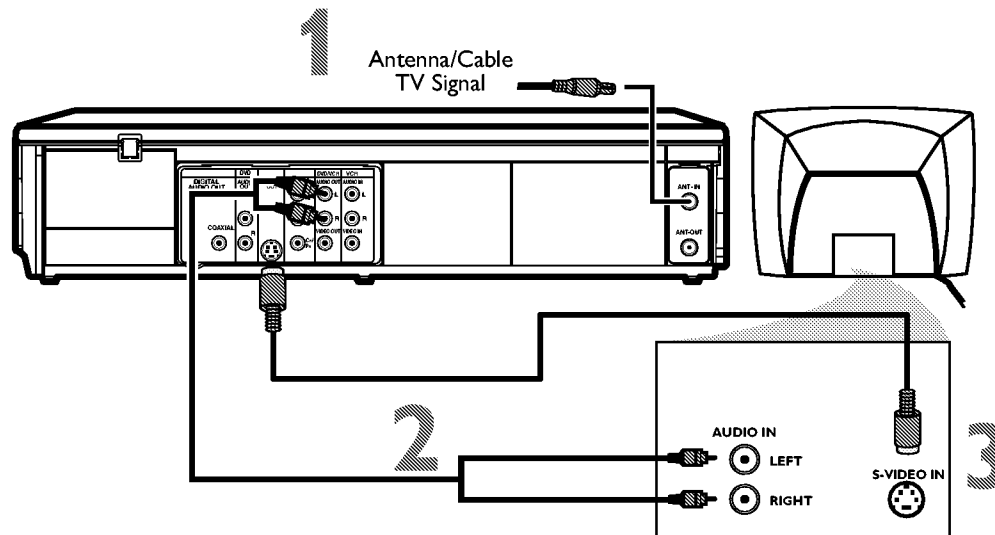

- 1** Connect the antenna or Cable TV signal to the **ANT-IN (Antenna In)** jack of your DVD/VCR.
- 2** Connect the supplied red and white audio cables to the red and white DVD/VCR **AUDIO OUT** jacks on the DVD/VCR and to the red and white **AUDIO IN** jacks on the TV. Match the cable colors to the jack colors.
- 3** Connect an **S-Video** cable (not supplied) to the **S-VIDEO OUT** jack on the DVD/VCR and to the **S-VIDEO IN** jack on the TV.
The S-Video connection only supplies video (picture) for the DVD Player of the DVD/VCR. Therefore, in order to use the VCR features or view TV channels at the DVD/VCR, you still need to either connect the RF coaxial cable between the ANT-OUT jack of the DVD/VCR and the TV's Antenna In jack, or connect the yellow video cable. To connect the supplied RF coaxial cable, see step 2 on page eight. To connect the supplied yellow video cable, see step 3 on page 11.
- 4** Connect the power cords of the DVD/VCR and TV to a power outlet. Turn on the TV and set it to the **S-Video In** channel for DVD Player features.
 If you are using the RF coaxial cable for VCR playback, choose channel 3 or 4 at the TV. If you are using the yellow video cable for VCR playback, choose the Video In channel at your TV. To find the correct Video In channel, go to your lowest TV channel and change channels downward until you see VCR playback on the TV screen.
 To help you find the right S-Video In channel, turn on the DVD/VCR. Press DVD to put the DVD/VCR in DVD mode. With no Disc in the Player, a large DVD Video logo will appear on the TV screen when you get the TV on the S-Video In channel. Make sure PROGRESSIVE is OFF and P.SCAN does not appear on the DVD/VCR display panel. Disable Progressive Scan either in the DISPLAY menu or by pressing and holding PLAY ► (DVD) on the front of the DVD/VCR for more than five seconds so P.SCAN does not appear on the display panel. *Details are on pages 64-65.*
- 5** You are ready to turn on the DVD/VCR. Go to page 17 before turning on the DVD/VCR.

14 Hookups (cont'd)

DVD/VCR to a TV and a Stereo

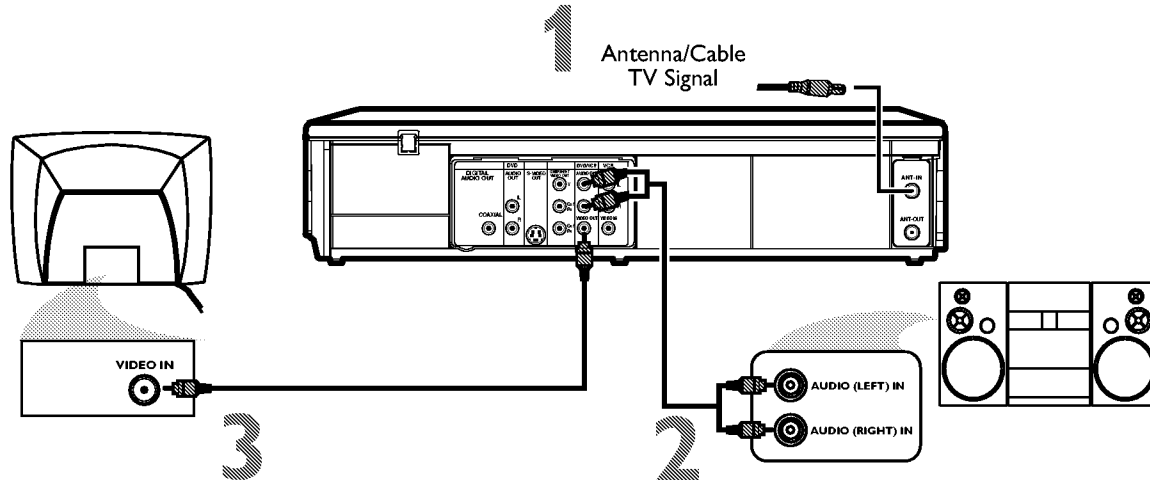

- 1** Connect the antenna or Cable TV signal to the **ANT-IN (Antenna In)** jack of your DVD/VCR.
- 2** Connect the supplied red and white audio cables to the red and white **DVD/VCR AUDIO OUT** jacks on the DVD/VCR and to the red and white **AUDIO IN** jacks on the Stereo. Match the cable colors to the jack colors.
- 3** Connect the supplied yellow video cable to the **DVD/VCR VIDEO OUT** jack on the DVD/VCR and to the **VIDEO IN** jack on the TV. To use Component Video cable or S-Video cable instead for the DVD Player, see pages 12-13. You will still need the yellow video cable or RF coaxial cable for VCR features.
- 4** Connect the power cords of the DVD/VCR, TV, and Stereo to a power outlet. Turn on the TV and set it to the Video In channel. Or, simply go to your TV's lowest channel (02 or 03) and continue changing channels downward at the TV until you see VCR or DVD playback on the TV screen. To help you find the right Video In channel at the TV, turn on the DVD/VCR. Press DVD to put the DVD/VCR in DVD mode. With no Disc in the Player, a large DVD Video logo will appear on the TV screen when you get the TV on the correct Video In channel. Turn on the Stereo and set it to the correct Auxiliary or Source mode. Check your Stereo manual for details.
- 5** You are ready to turn on the DVD/VCR. Go to page 17 before turning on the DVD/VCR.

Hookups (cont'd) 15

DVD/VCR to a TV and to Stereo that is Dolby Digital-compatible Using Digital Audio connections

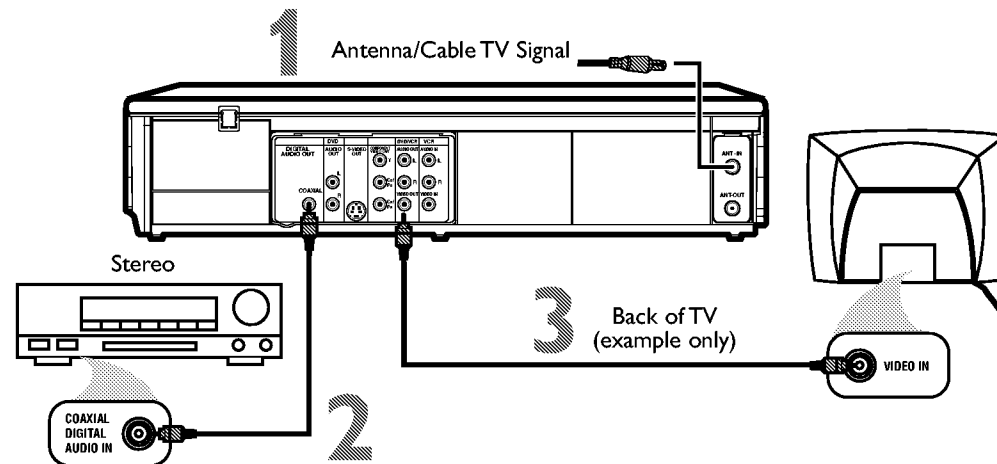

1 Connect the antenna or Cable TV signal to the **ANT-IN (Antenna In)** jack of your DVD/VCR.

2 Connect a coaxial digital audio cable (not supplied) to the DVD/VCR's **COAXIAL DIGITAL AUDIO OUT** jack and to the **COAXIAL DIGITAL AUDIO IN** jack on the Stereo.

This digital audio connection only provides sound for the DVD Player of the DVD/VCR. So, in order to use the VCR features or hear TV channels at the DVD/VCR, you still need to either connect the RF coaxial cable between the ANT-OUT jack of the DVD/VCR and the TV's Antenna In jack, or connect the supplied red/white audio cables. To connect the supplied RF coaxial cable, see step 2 on page eight. To connect the red/white audio cables, see step 2 on page 11.

3 Connect the supplied yellow video cable to the yellow **DVD/VCR VIDEO OUT** jack on the DVD/VCR and to the **VIDEO IN** jack on the TV. To use component video cable or S-Video cable instead for the DVD Player, see pages 12-13. You will still need the yellow video cable or RF coaxial cable for VCR features.

4 Plug in the power cords of the Stereo, TV, and DVD/VCR. Turn on the Stereo and select its **Auxiliary IN** channel. Turn on the TV and set it to the correct **Video In** channel. Go to your TV's lowest channel (01 or 02) and change channels downward until you see DVD or VCR material on the TV screen. To help you find the right Video In channel on the TV, turn on the DVD/VCR. Press DVD to put the DVD/VCR in DVD mode. With no Disc in the Player, a large DVD Video logo will appear on the TV screen when you get the TV on the correct Video In channel.

Make sure PROGRESSIVE is OFF and P.SCAN does not appear on the DVD/VCR's display panel. Disable Progressive Scan either in the DISPLAY menu or by pressing and holding PLAY ► (DVD) on the front of the DVD/VCR for more than five seconds. Details are on pages seven and 64-65.

5 You are ready to turn on the DVD/VCR. Go to page 17 before turning on the DVD/VCR.

Remember...

Some DVDs are recorded in Dolby Digital 5.1 channel Surround Sound. Select Dolby Digital 5.1 channel Surround Sound in the DVD Disc menu. If Dolby Digital Surround Sound is not recorded on the Disc, you will not have surround sound available.

If you connect the DVD/VCR to a Dolby Digital Stereo, set DOLBY DIGITAL to ON in the DVD Player's Setup menu. Details are on page 68. If the DVD/VCR is not connected to a Dolby Digital-compatible Stereo, set DOLBY DIGITAL to OFF. Incorrect settings may cause noise distortion and damage the speakers.

16 Remote Control Setup

Putting Batteries in the Remote Control

- 1 Remove the battery compartment lid on the bottom of the remote control by pressing the tab, then lifting the lid.
- 2 Place two AA batteries inside the battery compartment with their + and – ends aligned as indicated.
- 3 Replace the battery compartment lid.

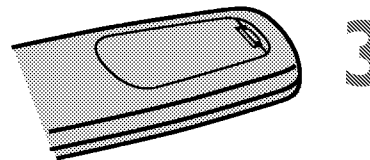
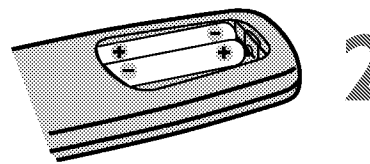
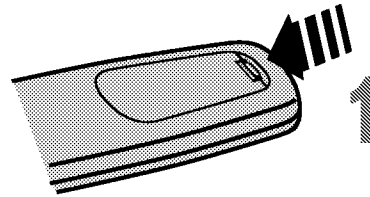

Using the Remote Control

- Point the remote control at the DVD/VCR's remote sensor (see page 22) when using the remote to operate the DVD/VCR. Do not point the remote at the TV.
- Do not put objects between the remote and the DVD/VCR.

Recycling Guidelines/Battery Safety

- Your new product and its packaging contain materials that can be recycled and reused. Specialized companies can recycle your product to increase the amount that needs to be properly disposed. Your product uses batteries that should not be thrown away when depleted but should be disposed of as small chemical waste. Please find out about the local regulations on disposal of your old product, batteries, and packaging whenever you replace existing equipment.
- Battery Usage CAUTION - To prevent battery leakage that may result in bodily injury, property damage, or damage to the unit: Install ALL batteries correctly, with the + and - markings on the battery aligned as indicated on the unit; Do not mix batteries, for example, old with new or carbon with alkaline; and Remove batteries when the unit will not be used for a long time.

First-time DVD/VCR Setup 17

Before turning on your DVD/VCR, make sure batteries are in the remote control and the DVD/VCR and TV are connected correctly. You cannot program channels if you are using a Cable Box or a Satellite Receiver.



These menus may not appear if you have already turned on the DVD/VCR.

1 Turn on the TV. Set it to channel 3 or 4 or its AUDIO/VIDEO IN channel, depending on how you connected the DVD/VCR to a TV.



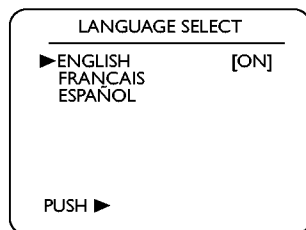

2 Press VCR, then press STANDBY-ON . The VCR light will appear on the front of the DVD/VCR. The display shown below will appear.

These menus may not appear if you have already turned on the DVD/VCR. You may have turned on the DVD/VCR before to find the Audio/Video In channel of the TV, for example. If so, follow the steps on page 26 to set up channels and page 30 to select a language for the VCR menus.

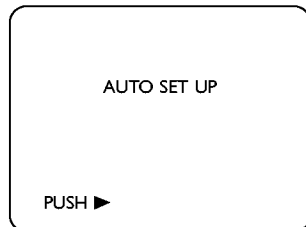

3 Press  or  to select English, French, or Spanish as the language for VCR on-screen displays and menus. Then, press .



4 Press  to begin channel programming. AUTO SETUP will flash on the TV screen during the channel search. The DVD/VCR will memorize all available channels. When channel programming is complete, the lowest available channel will appear on the TV. These channels will be available when you want to watch TV while in VCR mode. To put the DVD/VCR in VCR mode, press VCR so the VCR light appears. Use the SKIP /CH  and SKIP /CH  buttons to select memorized channels. To select non-memorized channels, use the Number buttons.

1 Turn on the TV.

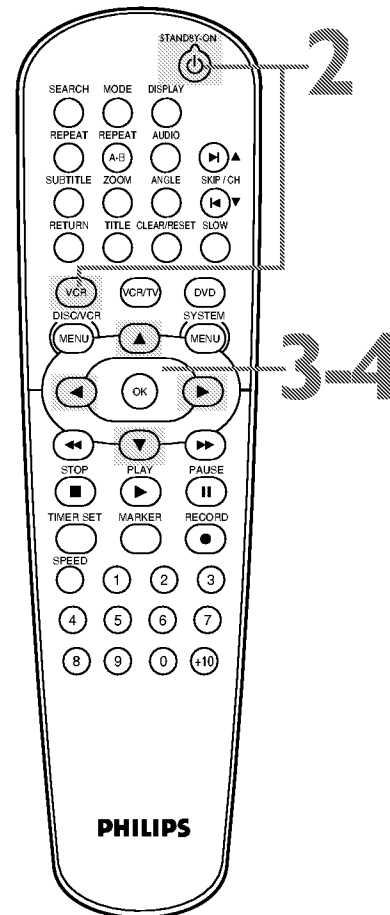

Helpful Hints

- To skip this feature and play a tape immediately, insert a tape with its record tab removed.
- To skip step 3, press DISC/VCR/MENU. VCR menus and displays will be in English.
- If you try to program channels when there is no antenna or Cable TV signal connected to the ANT-IN jack of the DVD/VCR, programming will stop. AUTO SET UP will stop flashing. Connect an antenna or Cable TV signal to the DVD/VCR's ANT-IN jack and press  again.
- Repeat this process if the power fails.
- To stop the Channel Setup while AUTO SET UP is flashing, press DISC/VCR/MENU.

18 Video Cassette Playback

Read and follow the steps below to play a tape.

- 1 **Turn on the TV. Set it to channel 3 or 4 or its AUDIO/VIDEO IN channel.** This depends on how you connected the DVD/VCR to a TV. Details are on pages 7-15.
- 2 **With the DVD/VCR power off, insert a tape in the cassette compartment of the DVD/VCR.** The VCR light will appear on the front of the DVD/VCR. If the tape's record tab has been removed, play will start automatically. If the DVD/VCR power is already on, press VCR to put the DVD/VCR in VCR mode if necessary. The VCR light will appear on the front of the DVD/VCR.
- 3 **If playback does not start automatically, press VCR, then press PLAY ►.**
- 4 **Press STOP ■ to stop playback.**
- 5 **Press ◀◀ to rewind the tape.**
- 6 **After the tape stops, press STOP/EJECT ■▲ on the front of the DVD/VCR to remove the tape.**

- 1 Turn on the TV.
- 2 Insert a tape in the DVD/VCR.

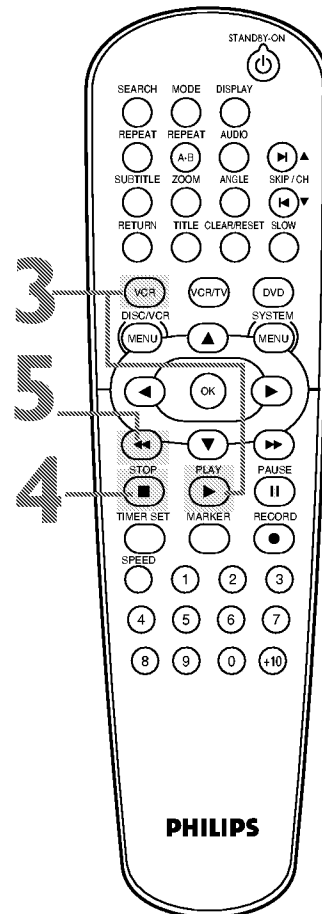







- 6 Press STOP/EJECT ■▲ on the DVD/VCR.

Helpful Hints

- Other tape playback features are on pages 40-47.
- If AUTO REPEAT is ON, playback will begin when you insert a tape, even when the record tab is intact. Details are on page 40.
- You must connect the DVD/VCR to a TV using the RF coaxial cable or the audio/video cables in order to use the VCR features. These hookups are explained on pages eight and 11.

Disc Playback 19

Before you begin, turn on the TV, Stereo, and other equipment connected to the DVD/VCR. Make sure the TV and the Stereo (if applicable) are set to the correct channel.
Details are on pages 7-15.

- 1** Press **STANDBY-ON**  to turn on the DVD/VCR.
- 2** Press **DVD** so the DVD light appears on the front of the DVD/VCR.
- 3** Press **OPEN/CLOSE**  (to the left of the disc tray on the front of the DVD/VCR) to open the Disc tray.
- 4** Place a Disc into the tray. If the DVD is recorded on only one side, place the Disc in the tray with the label facing up and the shiny side facing down. Some DVDs are recorded on both sides. Make sure the label of the side you want to play is facing up.
- 5** Press **PLAY** . The tray will close and play will begin at the first Chapter or Track. If a DVD menu appears instead, see page 48. With some Audio CDs, playback will not begin unless you press **PLAY** .
Or, press **OPEN/CLOSE**  or press the tray toward the DVD/VCR to close the tray.
With MP3 and JPEG files, playback will begin from the beginning of the disc.
- 6** Press **STOP**  to stop playback.

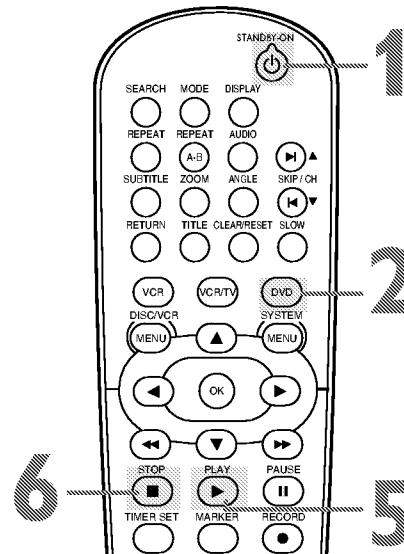

- 3** Press **OPEN/CLOSE**  on the DVD/VCR.
- 4** Insert a Disc.

Helpful Hints

- An "X" may appear at the top right corner of the TV screen when you try a feature. Either the feature is not available on the Disc, or the DVD/VCR cannot access the feature at this time. This does not indicate a problem with the DVD/VCR.
- If a Disc is dirty or scratched, the picture may appear distorted or playback may stop. Remove the Disc and turn off the DVD/VCR. Disconnect the power cord, then reconnect it. Clean the Disc, then turn on the DVD/VCR again and reinsert the Disc for playback.
- When the DVD or CD light appears on the display panel, the Disc is loaded and ready for playback.
- When you press **OPEN/CLOSE**  or **PLAY** (DVD) on the front of the DVD/VCR when the power is off, the DVD/VCR will turn on in DVD mode. Otherwise, the DVD/VCR will turn on in the mode in which it was turned off.

Remember, this DVD/VCR will play only certain Discs. See page six for details.

20 Display Panel (DVD)

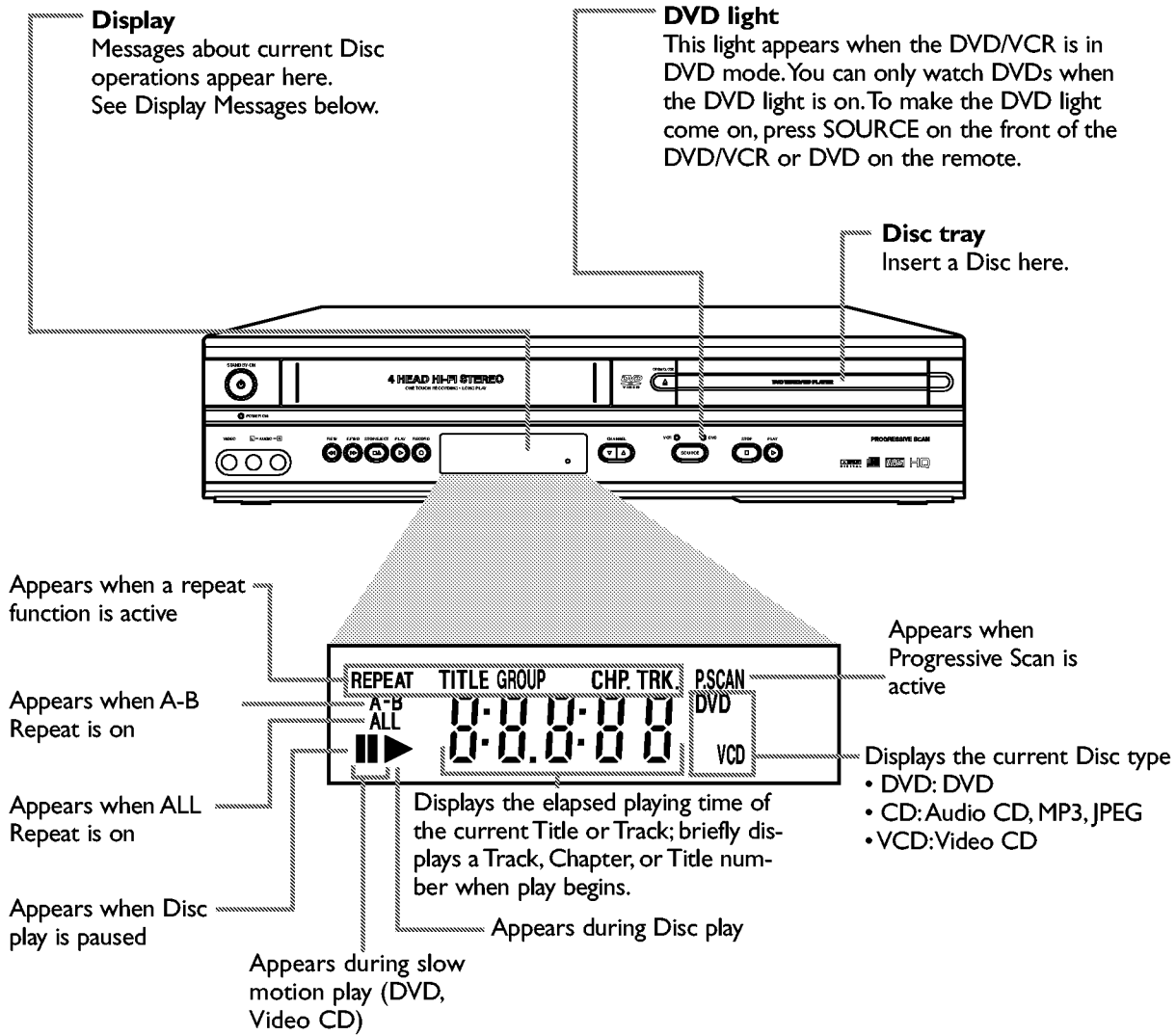

Display Messages

- - - -	Appears after the disc tray closes if the tray is empty, if there is an error reading the disc, or if an unacceptable disc is installed.
OPEN	Tray is opening or is open.
CLOSE	Tray is closing.
Load	Disc is loading.
Pbc	Appears when Playback Control is active (Video CD).

Display Panel (VCR) 21

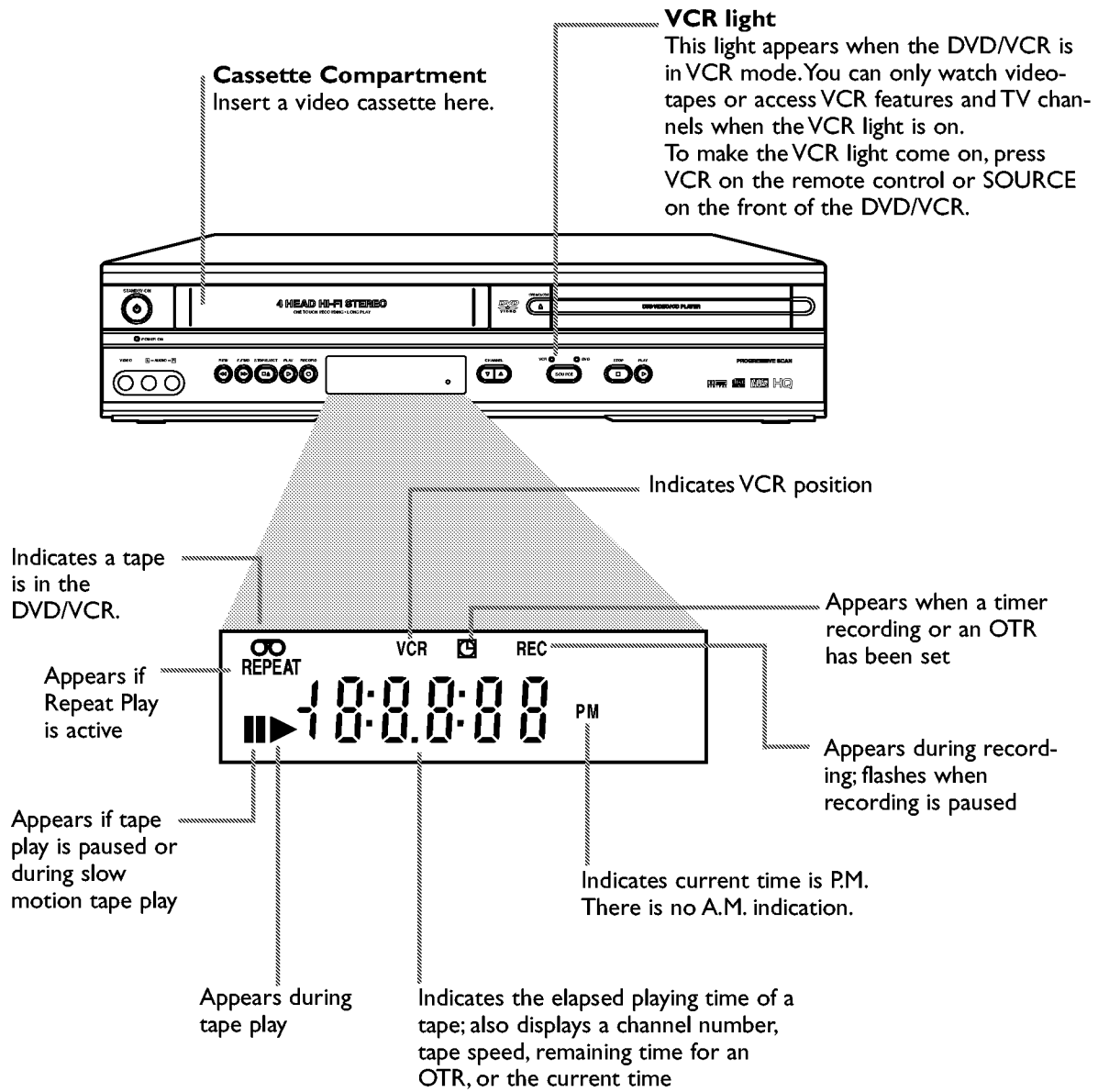

22 Front Panel

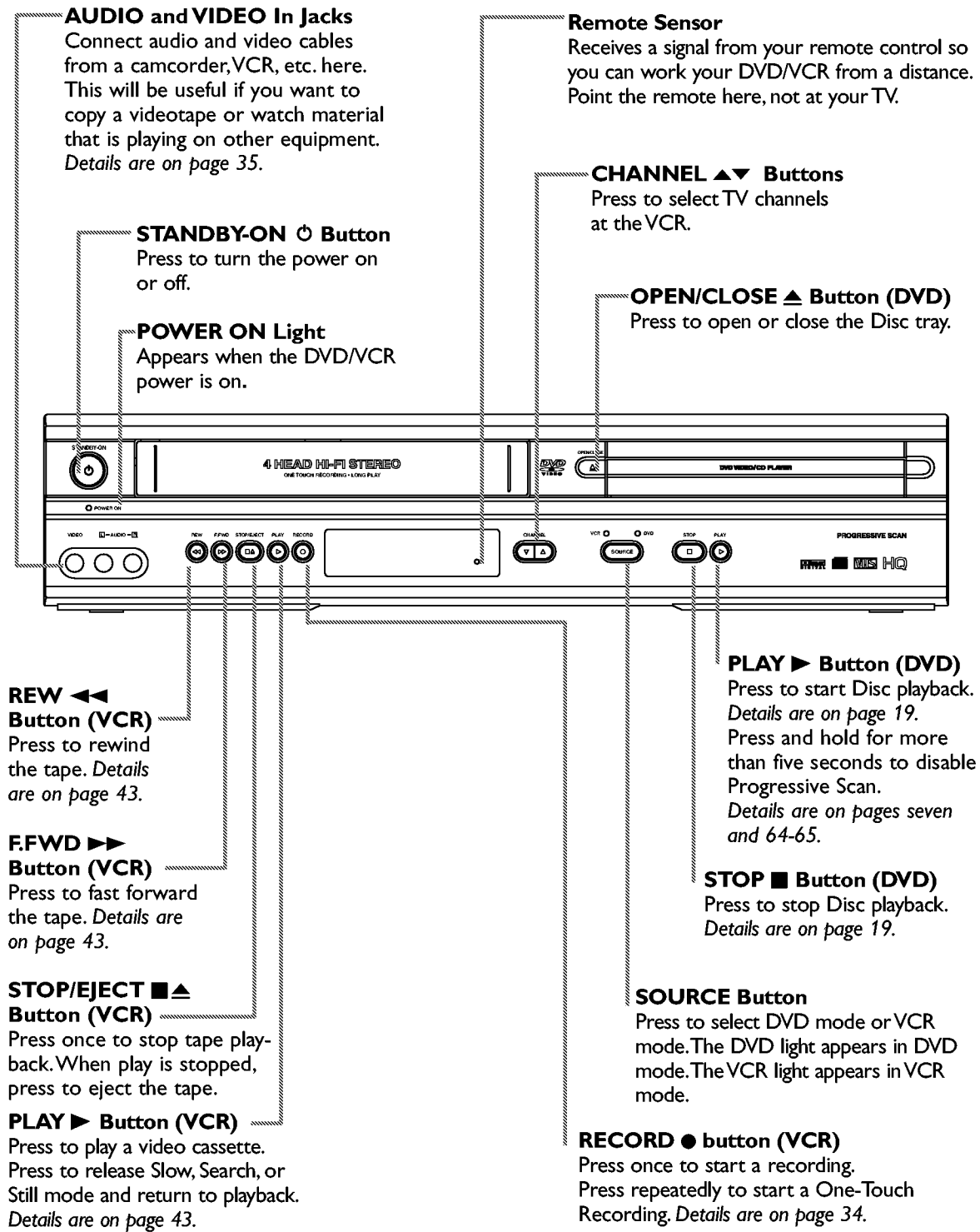

Rear Panel 23

DVD/VCR AUDIO OUT Jacks Left (white) and Right (red)

Connect the supplied audio cables here and to the Audio In jacks of a TV or Stereo. *Details are on pages 11-14.* These jacks provide audio for both the DVD Player and the VCR.

DVD COMPONENT VIDEO OUT (Y Cb/Pb Cr/Pr) Jacks (green, blue, red)
Connect component video cables (not supplied) here and to the Component Video In jacks of a TV. This supplies the picture only for the DVD Player. *Details are on page 12.*

DVD AUDIO OUT jacks Left (white) and Right (red)
Connect the supplied audio cables here and to the Audio In jacks of a TV or Stereo. These jacks only supply audio for the DVD Player. Use these for a second connection to a TV, etc.

AC Power Cord
Connect to a standard AC outlet to supply power to the DVD/VCR.

VCR AUDIO IN jacks Left (white) and Right (red)

Connect audio cables coming from the audio out jacks of a camcorder, another VCR, another DVD Player, or Stereo here. *Details are on page 35.* This will be useful if you want to copy a videotape or watch material that is playing on other equipment.

ANT-IN (Antenna In) jack
Connect your antenna or Cable TV signal here. *Details are on pages 8-15.*

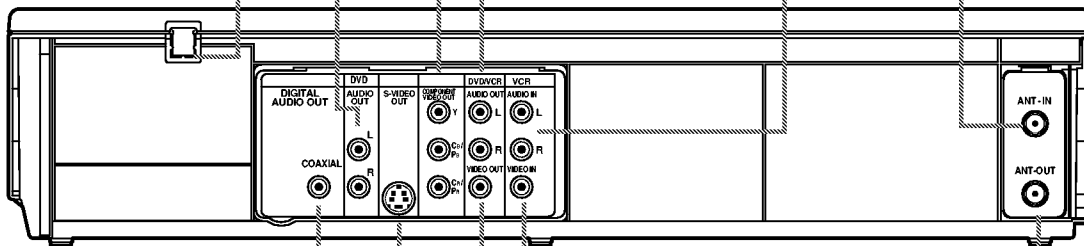

DVD COAXIAL DIGITAL AUDIO OUT Jack (black)
Connect a coaxial digital audio cable (not supplied) here and to the Coaxial Digital Audio In jack of a Stereo. This supplies audio only for the DVD Player. *Details are on page 15.*

DVD S-VIDEO OUT Jack
Connect an S-Video cable (not supplied) here and to the S-Video In jack of a TV. This supplies the picture only for the DVD Player. *Details are on page 13.*

DVD/VCR VIDEO OUT Jack (yellow)
Connect the yellow video cable (supplied) here and to the TV's Video In jack. This supplies the picture for both the VCR and the DVD Player. *Details are on page 11.*

VCR VIDEO IN Jack (yellow)
Connect a video cable from a camcorder, VCR, or DVD Player here. *Details are on page 35.*

ANT-OUT (Antenna Out) Jack
Use the supplied RF coaxial cable to connect this jack to the ANTENNA IN jack on your TV, Cable Box, or Satellite Receiver. *Details are on pages 8-10.*

Helpful Hint

- The DVD S-VIDEO OUT, DVD COMPONENT VIDEO OUT, DVD AUDIO OUT and DVD COAXIAL DIGITAL AUDIO OUT jacks are only useful in DVD mode. To have sound and picture in VCR mode, you must connect either the RF coaxial cable or the audio/video cables supplied. *Details are on pages eight and 11.*

24 Remote Control

SEARCH Button

In DVD mode, press to search for a specific Title/Chapter/Track/Time. Details are on pages 50-51.
In VCR mode, press for a Time Search or an Index Search. Details are on page 42.

REPEAT Button

Press to play a Track, Audio CD, Title, or Chapter repeatedly. Details are on page 53.

A-B REPEAT Button

Press to set up A-B Repeat. Details are on page 53.

RETURN Button

Press to return to the previous level of the DVD Player's Setup menu or to remove the Setup menu.

TITLE Button

Press to see a DVD Title menu. Details are on page 48.

◀▶▶▶ Buttons

Press to select an item in a menu.

STOP ■ Button

Press to stop Disc playback, tape playback, or recording.

PLAY ▶ Button

Press to begin Disc or tape playback.

MARKER Button

Press to see the Markers, which give you quick access to points you select on a Disc. Details are on page 54.

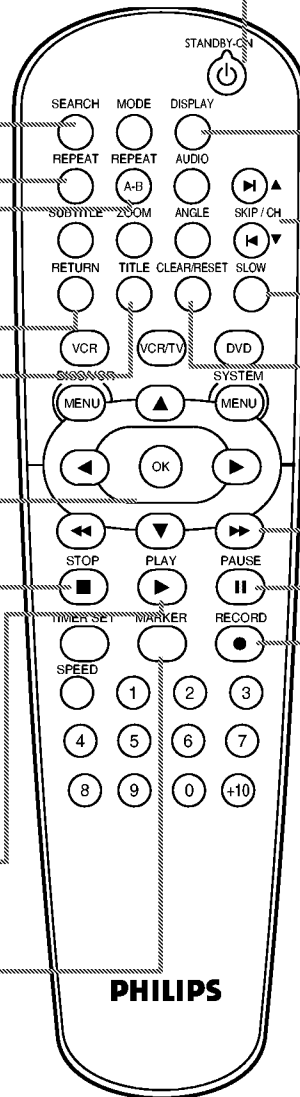

STANDBY-ON ⏻ Button

Press to turn the power on or off.

DISPLAY Button

In VCR mode, press to see status displays. Details are on page 31. In DVD mode, press to access Disc information. Details are on page 69.

SKIP▶/CH ▲ or SKIP◀/CH ▼ Buttons

In DVD mode, press to skip Chapters or Tracks. In VCR mode, press to change TV channels at the DVD/VCR. Press to adjust tracking. Details are on page 44.

SLOW Button

Press to view a videotape in slow motion. Details are on page 43.

CLEAR/RESET Button

Press to remove VCR menus. Press to reset the tape counter. Details are on page 41. Press to reset a menu item in DVD mode.

▶▶ (Fast Forward) Button

In DVD mode, press to fast forward the Disc. Details are on page 49. Press when DVD/Video CD play is paused to start slow motion play. Details are on page 59. In VCR mode, press to fast forward the tape. Details are on page 43.

PAUSE || Button

Press to pause Disc playback. Press repeatedly to advance the DVD or Video CD picture step by step (or one frame at a time). Details are on page 52. Press to pause or resume VCR recording. Details are on page 32. Press to pause a tape. Details are on page 43.

RECORD ● Button

Press to start a VCR recording. Details are on page 32. Press repeatedly to start a One-Touch Recording. Details are on page 34.

Helpful Hints

- For DVD Player features, press DVD before pressing other buttons. To put the DVD/VCR in DVD mode, press DVD or SOURCE so the DVD light appears on the front of the DVD/VCR.
- For VCR features, press VCR before pressing any other buttons. To put the DVD/VCR in VCR mode, press VCR or SOURCE so the VCR light appears on the front of the DVD/VCR.

Remote Control (cont'd) 25

MODE Button
Press to set a Program. *Details are on page 60.* Press to start Random playback. *Details are on page 61.*

ZOOM Button
Press to enlarge the DVD, Video CD, or JPEG image. *Details are on page 59.*

SUBTITLE Button
Press to select a language for DVD subtitles. *Details are on page 55.*

VCR Button
Press before using the remote control for VCR features. Press to put the DVD/VCR in VCR mode.

DISC/VCR/MENU Button
Press to access or remove a DVD Disc menu or the VCR menu.

◀◀ (Rewind) Button
Press to fast reverse a Disc. *Details are on page 49.* Press when DVD playback is paused to start reverse slow motion playback. *Details are on page 59.* Press to rewind a tape. *Details are on page 43.*

TIMER SET Button
Press to set a timer recording that you have programmed. *Details are on pages 36-38.*

SPEED Button
Press to select the VCR's recording speed (SP or SLP). *Details are on pages 32, 35, and 72.*

Number Buttons
In DVD mode, press to select a Track or Chapter for playback. Use the +10 button for items 10 and above. *Details are on page 51.*
In VCR mode, use to select TV channels. Enter channel numbers as a two-digit number for the quickest results (to select channel 6, press 0,6). For channels 100 and above, enter a three-digit number (for channel 117, press 1, 1, 7). If you have Cable TV, channels 1-125 are available. If you have an antenna, channels 2-69 are available. The +10 button has no effect in VCR mode.

AUDIO Button
Press to choose a DVD audio language or an Audio CD sound mode. *Details are on page 58.*

ANGLE Button
Press to see a DVD picture from a different angle. *Details are on page 55.*

VCR/TV Button
Press to select VCR or TV position. In VCR position, watch a tape or watch/record TV programs (changing channels at the VCR). Use TV position to watch TV channels (changing channels at the TV) or watch one program while recording another. *Details are on page 33.*

DVD Button
Press before using the remote control for DVD features. Press to put the DVD/VCR in DVD mode.

SYSTEM/MENU Button
Press to access or remove the DVD Player's Setup menu.

OK Button
Press to confirm or select menu items.

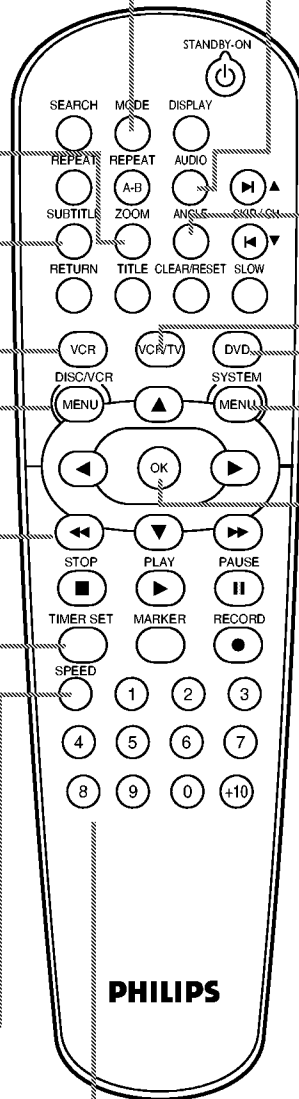

26 Channel Setup

Although your DVD/VCR may automatically memorize the channels you receive when you turn it on for the first time, you can set up the channels again.

- 1 Press **VCR**, then press **DISC/VCR/MENU** so MENU appears.

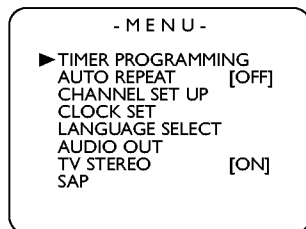

- 2 Press **▲** or **▼** to select **CHANNEL SET UP**. Then, press **▶**.

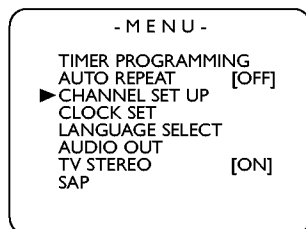

- 3 Press **▲** or **▼** to select **AUTO SET UP**. Press **▶**.

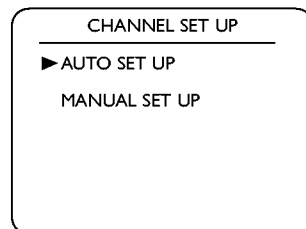

- 4 **AUTO SET UP** will flash while the DVD/VCR sets up the available channels. When setup is complete, the lowest available channel will appear on the TV. Now when you press **SKIP▶/CH▲** or **SKIP◀/CH▼**, you will scan only through available channels. You still can select any channel using the Number buttons.

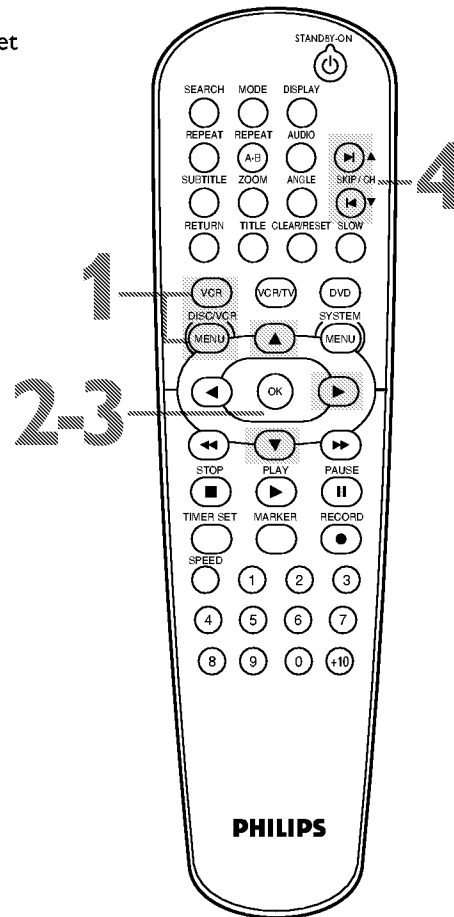
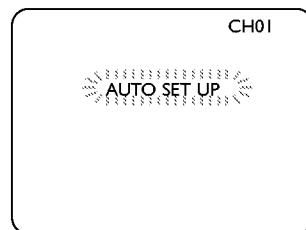

Helpful Hints

- You cannot program channels if you are using a Cable Box or Satellite Receiver.
- If you have an antenna, channels 2-69 will be possible. If you have Cable TV, channels 1-125 will be possible.
- To stop Channel Setup, press **DISC/VCR/MENU** while **AUTO SET UP** is flashing.

Channel Setup (cont'd) 27

Adding/Deleting Channels

You may want to add or delete TV channels if your channel lineup changes or if you no longer watch some channels.

- 1 Press **VCR**, then press **DISC/VCR/MENU** so MENU appears.
- 2 Press **▲** or **▼** to select **CHANNEL SET UP**, then press **▶**.
- 3 Press **▲** or **▼** to select **MANUAL SET UP**, then press **▶**.

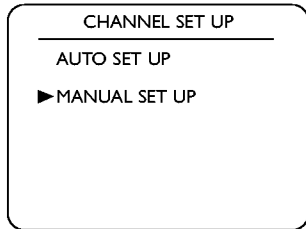

- 4 Press **▲** or **▼** until the channel number you want to add or delete appears on the screen.

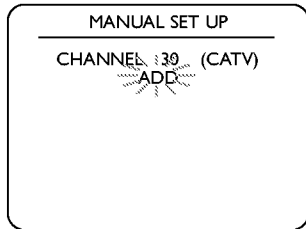

- 5 Press **▶** or **◀** so **ADD** or **DELETE** flashes on the screen.

- 6 While your choice is flashing, press **CLEAR/RESET**. The channel you added or deleted will be the current channel. Added channels are available when you flip through channels using the **SKIP▶/CH▲** and **SKIP◀/CH▼** buttons. You still can select deleted channels with the Number buttons.

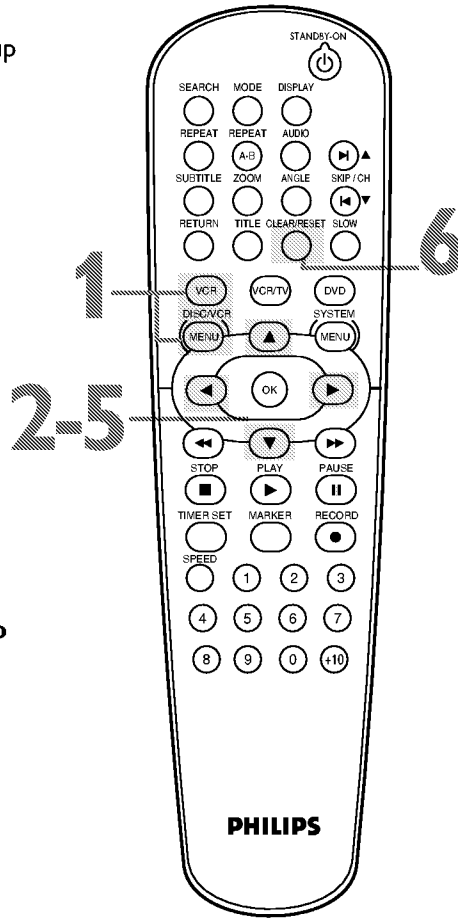

28 Clock (VCR)

Follow these steps to set the VCR clock. Make sure:

- 1 Press **VCR**, then press **DISC/VCR/MENU** so **MENU** appears.

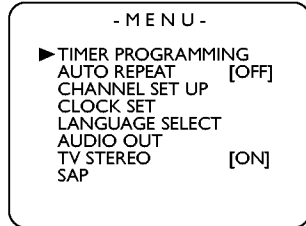

- 2 Press **▲** or **▼** to select **CLOCK SET**, then press **▶**.

- 3 While the **MONTH** space is flashing, press **▲** or **▼** until the month appears. Then, press **▶**.

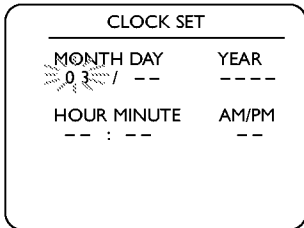

- 4 While the **DAY** space is flashing, press **▲** or **▼** until the day appears. Then, press **▶**.

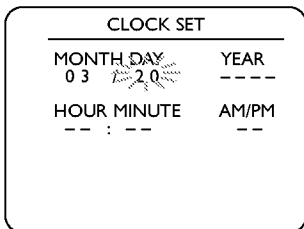

- 5 While the **YEAR** space is flashing, press **▲** or **▼** until the year appears. Press **▶**. The day of the week will appear automatically.

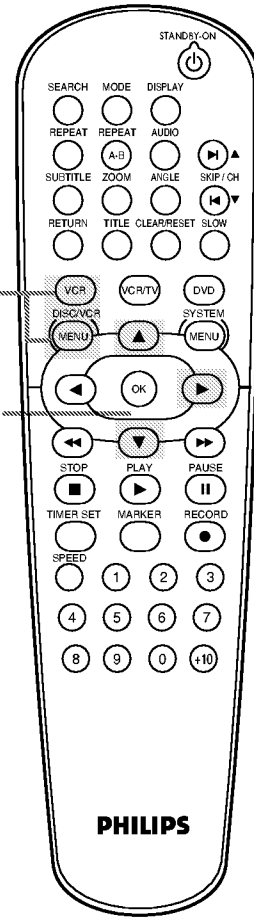
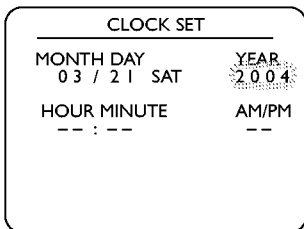

Helpful Hints

- If the clock has never been set, the **CLOCK SET** menu may appear when you press **DISC/VCR/MENU**. If so, follow the instructions from step 3 above.
- Press **DISPLAY** until the time appears on the TV screen.
- Power failures of more than 30 seconds can erase the clock setting.

Clock (VCR) (cont'd) 29

- 6** While the **HOUR** space is flashing, press **▲** or **▼** until the hour appears. Then, press **▶**.

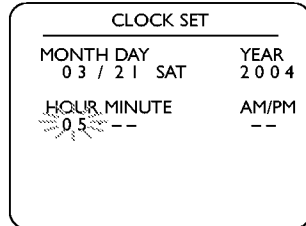

- 7** While the **MINUTE** space is flashing, press **▲** or **▼** until the minute appears. Then, press **▶**.

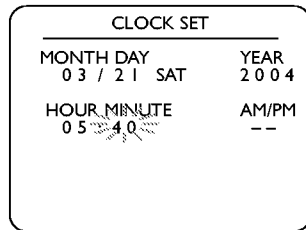

- 8** While the **AM** or **PM** space is flashing, press **▲** or **▼** to point to **AM** or **PM**. Your selection will flash on the screen in the AM/PM space.

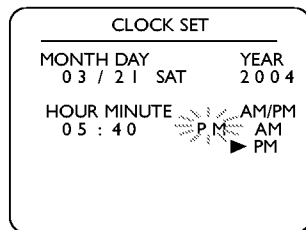

- 9** Press **CLEAR/RESET** or **▶** to start the clock.

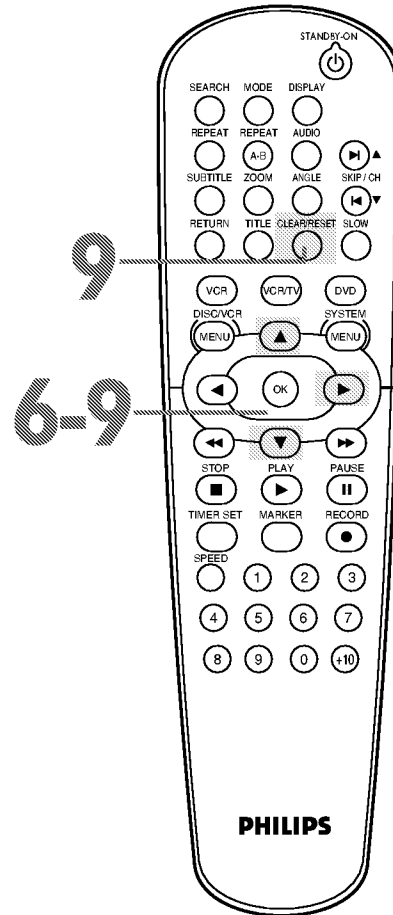

Helpful Hint

- To reset the clock, follow steps 1-2 on page 28. Select the information you want to change using **▶** or **◀**. When the information is flashing, use **▲** or **▼** to enter the correct information. Press **CLEAR/RESET** to set the clock.

30 Language (VCR)

Follow the steps below to change the language of the VCR on-screen displays and menus.

- 1 Press **VCR**, then press **DISC/VCR/MENU** so MENU appears.

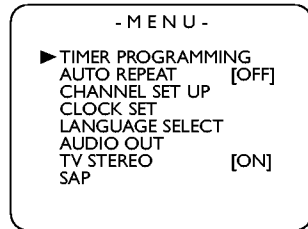

- 2 Press **▲** or **▼** to choose **LANGUAGE SELECT**, then press **▶**.

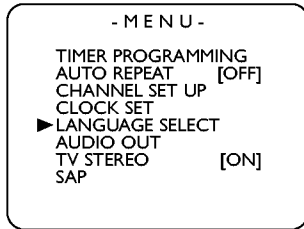

- 3 Press **▲** or **▼** to choose **ENGLISH, FRANCAIS (French), or ESPAÑOL (Spanish)**.

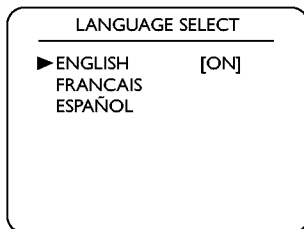

- 4 Press **CLEAR/RESET** to remove the menu.

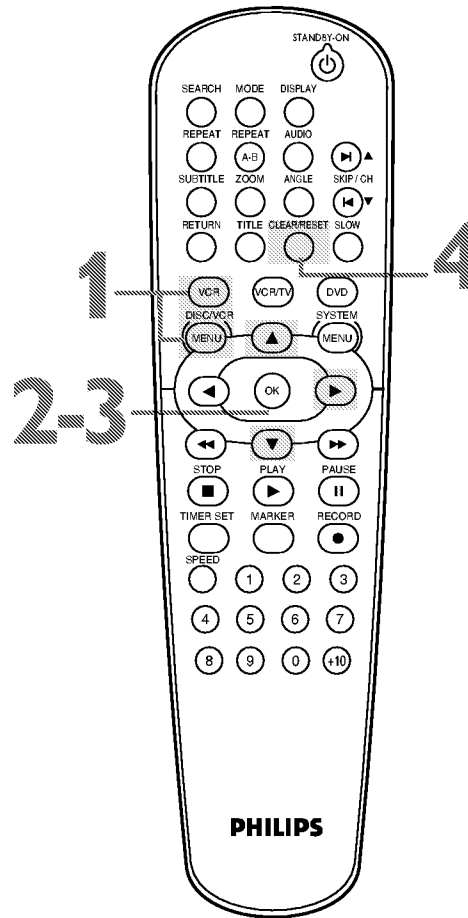

Helpful Hint

- If you select **FRANCAIS (French)**, or **ESPAÑOL (Spanish)** and need English:
 - 1) Press **DISC/VCR/MENU** so **MENU** appears.
 - 2) Press **▼** to choose **SELECTION LANGUE** or **SELEC. IDIOMA**, then press **▶**.
 - 3) Press **▲** or **▼** to select **ENGLISH**.
 - 4) Press **CLEAR/RESET**.

VCR Status Displays 31

You may access status displays by pressing DISPLAY. The displays may include the current time, channel, and other information.

- 1 **Press DISPLAY.** The COUNT display will appear for five seconds. After five seconds, only the real-time tape counter will appear. This counter shows you the elapsed playing time of the tape (from the point at which the counter was set to zero). The counter also will appear on the display panel on the front of the DVD/VCR.

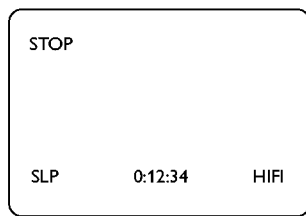

- 2 **Press DISPLAY again.** The CLOCK display will appear for five seconds. After five seconds, only the time will appear (the clock must be set). (If you are watching TV, the channel number and the availability of stereo or second audio will also appear.) The time also will appear on the display panel on the front of the DVD/VCR.

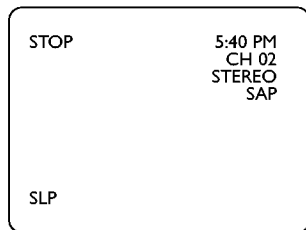

- 3 **Press DISPLAY again to remove all the displays.**

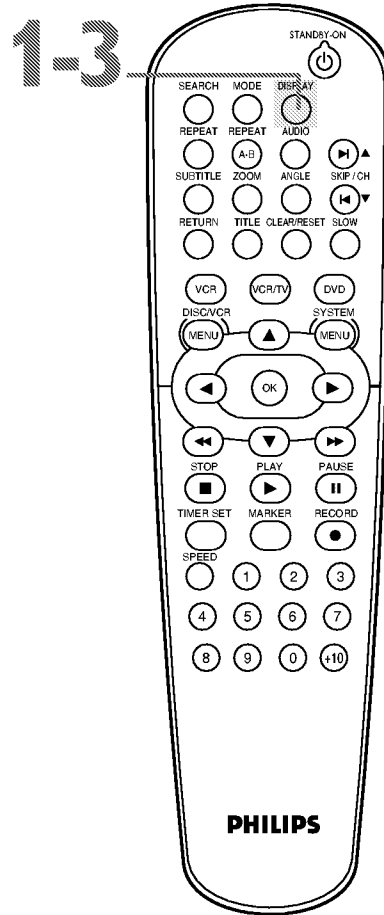

Helpful Hints

- If the channel you select has no broadcast, the screen will be solid blue.
- You cannot access a status display when viewing a still picture, during slow motion, or during forward and reverse searching.
- Channel numbers appear on the screen for a few seconds each time you change channels.

32 Videotape Recording

Read and follow the steps below to record a television program onto a videotape.

- ◆ Before you begin, make sure the DVD/VCR is in VCR mode. Press VCR so the VCR light appears on the front of the DVD/VCR.

- 1 Turn on the TV and set it to channel 3 or 4 or the Video In channel.** If you connected the DVD/VCR to the TV using the supplied audio and video cables, select your TV's Video In channel. *Details are on page 11.* If you connected the DVD/VCR to the TV using the supplied RF coaxial cable, choose channel 3 (or 4) at the TV. *Details are on pages 8-10.*
- 2 Insert a tape with its record tab intact into the cassette compartment of the DVD/VCR.** If tape playback begins, press STOP ■.
- 3 Press SPEED** until the desired tape speed (**SP** or **SLP**) appears briefly on the screen. *Details about tape speed are on page 72.*
- 4 Press SKIP▶/CH▲ or SKIP◀/CH▼ or the Number buttons** to select the TV channel to record.
- 5 Press RECORD ●** to start recording. REC will appear on the DVD/VCR's display panel.
- 6 To pause the recording, press PAUSE || once.** REC will flash. **To resume recording, press RECORD ● or press PAUSE || again.** REC will reappear.
- 7 To stop recording, press STOP ■.**

Recording Prevention

Video cassettes have record tabs to ensure that recordings are not accidentally erased.

- 1 To prevent recording, break off the tab with a screwdriver.**
- 2 To allow recording, cover the hole with clear tape.**



- 1 Turn on the TV.**
- 2 Insert a tape in the DVD/VCR.**

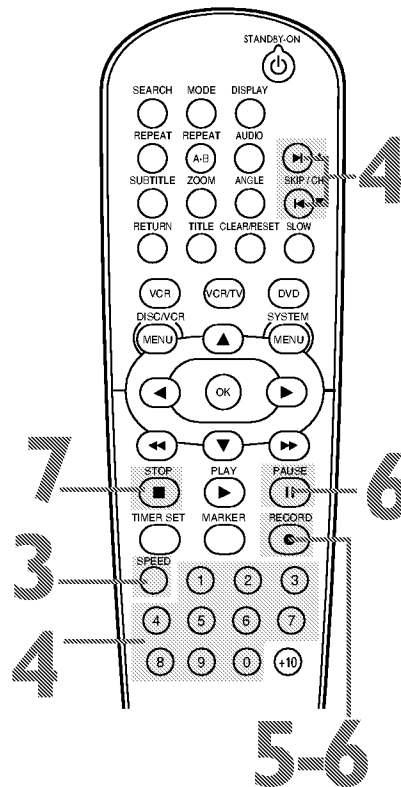

Helpful Hints

- Other recording options are on pages 33-39.
- The VCR will record in a preset volume.
- Pause will switch to Stop after five minutes to protect the VCR and the tape from damage. When a recording is paused, review the pause time remaining with the ■ marks on the screen. Each ■ mark equals one minute remaining. During the last minute of paused recording, the ■ mark will flash.
- If any menu is on the TV screen, the RECORD ● button on the remote does not function. Press CLEAR/RESET to remove the menu. Then, press RECORD ●. Or, use the RECORD ● button on the front of the DVD/VCR.

Recording One Channel/Watching Another 33

- 1** Press **VCR**, then press **RECORD** ● to record the current TV channel. Details are on page 32.
- 2** Press **VCR/TV** once to put the DVD/VCR in TV position. The VCR light will disappear from the DVD/VCR's display panel.
- 3** Use the TV remote control to select the channel you want to watch at the TV.
- 4** To return to the channel being recorded, use the TV remote control to return to channel 03 or 04 at the TV. Details are on page eight. Or, if you connected the DVD/VCR to the TV using audio and video cables, return to the TV's correct Video In channel. Details are on page 11.
- 5** Press **VCR/TV** on the DVD/VCR remote control to put the DVD/VCR in VCR position. (The VCR light will appear in the DVD/VCR's display panel again.) The channel being recorded will appear on the TV screen.
- 6** Press **STOP** ■ to stop the recording.

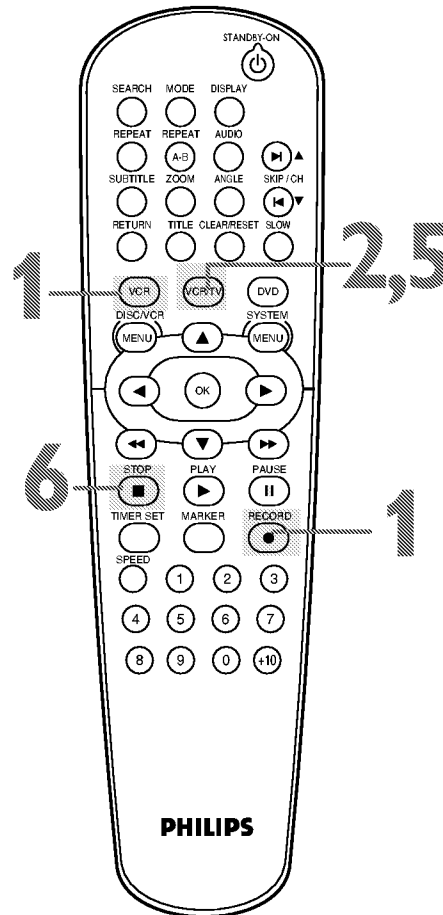

- 3** Select the channel you want to watch at the TV.
- 4** Reselect channel 03, 04, or Video In at the TV.

Helpful Hint

- If you use a Cable Box or Satellite Receiver, you may not be able to watch one channel while recording another. See pages 9-10 for details.

34 One-Touch Recording

One-Touch Recording (OTR) lets you set a timed recording 30 minutes to eight hours long of the current TV channel. Before you begin:

- Place the DVD/VCR in VCR mode. Press VCR so the VCR light appears on the front of the DVD/VCR.
- Select a recording speed (SP, SLP) with the SPEED button.
- Put a videotape in the cassette compartment. Make sure the tape's record tab is intact and the tape is long enough to record the program(s).

1 Press **VCR**, then press **SKIP ►/CH ▲** or **SKIP ◀/CH ▼** or the **Number** buttons to select the channel you want to record.

2 Press **RECORD ●** repeatedly until the desired recording length (30 minutes to eight hours) appears on the TV screen. Recording will begin. REC and  will appear on the DVD/VCR's display panel.

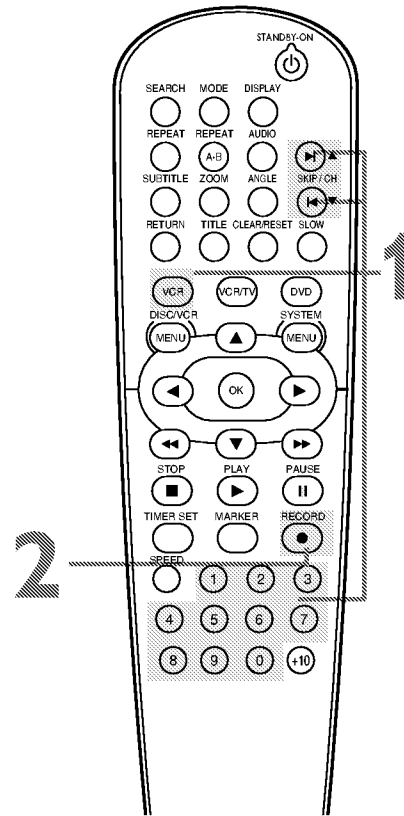
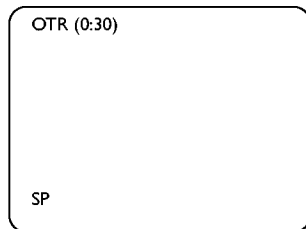

Stopping an OTR

To stop an OTR before recording is finished, press **STOP ■** on the remote control or **STOP/EJECT ■▲** (VCR) on the front of the DVD/VCR.

To cancel the OTR but continue recording, press **RECORD ●** repeatedly until **RECORD** appears in the upper left corner of the TV screen.

When an OTR finishes, the DVD/VCR will either switch to DVD mode or turn itself off. If it changes to DVD mode, press **STANDBY-ON ○** to turn it off.

After an OTR,  flashes because the VCR is still on standby for timer recordings. Press **TIMER SET** on the remote or **STOP/EJECT ■▲** (VCR) on the DVD/VCR to cancel timer standby and use the VCR normally again.

Helpful Hints

- The remaining recording time will appear on the display panel during an OTR. Press **DISPLAY** to see it on the TV screen.
- To change the recording length while an OTR is in progress, press **RECORD ●** repeatedly.
- You cannot pause an OTR.
- If the preset time for a timer recording comes up during an OTR, the OTR has priority. The timer recording will not take place.
- If the end of the tape is reached during an OTR, the VCR will stop recording, eject the tape, and switch to DVD mode or turn off.

Rerecording (Tape Duplication) 35

These instructions show you how to copy videotapes. The illustration uses two DVD/VCRs. Other VCRs or Camcorders may operate differently.

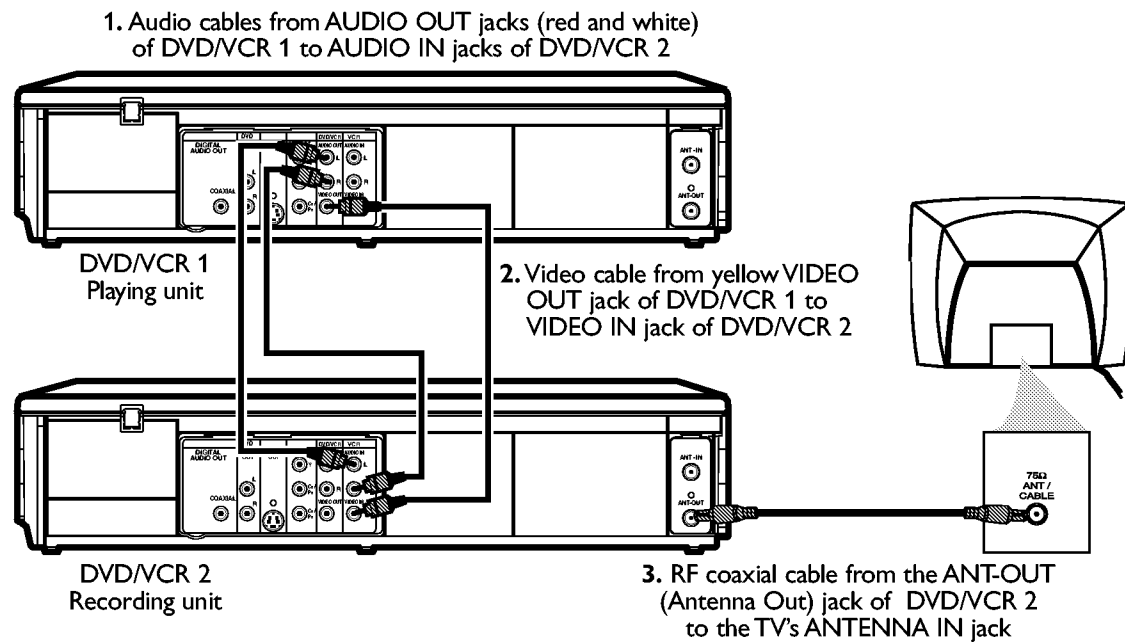

- 1 **Make the connections shown above.**
- 2 DVD/VCR 1 will play your tape. **Put a prerecorded tape into the cassette compartment of DVD/VCR 1.** Press VCR to put the unit in VCR mode if necessary.
- 3 DVD/VCR 2 will record your tape. **Insert a blank tape in the cassette compartment of DVD/VCR 2.** Press VCR to put the unit in VCR mode if necessary.
- 4 **Turn on the TV and set it to channel 03 or 04** (the RF output channel of DVD/VCR 2). To determine the DVD/VCR's output channel, see step 4 on page eight.
- 5 **Point the remote control at DVD/VCR 2. Press Number buttons 0, 0, 1 or 0, 0, 2.** (See *Helpful Hints to the right.*)
- 6 **Press SPEED to select SP or SLP at DVD/VCR 2.**
- 7 **Press PLAY ► (VCR) on the front of DVD/VCR 1 and RECORD ● on the front of DVD/VCR 2 at the same time.**
To stop recording, press STOP/EJECT ■▲ (VCR) on DVD/VCR 1, then press STOP/EJECT ■▲ (VCR) on DVD/VCR 2.

Helpful Hints

- If you use the AUDIO and VIDEO IN jacks on the back of DVD/VCR 2, press Number buttons 0, 0, 1 at step 5. L1 will appear on the TV screen.
- If you use the AUDIO and VIDEO In jacks on the front of DVD/VCR 2, press Number buttons 0, 0, 2 at step 5. L2 will appear on the TV screen.
- Unauthorized recording of copyrighted television programs, video tapes, or other materials may infringe on the rights of copyright owners and violate copyright laws.
- If a program has copyright protection, it may not be recorded clearly.

36 Timer Recording

Follow the steps below to program the VCR of the DVD/VCR to record TV programs while you're away from home. Before you begin:

- Set up the TV channels at the DVD/VCR. *Details are on page 26.*
- Set the clock. *Details are on pages 28-29.*
- Put a tape in the cassette compartment of the DVD/VCR. Make sure the tape's record tab is intact and the tape is long enough to record the program(s).
- Press VCR so the VCR light appears on the front of the DVD/VCR.

1 Press **DISC/VCR/MENU** so **MENU** appears.

2 Press **▲** or **▼** to select **TIMER PROGRAMMING**. Then, press **▶**. Program numbers that do not have a timer recording stored will flash.

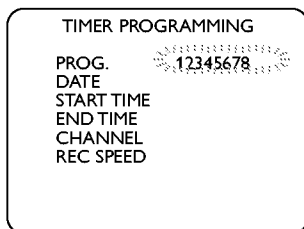

3 Press **▲** or **▼** to select an empty program. Then, press **▶**.

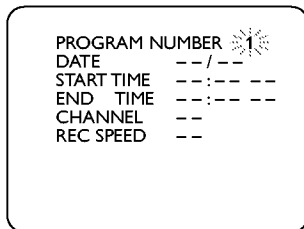

4 Press **▲** or **▼** to select **ONCE, DAILY, or WEEKLY**. Then, press **▶**.

- **ONCE** - The VCR will record a TV program on any day you choose, up to 12 months away.
- **DAILY** - The VCR will record a TV program at the same time on the same channel every day, Monday through Friday.
- **WEEKLY** - The VCR will record a TV program at the same time on the same channel every week, for example, every Monday.

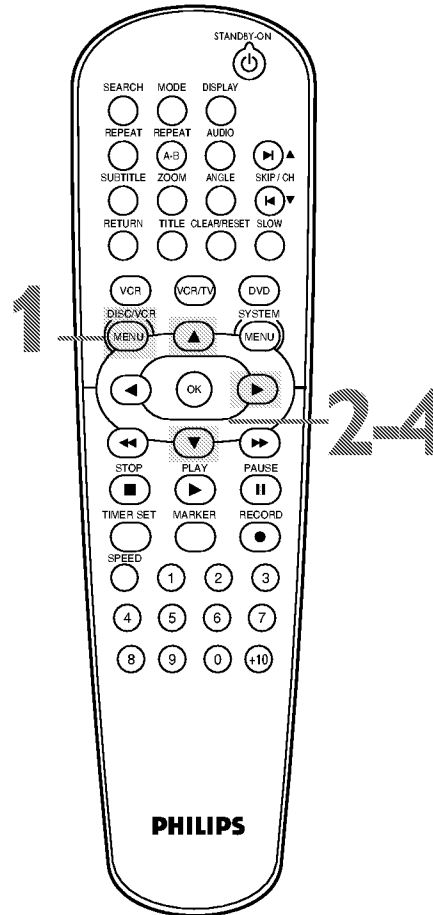
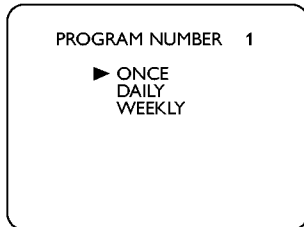

Helpful Hints

- You cannot access the **TIMER PROGRAMMING** menu at step 2 if the clock is not set. The **CLOCK SET** menu will appear. Follow the steps on pages 28-29 to set the clock.
- Only programs that will air Monday-Friday can be recorded on a **DAILY** basis. If you select **DAILY** at step 4, then enter a Saturday or Sunday **DATE** at step 5, the correct program will not be recorded. The VCR will alter the recording date and record a different program than the one you intended.

Timer Recording (cont'd) 37

- 5** To enter the recording date, press **▲** or **▼** until the month appears. Then, press **▶**. Next, press **▲** or **▼** until the day appears. Then, press **▶**. The day of the week will appear. You cannot record more than one year in advance.

```

ONE TIME PROGRAM
PROGRAM NUMBER 1
DATE 05/04 TUE
START TIME ---:--:--
END TIME ---:--:--
CHANNEL ---
REC SPEED --
    
```

- 6** To enter the recording's start time, press **▲** or **▼** until the hour appears. Press **▶**. Press **▲** or **▼** until the minute appears. Press **▶**. Finally, press **▲** or **▼** to point to AM or PM. AM or PM will flash beside the start time. Press **▶**.

```

ONE TIME PROGRAM
PROGRAM NUMBER 1
DATE 05/04 TUE
START TIME 07:30 P M
END TIME ---:--:--
CHANNEL ---
REC SPEED --
                                AM
                                ▶PM
    
```

- 7** Repeat the procedure in step 6 to set the recording's end time.

- 8** Press **▲** or **▼** until the channel number appears. Then, press **▶**.

- If you are using a standard antenna/Cable TV hookup (as shown on page eight), select the channel of the TV program you want to record.
- If you are recording from other equipment, select L1 or L2. To determine L1 or L2, refer to the Helpful Hints on page 38.
- If you are using a Cable Box/Satellite Receiver, select the Cable Box/Satellite Receiver output channel (03 or 04). Then, at the Cable Box/Satellite Receiver, select the channel you want to record. Leave the Cable Box/Satellite Receiver on for the timer recording. Details are on page nine.

```

ONETIME PROGRAM
PROGRAM NUMBER 1
DATE 05/04 TUE
START TIME 07:30 P M
END TIME 08:30 P M
CHANNEL 16
REC SPEED --
    
```

Instructions continue on page 38.

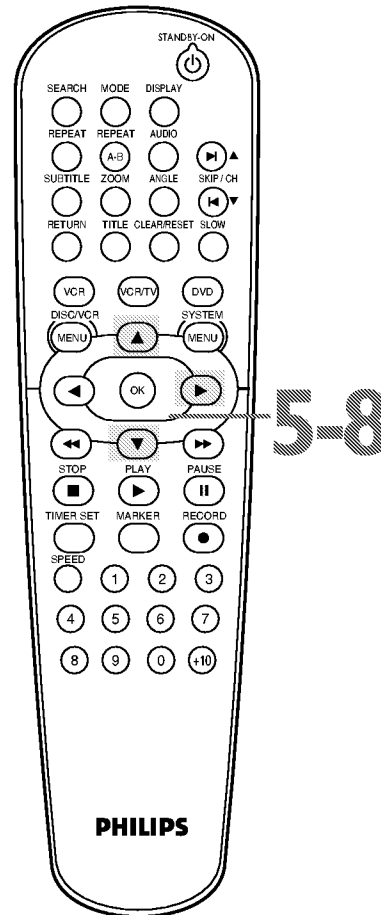

Helpful Hints

- If you are recording from other equipment, set CHANNEL to L1 or L2 at step 8. If you connected the other equipment to the AUDIO and VIDEO In jacks on the front of the DVD/VCR, choose L2. If you connected the equipment to the AUDIO IN and VIDEO IN jacks on the back of the DVD/VCR, choose L1.
- Enter the information while the space is flashing.
- To stop a started timer recording, press STOP/EJECT **■▲** (VCR) on the front of the DVD/VCR. (You cannot stop a started timer recording with the STOP **■** button on the remote.)

More Helpful Hints are on page 76.

38 Timer Recording (cont'd)

- 9 Press **▲** or **▼** to select a recording tape speed. The arrow will appear beside your choice. The selected speed will flash beside REC SPEED. Details about tape speed are on page 72.

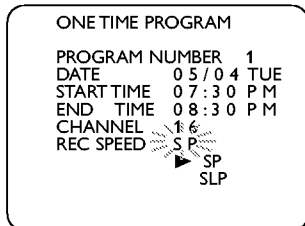

- 10 Press **CLEAR/RESET** to store the timer recording.

- 11 Press **TIMER SET**. The DVD/VCR will turn off and **⏻** will appear in the display panel. In some cases, the DVD/VCR will switch to DVD mode instead. You may use the DVD Player during a timer recording. If you want to use the VCR until time for the recording, don't press **TIMER SET** until a few minutes before the recording should start. Or, press **TIMER SET** only when you know you won't be using the VCR anymore (until after the recording). When **⏻** appears, you cannot put the DVD/VCR in VCR mode by pressing **VCR** or **SOURCE**. You must first press **TIMER SET** to cancel the timer recording temporarily. Then, you can use the VCR features again.

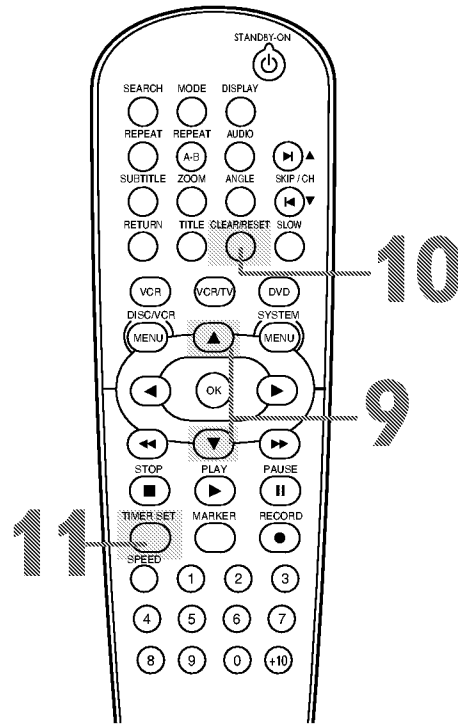

cancelling Timer Recordings

- 1 Press **VCR**, then press **DISC/VCR/MENU** so **MENU** appears.
- 2 Press **▲** or **▼** to select **TIMER PROGRAMMING**, then press **▶**.
- 3 Press **▲** or **▼** to find the program you want to cancel.
- 4 While the program number is flashing, press **◀** to clear all the information for that program.

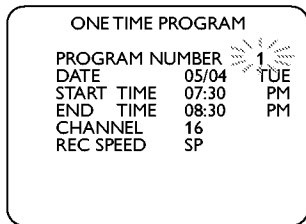

- 5 Press **CLEAR/RESET** to remove the menu.

Helpful Hints

- To change incorrect information, press **◀** or **▶** to choose the item you want to change. Press **▲** or **▼** to adjust the information.
- If a timer recording is set and **⏻** appears, pressing **STOP/EJECT** **■▲** (VCR) will turn on the DVD/VCR and/or cancel the timer recording. The **⏻** will disappear. Press **STOP/EJECT** **■▲** (VCR) again to remove the tape. Insert a tape and press **TIMER SET** to reset the timer recording.
- If there is no tape in the VCR when you press **TIMER SET**, **⏻** will flash. Insert a tape.

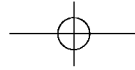

DVD to Videotape Duplication 39

Follow the steps below to copy a DVD to a videotape. **This will be possible only if the DVD is not copy protected.**

Before you begin:

- Put a videotape in the cassette compartment. Make sure the tape's record tab is intact and the tape is long enough to record the DVD.
- Put the DVD you want to copy in the disc tray.
- Press VCR so the VCR light appears on the front of the DVD/VCR.
- Turn on the TV and set it to channel 3, 4, or its Video Input.

- 1** Point the remote control at the DVD/VCR. Press **Number buttons 0, 0, 3**. "DISC" will appear on the TV screen.

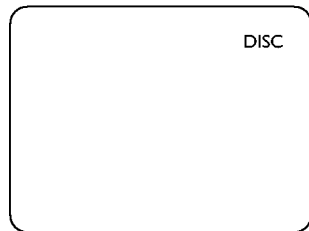

- 2** Press **SPEED** until the desired tape speed (**SP** or **SLP**) appears briefly on the screen. Details about tape speed are on page 72.

- 3** Press **RECORD** ● to start recording. 'REC' will appear on the display panel.

- 4** Press **DVD**. Press **PLAY** ► to play the disc.

- 5** To pause the recording, press **VCR**, then press **PAUSE** || once. REC will flash. To resume recording, press **RECORD** ● or press **PAUSE** || again. REC will reappear.

- 6** To stop recording, press **VCR**, then press **STOP** ■.

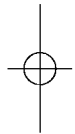
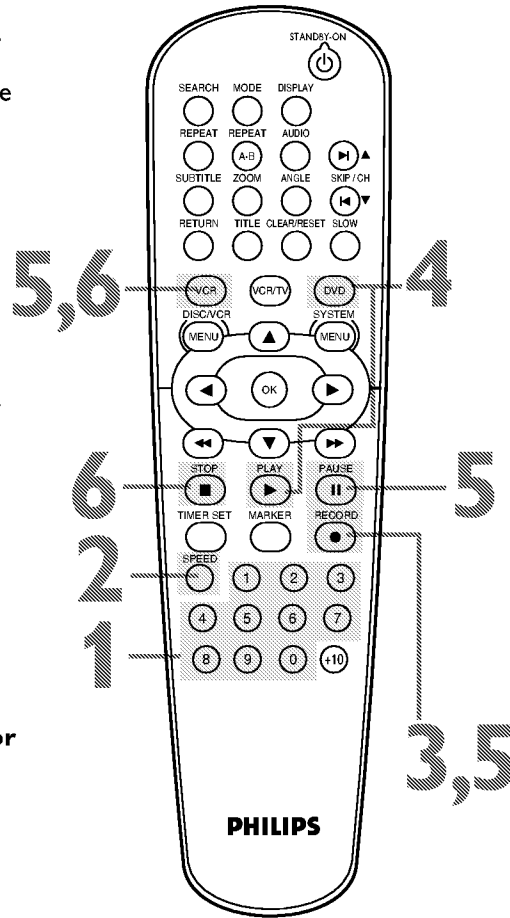

Helpful Hints

- A timer recording is not possible during DVD to videotape duplication.
- You cannot copy a DVD to a videotape if you are using Progressive Scan. Details are on page 12.

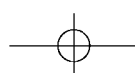

40 Repeat Play

Follow the steps below to play a videotape repeatedly.

- 1 Press **VCR**, then press **DISC/VCR/MENU** so **MENU** appears.

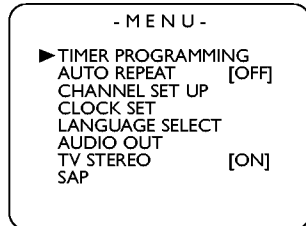

- 2 Press **▲** or **▼** to select **AUTO REPEAT**.

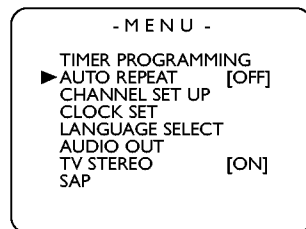

- 3 Press **▶** so **ON** appears next to **AUTO REPEAT**.
Tape playback will begin immediately. **AUTO REPEAT ▶** will appear on the TV screen briefly.
(If you are fast forwarding or rewinding the tape, press **CLEAR/RESET** to remove the menu, then press **PLAY ▶** to begin tape playback.)
The tape will play to the end, rewind, then play again. (TV programming will appear on the screen while the tape is rewinding.)

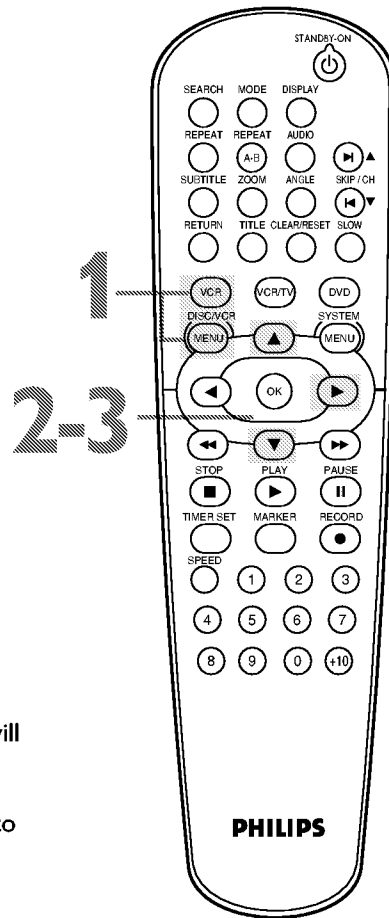
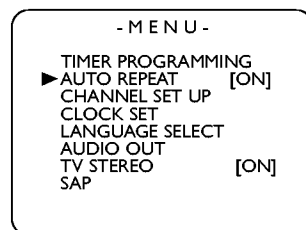

Helpful Hint

- To cancel **AUTO REPEAT**, follow steps 1-2. At step 3, press **▶** so **OFF** appears beside **AUTO REPEAT**. Press **CLEAR/RESET**.

Tape Counter 41

Follow the steps below to reset the VCR's real-time tape counter to zero at a tape location you want to refer to later.

1 Press **VCR**, then play, fast forward, or rewind a tape to the location that you would like to refer to later. Press **STOP** ■ to stop the tape.

2 Press **DISPLAY** to see the status display.



3 While the counter is on the screen, press **CLEAR/RESET** to reset the counter to zero.

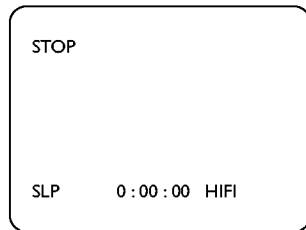

4 When you later want to return to this point on the tape, press **DISPLAY** so you can see the counter (while tape play is stopped). Press ◀◀ or ▶▶. As the tape rewinds or forwards, watch the counter. When it reaches zero, press **PLAY** ▶ to play the tape.

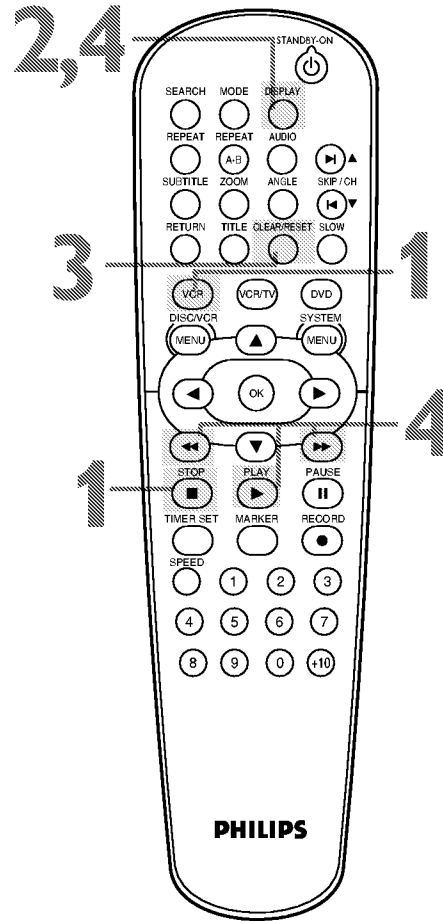

Helpful Hints

- You may only set the counter to zero at one location at a time. Setting the counter to zero at a second location will erase the previous zero setting.
- If you remove the tape, the counter will reset to zero at the point at which you last stopped playback whenever you reinsert the tape.

42 Time Search, Index Search

Time Search

Follow the steps below to search forward or backward on a tape a specific length of time. There must be a tape in the cassette compartment.

- 1 Press **VCR**, then press **SEARCH** until the **TIME SEARCH** screen appears.

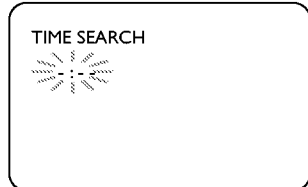

- 2 Within 30 seconds, press **▲** or **▼** until your desired length of time appears. Or, press and hold **▲** or **▼** until you reach the desired length of time. You can set a Time Search for up to 9 hours and 59 minutes (9:59).

- 3 Within 30 seconds, press **◀** (for a reverse search) or **▶** (for a forward search). The VCR begins rewinding or fast forwarding the tape. When the tape finishes rewinding or fast forwarding the time you specified, playback will begin. The time will count down beneath **TIME SEARCH** during the search. If the end of the tape is reached during the search, the search will stop and the tape may rewind. *Details are on page 44.*

Index Search

An Index Mark is made automatically at the beginning of each recording. Essentially, an Index Mark is a "bookmark." Find the start of a recording by following these steps.

- 1 Press **VCR**, then press **SEARCH** until the **INDEX SEARCH** screen appears.

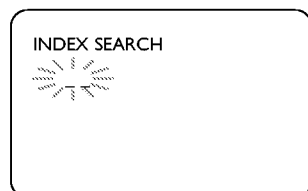

- 2 Within 30 seconds, press **▲** or **▼** until the number of programs you want to skip appears beneath **INDEX SEARCH**. Include the current program in your number.

- 3 Within 30 seconds, press **◀** (for a reverse search) or **▶** (for a forward search). When the tape finishes rewinding or forwarding, playback will start. The program numbers will count down beneath **INDEX SEARCH** during the search. If the end of the tape is reached during the search, the search will stop and the tape may rewind. *Details are on page 44.* Recordings should be at least one minute long in SP speed, two minutes in LP, and three minutes in SLP. Otherwise, the Index Mark will not be available. *Details on tape recording speeds are on page 72.*

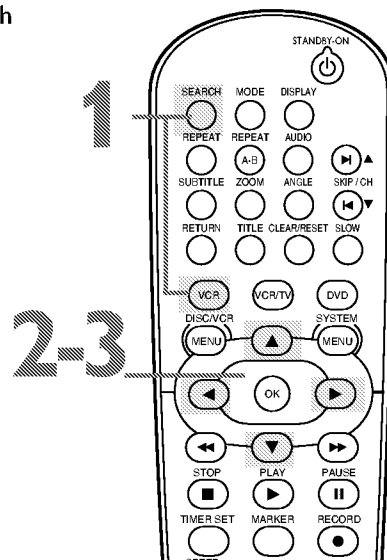
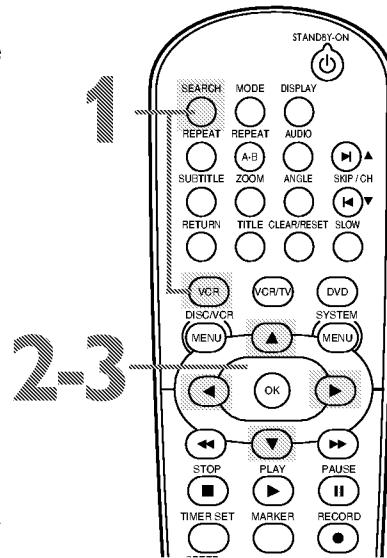

Helpful Hints

- Time Search and Index Search are not available during recording.
- To remove a Search display, press **CLEAR/RESET**.
- To cancel a search, press **STOP** ■.

Special Effects Playback 43

- Before you begin, press VCR so the VCR light appears on the front of the DVD/VCR.

Forward and Reverse Searching (SP/LP/SLP)

- 1 During tape playback, press and release **▶▶** or **◀◀**. A fast forward or reverse picture search will begin.
- 2 To return to playback, press **▶**.

Super High Speed Searching (LP/SLP)

- 1 During tape playback, press **▶▶** or **◀◀**, then press again. The search speed will increase. Repeatedly pressing **▶▶** or **◀◀** will switch between regular and high speed searching.
- 2 To return to normal playback, press **▶**.

Viewing a Still Picture

- 1 During tape playback, press **⏸**. A still picture will appear on the screen.
- 2 To advance the still picture one frame at a time, press **⏸** repeatedly.
- 3 To release the still picture and return to playback, press **▶**.

Viewing a Slow Motion Picture

- 1 During tape playback, press **⏪**. The tape will play in slow motion.
- 2 To return to normal playback, press **▶**.

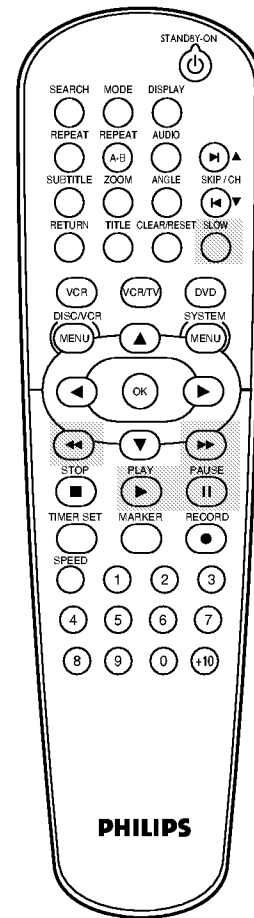



Helpful Hints

- Slow and Still modes will switch to Stop mode after five minutes to protect the DVD/VCR and the tape from damage.
- SP/LP/SLP means this feature will work with tapes recorded in Standard Play, Long Play, or Super Long Play. LP/SLP means this feature will work with tapes recorded in Long Play or Super Long Play. Tape speed details are on page 72.

44 Automatic Operation Features

The following tape features are available in VCR mode. Press VCR so the VCR light appears on the front of the DVD/VCR, if necessary.





Automatic Playback

When you put a tape in the DVD/VCR, the power will come on. If the tape's record tab is missing, playback will begin. If a timer recording is set and  is flashing in the display panel, the power will not come on automatically when you insert a tape with the record tab intact. If a timer recording is set and  is flashing in the display panel, the DVD/VCR will eject the tape if the record tab is missing.

Automatic Rewind, Eject

When a tape is played, fast forwarded, or recorded to its end, the tape will rewind to the beginning, stop, and eject itself. This feature does not operate if AUTO REPEAT is ON. *Details are on page 40.*

Tape Eject

A tape can be ejected with the DVD/VCR power on or off (but the DVD/VCR must be plugged in). If a timer recording is set and  appears on the display panel, pressing STOP/EJECT  (VCR) will turn on the DVD/VCR and/or cancel the timer recording. The  will turn off. Press STOP/EJECT  (VCR) again to remove the tape. Remember to insert a tape and press TIMER SET to reset the timer recording.

Automatic Tracking Adjustment

The VCR adjusts tracking automatically to give you the best possible picture quality. With some recordings, however, you may get a better picture using manual tracking.

Manual Tracking

To manually adjust the tracking during normal playback and slow motion playback of a videotape, press SKIP▶/CH ▲ or SKIP◀/CH ▼ on the remote. Tracking will return to Automatic Tracking when you press STOP  or insert a tape. You can also press SKIP▶/CH ▲ or SKIP◀/CH ▼ to remove vertical jitter in a Still picture.

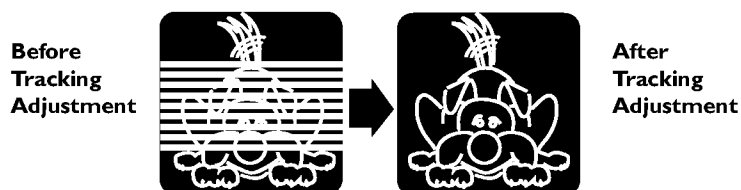

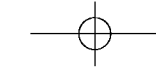

Multi-Channel Television Sound 45

.....
Your DVD/VCR can play tapes recorded in Hi-Fi (high fidelity) stereo, which produces a crisp, clear sound from the left and right audio channels. Your DVD/VCR also can play tapes recorded in a second audio (usually, that means your program is recorded in a second language). Of course, your DVD/VCR will play tapes recorded in monaural (single-source) sound as well.

Your DVD/VCR also will record on a video cassette in Hi-Fi stereo or in second audio, so when you play that tape on the DVD/VCR, it will be in stereo or second audio.

Read the directions on this page to familiarize yourself with the stereo and second audio setups. Then follow the directions on page 46 to record in stereo or second audio, or follow the directions on page 47 to play tapes recorded in Hi-Fi stereo.

Understanding Displays

When you watch TV channels through the DVD/VCR, portions of the display shown below will appear when you press DISPLAY twice.

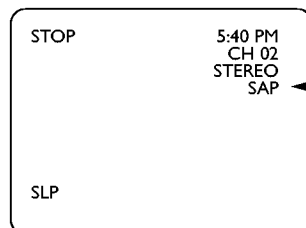

If SAP or STEREO appears, the program is available in second audio or stereo. Even though a program is available in second audio or stereo, you must program the DVD/VCR to receive or record the program. Follow the directions on page 46.
This display is not available during tape playback.

To play programs in stereo, connect the DVD/VCR to a Stereo or TV as described on pages 11 and 14. You will use the red and white AUDIO OUT jacks on the DVD/VCR.

46 Multi-Channel Television Sound (cont'd)

To set the DVD/VCR to receive programs in stereo or second audio, follow these steps.

1 Press **VCR**, then press **DISC/VCR/MENU** so MENU appears.

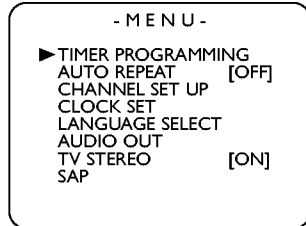

2 Press **▲** or **▼** to select **TV STEREO** or **SAP** (Second Audio Program). Press **▶** so **ON** appears beside your selection.

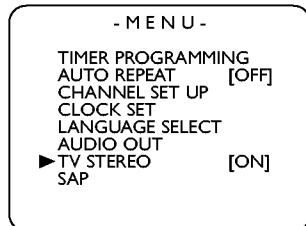

3 Press **DISC/VCR/MENU** to remove the menu.

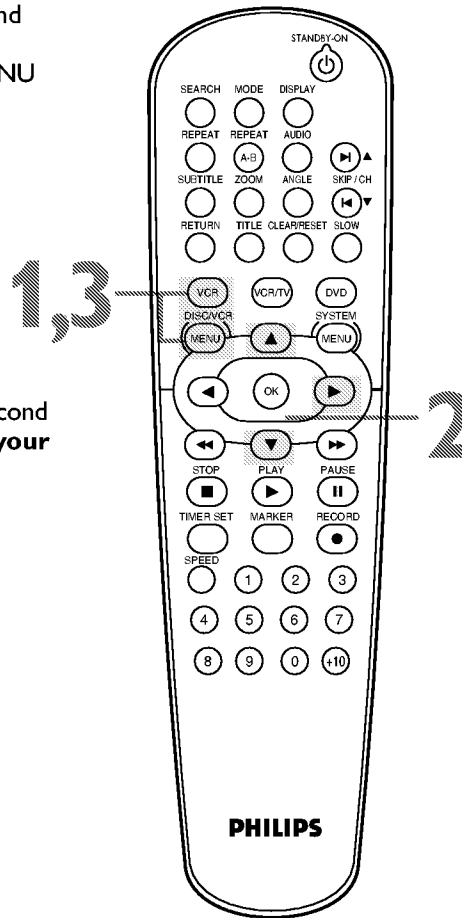

Helpful Hints

- You can only receive and record in stereo or second audio programs that are broadcast in stereo or second audio. You can only play a tape in Stereo or second audio if it was recorded in stereo or second audio. Please see page 45 to determine if the program is in stereo or second audio.
- If SAP is ON but the program is not broadcast in Second Audio, you will hear and record the program in normal audio.

Hi-Fi Stereo 47

Multi-Channel Television Sound system broadcasts are recorded in Hi-Fi stereo. To play in Hi-Fi stereo the tapes recorded in Hi-Fi stereo, follow these steps.

- 1 Press **VCR**, then press **DISC/VCR/MENU** so MENU appears.

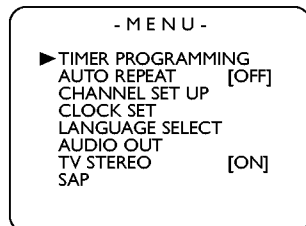

- 2 Press **▲** or **▼** to select **AUDIO OUT**. Then, press **▶**.

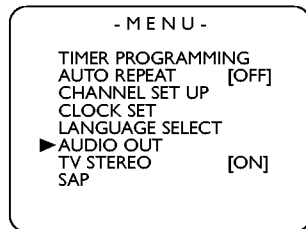

- 3 Press **▲** or **▼** to select **HIFI**. ON will appear beside HIFI.

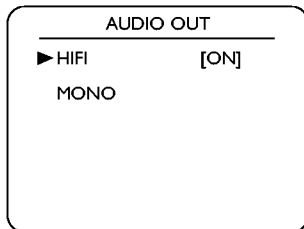

- 4 Press **DISC/VCR/MENU** to remove the menu.

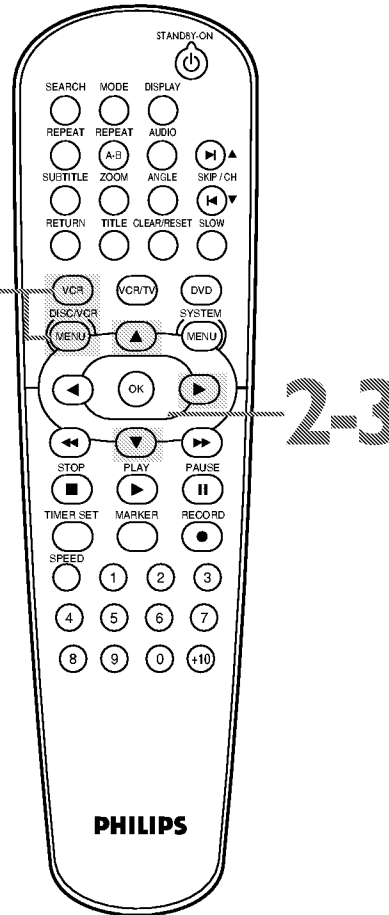

Helpful Hints

- Programs are recorded in both Hi-Fi stereo sound and in monaural (single-channel) sound.
 - The audio level of a tape recorded in Hi-Fi stereo will differ from the audio level of a tape not recorded in Hi-Fi stereo.
 - You can change to MONO if you want monaural audio playback. Follow steps 1-2, then press **▲** or **▼** to select MONO at step 3. Press **DISC/VCR/MENU**. HIFI will disappear from the status display.
 - If you play non-Hi-Fi tapes while AUDIO OUT is set to HIFI, HIFI will not appear on the status display. The tape will play in monaural sound.
- Please see additional notes on page 77.**

48 DVD Disc Menus

DVDs contain menus that describe the contents of the DVD or allow you to customize DVD playback. For example, the menu may offer choices for subtitle languages, special features, or scene selection. To use the DVD Disc menu and select playback features, follow these steps.

- 1 Press **DVD** to put the DVD/VCR in DVD mode. The DVD light will appear on the front of the DVD/VCR.
- 2 Press **DISC/VCR/MENU**. The DVD's main Disc menu will appear.
- 3 Press **▲, ▼, ◀, or ▶** to select an item, then press **OK**. Continue this process to set up all the features you want.

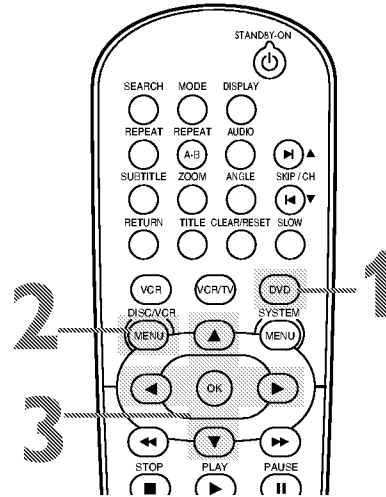

Using the Title Menu

Some DVDs have a Title Menu, which lists the Titles available on the DVD. Use the Title Menu to play a specific Title.

- 1 Press **DVD** to put the DVD/VCR in DVD mode. The DVD light will appear on the front of the DVD/VCR.
- 2 Press **TITLE**. The Title menu will appear. If a Title menu is not available, the "X" may appear on the TV screen. Or, if the DVD only has a main Disc menu as described above, it may appear when you press TITLE.
- 3 Press **▲, ▼, ◀, or ▶** to select a Title, then press **OK**. Play will begin at the Title you selected.

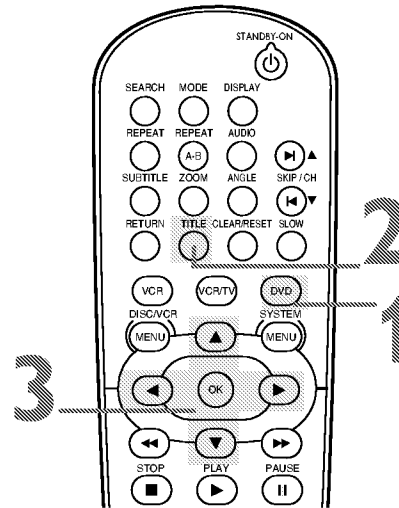

Helpful Hints

- Menus vary among DVDs. Follow the information accompanying the DVD.
- Not all DVDs have Disc or Title menus.
- Some DVDs may refer to Chapters as "scenes." Some DVDs may refer to the Title Menu as the "scene index."
- The TITLE button will not be active with all DVDs.

Fast Forward/Reverse Search 49

1 Press DVD to put the DVD/VCR in DVD mode. The DVD light will appear on the front of the DVD/VCR.

2 During playback, press ►► or ◀◀. Use ►► for a forward search. Press ◀◀ for a reverse search.

- During DVD playback, pressing ►► or ◀◀ will forward or reverse the picture at approximately two, eight, 50, or 100 times the normal playback speed. The speed may vary depending on the Disc.

An ►► 1, ►► 2, ►► 3, or ►► 4 will indicate fast forward searching.

An ◀◀ 1, ◀◀ 2, ◀◀ 3, or ◀◀ 4 will appear briefly on the TV screen to indicate fast reverse searching. Sound will be mute during searching.

- For Audio CDs, the approximate searching speed is 16 times the normal play speed. An ►► or ◀◀ will appear briefly on the TV screen. Sound will be intermittent during searching on an Audio CD.

- During Video CD play, pressing ►► or ◀◀ will forward or reverse the picture at approximately two, eight, or 30 times the normal play speed. The speed may vary depending on the Disc.

An ►► 1, ►► 2, or ►► 3 will indicate fast forward searching.

An ◀◀ 1, ◀◀ 2, or ◀◀ 3 will appear briefly on the TV screen to indicate fast reverse searching.

- For MP3, the approximate search speed is eight times the normal play speed. An ►► or ◀◀ will appear briefly on the TV.

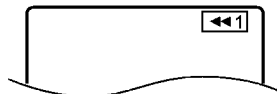

Example: Playing a DVD in reverse at twice the normal playing speed.

3 Press PLAY ► to return to normal playback.

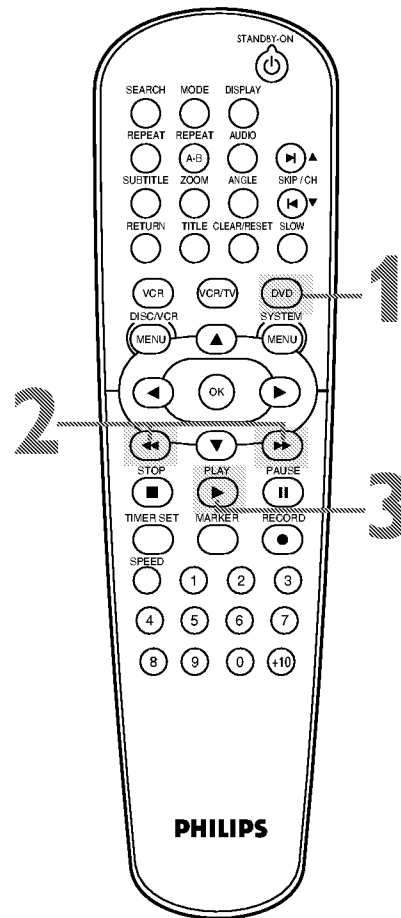

50 Title/Chapter Playback, Specific Time Playback

Title/Chapter Playback

- 1 Press **DVD** to put the DVD/VCR in DVD mode. The DVD light will appear on the front of the DVD/VCR.
- 2 During DVD playback, press **SEARCH** until CH (for Chapter) or TT (for Title) appears on the TV. The number of available Titles or Chapters will appear at the right (/4, for example).
- 3 Enter the Title or Chapter number using the **Number** buttons. The Title or Chapter will play.
 - To select a single-digit Track number when there are more than 10 tracks, press **OK** to play the Track.
 - If you enter a Track number that is not available on the Disc, play will not begin (or the current Track will continue to play).

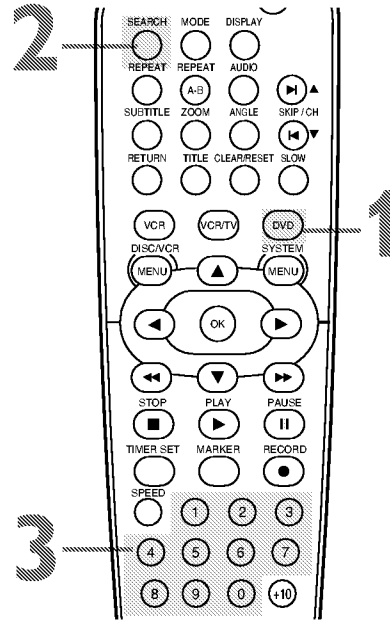
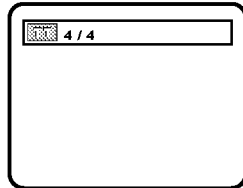
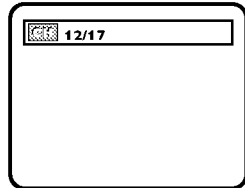

Specific Time Playback

- 1 Press **DVD** to put the DVD/VCR in DVD mode. The DVD light will appear on the front of the DVD/VCR.
- 2 During DVD, Audio CD, or Video CD (without PBC) play, press **SEARCH** until the Time Search display appears.

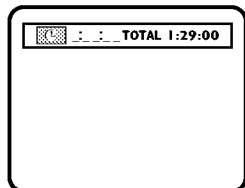

- 3 Within 30 seconds, use the **Number** buttons to enter the elapsed playing time (of the Track or Title) at which you want play to begin. Enter the time in hours, minutes, and seconds. Within a few seconds, play will start at the specified time.
 - Example: 1 hour, 23 minutes, and 30 seconds
1 → 2 → 3 → 3 → 0
 - Make sure the time you enter is within the total time of the current Title or Track. If it is not, the time space will clear and play will continue at its current point. The total time available in the current Track or Title will appear in the Time Search display.
 - If you make a mistake entering the time, press **CLEAR/RESET** to clear the time area. Enter the correct information.

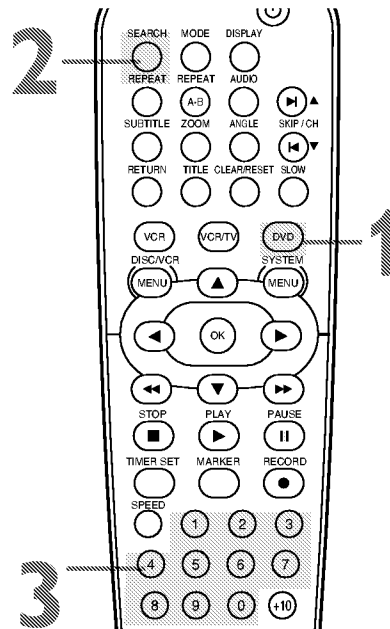

Helpful Hints

- When play is stopped, use the **Number** buttons to select a Title for immediate play. During play, use the **Number** buttons to choose a Chapter for immediate play.
- Title/Chapter playback is not available with some DVDs.

Track Playback 51

There are three ways to play a specific Audio CD, Video CD (without PBC), MP3, or JPEG Track: Use the Number buttons, the SEARCH button, or SKIPSKIP ►/CH ▲ and SKIP ◀/CH ▼.

• Before you begin, press DVD so the DVD light appears on the front of the DVD/VCR.

A

Using the Number Buttons

Press the Number buttons to enter a Track number. Play will start at the selected Track.

For Tracks 10 and above, press the +10 button so the Search display (TR __ /12 - an example of total tracks) appears on the TV. Press the Number button of the first digit, then press the Number button of the second digit. For example, to play Track 26, press +10, then Number 2, then Number 6.

For single-digit Tracks (1-9), press a single Number button.

If you enter a Track number that is not available on the Disc, play will not begin (or the current Track will continue to play).

B

Using SEARCH

Press SEARCH so the Track Search display (TR) appears.

Within 30 seconds, press the Number buttons to select the Track number. Play will begin at the selected Track. For a single-digit Track (1-9), enter a zero first. For example, to play Track 5, press 0, 5. You do not have to use the +10 button in Search Mode.

C

Using SKIP ►/CH ▲ or SKIP ◀/CH ▼

During play, press SKIP ►/CH ▲ to skip the current Track and move to the next Track. The Track number will appear briefly on the DVD/VCR display panel.

Or, during play, press SKIP ◀/CH ▼ to return to the beginning of the current Track. Press SKIP ◀/CH ▼ repeatedly to go to previous Tracks. The Track number will appear briefly on the DVD/VCR display panel.

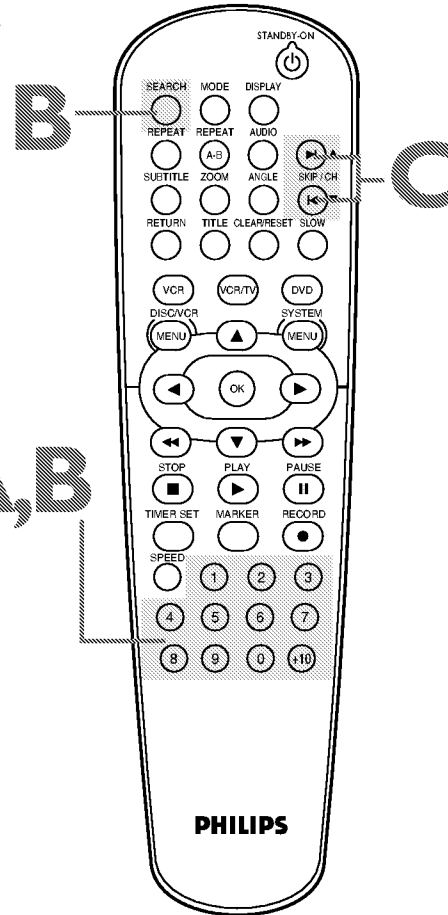

Helpful Hint

- You cannot use SKIP ►/CH ▲ to go from the last Track on the Disc to the first Track.

52 Paused and Step-by-Step Playback, Resume On

Paused and Step-by-Step Playback

- 1 Press **DVD** to put the DVD/VCR in DVD mode. The DVD light will appear on the front of the DVD/VCR.
- 2 During playback, press **PAUSE** **||**. Play will pause and the sound will be mute.
- 3 Press **PAUSE** **||** repeatedly to see a DVD or Video CD picture advance one frame (or step) at a time. The sound will remain mute. Pressing **PAUSE** **||** repeatedly during Audio CD, MP3, or JPEG play will have no effect.
- 4 Press **PLAY** **▶** to resume play.

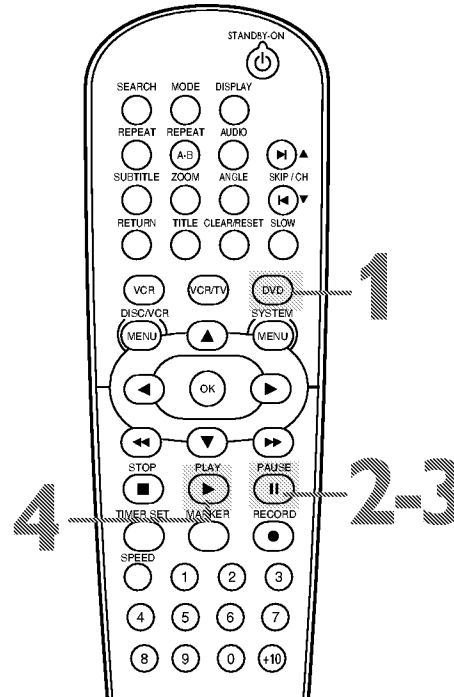

Resume On

- 1 Press **DVD** to put the DVD/VCR in DVD mode. The DVD light will appear on the front of the DVD/VCR.
- 2 Press **STOP** **■** during playback. In a few seconds, the following Resume message will appear on the TV screen.

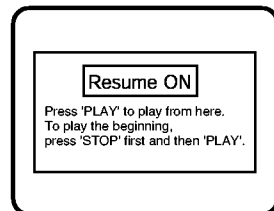

- 3 Press **PLAY** **▶**. In a few seconds, play will resume from the point at which it stopped last. You can resume playing at the same point even if you turn off the DVD/VCR, then turn it on again later. However, opening the disc tray will cancel the Resume feature. Play will start at the beginning the next time you insert the Disc. For MP3, play will resume from the beginning of the current Track. To cancel Resume and start playing the Disc from the beginning, press **STOP** **■** a second time while playback is stopped. The Stop symbol (■) will appear briefly on the TV screen. Press **PLAY** **▶** to start playing the Disc from the beginning.

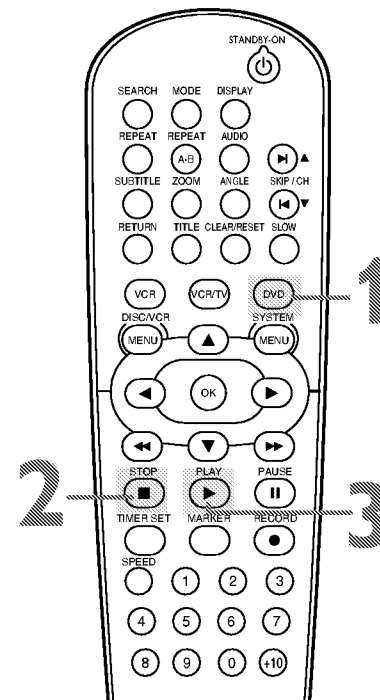

Helpful Hint

- Set **STILL MODE** to **FIELD** in the **DISPLAY** menu if paused images are blurry. Details are on pages 64-65.

Repeat, A-B Repeat 53

Repeat

- 1 Press **DVD** to put the DVD/VCR in DVD mode. The DVD light will appear on the front of the DVD/VCR.
- 2 During play, press **REPEAT** until the repeat mode you want appears on the TV.
On a DVD, select **CHAPTER**, **TITLE**, or **OFF**. On an Audio CD and Video CD (without PBC), select **TRACK**, **ALL** (all Tracks on the Disc), or **OFF**. With MP3 or JPEG files, select **TRACK**, **GROUP** (all Tracks in the current folder), or **ALL**. Selecting a new Track, Chapter, or Title will cancel repeat play.

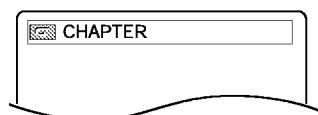

Example: Repeat a DVD Chapter

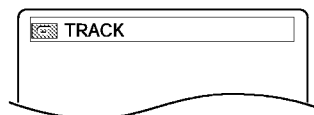

Example: Repeat an Audio CD or Video CD Track

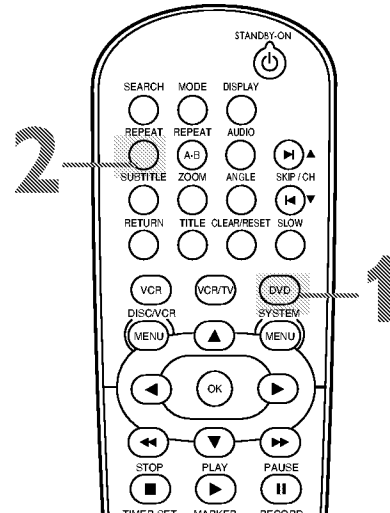

A-B Repeat

Follow these steps to play a section of a DVD, Audio CD, or Video CD repeatedly.

- 1 Press **DVD** to put the DVD/VCR in DVD mode. The DVD light will appear on the front of the DVD/VCR.
- 2 Press **PLAY** to play the Disc to the point at which you want repeated play to begin.
- 3 Press **A-B REPEAT** to set the starting point (A).
A - will appear on the TV screen.
- 4 Play or fast forward the Disc to the point at which you want repeated play to end, then press **A-B REPEAT** again. A-B will appear on the TV. The section will begin to play repeatedly.
- 5 To cancel A-B Repeat, press **A-B REPEAT**. OFF will appear on the TV screen. Regular play will resume.

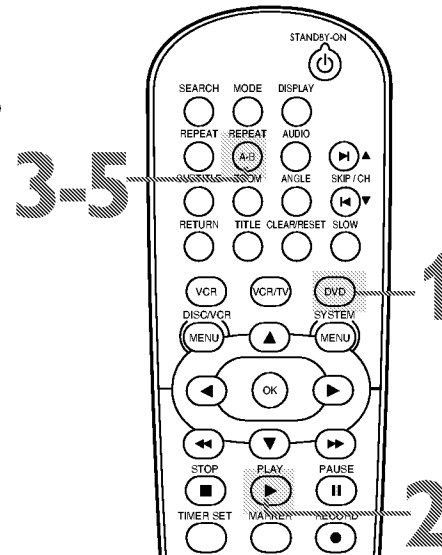

Helpful Hints

- Repeat play and A-B Repeat are not available with all Discs.
- The entire A-B Repeat section must be within a single Title or Track. If you do not enter Point B before the end of the Track or Title is reached, the end of the Track or Title will become Point B automatically.
- Point B must be later on the Disc than Point A.

54 Markers

Use Markers to remember your favorite places on a DVD, Audio CD, or Video CD (without PBC). To set the Markers, follow these steps.

• Before you begin, place the DVD/VCR in DVD mode. Press DVD so the DVD light appears on the front of the DVD/VCR.

- 1 **Play the Disc to within 30 seconds of the point at which you want to set the Marker. Press MARKER.** The markers will appear at the top of the TV screen.

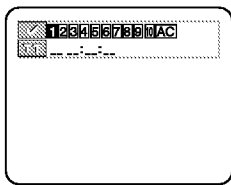

Example: DVD

- 2 **Within 30 seconds, press ◀ or ▶ to select a Marker (1-10).** Make sure __:__:__ appears beneath the number.

- 3 **Play the Disc to the point at which you want to set the Marker (up to 30 seconds away). When the Disc reaches the point you want to remember, press OK.** The Title or Track number and its elapsed playing time will appear beneath the markers.

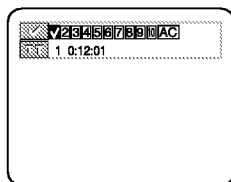

Example: DVD

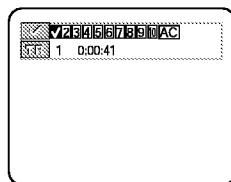

Example: Audio CD or Video CD

- 4 **To return to a Marker during play, press MARKER until you see the Markers. Press ◀ or ▶ to choose the Marker you want, then press OK.** Disc play will continue from the marked point.

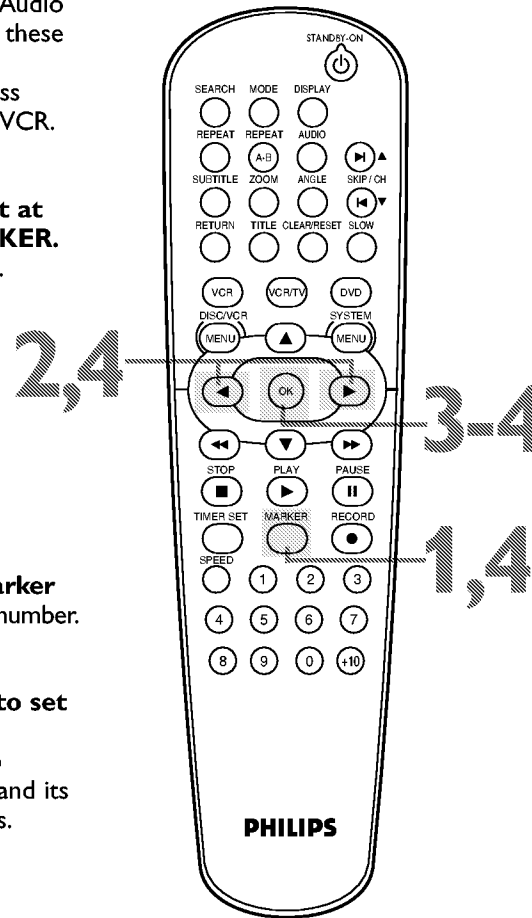

Helpful Hints

- Opening the disc tray or turning off the DVD/VCR will erase all the Markers.
- To erase a single Marker, press MARKER until you see the Markers. Press ◀ or ▶ to select a Marker. Press CLEAR/RESET. Press RETURN or MARKER to remove the display.
- To erase all the Markers, press MARKER until you see the Markers. Press ▶ to select AC, then press OK. Press MARKER or RETURN to remove the display.

Subtitles, Camera Angles 55

Subtitles

You can select a language for DVD subtitles during playback. You can select only languages that are available on the DVD.

- 1 Press **DVD** to put the DVD/VCR in DVD mode. The DVD light will appear on the front of the DVD/VCR.
- 2 During play, press **SUBTITLE** repeatedly to select a subtitle language. The number of available languages appears at the right of the subtitle display. In the example below, six languages are available (/6). After a few seconds, the subtitles will appear.
Or, press **SUBTITLE** repeatedly to turn off subtitles. When no subtitles are available, "NOT AVAILABLE" appears at the right of the subtitle display.

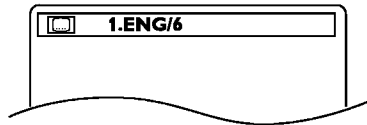

Example: English as first of six available subtitles

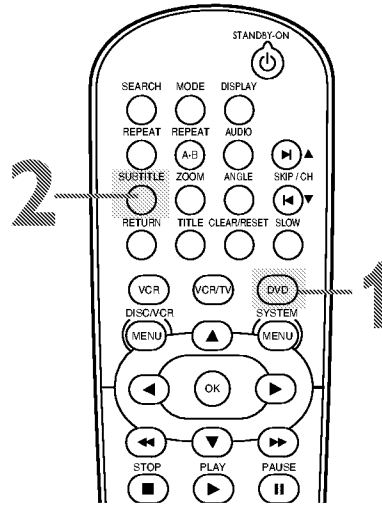

Camera Angles

Some DVDs contain scenes recorded from different angles. The camera angle will not change if the DVD does not contain sequences recorded from different perspectives.

- 1 Press **DVD** to put the DVD/VCR in DVD mode. The DVD light will appear on the front of the DVD/VCR.
- 2 During DVD play, press **ANGLE** repeatedly to select a different angle. The number of available angles appears at the right of the Angle display. In this example, eight angles are available (/8).

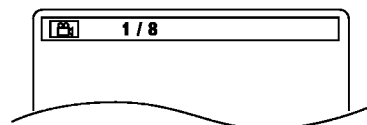

Example: Angle 1 of eight available angles

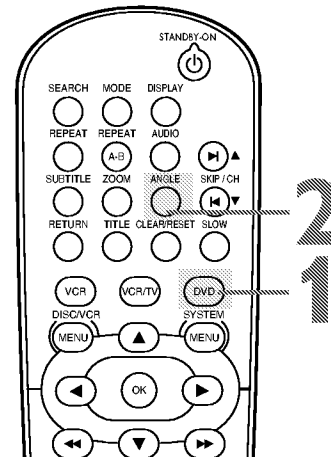

Helpful Hints

- On some DVDs, you must select a subtitle language in the Disc menu.
- If the language does not appear after pressing **SUBTITLE** several times, the Disc does not have subtitles in that language.
- Opening the disc tray will cancel your subtitle setting.
- If the current portion of the Disc has multiple camera angles,  will appear on the TV screen. **ANGLE ICON** must be **ON**. Details are on pages 64-65.

56 Parental Controls Password

Parental Controls prevents viewing of DVDs that exceed your rating limits. This feature will not limit viewing if the DVD is not rated or coded. Check your DVDs and settings before letting children access the DVD/VCR. Follow these steps to change your password.

1 Press **DVD** to put the DVD/VCR in DVD mode. The DVD light will appear on the front of the DVD/VCR. Press **STOP** to stop Disc playback.

2 Press **SYSTEM/MENU**.

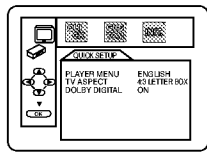

3 Press **Left** or **Right** to select **CUSTOM**, then press **OK**.

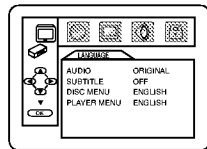

4 Press **Left** or **Right** to select **Lock** (the lock), then press **OK**. The first time you set a password, this menu will appear.

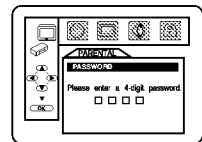

Press the **Number** buttons to enter a four-digit password. The password will appear on the screen. Write it down so you don't forget it. Press **OK**. You are finished! Go to step 7.

If you have set a password before, this menu will appear.

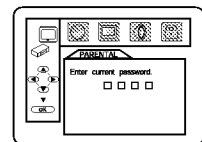

Press the **Number** buttons to enter your current four-digit password. Asterisks (*) will appear instead of your password. This protects its identity.

5 Press **Down** to select **CHANGE**, then press **OK**.

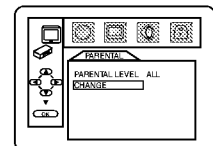

6 Press the **Number** buttons to enter a four-digit password. The password numbers will appear on the screen. Write down the password so you will not forget it. Press **OK**. The previous menu will reappear.

7 Press **SYSTEM/MENU** to remove the menu.

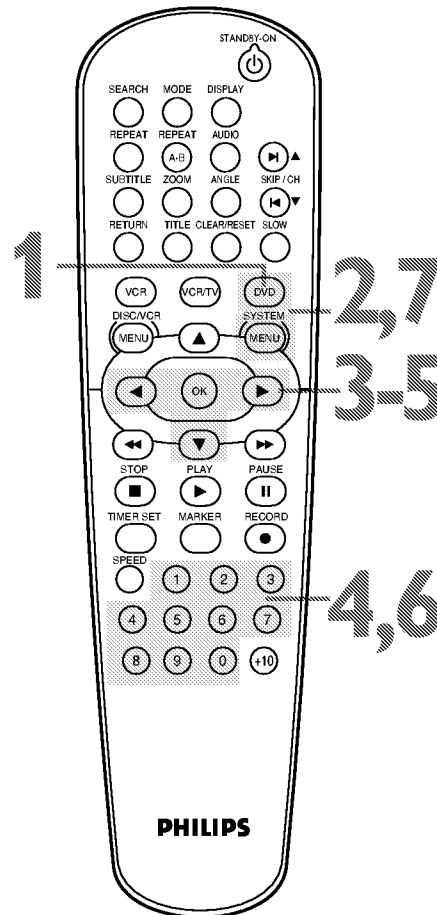

Helpful Hints

- The default password is 4737. If you forget your password, press Number buttons 4, 7, 3, 7 at step 4. You will be prompted to enter a new four-digit password. Use the Number buttons to enter a new four-digit password, then press OK. PARENTAL LEVEL will reset to ALL. See page 57 to reset PARENTAL LEVEL as you desire.
- A power failure will not erase your password.

Parental Levels 57

Follow these steps to set the rating level for your DVDs. DVDs whose ratings exceed the level you set will not play.

1 Press **DVD** to put the DVD/VCR in DVD mode. The DVD light will appear on the front of the DVD/VCR. Press **STOP** to stop Disc playback if necessary.

2 Press **SYSTEM/MENU**.

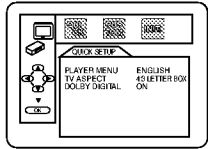

3 Press **◀** or **▶** to select **CUSTOM**, then press **OK**.

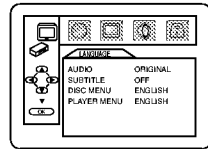

4 Press **◀** or **▶** to select **8** (the lock), then press **OK**.

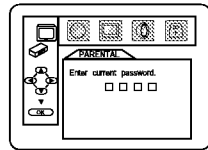

5 Press the **Number** buttons to enter your four-digit password.

6 Press **▲** or **▼** to select **PARENTAL LEVEL**, then press **OK**.

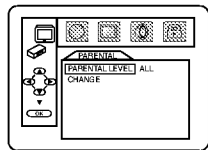

7 Press **▲** or **▼** to select a level, then press **OK**. The rating levels continue on two menu screens. Press **▲** or **▼** repeatedly to move to the next or previous screen to find the rating level you want. After making your selection, the previous menu will appear. The level you selected will appear beside **PARENTAL LEVEL**.

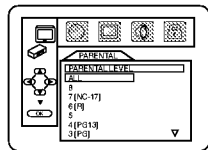

8 Press **SYSTEM/MENU** to remove the menu.

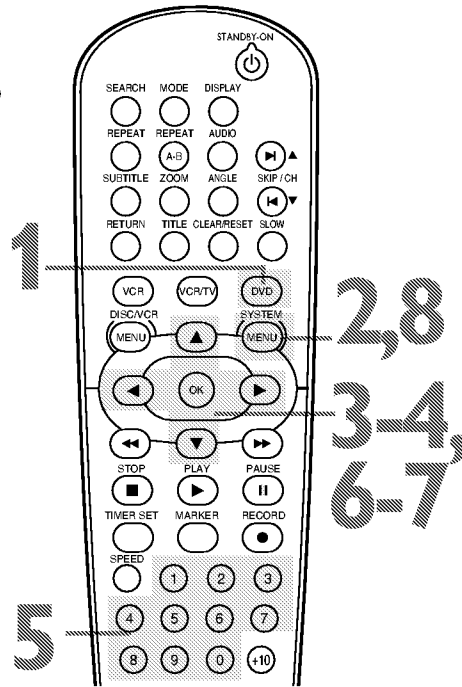

RATING EXPLANATIONS

- **ALL** - Parental Controls is inactive; all discs can play.
- **8** - Adult material
- **7** - NC-17 - Not appropriate for children under 17
- **6** - R - Restricted; parental approval required for viewers under 18.
- **4** - PG13 - Unsuitable for children under 13
- **3** - PG - Parental Guidance suggested.
- **1** - G - General Audience; recommended for all ages.

Helpful Hints

- When you try to play a DVD whose rating exceeds the level you set, an on-screen message will indicate the DVD cannot play. Remove the DVD, then set **PARENTAL LEVEL** to **ALL**. Reload the DVD and begin playback. Some DVDs may let you enter your four-digit password to begin playback. Follow the on-screen messages as prompted.
- You cannot use the default password (4737) to play a DVD.

58 Audio Language, Stereo Sound Mode

Audio Language

You can select a language for DVDs during playback if multiple languages are available.

- 1 Press **DVD** to put the DVD/VCR in DVD mode. The DVD light will appear on the front of the DVD/VCR.
- 2 During DVD playback, press **AUDIO** repeatedly to choose one of the available languages. The new audio will be heard. The display will disappear after about five seconds. The Audio display may show if the DVD has Dolby Digital or multi-channel (5.1 CH) sound or its sampling rate (48 k, for example). The number of available languages appears after the “ / ” at the right of the display (/3, for example).

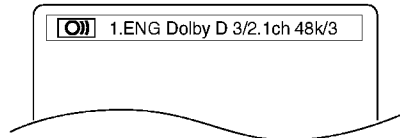

Example: English audio

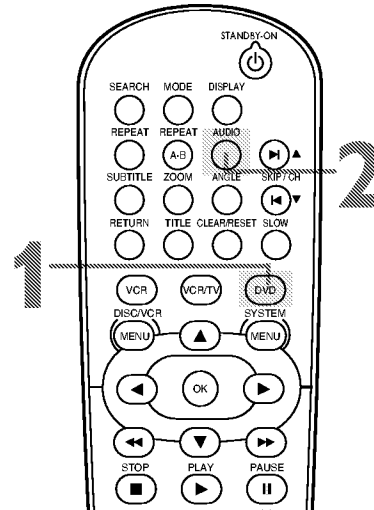

Stereo Sound Mode

Adjust Stereo Sound to determine whether you will hear the left channel, the right channel, or both channels (stereo) during Audio CD or Video CD playback.

If you connected the DVD/VCR to a Stereo using the COAXIAL DIGITAL AUDIO OUT jack as described on page 15, or if you connected to a TV with only the RF coaxial cable, you cannot adjust Stereo Sound Mode.

- 1 Press **AUDIO** repeatedly during Audio CD or Video CD play to choose **STEREO**, **L-CH**, or **R-CH**.

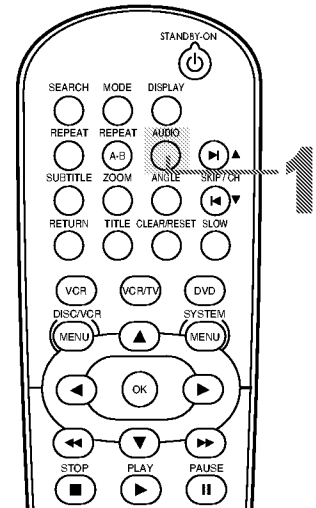
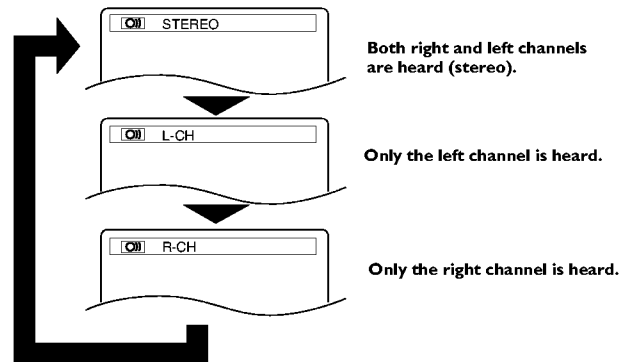

Helpful Hints

- If a language is not available after pressing **AUDIO** several times, the DVD does not have that language.
- Some DVDs only let you change the language in the Disc menu.
- Audio languages may be abbreviated (such as *ENG* for English). Or, three dashes (---) may appear instead of an abbreviation.
- You cannot adjust the Stereo Sound Mode when Virtual Surround is active. Details are on page 70.

DVD Slow Motion, Zoom 59

Slow Motion

- 1 Press **PAUSE** during DVD or Video CD play.
- 2 Press **▶▶** or **◀◀**. Slow motion play will begin. Press **▶▶** or **◀◀** repeatedly during slow motion play to play a DVD forward or backward at approximately 1/16, 1/8, or 1/2 the normal speed. Reverse slow motion is not available on a Video CD.
An **▶ 1 (1/16)**, **▶ 2 (1/8)**, or **▶ 3 (1/2)** will appear briefly on the TV screen to indicate slow forward play.
An **◀ 1 (1/16)**, **◀ 2 (1/8)**, or **◀ 3 (1/2)** will indicate slow reverse play.

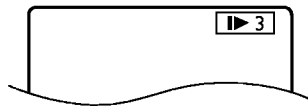

Example: Playing a DVD forward at half the normal speed.

- 3 Press **PLAY** to return to normal play.

Zoom

You can enlarge a DVD, Video CD, or JPEG picture to two or four times larger than normal.

- 1 Press **ZOOM** during playback or when play is paused. The picture will appear twice as large. Press **ZOOM** again to make the picture four times larger than normal. Either x2 or x4 will appear beside the zoom icon on the TV screen.
- 2 While the picture is enlarged, press **▲**, **▼**, **◀**, or **▶** to move the zoomed image up, down, left, or right. The gray box with an inner blue box that shows during Zoomed playback is the position guide. To remove it or show it, press **OK**. The position of the blue box inside the gray box indicates the position of the zoomed image within the overall picture.

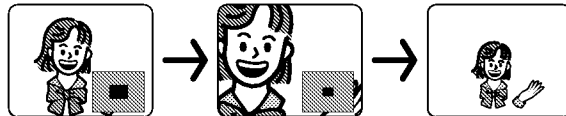

- 3 To return the picture to normal, press **ZOOM**.

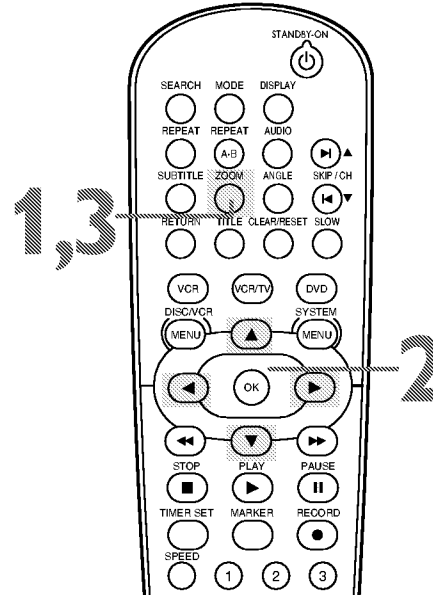
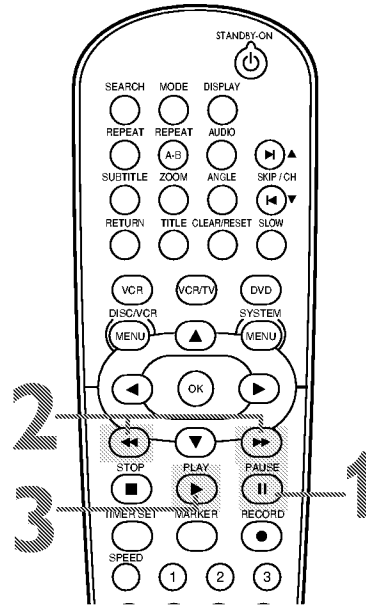

Helpful Hints

- The sound will be mute during slow motion play.
- The **SLOW** button on the remote does not activate slow motion of Discs.
- The x4 zooming is not active with some Discs. Only x2 zooming is available for Video CDs and JPEGs.

60 Programmed Playback

You may determine the order in which Audio CD, MP3, or JPEG Tracks will play. To set a Program, follow these steps.

1 Press DVD to put the DVD/VCR in DVD mode. The DVD light will appear on the front of the DVD/VCR.

2 While playback is stopped, press MODE. The PROGRAM screen will appear.

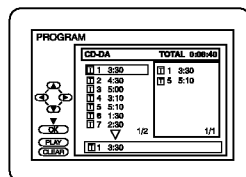

Example: Audio CD

3 Press ▲ or ▼ to select a track you want to play, then press OK. Repeat this step until you have selected all the Tracks you wish to play in the Program. Press CLEAR/RESET to erase the last Track in the Program if you make an error.

Additional Tracks may be on other screens. Press ▼ or ▲ to see all the Tracks.

To see Tracks in a Program when there are more than eight tracks, use SKIP ►/CH ▲ and SKIP ◀/CH ▼ to see all the Tracks.

While an MP3/ JPEG folder is open, press ◀ or ► to go to the previous or next level of Files or Folders. Press TITLE to return to the first item in the highest level of Files or Folders.

4 Press PLAY ►. The Tracks will play once in the order you set. Turning off the DVD/VCR or opening the disc tray will erase the Program.

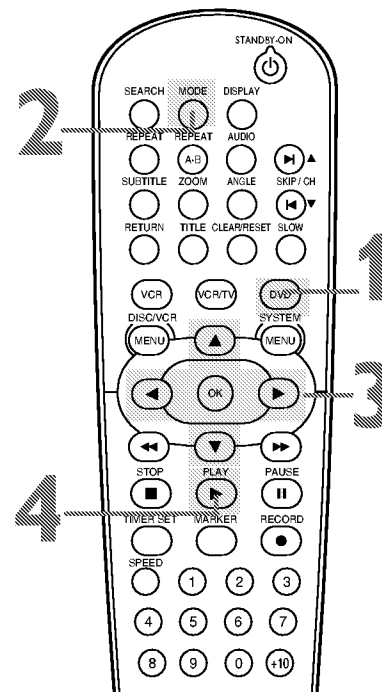

Helpful Hints

- You cannot use the Number buttons or SEARCH to select another Track while playing a Program. Use SKIP ►/CH ▲ or SKIP ◀/CH ▼ to select other Tracks in a Program.
- You cannot combine Random play with a Program.
- You may play a Program or a Track within a Program repeatedly. During Program play, press REPEAT so ALL (all Tracks in the Program) or TRACK appears. The entire Program or the current Track will play over and over.
- You cannot alter a Program during play.
- You can start Program play only while in the PROGRAM screen.
- A Program can have a maximum of 99 Tracks.
- To erase all Tracks in the Program, select ALL CLEAR at step 3.

Random Playback 61

You may play Audio CD, JPEG, or MP3 Tracks in Random order instead of the order in which they are recorded (1,2,3...).

1 Press **DVD** to put the DVD/VCR in DVD mode. The DVD light will appear on the front of the DVD/VCR.

2 While play is stopped, press **MODE** twice so the **RANDOM** screen appears.

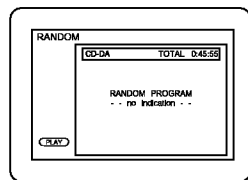

Example: Audio CD

3 While the **RANDOM** screen appears, press **PLAY** ►. The Tracks will play in random order. After all the Tracks play once, play will stop.

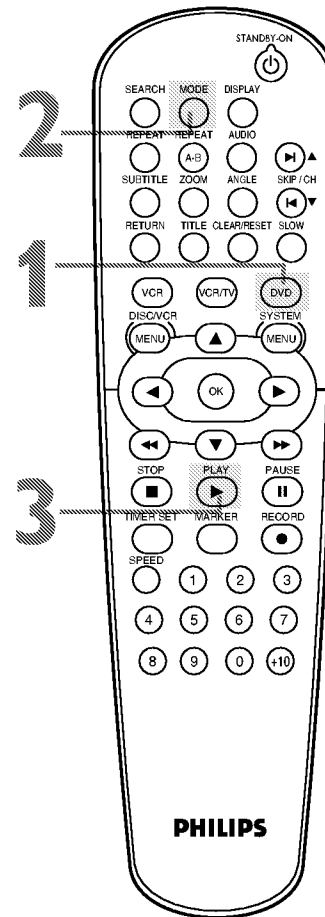

62 MP3/JPEG Playback

The DVD Player will play MP3 and JPEG files that you record and finalize on a CD-RW (Compact Disc-Rewritable) or CD-R (Compact Disc-Recordable).

These Discs may contain pictures in a JPEG format or audio Tracks in an MP3 format. You may copy or download MP3 music files from certain legal Internet sites, then copy those files onto a CD-R or CD-RW.

You cannot make or record such Discs using this DVD/VCR. See your computer manual for details on recording.

Keep these characteristics in mind when making Discs you intend to play on the DVD Player of this DVD/VCR.

- Record MP3 Tracks at a sampling frequency of 44.1 kHz or 48 kHz. Record in a constant bit rate between 112 kbps and 320 kbps.
- When recording JPEG Files, the size of the picture should be between 32 x 32 and 6300 x 5100 dots.

1 Press DVD to put the DVD/VCR in DVD mode. The DVD light will appear on the front of the DVD/VCR.

2 When you put a CD-RW or CD-R with MP3 or JPEG files in the DVD/VCR and press MENU, the File List will appear on the TV screen.

Press ▲ or ▼ to select a Folder, MP3 Track, or JPEG File.

3 **If you choose a Track or File, press PLAY ► or OK.** Starting with the Track or File you selected, the Tracks/Files will play in the order they were recorded, i.e. 1, 2, 3,...



If you select a Folder and press OK, the Tracks or Files within that Folder will appear. Press ▲ or ▼ to select the Track or File you want, then press PLAY ► or OK.

- Press TITLE to return to the first item in the highest level of Folders or Files.
- Press ◀ or ▶ to return to previous or next levels.
- During JPEG play, press MODE to choose a transition mode (Cut In/Out or Fade In/Out). If you chose Cut In/Out, the images will cut in and out sharply as play progresses. If you choose Fade In/Out, then the images fade in and out as play progresses. Press MODE again to remove the transition modes.
- During JPEG play, press ► or ◀ to rotate a picture 90 degrees clockwise or counter-clockwise.

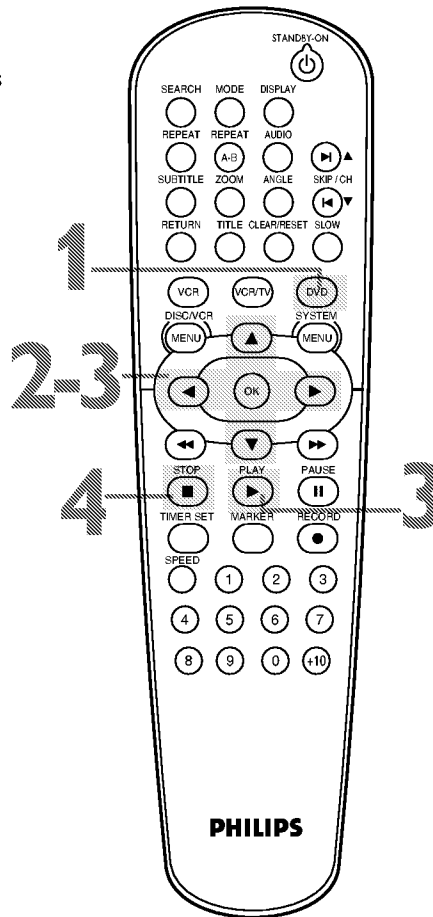
4 **To stop play, press STOP ■.**



Helpful Hints

- JPEG images and MP3 Tracks are known as Files. Groups of Files are called Folders.
- Folders have the  icon.
- MP3 Tracks have the  icon.
- JPEG Files have the  icon.
- A maximum of 255 Folders can be recognized. A maximum of 512 Files can be recognized.
- During play, use the Number buttons or SKIP ►/CH ▲ and SKIP ◀/CH ▼ to change Tracks.
- If a Track is not available, "X" will appear on the TV. Play may resume at an incorrect Track or may continue with its current Track.
- Specific Time play is not possible with MP3 Tracks.

MP3/JPEG Displays 63

You can review MP3 and JPEG information during play.

- Before you begin, place the DVD/VCR in DVD mode. Press DVD so the DVD light appears on the front of the DVD/VCR.

1 Press DISPLAY during play. The current Track name will show on the TV screen.

2 Press DISPLAY again. The current Track number, total Tracks available, and elapsed playing time of the current Track will appear (MP3 only).

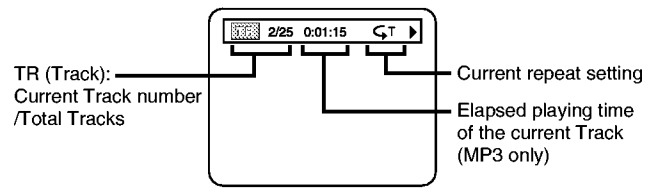

The following may appear to indicate Repeat play.

- ↺ T: The current Track will play repeatedly.
- ↺ G: Tracks in the current Folder will play repeatedly.
- ↺ A: All Tracks will play repeatedly.

3 Press DISPLAY again to remove the display.

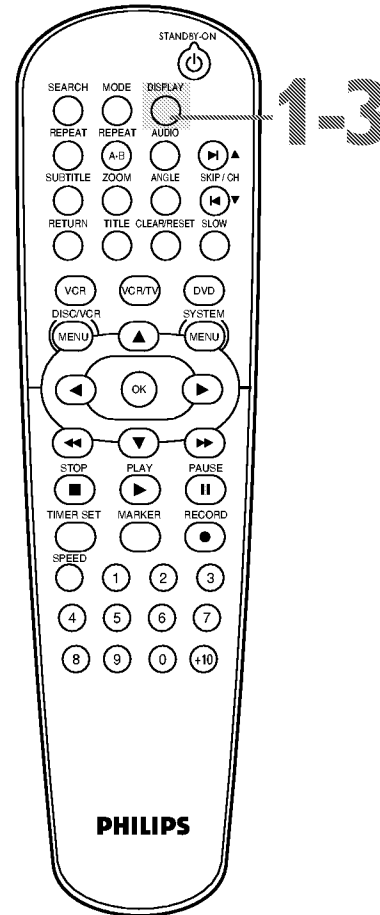

64 Display

You can change the TV Aspect ratio, Still Mode clarity, Angle Icon availability, Automatic Power Off, and Progressive Scan features of the DVD Player in the Display menu.

1 Press DVD to put the DVD/VCR in DVD mode. The DVD light will appear on the front of the DVD/VCR.

2 When play is stopped, press SYSTEM/MENU. The QUICK SETUP screen will appear.

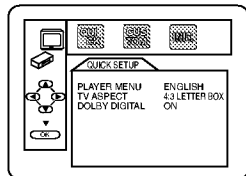

3 Press ◀ or ▶ to select **CUSTOM** at the top of the menu, then press **OK**.

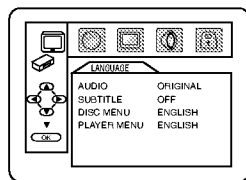

4 Press ◀ or ▶ to select **□ (display)**, then press **OK**.

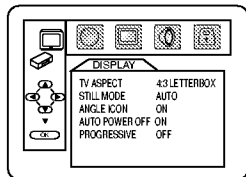

5 Press ▲ or ▼ to select an item, then press **OK**.
 • If you selected **TV ASPECT**, press ▲ or ▼ to select a setting, then press **OK**.

Choose **4:3 LETTER BOX** if you want to see the entire, widened picture with black bars at the top and bottom of the screen. This looks like the picture you see when watching movies in a theater. This setting is possible only if the DVD was recorded in the letterbox or widescreen format.

Choose **4:3 PAN & SCAN** for a full height picture, with both sides trimmed. Some companies refer to this as reformatting the picture to fit your TV screen and may call it the regular or normal format.

Choose **16:9 WIDE** if a widescreen TV is connected to the DVD/VCR.

• If you selected **STILL MODE**, press ▲ or ▼ to select a setting, then press **OK**.

This function allows you to adjust the quality of a still image. **AUTO** is the default setting.

If you select **FIELD**, still images will be stabilized but coarse due to the small amount of data.

If you select **FRAME**, still images will be highly defined due to the simultaneous output of two fields.

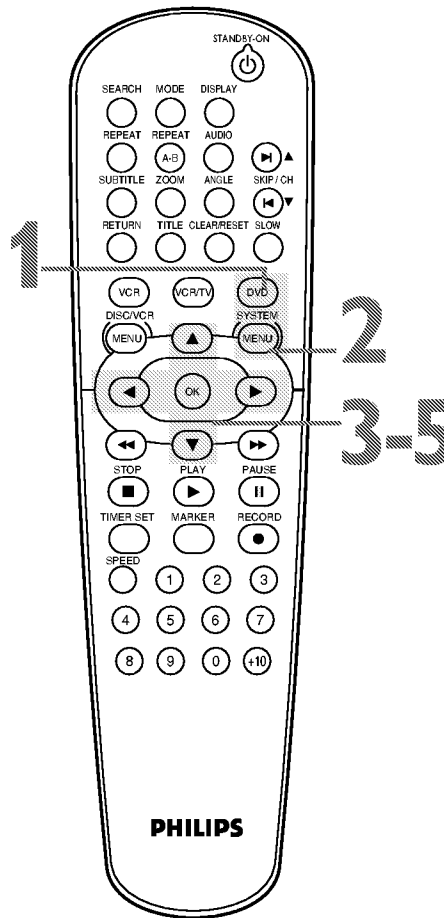

Helpful Hints

- Selecting a different TV ASPECT setting is only effective if it is available on the DVD. Check the DVD Disc menu or case for details.
- You also can adjust TV ASPECT in the QUICK SETUP menu that appears when you first press the SYSTEM/MENU button. With QUICK selected, press OK. Press ▼ to select TV ASPECT, then press OK. Press ▲ or ▼ to choose a setting, then press OK. Press SYSTEM/MENU to remove the menu.

Display (cont'd) 65

- If you selected **ANGLE ICON**, press **OK** repeatedly to turn it ON or OFF. The default setting is ON. Choose ON to see the Angle icon when multiple camera angles are available during DVD playback. Details are on page 55. Choose OFF to disable the Angle icon.
- If you selected **AUTO POWER OFF**, press **OK** repeatedly to turn it ON or OFF. The default setting is ON. Choose ON if you want the DVD/VCR to switch to VCR mode automatically if there is no activity at the DVD Player for 35 minutes.
- If you chose **PROGRESSIVE**, press **OK** repeatedly to turn PROGRESSIVE ON or OFF. The default setting is OFF. Choose ON if your TV has Progressive Scan and if the TV is connected to the Player's COMPONENT VIDEO OUT jacks. Choose OFF otherwise.

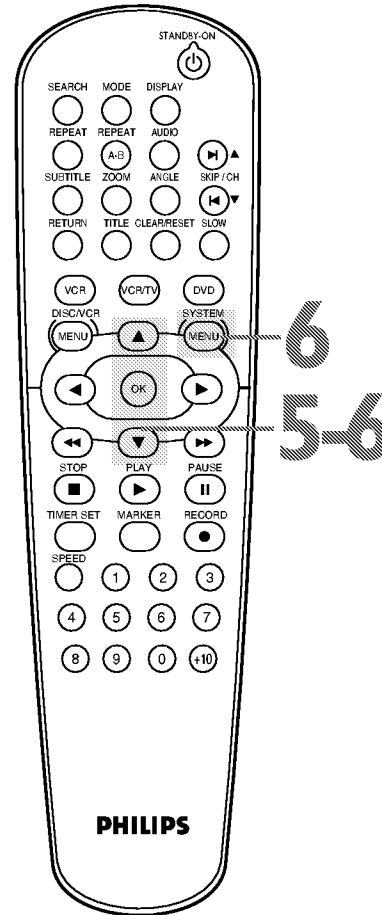
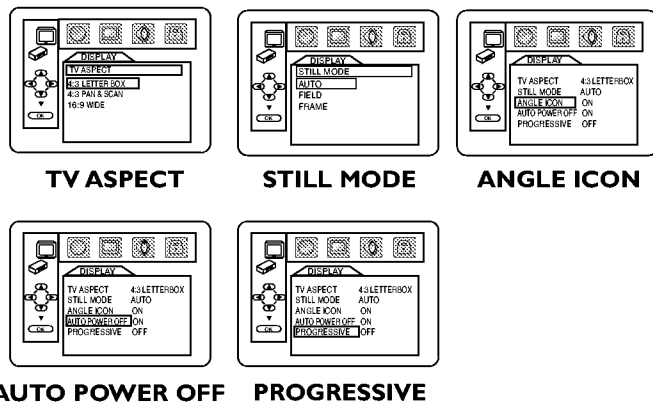

6 Press **SYSTEM/MENU** to remove the menus.

- If **PROGRESSIVE** is ON, this message appears:

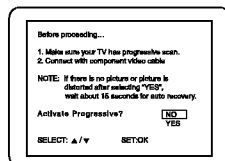

Press **▲** or **▼** to make a selection, then press **OK**. If you select **NO**, the menu disappears and **PROGRESSIVE** is **OFF**. If you select **YES**, this appears:

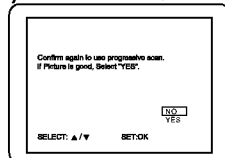

Confirm your setting, then press OK. The menu will disappear and **PROGRESSIVE** will be **ON**. If you do not press any buttons for 15 seconds, the Progressive Scan will switch to **OFF**.

Helpful Hints

- You can set **PROGRESSIVE** to **OFF** either in the **DISPLAY** menu or by pressing and holding the **PLAY ►** (DVD) button on the front of the DVD/VCR for more than five seconds.

66 Language

You can use the LANGUAGE settings to select different languages for the Audio or Subtitles of DVDs, as well as languages for DVD Disc menus and the menus of the DVD Player SETUP menus.

1 Press **DVD** to put the DVD/VCR in DVD mode. The DVD light will appear on the front of the DVD/VCR.

2 While playback is stopped, press **SYSTEM/MENU**. The QUICK SETUP screen appears.

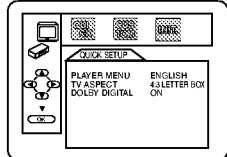

3 Press **◀** or **▶** to select **CUSTOM** at the top of the menu, then press **OK**.

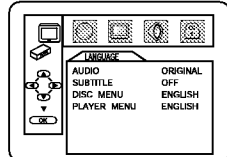

4 The Language menu () will be selected. Press **OK**.

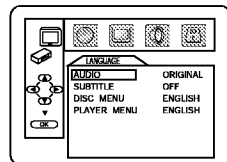

5 Press **▲** or **▼** to select **AUDIO**, **SUBTITLE**, **DISC MENU**, or **PLAYER MENU**. Then, press **OK**. The language options for the selected item will appear.

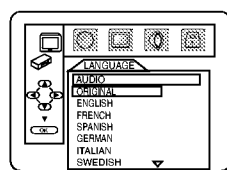

AUDIO: The DVD's audio plays in the selected language.

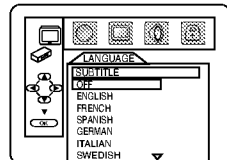

SUBTITLE: Subtitles appear in the chosen language.

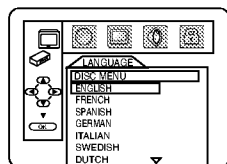

DISC MENU: A DVD's Disc menu appears in the chosen language.

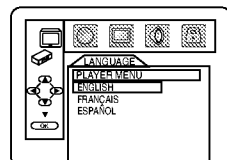

PLAYER MENU: The DVD Player's Setup menu can be in English, French, or Spanish only.

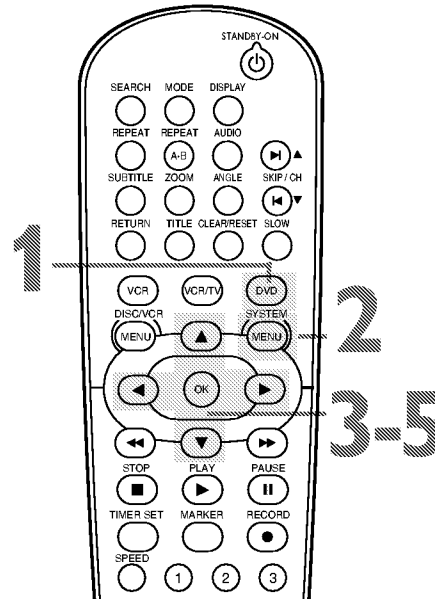

Helpful Hints

- If the DVD's default settings for Audio and Subtitle are the same language, the subtitles may not show unless you turn them on.
- Use the **AUDIO** and **SUBTITLE** buttons to select Audio and Subtitles available on the DVD. Details are on pages 55 and 58.
- If you set **AUDIO** to **ORIGINAL**, the default setting of the DVD Audio will play.
- If you set **PLAYER MENU** to **FRANÇAIS** (French), or **ESPAÑOL** (Spanish) and need English: Follow steps 1-3. At step 4, the **IDIOMA** or **LANGUE** menu will appear. Press **OK**. Press **▼** to select **MENU DU LECTEUR** or **MENU REPRODUC.**, then press **OK**. Press **▲** to select **ENGLISH**, then press **OK**. The menus will change to English. Press **SYSTEM/MENU** to remove the menus.
- You can change the **PLAYER MENU** language in the **QUICK SETUP** menu that appears when you first press **SYSTEM/MENU**. With **QUICK** selected, press **OK**. **PLAYER MENU** will be selected. Press **OK**. Press **▲** or **▼** to choose a language, then press **OK**. Press **SYSTEM/MENU** to remove the menu.

Language (cont'd) 67

6 Press **▲** or **▼** to select a language, then press **OK**. The language list continues on multiple screens. Press **▲** or **▼** to move to the other screens.

7 If you select **OTHER** for **AUDIO**, **SUBTITLE**, or **DISC MENU**, press four Number buttons to enter the code for the language you desire. Use the Language Codes below. The language or language code you select will appear in the Language menu beside **AUDIO**, **SUBTITLE**, or **DISC MENU**.

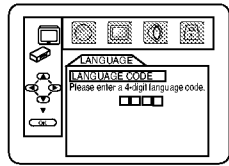

8 You can select other languages for **AUDIO**, **SUBTITLE**, and **DISC MENU** only if the language is available on the Disc. If the language you select is not recorded on the DVD, changing these settings will have no effect.

9 Press **SYSTEM/MENU** to remove the menu.

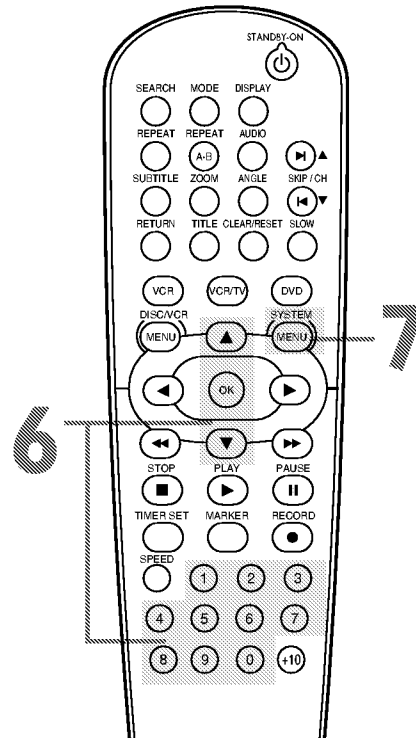

Language Codes

A-B	English	5160	Kannada	5760	Punjabi	6247	T		
Abkhazian	4748	Esperanto	5161	Kashmiri	5765	Pashto	6265	Tagalog	6658
Afar	4747	Estonian	5166	Kazakh	5757	Persian	5247	Tajik	6653
Afrikaans	4752	F-H		Kinyarwanda	6469	Polish	6258	Tamil	6647
Albanian	6563	Faroese	5261	Kirghiz	5771	Portuguese	6266	Tatar	6666
Amharic	4759	Fiji	5256	Kirundi	6460	Pushto	6265	Telugu	6651
Arabic	4764	Finnish	5255	Korean	5761	Quechua	6367	Thai	6654
Armenian	5471	French	5264	Kurdish	5767	Rhaeto-Romance	6459	Tibetan	4861
Assamese	4765	Frisian	5271	L-N		Romanian	6461	Tigrinya	6655
Aymara	4771	Gaelic (Scots)	5350	Laothian	5861	Russian	6467	Tonga	6661
Azerbaijani	4772	Galician	5358	Latin	5847			Tsonga	6665
Bangla	4860	Georgian	5747	Latvian	5868	S		Turkish	6664
Bashkir	4847	German	5051	Lettish	5868	Samoan	6559	Turkmen	6657
Basque	5167	Greek	5158	Lingala	5860	Sangho	6553	Twi	6669
Bengali	4860	Greenlandic	5758	Lithuanian	5866	Sanskrit	6547	U-Z	
Bhutani	5072	Guarani	5360	Macedonian	5957	Serbian	6564	Ukrainian	6757
Bihari	4854	Gujarati	5367	Malagasy	5953	Serbo-Croatian		Urdu	6764
Bislama	4855	Hausa	5447	Malay	5965		6554	Uzbek	6772
Breton	4864	Hebrew	5569	Malayalam	5958	Sesotho	6566	Vietnamese	6855
Bulgarian	4853	Hindi	5455	Maltese	5966	Setswana	6660	Volapuk	6861
Burmese	5971	Hungarian	5467	Maori	5955	Shona	6560	Welsh	4971
Byelorussian	4851	I-K		Marathi	5964	Sindhi	6550	Wolof	6961
C-E		Icelandic	5565	Moldavian	5961	Singhalese	6555	Xhosa	7054
Cambodian	5759	Indonesian	5560	Mongolian	5960	Siswat	6565	Yiddish	5655
Catalan	4947	Interlingua	5547	Nauru	6047	Slovak	6557	Yoruba	7161
Chinese	7254	Interlingue	5551	Nepali	6051	Slovenian	6558	Zulu	7267
Corsican	4961	Inupiak	5557	Norwegian	6061	Somali	6561		
Croatian	5464	Irish	5347	O-R		Spanish	5165		
Czech	4965	Italian	5566	Occitan	6149	Sundanese	6567		
Danish	5047	Japanese	5647	Oriya	6164	Swahili	6569		
Dutch	6058	Javanese	5669	Oromo (Afan)	6159	Swedish	6568		

68 Audio

Change Audio settings based on other equipment you connected to the DVD/VCR or according to your Disc sound features. These settings only affect the Audio from the DVD Player of the DVD/VCR.

1 Press **DVD** to put the DVD/VCR in DVD mode. The DVD light will appear on the front of the DVD/VCR.

2 While play is stopped, press **SYSTEM/MENU**. The QUICK SETUP screen will appear.

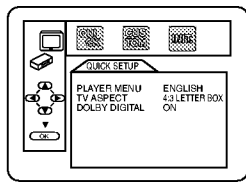

3 Press **◀** or **▶** to select **CUSTOM** at the top of the menu, then press **OK**.

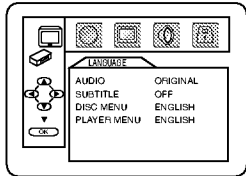

4 Press **◀** or **▶** to select **AUDIO** (). Press **OK**.

5 Press **▲** or **▼** to select **DRC**, **DOLBY DIGITAL**, or **DOWN SAMPLING**, then follow step 6 accordingly.

- 6**
- If you selected **DRC**, press **OK** repeatedly to turn Dynamic Range Control (DRC) ON or OFF. Choosing ON compresses the range of volume by suppressing loud sounds and raising low sounds. DRC is available only on Discs recorded in the Dolby Digital format.
 - If you selected **DOWN SAMPLING**, press **OK** repeatedly to choose ON or OFF. ON sets downsampling to 48 kHz. OFF sets downsampling to 96 kHz. DOWN SAMPLING is available only when the unit is connected to a Stereo using the COAXIAL DIGITAL AUDIO OUT jack.
 - If you selected **DOLBY DIGITAL**, press **OK** repeatedly to select ON or OFF. Select ON if you used the COAXIAL DIGITAL AUDIO OUT jack to connect the DVD/VCR to a stereo that is Dolby Digital compatible. Details are on page 15. Otherwise, choose OFF.

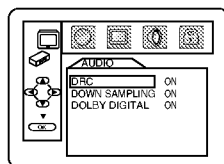

DRC

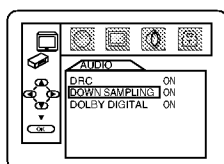

Down Sampling

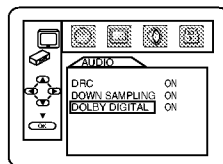

Dolby Digital

7 Press **SYSTEM/MENU** to remove the menu.

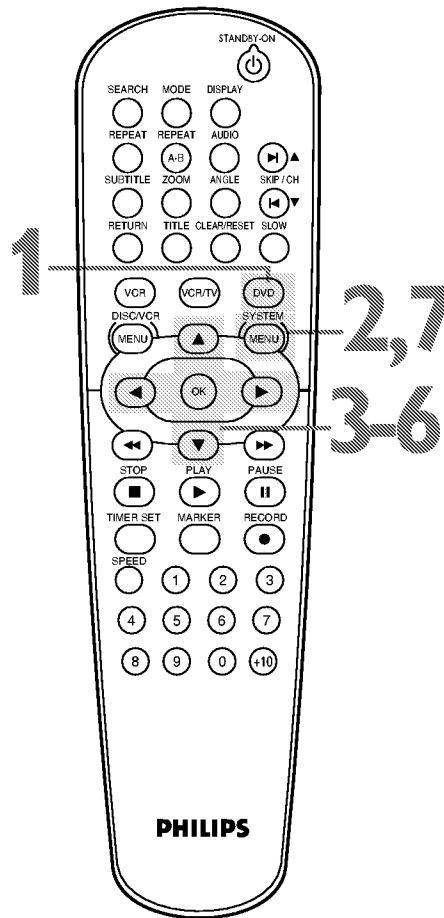

Helpful Hints

- Dolby Digital sound must be available on the DVD.
- You can adjust DOLBY DIGITAL in the QUICK SETUP menu that appears when you first press SYSTEM/MENU. With QUICK selected, press OK. Press ▼ to select DOLBY DIGITAL. Press OK to choose ON or OFF. Press SYSTEM/MENU to remove the menu.
- When you play a Disc that has copyright protection, downsampling will be at 48 kHz, even if you set DOWN SAMPLING to OFF.

On-Screen Displays 69

DVD Displays

- 1 Press **DVD** to put the DVD/VCR in DVD mode. The DVD light will appear on the front of the DVD/VCR.
- 2 Press **DISPLAY** repeatedly to see the following displays during DVD playback.

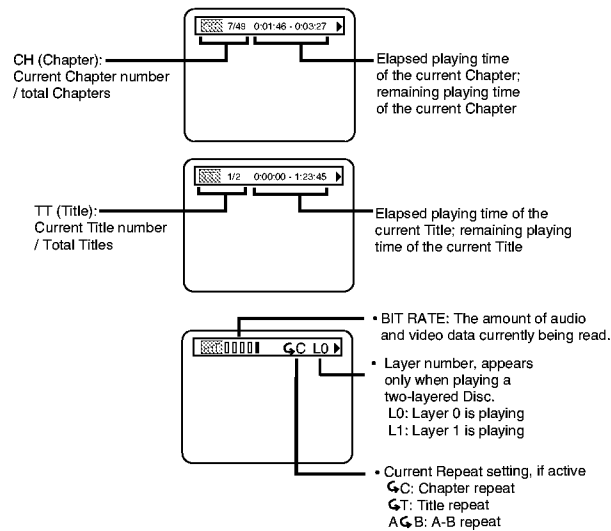

- 3 Press **DISPLAY** repeatedly or press **RETURN** to remove the display.

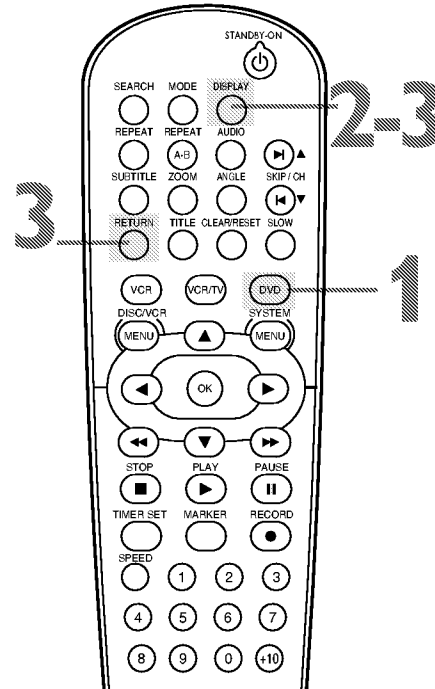

Audio CD and Video CD Displays

- 1 Press **DVD** to put the DVD/VCR in DVD mode. The DVD light will appear on the front of the DVD/VCR.
- 2 Press **DISPLAY** repeatedly to see the following displays during Audio CD or Video CD (without PBC) play.

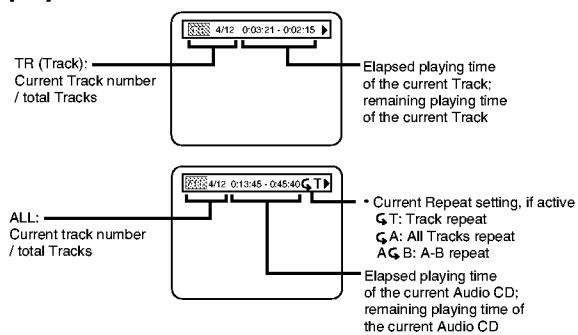

- 3 Press **DISPLAY** repeatedly or press **RETURN** to remove the display.

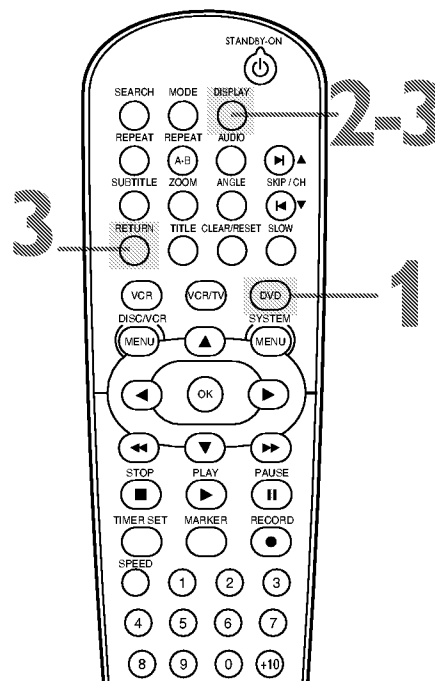

70 Black Level, Virtual Surround

Black Level

Adjust Black Level to brighten the DVD and Video CD picture during playback.

1 Press **DVD** to put the DVD/VCR in DVD mode. The DVD light will appear on the front of the DVD/VCR.

2 During DVD or Video CD play, press **MODE** so the Black Level icon shows in the top left corner of the TV screen.

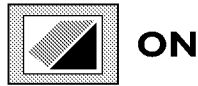

3 Within 10 seconds, press **OK** repeatedly to choose **ON** or **OFF**. **ON** brightens the dark parts of the picture. **OFF** shows the original picture as recorded.

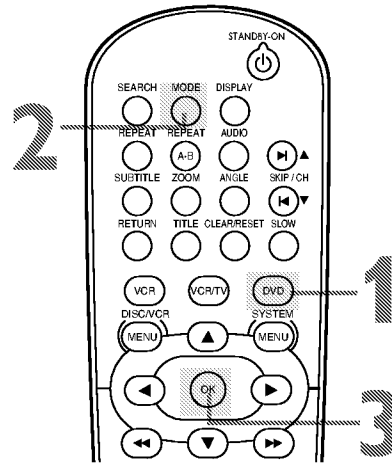

Virtual Surround

You can enjoy improved stereo sound when you play DVDs, Audio CDs, Video CDs, or MP3 files recorded in Dolby Digital or Pulse Code Modulation (PCM). Check the Disc case for details on availability.

1 Press **DVD** to put the DVD/VCR in DVD mode. The DVD light will appear on the front of the DVD/VCR.

2 During Disc play, press **MODE** so the Virtual Surround icon appears in the top left corner of the TV screen.

3 While the Virtual Surround icon appears, press **OK** to choose **1**, **2**, or **OFF**. The default setting is **OFF**. The icon will disappear after about 10 seconds.

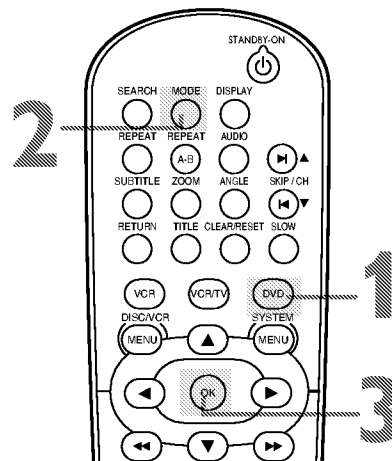

Helpful Hints

- Virtual Surround is available only when the DVD/VCR is connected to a Stereo or TV using the red and white DVD/VCR AUDIO OUT jacks on the DVD/VCR.
- Virtual Surround is active only if you set Stereo Sound Mode to Stereo. Details are on page 58.
- Virtual Surround and Black Level settings will be saved even if the DVD/VCR is turned off.

Initializing 71

Initializing

Use INITIALIZE to return all the DVD Player's Setup menu items (except for PARENTAL) to their default settings.

1 Press **DVD** to put the DVD/VCR in DVD mode. The DVD light will appear on the front of the DVD/VCR.

2 While play is stopped, press **SYSTEM/MENU**. The QUICK SETUP screen appears.

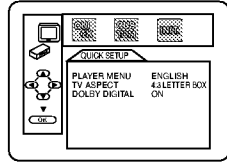

3 Press **◀** or **▶** to select **INIT. (INITIALIZE)** at the top of the menu, then press **OK**.

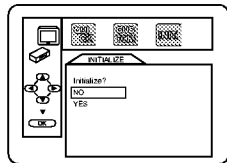

4 Press **▲** or **▼** to select **YES**. Then, press **OK** twice. To cancel, select **NO** instead.

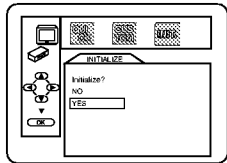

5 Press **SYSTEM/MENU** to remove the menu.

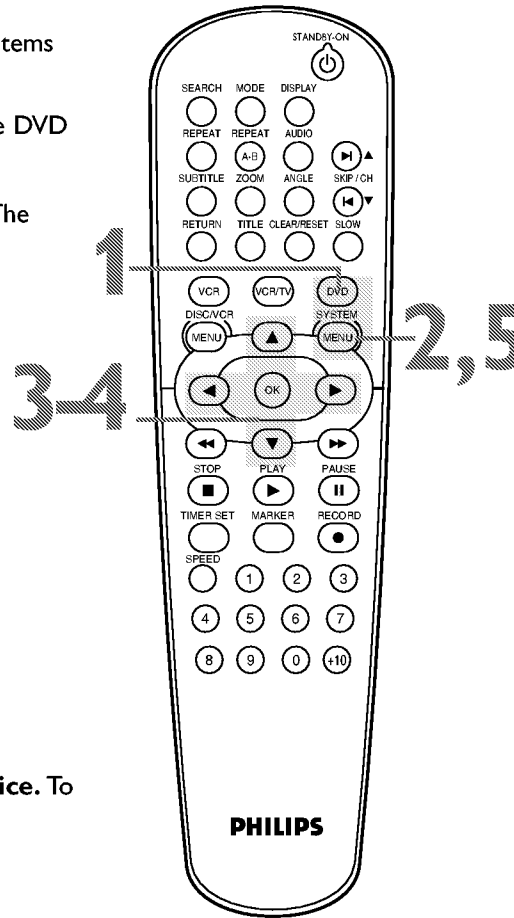

72 Glossary

AUDIO IN/OUT Jacks: jacks on the front and back of the DVD/VCR that receive audio from another source (IN) or send audio to another system (OUT). These jacks are red (right) and white (left).

Automatic Channel Setup: process in which the VCR memorizes all available TV channels. Then, when you press SKIP ►/CH ▲ or SKIP ◀/CH ▼ in VCR mode, you only scan through channels you receive.

Bands: settings that allow you to tune channels.

- **Antenna** – VHF (very high frequency; channels 2-13) and UHF (ultra high frequency; channels 14-69).
- **Cable** – standard channels 1-125 can be available without a Cable Box.

Cable Box/Satellite Receiver Output Channel: 03 or 04.

COAXIAL DIGITAL AUDIO OUT jack: Sends digital audio to a Stereo, allowing you to adjust the volume at the Stereo. This connection provides the 5.1 channel surround sound as heard in movie theaters. This jack on the DVD/VCR is black.

COMPONENT VIDEO OUT (Y C_B/P_B C_R/P_R) Jacks: jacks on the back of the DVD/VCR that send high-quality DVD video to a TV with Component Video In jacks. This connection provides the best picture quality for the DVD Player of the DVD/VCR.

Dolby Digital: A surround sound system that provides 5.1 channel sound as used in movie theaters.

Dubbing: copying a video cassette using another VCR.

HQ: high quality; a feature in the VCR circuitry which provides enhanced picture detail.

Line Input: The channel to which you set your DVD/VCR during video cassette copying. If you connected the other video equipment to the AUDIO and VIDEO In jacks on the front of the DVD/VCR, select L2. If you used the AUDIO and VIDEO IN jacks on the back of the DVD/VCR, select L1. If you accidentally enter Line Input mode, press SKIP ►/CH ▲ or SKIP ◀/CH ▼ or the Number buttons to select another channel.

OTR: One-Touch Recording; a timed recording on the VCR that starts immediately and records for 30 minutes to 8 hours.

RF coaxial cable: A black cable supplied with your DVD/VCR. Use it to connect your DVD/VCR to your TV, Cable Box, or Satellite Receiver.

S-Video: Produces a clearer DVD picture by sending separate signals for the luminance and the color. S-Video only provides a picture for the DVD Player of the DVD/VCR.

Tape Speeds: how fast the video cassette travels during a recording or playback. The faster the tape speed, the better the picture quality. Slower tape speeds affect picture quality, but you can record more onto a videotape.

- **SP** (standard play) – fastest tape speed (recording time for a T120 tape is approximately two hours); best picture quality.
- **LP** (long play) – average tape speed. You cannot record in LP with this VCR. If tapes were recorded on a different VCR in LP speed, the tape will play in LP on the DVD/VCR.
- **SLP** (super long play) – slowest tape speed (recording time for a T120 tape is approximately six hours). This speed allows the maximum recording on a single videotape.

VIDEO IN/OUT Jacks: jacks on the front and back of the DVD/VCR that receive video from another source (IN) or send video to other video equipment or a TV (OUT). These jacks are yellow.

Specifications 73

VCR Video Heads

Four heads - Hi-Fi

Antenna

VHF/UHF – 75 ohm external antenna terminal

VHF Output Signal

Channel 03 or 04

75 ohms unbalanced

DVD Color System

NTSC

Frequency Response

DVD (linear sound):

20 Hz to 22 kHz (sample rate: 48 kHz)

20 Hz to 44 kHz (sample rate: 96 kHz)

Audio CD: 20 Hz to 20 kHz

Signal-to-Noise Ratio

Audio CD: 120 dB JEITIA

(Japan Electronics and Information Technology Industries Association)

Dynamic Range

DVD (linear sound): 102 dB

Audio CD: 99 dB (JEITIA)

Total Distortion Factor

Audio CD: 0.003% (JEITIA)

DVD: 0.0025%

Wow and Flutter

Below the measurement limitation

($\pm 0.001\%$ W PEAK) (JEITIA)

Power Requirement

120V AC $\pm 10\%$, 60 Hz $\pm 0.5\%$

Power Consumption

Power on: 21 W

Power off: 3.6 W

Operating Temperature

41°F (5°C) to 104°F (40°C)

Relative Humidity

30% to 80%

Dimensions

17-3/16" (W) x 3-3/4" (H) x 9-3/16" (D)

(435mm x 94mm x 233mm)

Weight

6.0 lbs. (2.7 kg.)

NOTE: Designs and specifications are subject to change without notice.

74 Helpful Hints

If you are having problems with your product, check this list of problems and possible solutions before requesting service. You may be able to solve the problem yourself.

If you need to call a customer service representative, please know the model number and serial number of your product before you call. This information is displayed on the back of the product. Also, please take a moment to identify the problem you are having, and be prepared to explain this to the representative. If you believe the representative will need to help you with operations, please stay near the product. Our representatives will be happy to assist you.

The DVD/VCR has no power.

- Make sure the power cord is connected completely to an AC (alternating current) outlet.
- Press the STANDBY-ON  button to turn on the DVD/VCR. The DVD/VCR usually turns on in the mode it was in when you turned it off. If there has been a power failure, it will turn on in VCR mode. Press DVD to put the unit in DVD mode. Press VCR to put the unit in VCR mode. Or, press SOURCE on the front of the DVD/VCR to switch between the two modes.

The remote control will not operate the DVD/VCR.

- Aim the remote control directly at the remote sensor on the front of the DVD/VCR, not toward the TV. *Details are on page 22.*
- Remove all obstacles between the remote control and the DVD/VCR.
- Inspect and/or replace the batteries in the remote control. *Details are on page 16.*
- Use the remote control within 23 feet of the DVD/VCR.
- When using the DVD Player, press the DVD button, then try the other DVD feature buttons. Press DVD so the DVD light appears on the front of the DVD/VCR. This means the DVD/VCR is in DVD mode.
- To use the VCR, press VCR, then try the other VCR feature buttons. Press VCR so the VCR light appears on the front of the DVD/VCR. This means the DVD/VCR is in VCR mode.

There is no picture in DVD mode.

- Make sure the video cable is connected correctly. You may connect either the yellow video cable (supplied), an optional S-Video cable, or optional component video cables. Make sure the TV is set to the correct Video In channel (usually the AUX IN, A/V IN, Auxiliary In, EXT or External In, Component Video In, or S-Video In channel). Check your TV owner's manual for details. *Details are on pages seven and 11-15.*
- If you only used the supplied black RF coaxial cable, *details are on pages 8-10.* Make sure the TV is set to channel 3 or 4 (the output channel of the DVD/VCR). Or, if you have a Cable Box/Satellite Receiver, make sure the TV is set to the Cable Box/Satellite Receiver output channel (usually 03 or 04).
- Insert a DVD that is playable on this DVD/VCR. *Details are on page six.*
- Make sure the DVD/VCR is in DVD mode. Press DVD or SOURCE so the DVD light appears on the front of the DVD/VCR.
- Check if Progressive Scan is set correctly according to your connection to a TV. *Details are on page seven.* Enable Progressive Scan at the DVD Player only if you used the Component Video connection to a TV that has Progressive Scan. *Details are on pages seven, 12, and 64-65*

Disc cannot be played.

- Insert a playable Disc. *Details are on page six.*
- Place the Disc correctly in the Disc tray. If the Disc is one-sided, place the Disc in the tray with the label facing up. If the Disc is two-sided, make sure the label of the side you want to play is facing up.
- Clean the Disc. Make sure the Disc is not scratched or warped.
- Cancel the Parental Controls, enter the password, or change the control level. *Details are on pages 56-57.*
- Make sure the Disc is labelled for use in Region 1 or ALL regions and is NTSC or PAL compatible. *Details are on page six.*

Helpful Hints (cont'd) 75

There is no sound.

- Connect the audio cables firmly. Make sure the cables are connected to the AUDIO IN jacks on the TV or Stereo. *Details are on pages 11-14.*
- Check the audio settings of the DVD Player. *Details are on page 68.*
- Check the audio settings of the DVD. For example, you may have selected "soundtrack" playback or an unavailable sound setting (such as Dolby Digital). *Details are on pages 58 and 68.* Try other sound options provided in the DVD Disc menu.
- If you used audio cables (instead of only using the supplied black RF coaxial cable) make sure the TV or Stereo is set to the correct Audio In channel (usually the AUX IN, Auxiliary In, A/V IN, Audio In, or External In channel). See your TV or Stereo owner's manual for details.

The picture is distorted.

- Connect the DVD/VCR directly to the TV. *Details are on pages 7-15.* Do not connect the DVD/VCR to a VCR, then connect the VCR to the TV. Copyright protection systems in the VCR could distort the picture playing on the DVD/VCR.
- There are some cases where a Disc or videotape picture may be distorted slightly because of the quality in which it was recorded. This is not a malfunction of the DVD/VCR.
- Make sure the Disc is compatible with the DVD Player of the DVD/VCR. *Details are on page six.*
- If your TV is not PAL compatible, DVDs recorded in the PAL color system may play only in black and white, the picture may roll continuously, or the picture may appear distorted.

You cannot change the camera angle of a DVD.

- The DVD might not contain segments recorded from different camera angles. See if multiple angles are available by referring to the Disc case or DVD Disc menu. *Details are on page 55.*

You cannot change the audio or subtitle language of a DVD.

- The DVD does not contain audio or subtitles in the desired language. Not all DVDs contain audio or subtitles in multiple languages. See if other languages are available by referring to the Disc case or DVD Disc menu. *Details are on pages 55 and 58.*

An X appears in the top right corner of the TV screen when you try a DVD feature.

- The operation is not available at the current time or the feature is not available on the Disc. Some features are only available during playback. Others can be accessed only if play is stopped. Try stopping or playing the Disc, then try the feature again.

The DVD/VCR switches from DVD mode to VCR mode after 35 minutes of no activity.

- When AUTO POWER OFF is set to ON, the DVD/VCR switches itself from DVD mode to VCR mode if Disc playback stops for more than 35 minutes and you press no buttons on the remote or the DVD/VCR. *Details are on pages 64-65.* This prevents possible damage to your TV's picture tube that can occur if a still image is left on too long.

A screen saver appears on the TV screen during DVD mode.

- The DVD logo will appear on the TV screen when you stop Disc playback. You cannot remove it.

You want to use the DVD Player during a VCR timer recording or while appears on the display panel.

- Press STANDBY-ON  to turn on the DVD/VCR. Press DVD to choose DVD mode, then continue with other DVD features as described in this manual.

76 Helpful Hints (cont'd)



Power Failure

- Clock setting, language selection, and channel setup may be lost if the power fails. See pages 26-30 to set up the channels, clock, and language again.

The VCR will not record a TV program.

- Put the DVD/VCR in VCR mode. Press VCR or SOURCE so the VCR light appears on the front of the DVD/VCR.
- Check the connections between the DVD/VCR, TV, antenna/Cable TV signal, and Cable Box/Satellite Receiver (if applicable). *Details are on pages 8-15.* For VCR features, you must connect the DVD/VCR to a TV with the RF coaxial cable or the yellow video cable as described on pages 8-11.
- Make sure the video cassette has a record tab. *Details are on page 32.*

The VCR will not perform a timer recording.

- Make sure the recording start and stop times are set correctly. *Details are on pages 36-38.*
- Make sure a tape is in the VCR and the tape has a record tab. *Details are on page 32.* If, after programming a timer recording, you press TIMER SET without putting a tape in the DVD/VCR,  will blink on the display panel.
- If the record tab on a tape is missing, the DVD/VCR will eject the tape.  will blink.
- Press TIMER SET to put the DVD/VCR in standby mode for the timer recording.
- Make sure the VCR clock is set. *Details are on pages 28-29.*
- The VCR may not perform or continue a timer recording if the power fails.
- If you have a Cable Box/Satellite Receiver, set timer recordings differently. *Details are on page nine.*
- Finish programming a timer recording at least five minutes before it is set to begin.
- 12 p.m. is noon; 12 a.m. is midnight.

There is no picture or the picture is noisy or has streaks during video cassette playback.

- Put the DVD/VCR in VCR mode. Press VCR or SOURCE so the VCR light appears on the front of the DVD/VCR.
- If you used the supplied RF coaxial cable to connect the DVD/VCR to the TV, make sure the TV is on the same channel as the DVD/VCR's output channel (03 or 04). The DVD/VCR's output channel is channel 3 when you receive it. To change it to channel 4, see *page eight*. Make sure channel 03 or 04 is properly adjusted at the TV.
Or, if you connected the DVD/VCR to the TV using audio and video cables, select the correct Video In channel at the TV. *Details are on pages seven and 11.*
- Adjust the tracking. *Details are on page 44.*
- TVs placed too close to the DVD/VCR can cause interference during tape playback. Move the DVD/VCR away from the TV.

The Number buttons won't work for TV channels above 69.

- Enter channel numbers as a two-digit number. If you want to select channels 100 and above, enter channel numbers as a three-digit number. If you do not have Cable TV, only channels 2-69 are available.

TV programs cannot be watched normally.

- Check the connections between the DVD/VCR, TV, antenna/Cable TV signal, and Cable Box/Satellite Receiver (if applicable). *Details are on pages 8-15.*

Poor reception

- You may need to tune your TV again. Or, reset channels at the VCR using CHANNEL SET UP. *Details are on pages 26-27.*

Helpful Hints (cont'd) 77

You cannot insert a video cassette.

- Insert the tape, window side up, with the record tab facing you.
- Make sure a tape isn't already in the VCR by pressing STOP/EJECT ■▲ (VCR) on the front of the DVD/VCR.
- Gently push on the center of the tape when putting it in the VCR. Never force the tape into the VCR.
- If a timer recording is set, you cannot insert a tape without a record tab.

You cannot remove the tape.

- Make sure the power plug is completely connected to a power outlet.
- If you have set a timer recording, press TIMER SET to delay the recording. The  will disappear from the display panel. Then, press STOP/EJECT ■▲ (VCR) on the front of the DVD/VCR to eject the tape. Insert another tape and press TIMER SET to reset the timer recording.
- Unplug the DVD/VCR power cord for five minutes. Then, plug in the power cord again and press STANDBY-ON ○ on the DVD/VCR. Press STOP/EJECT ■▲ (VCR) on the DVD/VCR three to five times. If the tape still does not eject, you may need to have an authorized servicer remove the tape.

DVD/VCR ejects the tape when you press RECORD ● or TIMER SET.

- Make sure the tape has a record tab. *Details are on page 32.*

Satellite Receiver Hookups

- Watching one TV channel while recording another may not be possible if you have a Satellite Receiver. Set your TV to channel 03 or 04, then make your channel selections at the Satellite Receiver.
- With many Satellite Receiver hookups, if you use audio and video cables to connect your DVD/VCR to your TV, you will have to put your DVD/VCR in Line Input mode (L1 or L2).

Line Input mode

- If you accidentally enter Line Input mode (L1 or L2 will appear on your TV screen briefly), press SKIP ►/CH ▲ or SKIP ◀/CH ▼ or the Number buttons to select another channel.

Hi-Fi Stereo Sound

- During playback, Hi-Fi audio may normally revert to normal audio when you adjust tracking.
- When connecting the DVD/VCR to a TV with the red and white audio cables, you will only get stereo sound if you connect the DVD/VCR AUDIO OUT jacks on the DVD/VCR to the AUDIO IN jacks on your TV, and if the TV is on its Audio/Video In channel. See your TV owner's manual for details.
- When you connect the DVD/VCR AUDIO OUT jacks on the DVD/VCR to the AUDIO IN jacks on your TV, the stereo light on the TV might not glow. If the status display indicates you are receiving stereo, you are. *Details are on page 45.*
- Only tapes recorded in Hi-Fi audio will play in Hi-Fi audio. Tapes recorded in normal audio will play in monaural (single-channel) audio.

Cleaning the Video Heads

- Your DVD/VCR automatically cleans the video heads of the VCR each time you insert a tape. However, the heads may become dirty. If so, have an authorized servicer clean the video heads. Eventually, the heads may need to be replaced.

The playback picture is too dim, too bright, or fluctuates in brightness.

- Some programs may be broadcast with copyright protection technology in order to protect the rights of copyright owners. This technology is used on programs that are recorded on video cassettes or DVDs, as well as some programs broadcast by antenna/cable/satellite television channels. Programs broadcast with copyright protection may not record clearly. Likewise, if you play a tape that is a recording of a copyright protected program, the picture may not be clear. Tapes of copyright protected programs may have a picture that is dark or dim, or the brightness of the picture may fluctuate. Therefore, avoid recording or playing copies of copyright protected programs.
- This DVD/VCR incorporates copyright protection technology that is protected by method claims of certain U.S. patents and other intellectual property rights owned by Macrovision Corporation and other rights owners. Use of this copyright protection technology must be authorized by Macrovision Corporation and is intended for home and other limited viewing uses only, unless otherwise authorized by Macrovision Corporation. Reverse engineering or disassembly is prohibited.

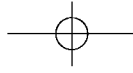

78 Care and Maintenance

Cleaning the DVD/VCR

- Wipe the front panel and other exterior surfaces of the DVD/VCR with a soft, slightly damp cloth.
- Never use a solvent, thinner, benzene, or alcohol to clean the DVD/VCR. Do not spray insecticide liquid near the DVD/VCR. Such chemicals may discolor the surface or damage the DVD/VCR.

Cleaning a Disc

- Use a soft, dry cloth to wipe the Disc.
- Wipe the Disc in a straight line from the center to the edge. Never wipe the Disc in a circular motion.
- Do not use detergent or abrasive cleaning agents.
- Handle the Discs so fingerprints and dust do not adhere to the Discs.
- Always store the Disc in its protective case when it is not in use.

Checking the Laser

- If the DVD/VCR does not operate as described in this manual, the DVD Player's laser may be dirty. Consult an Authorized Service Center for inspection and cleaning of the laser.

Caring for Video Cassettes

- Use only cassettes with the **VHS** mark.
- Remove any light adhesive stick-on notes from the video cassette before putting the cassette in the VCR. Removable labels can jam the VCR.

Caring for the VCR's Video Heads

- Periodic maintenance is required to maintain your DVD/VCR's excellent performance. The VCR has an Automatic Head Cleaner. However, the video heads will require replacement eventually. Only an authorized service center should perform this service.

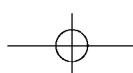
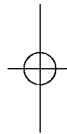
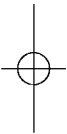

Limited Warranty 79

PHILIPS LIMITED WARRANTY

Ninety (90) Days Free Product Exchange Ninety-One (91) Days-One (1) Year Reduced-Cost Exchange

PHILIPS CONSUMER ELECTRONICS warrants this product against defect in material or workmanship, subject to any conditions set forth as follows:

PROOF OF PURCHASE:

You must have proof of the date of purchase to exchange the product. A sales receipt or other document showing the product and the date that you purchased the product, as well as the authorized retailer included, is considered such proof.

COVERAGE:

Warranty coverage begins the day you buy your product. For a period of ninety (90) days from the date of purchase, if the product is determined to be defective, Philips will exchange the defective product with a new or renewed product, at its option, at no charge. From ninety-one (91) days to one year from the date of purchase, you will pay a preset exchange fee to obtain a new or renewed product. Contact the Customer Care Center for limited exchange pricing. This exchange opportunity ends one year after the date of purchase. The replacement product is covered only for the warranty period of the original product. When the warranty on the original product expires, the warranty on all replaced products also expires. When it is necessary for you to ship the product to Philips for exchange, you will pay the shipping cost for shipment to Philips. Philips will pay the shipping costs when returning a product to you.

Note: The exchange model supplied will be the most comparable one in Philips current inventory. Shipping of your product to Philips implies intent to follow the specified requirements of the warranty and exchange program. Product received by Philips cannot be returned. Replacement product can only be sent if all warranty requirements are met. Failure to follow all requirements can result in delay of exchange process.

EXCLUDED FROM WARRANTY COVERAGE

Your warranty does not cover:

- Shipping charges to return defective product.
- Labor charges for installation or setup of the product, adjustment of customer controls on the product, and installation or repair of antenna systems outside of the product.
- Product repair and/or part replacement because of improper installation, connections to improper voltage supply, abuse, neglect, misuse, accident, unauthorized repair or other cause not within the control of Philips.

- Damage occurring to product during shipping when improperly packaged or cost associated with packaging.
- A product that requires modification or adaptation to enable it to operate in any country other than the country for which it was designed, manufactured, approved and/or authorized, or repair of products damaged by these modifications.
- A product used for commercial or institutional purposes (including but not limited to rental purposes).
- Product lost in shipment and no signature verification receipt can be provided.
- Products sold AS IS or RENEWED.

WHERE WARRANTY EXCHANGE IS AVAILABLE:

Exchange is available in all countries where Philips officially distributes the product. In countries where Philips does not distribute the product, the local Philips organization will attempt to exchange the product, although there may be a delay if the appropriate product is not readily available, or special customs processes are implied.

FOR EXCHANGE IN THE U.S.A., PUERTO RICO, OR U.S. VIRGIN ISLANDS...

Contact Philips Customer Care Center at:
1-800-531-0039

FOR EXCHANGE IN CANADA...

1-800-661-6162 (French Speaking)
1-800-531-0039 (English or Spanish Speaking)

REPLACEMENT AS PROVIDED UNDER THIS WARRANTY IS THE EXCLUSIVE REMEDY FOR THE CONSUMER. PHILIPS SHALL NOT BE LIABLE FOR ANY INCIDENTAL OR CONSEQUENTIAL DAMAGES FOR BREACH OF ANY EXPRESS OR IMPLIED WARRANTY ON THIS PRODUCT. EXCEPT TO THE EXTENT PROHIBITED BY APPLICABLE LAW, ANY IMPLIED WARRANTY OF MERCHANTABILITY OR FITNESS FOR A PARTICULAR PURPOSE ON THIS PRODUCT IS LIMITED IN DURATION TO THE DURATION OF THIS WARRANTY.

Some states do not allow the exclusions or limitation of incidental or consequential damages, or allow limitations on how long an implied warranty lasts, so the above limitations or exclusions may not apply to you. In addition, if you enter into a service contract agreement with the PHILIPS partnership within ninety (90) days of the date of sale, the limitation on how long an implied warranty lasts does not apply.

This warranty gives you specific legal rights. You may have other rights which vary from state/province to state/province.

Philips, P.O. Box 520890, Miami, FL 33152 (402) 536-4171

EL6589E001 / 01-04

80 Information Index

- ac power cord 23
 angle button 25, 55
 angle icon 64
 ant-in (antenna in) jack 8-15, 23
 ant-out (antenna out) jack 8-10, 23
 arrow buttons 24
 audio button 25, 58
 audio in/out jacks 11-14, 22-23, 35
 audio settings 68
 auto power off 64-65
 auto repeat 40
 automatic
 tape playback 44
 tape rewind, eject 44
 a-b repeat 53
 a-b repeat button 24, 53
- batteries 16
 bit-rate display 69
 black level 70
- camera angle 55
 cassette compartment 21
 channel
 adding 27
 deleting 27
 selection 24-25
 setup 17, 26, 27
 chapters 50
 clear/reset button 24, 41
 clock 21, 28-29
 coaxial digital audio out jack 15, 23
 component video out jacks 12, 23
 connections 7-15
 contents, table of 4
 controls
 dvd/vcr 22
 remote 24-25
 copyright protection 35, 39, 77
 counter 21, 31, 41
- disc menus 48, 66
 disc tray 20
 disc/vcr/menu button 24, 48
 display button 24, 31, 69
 display messages 20
 display panel 20-21
 displays 31, 63, 69
 dolby digital 68
 down sampling 68
 drc (dynamic range control) 68
 duplication (dvd to videotape) 39
 duplication (tape) 35
 dvd button 25
 dvd light 20
- ejecting a tape 22, 44, 77
- fast forward 43, 49
 ►► (fast forward) button 24
 front panel 22
- glossary 72
- head cleaner 77
 helpful hints 74-77
 hi-fi stereo sound 47
 hookups
 cable box/satellite receiver 9-10
- component video 12
 S-video 13
 stereo 14-15
 tv 8-15
- index search 42
 initializing 71
- jpeg 62-63
- language (dvd) 66-67
 language (vcr) 30
 line input mode 35, 77
 long play 72
 lp 72
- markers 54
 menus 5, 48
 mode button 25, 60-61
 mp3 display 63
 mp3 playback 62
- number buttons 25
- ok button 25
 on-screen status displays (vcr) 31
 one-touch recording 34
 open/close ▲ button 19, 22
- parental controls 56-57
 password 56
 pause button 24, 43, 52, 59
 play button 18-19, 22, 24
 player menu 66
 playing discs 19
 playing tapes 18
- power
 cord 23
 on light 22
 program 60
- quick setup 65, 66, 68
- random 61
 rear panel 23
 rec (record) light 21
 record ● button 22, 24, 32, 34
 recording
 basic 32
 one channel/watching another 33
 prevention 32
 timer 36-38
- remote control
 batteries 16
 buttons 24-25
 sensor 22
- repeat button 24, 53
 repeat (discs) 53
 repeat (tape) 40
 rerecording 35
 resume on 52
 return button 24
 reverse searching 43, 49
 ◀◀ (rewind) button 25, 43, 49
 rf coaxial cable 8-10
- safety precautions 3
 sap (second audio program) 45-46
 search button 24, 42, 50-51
- searching 43, 49
 sensor (remote) 22
 skip ►/ch ▲, skip ◀/ch ▼ 25, 51
 slow button 24, 43
 slow motion 43, 59
 slp 72
 source button 22
 sp 72
 specifications 73
 speed button 25, 32
 standard play 72
 standby-on Ⓞ button 22, 24
 status display (vcr) 31
 step-by-step playback 52
 stereo broadcast
 hookups 11, 14
 receiving/recording 45-46
 stereo sound 58
 stereo TV hookups 11
 still picture 43, 52
 stop ■ button 24
 stop/eject ■▲ (vcr) button 22
 subtitle button 25, 55
 super high speed searching 43
 super long play 72
 s-video out jack 13, 23
- table of contents 4
 tape
 duplication 35
 eject 22, 44, 77
 speed 72
 time search 42
 timer recording
 cancelling 38
 setting 36-38
 timer set button 25, 38
 title button 24, 48
 titles 48
 tracking 44
 tracks 51
 tv aspect 64-65
 tv hookups 8-15
- vcr
 button 25
 light 21
 vcr/tv button 25
 video in/out jacks 11, 14-15, 22-23
 virtual surround 70
- warranty 79
- zoom 59
 zoom button 25, 59



This owner's manual is made of recyclable materials. Remember to recycle!
 IB8479E002 Printed In China
 0VMN04132A / H9620UD * * * *

Free Manuals Download Website

<http://myh66.com>

<http://usermanuals.us>

<http://www.somanuals.com>

<http://www.4manuals.cc>

<http://www.manual-lib.com>

<http://www.404manual.com>

<http://www.luxmanual.com>

<http://aubethermostatmanual.com>

Golf course search by state

<http://golfingnear.com>

Email search by domain

<http://emailbydomain.com>

Auto manuals search

<http://auto.somanuals.com>

TV manuals search

<http://tv.somanuals.com>