

**Digital Video Disc Player
Video Cassette Recorder
FM/MW Radio Tuner**



SHOWVIEW[®]

Let's make things better.



PHILIPS



General Information

The region code for this set is 2.

Since it is usual for DVD movies to be released at different times in different regions of the world, all players have region codes and discs can have an optional region code. If you load a disc of a different region code to your player, you will see the region code notice on the screen. The disc will not playback, and should be unloaded.



Manufactured under license from Dolby Laboratories. "Dolby", "Pro Logic" and the double-D symbol are trademarks of Dolby Laboratories.

Manufactured under license from Digital Theater Systems, Inc. US Pat. No. 5,451,942, 5,956,674, 5,974,380, 5,978,762 and other world-wide patents issued and pending. "DTS" and "DTS Digital Surround" are registered trademarks of Digital Theater Systems, Inc. Copyright 1996, 2000 Digital Theater Systems, Inc. All Rights Reserved.

This product incorporates copyright protection technology that is protected by method claims of certain U.S. patents and other intellectual property rights owned by Macrovision Corporation and other rights owners. Use of this copyright protection technology must be authorised by Macrovision Corporation, and is intended for home and other limited viewing uses only unless otherwise authorised by Macrovision Corporation. Reverse engineering or disassembly is prohibited.

 **The System is in conformity with the EMC directive and low-voltage directive.**

For Customer Use:

Read carefully the information located at the bottom of your System and enter below the Serial No. Retain this information for future reference.

Model No. MX5100VR

Serial No. _____

Laser safety

This unit employs a laser. Due to possible eye injury, only a qualified service person should remove the cover or attempt to service this device.

USE OF CONTROLS OR ADJUSTMENTS OR PERFORMANCE OF PROCEDURES OTHER THAN THOSE SPECIFIED HEREIN MAY RESULT IN HAZARDOUS RADIATION EXPOSURE.

LASER		
Type	Semiconductor laser GaAlAs	
Wave length	655 nm (DVD)	790 nm (VCD/CD)
Output Power	0.8 mW (DVD)	0.5 mW (VCD/CD)

CLASS 1 LASER PRODUCT
KLASSE 1 LASER PRODUKT
KLASS 1 LASER APPARAT
CLASSE 1 PRODUIT LASER

WARNING LOCATION:

ON THE BACKPLATE OF SET

About the PBC Function of VIDEO CD

This unit conforms to ver.1.1 and ver.2.0 of VIDEO CD standard, with PBC function.

Ver.1.1 (without PBC function): You can enjoy playback picture as well as music CD.

Ver.2.0 (with PBC function): When using a VIDEO CD with PBC function, "PBC" appears on the display.

What is PBC? "PBC" stands for the PlayBack Control.

You can play interactive software using a menu screens. Refer to instructions of VIDEO CD.

Note:

– When playing Video CDs with PBC function, some operations (e.g., select and repeat tracks) cannot be performed unless the function is cancelled temporarily (refer to page 16).

Thank you for purchasing this Philips System. This Owner's Manual explains the basic operation of this System.

Environmental Information

All unnecessary packaging has been omitted.

Packaging has been made easy to separate into three materials: cardboard (box), polystyrene foam (buffer) and polyethylene (bags, protective foam sheet).

Your System consists of materials which can be recycled and reused if disassembled by a specialised company. Please observe the local regulations regarding the disposal of packaging materials, exhausted batteries and old equipment.

Supplied Accessories





- Remote control
- Batteries (two AA size) for remote control
- SCART cable (not available for all versions)
- MW antenna
- FM antenna
- Speaker set
- RF Coaxial cable
- Owner's Manual

Safety Information

- To reduce the risk of fire or electric shock, do not expose this device to rain or moisture.
- Before operating the System, check that the operating voltage indicated on the typeplate (or the voltage indication beside the voltage selector) is identical with the voltage of your local power supply. If not, please consult your dealer.
- Place the System on a flat, hard and stable surface.
- There must be sufficient room in front of the player for the disc tray to be opened.
- In cabinet, allow about 2.5cm (1 inch) of free space all around the player for adequate ventilation.
- Do not expose your player to extreme of temperature or humidity.
- If the System is brought directly from a cold to a warm location, or is placed in a very damp room, moisture may condense on the lens of the disc unit inside the System player. Should this occur, the System would not operate normally. Leave the player on for about one hour with no disc in the System until normal playback is possible.
- The mechanical parts of the set contain self-lubricating bearings and must not be oiled or lubricated.
- Never spill liquid of any kind on this unit. If liquid is spilled into the unit, consult qualified service engineer.
- **When the System is switched to Standby mode, it is still consuming some power. To disconnect the system from the power supply completely, remove the AC power plug from the wall socket.**

Symbols Used in this Manual

The below symbols appear in some headings and notes with the following meanings:

	– Description refers to playback of DVD-video discs
	– Description refers to playback of Audio CDs
	– Description refers to playback of MP3 files
	– Description refers to playback of video CDs.

Helpful Hints!

- Some DVD video discs require specific functions or allow only limited functions during playback.
- “” may appears on the TV screen which means that the function is not available on that specific DVD video disc. It also appears when a prohibited operation has been encountered by this unit or the disc.

General Information	
Environmental Information.....	2
Supplied Accessories.....	2
Safety Information.....	2
Symbols Used in this Manual.....	2
Functional Overview	
Front Panel.....	4
Display Message.....	4
Rear Panel.....	5
Remote Control.....	5
Setting Up your System	
Basic Connections.....	6
Connecting to a TV.....	6
Connecting to Optional Equipment (for DVD features).....	7
Antenna Connections.....	7
Connecting the speaker wires to the speaker jacks..	7
Setting up Surround Sound.....	8
External Input Mode (for VCR features).....	8
Inserting batteries into the Remote Control.....	8
Using the Remote Control.....	8
Playable Video Cassette Tapes.....	8
Turning on your System.....	8
Automatic Channel Setup.....	9
Manual Channel Preset.....	9
Follow TV (Automatic TV channels sorting).....	9
Sorting and clearing TV channels manually.....	10
Setting the language (for VCR features).....	10
Setting the clock.....	10
Changing video (colour) system (for VCR features).....	10
Decoder allocation (for VCR features).....	10
VCR Playback	
Playing cassettes.....	11
Playing back NTSC cassettes.....	11
Displaying current tape position.....	11
Searching for a tape position with picture (scanning).....	11
Still picture / slow motion.....	11
Searching for tape position without picture (forward wind and rewind).....	11
Index search.....	11
Manual Tracking.....	11
VCR Manual Recording	
General information.....	12
Recording without automatic switch-off.....	12
Linking up recordings (assemble cut).....	12
Selecting the recording speed (SP or LP).....	12
Automatic controlled recording from a satellite receiver (RECORD LINK).....	12
'Direct Record'.....	12
Switching 'Direct Record' on or off.....	12
Direct dubbing.....	13
Recording (From DVD To VCR).....	13
Programming a Recording (TIMER)	
General information.....	13
Programming a recording (with the 'SHOWVIEW® system').....	13
Programming a recording (without the SHOWVIEW system).....	14
OTR (One Touch Recording).....	14
How to check, or delete a programmed recording (TIMER).....	14
How to change a programmed recording (TIMER).....	14
Hints for Timer Recording.....	14
Other Functions	
Switching the status display off or on.....	15
Blue Background on or off.....	15
Clock Display.....	15
Selecting the sound channel.....	15
Digital Sound.....	15
Surround Sound.....	15
Playing a Disc	
Basic Playback.....	16
General Features.....	16
Pause.....	16
Disc Menus.....	16
Title Menu.....	16
Calling Up a Menu During Playback.....	16
Step by Step Playback.....	16
Resume.....	16
Fast Forward / Reverse Search.....	16
Slow Forward / Slow Reverse.....	16
Zoom.....	17
Track.....	17
Title / Chapter Search.....	17
Time Search.....	17
Repeat.....	17
Program.....	18
Random Playback.....	18
MP3/JPEG Playback.....	18
On-Screen Information.....	18
Track Selection.....	18
Random Playback.....	18
Program.....	18
Audio Language.....	18
Stereo Sound Mode.....	18
Subtitle Language.....	19
Camera Angle.....	19
Changing the On-Screen Display.....	19
Parental Control.....	19
Marker Setup Screen.....	19
DVD Setup	
Audio Setting.....	20
Delay Time.....	20
Speaker Balance.....	20
Language Setting.....	20
Display Setting.....	21
FM/MW Radio	
Selecting Radio Station.....	22
Preset Radio Stations.....	22
Maintenance.....	
Specifications.....	23
Troubleshooting.....	23

SHOWVIEW®

SHOWVIEW is a registered trademark of Gemstar Development Corporation.

The SHOWVIEW system is manufactured under licence from Gemstar Development Corporation.

Functional Overview

English

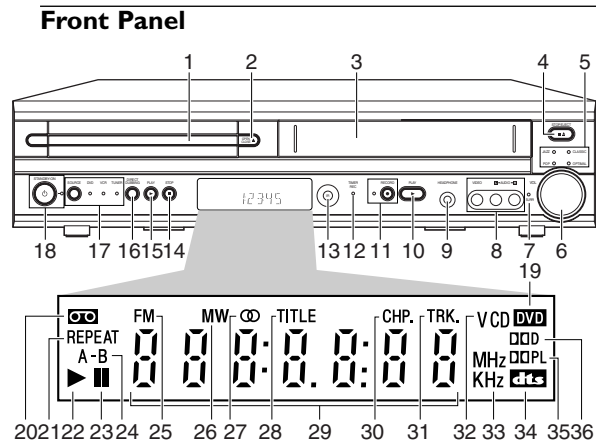

1. **Disc Tray (DVD)**
insert a disc here
2. **OPEN/CLOSE ▲ button (DVD)**
to open/close the disc tray
3. **Cassette Compartment (VCR)**
insert a tape here
4. **STOP/EJECT ■▲ button (VCR)**
when playback is stopped, press to eject the tape
5. **Sound lights**
Each indicator lights according to the sound effect you select by pressing the SOUND button on the remote
6. **VOLUME dial**
turn clockwise to increase the volume; turn counter-clockwise to decrease the volume
7. **SURR light**
light appears when Surround Sound is On
8. **AUDIO and VIDEO in jacks**
connect to AUDIO and VIDEO OUT of an audio source
9. **HEADPHONE jack**
connect headphones (not supplied) here
10. **PLAY ► button (VCR)**
to play a tape
11. **RECORD button and light (VCR)**
Press once to start recording, repeatedly to start an One Touch Recording
light appears during recording, it flashes when a recording is paused
12. **TIMER REC light (VCR)**
light appears when the System is in standby mode for a timer recording (also light appears during timer recording)
13. **IR (Infrared) Remote Sensor (DVD,VCR,TUNER)**
receive signals from remote control
14. **STOP ■ button (DVD)**
to stop playback
15. **PLAY ► button (DVD)**
to start, pause or resume disc playback
16. **DIRECT DUBBING button (VCR)**
to play DVD disc and record its' content to video cassette tape at the same time
17. **SOURCE button and lights (DVD,VCR,TUNER)**
to select DVD,VCR and TUNER mode
DVD light appears when the System in DVD mode
VCR light appears when the System in VCR mode
TUNER light appears when the System in TUNER mode
18. **STANDBY-ON ○ button and light (DVD,VCR, TUNER)**
to switch the player to ON or OFF
light appears when the System turns on.
19. **DVD**
Lights up when a DVD is inserted on the tray.

20. **Ⓜ (VCR)**
Appears when a videotape is loaded.
21. **REPEAT (DVD)**
Stays on when the repeat function is on.
22. **► (DVD,VCR)**
Stays on when the inserted disc or cassette is being played back.
23. **⏸ (DVD,VCR)**
Lights up when the inserted disc comes to a pause. (DVD)
Lights up when the playback is in a still or in a slow mode. (VCR)
24. **A-B (DVD)**
Stays on when the A-B repeat function is on.
25. **FM (TUNER)**
Indicates an FM station
26. **MW (TUNER)**
Indicates an MW station
27. **Ⓢ (TUNER)**
Indicates a stereo broadcast
28. **TITLE (DVD)**
Stays on when repeat title function is on.
29. **Digital Display (DVD,VCR,TUNER)**
Displays how long a current title or track has been played back. When a chapter or track has switched, the number of a new title, chapter or track is displayed. (DVD)
Works as a clock, or a tape counter. Also displays a channel number, and remaining time for OTR. (VCR)
Displays a current radio frequency (station number). (TUNER)
30. **CHP. (DVD)**
Stays on when repeat chapter function is on.
31. **TRK (DVD)**
Stays on when repeat track function is on.
32. **CD**
Lights up when a CD is inserted on the tray.
VCD
Lights up when a VCD is inserted on the tray.
33. **MHz**
Indicates an FM station.
KHz
Indicates an MW station.
34. **dts**
Indicates DTS is available.
35. **DDPL**
Indicates Dolby ProLogic is available.
36. **DDD**
Indicates Dolby Digital is available.

Display Message

- - - -	Appears after the disc tray closes if the tray is empty, if there is an error reading the disc, or if an unacceptable disc is installed.
OPEN	Tray is opening or is open.
CLOSE	Tray is closing. This also may appear as the Player tries to load a Disc.
Load	Disc is loading.
Pbc	Lights up when a playback control is activated.

Functional Overview

Rear Panel

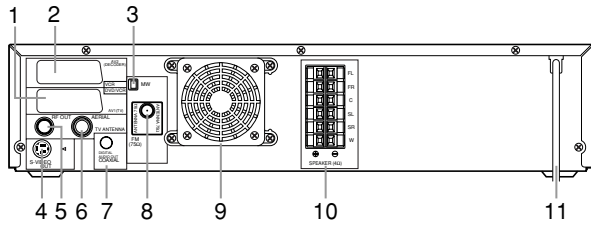

1. **AV1 (TV) jack**
connect SCART cable to a TV
2. **AV2 (DECODER) jack (VCR only)**
connect SCART cable from another DVD/VCR, camcorder or an audio/video source
3. **MW antenna jack**
connect the supplied MW antenna to the MW jack
4. **S-Video Out jack (DVD only)**
connect to a TV with S-Video inputs
5. **RF OUT jack**
use the supplied RF coaxial cable to connect to the ANTENNA IN on your TV, cable box or Direct Broadcast System
6. **AERIAL jack**
connect to an antenna or cable
7. **COAXIAL (Digital audio out) jack (DVD only)**
connect to AUDIO inputs of a digital (coaxial) audio equipment
8. **FM antenna jack**
connect the supplied FM antenna to the FM jack
9. **Fan**
10. **SPEAKER jacks**
connect the supplied speakers using the supplied speaker wires.
11. **MAINS (AC Power Cord)**
connect to a standard AC outlet

Remote Control

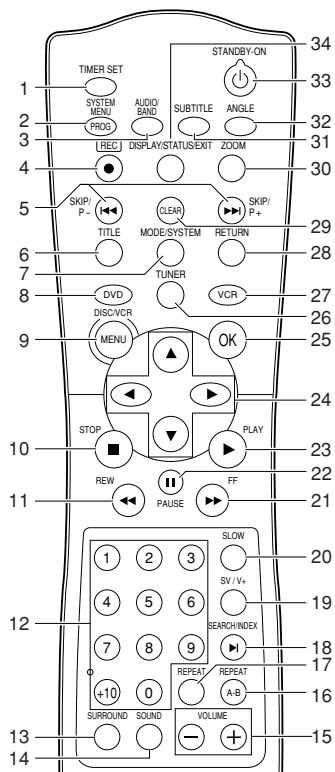

1. **TIMER SET**
to put the System into standby mode for a timer recording
2. **SYSTEM MENU**
to access or remove the DVD setup menu (DVD)
3. **AUDIO/BAND**
to choose audio languages or sound modes (DVD)
to choose sound modes (VCR)
to choose FM or MW in Tuner mode (TUNER)
4. **REC** ●
to record the TV channel selected at this moment or press repeatedly to start a One Touch Recording (VCR)
5. **SKIP/P- / SKIP/P+** ◀▶
to skip chapter/tracks (DVD)
to change TV channels (VCR)
press and hold to search radio station
or press to increase or decrease the frequency by one-tenth (TUNER)
6. **TITLE**
to display title menu of a disc (DVD)
7. **MODE/SYSTEM**
to set up programmed or random playback (DVD, Audio CD)
to change the System for matching recorded colour system (SECAM, ME-SECAM or PAL) (VCR)
8. **DVD**
press to put the System in DVD mode and before using the remote control for DVD features
9. **DISC/VCR MENU**
to display the menu of the DVD disc or to access VCR menu
10. **STOP** ■
to stop a DVD disc playback (DVD)
to stop playback, recording (VCR)
to erase a preset (TUNER)
11. **REW** ◀◀
to view DVD picture in fast reverse motion (DVD)
to rewind the tape (VCR)
12. **0-9 numerical key pads/+10**
select numbered items in a menu
use +10 button to enter number 10 and above (DVD)
to select TV channels / to enter the SHOWVIEW number (VCR)
to choose a preset radio station (TUNER)
13. **SURROUND**
to turn Surround Sound on or off
14. **SOUND**
to choose a Digital Sound effect
15. **VOLUME**
to adjust the volume
16. **REPEAT A-B**
repeat a specific segment (DVD)
17. **REPEAT**
repeat chapter, track, title, disc (DVD)
18. **SEARCH/INDEX** ▶
to access or remove search display (DVD)
to fast forward or rewind the tape at index number (VCR)
19. **SV/V+**
to programme timer recording with the SHOWVIEW system (VCR)
20. **SLOW**
to view tape playback in slow motion (VCR)
21. **FF** ▶▶
to view DVD picture in fast forward motion (DVD)
to fast forward the tape (VCR)
22. **PAUSE** ||
pause playback temporarily / frame-by-frame playback (DVD)
pause playback and recording temporarily (VCR)
23. **PLAY** ▶
to start a DVD disc playback (DVD)
to start a tape playback (VCR)

Functional Overview

24. **◀▶▲▼**
(left/right/up/down) select an item in the menu
◀▶ to choose a preset radio station (TUNER)
25. **OK**
acknowledge menu selection (DVD)
26. **TUNER**
press to put the System in TUNER mode and before using the remote control for TUNER features
27. **VCR**
press to put the System in VCR mode and before using the remote control for VCR features
28. **RETURN**
to return previous or remove setup menu (DVD)
29. **CLEAR**
to reset the setting (DVD)
to reset the counter (VCR)
to delete last entry/Clear programmed recording (TIMER) (VCR)
30. **ZOOM**
enlarge DVD video image (DVD)
31. **SUBTITLE**
subtitle language selector (DVD)
32. **ANGLE**
select DVD camera angle (DVD)
33. **STANDBY-ON** 
switch the System ON or OFF
34. **DISPLAY/STATUS/EXIT**
to access or remove the display screen during DVD or Audio CD playback (DVD)
to access or remove VCR's on-screen status display/ to remove VCR's menu (VCR)

Setting Up your System

Basic Connections

- Please refer to the instruction books of your TV, VCR, Stereo System or other devices as necessary to make the best connections.
 - Make one of the following connections, depending on the capabilities of your existing equipment.
- The following guidelines are options for the best picture and sound quality available on your System.

Picture

- 1 Use SCART RGB Output (DVD/VCR(AV1 TV)) for best picture quality (for DVD features).
- 2 Use S-VIDEO Output for the better picture quality (for DVD features only).
- 3 Use SCART Composite Output for good picture quality (for DVD and VCR features).

Sound

- 1 Digital audio connections provide the clearest sound. Connect the System DIGITAL AUDIO OUT (COAXIAL) to your amplifier or receiver (for DVD features only).
- 2 Use SCART Output (DVD/VCR(AV1 TV)) for better sound quality (for DVD and VCR features).

Warning!

- **Never make or change connections with the power switched on.**
- **Connect the System directly to your TV, instead of eg. a VCR, to avoid distortion because DVD video discs are copy protected.**
- **If you use the Euro audio/video cable, it is not necessary to use other audio cables.**

Connecting to a TV

- 1 Disconnect the antenna or cable from your TV.
- 2 Connect the antenna or cable to the AERIAL of your System.
- 3 Connect black RF coaxial cable to the RF OUT on the rear panel of the System and to the ANTENNA IN on the TV.
- 4 Connect the AV1 (TV) jack on the System to the corresponding connector on the TV.

Note:

- **Ensure that the "TV" indication on SCART cable is connected to the TV set and "DVD" indication on SCART cable is connected to the System.**

- 5 Plug in the power cords of the TV and the System.

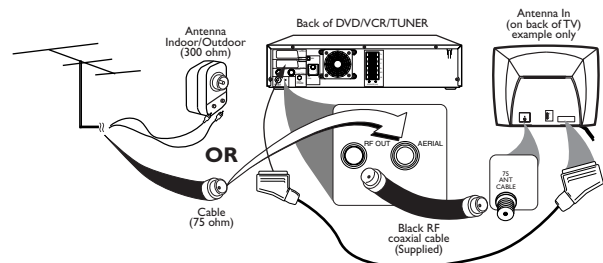

Setting Up your System

If your TV is not equipped with a SCART input, you can select the following connection:

If your TV has a S-Video input connector,

- 1 Connect the antenna or cable to the AERIAL of your System.
- 2 Connect the S-Video out on the System to the S-Video in on the TV.
- 3 Connect the COAXIAL (Digital audio out) on the System to the Coaxial jack on the TV.

Note:

– You will still need the SCART cable for VCR features.

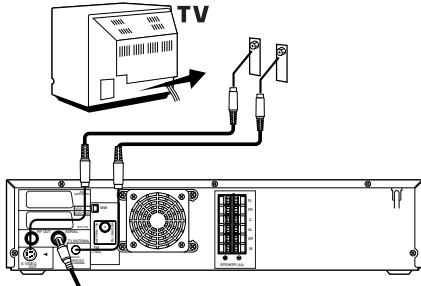

Connecting to Optional Equipment (for DVD features)

- A digital component with a built-in MPEG 2 or Dolby Digital™ decoder allows you to enjoy the surround sound while producing the effect of being in a movie theater or a concert hall.
- The player outputs the surround sound signals from the DIGITAL OUT COAXIAL connector.

- 1 If your receiver has a MPEG 2 or Dolby Digital™ decoder, Connect the COAXIAL DIGITAL AUDIO OUT of the System to the COAXIAL DIGITAL AUDIO IN on your receiver.

Notes:

- If the audio format of the digital output does not match the capabilities of your receiver, the receiver will produce a strong, distorted sound or no sound at all.
- MP3 Audio is not available on the Digital Output.
- You will still need the video cable or RF coaxial cable for VCR features.

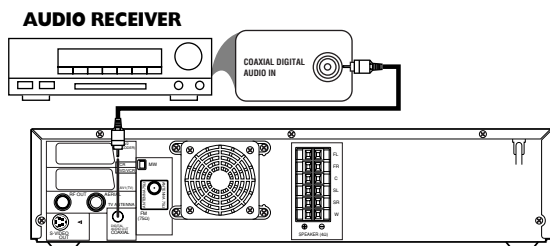

Antenna Connections

MW Antenna

- 1 Fix the antenna holder as shown.

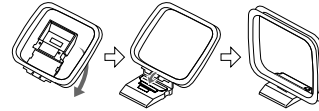

- 2 Connect the supplied MW antenna to the MW jack, then position it to receive the clearest sound.

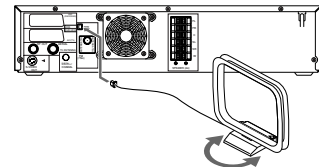

FM Antenna

- 1 Connect the supplied FM antenna to the FM jack. Extend the FM antenna wire and fix its end to the wall.

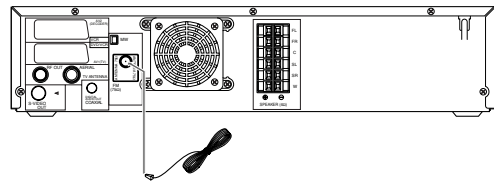

Notes:

- Do not place the MW antenna on the System. Keep it as possible from the System and the speaker wires. Keep it away from the AC power cords of the System and other equipment.
- For better FM reception, connect an outdoor FM antenna (not supplied) to the ANTENNA 75 ohm jack.

Connecting the speaker wires to the speaker jacks

- 1 Connect the supplied speakers using the supplied speaker wires. Match the colors of the wires to the colors on the jacks. Hold down the jack tab while inserting the stripped portion of the speaker wire into the jack. Then, release the tab. Make sure you do not insert the wire too far. None of the rubber-coated wire should be clamped by the jack tab.

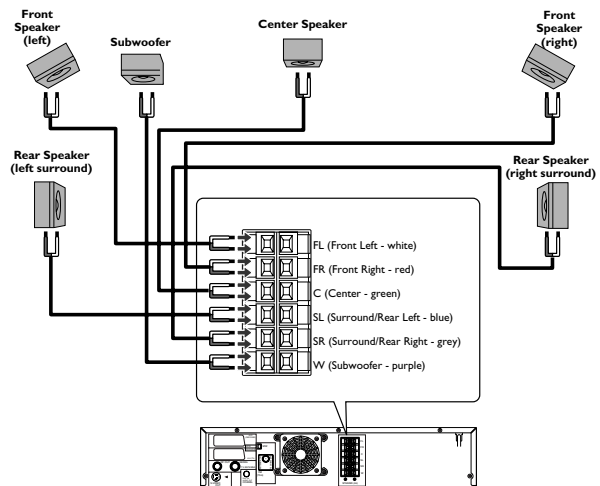

Setting Up your System

Setting up Surround Sound

Connect all the speakers and set up the System properly in order to enjoy the Home Cinema experience.

- 1 Place the FRONT Left and Right speakers at equal distances from the TV and at a 45-degree angle from the listening position.
- 2 Place the CENTER speaker above or below the TV to localize the sound.
- 3 Place the REAR (Surround) speakers at normal listening ear level, facing each other or mounted on the wall. Use the supplied mounting brackets to mount speakers to the wall.
- 4 Place the Subwoofer on the floor, near the TV.

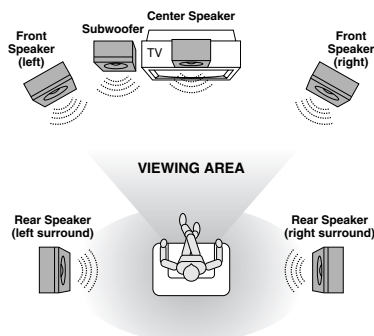

Notes:

- Connect the speaker wires correctly. Improper connections may short circuit the System.
- For optimal sound, use the supplied speakers.
- Do not connect more than one speaker to any pair of speaker jacks on the System.
- Do not connect speakers with an impedance lower than 6 ohms.
- Sit in your usual listening position to set up the speaker balance.
- To avoid magnetic interference, do not place the FRONT speakers too close to your TV.
- Placing the REAR (Surround) speakers farther from the listening position than the FRONT and CENTER speakers will weaken the Surround Sound effect.
- Secure all speakers to prevent accidents and improve sound quality. Use the supplied mounting brackets to mount speakers to a wall.

External Input Mode (for VCR features)

To receive the signal from an external input (decoder, satellite receiver, video camera, another VCR etc.), connect to the AV2 (DECODER) socket, and enter "002" with numerical key pads to appear "AV2" on the TV screen.
If you use the AV1 (TV) socket, enter "001" with numerical key pads to appear "AV1" on the TV screen.
If you use the front AUDIO/VIDEO input jacks, enter "003" with numerical key pads to appear "AV3" on the TV screen.

Inserting batteries into the Remote Control

- 1 Open the battery cover.
- 2 Insert batteries (AA size) with the correct polarity as indicated by the + and - symbols inside the battery compartment.
- 3 Close the cover.

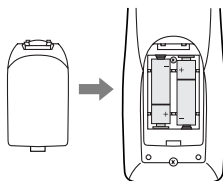

CAUTION!

- Remove batteries if they are exhausted or not to be used for a long time.
- Do not use old and new or different types of batteries in combination.
- Batteries contain chemical substances, so they should be disposed off properly and kept away from children.

Using the Remote Control

- Direct the remote control at the remote sensor of the System.
- Do not drop the remote control.
- Do not leave the remote control near extremely hot or humid place.
- Do not spill water or put anything wet on the remote control.

Playable Video Cassette Tapes

Philips Consume Electronics recommends that only video cassette tapes that have the VHS mark and High Quality (HQ) system is compatible with this System. This System has an Automatic Head Cleaner.

Recording Prevention

Video cassette tapes have record tabs to ensure recordings are not erased accidentally.

- 1 To prevent recording, break off the tab with a screw-driver.
- 2 To allow recording, cover the hole with cellophane tape.

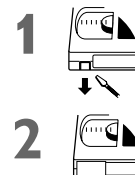

Notes:

- Use only tapes with VHS mark.
- Remove any adhesive stick-on notes from the tape before inserting into the System.
- Periodic maintenance is required to maintain your System performance.
- Video heads will require replacement after a period of time. Only an authorised service center should perform this service.

Turning on your System

The following steps only be performed when you insert the AC PLUG at the first time.

- 1 Turn on the TV and select the video channel on the TV.
 - 2 Plug in the System.
 - 3 Press ▲/▼ repeatedly to select your desired language.
 - 4 Press DISC/VCR MENU.
 - 5 Confirm with SKIP/P+ ►►.
- The automatic TV channel search starts.
- 6 'TIME' and 'DATE' will appear on the TV screen.
 - 7 Check 'TIME'. If required, please change the time with numerical key pads.
 - 8 Check if the displayed settings for 'DAY', 'MONTH' and 'YEAR' are correct.
 - 9 When all information is correct, save by pressing DISPLAY/STATUS/EXIT. The preparation for use is now complete.

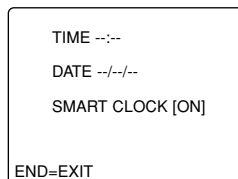
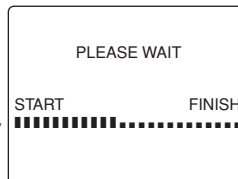
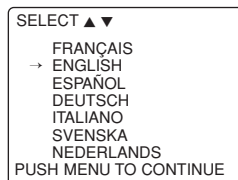

Note:

- If the System has been completed AUTO TUNING at this procedure, this initial menu has never shown even if power failure is occurred or inserted AC plug again.

Setting Up your System

Automatic Channel Setup

You can programme the tuner to scan only the channels that you can receive in your area.

- 1 Turn on the TV and select the video out channel on your TV.
- 2 Press VCR, then DISC/VCR MENU.
- 3 Press ▲/▼ to select TUNER SET UP, then press ►.
- 4 Press ▲/▼ to select AUTO TUNING, then press ►.
 - The System distinguishes SECAM or PAL automatically.
 - The tuner scans and memorizes all the active channels in your area. After scanning, the tuner stops on the lowest memorized channel.
- 5 Press SKIP/P+ ►► / SKIP/P- ◄◄ or numerical key pads to scan through channels you have received.

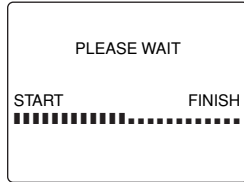

Manual Channel Preset

- 1 Press VCR, then DISC/VCR MENU.
- 2 Press ▲/▼ to select TUNER SET UP, then press ►.
- 3 Press ▲/▼ to select MANUAL TUNING, then press ►.
- 4 Press ▲/▼ to select SYSTEM, then press ► to appear your desired system.
 - You can select programme number 01-99.
- 5 Press ▲/▼ to select PROG., then press ►.
- 6 Press ▲/▼ or numerical key pads to select your desired programme number, then press ►.
 - You can select programme number 01-99.
- 7 Press ▲/▼ to select CHANNEL, then press ►.
- 8 Press ▲/▼. The System tuner will begin to search up or down automatically. When a channel is found, the System will stop searching and the picture will appear on the TV Screen.
 - You can select desired channel number by using numerical key pads. You must refer to the channel plan and press three digits to select the channel number. (To select channel 24, first press "0" button then press "2" and "4").
 - If this is the channel you want, press ►.
 - If you want to remove scrambled signals, press ▲/▼ to select DECODER. Then, press ► to select [ON].
- 9 Press DISPLAY/STATUS/EXIT to exit.

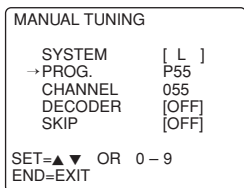

Follow TV (Automatic TV channels sorting)

When the automatic channel search function is activated, the TV channels are saved in a specific order. This may vary from the order of TV channels on the TV.

This function changes the order of TV channels saved in the System to match that of the TV.

Make sure that the System and the TV are connected by a scart cable.

- 1 Press VCR, then DISC/VCR MENU.
- 2 Press ▲/▼ to select TUNER SET UP, then press ►.
- 3 Press ▲/▼ to select 'FOLLOW TV', then press ►.
- 4 'P:01' will appear in the System display.

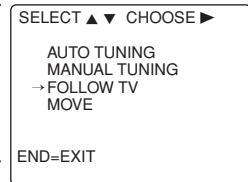

I cannot switch my TV set to programme number '1'

* If you have connected additional devices to socket AV2(DECODER), please disconnect these devices. Because of other connected devices, the TV set could switch to the programme number of the scart socket.

'NO TV SIGNAL' will appear in the TV screen. The System is not receiving a video signal from the TV.

Check the plug on the scart cable.

Check your TV's operating instructions to see which scart socket is used for video signals.

If this does not help, it's not possible to use this function. Please read the section 'Sorting and Clearing TV channels manually'.

- 5 Select programme number '1' on the TV.
- 6 Confirm with ► on the System remote control. The System compares the TV channels on the TV and the System. If the System finds the same TV channel as on the TV, then it stores it at 'P01'.
- 7 Wait until the next number, e.g. 'P:02' appears in the display.
- 8 Select the next programme number on the TV, e.g. '2'.
- 9 Confirm with ►.
- 10 Repeat steps 7 to 9 until you have assigned a programme number to all TV channels.
- 11 To end, press DISPLAY/STATUS/EXIT.

Notes:

- To confirm that a channel has been added, press the SKIP/P+ ►► / SKIP/P- ◄◄ buttons.
- You should select the satellite channels to be received by the satellite receiver directly on the receiver itself.

Setting Up your System

Sorting and clearing TV channels manually

After you have performed the automatic channel search you may not agree with the sequence in which the individual TV channels have been allocated to the programme positions (programme numbers) of the System. You can use this function to individually sort the TV channels already saved or to delete unwanted TV channels or those with poor reception.

The clock resets automatically

If you save a TV channel that transmits TXT/PDC on programme number 'P01', date and time will constantly be updated. As a result, time changes, i.e. daylight savings time, will be set automatically.

- 1 Press VCR, then DISC/VCR MENU.
- 2 Press ▲/▼ to select 'TUNER SET UP', then press ►.
- 3 Press ▲/▼ to select 'MOVE', then press ►.
- 4 Press ▲/▼ to select the saved TV channel that you want to change.
- 5 Confirm with ►.
- 6 Move the selected channel with ▲/▼ to the programme number you want to assign.
- 7 Confirm with ►.
- 8 To assign other TV channels to a programme number, repeat steps 4 to 7.
- 9 Confirm the assignment of the TV channel with MOVE menu.
- 10 To exit the MOVE menu, press DISPLAY/STATUS/EXIT.

```
MOVE
→P01: 02   P06: 90
P02: 03   P07: 99
P03: 05   P08: 121
P04: 10   P09: 124
P05: 74   P10: 130

SELECT ▲ ▼ CHOOSE ►
END=EXIT
```

Setting the language (for VCR features)

You have the option of setting one of the displayed languages for the on-screen menu (OSD). However, the System display will only display English text regardless of this setting.

- 1 Press VCR, then DISC/VCR MENU.
- 2 Press ▲/▼ to select 'INITIAL SET UP', then press ►.
- 3 Press ▲/▼ to select 'LANGUAGE', then press ►.
- 4 Select the desired language with ▲/▼.
- 5 To end, press DISPLAY/STATUS/EXIT.

```
SELECT ▲ ▼
FRANÇAIS
→ ENGLISH
ESPAÑOL
DEUTSCH
ITALIANO
SVENSKA
NEDERLANDS
END=EXIT
```

Setting the clock

If the display shows an incorrect time or '---', the time and date must be reset manually.

If a TV channel that transmits TXT/PDC (teletext/PDC) is stored under programme number 'P01', time/date will automatically be taken from the TXT/PDC information. (SMART CLOCK)

- 1 Press VCR, then DISC/VCR MENU.
- 2 Press ▲/▼ to select 'INITIAL SET UP', then press ►.
- 3 Press ▲/▼ to select 'CLOCK', then press ►.
- 4 Check the time in 'TIME'. If required, please change the time with numerical key pads.
- 5 Check 'DAY', 'MONTH' and 'YEAR' in the same way.
- 6 Choose 'SMART CLOCK' ON or OFF with ►.
- 7 To end, press DISPLAY/STATUS/EXIT.

```
TIME ---
DATE ---
SMART CLOCK [ON]

END=EXIT
```

Changing the video (colour) system (for VCR features)

If you playback recordings made on other video recorders or you want to record from external sources (via the scart socket), the automatic video (colour) system switch-over may lead to colour distortion. You can switch off the automatic TV system switch-over as follows.

Video (colour) systems

Other countries, other video (colour) systems:

In central Europe transmissions are broadcast in the PAL system (Phase Alternation Line) standard. France uses SECAM (Séquentiel à mémoire). In some countries (USA and Japan), TV viewers receive their programmes as an NTSC signal (National Television System Committee).

- 1 Press MODE/SYSTEM on the remote control to select the TV (colour) system with the least disruptions before you start recording or during playback. Each pressing MODE/SYSTEM, the display will change cyclically: AUTO, PAL, SECAM, ME-SECAM.

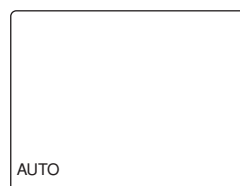

- 2 After 5 seconds, the OSD will disappear.

How can I change back to 'Automatic Switch-over'?

Even if you change the programme number, the video (colour) system for recording will keep the setting.

If you eject the cassette, the video (colour) system for playback will switch itself back to 'AUTO' (automatic switchover).

Decoder allocation (for VCR features)

Some TV channels transmit encoded TV signals which can only be viewed with a purchased or rented decoder. You can connect such a decoder to this System. The following function will automatically activate the connected decoder for the desired TV channel.

- 1 Switch the TV on. If applicable, select the programme number for the System operation.
- 2 Press ▲/▼ or numerical key pads to select the TV channel which you would like to allocate the decoder to.
- 3 Press DISC/VCR MENU. The main menu will appear.
- 4 Press ▲/▼ to select 'TUNER SET UP'. Then press ►.
- 5 Press ▲/▼ to select 'MANUAL TUNING'. Then press ►.
- 6 Press ▲/▼ to select 'DECODER'.
- 7 Press ► to select 'ON' (Decoder switched on).

```
MANUAL TUNING
SYSTEM [ L ]
PROG. P55
CHANNEL 055
→ DECODER [OFF]
SKIP [OFF]

SELECT ▲ ▼ CHOOSE ►
END=EXIT
```

How can I switch off the decoder?

Use ► to select 'OFF' (Decoder switched off).

- 8 To end, press DISPLAY/STATUS/EXIT. The decoder has now been allocated to this TV channel.

Playing cassettes

- When you select AUTO by pressing the MODE/SYSTEM button, this System will distinguish the colour system (SECAM, PAL or ME-SECAM) automatically according to the format of recorded tape during playback.
If the picture on the TV screen is black and white, select SECAM, ME-SECAM or PAL by using the MODE/SYSTEM button.
- Tapes recorded with the NTSC system can playback with this System via a PAL system TV set.

Note:

- Depending on the TV, when playing back a NTSC tape on a PAL TV, the picture may roll up or down, shrink vertically and black bars may appear both at the top and bottom of the screen.

You can use this System to play back recorded VHS videocassettes. You can operate the System using the remote control or the buttons on the front of the System.

If you press PLAY, STOP, FF or REW while the set is in Stand-by, the power will be automatically turned on. Additionally, if a cassette was already inserted, the corresponding operation will be performed.

Your System can only record and play standard VHS cassettes.

- 1 Put a cassette into the cassette slot. The cassette is inserted automatically.
- 2 Press PLAY ► to view the tape.
- 3 To stop the playback, press STOP ■ or STOP/EJECT ■▲ on the System.
- 4 To eject the cassette, press STOP/EJECT ■▲ on the System when the System stops the playback.

DIGITAL STUDIO PICTURE CONTROL

Philips has developed a system which produces the best possible playback quality. For old and often-used video cassettes, this system reduces interference. For new or high quality cassettes, it emphasises the details.

Picture/ sound quality is poor

When playing rental videos or older, poorer quality cassettes, it may not be possible to completely filter out picture and sound interference. This is not a fault in your machine. Read the section 'Manual Tracking'.

Do I need to change the playback speed when playing back LP recordings?

During playback, the correct speed will automatically be selected. For more information, please read the section 'Selecting the recording speed (SP or LP)' in the chapter 'VCR Manual Recording'.

Playing back NTSC cassettes

This System can also play back cassettes that have been recorded in SP [Standard Play] or SLP [Super Long Play] mode in the NTSC standard (for example, American cassettes). However, this only works on PAL-television sets that are suitable for a picture frequency of 60Hz.

Displaying current tape position

The following information is displayed on the screen: e.g.: 0:02:45 shows the counter in hours, minutes and seconds.

SP/LP: will show the recorded speed of your cassette

'REM 0:06': will show the actual amount of playing/recording time left on the tape in hours and minutes.

When you play an NTSC cassette, the System will show 'REM -:--'.

How can I set the counter to '0:00:00'?

You can set the counter to '0:00:00' with CLEAR.

When you put a cassette in the System, the counter will automatically reset to '0:00:00'.

The counter does not move

This occurs when there are no recordings on a portion of a tape. This is not a fault in your System.

The screen shows '-0:01:20'

If you rewind a cassette from the tape position '0:00:00', the counter will show for instance, '-0:01:20' (the cassette was rewound to 1 minute and 20 seconds before '0:00:00').

'-:--' is displayed in the 'REM' counter

This counter will automatically recognise the length of the tape. In addition, when you put in a cassette the System must first calculate the time played. Therefore, '-:--' appears first and only after the tape has been running for a few seconds, the correct playing time will be shown.

Searching for a tape position with picture (scanning)

- 1 While a cassette is playing, press REW ◀◀ (rewind) or FF ▶▶ (forward) one or more times.
- 2 Press PLAY ► to resume playback.

Still picture / slow motion

- 1 During playback, press PAUSE ■■ to stop the tape and display a still picture.
 - 2 During playback, press SLOW to play the tape in slow motion.
 - 3 Press PLAY ► to resume playback.
- Scanning and still/slow motion interferes with the picture quality. The sound is switched off. This is not a fault in your System.

Searching for tape position without picture (forward wind and rewind)

- 1 Stop the tape with STOP ■.
- 2 Press REW ◀◀ (rewind) or FF ▶▶ (forward).
- 3 To stop the tape, press STOP ■.

Index search

Every time a tape is recorded an index marking is written on the tape.

These marked positions can be found again quickly and easily later.

- 1 To search for the previous marking, press SEARCH/INDEX ► and then REW ◀◀.
- 2 For the next marking, press SEARCH/INDEX ► and then FF ▶▶.
- 3 As soon as the System finds this marking, it automatically switches to playback.

Manual Tracking

To manually adjust the tracking during playback and slow motion playback, press SKIP/P+▶▶ or SKIP/P-◀◀.

Tracking will return to Automatic Tracking Adjustment when you press STOP ■, insert a tape, or press PLAY ►.

To remove vertical jitter in a Still picture, press SKIP/P+▶▶ or SKIP/P-◀◀.

VCR Manual Recording

General information

Use **'Manual Recording'** to make a spontaneous recording (for example, a programme currently being shown).

If you want to start and stop a recording manually, read the section **'Recording without automatic switch-off'**.

Read the section **'Direct Record'** if you want to record a programme currently being shown.

Read the section **'Automatic controlled recording from a satellite receiver (RECORD LINK)'**, if you want a recording to be controlled automatically by a satellite receiver.

Recording without automatic switch-off

- 1 Insert a cassette.
- 2 Use SKIP/P+ ►► / SKIP/P- ◄◄ to select the programme number you want to record, for example, 'P01'.
- 3 To start recording, press REC ●.
- 4 Stop recording with STOP ■.

Linking up recordings (assemble cut)

When you add a further recording to a cassette, which already has a recording on it, a short blank (flicker) can appear between the old and the new recording or the picture itself can flicker.

To help reduce these from occurring, proceed as follows:

- 1 Find the tape position of the old recording where you want to insert the new recording.
- 2 Look at the last minute of the old recording (playback).
- 3 Press PAUSE ■■ at the tape position where the new recording is to go and press REC ●.
- 4 Now start recording as usual by pressing REC ● on the remote control.
- 5 Stop recording with STOP ■.

Selecting the recording speed (SP or LP)

LP allows to double the recording duration on tape (for example six hours instead of three hours on an E180 cassette).

- 1 Switch on the TV set. If required, select the programme number for the System.
- 2 Press DISC/VCR MENU. The main menu will appear.
- 3 Select 'RECORD SETUP' using ▲/▼ and confirm with ►.
- 4 Select 'RECORD SPEED' using ▲/▼.
- 5 Select the required recording speed with ►.

SELECT ▲ ▼ CHOOSE ►
→ RECORD SPEED [SP]
DIRECT RECORD [OFF]
RECORD LINK [OFF]
END=EXIT

'SP'/'LP'/'AUTO'

'SP': StandardPlay (normal recording speed) offers the usual first-class picture quality.

'LP': LongPlay (half recording speed, double recording time). 6 hours can be recorded on a 3-hour cassette (E180) with a somewhat reduced picture quality.

'AUTO': AUTOMATIC Long Play. If there is not enough space on the tape to record a programmed recording in standard speed, the recording is automatically done in 'LP' (Longplay). Otherwise, the recording speed will be 'SP' (Standardplay).

- 6 To end, press DISPLAY/STATUS/EXIT.

Automatic controlled recording from a satellite receiver (RECORD LINK)

This function automatically starts recording on the switched-off System when a video signal is recognised through the connected scart cable. If your satellite receiver has a programming function, the recording will start automatically (as long as the satellite receiver is switched on).

- 1 Use a scart cable to connect scart socket AV2(DECODER) on the System to the corresponding scart socket on the satellite receiver.
- 2 Switch on the TV. If required, select the programme number for the System.
- 3 Press DISC/VCR MENU. The main menu will appear.
- 4 Select 'RECORD SET UP' with ▲/▼ and confirm with ►.
- 5 Select 'RECORD LINK' with ▲/▼.
- 6 Select function 'ON' with ►.
- 7 To end, press DISPLAY/STATUS/EXIT.

SELECT ▲ ▼ CHOOSE ►
RECORD SPEED [SP]
DIRECT RECORD [OFF]
→ RECORD LINK [OFF]
END=EXIT

- 8 Insert a cassette.
- 9 Programme the satellite receiver with the required information (programme number of the TV channel, start time, end time).

If necessary, please see the operating instructions for your satellite receiver.

- 10 Press TIMER SET.

The System is now ready to record. The beginning and end of the recording is controlled via scart socket AV2(DECODER).

'Direct Record'

With Direct Record, you can record the right TV channel in seconds even if your System is switched off. If the recording is started manually, the System uses the current TV channel set on the TV. You will find more information on how to switch 'Direct Record' on or off in the next section. Make sure that your System socket AV1(TV) and the TV are connected by a scart cable.

- 1 On the TV, select the programme number you want make the recording from.
- 2 Press REC ● with the System switched off.
- 3 Stop recording with STOP ■.

How does Direct Record work?

The System compares the TV channel selected on the TV set with its stored TV channels via the scart cable. If the same TV channel is found, it switches the System to the corresponding programme number and starts recording. Please do not change the TV channel on the TV set during the search so as not to affect the process.

Switching 'Direct Record' on or off

- 1 Switch on the TV. If required, select the programme number for the System.
- 2 Press DISC/VCR MENU. The main menu will appear.
- 3 Select 'RECORD SET UP' with ▲/▼ and confirm with ►.
- 4 In 'DIRECT RECORD', select 'OFF' (Direct Record off) or 'ON' (Direct Record on) with ►.
- 5 To end, press DISPLAY/STATUS/EXIT.
- 6 Press STANDBY-ON ○.

SELECT ▲ ▼ CHOOSE ►
RECORD SPEED [SP]
→ DIRECT RECORD [OFF]
RECORD LINK [OFF]
END=EXIT

VCR Manual Recording

Direct dubbing

Follow the steps below to copy a DVD or video disc to a videotape. This will be possible only if the DVD is not copy protected.

- 1 Put a videotape in the cassette compartment. Make sure the tape's record tab is intact and the tape is long enough to record the disc.
- 2 Press VCR.
- 3 Select the recording speed.
Details are at "Selecting the recording speed (SP or LP)".
- 4 Put the DVD you want to copy in the disc tray.
- 5 Press DVD.
- 6 Press PLAY ►. While disc is playing, press PAUSE ■■ at the point you wish to start recording.
- 7 Press DIRECT DUBBING to record.

To pause the recording.

Press PAUSE ■■.

To resume recording.

Press PAUSE ■■ again.

To stop the recording.

Press STOP ■.

Recording(From DVD To VCR)

- 1 Insert a DVD without copyright protection in the tray.
- 2 Insert a video cassette tape with its erase prevention tab in place.
- 3 Select the recording speed.
Details are at "Selecting the recording speed (SP or LP)".
- 4 Enter "004" with numerical key pads to appear "DISC" on the TV screen.
- 5 Press REC ●.
- 6 Change to DVD operation mode.
- 7 Press DVD, then PLAY ► to begin the playback of a DVD.
- 8 Press VCR, then STOP ■ to stop recording.

Programming a Recording (TIMER)

General information

Use a TIMER programming to automatically start and stop a recording at a later time or date. The System will switch to the right programme number and begin recording at the correct time. With this System, you can pre-programme up to eight recordings within a period of one year. To make a programmed recording, your System needs to know:

- * the date you want to make the recording
- * the programme number of the TV channel
- * the start and stop time of the recording
- * VPS or PDC on or off

This information is saved in a TIMER block.

What is 'VPS/PDC'?

'VPS' (Video Programming System)/ 'PDC' (Programme Delivery Control) are used to control the start and duration of TV channel recordings. If a TV programme starts earlier or ends later than scheduled, the System will turn on and off at the correct time.

What do I need to know about 'VPS/PDC'?

Usually the VPS or PDC time is the same as the start time. But if your TV guide shows a VPS or PDC time which is different from the programme's scheduled start time, e.g. 20.10 (VPS/PDC 20.14), you must enter the VPS/PDC time exact to the minute. If you want a start time different from the VPS/PDC time, you must switch VPS/PDC off.

Programming a recording (with the 'SHOWVIEW® system')

SHOWVIEW®

You no longer need to tediously enter the date, programme number, start and end time. All the information needed for programming is contained in the SHOWVIEW-programming number. You can find this SHOWVIEW number in most TV listing magazines written next to the concerned programme.

- 1 Press SV/V+.
- 2 Enter the entire SHOWVIEW number. This number is up to 9 digits long and can be found next to the start time of the TV programme in your TV listing magazine. [e.g. 1-234-5 or 1 234 5]
If you make a mistake, you can clear your input with CLEAR.
- 3 Press SV/V+.
- 4 Select ONCE, DAILY or WEEKLY recording with ▲/▼. Then press ►.

ShowView system
ShowView No.
12345 - - - -
SET=SV/V+
CORRECT=CLEAR
END=EXIT

ShowView system
→ ONCE
DAILY
WEEKLY
SELECT ▲ ▼ CHOOSE ►
END=EXIT

Selecting once/daily/weekly recordings

Using ▲/▼, select from the following options:

- 'ONCE': Recording once
- 'DAILY': Repeated daily recordings (Monday to Friday)
- 'WEEKLY': Repeated weekly recordings (every week on the same day)

'- .' appears at PROG .

* The programme number of the TV channel has not yet been assigned to the SHOWVIEW number. Using the numerical key pads, select the corresponding programme number (name) of the TV channel.

The following message appears on the screen:'ERROR'

- * The entered SHOWVIEW number is incorrect. Correct your input or end with DISPLAY/STATUS/EXIT.
- * Check the time/date (see chapter 'Installing your video', section 'Setting the time and date').
- * A daily recording was entered for the wrong day. Daily programming can only be used for recordings to be made from Monday to Friday.

The following message appears on the screen:'TIMER NOT COMPLETED'

* The channel is wrong.

Programming a Recording (TIMER)

- The decoded data appears after confirmation. You can go back to change the data. Select the corresponding input field using **▶** or **CLEAR**. Change the data with numerical key pads.
- When all inputs are correct, press **DISPLAY/STATUS/EXIT**. The programming information is stored in a Timer block.

Switching on 'VPS/PDC' in the 'START' input field
Select 'VPS/PDC' using **▶** or **CLEAR**. Press '1' to switch off 'VPS/PDC' or press '2' to switch on 'VPS/PDC'.

- Insert a cassette with an intact security tab (unprotected).
- Press **TIMER SET**.
'TIMER REC' will light up on the System.

Programming a recording (without the SHOWVIEW system)

- Press **VCR**, then **DISC/VCR MENU**.

- Select 'TIMER' with **▲/▼**. Then press **▶**.
- Select **ONCE**, **DAILY** or **WEEKLY** recording with **▲/▼**. Then press **▶**. If all Timer blocks are in use, 'FULL' will appear on the OSD.
- Select the desired Timer block with numerical key pads. (The flashing number indicates an empty TIMER block.)

SELECT ▲ ▼ CHOOSE ▶
→ ONCE
DAILY
WEEKLY
TIMER LIST
END=EXIT

Selecting once/daily/weekly recordings

Using **▲/▼**, select from the following options:

'ONCE': Recording once
'DAILY': Repeated daily recordings (Monday to Friday)
'WEEKLY': Repeated weekly recordings (every week on the same day)

- Enter the Start time (START) End time (STOP), Programme number (PROG.), VPS/PDC information and the Date with numerical key pads.

Programme numbers of the 'AV1', 'AV2' and 'AV3' scart socket

You can also programme recordings from external sources via scart socket AV1 (TV), AV2 (DECODER) or AV3 (FRONT).

- When all inputs are correct, press **DISPLAY/STATUS/EXIT**. The programming information is stored in a TIMER block.
- Insert a cassette with an intact security tab (unprotected).
- Press **TIMER SET**.

OTR (One Touch Recording)

This function enables you to set a recording length simply by pressing **RECORD** on the System.

- Follow steps 1 to 2 in "Recording without automatic switch-off" section.
- Press **RECORD** on the System repeatedly until the desired recording length appears.

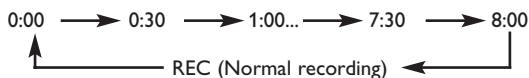

- Recording stops when 0:00 is reached.

To check time remaining during an OTR

Press **DISPLAY/STATUS/EXIT**.

To change the recording length during an OTR

Press **RECORD** until the desired length appears.

To stop an OTR before recording is finished

Press **STOP** ■.

To cancel the OTR but continue recording

Press **RECORD** repeatedly until "REC" appears in the upper left corner of the TV screen.

How to check, or delete a programmed recording (TIMER)

- Press **VCR**, then **DISC/VCR MENU**.
- Press **▲/▼** to select 'TIMER'. Then press **▶**.
- Press **▲/▼** to select 'TIMER LIST', then press **▶**.
- Select timer block with **▶**.
- To cancel the recording, press **CLEAR**.
- To end, press **DISPLAY/STATUS/EXIT**.
- Press **TIMER SET**.

SELECT ▲ ▼ CHOOSE ▶
ONCE
DAILY
WEEKLY
→ TIMER LIST
END=EXIT

How to change a programmed recording (TIMER)

- Press **VCR**, then **DISC/VCR MENU**.
- Press **▲/▼** to select 'TIMER', then press **▶**.
- Press **▲/▼** to select **ONCE**, **DAILY**, or **WEEKLY** recording with **▲/▼**, then press **▶**.
- Select a TIMER block with numerical key pads. (The flashing number indicates an empty TIMER block.)
- Press **CLEAR** to delete information and input correct information with numerical key pads.
- To end, press **DISPLAY/STATUS/EXIT**.
- Press **TIMER SET**.

ONCE
TIMER - 1 2 3 4 5 6 7 8 -
SELECT TIMER NUMBER
END=EXIT

Hints for Timer Recording

- If there is a power failure or the System is unplugged for more than 1 minute, the clock setting and all timer settings will be lost.
- If a tape ends during **TIMER RECORDING**, the System will stop, eject the tape, and switch to the DVD mode automatically as the **TIMER REC** light blinks. (If the DVD power is off, the System will become the **STANDBY** status).
- If a tape is not in the System or does not have a record tab, the **TIMER REC** light flashes and timer recording will not operate. Please insert a recordable tape.
- When timer recordings are set, the **TIMER REC** light will come on. To use the System as usual until the time for the recording, press **TIMER SET** so that the **TIMER REC** light disappears. Press the System to choose **VCR**, **DVD** or **TUNER** modes, then continue with the other features as described in this manual.

'PRESS TIMER SET BUTTON FOR TIMER RECORDING' appears on the screen

* Press **TIMER SET** on several minutes before the start of a programmed recording.

Error message: 'FULL'

- If this error message appears after you select 'ONCE', 'DAILY', or 'WEEKLY' on **TIMER** menu and press **▶**, then all **TIMER** blocks are already programmed. No more recordings can be programmed. If you want to clear or check a programmed recording (**TIMER** block), select the programme number on **TIMER LIST** menu and press **CLEAR**.

Other Functions

Switching the status display off or on

Along with the on screen menu, the status display also displays information on the current operating status (counter, playback, recording, TV channel, etc.) on the TV screen. You can switch off the information about the operating status so that the status display is not recorded when copying videocassettes.

- 1 Press VCR, then DISC/VCR MENU.
- 2 Press ▲/▼ to select 'VCR SET UP', then press ►.
- 3 Press ▲/▼ to select 'STATUS DISPLAY', then press ►.
- 4 Press ▲/▼ to select 'ON' or 'OFF', then press ►.
- 5 To end, press DISPLAY/STATUS/EXIT.

SELECT ▲▼ CHOOSE ►	
→STATUS DISPLAY	[ON]
BLUE BACKGROUND	[ON]
CLOCK DISPLAY	[ON]
END=EXIT	

Which settings can I choose?

'ON': Shows the status display for a few seconds only.
'OFF': Switches off the status display.

Blue Background on or off

If you want the TV screen to be solid blue when a weak signal is received, set BLUE BACKGROUND to 'ON'. The screen will be blue and the sound will be muted. Or, if you want to receive the weak signal, set BLUE BACKGROUND to 'OFF'.

- 1 Press VCR, then DISC/VCR MENU.
- 2 Press ▲/▼ to select 'VCR SET UP', then press ►.
- 3 Press ▲/▼ to select 'BLUE BACKGROUND', then press ►.
- 4 Select 'OFF' (no blue background) or 'ON' (blue background on) with ►.
- 5 To end, press DISPLAY/STATUS/EXIT.

SELECT ▲▼ CHOOSE ►	
STATUS DISPLAY	[ON]
→BLUE BACKGROUND	[ON]
CLOCK DISPLAY	[ON]
END=EXIT	

Clock Display

This function allows you to switch the System display off. It is useful in case you feel disturbed by the display-brightness while watching TV in a dark room. It also reduces the power consumption.

- 1 Press VCR, then DISC/VCR MENU.
- 2 Press ▲/▼ to select 'VCR SET UP', then press ►.
- 3 Press ▲/▼ to select 'CLOCK DISPLAY', then press ►.
- 4 Select 'OFF' (no clock display) or 'ON' (clock display on) with ►.
- 5 To end, press DISPLAY/STATUS/EXIT.

SELECT ▲▼ CHOOSE ►	
STATUS DISPLAY	[ON]
→BLUE BACKGROUND	[ON]
→CLOCK DISPLAY	[ON]
END=EXIT	

Selecting the sound channel

You can select the desired sound channel during playback or while receiving TV channels via the System. This allows you to select a desired language for multi-language transmissions.

- 1 Press AUDIO/BAND. This will show the current sound setting.
- 2 Press AUDIO/BAND until the desired setting appears in the display.

• During reception of bilingual broadcasts:

Mode	AUDIO OUTPUT		Display on the TV screen
MAIN	L	Main Audio	MAIN
	R	Main Audio	
SUB	L	Sub Audio	SUB
	R	Sub Audio	
MAIN SUB	L	Main Audio	MAIN SUB
	R	Sub Audio	

• Reception of stereo broadcasts:

Mode	AUDIO OUTPUT		Display on the TV screen
Stereo	L	L Audio	STEREO
	R	R Audio	
L	L	L Audio	LEFT
	R	L Audio	
R	L	R Audio	RIGHT
	R	R Audio	
Monaural	L	L+R Audio	NONE
	R	L+R Audio	

• During playback of the recorded tape in Hi-Fi mode:

Mode	AUDIO OUTPUT		Display on the TV screen
Stereo	L	Hi Fi L Audio	STEREO
	R	Hi Fi R Audio	
L	L	Hi Fi L Audio	LEFT
	R	Hi Fi L Audio	
R	L	Hi Fi R Audio	RIGHT
	R	Hi Fi R Audio	
Monaural	L	Normal Audio	MONO
	R	Normal Audio	
MIX	L	Hi Fi L Audio + Normal Audio	MIXED
	R	Hi Fi R Audio + Normal Audio	

Digital Sound

Digital Sound lets you enjoy special sound effects that have preset equalizer settings, providing the best music reproduction. The default setting of the System is OPTIMAL.

- 1 Press SOUND repeatedly to select OPTIMAL, CLASSIC, POP, or JAZZ. The selected Digital Sound light will appear on the front of the System.

Surround Sound

For proper Surround Sound, connect the speakers and Subwoofer correctly. The Center and Rear (Surround) speakers only operate when Surround is On. The Discs or TV programs must be recorded or broadcast in Surround Sound.

- 1 Press SURROUND to set Surround to On or Off. When Surround is On, the SURR (Surround) light will appear on the front of the System. When Surround is Off, the SURR (Surround) light will be off. Programs broadcast in Stereo will produce some surround sound effects when played in a surround mode. However, non-Stereo programs will not have any sound at the Rear (Surround) speakers.

The following Surround Sound modes may be broadcast by DVDs or TV stations. You cannot alter these Surround Sound options at the System.

Matrix: Delivers sound through 5.1 Channels. You will have sound at all five speakers (Front Left and Right, Center, and Rear (Surround) Left and Right).

Dolby Digital: Dolby Digital is a high-quality audio compression technology first used in movies. This technology has since been adopted for use in Consumer Electronic products and allows you to enjoy the same type of sound in your home. Your player has a built-in Dolby Digital decoder so you can enjoy DVDs that include a Dolby Digital soundtrack.

You can identify DVDs and equipment that contain Dolby Digital by looking for the following logo: 

Dolby Pro Logic: A two-channel analog format that provides sound through four speakers (Front Left and Right, Center, and a single Rear (Surround)) when using a Dolby ProLogic Decoder. It is compatible with a Stereo, but you will only have two-channel sound (left and right) at the Stereo.

DTS (Digital Theater System): Developed by Digital Theater Systems, Inc., of the United States. Sound is compressed to reduce its recording size. Since the compression level is less than Dolby Digital, the quantity of data is greater when decoded, providing clarity and depth in the sound. The sound has a wider dynamic range and higher resolution.

Note:

- Surround Sound is not available when you are using headphones. The SURROUND light will turn off.



Playing a Disc

Basic Playback

Getting Started

Turn on the power of the TV, amplifier and any other components which are connected to the DVD system.

Make sure the TV and audio receiver (commercially available) are set to the correct channel.

- 1 Press STANDBY-ON .
- 2 Press DVD, then OPEN/CLOSE  to open disc loading tray.
- 3 Place the chosen disc in the tray, with the label facing up.
- 4 Press PLAY .

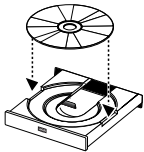

- The tray will close automatically, and playback will then start from the first chapter or track of the disc. If the playback does not start automatically, press PLAY .



- When you playback the DVD which a title menu is recorded, it may appear on the screen. In this case, refer to "Title Menu".

- 5 Press STOP  to stop playback.





Notes:

- A "prohibited icon" may appear at the top-right on the TV screen during operation, warning that a prohibited operation has been encountered by the DVD system or the disc. 
- With DVDs that use some titles for playback program signals, playback may start from the second title, or it may skip these titles.
- During the playback of two layered disc, pictures may stop for a moment. This happens when the 1st layer switches to the 2nd layer. This is not a malfunction.

Cancelling and Calling Back PBC Function

- 1 Insert a Video CD.
 - Playback will start automatically.
- 2 Press STOP .
- 3 Press numerical key pads to enter the desired track number.
 - PBC function is now cancelled and the playback of the Video CD will start.
- 4 To call back PBC function, press STOP  twice, and then press PLAY .
 - Title menu will appear on the display.



General Features

DVD or video CDs may contain menus to navigate the disc and access special features. Press the appropriate numerical key pads or use Arrow (, , , ) to highlight your selection in the DVD main menu and press OK to confirm.





Note:

- Unless stated, all operations described are based on remote control use. Some operations can be carried out using the menu bar on the TV screen.





Pause

- 1 During playback, press PAUSE .
 - Playback will pause and sound will be muted.
- 2 To continue playback, press PLAY .

Disc Menus

- 1 Press DVD, then DISC/VCR MENU.
 - The DVD main menu will appear.
- 2 If the feature is not available,  symbol may appear on the TV screen.
- 3 If disc menu is available on the disc, audio language, subtitle options, chapters for the title and other options will appear for selection.
- 4 Press Arrow (, , , ) to select an item, and OK to confirm selection.

Title Menu

- 1 Press DVD, then TITLE.
 - The title menu will appear.
- 2 If the feature is not available,  symbol may appear on the TV screen.
- 3 Press Arrow (, , , ) to select an item, and OK to confirm selection.
 - Playback will begin at the selected Title.

- 1 The title menu will appear.
- 2 Press numerical key pads to select the menu.
 - Playback will start.



Calling Up a Menu During Playback

- Press DISC/VCR MENU to call up the DVD main menu.
- Press TITLE to call up the title menu.



Note:

- Contents of menus and corresponding menu operations may vary between discs. Refer to the manual accompanying the disc for details.

Step by Step Playback

- 1 During playback, press PAUSE .
 - Playback will pause and sound will be muted.
- 2 The disc goes forward by one frame each time PAUSE  is pressed.
- 3 To exit step by step playback, press PLAY .



Resume

- 1 During playback, press STOP .
- 2 Press PLAY , playback will resume from the point at which playback was stopped.
 - To cancel resume, press STOP  twice.







Notes:

- The resume information stays on even when the power is turned off.
- Some Video CDs with PBC function resume playback from the beginning of the track.

Fast Forward / Reverse Search

- 1 During playback, press FF  or REW  repeatedly to select the required forward or reverse speed: x2, x8, x50, x100.
 - For video CDs, the speed is fixed at x2, x8, x30.
 - For audio CDs, the speed is fixed at x16.
 - For MP3, the speed is fixed at x8.
- 2 To return to normal playback, press PLAY .

Slow Forward / Slow Reverse

- 1 During playback, press PAUSE .
- 2 Press FF  or REW .
 - Slow motion playback will begin and sound will be muted.
- 3 Press FF  or REW  repeatedly to select the required speed: 1/16, 1/8, 1/2 of the normal playback.
- 4 To return to normal playback, press PLAY .

Note:

- Slow Reverse is not available on video CDs.

Zoom DVD-V VCD

The Zoom function allows you to enlarge the video image and to pan through the enlarged image.

- 1 Press ZOOM during playback.
 - Playback will continue.
- 2 Press ZOOM repeatedly to select the required zoom factor: x2, x4 or OFF.
- 3 Use Arrow (▼ / ▲ / ► / ◀) to move the zoomed picture across the screen.
- 4 To exit zoom mode, press ZOOM to OFF.

Notes:

- **Zooming function does not work while disc menu is shown.**
- **x4 zoom is not available on some discs.**
- **only x2 zoom is available on video CDs.**

Track CD VCD

There are three ways to begin playback on an Audio CD at a specific Track.

Using the Numerical key pads

- 1 Press **numerical key pads** to enter the desired Track number.
 - Playback will start at the selected track.
 - For single digit tracks (1-9), press a single number (eg. track 3, press 3).
 - To play track 26, press +10, 2, 6 on the numerical key pads.

Using the SEARCH MODE

- 1 Press SEARCH/INDEX ►.
 - The track search display appears.
- 2 Within 30 seconds, select a desired track number using numerical key pads. For single digits press "0" first.
 - Playback will start at the selected track.

Using the SKIP/P- ◀◀ , SKIP/P+ ▶▶

During playback, press SKIP/P+ ▶▶ to move to the next track. Press it repeatedly to skip subsequent tracks. Press SKIP/P- ◀◀ to go back to the beginning of the current track. Press it repeatedly to go to the previous tracks.

- Track number will appear briefly on the DVD system display panel.
- If SKIP/P+ ▶▶ is pressed while the playback is paused, the playback will be paused again after skipping to the next track.

Note:

- **SKIP/P- ◀◀ , SKIP/P+ ▶▶ are not available when playback is stopped.**

Title / Chapter Search DVD-V

- 1 Press SEARCH/INDEX ► once for the Chapter search, twice for the Title search during playback.
- 2 Enter the desired chapter/title number using numerical key pads.

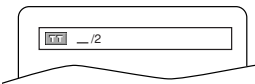
**Time Search** DVD-V CD VCD

- 1 During playback, press SEARCH/INDEX ► three times (CD/VCD: twice) to display the Time Search on the TV screen.
- 2 Within 30 seconds, enter a desired disc time using numerical key pads.
 - Playback will start at the specified time.
- 3 Press CLEAR to erase the incorrect input.

Repeat

- **REPEAT** are available only during playback.

Repeat Title / Chapter DVD-V

To activate the repeat function, press REPEAT during playback.

- The repeat mode changes as described below every time you press the button.

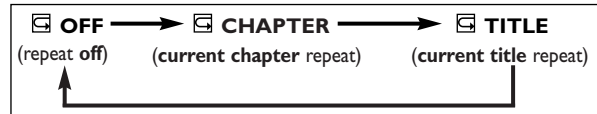
**Notes:**

- **Repeat Title/Chapter is not available with some scenes.**
- **The REPEAT setting will be cleared when moving to other title or chapter.**

Repeat Track CD VCD

To activate the repeat function, press REPEAT during playback.

- The repeat mode changes as described below every time you press the button.

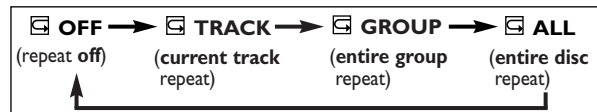
**MP3****Notes:**

- **The REPEAT setting will be cleared when moving to other track.**
- **Repeat playback does not function during repeat A-B playback.**

Repeat at A-B DVD-V CD VCD

- 1 Press REPEAT A-B at your chosen starting point.
 - A- appears briefly on the TV screen.
- 2 Press REPEAT A-B again at your chosen end point.
 - A-B appears briefly on the TV screen, and the repeat sequence begins.

- 3 To exit the sequence, press REPEAT A-B.



Notes:

- **The repeat A-B section can only be set within the current title (for DVDs), or current track (for audio CDs).**
- **Repeat A-B is not available with some scenes in DVD.**
- **To cancel the A point which was set, press CLEAR.**
- **Repeat A-B playback does not function during title, chapter, track or all repeat playback.**

Playing a Disc







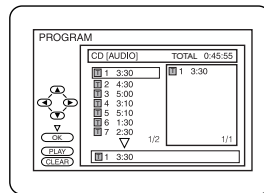

Program

You may determine the order in which tracks will play.

- In stop mode press MODE/SYSTEM.
 - The PROGRAM screen will appear.
- Press  or  to select a track, then press OK.
 - Press CLEAR to erase the most recently entered program.
- Press PLAY  to play the programmed tracks.



Notes:

- While the program is being played back, the STOP  works as follows.
 - Press STOP  once and then PLAY  again, playback will restart from the point where STOP  was pressed. (Program continued)
 - Press STOP  twice and then PLAY  again, playback will restart from the track in the usual way. (Program cleared)
- Up to 99 programs can be entered.
- If you like to repeat the current track in the program, press REPEAT repeatedly until  TRACK appears during playback. If you like to repeat the entire program press REPEAT repeatedly until  ALL appears during playback.



Random Playback

This shuffles the playing order of tracks instead of playback in the sequence.

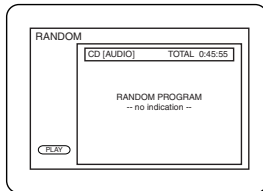
- In stop mode, press MODE/SYSTEM twice.
 - RANDOM screen appears.
- Press PLAY  to start random playback.









Note:

- If you like to repeat the current track in the random selection, press REPEAT repeatedly until  TRACK appears during playback. If you like to repeat the entire random selection press REPEAT repeatedly until  ALL appears during playback.

MP3/JPEG Playback

When a CD with MP3 or JPEG files is inserted in the DVD system, the MP3 or JPEG menu will appear on the TV screen, and number of tracks is displayed on the front panel.

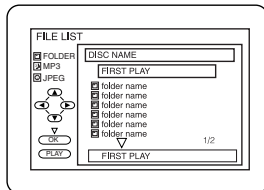

- In stop mode, press  or  to select the desired group, MP3 track or JPEG file.
 - If a group is selected, press PLAY  or OK to go on to the track selection screen. Press  or  to choose a track, then press PLAY  or OK.



- If a track is selected, press PLAY  or OK to start playing tracks. Starting from the one you've just chosen the subsequent tracks will be played.
- Choose FIRST PLAY to start playback from the beginning of the listed tracks.
- Press TITLE to return to the first item.

- Press STOP  to stop playback.

Notes:





- Folders are known as Groups; files are known as Tracks.
- MP3 files are accompanied by  icon.
- JPEG files are accompanied by  icon.
- Maximum of 255 folders can be recognized.
- Maximum of 256 files can be recognized.
- Up to 8 hierarchies can be created.

This DVD system recommends the use of files recorded at the below specifications:









- Sampling frequency: 44.1kHz or 48kHz
- Constant bit rate: 112kbps ~ 320kbps.

On-Screen Information

You can check the MP3 files during playback.

- Press DISPLAY/STATUS/EXIT.
 - The name of the file currently in play will be displayed.
- Press DISPLAY/STATUS/EXIT again to show the track number, the elapsed time, the repeat status, and the playback status at the top of the screen.
 -  will be displayed when the repeat play has been selected.
 -  T - indicates Track repeat
 -  G - indicates Group (folder) repeat
 -  A - indicates Disc repeat
- Press DISPLAY/STATUS/EXIT again to exit.

Track Selection

- Press SEARCH/INDEX  during playback.
 - The FILE LIST will appear.
- Select a desired track using Arrow (, , , ).
 - Press  when you want to go to the next hierarchy.
 - Press  when you want to go back to the previous hierarchy.
- Press PLAY  to start playing

Notes:



- Press SEARCH/INDEX  to EXIT.
- Some selections may take a while to be recognized.

Random Playback

- Press MODE/SYSTEM twice while playback is stopped.
- Press PLAY  to play the tracks in random order.

Program

This feature allows you to program a mp3 disc to play in a desired sequence.

- Press MODE/SYSTEM during playback is stopped.
 - The PROGRAM screen will appear.
- Press  or  to select a track, then press OK, to save it in a program.
 - Press CLEAR to erase the incorrect input.
- Press PLAY  to start programmed playback.

Audio Language

The DVD system allows you to select a language during DVD disc (if multi language available) playback.

- Press AUDIO/BAND during playback.
- Press AUDIO/BAND repeatedly to select your desired language.

Notes:

- Pressing AUDIO/BAND may not work on some DVDs with multiple audio languages (e.g. DVDs which allow audio language setting on the disc menu).
- Some discs allow audio language setting on the disc menu. (Operation varies between discs, so refer to the manual accompanying the disc.)

Stereo Sound Mode

- Press AUDIO/BAND repeatedly during playback to select between STEREO, L-CH or R-CH.
 - STEREO - both right and left channels are active (stereo)
 - L-CH - only left channel is active
 - R-CH - only right channel is active

Subtitle Language

The DVD system allows you to select a language for subtitle during DVD disc (if available) playback.

- 1 Press DVD, then SUBTITLE during playback.
- 2 Press SUBTITLE repeatedly to select your desired subtitle language.
 - The selected language will be displayed on the display bar at the top of the screen.
- 3 To turn off subtitles, press SUBTITLE repeatedly until OFF appears.

Notes:

- Some discs allow subtitle language setting on the disc menu. (Operation varies between discs, so refer to the manual accompanying the disc.)
- If the desired language is not shown after pressing SUBTITLE several times, the disc does not have subtitles in that language.
- If you choose a Language that has a 3 letter language code, the code will be displayed every time you change the Subtitle language setting. If you choose any other languages, '---' will be displayed instead. (Details are on page 21.)

Camera Angle

Some DVD discs contain scenes which have been shot simultaneously from various angles. You can change the camera angle when the  icon appears on the screen.

- 1 Press DVD, then ANGLE during playback.
 - The selected angle will be displayed on the display bar at the top of the screen.
- 2 Press ANGLE repeatedly to select your desired angle.

Changing the On-Screen Display

You can check information about the current disc by pressing DISPLAY/STATUS/EXIT on the remote control.

- 1 Press DISPLAY/STATUS/EXIT during playback to show current Chapter.
 - ➔ The elapsed and remaining playing time of the current chapter will be displayed.
- 2 Press DISPLAY/STATUS/EXIT again to show current Title.
 - ➔ The elapsed and remaining playing time of the current title will be displayed.
- 3 Press DISPLAY/STATUS/EXIT the third time.
 - ➔ The BIT RATE, layer number (if available) and the current repeat setting will be displayed.
- 4 Press DISPLAY/STATUS/EXIT the fourth time to remove the display.

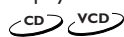

- 1 Press DISPLAY/STATUS/EXIT during playback, the current Track will be displayed on the TV screen.
 - ➔ The elapsed and remaining playing time of the current total track will be displayed.
- 2 Press DISPLAY/STATUS/EXIT again to show current Total Track.
 - ➔ The elapsed and remaining playing time of the current total track will be displayed.
- 3 Press DISPLAY/STATUS/EXIT the third time to remove the display.







Parental Control

Parental Control limits the disc viewing that exceed your settings. (with a password or playback will stop.)

This feature allows you to prevent discs with alternative scenes from being played by your children.



Parental Level

Parental Level allows you to set the rating level of your DVD discs. Playback will stop if the disc's ratings exceed the level you set.

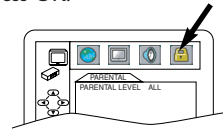
- 1 Press SYSTEM MENU/PROG in STOP mode.
- 2 Press  to select CUSTOM, then press OK.
- 3 Press  or  to select PARENTAL, then press OK.
- 4 Enter your four-digit password then press OK.
- 5 Press  or  to select PARENTAL LEVEL, then press OK.
- 6 Press  or  to select the desired level, then press OK.
- 7 Press SYSTEM MENU/PROG to exit.



Notes:

- When doing this for the first time, enter any 4 digits. (except for 4737) That number will be used as the password from the second time onward.
- To change the password, press  or  to select CHANGE, then press OK. Enter the four-digit password, then press OK.
- With some DVDs, it may be difficult to find if they are compatible with parental lock. Be sure to check if the parental lock function operates in the way that you have set.
- Record the password in case you forget it.

If You Forget the Password

- 1 Press 4, 7, 3, 7 at step 4.
 - Password will be cleared and parental level will be set to ALL.
- 2 Proceed the above steps 4-5 again.

Control Levels

ALL

All parental lock is cancelled.

Level 8

DVD software of any grade (adult/general/children) can be played back.

Levels 7 to 2







Only DVD software intended for general use and children can be played back.

Level 1



Only DVD software intended for children can be played back, with those intended for adult and general use prohibited.

Marker Setup Screen

Use markers to memorise your favourite places on a disc.

- 1 Press SEARCH/INDEX  four times (CD/VCD: three times) during playback.
 - The display screen and Markers will appear on the TV screen.
- 2 Press  or  to select 1, 2, 3, 4, 5, 6, 7, 8, 9, or 10 and ensure that "-- :--" appears in the display.
- 3 When reaches the desired point, press OK.
 - The Title or Track and elapsed playing time will appear in the TV screen.
- 4 To return to the Marker later, press SEARCH/INDEX  four times (CD/VCD: three times) during playback and  or  to choose the desired marker, then press OK.

Notes:

- Opening the disc tray or turning off the power or select AC at step 2 and press OK will erase all Markers.
- To clear a marker, using  or , position the cursor on to the marker number to be cleared and press CLEAR.
- You can mark up to 10 points.

- 5 Press SEARCH/INDEX  or RETURN to exit.

DVD Setup

Audio Setting

Choose the appropriate Audio settings for your equipment as it only affect during the playback of DVD discs of the DVD system.

- 1 Press SYSTEM MENU/PROG in STOP mode.
- 2 Press **▶** to select CUSTOM, then press OK.
 - CUSTOM mode will appear.
- 3 Press **◀** or **▶** to select AUDIO, then OK to confirm.
- 4 Press **▲** or **▼** to select the below items, then press OK.

DRC (Dynamic Range Control) :

To compress the range of sound volume.
The default setting is OFF.

DOLBY DIGITAL : QUICK

Set to ON when the player is connected to Dolby Digital Decoder.
(ON : Output by Dolby Digital)
(OFF : Convert the Dolby Digital to PCM)
The default setting is ON.

DOWN SAMPLING :

Set to ON when outputting in 48kHz.
The default setting is ON.

When playing disc with copyright Protection

- If you select OFF, copyright protection will be activated and sound will be down sampled at 48kHz.

MPEG :

Set to ON when the player is connected MPEG Decoder.
(ON: Output by MPEG)
(OFF: Convert the MPEG to PCM)
• The default setting is OFF.

- 5 Press SYSTEM MENU/PROG to exit.

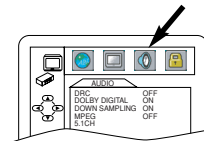
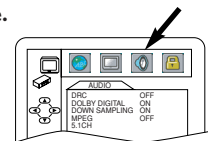

Delay Time

Set the delay time for the Center and Rear (Surround) speakers to suit your listening position. If you usually sit closer to the Center speaker than the Front speakers, increase the Center delay time to improve the Surround Sound effect. If you plan to sit closer to the Rear speakers than the Front speakers, increase the Rear delay time.

- 1 Press DVD to put the DVD system in DVD mode.
 - The red DVD light will be on the front of the DVD system.
Press STOP **■** to stop Disc playback if necessary.
- 2 Press SYSTEM MENU/PROG.
 - The QUICK SETUP screen will appear.
- 3 Press **▶** to select CUSTOM at the top of the menu, then press OK.
 - This menu will appear.
- 4 Press **▶** to select AUDIO at the top of the menu, then press OK.
- 5 Press **▼** to select 5.1CH, then press OK.
- 6 DELAY TIME will be selected. Press OK.
- 7 Press **▲** or **▼** to select CENTER or SURROUND (for the REAR speakers), then press OK.
- 8 Press **▲** or **▼** to select a delay time in milliseconds, then press OK.
 - The default setting for the CENTER Delay time is 0 ms. The default setting for the SURROUND (rear) Delay time is 5 ms.
- 9 Press SYSTEM MENU/PROG to remove the menu.

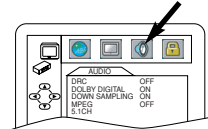

Speaker Balance

You can test the volume balance of each speaker with this procedure.

- 1 Press DVD to put the DVD system in DVD mode.
 - The red DVD light will be on the front of the DVD system.
Press STOP **■** to stop Disc playback if necessary.
- 2 Press SYSTEM MENU/PROG.
 - The QUICK SETUP screen will appear.
- 3 Press **▶** to select CUSTOM at the top of the menu, then press OK.
 - This menu will appear.
- 4 Press **▶** to select AUDIO at the top of the menu, then press OK.
- 5 Press **▼** to select 5.1CH, then press OK.
- 6 Press **▼** to select BALANCE, then press OK.
- 7 TEST will be selected. Press OK.
 - The test sound will come from each speaker (in the order indicated in the menu) so you can check the volume of each speaker.
- 8 Press OK to stop the test.
- 9 Press **▲** or **▼** to select the speaker for which you want to adjust the volume, then press OK.
 - You will hear the test sound from that speaker.
- 10 Press **▲** or **▼** to adjust the volume of the selected speaker, then press OK.
 - The BALANCE menu will reappear, showing the value you selected for that speaker. The available volume range is -6 dB to +6 dB. Press **▲** or **▼** to see all the available dB values.
- 11 Press SYSTEM MENU/PROG to remove the menu.

Note:

- You cannot hear the test sound from the Subwoofer.

Language Setting DVD-V

Language options are not available with some discs.

- 1 Press SYSTEM MENU/PROG in STOP mode.
- 2 Press **▶** to select CUSTOM, then press OK.
 - CUSTOM mode will appear.
- 3 Press **◀** or **▶** to select LANGUAGE, then OK to confirm.
- 4 Press **▲** or **▼** to select the below items, then press OK.

AUDIO :

Sets the audio language.

SUBTITLE :

Sets the subtitle language.

DISC MENU :

Sets the language for DVD Menu.

PLAYER MENU : QUICK

Sets the language for the On-Screen display.

- 5 Press **▲** or **▼** to select a setting, then press OK.
 - If OTHER is selected in the AUDIO, SUBTITLE or DISC MENU screen, press four-digit number to enter the code for the desired language. (Refer to the language code list on page 21).
 - Only the languages supported by the disc can be selected.
- 6 Press SYSTEM MENU/PROG to exit.

Note:

- Language Setting for Audio and Subtitle is not available with some discs. Then use AUDIO and SUBTITLE. Details are on pages 18-19.

Display Setting DVD-V

Use markers to memorise your favourite places on a disc.

- 1 Press SYSTEM MENU/PROG in STOP mode.
- 2 Press ► to select CUSTOM, then press OK.
 - CUSTOM mode will appear.
- 3 Press ◀ or ▶ to select DISPLAY, then OK to confirm.
- 4 Press ▲ or ▼ to select the below items, then press OK.

TV ASPECT : QUICK

Press ▲ or ▼ for an item selection, then press OK.

Select 4:3 LETTER BOX for a black bars appears on top and bottom of the screen.

Select 4:3 PAN & SCAN for a full height picture with both sides trimmed.

Select 16:9 WIDE if a wide-screen TV is connected to the DVD system.

The default setting is 4:3 LETTER BOX.

ANGLE ICON :

Press OK repeatedly to turn Angle icon ON or OFF.

The default setting is ON.

AUTO POWER OFF :

Press OK repeatedly to turn Auto Power off ON or OFF.

The default setting is ON and it will turn the DVD system to off automatically after 35 minutes of no use.

- 5 Press SYSTEM MENU/PROG to exit.

Notes:

- Be sure to press SYSTEM MENU/PROG, or the setting will not work.
- You can also choose the item by pressing the numbers.

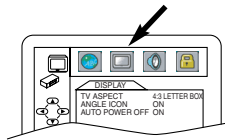

Language	Code	Language	Code	Language	Code	Language	Code
A-B		French [FRE]	5264	Macedonian	5957	Siswat	6565
Abkhazian	4748	Frisian	5271	Malagasy	5953	Slovak	6557
Afar	4747	Galician	5358	Malay	5965	Slovenian	6558
Afrikaans	4752	Georgian	5747	Malayalam	5958	Somali	6561
Albanian	6563	German [GER]	5051	Maltese	5966	Spanish [SPA]	5165
Amharic	4759	Greek [GRE]	5158	Maori	5955	Sundanese	6567
Arabic	4764	Greenlandic	5758	Marathi	5964	Swahili	6569
Armenian	5471	Guarani	5360	Moldavian	5961	Swedish [SWE]	6568
Assamese	4765	Gujarati	5367	Mongolian	5960		T
Aymara	4771	Hausa	5447	Nauru	6047	Tagalog	6658
Azerbaijani	4772	Hebrew	5569	Nepali	6051	Tajik	6653
Bashkir	4847	Hindi	5455	Norwegian [NOR]	6061	Tamil	6647
Basque	5167	Hungarian [HUN]	5467		O-R	Tatar	6666
Bengali;Bangla	4860			Occitan	6149	Telugu	6651
Bhutani	5072	Icelandic [ICE]	5565	Oriya	6164	Thai	6654
Bihari	4854	Indonesian	5560	Oromo(Afan)	6159	Tibetan	4861
Bislama	4855	Interlingua	5547	Panjabi	6247	Tigrinya	6655
Breton	4864	Interlingue	5551	Pashto;Pushto	6265	Tonga	6661
Bulgarian	4853	Inupiak	5557	Persian	5247	Tsonga	6665
Burmese	5971	Irish [IRI]	5347	Polish	6258	Turkish [TUR]	6664
Byelorussian	4851	Italian [ITA]	5566	Portuguese [POR]	6266	Turkmen	6657
	C-E	Japanese [JPN]	5647	Quechua	6367	Twi	6669
Cambodian	5759	Javanese	5669	Rhaeto-Romance	6459		U-Z
Catalan	4947	Kannada	5760	Romanian [RUM]	6461	Ukrainian	6757
Chinese [CHI]	7254	Kashmiri	5765	Russian [RUS]	6467	Urdu	6764
Corsican	4961	Kazakh	5757		S	Uzbek	6772
Croatian	5464	Kinyarwanda	6469	Samoa	6559	Vietnamese	6855
Czech	4965	Kirghiz	5771	Sangho	6553	Volapuk	6861
Danish [DAN]	5047	Kirundi	6460	Sanskrit	6547	Welsh	4971
Dutch [DUT]	6058	Korean [KOR]	5761	Scots Gaelic	5350	Wolof	6961
English [ENG]	5160	Kurdish	5767	Serbian	6564	Xhosa	7054
Esperanto	5161		L-N	Serbo-Croatian	6554	Yiddish	5655
Estonian	5166	Laothian	5861	Sesotho	6566	Yoruba	7161
	F-H	Latin	5847	Setswana	6660	Zulu	7267
Faroese	5261	Latvian;Lettish	5868	Shona	6560		
Fiji	5256	Lingala	5860	Sindhi	6550		
Finnish [FIN]	5255	Lithuanian	5866	Singhalese	6555		

FM/MW Radio

Selecting Radio Station

- 1 Press TUNER to select Tuner mode.
 - The red TUNER light will appear on the front of the System. The current radio frequency (station number) will appear on the display panel.
- 2 Press AUDIO/BAND to select FM or MW.
- 3 Press ◀ or ▶ to select a preset radio station. You also can select a preset radio station by pressing the Number buttons.
 - The preset number will appear in the display panel to the left of the station's frequency. When choosing preset stations 10 and above, enter both digits within two seconds to ensure you enter the complete number.
- 4 Press SKIP/P+ ▶▶| or SKIP/P- |◀◀ to change the radio frequency by one-tenth.
 - For example, to go from 100.1 to 100.2, press SKIP/P+ ▶▶|. Use these buttons to fine-tune the station you want. Or, to search for the next available station, press and hold SKIP/P+ ▶▶| or SKIP/P- |◀◀ for one second, then release. SEARCH will appear on the display panel when you release the button. When a station with sufficient signal strength is found, the station will be tuned and searching will stop. You can press and hold SKIP/P- |◀◀ to search backward to the last available station.

Note:

- **If the sound is distorted during MW reception, press ▲ / ▼ on the remote to reduce the noise. This is effective only for the current MW station. This does not work for every situation. There may be interference from other electrical appliances or weak MW signals.**

Preset Radio Stations

Automatic Presetting

You can store up to 40 preset radio stations automatically by following these steps.

- 1 Press TUNER to select Tuner mode. The red TUNER light will appear on the front of the System.
- 2 Press and hold SYSTEM MENU/PROG until AUTO appears on the System's display panel, then release SYSTEM MENU/PROG. The System will start scanning for stations. FM stations will be set first, followed by MW stations. The System will store the first 40 stations found. When programming is finished, the last preset station will be tuned.
- 3 Or, you can press SYSTEM MENU/PROG or STOP ■ to stop presetting stations. The radio stations scanned so far will be stored. The last stored station will be tuned.

Note:

- **If a radio station has been stored in one of the presets, it will not be stored again under another preset number during Automatic Presetting.**

Manual Presetting

If Automatic Presetting does not memorize all the stations you want, you can preset individual stations manually.

- 1 Press SKIP/P+ ▶▶| or SKIP/P- |◀◀ to select the station you want to designate as a preset station.
- 2 Press SYSTEM MENU/PROG. The next available preset number and the station's frequency will blink in the display panel. To store the station under a different preset number, press ◀ or ▶ to choose a preset number. If Prog ... FULL appears before the station's frequency starts blinking, there are already 40 presets. Press ◀ or ▶ to choose a preset that you want to replace with the new station you are presetting now.
- 3 Within 20 seconds, press SYSTEM MENU/PROG to store the radio station under the designated preset number. (After 20 seconds, the Tuner will exit presetting mode. If you've made a mistake, wait 20 seconds for the frequency and preset number to stop flashing, then try again.)

Note:

- **To erase a preset, press ▶ or ◀ to select the preset station you want to delete. Then, press and hold STOP ■ on the remote until PRESET . . . DELETED appears on the System's display panel. The preset numbers of all other radio stations with higher numbers will decrease by one.**

Maintenance

Cleaning the Cabinet

- Use a soft cloth slightly moistened with a mild detergent solution. Do not use a solution containing alcohol, spirits, ammonia or abrasives.

Cleaning Discs

- When a disc becomes dirty, clean it with a cleaning cloth. Wipe the disc from the centre out. Do not wipe in a circular motion.
- Do not use solvents such as benzene, thinner, commercially available cleaners, or antistatic spray intended for analogue records.

Cleaning the disc lens

- After prolonged use, dirt or dust may accumulate at the disc lens. To ensure good playback quality, clean the disc lens with Philips CD Lens Cleaner or any commercially available cleaner. Follow the instructions supplied with the cleaner.

Specifications

VCR Video Heads

Four heads - Hi-Fi

Antenna

VHF/UHF - 75 ohm external antenna terminal

DVD Color System

PAL

Amplifier

Output power (rms, 4 ohms, 1 kHz, 10% Total Harmonic Distortion) 360W total
 - Front 75W/channel
 - Center 75W
 - Rear (Surround) 75W/channel
 - Subwoofer 75W

FTC (Federal Trade Commission)
 (4 ohms, 120 Hz to 12.5 kHz,
 10 % Total Harmonic Distortion)
 2 X 60W

Frequency Response

DVD (linear sound):
 20 Hz to 22 kHz
 (sample rate: 48 kHz)
 20 Hz to 44 kHz (surround off)
 (sample rate: 96 kHz)
 Audio CD: 20 Hz to 20 kHz

Signal-to-Noise Ratio

Audio CD: 120 dB (JEITA:
 Japan Electronics and Information Technology
 Industries Association)

Dynamic Range

DVD (linear sound): 99 dB
 Audio CD: 99 dB (JEITA)

Total Distortion Factor

Audio CD: 0.003% (JEITA)
 DVD: 0.003%

Wow and Flutter

Below the measurement limitation
 ($\pm 0.001\%$ W PEAK) (JEITA)

Power Requirement

220–240V AC, 50 Hz

Power Consumption

Power on: 50 W
 Power off (standby): 5 W
 (When CLOCK DISPLAY set to OFF.)

Operating Temperature

5°C to 40°C

Relative Humidity

30% to 80%

Dimensions (w x h x d)

Receiver (System):
 43.5 x 9.9 x 39.2 cm

Front Speakers:
 9.4 x 15.5 x 8.9 cm

Rear Speakers:
 9.4 x 15.5 x 8.9 cm

Center Speaker:
 43.5 x 7.2 x 6.4 cm

Subwoofer:
 19.6 x 39.1 x 43.2 cm

Weight

7.8 kg

NOTE: Designs and specifications are subject to change without notice.

Troubleshooting

Problem	Solution
No power	– Check if the AC power cord is properly connected.
No picture	– Check if the TV is switched on. – Check the video connection.
Distorted picture	– Sometimes a small amount of picture distortion may appear. This is not a malfunction.
Completely distorted picture or black/white picture with DVD	– Connect the DVD system directly to the TV. – Make sure the disc is compatible with the DVD system.
No sound or distorted sound	– Adjust the volume. – Check that the speakers are connected correctly.
No audio at digital output	– Check the digital connections. – Check if the audio format of the selected audio language matches your receiver capabilities.
No DTS audio at analog output	– Use a DIGITAL AUDIO OUT jack when outputting the DTS audio.
No sound and picture	– Check that the SCART cable is connected to the correct device (See Connecting to a TV)
Picture freezes momentarily during playback	– Check the disc for fingerprints/scratches and clean with a soft cloth wiping from centre edge. – This may happen when you use the disc recorded in the non-seamless manner. This is not a malfunction.
Disc can't be played	– Ensure the disc label is facing up. – Check if the disc is defective by trying another disc.
No return to start-up screen when disc is removed	– Reset the unit by switching the DVD system off, then on again.
The System does not respond to the remote control	– Aim the remote control directly at the sensor on the front of the System. – Reduce the distance to the System. – Replace the batteries in the remote control. – Re-insert the batteries with their polarities (+/– signs) as indicated.
Buttons do not work or the System stops responding	– To completely reset the System, unplug the AC cord from the AC outlet for 5-10 seconds.
The System does not respond to some operating commands during playback.	– Operations may not be permitted by the disc. Refer to the instructions of the disc.
The DVD system cannot read CDs/DVDs	– Use a commonly available cleaning CD/DVD to clean the lens before sending the DVD system for repair.
The System switches from DVD mode to VCR mode after 35 minutes	– Playback will stop for more than 35 minutes and no button is pressed.
The VCR do not record a TV program	– Make sure the tape has a record tab. – Make sure the System is in VCR position. – Check the TV and the System channel are similar.
The System does not perform a timer	– Make sure the recording start and stop times are set correctly. – Make sure the tape has a record tab. – Make sure the clock is set. – The System may not perform or continue a timer recording if the power fails for more than 1 minute.
The motor (cylinder) rotates even when tape playback is stopped	– To enable quick play mechanism, the cylinder will rotate for about five minutes. This is normal.
You cannot insert a tape	– Insert a tape, window side up with the record tab facing you. – Gently push on the center of the tape when putting into the System.
You cannot remove a tape	– Make sure the power plug is completely connected to a power outlet.
The System ejects the tape when you press REC or TIMER SET for a timer recording.	– Make sure the tape has a record tab.
Radio reception is poor.	– If the signal is too weak, adjust the antenna or connect an external antenna for better reception. – Increase the distance between the System and your other electronics equipment.

If you are unable to remedy a problem by following these hints, consult your dealer or service centre (HOTLINE).

PHILIPS NORGE AS

Sandstuveien 70,
PO Box 1, Manglerud
N-0612 Oslo
NORWAY
Phone: 2274 8250

OY PHILIPS AB

Sinikalliontie 3,
02630 Espo
Helsinki
FINLAND
puh. 09 615 80 250

PHILIPS KUNDTJÄNST

Kollbygatan 7,
Akalla,
16485 Stockholm
SWEDEN
Phone: 08-598 52 250

PHILIPS POLSKA

AL. Jerozolimskie 195B
02-222 Warszawa
POLSKA
Tel.: (022)-571-0-571

PHILIPS SERVICE

V Mezihori 2
180 00 Prague
CZECH REPUBLIC
Phone: (02)-3309 9240

PHILIPS Iberia, S.A.

C/Martinez Villergas, 49
28027 MADRID
SPAIN
Phone: 902-11 33 84

ΦΙΛΙΠΣ ΕΛΛΑΣ ΑΕΒΕ

25ΗΣ ΜΑΡΤΙΟΥ 15
177 78 ΤΑΥΡΟΣ
ΑΘΗΝΑ
Τηλ. 00800 3122 1280

PHILIPS

Österreichische Philips Industrie
GmbH
Triesterstrasse 64
1101 Wien
AUSTRIA
Tel: 0810 001 203

PHILIPS INFO CENTER

Alexanderstrasse 1
20099 Hamburg
GERMANY
Tel: 0180-53 56 767

SERVICE CONSOMMATEURS

PHILIPS
BP 0101
75622 Paris Cédex 13
FRANCE
Phone: 0825-889 789

**PHILIPS ELECTRONICS
IRELAND LIMITED**

Consumer Information Center
Newstead, Clonskeagh
DUBLIN 14
Phone: 01-7640292

**PHILIPS CONSUMER
ELECTRONICS**

Servizio Consumatori
Via Casati 23
20052 Monza - Milano
ITALY
Phone: 800 820026

PHILIPS MÁRKASZERVIZ

Kinizsi U 30 - 36
Budapest 1092
HUNGARY
Phone: (01)-2164428

PHILIPS PORTUGUESA, S.A.

Consumer Information Center
Rua Dr. António Loureiro Borge, nr.5
Arquiparque, Miraflores
P-2795 L-A-VEHLA
PORTUGAL
Phone: 021-4163063

PHILIPS CE, The Philips Centre,

420 - 430 London Road,
Croydon, Surrey
CR9 3QR
UNITED KINGDOM
Phone: 0208-665-6350

CONSUMER SERVICES

Prags Boulevard 80. PO Box 1919,
DK-2300 Copenhagen S
DANMARK
Tlf: 32 88 32 00

**PHILIPS REPRESENTATION
OFFICE**

Ul. Usacheva 35a
119048 MOSCOW
RUSSIA
Phone: 095-937 9300

PHILIPS INFO CENTER

Fegjstrasse 5
8957 Spreitenbach
SUISSE
Tel.: 0844-800 544

**PHILIPS CUSTOMER CARE
CENTER**

Twee Stationsstraat 80/
80 Rue des Deux Gares
1070 BURSSEL/BRUXELLES
BELGIUM (for BENELUX)
Tel: 070-222303

Meet Philips at the Internet
<http://www.philips.com>



The products and services described herein are not necessarily available in all countries
Due to continuous product improvements this document is subject to change without notice.

Printed in China
0VMN03815 / E9017FD****

Free Manuals Download Website

<http://myh66.com>

<http://usermanuals.us>

<http://www.somanuals.com>

<http://www.4manuals.cc>

<http://www.manual-lib.com>

<http://www.404manual.com>

<http://www.luxmanual.com>

<http://aubethermostatmanual.com>

Golf course search by state

<http://golfingnear.com>

Email search by domain

<http://emailbydomain.com>

Auto manuals search

<http://auto.somanuals.com>

TV manuals search

<http://tv.somanuals.com>