

Video Cassette Recorder &  
DVD Video Player / Recorder

DVDR3320V

Visit us at [www.philips.com/support](http://www.philips.com/support) for service support



**Owner's Manual**  
**Manuel de l'utilisateur**  
**Bedienungsanleitung**  
**Instrukcja obsługi**  
**Navod k pouziti**  
**Bruksanvisning**  
**Betjeningsvejledning**  
**Käyttöohje**

**PHILIPS**

## Safety Precautions



**CAUTION**  
RISK OF ELECTRIC SHOCK  
DO NOT OPEN



**CAUTION:** TO REDUCE THE RISK OF ELECTRIC SHOCK DO NOT REMOVE COVER (OR BACK) NO USER-SERVICEABLE PARTS INSIDE REFER SERVICING TO QUALIFIED SERVICE PERSONNEL.



This lightning flash with arrowhead symbol within an equilateral triangle is intended to alert the user to the presence of uninsulated dangerous voltage within the product's enclosure that may be of sufficient magnitude to constitute a risk of electric shock to persons.



The exclamation point within an equilateral triangle is intended to alert the user to the presence of important operating and maintenance (servicing) instructions in the literature accompanying the product.

**WARNING:** TO REDUCE THE RISK OF FIRE OR ELECTRIC SHOCK, DO NOT EXPOSE THIS PRODUCT TO RAIN OR MOISTURE.

**WARNING:** Do not install this equipment in a confined space such as a book case or similar unit.

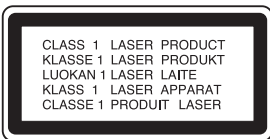

### CAUTION:

This DVD Recorder employs a Laser System.

To ensure proper use of this product, please read this owner's manual carefully and retain for future reference should the unit require maintenance, contact an authorized service location (see service procedure).

Use of controls, adjustments, or the performance of procedures other than those specified herein may result in hazardous radiation exposure.

To prevent direct exposure to laser beam, do not try to open the enclosure. Visible laser radiation when open. DO NOT STARE INTO BEAM.

**CAUTION:** The apparatus should not be exposed to water (dripping or splashing) and no objects filled with liquids, such as vases, should be placed on the apparatus.



This product is manufactured to comply with the radio interference requirements of EEC DIRECTIVE 89/336/EEC, 93/68/EEC and 73/23/EEC.

### NOTES ON COPYRIGHTS:

It is forbidden by law to copy, broadcast, show, broadcast via cable, play in public, or rent copyrighted material without permission.

This product features the copy protection function developed by Macrovision. Copy protection signals are recorded on some discs. When recording and playing the pictures of these discs on a VCR, picture noise will appear.

This product incorporates copyright protection technology that is protected by method claims of certain U.S. patents and other intellectual property rights owned by Macrovision Corporation and other rights owners. Use of this copyright protection technology must be authorized by Macrovision Corporation, and is intended for home and other limited viewing uses only unless otherwise authorized by Macrovision Corporation. Reverse engineering or disassembly is prohibited.

**SERIAL NUMBER:** The serial number is found on the back of this unit. This number is unique to this unit and not available to others. You should record requested information here and retain this guide as a permanent record of your purchase.

Model No. \_\_\_\_\_

Serial No. \_\_\_\_\_

## SHOWVIEW®

SHOWVIEW is a registered trademark of Gemstar Development Corporation.

The SHOWVIEW system is manufactured under licence from Gemstar Development Corporation.

## Index

---

English ..... 4

English

Français .....62

Français

Deutsch .....121

Deutsch

Polski .....180

Polski

Česky ..... 239

Česky

Svenska .....298

Svenska

Dansk ..... 357

Dansk

Suomi .....416

Suomi

# Table of Contents

## INTRODUCTION

Safety Precautions	2
Index	3
Table of Contents	4-5
Overview	6-11
Recordable Discs	6
Playable Discs	6
Disc-related terms	7
• Types of video CDs	7
About Symbols	7
• About the ∅ symbol display	7
• About the disc symbols for instructions	7
About DVD+R and DVD+RW disc	8
About DVD recording	9
• Disc types and recording formats, modes, and settings	9
• Notes for recording	9
• Recording TV audio channels	10
• Restrictions on video recording	10
• Copyright	10
Remote Control Operation Range	10
Remote Control Battery Installation	10
Reset the Recorder	10
Precautions	11
• Handling the unit	11
• Cleaning the unit	11
Notes on Discs	11
• Handling discs	11
• Storing discs	11
• Cleaning discs	11
Front Panel	12
Function Display Window	13
Remote Control Overview	14
Rear Panel	15

## HOOKUP

Connections	16-19
Connecting to the Aerial	16
Connections to Your TV	16
Connecting to a cable box or satellite receiver	17
Connecting an external decoder box	17
Connecting to an Amplifier	18
Accessory Audio/Video (A/V) Connections to Recorder	19
Connecting a Digital Camcorder	19
Before Operation	20-33
Initial Settings	20
General Operation	20
GENERAL	20-24
• Auto Programming	20
• Program Edit	21-22
• Clock Set	23
• TV Aspect	23
• VCR Play Aspect	23
• VCR Play System	24
• AV2 Connection	24
• Progressive Scan	24
• Factory Setting	24
LANGUAGE	24
• Display Language	24
• Disc Language	24
AUDIO	25
• Dolby Digital	25
• MPEG	25
• Sampling Frequency	25
• DRC (Dynamic Range Control)	25
• Vocal	25
LOCK (Parental Control)	26
• Set Password	26
• Rating	26
• Area Code	27
RECORD	27
• Disc Record Mode	27
• VCR Record Mode	27
• VCR Record System	28
• DV Record Audio	28
• Auto Chapter	28
DISC	28-30
• Initialize	28
• Finalize	29
• Disc Label	29
• Disc Protect	30
• PBC	30
• Auto Play	30
• About DivX(R)	30
General Explanation of On-Screen Display	31-33
• Displaying Information on-screen	31-33
• Displaying Information While Watching TV	31
• Changing TV Channels	31
• Changing TV Audio Channel	31

# Table of Contents

## PLAYBACK

<b>Operation with DVD and Video CD</b> . . . . .	<b>34-37</b>
Playing a DVD or Video CD . . . . .	34
General Feature . . . . .	34
• Moving to another TITLE . . . . .	34
• Moving to another CHAPTER/TRACK . . . . .	34
• Search . . . . .	34
• Still Picture and Frame-by-Frame Playback . . . . .	34
• Slow Motion . . . . .	35
• Repeat . . . . .	35
• Repeat A-B . . . . .	35
• Time Search . . . . .	35
• Zoom . . . . .	36
• Marker Search . . . . .	36
• Checking the contents of DVD Video discs: Menus . . . . .	36
• Title Menu . . . . .	36
• Disc Menu . . . . .	36
• Changing the Audio Soundtrack . . . . .	36
• Changing the Audio Channel . . . . .	37
• 3D Surround . . . . .	37
• Finding Locations on a Disc . . . . .	37
• Last Condition Memory . . . . .	37
<b>Playing a DivX Movie Disc</b> . . . . .	<b>38</b>
<b>Audio CD and MP3/Windows Media™ Audio Operation</b> . . . . .	<b>39-40</b>
Playing an Audio CD or MP3/Windows Media™ Audio Disc . . . . .	39
Music menu options . . . . .	39
• Pause . . . . .	40
• Moving to Another Track . . . . .	40
• Repeat Track/All(Folder)/Off . . . . .	40
• Changing the Audio Channel . . . . .	40
• Search . . . . .	40
• Repeat A-B . . . . .	40
Notes on MP3/Windows Media™ Audio Recordings . . . . .	40
<b>Programmed Playback with Audio CD and MP3/Windows Media™ Audio</b> . . . . .	<b>41</b>
<b>JPEG File Operation</b> . . . . .	<b>42</b>
Viewing a JPEG File . . . . .	42
• Skip Image . . . . .	42
• Rotate Images . . . . .	42
• View Slide Shows . . . . .	42
• Notes or JPEG Recordings . . . . .	42
<b>VCR Mode Tape Playback</b> . . . . .	<b>43</b>
Preparation . . . . .	43
Normal Playback . . . . .	43
• Tracking Control . . . . .	43
Special Effect Playback . . . . .	43
• Search . . . . .	43
• Still Picture and Frame-by-Frame Playback . . . . .	43
• Slow Motion . . . . .	43
• Counter Memory Function . . . . .	43

## RECORDING

<b>Basic Recording</b> . . . . .	<b>44-45</b>
Basic Recording from a TV . . . . .	44
Instant Timer Recording . . . . .	44
Copying from DVD to VCR . . . . .	45
Copying from VCR to DVD . . . . .	45

<b>Timer Recording</b> . . . . .	<b>46</b>
<b>Timer Recording with ShowView® System</b> . . . . .	<b>47</b>
Checking Timer Recording Details . . . . .	47
Canceling a Timer Recording . . . . .	47
Stopping a Timer Recording in Progress . . . . .	47
Timer Recording Troubleshooting . . . . .	47
<b>Recording from External Input</b> . . . . .	<b>48-49</b>
Recording from External Components . . . . .	48
Recording from a Digital Camcorder . . . . .	48
What is DV? . . . . .	49
• DV-Related Messages . . . . .	49
• Troubleshooting . . . . .	49



## EDITING

<b>Title List and Chapter List Menu</b> . . . . .	<b>50-51</b>
Using the Title List menu [+RW] . . . . .	50
Using the Chapter List menu [+RW] . . . . .	50
Using the Title List menu [+R] . . . . .	51
Using the Chapter List menu [+R] . . . . .	51
<b>Title and Chapter Editing</b> . . . . .	<b>52-55</b>
Adding Chapter Marker . . . . .	52
Changing Title Thumbnails . . . . .	52
Deleting a Title . . . . .	52
Naming a Title . . . . .	53
Combining Two Chapters Into One . . . . .	53
Protect a Title . . . . .	54
Hide a Title/Chapter . . . . .	55
Divide One Title Into Two . . . . .	55
<b>Additional Information</b> . . . . .	<b>56</b>
Overwrite Recording . . . . .	56
Viewing Title List menu displayed on other DVD recorders or players . . . . .	56
Playing Your Recordings on other DVD Players (Finalizing a Disc) . . . . .	56

## REFERENCE

<b>Language Code List</b> . . . . .	<b>57</b>
<b>Area Code List</b> . . . . .	<b>58</b>
<b>Troubleshooting</b> . . . . .	<b>59-60</b>
<b>Specifications</b> . . . . .	<b>61</b>

### About the symbols for instructions

-  Indicates hazards likely to cause harm to the unit itself or other material damage.
-  Indicates special operating features of this unit.
-  Indicates tips and hints for making the task easier.

## Overview

### Recordable Discs



**DVD+RW (Digital Video Disc + ReWritable):** These Discs can be recorded on repeatedly. Recordings can be erased, then you can record again on the same Disc.



**DVD+R (Digital Video Disc + Recordable):** These Discs can be recorded only once. After you finalize a DVD+R, you cannot record on it or edit it any more.



**DVD+R DL (Digital Video Disc + Recordable; Double Layer):** Storage space is nearly doubled with double layer DVD+R media, allowing consumers to burn up to 8.5GB of video on a single DVD+R disc.

#### Notes

- This recorder cannot record CD-R or CD-RW discs.
- DVD-R/RW, DVD+R/RW and CD-R/RW discs recorded using a personal computer or a DVD or CD recorder may not play if the disc is damaged or dirty, or if there is dirt or condensation on the recorder's lens.
- If you record a disc using a personal computer, even if it is recorded in a compatible format, there are cases in which it may not play because of the settings of the application software used to create the disc. (Check with the software publisher for more detailed information.)
- The company does not hold any responsibility to compensate the contents which should have been recorded, and any losses or damages (e.g. losses of business profit, or business intermission) that may arise from malfunction of this recorder (not recording/editing as intended).

Problems arising in the following situations are included.

- When a DVD disc recorded on this recorder is used in a DVD recorder of another manufacturer, or used (insertion, playback, recording or editing) in a personal computer DVD drive.
- When a DVD that has been used as above is used again in this recorder.
- When a DVD disc recorded in a DVD recorder of another manufacturer, or in a personal computer DVD drive is used.

### Playable Discs



DVD  
(8 cm/12 cm disc)



Video CD (VCD)  
(8 cm / 12 cm disc)



Audio CD  
(8 cm/12 cm disc)

In addition, this unit can play DVD-R/DVD-RW discs; DVD+R/DVD+RW discs; CD-R/CD-RW discs that contain audio titles, MP3/Windows Media™ Audio files or JPEG files; and SVCD.

#### Notes

- Depending on the conditions of the recording equipment or the CD-R/RW (or DVD±R/±RW) disc itself, some CD-R/RW (or DVD±R/±RW) discs cannot be played on the unit.
- Do not attach any seal or label to either side (the labeled side or the recorded side) of a disc.
- Do not use irregularly shaped CDs (e.g., heart-shaped or octagonal). Doing so may result in malfunctions.

#### Regional code of the DVD Recorder and DVDs

This DVD Recorder is designed and manufactured for playback of Region 2 encoded DVD software. The region code on the labels of some DVD discs indicates which type of DVD Recorder can play those discs. This unit can play only DVD discs labeled 2 or ALL. If you try to play any other discs, the message "Incorrect region code. Can't play back" will appear on the TV screen. Some DVD discs may not have a region code label even though their playback is prohibited by area limits.



#### Notes on DVDs and Video CDs

Some playback operations of DVDs and Video CDs may be intentionally fixed by software manufacturers. As this unit plays DVDs and Video CDs according to disc content designed by the software manufacturer, some playback features of the unit may not be available or other functions may be added. Refer also to the instructions supplied with the DVDs and Video CDs. Some DVDs made for business purposes may not be played on the unit.

### Disc-related terms

#### **Title (DVD only)**

The main film content or accompanying feature content or music album.

Each title is assigned a title reference number enabling you to locate it easily.

#### **Chapter (DVD only)**

Sections of a picture or a musical piece that are smaller than titles. A title is composed of one or several chapters. Each chapter is assigned a chapter number to enable you to locate the chapter you want. Depending on the disc, chapters may not be labeled.

#### **Track (Video CD and audio CD only)**

Sections of a picture or a musical piece on a video CD or an audio CD. Each track is assigned a track number, enabling you to locate the track you want.

#### **Scene**

On a video CD with PBC (Playback control) functions, moving pictures and still pictures are divided into sections called "Scenes". Each scene available is displayed on the Scene menu and assigned a scene number, enabling you to locate the scene you want.

A scene may be composed of one or several tracks.

### Types of video CDs

There are two types of video CDs:

#### **Video CDs equipped with PBC (Version 2.0)**

PBC (Playback control) functions allow you to interact with the system via menus, search functions, or other typical computer-like operations. Moreover, high resolution still pictures can be played if they are included on the disc.

#### **Video CDs not equipped with PBC (Version 1.1)**

Operated in the same way as audio CDs, these discs allow playback of video pictures as well as sound, but they are not equipped with PBC.



### About Symbols

#### About the symbol display

"" may appear on the TV screen during operation. This icon means the function explained in this owner's manual is not available on that specific disc.

#### About the disc symbols for instructions

A section whose title has one of the following symbols are applicable only to those discs represented by the symbol.

Many functions of this recorder are dependent on the recording mode. One or more of the symbols (, ) appear by each function explained in this manual so that you can see at a glance whether it's relevant for the disc loaded.

-  DVD+R disc
-  DVD+RW disc
-  DVD-Video disc
-  Video CDs
-  Audio CDs
-  MP3 CDs
-  JPEG CDs
-  DivX CDs
-  VHS Tape.

The finalized DVD disc is as DVD-Video disc

#### **DivX**

DivX is the name of a revolutionary new video codec which is based on the new MPEG-4 compression standard for video. You will be able to play DivX movies using this recorder.

DivX, DivX Certified, and associated logos are trademarks of DivXNetworks, Inc and are used under license.



## Overview (Continued)

---

### About DVD+R and DVD+RW disc

#### How are DVD+R and DVD+RW discs different?

The essential difference between DVD+R and DVD+RW is that DVD+R is a record-once medium, while DVD+RW is a re-recordable/erasable medium. You can re-record/ erase a DVD+RW disc approximately 1,000 times.

#### DVD+RW mode recording

- 4 different picture quality/recording time settings available (XP, SP, LP, EP)
- Playable on regular DVD players
- The edited contents is playable on regular DVD players only after finalizing
- Recordings can be edited the title/chapter

#### DVD+R mode recording

- 4 different picture quality/recording time settings available (XP, SP, LP, EP)
- Playable on regular DVD players (after finalizing)
- Any edited contents are not be compatible on regular DVD players. (Hide, chapter combine, added chapter mark, etc.)
- Limited title/chapter editing features

#### DVD +R (Double Layer)

Double layer recording technology offers two recordable layers on a single DVD disc, providing nearly double the capacity of 4.7GB single layer DVDs. The greatest, most valuable benefit of double layer recording technology is increased capacity. Storage space is nearly doubled with double layer DVD+R media, allowing consumers to burn up to 8.5GB of video on a single DVD+R disc.



### About DVD recording

#### **N**otes

- This recorder cannot make recordings on CD-R or CD-RW discs.
- Our company takes no responsibility for recording failure due to power cuts, defective discs, or damage to the recorder.
- Fingerprints and small scratches on a disc can affect playback and/or recording performance. Please take proper care of your discs.

### Disc types and recording formats, modes, and settings

This recorder can play five different kinds of DVD disc: pre-recorded DVD-Video discs, DVD-RW, DVD-R, DVD+RW and DVD+R discs. The disc format for DVD-R discs is always "Video format"—the same as pre-recorded DVD-Video discs. This means that once finalized, you can play a DVD-R in a regular DVD player.

### Notes for recording

- The recording times shown are not exact because the recorder uses variable bit-rate video compression. This means that the exact recording time will depend on the material being recorded.
- When recording a TV broadcast, if the reception is poor or the picture contains interference, the recording times may be shorter.
- If you record still pictures or audio only, the recording time may be longer.
- The displayed times for recording and time remaining may not always add up to exactly the length of the disc.
- The recording time available may decrease if you heavily edit a disc.
- The overwrite recording is available with DVD+RW disc.

Disc type	Disc format	Recording mode	Functions
DVD-Video	Video format	n/a	Playback only
DVD+RW	+RW Video format	DVD+RW	Playback, limited recording, Title/Chapter editing
DVD+R	+R Video format	DVD+R	Playback, limited recording, limited Title/Chapter editing

## Overview (Continued)

### Recording TV audio channels

This recorder can record either NICAM or regular audio. If the NICAM setting (page 22) is set to Auto, then if the broadcast is NICAM, you can record the NICAM audio. If the broadcast is non-NICAM, the regular audio is always recorded.

### Restrictions on video recording

- You cannot record copy-protected video using this recorder. Copy-protected video includes DVD-Video discs and some satellite broadcasts. If copy-protected material is encountered during a recording, recording will pause or stop automatically and an error message will be displayed on-screen.
- NTSC format signals from the analog or the DV inputs is not recorded correctly with this recorder.
- Video signals in SECAM format (from the built-in TV tuner or from the analog inputs) are recorded in PAL format.

### Copyright

- Recording equipment should be used only for lawful copying and you are advised to check carefully what is lawful copying in the country in which you are making a copy. Copying of copyright material such as films or music is unlawful unless permitted by a legal exception or consented to by the rights owner.
- This product incorporates copyright protection technology that is protected by method claims of certain U.S. patents and other intellectual property rights owned by Macrovision Corporation and other rights owners. Use of this copyright protection technology must be authorized by Macrovision Corporation, and is intended for home and other limited viewing uses only unless otherwise authorized by Macrovision corporation. Reverse engineering or disassembly is prohibited.
- CONSUMERS SHOULD NOTE THAT NOT ALL HIGH DEFINITION TELEVISION SETS ARE FULLY COMPATIBLE WITH THIS PRODUCT AND MAY CAUSE ARTIFACTS TO BE DISPLAYED IN THE PICTURE. IN CASE OF 625 PROGRESSIVE SCAN PICTURE PROBLEMS, IT IS RECOMMENDED THAT THE USER SWITCH THE CONNECTION TO THE 'STANDARD DEFINITION' OUTPUT. IF THERE ARE QUESTIONS REGARDING OUR TV SET COMPATIBILITY WITH THIS MODEL 625p RECORDER, PLEASE CONTACT OUR CUSTOMER SERVICE CENTER.

### Remote Control Operation Range

Point the remote control at the remote sensor and press the buttons.

### Remote Control Battery Installation

Detach the battery cover on the rear of the remote control, and insert two (size AA) batteries with **+** and **-** aligned correctly.

#### **Caution**



Do not mix old and new batteries. Never mix different types of batteries (standard, alkaline, etc.).

### Reset the Recorder

If you observe any of the following symptoms...

- The front panel display is not working.
- The Recorder is not operating normally.

...you can reset the Recorder as follows:

- Press and hold the  button for at least five seconds. This will force the unit to power off. Press the  button again to turn the unit back on.
- Unplug the power cord, wait at least five seconds, and then plug it in again.

### Precautions

#### Handling the unit

##### **When shipping the unit**

The original shipping carton and packing materials come in handy. For maximum protection, re-pack the unit as it was originally packaged at the factory.

##### **When setting up the unit**

The picture and sound of a nearby TV, VCR, or radio may be distorted during playback. In this case, position the unit away from the TV, VCR, or radio, or turn off the unit after removing the disc.

##### **To keep the surface clean**

Do not use volatile liquids, such as insecticide spray, near the unit. Do not leave rubber or plastic products in contact with the unit for a long period of time. They will leave marks on the surface.

#### Cleaning the unit

##### **To clean the cabinet**

Use a soft, dry cloth. If the surfaces are extremely dirty, use a soft cloth lightly moistened with a mild detergent solution. Do not use strong solvents such as alcohol, benzene, or thinner, as these might damage the surface of the unit.

##### **To obtain a clear picture**

The Recorder is a high-tech, precision device. If the optical pick-up lens and disc drive parts are dirty or worn, the picture quality will be poor.

Regular inspection and maintenance are recommended after every 1,000 hours of use. (This depends on the operating environment.)

For details, please contact your nearest dealer.

### Notes on Discs

#### Handling discs

Do not touch the playback side of the disc. Hold the disc by the edges so that fingerprints will not get on the surface. Do not stick paper or tape on the disc.



#### Storing discs

After playing, store the disc in its case.

Do not expose the disc to direct sunlight or sources of heat, or leave it in a parked car exposed to direct sunlight, as there may be a considerable temperature increase inside the car.

#### Cleaning discs

Fingerprints and dust on the disc can cause poor picture quality and sound distortion. Before playing, clean the disc with a clean cloth. Wipe the disc from the center outward.

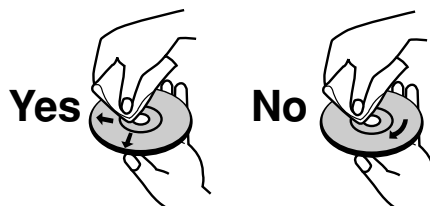

Do not use strong solvents such as alcohol, benzene, thinner, commercially available cleaners, or anti-static spray intended for older vinyl records.

# Front Panel

English

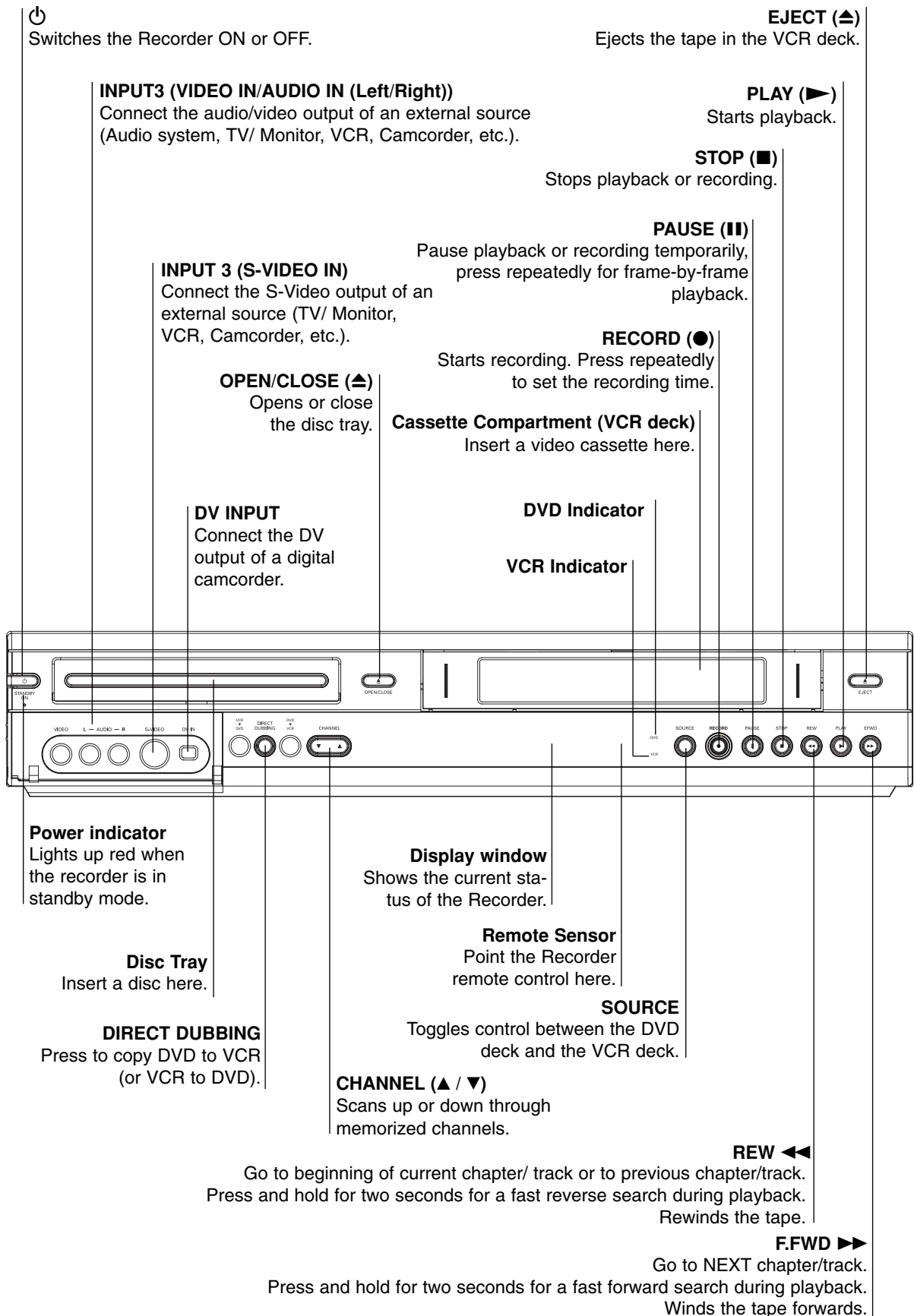

# Function Display Window

## Disc type indicators

Indicates the type of disc loaded.

Ⓢ Indicates when the recorder is in timer recording or a timer recording is programmed.

**REC** The recorder is recording.

**PRG** Programmed playback active

**TTL** Indicates current title.

A disc is inserted in the DVD deck.

A VHS tape is inserted in the VCR deck.

**TV** Indicates when the recorder is in TV tuner mode.

**CHP/TRK** Indicates current chapter or track number

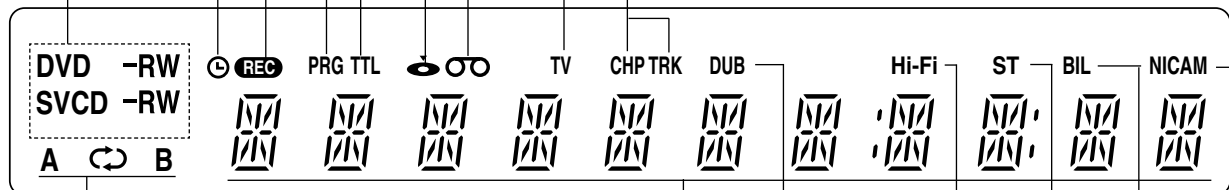

**REPEAT** Indicates repeat mode.

## Character indicators

Indicates clock, total playing time, elapsed time, remaining time, title number, chapter/track number, channel, etc.

**DUB** Indicates that a DVD to VCR (or VCR to DVD) copy is in progress.

**Hi-Fi** Indicates when the Recorder is playing a tape in Hi-Fi.

**ST** Indicates a stereo broadcast is being received.

**BIL** Indicates when a BILINGUAL broadcast is being received.

## NICAM

Indicates when a NICAM broadcast is being received.

# Remote Control Overview

English

**TV/VIDEO**  
To view channels selected by the recorder tuner or by the TV tuner.

**DVD**  
Select the Recorder's function mode to DVD.

**VCR**  
Select the Recorder's function mode to VCR.

**EJECT, OPEN/CLOSE**  
- Opens and closes the disc tray.  
- Ejects the tape in the VCR deck.

**LIST/DISC MENU**  
Accesses menu on a DVD disc, Title List menu.

**SYSTEM MENU**  
Accesses or removes the Setup menu.

**◀ / ▶ / ▲ / ▼ (left/right/up/down)**  
Selects an option in the menu.  
▲ / ▼  
- Select channel programme of the recorder.  
- To adjust tracking.  
- To control vertical tremble during picture still.  
- Changes the input to use for recording (Tuner, AV1-3, or DV IN).

**OK**  
- Acknowledges menu selection.  
- Displays information while viewing a TV program.

**◀ / ▶**  
Go to next chapter or track. Returns to beginning of current chapter or track or go to previous chapter or track.

**THUMBNAIL**  
Selects a thumbnail picture for the current title and chapter.

**CHAPTER**  
Inserts a chapter marker when playing/recording.

**TIMER**  
Displays Timer Record menu.

**REC MODE**  
Selects the recording mode: XP, SP, LP, or EP.

**REPEAT**  
- Repeat chapter, track, title, all.  
- Repeat sequence.

**TITLE**  
Displays the disc's Title menu, if available.

**AUDIO**  
Selects an audio language (DVD) or an audio channel (CD).

**ZOOM**  
Enlarges DVD video image.

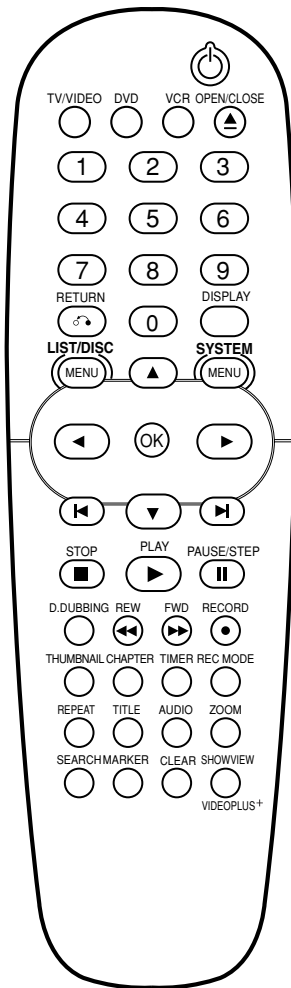

**Power**  
Switches the recorder ON or OFF.

**0-9 numerical buttons**  
Selects numbered options in a menu.

**RETURN**  
- Removes the menu.  
- Displays the menu of a video CD with PBC.

**DISPLAY**  
Accesses On-Screen Display.

**STOP (■)**  
Stops playback or recording.

**▶ (PLAY)**  
Starts playback.

**PAUSE/STEP (||)**  
Pause playback temporarily / press repeatedly for frame-by-frame playback.

**D.DUBBING**  
Press to copy DVD to VCR (or VCR to DVD).

**REW / FWD (◀▶)**  
- DVD: Search backward or forward.  
- VCR: Rewinds the tape during the STOP mode, for fast reverse picture search and Advances the tape during the STOP mode, fast forward picture search.

**RECORD (●)**  
Starts recording. Press repeatedly to set the recording time.

**SEARCH**  
Displays Marker Search menu.

**MARKER**  
Marks any point during playback.

**CLEAR**  
- Removes a track number on the Program List or a mark on the Marker Search menu.  
- Reset tape counter to zero.

**SHOWVIEW**  
To display the programme menu for ShowView programming.

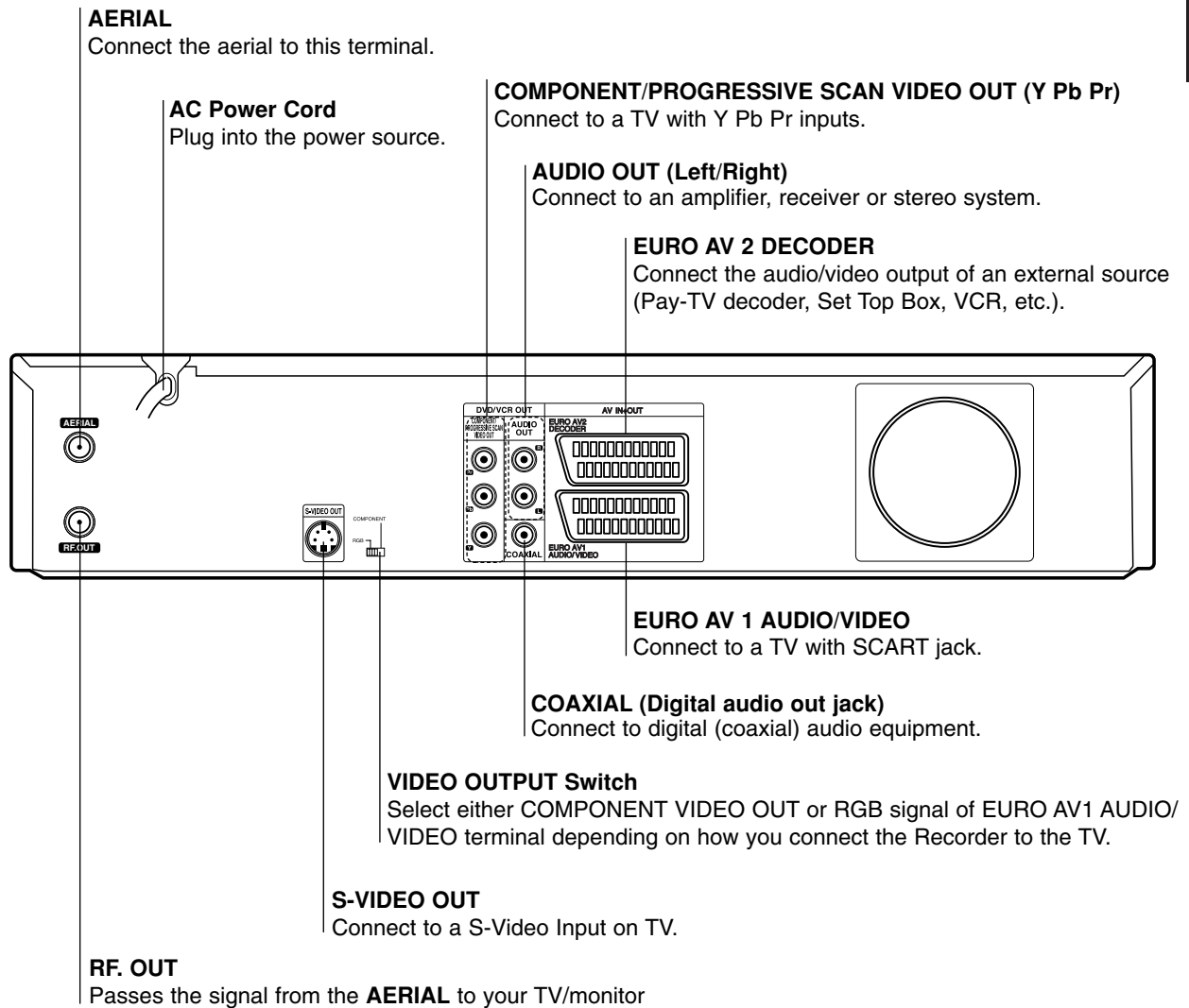

## Important Note

### About Ferrite Core

Be sure to attach the ferrite core to the power cord (for connecting to this unit). This ferrite core can reduce noises.

- 1 Push the stopper [a] of the ferrite core to open.
- 2 Wind the power cord twice on ferrite core.
- 3 Close the ferrite core until it clicks.

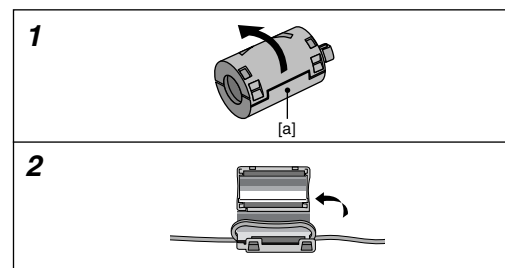

## Caution

Do not touch the inner pins of the jacks on the rear panel. Electrostatic discharge may cause permanent damage to the unit.

## Connections

### Tips

- Depending on your TV and other equipment you wish to connect, there are various ways you could connect the recorder. Use only one of the connections described below.
- Please refer to the manuals of your TV, VCR, Stereo System or other devices as necessary to make the best connections.

### Caution

- Make sure the Recorder is connected directly to the TV. Tune the TV to the correct video input channel.
- Do not connect the Recorder's AUDIO OUT jack to the phono in jack (record deck) of your audio system.
- Do not connect your Recorder via your VCR. The DVD image could be distorted by the copy protection system.

## Connecting to the Aerial

Remove the aerial cable plug from your TV set and insert it into the aerial socket at the back of the recorder. Plug one end of the aerial cable into the TV socket on the recorder and the other end into the aerial input socket on your TV set.

### RF coaxial connection

Connect the RF. OUT jack on the Recorder to the aerial input jack on the TV using the 75-ohm Coaxial Cable supplied (R). The RF. OUT jack passes the signal through from the AERIAL jack.

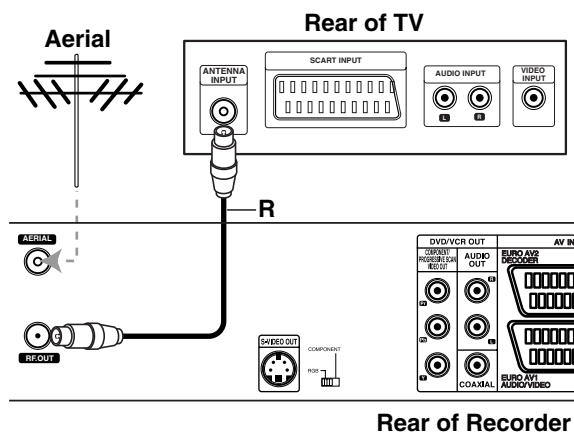

## Connections to Your TV

- Make one of the following connections, depending on the capabilities of your existing equipment.
- When using the COMPONENT VIDEO OUT jacks, set the VIDEO OUTPUT switch to COMPONENT.
- When using the SCART jack, set the VIDEO OUTPUT switch to RGB.

### SCART connection

Connect the EURO AV1 AUDIO/VIDEO scart jack on the Recorder to the corresponding in jacks on the TV using the scart cable (T).

### S-Video connection

Connect the S-VIDEO OUT jack on the Recorder to the S-Video in jack on the TV using the S-Video cable (S).

### Component Video connection

Connect the COMPONENT/PROGRESSIVE SCAN VIDEO OUT jacks on the Recorder to the corresponding input jacks on the TV using a Y Pb Pr cable (C).

### Progressive Scan (ColorStream®Pro) connection

If your television is a high-definition or "digital ready" television, you may take advantage of the recorder's progressive scan output for the highest video resolution possible. If your TV does not accept the Progressive Scan format, the picture will appear scrambled if you try Progressive Scan on the recorder.

Connect the COMPONENT/PROGRESSIVE SCAN VIDEO OUT jacks on the Recorder to the corresponding input jacks on the TV using a Y Pb Pr cable (C).

### Notes

- Set the Progressive to "ON" on the setup menu for progressive signal, see page 24.
- Set the progressive to "Off" by removing any disc from the unit and close the disc tray. Then press STOP and hold it for five seconds before releasing it.
- Progressive scan does not work with the analog video connections or S-VIDEO connection.

### Audio (Left/Right) Connection

Connect the left and right AUDIO OUT jacks of the Recorder to the audio left and right IN jacks on the TV using the audio cables (A). Do not connect the Recorder's AUDIO OUT jack to the phono in jack (record deck) of your audio system.

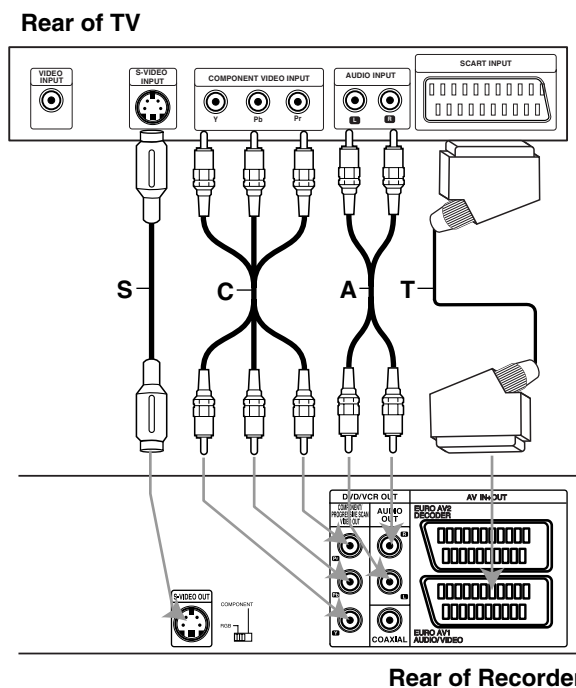



## Connections (Continued)

### Connecting to a cable box or satellite receiver

If you have a cable or satellite receiver with a built-in decoder, connect it to this recorder and your TV as shown on this page. If you are using a separate decoder box for your cable/satellite TV, set up following the instructions on the right.

Using the setup on this page you can:

- Record any channel by selecting it on the cable box/satellite tuner.

- 1 Connect RF cables as shown. This enables you to watch and record TV channels.
- 2 Use the SCART cable to connect the EURO AV1 AUDIO/VIDEO connector to a SCART AV connector on your TV. This enables you to watch discs.
- 3 Use a SCART cable to connect the EURO AV2 DECODER connector to a SCART AV connector on your satellite/cable box. This enables you to record scrambled TV channels.

#### Tip

This recorder has a 'loop through' function. This feature allows you to record a TV program from the built-in TV tuner in this recorder, while watching a satellite or cable channel. Press TV/VIDEO to select the TV mode during recording. The TV indicator appears.

#### Caution:

Do not connect this recorder 'through' your VCR, satellite receiver or cable box. Always connect each component directly to your TV or AV receiver.

### Connecting an external decoder box

If you have an external, dedicated decoder box for your satellite or cable TV system, use the setup described on this page.

- 1 Connect the cable from the aerial/cable TV outlet to the aerial input on your cable/satellite tuner.
- 2 Use a SCART cable to connect your decoder to your cable/satellite tuner. See the manual for your decoder box for more detailed instructions.
- 3 Use a SCART cable to connect the EURO AV2 DECODER connector to a SCART AV connector on your satellite/cable box.
- 4 Use the SCART cable to connect the EURO AV1 AUDIO/VIDEO connector to a SCART AV connector on your TV.

#### Caution:

- Information from the decoder (for example, relating to pay TV services), is only viewable when this recorder is off (in standby).
- For timer recording to work properly on this recorder, the satellite/cable box must also be switched on during recording.

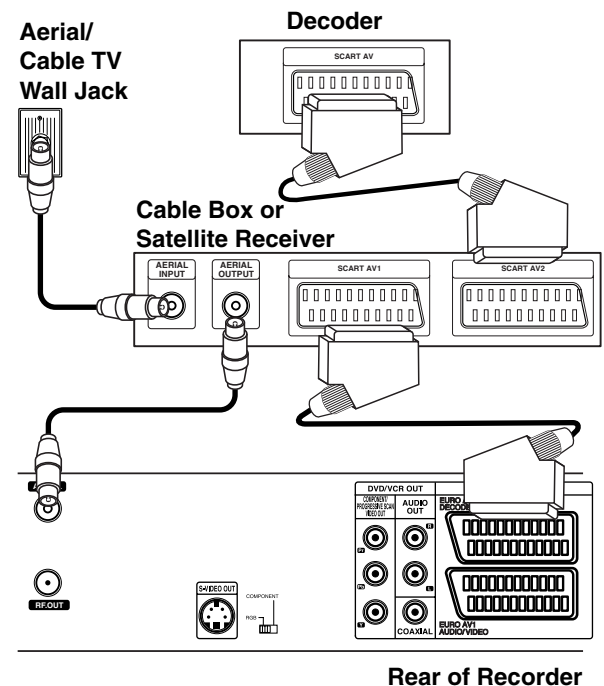
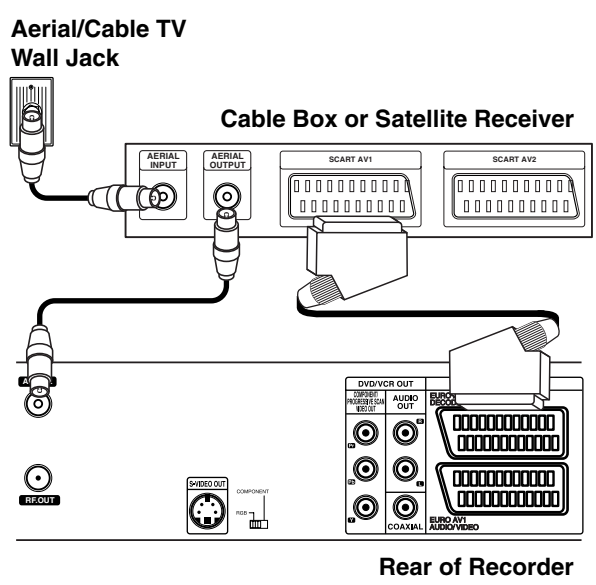

## Connections (Continued)

### Connecting to an Amplifier

#### Connecting to an amplifier equipped with two channel analog stereo or Dolby Pro Logic II/ Pro Logic

Connect the Left and Right AUDIO OUT jacks on the Recorder to the audio left and right in jacks on your amplifier, receiver, or stereo system, using the audio cables (A).

#### Connecting to an amplifier equipped with two channel digital stereo (PCM) or to an Audio/ Video receiver equipped with a multi-channel decoder (Dolby Digital™ or MPEG 2)

- 1 Connect one of the Recorder's DIGITAL AUDIO OUT jacks (COAXIAL X) to the corresponding in jack on your amplifier. Use an optional digital (coaxial X) audio cable.
- 2 You will need to activate the recorder's digital output. (See "AUDIO" on page 25).

#### Digital Multi-channel sound

A digital multi-channel connection provides the best sound quality. For this you need a multi-channel Audio/Video receiver that supports one or more of the audio formats supported by your Recorder (MPEG 2 and Dolby Digital). Check the receiver manual and the logos on the front of the receiver.

#### Notes

- If the audio format of the digital output does not match the capabilities of your receiver, the receiver will produce a strong, distorted sound or no sound at all.
- Six Channel Digital Surround Sound via digital connection can only be obtained if your receiver is equipped with a Digital Multi-channel decoder.
- To see the audio format of the current DVD in the on-screen display, press AUDIO.

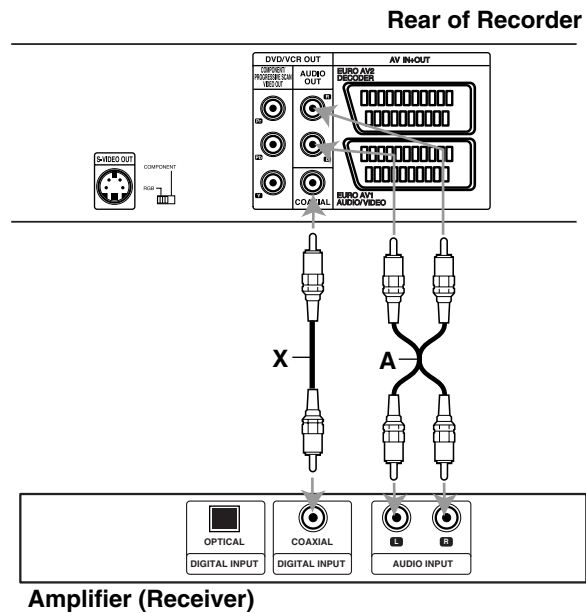

## Connections (Continued)

### Accessory Audio/Video (A/V) Connections to Recorder

Connect the input jacks (AV3) on the Recorder to the audio/video out jacks on your accessory component, using audio/video cables.

**Note**  
If you use the S-VIDEO IN jack on the front panel, the VIDEO IN jack on the front panel is not available.

Jack panel of Accessory Component (VCR, Camcorder, etc.)

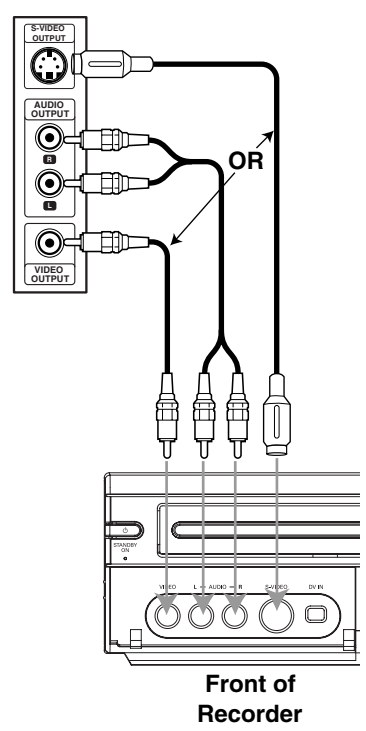

### Connecting a Digital Camcorder

Use a DV cable (not supplied) to connect the DV in/out jack of your DV camcorder/video deck to the front panel DV IN jack of this recorder.

**Note**  
This jack is for connection to DV equipment only. It is not compatible with digital satellite tuners or D-VHS video decks.

DV Digital Camcorder

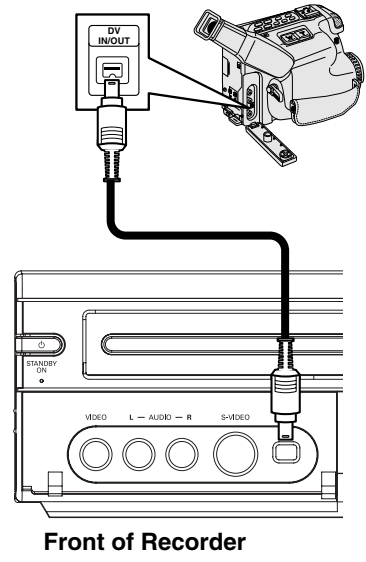

## Before Operation

### Initial Settings

In this menu system, there are several ways to customize the settings provided. Most menus consist of three levels to set up the options, but some require greater depth for the variety of settings. If you press SYSTEM MENU, only the first and second level of the menu system will appear on the TV screen. The third level can be displayed by pressing ►. For navigating the menu levels, you will see “►” on the right side of the menu label to help you go to the next level.

#### To bring up and exit the Menu:

Press SYSTEM MENU to bring up the menu. A second press of SYSTEM MENU will take you back to initial screen.

#### To go to the next level:

Press ► on the remote control.

#### To go back to the previous level:

Press ◀ on the remote control.

### General Operation

- 1** Press SYSTEM MENU.  
The Setup menu appears.
- 2** Use ▲ / ▼ to select the desired option.
- 3** While the desired item is selected, press ► to move to the second level.
- 4** Use ▲ / ▼ to select the second desired option.
- 5** Press ► to move to the third level.
- 6** Use ▲ / ▼ to select the desired setting then press OK to confirm your selection.  
Some items require additional steps.
- 7** Press SYSTEM MENU to exit the Setup menu.

## GENERAL

### Auto Programming

This Recorder is equipped with a frequency synthesized tuner capable of receiving up to 99 TV channels.

#### Preparation:

- Connect the Recorder to the desired type of aerial, as shown in Connecting to the Aerial on page 16.

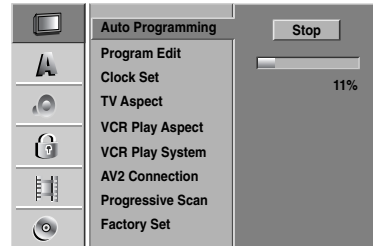

- 1** Press SYSTEM MENU.  
The Setup menu appears.
- 2** Use ▲ / ▼ to select the GENERAL option.
- 3** While the GENERAL option is selected, press ► to move to the second level.
- 4** Use ▲ / ▼ to select the Auto Programming option.
- 5** Press ► to move to the third level.  
“Start” icon is highlighted.
- 6** Press OK to begin the channel search.  
The tuner will automatically cycle through all available channels in the area and place them in the tuner’s memory.

## Before Operation (Continued)

### Program Edit

You can edit a channel manually (add, delete, name, move, etc.).

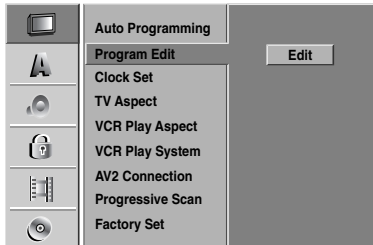

- 1 Press SYSTEM MENU.**  
The Setup menu appears.
- 2 Use ▲ / ▼ to select the GENERAL option.**
- 3 While the GENERAL option is selected, press ► to move to the second level.**
- 4 Use ▲ / ▼ to select the Program Edit option then press ► to move to the third level.**  
"Edit" icon is highlighted.
- 5 Press OK.**  
Program List menu appears.

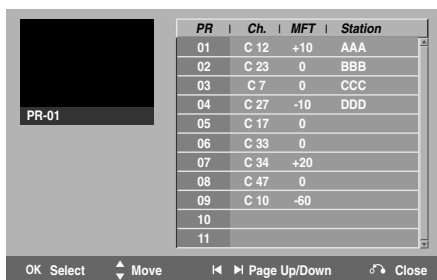

- 6 Use ▲ / ▼ to select a PR number then press OK.**  
Program List options appears on the left side of the menu display.
- 7 Use ▲ / ▼ to select an option then press OK to confirm.**

<b>Program Edit</b>
<b>Station Rename</b>
<b>Move</b>
<b>Delete</b>
<b>Decoder On/Off</b>
<b>NICAM Auto/Off</b>

**Program Edit:** Edits the selected program.

**Station Rename:** Edits the station name.

**Move:** Moves the program's location on the program list.

**Delete:** Deletes the program from program list.

**Decoder On/Off:** Set the decoder for the program to On or Off.

**NICAM Auto/Off:** Set the NICAM function to for the program Auto or Off.

- 8 Press RETURN (↵) repeatedly to exit Program List menu.**

### Program Edit

You can perform a search to select and store TV channels manually.

1. Use ▲ / ▼ to select a program on the Program List menu then press OK.  
Program List options appears on the left side of the Program List menu.
2. Use ▲ / ▼ to select 'Program Edit' option from the options then press OK.  
Program Edit menu appears.

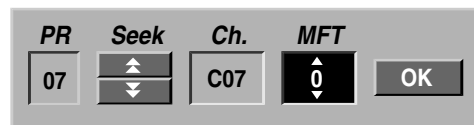

3. See the descriptions on below to use Program Edit menu.
  - ◀ / ▶ (left/right): Moves the cursor to the previous or next column.
  - ▲ / ▼ (up/down): Changes the setting at the current cursor position.
  - PR:** Indicates program number (display only)
  - Seek:** Searches a station automatically. Use ◀ / ▶ to select Seek option then press ▲ / ▼. Searching stops when the recorder tunes in a station.
  - Ch.:** Changes the channel number to edit. Use ◀ / ▶ to select Ch. option then press ▲ / ▼.
  - MFT:** Changes the frequency for fine tuning. Use ◀ / ▶ to select MFT option then press ▲ / ▼.
4. Choose OK then press OK to confirm the setting and returns to the Program List menu.

## Before Operation (Continued)

### Program Edit (Continued)

#### Station Rename

You can name stations independently. Names can be up to 5 characters long.

1. Use ▲ / ▼ to select a program on the Program List menu then press OK.  
Program List options appears on the left side of the Program List menu.
2. Use ▲ / ▼ to select 'Station Rename' option from Program List options then press OK.  
Keyboard menu appears.

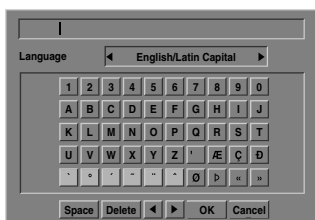

3. Enter a name for the station. Use ▲ ▼ ◀ ▶ to select a character then press OK to confirm your selection.
  - **English/Latin Capital:** Switches the keyboard upper case characters.
  - **English/Latin Lowercase:** Switches the keyboard to lower case characters.
  - **Symbol:** Switches the keyboard to symbol characters.
  - **Space:** Inserts a space at the cursor position.
  - **Delete:** Deletes the previous character at the cursor position.
  - **◀ / ▶:** Moves cursor to left or right.
  - **OK:** Select to finish.
  - **Cancel:** Select to exit the menu.
4. Choose 'OK' icon then press OK to fix the name and returns to the Program List menu.

#### Sort TV channels manually

You can sort the program's position on the Program List menu.

1. Use ▲ / ▼ to select a program on the Program List menu then press OK.  
Program List options appears on the left side of the Program List menu.
2. Use ▲ / ▼ to select 'Move' option from Program List options then press OK.
3. Use ▲ / ▼ to select a desired position then press OK to store.

#### Deleting a program

You can delete a program on the Program List menu.

1. Use ▲ / ▼ to select a program on the Program List menu then press OK.  
Program List options appears on the left side of the Program List menu.
2. Use ▲ / ▼ to select 'Delete' option from Program List options then press OK. The Program is deleted.

#### Setting the Decoder On/Off

1. Use ▲ / ▼ to select the program you wish to link with the decoder function on the Program List menu then press OK.  
Program List options appears on the left side of the Program List menu.
2. Use ▲ / ▼ to select 'Decoder On/Off' option from Program List options then press OK. If you select On, 'Decoder' appears on the menu screen.

#### Setting the NICAM Auto/Off

This recorder can receive Hi-Fi sound transmissions in NICAM Stereo. However, if sound distortion occurs, due to poor reception, you can switch Off

1. Use ▲ / ▼ to select a program on the Program List menu then press OK.  
Program List options appears on the left side of the Program List menu.
2. Use ▲ / ▼ to select 'NICAM Auto/Off' option from Program List options then press OK. If you select Auto, 'NICAM' appears on the menu screen.

## Before Operation (Continued)

### Clock Set

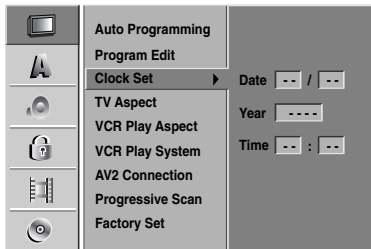

- 1** Press **SYSTEM MENU**.  
The Setup menu appears.
- 2** Use **▲ / ▼** to select the **GENERAL** menu.
- 3** While the **GENERAL** option is selected, press **▶** to move to the second level.
- 4** Use **▲ / ▼** to select the **Clock Set** option.
- 5** Press **▶** to move to the third level.
- 6** Ok the necessary information for date and time.  
◀ / ▶ (left/right): Moves the cursor to the previous or next column.  
▲ / ▼ (up/down): Changes the setting at the current cursor position.
- 7** Press **OK** to confirm your setting, then press **SYSTEM MENU** to exit the Setup menu.

### TV Aspect

To record a wide screen format programme successfully the correct type of wide screen signal must be broadcast by the TV station.

You can choose:

**4:3 Letter Box:** Select when a standard 4:3 TV is connected. Displays theatrical images with masking bars above and below the picture.

**4:3 Pan Scan:** Select when a standard 4:3 TV is connected. The video material formatted in the Pan & Scan style is played back in that style (Both sides of the picture are cut off).

**16:9 Wide:** Select when a 16:9 wide TV is connected.

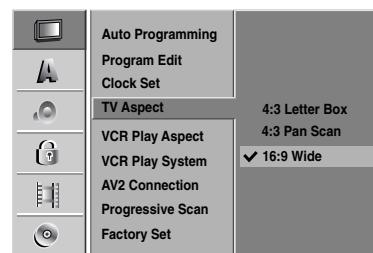

### VCR Play Aspect

You can choose:

**AUTO** : Automatically plays back Wide-Screen programmes as Wide-Screen and Normal programmes as normal.

**4:3** : Only for playing back Normal format recordings (4:3).

**16:9**:Only for playing back Wide-Screen format recordings (16:9).



## Before Operation (Continued)

### VCR Play System

Your video recorder uses triple colour standards, PAL, SECAM and MESECAM. During play your video recorder should select the colour system automatically, however if you experience problems you may need to do it manually.

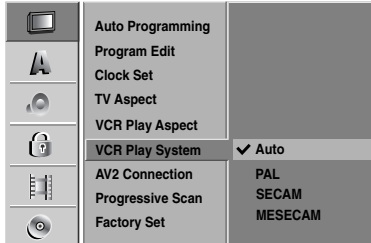

### AV2 Connection

You can connect a decoder, satellite receiver or other device to the EURO AV2 socket on the back.

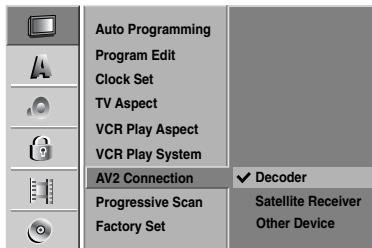

### Progressive Scan

Progressive Scan Video provides the highest quality pictures with less flickering.

If you are using the COMPONENT/PROGRESSIVE SCAN VIDEO OUT jacks, but are connecting the recorder to a standard (analog) television, set Progressive Scan to OFF.

If you are using the component video jacks for connection to a TV or monitor that is compatible with a progressive scan signal, set Progressive Scan to ON.

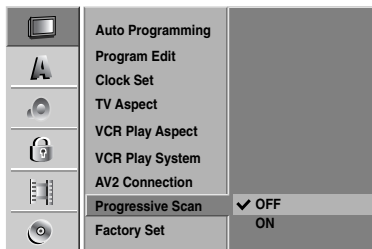

#### Note

Progressive Scan will not be set when the VIDEO OUTPUT switch is set at RGB position.

#### Caution

Once the setting for progressive scan output is entered, an image will only be visible on a progressive scan compatible TV or monitor. If you set Progressive Scan to On in error, you must reset the unit.

- 1) Remove any disc from the unit and close the disc tray.
- 2) Press STOP and hold it for five seconds before releasing it. The video output will be restored to the standard setting and a picture will once again be visible on a conventional analog TV or monitor.

### Factory Setting

If you need to, you can reset the recorder to all its factory settings. Select 'SET' icon then press OK.

#### Note

Some options can not be reset. (Auto Programming, Clock Set, Set Password, Rating, Area Code, and Disc Protect)

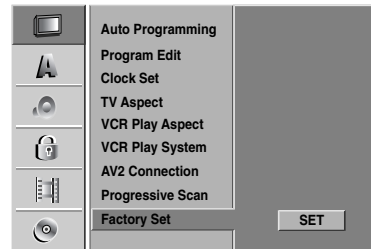

## LANGUAGE

### Display Language

Select a language for the Setup menu and on-screen display.



### Disc Language

Select a language for the disc's Menu, Audio, and Subtitle.

- Original: The original language set for the disc is selected.
- Others: To select another language, select Others option then press OK. Use the numbered buttons to key-in the corresponding 4-digit number according to the language code list on page 57. If you make a mistake, press ◀ repeatedly to delete one by one and correct it.





## Before Operation (Continued)

### AUDIO

Each DVD disc has a variety of audio output options. Set the recorder's Audio Output according to the type of audio system you use.

#### Dolby Digital

**PCM:** Select when connected to a 2-channel digital stereo amplifier. The Recorder's digital audio outputs sounds in the PCM 2ch format when you play a DVD video disc recorded on the Dolby Digital recording system.

**Bitstream:** Select "Bitstream" if you connected the Recorder's DIGITAL OUT jack to a Dolby Digital decoder (or an amplifier or other equipment with a Dolby Digital decoder).

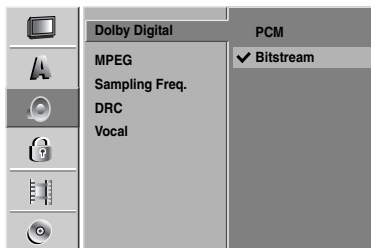

#### MPEG

**PCM:** Select when connected to a 2-channel digital stereo amplifier. The Recorder's digital audio outputs sounds in the PCM 2ch format when you play a DVD video disc recorded on the MPEG2 recording system.

**Bitstream:** Select "Bitstream" if you connected the Recorder's DIGITAL OUT jack to a MPEG decoder (or an amplifier or other equipment with a MPEG decoder).

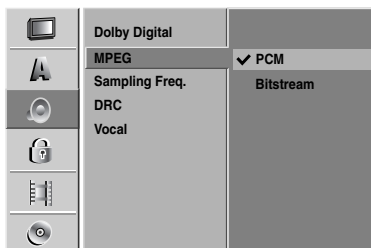

#### Sampling Frequency

If your receiver or amplifier is NOT capable of handling 96 kHz signals, select 48 kHz. When this choice is made, this unit will automatically convert any 96 kHz signals to 48 kHz so your system can decode them. If your receiver or amplifier is capable of handling 96 kHz signals, select 96 kHz. When this choice is made, this unit will pass each type of signal through without any further processing.

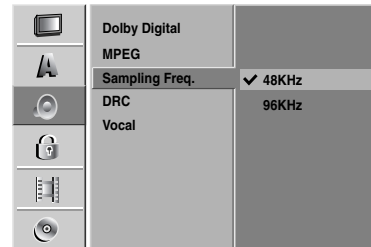

#### DRC (Dynamic Range Control)

With the DVD format, you can hear a program's sound-track in the most accurate and realistic presentation possible, thanks to digital audio technology. However, you may wish to compress the dynamic range of the audio output (the difference between the loudest sounds and the quietest ones). Then, you may listen to a movie at a lower volume without losing clarity of sound. Set DRC to ON for this effect.

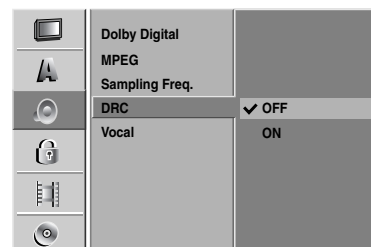

#### Vocal

Set Vocal to ON only when a multi-channel karaoke DVD is playing. The karaoke channels on the disc will mix into normal stereo sound.

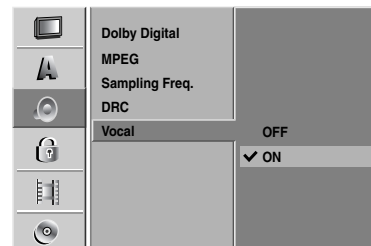

## Before Operation (Continued)

### LOCK (Parental Control)

#### Set Password

To access the Rating, Set Password and Area Code features, you must enter a 4-digit security password.

- 1** Press **SYSTEM MENU**.  
The Setup menu appears.
- 2** Use **▲ / ▼** to select the **LOCK** option.
- 3** While the **LOCK** option is selected, press **▶** to move to the second level.
- 4** Use **▲ / ▼** to select the **Set Password** option.
- 5** Press **▶** to move to the third level.
- 6** When you have not entered a password yet; Enter a 4-digit password using the numbered buttons to create a personal 4-digit security password. Enter the 4-digit password again to verify.

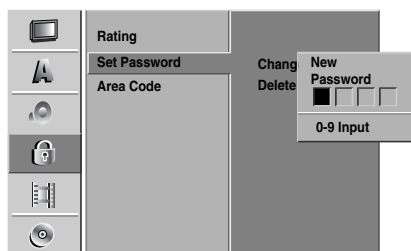

#### When you have already entered a password;

You can change or delete the password.

Use **▲ / ▼** to select "Change" or "Delete" then press **OK**.

**Change** : Enter a 4-digit password using the numbered buttons to confirm the personal 4-digit security password, then enter a 4-digit new password twice.

**Delete** : Enter a 4-digit password using the numbered buttons to confirm the personal 4-digit security password.

#### Tip

If you make a mistake, press **◀** repeatedly to delete password numbers one by one then correct it.

#### If you forget your 4-digit code

If you forget your password, to clear the current password, follow the procedure below.

1. Press **SYSTEM MENU** to display the Setup menu.
2. Use the Number buttons to enter the 6-digit number "210499".
3. Select "OK" then press **OK**. The 4-digit password is cleared. Enter a new code as shown above.

### Rating

Movies on DVDs may contain scenes not suitable for children. Therefore, discs may contain Parental Control information that applies to the complete disc or to certain scenes on the disc. These scenes are rated from Level 1 to 8, and alternatively, more suitable scenes are available for selection on some discs. Ratings are country-dependent. The Parental Control feature allows you to prevent discs from being played by your children or to have certain discs played with alternative scenes.

- 1** Press **SYSTEM MENU**.  
The Setup menu appears.
- 2** Use **▲ / ▼** to select the **LOCK** option.
- 3** While the **LOCK** option is selected, press **▶** to move to the second level.
- 4** Use **▲ / ▼** to select the **Rating** option.
- 5** Press **▶** to move to the third level.

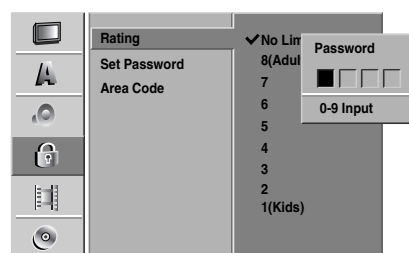

- 6** Enter a 4-digit password using the numbered buttons to confirm the personal 4-digit security password.
- 7** Select a rating from 1 to 8 using the **▲ / ▼** buttons. One (1) has the most playback restrictions. Eight (8) has the least playback restrictions.

**No Limit:** If you select No Limit, Parental Control is not active. The disc will play in full.

**Level 1 to 8:** Some discs contain scenes not suitable for children. If you set a rating for the recorder, all disc scenes with the same rating or lower will be played. Higher rated scenes will not be played unless an alternative scene is available on the disc. The alternative must have the same rating or a lower one. If no suitable alternative is found, playback will stop. You must enter the 4-digit password or change the rating level in order to play the disc.

- 8** Press **OK** to confirm your rating selection, then press **SYSTEM MENU** to exit the menu.

## Before Operation (Continued)

### Area Code

Enter the code of a country/area whose standards were used to rate the DVD video disc, referring to the list (See "Area Code List", page 58.).



- 1 Press SYSTEM MENU.**  
The Setup menu appears.
- 2 Use ▲ / ▼ to select the LOCK option.**
- 3 While the LOCK option is selected, press ► to move to the second level.**
- 4 Use ▲ / ▼ to select the Area Code option.**
- 5 Press ► to move to the third level.**
- 6 When you have not entered a password yet;** Enter a 4-digit password using the numbered buttons to create a personal 4-digit security password. Enter the 4-digit password again to verify.  
**When you have already entered a password;** Enter a 4-digit password using the numbered buttons to confirm the personal 4-digit security password.

#### Tip

If you make a mistake, press ◀ repeatedly to delete password numbers one by one then correct it.

- 7 Select the first character using the ▲ / ▼ buttons.**
- 8 Shift the cursor using ► buttons and select the second character using ▲ / ▼ buttons.**
- 9 Press OK to confirm your Area Code selection, then press SYSTEM MENU to exit the menu.**

### RECORD

#### Disc Record Mode

You can set the picture quality for DVD recording; XP (High Quality), SP (Standard Quality), LP (Low Quality), EP (Extend Quality).

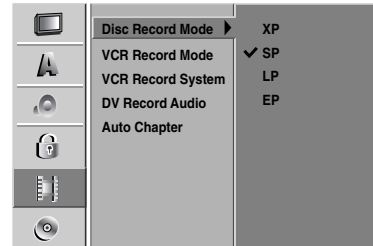

- 1 Press SYSTEM MENU.**  
The Setup menu appears.
- 2 Use ▲ / ▼ to select the RECORD option.**
- 3 While the RECORD option is selected, press ► to move to the second level.**
- 4 Use ▲ / ▼ to select the Disc Record Mode option.**
- 5 Press ► to move to the third level.**
- 6 Use ▲ / ▼ to select a desired Record Mode (XP, SP, LP or EP)**
- 7 Press OK to confirm your selection, then press SYSTEM MENU to exit the menu.**

#### VCR Record Mode

You can set the picture quality for VCR recording; SP (Standard Play), LP (Long Play).

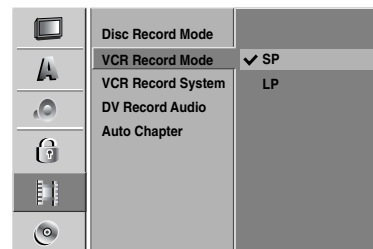

## Before Operation (Continued)

### VCR Record System

Your video recorder uses triple colour standards, PAL, SECAM and MESECAM. During recording your video recorder should select the colour system automatically, however if you experience problems you may need to do it manually.

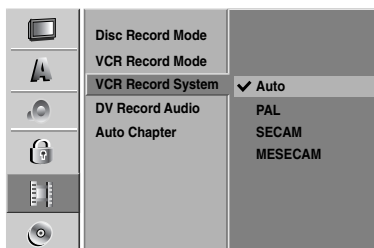

### DV Record Audio

You need to set this if you have a camcorder using 32kHz/12-bit sound connected to the front panel DV IN jack.

Some digital camcorders have two stereo tracks for audio. One is recorded at the time of shooting; the other is for overdubbing after shooting.

On the Audio 1 setting, the sound that was recorded while shooting is used.

On the Audio 2 setting, the overdubbed sound is used.

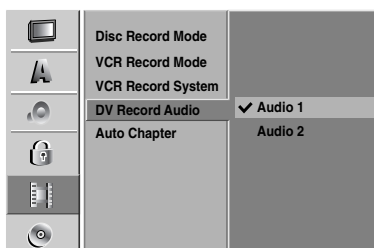

### Auto Chapter

When recording, chapter markers are put in specified setting. You can change this interval to 5 minutes, or 10 minutes. If you select None, switch off automatic chapter marking altogether with the No Separation setting.

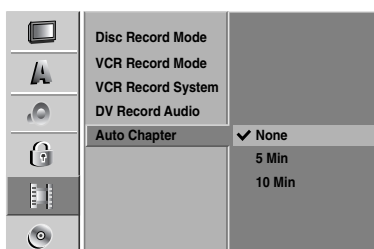

## DISC

### Initialize

If you load a completely blank disc, the recorder will initialize the disc.

**DVD+R:** The Initialize menu will appear. Select "OK" then press OK.

**DVD+RW:** The recorder initialize the disc to DVD+RW mode.

Also, you can format the disc from the Setup menu as below.

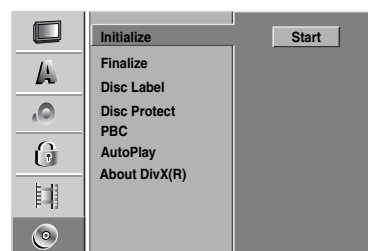

- 1 Press SYSTEM MENU.**  
The Setup menu appears.
- 2 Use ▲ / ▼ to select the DISC option.**
- 3 While the DISC option is selected, press ► to move to the second level.**
- 4 Use ▲ / ▼ to select the Initialize option.**
- 5 Press ► to move to the third level.**  
Start icon is highlighted.
- 6 Press OK.**  
Initialize menu appears.
- 7 Use ◀ / ▶ to select "OK" then press OK.**  
It takes a few moments to format the disc.

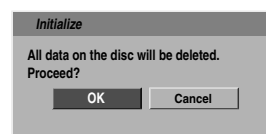

### Caution

**If you want to change the disc format, everything recorded on the disc will be erased.**

## Before Operation (Continued)

### Disc Finalize

Finalizing 'fixes' the recordings in place so that the disc can be played on a regular DVD player or computer equipped with a suitable DVD-ROM drive. Finalizing a Video mode disc creates a menu screen for navigating the disc. This is accessed by pressing LIST/DISC MENU or TITLE.

#### ⚠ Caution

- When DVD+R and DVD+RW recording, you've finalized a disc recording, you can't edit or record anything else on that disc except DVD+RW.

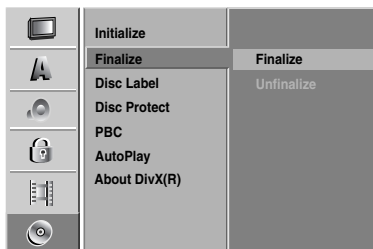

- 1 Follow steps 1-3 as shown on page 28 (Initialize).
- 2 Use ▲ / ▼ to select the Finalize option.
- 3 Press ► to move to the third level. Finalize is highlighted.
- 4 Press OK. Finalize menu appears.

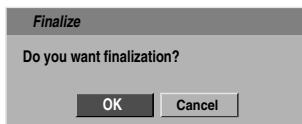

- 5 Select OK then press OK. The recorder starts finalizing the disc.

#### Note

How long finalization takes depends on the type of disc, how much is recorded on the disc, and the number of titles on the disc. A disc recorded can take up to 8 minutes or more to finalize.

### Disc Label

Use this to enter a name for the disc. This name appears when you display disc information on-screen.

- The disc name can be up to 32 characters long.
- For discs formatted on a different Recorder, you will see only a limited character set.

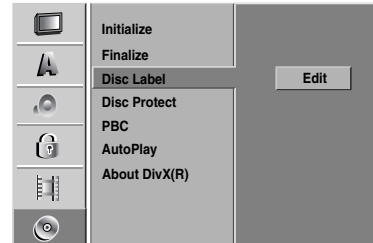

- 1 Follow steps 1-3 as shown Initialize on page 28.
- 2 Use ▲ / ▼ to select the Disc Label option.
- 3 Press ► to move to the third level. Edit icon is highlighted.
- 4 Press OK. Keyboard menu appears.

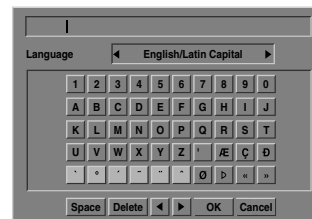

- 5 Enter a name for the disc. Use ▲ ▼ ◀ ▶ to select a character then press OK to confirm your selection. Refer step 3 as shown on page 22 (Station Rename).

- ▶ (PLAY): Inserts a space at the cursor position.
- || (PAUSE/STEP): Deletes the after character at the cursor position.
- (STOP), CLEAR: Deletes the previous character at the cursor position.
- ◀ / ▶: Moves cursor to left or right.
- Numbers (0~9): Enters the character of corresponding location on the selected column.
- LIST/DISC MENU, DISPLAY: Switches the keyboard type (English/Latin Capital, English/Latin Lowercase, Symbol)

- 6 Choose OK then press OK to fix the name and return to the Setup menu.

- 7 Press SYSTEM MENU to exit the menu.

## Before Operation (Continued)

English

### Disc Protect

When recording in DVD+RW / +R disc, set to ON to prevent accidental recording, editing or deleting of the disc loaded. If you need to unlock the disc to make edits, select OFF.

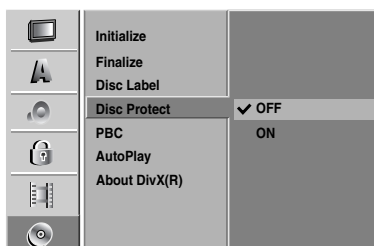

### PBC

Set Playback Control (PBC) to On or Off.

- ON: Video CDs with PBC are played according to the PBC.
- OFF: Video CDs with PBC are played the same way as Audio CDs.

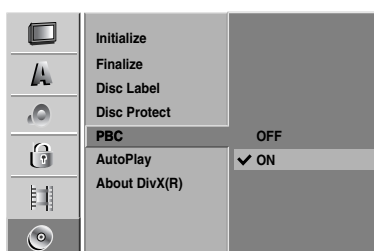

### Auto Play

You can set up the Recorder so a DVD disc automatically starts playing whenever the DVD is inserted. If Auto Play mode is set to On, this Recorder will search for title that has the longest playback time and then play back the title automatically.

**ON:** Auto Play function is active.

**OFF:** Auto Play function is not active.

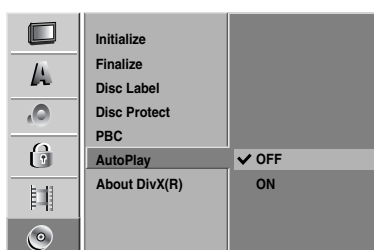

### Note

The Auto Play function may not work for some DVDs.

### About DivX(R)

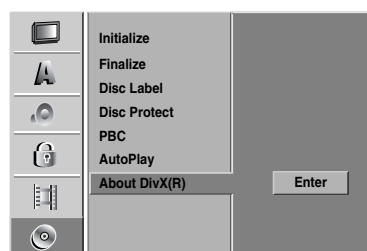

Philips provide you the DivX® VOD (Video On Demand) registration code that allows you to rent and purchase videos using the DivX® VOD service. For more information, visit [www.divx.com/vod](http://www.divx.com/vod).

- 1 Select "About DivX(R)" on the "DISC" menu then press ►.
- 2 Press OK and the registration code will appear.
- 3 Use the registration code to purchase or rent the videos from DivX® VOD service at [www.divx.com/vod](http://www.divx.com/vod). Follow the instructions and download the video onto a disc for playback on this unit.

### Note

All the downloaded videos from DivX® VOD can only be played back on this unit.

## Before Operation (Continued)

### General Explanation of On-Screen Display

This manual gives basic instructions for operating the Recorder. Some DVDs require specific operation or allow only limited operation during playback. When this occurs, the symbol  appears on the TV screen, indicating that the operation is not permitted by the Recorder or is not available on the disc.

### Displaying Information on-screen

You can display various information about the disc or tape loaded on-screen.



**1** Press **DISPLAY** repeatedly to display/change the information displayed on-screen.

**2** To remove the on-screen display, press **DISPLAY** or **RETURN** () repeatedly until it disappears. See the descriptions on next pages for detailed explanation during playing.

#### Notes

- Some discs may not provide all of the features on the on-screen display example shown on next pages.
- If no button is pressed for 7 seconds, the on-screen display disappears.

### Temporary Feedback Field Icons



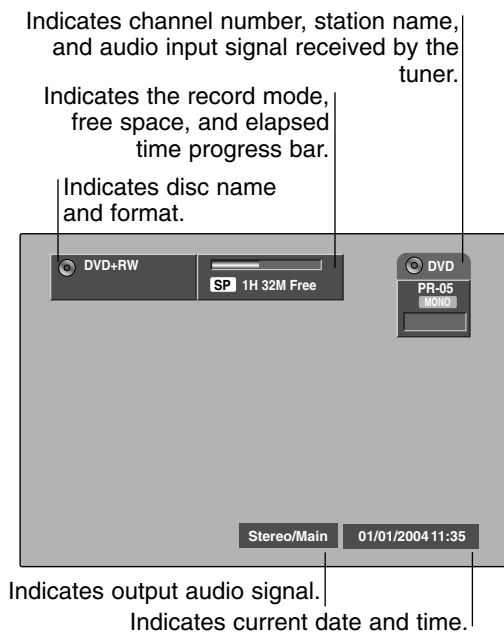

-  Resume play from this point
-  Action prohibited or not available

### Displaying Information While Watching TV

During viewing the TV, press **DISPLAY** to display/remove the information displayed on-screen.



### Changing TV Channels

If no disc or tape is playing, you can change TV channels using the number or  /  buttons on the remote control, or the CHANNEL ( / ) buttons on the front panel.

### Changing TV Audio Channel

Some TV programs are broadcast with a bilingual audio program (BIL). You can change the TV audio using the **AUDIO** button.

Press **AUDIO** repeatedly to change the TV audio as shown below.

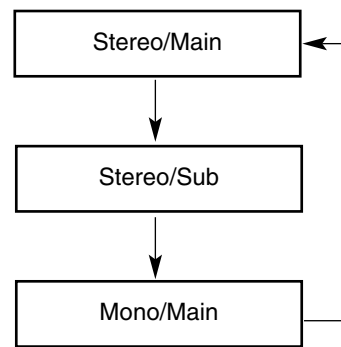

The current audio channel is displayed on-screen.

- For the detailed information, refer to the step 4 on page 44.
- If the sound is poor quality when set to Stereo, you can often improve it by changing to Mono.
- When an external input is selected, the audio channel can be switched only to Stereo.

## Before Operation (Continued)

### Displaying Information on-screen (Continued)







English

**DVD**

Shows the current title/chapter number and total number of titles/chapters.

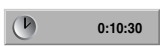
Shows the elapsed playing time and total time.

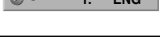
Shows the Current mode.



Menu Options	Function (Use ▲ / ▼ to select desired option)	Selection Method
Title Number 	Shows the current title number and total number of titles, and skips to the desired title number.	◀ / ▶, or Numbers, OK
Chapter Number 	Shows the current chapter number and total number of chapters, and skips to the desired chapter number.	◀ / ▶, or Numbers, OK
Time search 	Shows the elapsed playing time, and searches the point by the elapsed time directly.	◀ / ▶, Numbers, OK
Audio language and Digital Audio Output mode 	Shows the current audio soundtrack language, encoding method, and channel number, and changes the setting.	◀ / ▶
Subtitle language 	Shows the current subtitles language, and changes the setting.	◀ / ▶
Angle 	Shows the current angle number and total number of angles, and changes the angle number.	◀ / ▶
Sound 	Shows the current sound mode, and changes the setting.	◀ / ▶

**VCD**

Shows the current track number and total number of tracks, or shows PBC On mode.

Shows the elapsed playing time and total time.

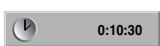



Shows the Current mode.

Menu Options	Function (Use ▲ / ▼ to select desired option)	Selection Method
Track Number 	Shows the current track number and total number of tracks or PBC On mode, and skip to the desired track number.	◀ / ▶, or Numbers, OK
Time 	Shows the elapsed playing time (Display only).	-
Audio Channel 	Shows the audio channel, and changes the audio channel.	◀ / ▶
Sound 	Shows the current sound mode, and changes the setting.	◀ / ▶

**DivX**

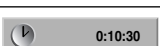
Shows the elapsed playing time and total time.

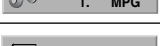
Shows the Current mode.





Menu Options	Function (Use ▲ / ▼ to select desired option)	Selection Method
Title Number 	Shows the current title number and total number of titles, and skips to the desired title number.	◀ / ▶, or Numbers, OK
Time search 	Shows the elapsed playing time, and searches the point by the elapsed time directly.	◀ / ▶, or Numbers, OK
Audio Channel 	Shows the audio channel, and changes the audio channel.	◀ / ▶
Subtitle 	Shows the current subtitles, and changes the setting.	◀ / ▶
Sound 	Shows the current sound mode, and changes the setting.	◀ / ▶



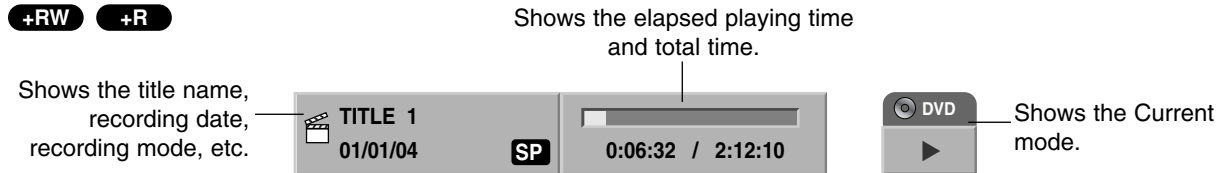

## Before Operation (Continued)

### Displaying Information on-screen (Continued)

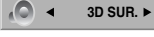

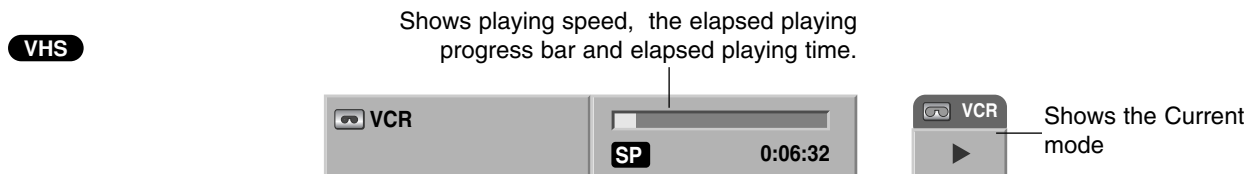
Menu Options	Function (Use ▲ / ▼ to select desired option)	Selection Method
Title Number 	<b>Shows the current title number and total number of titles, and skips to the desired title number.</b>	◀ / ▶, or Numbers, OK
Chapter Number 	<b>Shows the current chapter number and total number of chapters, and skips to the desired chapter number.</b>	◀ / ▶, or Numbers, OK
Time search 	<b>Shows the elapsed playing time, and searches the point by the elapsed time directly.</b>	◀ / ▶, Numbers, OK
Digital Audio Output mode 	<b>Shows the current audio encoding method, and channel number, and changes the setting.</b>	◀ / ▶
Sound 	<b>Shows the current sound mode, and changes the setting.</b>	◀ / ▶

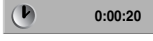

Menu Options	Function (Use ▲ / ▼ to select desired option)	Selection Method
Time 	<b>Shows the elapsed playing time (Display only).</b>	-
Audio Channel 	<b>Shows the audio channel, and changes the audio channel.</b>	◀ / ▶

## Operation with DVD and Video CD

### Playing a DVD or Video CD

#### Notes

- Multi session DVD containing Windows Media™ Audio files may not be supported.
- Open session disc does not be supported.
- This unit does not support PC data.
- This unit does not support an unfinalized disc with closed session.
- If color display on the TV is displayed wrongly, please toggle the switch between RGB and COMPONENT.

#### Playback Setup

- Before using the remote control, press the **DVD** button to select the device to be operated.
- Turn the TV on and select the video input source connected to the Recorder.
- Audio system: Turn the audio system on and select the input source connected to the Recorder.

#### 1 Press OPEN/CLOSE (▲) to open the disc tray.

#### 2 Load your chosen disc in the tray, with the playback side down.

- #### 3 Press OPEN/CLOSE (▲) to close the tray.
- READING appears on the display window, and playback starts automatically. If playback does not start, press ► (PLAY).  
In some cases, the disc menu might appear instead.

#### Tip

#### If a menu screen is displayed

The menu screen may be displayed first after loading a DVD or Video CD which contains a menu.

#### DVD

Use the ◀ ▶ ▲ ▼ buttons to select the title/chapter you want to view, then press OK to start playback. Press TITLE or LIST/DISC MENU to return to the menu screen.

#### VCD

- Use the number buttons to select the track you want to view.  
Press RETURN to return to the menu screen.
- Menu setting and the exact operating procedures for using the menu may differ depending on the disc. Follow the instructions on the each menu screen. You may also set PBC to OFF under Setup menu. See page 30.

#### Notes

- If Parental Control is set and the disc is not within the Rating settings (not authorized), the 4-digit code must be entered and/or the disc must be authorized (see "Rating", on page 26).
- DVDs may have a Region Code.  
Your recorder will not play discs that have a region code different from your recorder. The region code for this recorder is 2 (two).

### General Features

#### Note

Unless stated otherwise, all operations described use the remote control. Some features may also be available on the Setup menu.

#### Moving to another TITLE

**DVD +RW +R DivX**

When a disc has more than one title, you can move to another title as follows:

- Press DISPLAY twice then use ▲ / ▼ to select the title icon. Then, press the appropriate numbered button (0-9) or ◀ / ▶ to select a title number.

#### Moving to another CHAPTER/TRACK

**DVD +RW +R VCD**

When a title on a disc has more than one chapter/track, you can move to another chapter/track as follows:

- Press I◀ or ▶I briefly during playback to select the next chapter/track or to return to the beginning of the current chapter/track.
- Press I◀ twice briefly to step back to the previous chapter/track.
- To go directly to any chapter/track during playback, press DISPLAY twice. Then, use ▲ / ▼ to select chapter icon (or for a Video CD, select track icon). Then, enter the chapter/track number using the numbered buttons (0-9) or press ◀ / ▶.

#### Search **DVD +RW +R VCD**

- 1 Press REW (◀◀) or FWD (▶▶) during playback. The recorder will now go into SEARCH mode.
- 2 Press REW (◀◀) or FWD (▶▶) to select the required speed: ◀ (Reverse play), ◀◀, ◀◀◀, ◀◀◀◀, ◀◀◀◀◀, ◀◀◀◀◀◀ (backward) or ▶▶, ▶▶▶, ▶▶▶▶, ▶▶▶▶▶ (forward).  
With a Video CD, the Search speed changes: ◀◀, ◀◀◀, ◀◀◀◀ (backward) or ▶▶, ▶▶▶, ▶▶▶▶ (forward).
- 3 To exit SEARCH mode, press ► (PLAY).

#### Still Picture and Frame-by-Frame Playback

**DVD +RW +R VCD DivX**

- 1 Press PAUSE/STEP (||) during playback. The recorder will now go into PAUSE mode.
- 2 You can advance or back up the picture frame-by-frame by pressing ◀ / ▶ repeatedly during PAUSE mode.
- 3 To exit PAUSE mode, press ► (PLAY).

#### Note

The picture frame-by-frame in reverse is not available for Video CD.

#### Tip

You can advance the picture frame-by-frame by pressing PAUSE/STEP (||) repeatedly on the remote control.

## Operation with DVD and Video CD (Continued)

### General Features (Continued)

#### Slow Motion

**DVD** **+RW** **+R** **VCD**

- 1 Press PAUSE/STEP (||) during playback.  
The recorder will now go into PAUSE mode.
- 2 Press REW (◀◀) or FWD (▶▶) during PAUSE mode.  
The DVD Recorder will enter SLOW mode.
- 3 Use the REW (◀◀) or FWD (▶▶) to select the required speed: ◀◀ 1/16, ◀◀ 1/8, ◀◀ 1/4, or ◀◀ 1/2 (backward), or ▶▶ 1/16, ▶▶ 1/8, ▶▶ 1/4, or ▶▶ 1/2 (forward).  
With a Video CD, the Slow speed changes: ▶▶ 1/8, ▶▶ 1/4 or ▶▶ 1/2 (forward).
- 4 To exit Slow Motion mode, press ▶▶ (PLAY).

#### Note

Slow motion playback in reverse is not possible with Video CDs.

#### Repeat **DVD** **+RW** **+R** **VCD**

##### DVD Discs - Repeat Chapter/Title/Off

Press REPEAT to select a desired repeat mode.

- Chapter: repeats the current chapter.
- Title: repeats the current title .
- OFF: does not play repeatedly.

##### Video CDs - Repeat Track/All/Off

Press REPEAT to select a desired repeat mode.

- Track: repeats the current track.
- All: repeats the all tracks on the disc.
- OFF: does not play repeatedly.

#### Note

On a Video CD with PBC, you must set PBC to OFF in the Setup menu to use the Repeat function. See page 30.

#### Repeat A-B

**REPEAT**  
A - B

**DVD** **+RW** **+R** **VCD**

To repeat a sequence in a title:

- 1 Press REPEAT at your chosen starting point.  
Repeat icon and REPEAT A- appears on the TV screen.
- 2 Press OK at your chosen end point.  
Repeat icon and REPEAT A-B appears on the TV screen, and the repeat sequence begins.
- 3 To cancel the sequence, press REPEAT repeatedly to select REPEAT OFF.

#### Time Search

0:10:30

**DVD** **+RW** **+R** **DivX**

The Time Search function allows you to start playing at any chosen time on the disc.

- 1 Press DISPLAY twice during playback. The on-screen display appears on the TV screen.  
The Time Search box shows the elapsed playing time of the current disc.
- 2 Within 7 seconds, use ▲ / ▼ to select the Time Search icon in the on-screen display.  
The “-:--:--” appears in the Time Search box.
- 3 Within 7 seconds, use the number buttons to enter the required start time. Enter hours, minutes, and seconds from left to right in the box.  
You can not enter an invalid time.  
If you enter the wrong numbers, press ◀ / ▶ to move the under bar ( ) to the wrong number. Then enter the correct numbers.
- 4 Within 7 seconds, press OK to confirm the start time.  
Playback starts from the selected time on the disc.

## Operation with DVD and Video CD (Continued)

### General Features (continued)

#### Zoom

**DVD** **+RW** **+R**

The Zoom function allows you to enlarge the video image and to move through the enlarged image.

- 1 Press ZOOM during playback or still playback to activate the Zoom function.  
Each press of the ZOOM button changes the TV screen in the sequence shown below.  
x1 size → x2 size → x4 size → x1 size (normal size)
- 2 Use the ◀▶▲▼ buttons to move through the zoomed picture.
- 3 To resume normal playback, press CLEAR or press ZOOM repeatedly until the normal picture appears.

#### Note

The zoom function may not work for some DVDs.

#### Marker Search

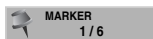

**DVD** **+RW** **+R** **VCD**

You can start playback from a memorized point. Up to six points can be memorized. To enter a mark, follow these steps.

- 1 During disc playback, press MARKER when playback reaches the spot that you want to memorize.  
The Marker icon will appear on the TV screen briefly.
- 2 Repeat step 1 to enter up to six Marker points on a disc.

#### To Recall a Marked Scene

- 1 Press SEARCH.  
The Marker Search menu will appear on the TV screen.
- 2 Use the ◀▶▲▼ buttons to select a Marked scene that you want to recall.
- 3 Press OK.  
Playback will start from the Marked scene.
- 4 To remove the Marker Search menu, press RETURN.

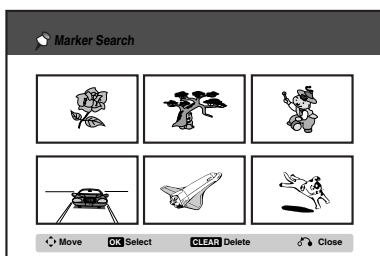

#### To clear a Marked Scene

- 1 Press SEARCH during playback or in stop mode.  
The Marker Search menu will appear on the TV screen.
- 2 Use ◀▶▲▼ to select the Marked scene that you want to erase.

- 3 Press CLEAR.  
“Delete selected marker? Proceed?” message appears.
- 4 Use ◀ / ▶ to select “OK” then press OK.
- 5 Repeat steps 2-4 to erase additional Marked scene.
- 6 To remove the Marker Search menu, press RETURN.

### Checking the Contents of DVD Video Discs: Menus

DVDs may contain menus that allow you to access special features. To open the disc menu, press LIST/DISC MENU. Then, press the appropriate number button to select an option. Or, use the ◀▶▲▼ buttons to highlight your selection, then press OK.

#### Title Menu **DVD**

- 1 Press TITLE.  
If the current title has a menu, the menu will appear on the TV screen. Otherwise, the disc menu may appear.
- 2 The menu may contain camera angles, spoken language and subtitle options, and chapters for the title.

#### Disc Menu **DVD**

- 1 Press LIST/DISC MENU.  
The disc menu is displayed.
- 2 To remove the disc menu, press LIST/DISC MENU again.

### Changing the Audio Soundtrack

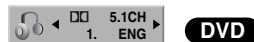

Press AUDIO then press ◀ / ▶ repeatedly during playback to hear a different audio language or audio soundtrack if available.

## Operation with DVD and Video CD (Continued)

### Changing the Audio Channel

**VCD** **+RW** **+R** **DivX**

With a Video CD, press AUDIO then press ◀ / ▶ repeatedly during playback to hear a different audio channel (STEREO, LEFT or RIGHT).

### 3D Surround

**DVD** **+RW** **+R** **VCD** **DivX**

This unit can produce a 3D Surround effect, which simulates multi-channel audio playback from two conventional stereo speakers, instead of the five or more speakers normally required to listen to multi-channel audio from a home theater system.

- 1 Press DISPLAY twice then use ▲ / ▼ to select the sound icon. Then, use ◀ / ▶ to select "3D SUR."
- 2 To turn off the 3D Surround effect, select "NORMAL".

### Finding Locations on a Disc **VCD**

You can directly access any point on a video CD using this function. Use this function only while a video CD is playing. Playback jumps to the point specified.

- 1 Press SEARCH during playback.  
The progress bar appears on the TV screen.



- 2 Use ◀ / ▶ to find a start position for playback.
- 3 Press OK to confirm the selected position.  
Playback starts from the selected position.

#### **ote**

This function works only when no marker is memorized.

### Last Condition Memory **DVD**

This recorder memorizes the user settings for the last disc that you have viewed. Settings remain in memory even if you remove the disc from the recorder or switch off the recorder. If you load a disc that had its settings memorized, the latest stop position is automatically recalled.

#### **otes**

- Settings are stored in memory for use any time.
- This recorder does not memorize settings of a disc if you switch off the recorder before commencing to play it.

## Playing a DivX Movie Disc

### Playing a DivX Movie Disc

Using this unit you can play DivX disc. Before playing DivX files, read "About DivX movie files" on page 38.

#### Notes

- Multi session DVD containing Windows Media™ Audio files may not be supported.
  - Open session disc does not be supported.
  - This unit does not support PC data.
  - This unit does not support an unfinalized disc with closed session.
  - If color display on the TV is displayed wrongly, please toggle the switch between RGB and COMPONENT.
1. Insert a disc and close the tray. The Movie menu appears on the TV screen.

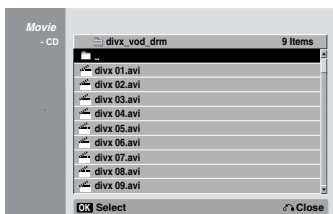

2. Press ▲ / ▼ to select a folder, and press OK. A list of files in the folder appears. If you are in a file list and want to return to the Folder list, use the ▲ / ▼ buttons on the remote to highlight and press OK.
3. If you want to view a particular file, press ▲ / ▼ to highlight a file and press PLAY. You can use variable playback functions. Refer to pages 34-37.
4. Press STOP to stop the playback. The Movie menu appears.

#### Tip

- On a CD with MP3/Windows Media™ Audio, JPEG and MOVIE file, you can switch Music, Photo and Movie menu. Press TITLE.

### Notice for displaying the DivX subtitle

Please refer to following notice when the DivX subtitle does not display properly.

1. Find a suitable language for the DivX subtitle on the figure below.

Disc Subtitle Language	Available DivX Subtitle
Original, English	English
French, German, Italian, Spanish, Portuguese	French, German, Italian, Spanish, Portuguese, Dutch, Swedish
Russian	Russian
Other 6976	Greek
Other 8076	Polish
Other 7285	Hungarian
Other 6783	Czech

2. Press SYSTEM MENU. The Setup menu appears. Press SYSTEM MENU → [LANGUAGE] → [Disc Subtitle] then select the language you have found. Refer to "Disc Menu/Audio/Subtitle" on page 24.

### Movie menu options

1. Press ▲ / ▼ to select a folder/file on the Movie menu then press OK. Movie menu options appear.
2. Press ▲ / ▼ to select an option, and press OK.
  - [Play] Start playback the selected title.
  - [Open] Opens the folder and a list of files in the folder appears
  - [Dubbing] Copies the file(s) to a VHS tape. (page 45)

### About DivX movie files

DivX disc compatibility with this recorder is limited as follows:

- Available resolution size of the DivX file is under 720x576 (W x H) pixel.
  - The file name of the DivX subtitle is limited to characters.
  - The total number of files and folders on the disc should be less than 1999.
  - **If the number of the screen frame is over 29.97 frames per second, this unit may not operate normally.**
  - **If the video and audio structure of recorded file is not interleaved, returns to the menu screen.**
  - **If the file is recorded with GMC, the unit supports only 1-point of the record level.**
    - \* GMC?
- GMC is the acronym for Global Motion Compensation. It is an encoding tool specified in MPEG4 standard. Some MPEG4 encoders, like DivX or Xvid, have this option. There are different levels of GMC encoding, usually called 1-point, 2-point, or 3-point GMC.

#### Playable DivX file

“.avi”, “.divx”

#### Playable DivX subtitle

“.smi”, “.srt”, “.sub (Micro DVD format only)”, “.txt (Micro DVD format only)”

- Divx subtitle except those listed above is not displayed on the TV screen.

#### Playable Codec format

“DIV3”, “MP43”, “DIVX”, “XVID”, “DX50”

#### Playable Audio format

“AC3”, “PCM”, “MP2”, “MP3”, “Windows Media™ Audio”

- Sampling frequency: within 8 - 48 kHz (MP3), within 32 - 48kHz (Windows Media™ Audio)
- Bit rate: within 8 - 320kbps (MP3), 32 - 192kbps (Windows Media™ Audio)

## Audio CD and MP3/Windows Media™ Audio Operation

### Playing an Audio CD or MP3/ Windows Media™ Audio

#### Disc **CD** **MP3**

The Recorder can play audio CDs. Also, the Recorder can play MP3/Windows Media™ Audio formatted recordings on CD-ROM, CD-R, CD-RW, DVD+R or DVD+RW disc. Before playing MP3/Windows Media™ Audio recordings, read the notes on MP3/Windows Media™ Audio Recordings on page 40.

#### Notes

- Multi session DVD containing Windows Media™ Audio files may not be supported.
- Open session disc does not be supported.
- This unit does not support PC data.
- This unit does not support an unfinalized disc with closed session.
- If color display on the TV is displayed wrongly, please toggle the switch between RGB and COMPONENT.

#### 1 Insert a disc and close the tray.

AUDIO CD or MP3 CD menu appears on the TV screen.

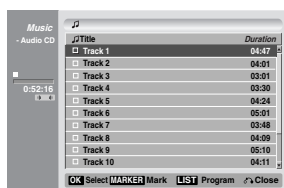

AUDIO CD Menu

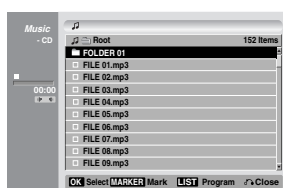

MP3/Windows Media™ Audio  
CD Menu

#### 2 Use ▲ / ▼ to select a track then press ▶ (PLAY).

Playback starts.

During playback, the current track's elapsed playing time will appear on the display window and menu. Playback will stop at the end of the disc.

#### Tips

- You can view TV channel or video input source by pressing RETURN. If you want to return to the Music menu, press LIST/DISC MENU.
- You can switch between the Track List and Program List menus by pressing LIST/DISC MENU.
- On CDs with mixed content (audio tracks, MP3/Windows Media™ Audio files and JPEG files), you can select among the Music-Audio CD menu, Music-MP3/Windows Media™ Audio CD menu, and Photo CD menu by pressing TITLE repeatedly in Stop mode.
- If you select a MP3 and press DISPLAY, the file informations are displayed. Press DISPLAY again to remove the file informations.  
If you select a folder and press DISPLAY, the number of subfolders and number of MP3/Windows Media™ Audio files in the folder are displayed.
- If you are in a file list and want to return to the Folder list, use the ▲/▼ to highlight and press OK to return to the previous menu screen.

**3** To stop playback at any other time, press STOP (■).

#### Music menu options

1. To display menu options, select a track (or folder) on the menu then press OK.
2. Use ▲ / ▼ to select an option then press OK to confirm your selection.

#### Music-Audio CD menu options **CD**

<b>Play</b>	<b>Play:</b> Starts playback the selected track.
<b>Program Add</b>	<b>Program Add:</b> Adds the track(s) to Program List. (page 41)
<b>Shuffle</b>	<b>Shuffle:</b> Plays tracks in random order.

#### Music-CD menu options **MP3**

- When you select a track.

<b>Play</b>	<b>Play:</b> Starts playback the selected track.
<b>Program Add</b>	<b>Program Add:</b> Adds the track(s) to Program List. (page 41)
<b>Shuffle</b>	<b>Shuffle :</b> Plays tracks in random order.

- When you select a folder.

<b>Open</b>	<b>Open:</b> Displays sub-folders and MP3/Windows Media™ Audio files only in the folder.
<b>Program Add</b>	<b>Program Add:</b> Adds all track(s) in the folder to Program List. (page 41)

## Audio CD and MP3/Windows Media™ Audio Operation (Continued)

### Pause **CD** **MP3**

- 1 Press PAUSE/STEP (||) during playback.
- 2 To return to playback, press ► (PLAY) or press PAUSE/STEP (||) again.

### Moving to Another Track **CD** **MP3**

- Press ◀ or ▶ briefly during playback to go to the next track or to return to the beginning of the current track.
- Press ◀ twice briefly to step back to the previous track.
- On an Audio CD, to go directly to any track, enter the track number using the numbered buttons (0-9) during playback on the Track List.

### Repeat Track/All(Folder)/Off **CD** **MP3**

Press REPEAT to select a desired repeat mode.

- TRACK: repeats the current track.
- ALL (CD): repeats the all tracks on the disc.
- FOLDER (MP3/Windows Media™ Audio): repeats the all tracks in the current folder.
- OFF (No display): does not play repeatedly.

### Changing the Audio Channel

#### **CD** **MP3**

Press AUDIO repeatedly to hear a different audio channel (stereo, left or right).

### Search **CD**

- 1 Press REW (◀◀) or FWD(▶▶) during playback. The recorder will now go into SEARCH mode.
- 2 Press REW (◀◀) or FWD(▶▶) to select the required speed: ◀◀, ◀◀◀, ◀◀◀◀ (backward) or ▶▶, ▶▶▶, ▶▶▶▶ (forward). Search speed and direction are indicated on the menu screen.
- 3 To exit SEARCH mode, press ► (PLAY).

### Repeat A-B **CD**

To repeat a sequence in a track:

- 1 Press REPEAT at your chosen start point. Repeat icon and 'A-' appears on the menu screen.
- 2 Press OK at your chosen end point. The Repeat icon and 'A - B' appears on the menu screen, and the repeat sequence begins.
- 3 To exit the sequence and return to normal play, press REPEAT again. The Repeat icon disappears from the menu screen.

## Notes on MP3/Windows Media™ Audio

### Recordings

#### About MP3

- An MP3 file is audio data compressed by using the MPEG1 audio layer-3 file-coding scheme. We call files that have the ".mp3" file extension "MP3 files".
- The recorder can not read an MP3 file that has a file extension other than ".mp3".

#### About Windows Media™ Audio

- An Windows Media™ Audio file is a Microsoft audio compression technology.
- Windows Media™ Audio offers double the audio.compression of the MP3 format.

#### MP3/Windows Media™ Audio Disc compatibility with this recorder is limited as follows:

1. CD-R physical format should be "ISO 9660" and "JOLIET".
2. If you record MP3/Windows Media™ Audio files using the software which cannot create a FILE SYSTEM, for example "Direct-CD" etc., it is impossible to playback MP3 files. We recommend that you use "Easy-CD Creator", which creates an ISO9660 or JOLIET file system.
3. Total number of files and folders on the disc should be less than 999.

This Recorder requires discs/recordings to meet certain technical standards in order to achieve optimal playback quality. Pre-recorded DVDs are automatically set to these standards. There are many different types of recordable disc formats (including CD-R containing MP3 or Windows Media™ Audio files) that require certain pre-existing conditions (see above) to insure compatible playback.

**Customers should also note that permission is required in order to download MP3/Windows Media™ Audio files and music from the Internet. Our company has no right to grant such permission. Permission should always be sought from the copyright owner.**



## Programmed Playback with Audio CD and MP3/Windows Media™ Audio

The Program function enables you to store your favorite tracks from any disc in the recorder memory. Program can contain 99 tracks (Audio CD) or 256 tracks (MP3/Windows Media™ Audio).

### 1 Insert an Audio CD or MP3/Windows Media™ Audio disc.

Audio CD or MP3/Windows Media™ Audio CD menu will appear.

### 2 Use ▲ ▼ to select a track or folder on the List then press OK.

The options appears on the left side of the menu.

### 3 Use ▲ ▼ to highlight the “Program Add” icon then press OK.

The selected track is added to the Program List.

### 4 Repeat steps 2-3 to place additional tracks on the Program list.



You can add multi tracks on the List to the Program List.

1. Select a track then press MARKER.
2. Repeat step 1 to mark additional tracks.
3. Select any track then press OK.  
The options appears on the left side of the menu.
4. Use ▲ / ▼ to highlight the “Program Add” icon then press OK.  
The all marked tracks are added to the Program List.



- Use the CLEAR button to select all tracks, or cancel all marked tracks.
- If you select folder for Programmed Playback, all tracks in the folder are added to the program list.

### 5 AUDIO CD : Use ► to move to the Program list.

### 6 Use ▲ / ▼ to select the track you want to start playing.

### 7 Press PLAY (▶) to start.

Playback begins in the order in which you programmed the tracks and “PRG” indicator appears on the display window.

Playback stops after playing the last programmed track on the program list.

### 8 To resume normal playback from programmed playback, select a track on the List then press PLAY (▶).

“PRG” indicator disappears from the display window.

## Program List menu options **CD** **MP3**

1. To display menu options, select a tack on the Program List menu then press OK.  
The menu options appear on the left side of the menu.
2. Use ▲ / ▼ to select an option then press OK to confirm your selection.

<b>Play</b>
<b>Move</b>
<b>Shuffle</b>
<b>Delete</b>

**Play:** Playback begins in the order in which you programmed the tracks from the selected track.

**Move:** Moves the track(s) to change the program order.

**Shuffle:** Plays tracks in random order.

**Delete:** Deletes the track(s) from the Program List menu.

### Repeat Programmed Tracks

Press REPEAT repeatedly during playback to select a desired repeat mode.

- TRACK: repeats the current track.
- ALL : repeats the all tracks on the Program list.
- OFF (No display): does not play repeatedly.

### Erasing a Track from the Program List

1. Select the track you wish to erase from the Program List.



Use the MARKER button to select multiple tracks.

2. Press OK.  
The menu options appear on the left side of the menu.
3. Select ‘Delete’ option then press OK.  
The selected track is deleted from the Program List.

### Changing Track Order in the Program List

1. Select the track you wish to move.



Use the MARKER button to select multiple tracks.

2. Press OK.  
The menu options appear on the left side of the menu.
3. Select ‘Move’ option then press OK.  
A yellow bar appears in the Program List.
4. Use ▲ / ▼ to move the yellow bar to the desired location, then press OK.  
The selected track is moved.

## JPEG File Operation

### Viewing a JPEG File **JPEG**

The recorder can play discs with JPEG files. Before playing JPEG recordings, read "Notes on JPEG Recordings" at right.

#### Notes

- Multi session DVD containing Windows Media™ Audio files may not be supported.
- Open session disc does not be supported.
- This unit does not support PC data.
- This unit does not support an unfinalized disc with closed session.
- If color display on the TV is displayed wrongly, please toggle the switch between RGB and COMPONENT.

#### 1 Insert a disc and close the tray.

The Photo menu appears on the TV screen.

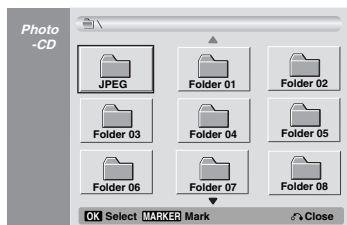

#### 2 Use ▲▼◀▶ to select a folder, then press OK.

Open icon is highlighted on the left side of the menu.

#### 3 Press OK.

A list of files in the folder appears.



#### Note

If the icon displays in the Photo menu, it means you cannot see those JPEG files.

#### 4 Use ▲▼◀▶ to select a file, then press OK.

The options appear on the left side of the menu.

#### Tip

- If you are in a file list and want to return to the Folder list, use the ▲/▼ buttons on the remote to highlight the icon and press OK.
- You can view TV channel or video input source by pressing RETURN. If you want to return to the Photo menu, press LIST/DISC MENU.
- On CDs with mixed content (audio tracks, MP3/Windows Media™ Audio files and JPEG files), you can select among the AUDIO CD menu, MP3/Windows Media™ Audio CD menu, and Photo CD menu by pressing TITLE repeatedly in Stop mode.

42

#### 5 Use ▲/▼ to select "Full Screen" option then press OK.

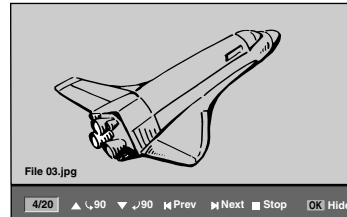

#### 6 To stop viewing at any time, press STOP. The Photo menu reappears.

### Skip Images

While viewing a picture, press ◀ or ▶ once to advance to the next file or return to the previous file.

### Rotate Images

Use ▲/▼ while viewing a picture to flip the picture clockwise or counterclockwise.

### View Slide Shows

1. Select "Slide Show" option on the Photo menu.
2. Press OK. The Slide Show menu appears.

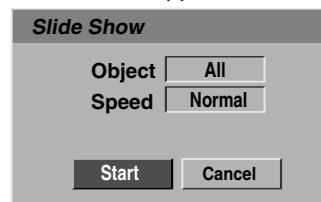

3. Use ▲▼◀▶ to set the options.  
Object: Selected file or All files.  
Speed: Sets the speed for Slide Show (Slow, Normal, or Fast)
4. Select the Start option then press OK to start the Slide Show.
5. Press STOP to stop the Slide Show and returns to the Photo menu.

#### Note

Use the MARKER button to select multiple files.

### Notes on JPEG Recordings

- Depending on the size and number of JPEG files, it may take several minutes for the recorder to read the disc's content. If you don't see an on-screen display after several minutes, some of the files are too big — reduce the resolution of the JPEG files to less than 4 mega pixels and burn another disc.
- The total number of files and folders are free but the total number of files on the folder should be less than 999.
- Some discs may be incompatible due to different recording formats or the condition of the discs.
- When you are using software such as "Easy CD Creator" to burn JPEG files on a CD-R, ensure that all selected files have the ".jpg" extension before copying them into the CD layout.
- If the files have ".jpe" extensions, please rename them as ".jpg" files.
- File names without the ".jpg" extension cannot be read by this recorder, even though the files are shown as JPEG image files in Windows Explorer®.

## Preparation

- Before using the remote control, press the **VCR** button to select the device to be operated.
- Turn the TV on and select the video input source connected to the Recorder.
- Audio system: Turn the audio system on and select the input source connected to the Recorder.

## Normal Playback **VHS**

### 1 Insert a prerecorded video cassette.

The  indicator will light and the Recorder will power-up automatically.

- Make sure that the **TIMER** indicator in the display window is not lighted. If it is, press  once.
- If a tape without a safety tab is inserted, the Recorder will start playback automatically.

### 2 Press **PLAY** () once.

**PLAY** icon appears on the TV screen.

- It is not necessary to select the tape speed for playback. It will be automatically selected by the Recorder.

### 3 Press **STOP** () to stop playback.

**STOP** icon appears on the TV screen.

If the tape reaches the end before **STOP** () is pressed, the Recorder will automatically stop, rewind and eject the tape, and turn itself off.

### **N**otes

- If you wish to watch the DVD playback during the VCR playback, press **DVD** (or **SOURCE**) to change to DVD mode and perform the DVD playback. If you press **VCR** (or **SOURCE**) to watch the VCR playback again, playback resumes from the point where playback was interrupted (PAL tape).
- You cannot playback for the both DVD and VCR at the same time.

## Tracking Control **VHS**





### Auto Tracking

The automatic tracking function adjusts the picture to remove snow or streaks.

The **AUTO TRACKING** function works in the following cases:

- A tape is played back for the first time.
- Tape speed (SP, LP) changes.
- Streaks or snow appear because of scratches on the tape.

### Manual Tracking

If noise appears on the screen during playback, press either / on the remote control or **CHANNEL** (/) on the front panel until the noise on the screen is reduced.

- In case of vertical jitter, adjust these controls very carefully.
- Tracking is automatically reset to normal when the tape is ejected or the power cord is unplugged for more than 3 seconds.

## Special Effect Playback **VHS**

### **N** Special effects playback notes

- Horizontal lines (noise bars) will appear on the TV screen. This is normal.
- The audio is automatically muted during special effect modes, so there is no sound during search.
- During the high-speed picture search modes, a short time is needed to stabilize tape speed when re-entering the **PLAY** mode. Slight interference may be observed during this time.

### Search

This function lets you visually search forward and backward for a desired scene on your tape.

#### 1 Press **REW** () or **FWD** () during playback.

The Recorder will be activated in the **SEARCH** mode.



- If the Recorder is left in the **SEARCH** mode for more than 3 minutes, the Recorder will automatically enter the **PLAY** mode, to protect the tape and video heads.

#### 2 To return to playback, press **PLAY** ()

### Still Picture and Frame-by-Frame Playback

#### 1 Press **PAUSE/STEP** () during playback.

A still picture appears on the TV screen.

- If a still picture vibrates vertically, stabilize it by using / on the remote control.

- If the Recorder is left in the **STILL** mode for more than 5 minutes, the Recorder will automatically enter the **STOP** mode to protect the tape and video heads.



#### 2 Press **PAUSE/STEP** () repeatedly to advance the video picture one frame at a time while viewing a still picture.

#### 3 To return to playback, press **PLAY** ()

### Slow Motion

#### 1 While in still mode, press **FWD** ()

The tape will be played back at a speed 1/19 times slower than the normal speed.

- During slow playback, use / on the Remote Control to minimize noise bands.
- If slow motion mode continues for more than 3 minutes, the Recorder will automatically change to normal play mode.

#### 2 To return to playback, press **PLAY** ()

### Counter Memory Function

This is useful if there is a section of tape you want to view immediately after recording or if you want to return to the same point several times.

#### 1 Begin recording or playing a tape.

#### 2 Press **DISPLAY** repeatedly to display the real-time counter on the TV screen.

#### 3 At the point you want to locate later, reset the real-time counter to 0:00:00 by pressing **CLEAR**.

Continue to play or record.

#### 4 Press **STOP** when recording or playback finishes.

#### 5 Press **RETURN**.

The tape automatically stops when the tape counter returns to about "0:00:00".

## Basic Recording

### Basic Recording from a TV

Follow the instructions below to record a TV program. Recording starts immediately and continues until the disc or tape is full or you stop the recording.

#### 1 Switch on the Recorder, select the device (VCR or DVD) for Recording and load a recordable disc or tape.

Also make sure that the TV input is set to this recorder.

#### 2 Set a recording mode as necessary by pressing REC MODE repeatedly.

DVD: SP (Standard quality), LP (Low quality), XP (High quality), EP (Extended quality)  
VCR: SP (Standard Play), LP (Long Play)

#### 3 Use CHANNEL (▲/▼) on the front panel or ▲/▼ on the remote control to select the TV channel to record.

#### 4 Use AUDIO to select the audio channel to record.

The table below shows what will be recorded on the different settings for different types of broadcast. The last column (Monitor Audio) shows what you'll hear as it is recording.

TV Broadcast Audio	Selected Audio	Broadcast Audio				Monitor Audio
		Tape		+R or +RW mode		
		L Ch	R Ch	L Ch	R Ch	
STEREO	STEREO/MAIN	STEREO		STEREO		STEREO
	STEREO/SUB	STEREO		STEREO		STEREO
	MONO/MAIN	MONO		MONO		MONO
MAIN+SUB	STEREO/MAIN	MAIN	SUB	MAIN	MAIN	MAIN
	STEREO/SUB	MAIN	SUB	SUB	SUB	SUB
	MONO/MAIN	MAIN	SUB	MAIN	MAIN	MAIN
MONO	STEREO/MAIN	MONO		MONO		MONO
	STEREO/SUB	MONO		MONO		MONO
	MONO/MAIN	MONO		MONO		MONO

#### 5 Press RECORD (●) once.

Recording will start. (The RECORD indicator lights in the display window.)

- Recording continues until you press STOP (■) or the disc (or tape) is full.
- To record for a fixed length of time, see Instant Timer Recording on right.

#### 6 Press STOP (■) to stop recording.

### Instant Timer Recording

Instant Timer Recording allows you to make a recording easily of a preset length without using the program timer.

#### 1 Follow steps 1-5 as shown left (Basic Recording from a TV).

#### 2 Press RECORD (●) repeatedly to select the recording time length.

Recording starts after the first press.

DVD: Each subsequent press increases the recording time by 10 minutes within free space.

VCR: Each subsequent press increases the recording time by 30 minutes. Please confirm the VHS tape has enough remaining time to be recorded before recording.

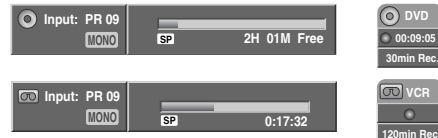

Instant Timer Record Menu

### Checking the Recording Time

Press RECORD (●) or DISPLAY once to check the recording time. The recalled setting will automatically return to the TV screen for a moment.

Also, remaining time of recording is shown in the display window.

### To Extend the Recording Time

The recording time can be extended anytime by pressing RECORD (●).

Each subsequent press increases the recording time by 10 minutes (DVD) within free space or 30 minutes (VCR).

### To Pause the Recording

- Press PAUSE/STEP (||) to pause the disc or tape during recording.
- When you want to continue recording, press PAUSE/STEP (||) or RECORD (●).

#### Notes

- If you press PAUSE/STEP (||) during the Instant Timer Recording, it will be canceled.
- The Recorder will automatically power off when the Instant Timer Recording ends.
- If the unit is in VCR recording when the DVD Instant Timer Recording ends, the unit will not automatically power off.

### To record one TV program while watching another

- Press TV/VIDEO to select the TV mode during recording. The TV indicator appears.
- Using the TV remote controller, select the channel to be viewed.

#### Tips

When recording onto a video tape, you can change a recording channel in the recording pause mode. (You cannot change a recording channel in the DVD recording pause mode.)

#### Notes

- If you wish to watch the DVD playback during the VCR recording, press DVD (or SOURCE) to change to DVD mode and perform the DVD playback. You cannot playback the VCR during the DVD recording.
- If you wish to use the DVD recording during the VCR recording, press DVD (or SOURCE) to change to DVD mode and perform the DVD recording. You cannot use the VCR recording during the DVD recording.

## Basic Recording (Continued)

### Copying from DVD to VCR

You can copy the contents of a DVD to a VHS tape using the D.DUBBING (or DIRECT DUBBING) button.

**Note**

If the DVD (or Discs) you are attempting to copy is copy protected, you will not be able to copy the disc. It is not permitted to copy Macrovision encoded DVDs (or Discs).

- 1 Insert a VHS Tape**  
Insert a blank VHS video tape into the VCR deck.
- 2 Insert a Disc**  
Insert the disc you wish to copy in the DVD deck and close the disc tray.
- 3 Select DVD mode by pressing DVD on the remote control or pressing SOURCE on the front panel.**
- 4 Find the place on the DVD (or Disc) from which you want to start recording using the PLAY and PAUSE functions.**  
For best results, pause playback at the point from which you want to record.
- 5 Press the D.DUBBING button on the remote control or press DIRECT DUBBING button on the front panel.**  
The Dubbing menu appears.

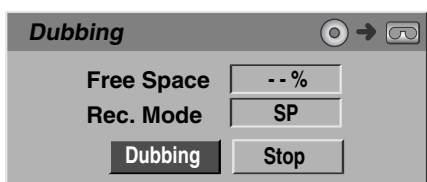

- 6 Use ▲ / ▼ / ◀ / ▶ to select the desired Record Mode:**
  - SP (Standard Play)
  - LP (Long Play, 2 times SP).
- 7 Select Dubbing then press OK or D.DUBBING (or DIRECT DUBBING) to start copying.**

**Tip**

If you press PAUSE/STEP during Copy mode, both the DVD and VCR decks go into Pause mode and the "DUB" indicator blinks on the front panel display. While in Pause mode, you can adjust the DVD playback position using PLAY, REW, FWD, PAUSE/STEP, etc. The VCR deck will remain in Pause mode. To resume copying, press the D.DUBBING (or DIRECT DUBBING) button twice.

- 8 Stop the Copy Process**  
To stop copying at any other time, press STOP (■). You must stop the Copy process manually when the DVD movie ends, or the unit may replay and record over and over again.

### Copying from VCR to DVD

You can copy the contents of a VHS tape to a recordable DVD disc using the D.DUBBING (or DIRECT DUBBING) button. This allows you to archive your old VHS tapes to DVD.

**Note**

If the VHS video tape you are attempting to copy is copy protected, you will not be able to copy the tape. It is not permitted to copy Macrovision encoded tapes.

- 1 Insert a recordable DVD disc.**  
Insert a blank recordable DVD disc in the DVD deck and close the disc tray.
- 2 Insert a VHS Tape**  
Insert the VHS video tape you wish to copy into the VCR deck.
- Note**  
When using a DVD+RW disc, you must initialize before copying; see page 28.
- 3 Select VCR mode by pressing VCR on the remote control or pressing SOURCE on the front panel.**
- 4 Find the place on the VHS tape from which you want to start recording using the PLAY, REW, FWD and PAUSE functions.**  
For best results, pause playback at the point from which you want to record.
- 5 Press the D.DUBBING button on the remote control or press DIRECT DUBBING button on the front panel.**  
The Dubbing menu appears.

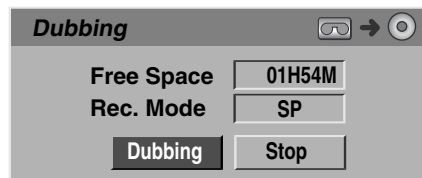

- 6 Use ▲ / ▼ / ◀ / ▶ to select the desired Record Mode:**
  - EP (Extended Quality)
  - LP (Low Quality)
  - SP (Standard Quality)
  - XP (High Quality)
- 7 Select Dubbing then press OK or D.DUBBING (or DIRECT DUBBING) to start copying.**

**Tip**

If you press PAUSE/STEP during Copy mode, both the DVD and VCR decks go into Pause mode and the "DUB" indicator blinks on the front panel display. While in Pause mode, you can adjust the VCR playback position using PLAY, REW, FWD, PAUSE/STEP, etc. The DVD deck will remain in Pause mode. To resume copying, press the D.DUBBING (or DIRECT DUBBING) button twice.

- 8 Stop the Copy Process**  
To stop copying at any other time, press STOP (■). Copying will stop automatically when the VHS tape ends.

## Timer Recording

This Recorder can be programmed to record up to 8 programs within a period of 1 month.

### 1 Press **TIMER**.

The Timer Record menu will appear.

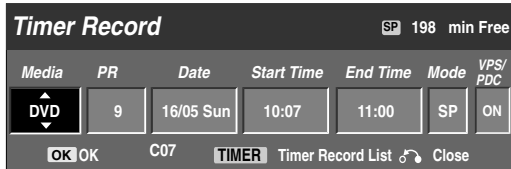

- **Media** – Choose a media (DVD or VCR).
- **PR** – Choose a memorized program number, or one of the external inputs from which to record.
- **Date** – Choose a date up to 1 month in advance, or select a daily or weekly program.
- **Start Time** – Set the recording start time.
- **End Time** – Set the recording end time.
- **Mode** – Choose a record mode.  
DVD: SP, LP, EP, XP, or AT (Auto)  
VCR: SP, LP, AT (Auto)  
AT (Auto) mode determines how much time is available on the disc or tape and switches record mode, if necessary, to complete recording the program. AT mode cannot be selected when VPS/PDC is ON.
- **VPS/PDC** – The VPS/PDC system automatically adjusts the recording time so that even if a program is not running to schedule, you won't miss it. For VPS/PDC to work properly, you must input the correct announced time and date of the program you want to record.  
Note that VPS/PDC may not work with every station.

#### **N**otes

- Stations that use VPS/PDC typically include VPS/PDC information in the teletext TV guide pages. Please refer to these pages when setting a timer recording.
- This recorder takes approximately 20 seconds to switch on and start recording. This means that when using VPS/PDC, there may be instances where the beginning of the program is not recorded.

### 2 Enter the necessary information for your timer recording(s).

- ◀ / ▶ (left/right) – move the cursor left/right
- ▲ / ▼ (up/down) – change the setting at the current cursor position
- Press RETURN to exit the Timer Record menu.
- Press TIMER to display Timer Record List.

### 3 Press **OK** to save the program.

The Timer Record List will appear.

### 4 Press **RETURN** (↵) to exit the Timer Record List.

### 5 Make sure that you load a recordable disc or tape and press **⏻** to switch your unit to Standby.

#### **N**otes

- The Timer indicator lights on the front panel display.
- If the Disc and Tape indicator are blinking, either no disc or tape is loaded, or the loaded disc is not recordable.
- The Recorder will record the audio according to the current TV tuner setting (Stereo, Mono or Bilingual). Use the AUDIO button to set the audio before switching the Recorder to Standby mode.
- You must press **⏻** to stop the Timer Recording.
- The Recorder will automatically power off when the Timer Recording ends.  
If the unit is DVD mode when the VCR timer recording ends, the unit will not automatically power off.
- There is a short delay when a timer recording finishes to confirm the recorded program. If two timer recordings are set to record sequentially (one right after the other), the very beginning of the later program may not be recorded.
- If you wish to watch the DVD playback during the VCR timer recording, press DVD (or SOURCE) to change to DVD mode and perform the DVD playback. You cannot playback the VCR during the DVD timer recording:

## The recommendable recordable DVD discs

DVD+R	DVD+RW	DVD+R(DL)
SONY (2.4x, 4x, 8x, 16x)	SONY (2.4x)	Mitsubishi (2.4x)
TDK (4x)	TDK (2.4x)	Maxell (2.4x)
Mitsubishi (4x, 8x)	Philips (4x)	-
Ricoh (2x, 4x, 8x)	Ricoh (2.4x)	-
-	HP (2.4x, 4x)	-

## Timer Recording with SHOWVIEW® System

This system makes programming timer recordings very simple. Most TV guides publish SHOWVIEW programming numbers with their program details. If you want to make a timer recording of a program, you just input the corresponding SHOWVIEW programming number. The date, start, stop and channel settings are made automatically. All you have to do is tell the recorder the recording mode and quality, and whether it's a once-only recording, or a regular recording. Up to 8 timer programs can be stored in the recorder.

### 1 Press SHOWVIEW.

The SHOWVIEW menu will appear.  
Press SHOWVIEW again to exit the menu.

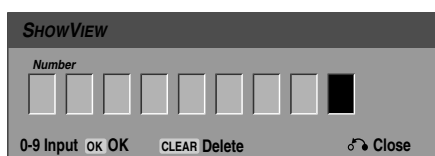

### 2 Use the number buttons then press OK to enter the SHOWVIEW programming number.

- If you make a mistake before pressing OK, press CLEAR repeatedly to delete password numbers one by one then correct it.

To check the programming, the Timer Record menu will appear.

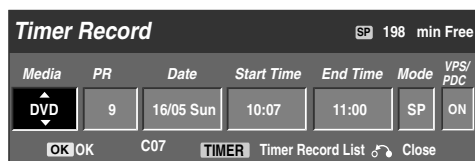

You can change the settings as required (Mode, VPS/PDC, etc.)

### 3 Follow steps 2-5 as shown on previous page (Timer Recording).

## Checking Timer Recording Details

Programming can be checked whenever the Recorder is turned on. Press TIMER twice.

- Use ▲ / ▼ to select a timer recording.
- Press OK to edit the selected program. Timer Record menu appears.
- Press CLEAR to delete the selected program from the Timer Record List.



## Canceling a Timer Recording

You can clear a timer setting anytime before the recording actually starts.

- Use ▲ / ▼ to select a program you want to erase on the Timer Recorder List. If you want to erase the program, press CLEAR.

## Stopping a Timer Recording in Progress

After a timer recording has started, you can still cancel the program.

- Press ⏻.

## Timer Recording Troubleshooting

**Even though the timer is set, the recorder will not record when:**

- There is no disc (or tape) loaded.
- A non-recordable disc (or tape) is loaded.
- Disc Protect is set to ON in the Setup menu (see page 30).
- Power is turned on. (Please ensure that the set is in Standby mode for Timer recording to activate.)
- There are already 49 titles recorded on the disc.

**You cannot enter a timer program when:**

- A recording is already underway.
- The time you're trying to set has already passed.
- There are already 8 timer programs set.

**If two or more timer programs overlap:**

- The earlier program takes priority.
- When the earlier program finishes, the later program starts.
- If two programs are set to start at exactly the same time, the program entered first takes priority.

If the disc is damaged, the recording may not complete successfully. In this case even though the Check field shows "Rec. OK", it may not be.

## Recording from an External Input

### Recording from External Components

You can record from an external component, such as a camcorder or VCR, connected to any of the recorder's external inputs.

- 1 Make sure that the component you want to record from is connected properly to the Recorder. See page 19.**
- 2 Press ▲ or ▼ repeatedly to select the external input to record from.**
  - Tuner: Built-in tuner
  - AV1: EURO AV1 AUDIO/VIDEO mounted on back panel
  - AV2: EURO AV2 DECODER mounted on front panel
  - AV3 : AV3 IN (VIDEO, AUDIO (L/R), S-VIDEO IN) mounted on front panel
  - DV: DV IN mounted on front panel

#### **N**ote

Check that the Audio In settings DV Record Audio are as you want them. See page 28.

- 3 Load a recordable disc or tape.**
- 4 Select the recording mode as necessary by pressing REC MODE repeatedly.**

DVD: SP (Standard Quality), LP (Low Quality), XP(High Quality), EP (Extended Quality)

VCR: SP (Standard Play), LP (Long Play)
- 5 Press RECORD (●) once.**

Recording will start. (The RECORD indicator lights in the display window.)

  - Recording continues until you press STOP (■) or the disc or tape is full.
  - To record for a fixed length of time, see Instant Timer Recording on page 44.
- 6 Press STOP (■) to stop recording.**

#### **N**ote

If your source is copy-protected using CopyGuard, you will not be able to record it using this recorder. See Copyright on page 10 for more details.

### Recording from a Digital Camcorder

You can record from a digital camcorder connected to the DV IN jack on the front panel of this recorder. Using the recorder's remote, you can control both the camcorder and this recorder.

Before recording, make sure that the audio input for the DV IN jack is set up (see page 28).

#### **T**ips

- The source signal must be DVC-SD format.
- Some camcorders cannot be controlled using this recorder's remote.
- If you connect a second DVD Recorder using a DV cable, you cannot control the second DVD Recorder from this one.
- You can't control this unit remotely from a component connected to the DV IN jack.
- You can't record date and time information from a DV cassette.

- 1 Make sure your digital camcorder is connected to the front panel DV IN jack. See page 19.**
- 2 Check that the DV audio input is as you require.**

You can choose between Audio 1 (original audio) and Audio 2 (overdubbed audio).

  - DV Input is set from the DV Record Audio in sub-menu of the Setup menu. See DV Record Audio on page 28 for more information.
- 3 Press ▲ or ▼ repeatedly to select the DV input.**

DV appears in the display window.
- 4 Find the place on the camcorder tape that you want to the recording to start from.**

For best results, pause playback at the point from which you want to record.

  - Depending on your camcorder, you can use this recorder's remote to control the camcorder using the STOP, PLAY and PAUSE functions.
- 5 Press RECORD (●) once to start recording.**

- Recording is automatically stopped if the recorder detects no signal.
- You can pause or stop the recording by pressing PAUSE/STEP (||) or STOP (■). You cannot control the camcorder from this remote control during recording.
- In Video mode, the final frame of the recording may remain displayed on screen for a while after recording stops.
- For timer recording to work properly on this recorder, the digital camcorder must also be switched on and in operating.



## Recording from an External Input (Continued)

### What is DV?

Using DV, also known as i.LINK, you can connect a DV-equipped camcorder to this recorder using a single DV cable for input and output of audio, video, data and control signals.

The i.LINK interface is also known as IEEE 1394-1995. "i.LINK" and the "i.LINK" logo are trademarks.

- This recorder is only compatible with DV-format (DVC-SD) camcorders. Digital satellite tuners and Digital VHS video recorders are not compatible.
- You cannot connect more than one DV camcorder at a time to this recorder.
- You cannot control this recorder from external equipment connected via the DV IN jack (including two DVD recorders).
- It may not always be possible to control the connected camcorder via the DV IN jack.
- Digital camcorders can usually record audio as stereo 16-bit/48kHz, or twin stereo tracks of 12-bit/32kHz. This recorder can only record one stereo audio track. Set DV Record Audio to Audio 1 or Audio 2 as required (see page 28).
- Audio input to the DV IN jack should be 32 or 48kHz (not 44.1kHz).
- Picture disturbance on the recording may occur if the source component pauses playback or plays an unrecorded section of tape, or if the power fails in the source component, or the DV cable becomes disconnected.
- Although DV Record Audio is set to Audio 2 and Audio 2 signal is not present, DV Rec Audio will be reset to Audio 1 automatically.

### DV-Related Messages

You may see the following messages appear on your TV screen when using the DV IN jack.

#### **Not connected to Camcorder.**

The camcorder is not connected properly, or the camcorder is switched off.

#### **Too many devices connected.**

The DV jack on this recorder supports connection to just one camcorder.

#### **Check the tape.**

There is no cassette loaded into the connected equipment.

#### **Uncontrollable device.**

This recorder cannot control the camcorder.

#### **Updating the information.**

Camcorder is updating the information for DV.

#### **Camera mode.**

Camcorder is set to camera mode.

### Troubleshooting

If you can't get a picture and/or audio through the DV IN jack, check the bullet points:

- Make sure the DV cable is properly connected.
- Try switching off the connected equipment then switch back on.
- Try switching the audio input.

#### **Notes**

- Depending on the connected camcorder, you may not be able to control it using the remote control supplied with this recorder.
- Before you set the mode of your Camcorder to camera mode, turn down the volume of connected Sound device. There can be a howling sound.

## Title List and Chapter List Menu

### Using the Title List menu **+RW**

The Title List is where you can see the all recorded titles, and where you can delete titles and make other changes to the Original content of the disc. You can also play titles directly from the Title List menu. The recorder must be stopped in order to edit using the Title List menu.

#### 1 Press LIST/DISC MENU to display the Title List menu.

- Use the ▲ / ▼ buttons to display the previous/ next page if there are more than 6 titles.
- To exit the Title List menu, press RETURN (↵).

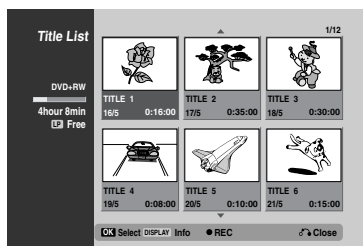

#### 2 To view Title List options, select the title you want then press OK.

Title List options appears on the left side of the menu.

#### 3 Use ▲ / ▼ to select an option then press OK to confirm.

Play
Full Play
Chapter
Delete
Protect
Edit >
Dubbing

**Play:** Starts playback the selected title except the hidden chapters.

**Full Play:** Starts playback the selected title including the hidden chapters.

**Chapter:** Moves Chapter List menu of the title. (refer to right on this page)

**Delete:** Deletes the title. (page 52)

**Protect:** Protects accidental recording, editing or deleting of the title. (page 54)

**Edit:** Selects Edit options.

- **Title Name:** Edits the title name. (page 53)
- **Divide:** Divides one title into two titles. (page 55)
- **Hide (Show):** Hides (or Shows) the all chapters within the title. (page 55)

**Dubbing:** Cops the title to a VHS tape.

#### 4 Press RETURN (↵) repeatedly to exit Title List menu.



**Tip**  
Press DISPLAY to display more detailed title information for selected title.



**Caution**  
If you press RECORD (●) when the Title List menu appears, the selected title is erased then overwrite recording starts. (See page 56 for more details.)

### Using the Chapter List menu **+RW**

#### 1 Press LIST/DISC MENU to display Title List menu.

#### 2 Use ▲ ▼ ◀ ▶ to choose the title you want to view Chapter List menu then press OK. Title List options appears on the left side of the menu.

#### 3 Use ▲ / ▼ to select 'Chapter' from Title List options then press OK. Chapter List menu appears on the TV screen.

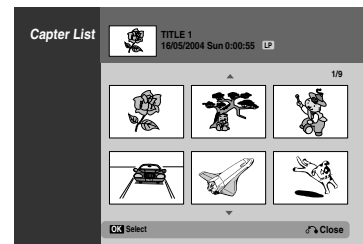

#### 4 To view Chapter List options, select the chapter you want then press OK.

Chapter List options appears on the left side of the menu.

#### 5 Use ▲ / ▼ to select an option then press OK to confirm.

Play
Title
Combine
Hide

**Play:** Starts playback of the selected chapter.

**Title:** Moves to Title List menu of the chapter. (refer to left on this page)

**Combine:** Combines two chapters into one. (page 53)

**Hide (Show):** Hides (or Shows) the selected chapter. (page 55)

#### 6 Press RETURN (↵) repeatedly to exit Chapter List menu.

## Title List and Chapter List Menu (Continued)

### Using the Title List menu **+R**

The Title List is where you can see the all recorded titles, and where you can delete titles and make other changes to the Original content of the disc. You can also play titles directly from the Title List menu. The recorder must be stopped in order to edit using the Title List menu.

#### 1 Press LIST/DISC MENU to display the Title List menu.

- Use the ▲ / ▼ buttons to display the previous/ next page if there are more than 6 titles.
- To exit the Title List menu, press RETURN (↵).

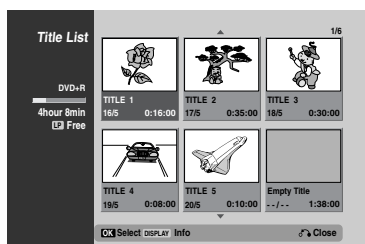

#### 2 To view Title List options, select the title you want then press OK.

Title List options appears on the left side of the Title List menu.

#### 3 Use ▲ / ▼ to select an option then press OK to confirm.

Play
Full Play
Chapter
Delete
Protect
Edit >
Dubbing

**Play:** Starts playback the selected title except the hidden chapters.

**Full Play:** Starts playback the selected title including the hidden chapters.

**Chapter:** Moves Chapter List menu of the title. (refer to right on this page)

**Delete:** Deletes the title. (page 52)

**Protect:** Protects accidental recording, editing or deleting of the title. (page 54)

**Edit:** Selects Edit options.

- **Title Name:** Edits the title name. (page 53)
- **Hide (Show):** Hides (or Shows) the all chapters within the title. (page 55)

**Dubbing:** Copys the title to a VHS tape.

Title Name
Divide
Hide

#### 4 Press RETURN (↵) repeatedly to exit Title List menu.

#### **T**ip

Press DISPLAY to display more detailed title information for selected title.

### Using the Chapter List menu **+R**

#### 1 Press LIST/DISC MENU to display Title List menu.

#### 2 Use ▲▼◀▶ to choose the title you want to view Chapter List menu then press OK.

Title List options appears on the left side of the menu.

#### 3 Use ▲ / ▼ to select 'Chapter' from Title List options then press OK.

Chapter List menu appears on the TV screen.



#### 4 To view Chapter List options, select the chapter you want then press OK.

Chapter List options appears on the left side of the menu.

#### 5 Use ▲ / ▼ to select an option then press OK to confirm.

Play
Title
Combine
Hide

**Play:** Starts playback of the selected chapter.

**Title:** Moves to Title List menu of the chapter. (refer to left on this page)

**Combine:** Combines two chapters into one. (page 53)

**Hide (Show):** Hides (or Shows) the selected chapter. (page 55)

#### 6 Press RETURN (↵) repeatedly to exit Chapter List menu.

## Title and Chapter Editing

### Adding Chapter Markers **+RW**



- 1** Play the title.
- 2** At the point you want to start a new chapter, press **CHAPTER**.
  - A chapter marker icon appears on the TV screen.
  - You can also put chapter markers in during recording.

#### **N**ote

Chapter markers are inserted at regular intervals automatically. You can change this interval from the Initial Setup menu (see Auto Chapter on page 28).

### Changing Title Thumbnails



Each title displayed in the Title List menu is represented by a thumbnail picture taken from the start of that title or chapter.  
If you prefer, select a different still picture from within a title.

- 1** Play the title.
- 2** Press **THUMBNAIL**.

### Deleting a Title **+RW** **+R**

- 1** On the Title List menu, use **▲ ▼ ◀ ▶** to choose a title you want to delete then press **OK**.  
Options appears on the left side of the screen.
- 2** Select 'Delete' option on the options on the menu.

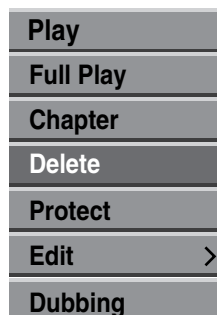

- 3** Press **OK** to confirm.  
The confirm message for deleting will appear.
- 4** Use **◀ / ▶** to select 'OK' then press **OK**.  
The selected title is deleted.  
After pressing OK, the new, updated menu is displayed.
- 5** Repeat steps 1 - 4 to continue to delete from the menu.
- 6** Press **RETURN** repeatedly to exit the menu.

#### **N**ote

- When DVD+RW recording, the deleted title's name is changed to 'Deleted Title'.
- If the deleted titles more than two are continued, the titles are combined into one.

## Title and Chapter Editing (Continued)

### Naming a Title +RW +R

You can name titles independently. Names can be up to 32 characters long.

- 1** On the Title List menu, use ▲▼◀▶ to choose the title you want to name then press OK. Options appears on the left side of the menu.
- 2** Use ▲/▼ to select 'Title Name' option then press OK. Keyboard menu appears.



- 3** Enter a name for the title. Use ▲▼◀▶ to select a character then press OK to confirm your selection. Refer step 3 as shown on page 22 (Station Rename).

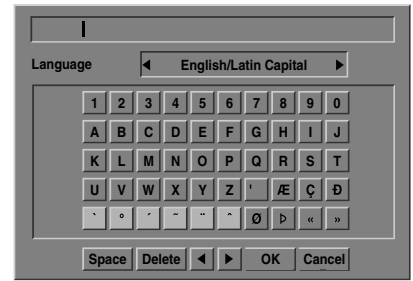

- 4** Choose OK then press OK to fix the name and return to the previous menu screen.
- 5** Press RETURN repeatedly to exit the menu.

#### **N**otes

- Names can be up to 32 characters long.
- For discs formatted on a different DVD Recorder, you will see only a limited character set.

### Combining Two Chapters Into One +RW +R

#### **N**ote

This function is not available if there is only one chapter within the title.

- 1** On the Chapter List menu, select the second chapter of the two chapters you want to combine then press OK. Chapter List options appears on the left side of the menu.
- 2** Use ▲ / ▼ to select 'Combine'.



- 3** Press OK to confirm. After pressing OK, the new, updated menu is displayed.
- 4** Repeat steps 1 - 3 to continue to combine from the menu.
- 5** Press RETURN repeatedly to exit the menu.

## Title and Chapter Editing (Continued)

---

### Protect a Title **+RW** **+R**

Use this function to protect accidental recording, editing or deleting of the title.

- 1** Press LIST/DISC MENU to display Title List menu.
- 2** Use ▲ ▼ ◀ ▶ to choose a title you want to protect then press OK.  
Options appears on the left side of the screen.
- 3** Select 'Protect' option on the options.

e.g., If you select "Protect" on Title List menu.

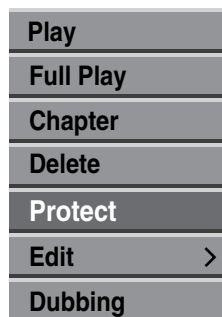

- 4** Press OK to confirm.  
The lock mark will appears on the title's thumbnail.

#### Tip

If you select a title that has already been protected on the Title List menu, you can unprotect it by choosing "Unprotect" from the Title List menu options. After doing this, you can edit and delete the title.

## Title and Chapter Editing (Continued)

### Hide a Title/Chapter **+RW** **+R**

Use this function to hide a title/chapter on the Title List or Chapter List menu.

**1** On the Title List or Chapter List menu, use **▲▼◀▶** to choose a title or chapter you want to hide then press **OK**.

Options appears on the left side of the screen.

**2** Select 'Hide' option on the options.

e.g., If you select "Hide" on Title List menu.

Play	
Full Play	
Chapter	
Delete	
Protect	Title Name
Edit	Divide
Dubbing	Hide

**3** Press **OK** to confirm.

The title's thumbnail will be dim.



**ip**

If you select a title that has already been dim on the Title List menu, you can show it by choosing "Show" from the Title List menu options. After doing this, you can see the title.

### Divide One Title Into Two **+RW**

Use this command to split a title up into two new titles.

**1** On the Title List menu, select a title you want to divide then press **OK**.

The menu options appears on the left side of the screen.

**2** Select 'Divide' from the Title List menu options.

Play	
Full Play	
Chapter	
Delete	
Protect	Title Name
Edit	Divide
Dubbing	Hide

**3** Press **OK** when 'Divide' option is highlighted.

Title Edit-Divide menu appears and goes into STOP mode.

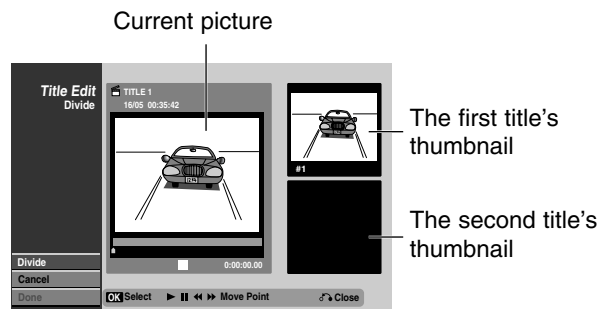

**4** Use pause step, search, skip and slow-motion to find the point you want to divide the title.

**5** When 'Divide' option is highlighted, press **OK** at the point.

You can clear the dividing point and exit the Title Edit-Divide menu, use **▲ / ▼** to select 'Cancel' option then press **OK**. The dividing point is clear.

**6** Choose 'Done' option then press **OK** to fix the dividing point.

The title is divided into two new titles. It take up to 4 minutes to divide.

## Additional Information

### Overwrite Recording **+RW**

To overwrite a new video recording to a previously recorded title, follow these steps. This feature is not available on DVD+R, which always record at the end of the Disc.

- 1 Select input source you want to record (channel, AV1-3, DV).
- 2 Press LIST/DISC MENU to display the Title List menu.

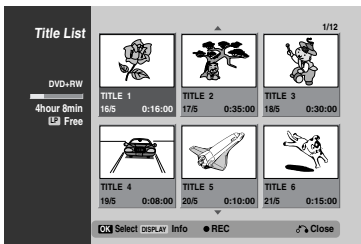

- 3 Use **▲ ▼ ◀ ▶** to choose a title you want to overwrite.
- 4 Press **RECORD (●)** to start overwrite recording. Overwrite recording is started from the start point of the title.
- 5 Press **STOP (■)** to stop the overwrite recording. The new title is created and updated menu is displayed.

#### **N**otes

- This function is not available with a protected title.
- If the overwriting is elapsed more than the recording length of the current title, the next title is overwritten. But if next title is protected, the overwriting is stopped at the starting point of the title.
- If the selected title's recording length is less than 10 seconds, the next title is overwritten. But if next title is protected, the overwriting is stopped.

### Viewing Title List menu displayed on other DVD recorders or players

**+RW** **+R**

You can view the Title List menu displayed on the another DVD player that is capable of playing DVD+RW or DVD+R discs.

- 1 Insert DVD+R or DVD+RW disc recorded already.
- 2 Press **TITLE** button. Title List menu will appear as below.

#### **T**ip

You can remove the Title List menu by pressing **STOP (■)**.

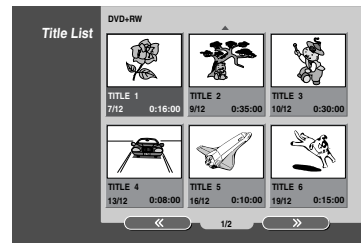

- 3 To play back a title, select the title you want then press **OK** or **▶** (**PLAY**).

### Playing Your Recordings on other DVD Players (Finalizing a Disc)

Check the manual that came with the other player to check what kinds of discs it will play.

Finalizing 'fixes' the recordings and editings in place so that the disc can be played on a regular DVD player or computer equipped with a suitable DVD-ROM drive. **To finalize a disc, refer to "Disc Finalize" on page 29.**

#### **N**otes

- Unfinalized DVD+RW is playable on regular DVD players.
- The edited contents of DVD+RW disc is compatible on regular DVD players only after finalizing.
- Any edited contents of the DVD+R disc are not be compatible on regular DVD players. (Hide, chapter combine, added chapter mark, etc.)



## Language Code List

Enter the appropriate code number for the initial settings "Disc Audio", "Disc Subtitle" and/or "Disc Menu" (See page 24).

Code	Language	Code	Language	Code	Language	Code	Language
6566	Abkhazian	7074	Fiji	7678	Lingala	8373	Singhalese
6565	Afar	7073	Finnish	7684	Lithuanian	8375	Slovak
6570	Afrikaans	7082	French	7775	Macedonian	8376	Slovenian
8381	Albanian	7089	Frisian	7771	Malagasy	8379	Somali
6577	Amharic	7176	Galician	7783	Malay	6983	Spanish
6582	Arabic	7565	Georgian	7776	Malayalam	8385	Sudanese
7289	Armenian	6869	German	7784	Maltese	8387	Swahili
6583	Assamese	6976	Greek	7773	Maori	8386	Swedish
6588	Aymara	7576	Greenlandic	7782	Marathi	8476	Tagalog
6590	Azerbaijani	7178	Guarani	7779	Moldavian	8471	Tajik
6665	Bashkir	7185	Gujarati	7778	Mongolian	8465	Tamil
6985	Basque	7265	Hausa	7865	Nauru	8484	Tatar
6678	Bengali; Bangla	7387	Hebrew	7869	Nepali	8469	Telugu
6890	Bhutani	7273	Hindi	7879	Norwegian	8472	Thai
6672	Bihari	7285	Hungarian	7982	Oriya	6679	Tibetan
6682	Breton	7383	Icelandic	8065	Panjabi	8473	Tigrinya
6671	Bulgarian	7378	Indonesian	8083	Pashto, Pushto	8479	Tonga
7789	Burmese	7365	Interlingua	7065	Persian	8482	Turkish
6669	Byelorussian	7165	Irish	8076	Polish	8475	Turkmen
7577	Cambodian	7384	Italian	8084	Portuguese	8487	Twi
6765	Catalan	7465	Japanese	8185	Quechua	8575	Ukrainian
9072	Chinese	7487	Javanese	8277	Rhaeto-Romance	8582	Urdu
6779	Corsican	7578	Kannada	8279	Romanian	8590	Uzbek
7282	Croatian	7583	Kashmiri	8285	Russian	8673	Vietnamese
6783	Czech	7575	Kazakh	8377	Samoan	8679	Volapük
6865	Danish	7589	Kirghiz	8365	Sanskrit	6789	Welsh
7876	Dutch	7579	Korean	7168	Scots Gaelic	8779	Wolof
6978	English	7585	Kurdish	8382	Serbian	8872	Xhosa
6979	Esperanto	7679	Laothian	8372	Serbo-Croatian	7473	Yiddish
6984	Estonian	7665	Latin	8378	Shona	8979	Yoruba
7079	Faeroese	7686	Latvian, Lettish	8368	Sindhi	9085	Zulu

## Area Code List

Enter the appropriate code number for the initial setting "Area Code" (See page 27).

Code	Country	Code	Country	Code	Country	Code	Country
AD	Andorra	ER	Eritrea	LC	Saint Lucia	SC	Seychelles
AE	United Arab Emirates	ES	Spain	LI	Liechtenstein	SD	Sudan
AF	Afghanistan	ET	Ethiopia	LK	Sri Lanka	SE	Sweden
AG	Antigua and Barbuda	FI	Finland	LR	Liberia	SG	Singapore
AI	Anguilla	FJ	Fiji	LS	Lesotho	SH	Saint Helena
AL	Albania	FK	Falkland Islands	LT	Lithuania	SI	Slovenia
AM	Armenia	FM	Micronesia	LU	Luxembourg	SJ	Svalbard and Jan Mayen Islands
AN	Netherlands Antilles	FO	Faroe Islands	LV	Latvia	SK	Slovak Republic
AO	Angola	FR	France	LY	Libya	SL	Sierra Leone
AQ	Antarctica	FX	France (European Territory)	MA	Morocco	SM	San Marino
AR	Argentina	GA	Gabon	MC	Monaco	SN	Senegal
AS	American Samoa	GB	Great Britain	MD	Moldavia	SO	Somalia
AT	Austria	GD	Grenada	MG	Madagascar	SR	Suriname
AU	Australia	GE	Georgia	MH	Marshall Islands	ST	Saint Tome and Principe
AW	Aruba	GF	French Guyana	MK	Macedonia	SU	Former USSR
AZ	Azerbaijan	GH	Ghana	ML	Mali	SV	El Salvador
BA	Bosnia-Herzegovina	GI	Gibraltar	MM	Myanmar	SY	Syria
BB	Barbados	GL	Greenland	MN	Mongolia	SZ	Swaziland
BD	Bangladesh	GM	Gambia	MO	Macau	TC	Turks and Caicos Islands
BE	Belgium	GN	Guinea	MP	Northern Mariana Islands	TD	Chad
BF	Burkina Faso	GP	Guadeloupe (French)	MQ	Martinique (French)	TF	French Southern Territories
BG	Bulgaria	GQ	Equatorial Guinea	MR	Mauritania	TG	Togo
BH	Bahrain	GR	Greece	MS	Montserrat	TH	Thailand
BI	Burundi	GS	S. Georgia & S. Sandwich Isls.	MT	Malta	TJ	Tadjikistan
BJ	Benin	GT	Guatemala	MU	Mauritius	TK	Tokelau
BM	Bermuda	GU	Guam (USA)	MV	Maldives	TM	Turkmenistan
BN	Brunei Darussalam	GW	Guinea Bissau	MW	Malawi	TN	Tunisia
BO	Bolivia	GY	Guyana	MX	Mexico	TO	Tonga
BR	Brazil	HK	Hong Kong	MY	Malaysia	TP	East Timor
BS	Bahamas	HM	Heard and McDonald Islands	MZ	Mozambique	TR	Turkey
BT	Bhutan	HN	Honduras	AN	Namibia	TT	Trinidad and Tobago
BV	Bouvet Island	HR	Croatia	NC	New Caledonia (French)	TV	Tuvalu
BW	Botswana	HT	Haiti	NE	Niger	TW	Taiwan
BY	Belarus	HU	Hungary	NF	Norfolk Island	TZ	Tanzania
BZ	Belize	ID	Indonesia	NG	Nigeria	UA	Ukraine
CA	Canada	IE	Ireland	NI	Nicaragua	UG	Uganda
CC	Cocos (Keeling) Islands	IL	Israel	NL	Netherlands	UK	United Kingdom
CF	Central African Republic	IN	India	NO	Norway	UM	USA Minor Outlying Islands
CG	Congo	IO	British Indian Ocean Territory	NP	Nepal	US	United States
CH	Switzerland	IQ	Iraq	NR	Nauru	UY	Uruguay
CI	Ivory Coast	IR	Iran	NZ	New Zealand	UZ	Uzbekistan
CK	Cook Islands	IS	Iceland	OM	Oman	VA	Vatican City State
CL	Chile	IT	Italy	PA	Panama	VC	Saint Vincent & Grenadines
CM	Cameroon	JM	Jamaica	PE	Peru	VE	Venezuela
CN	China	JO	Jordan	PF	Polynesia (French)	VG	Virgin Islands (British)
CO	Colombia	JP	Japan	PG	Papua New Guinea	VI	Virgin Islands (USA)
CR	Costa Rica	KE	Kenya	PH	Philippines	VN	Vietnam
CS	Former Czechoslovakia	KG	Kyrgyzstan	PK	Pakistan	VU	Vanuatu
CU	Cuba	KH	Cambodia	PL	Poland	WF	Wallis and Futuna Islands
CV	Cape Verde	KI	Kiribati	PM	Saint Pierre and Miquelon	WS	Samoa
CX	Christmas Island	KM	Comoros	PN	Pitcairn Island	YE	Yemen
CY	Cyprus	KN	Saint Kitts & Nevis Anguilla	PR	Puerto Rico	YT	Mayotte
CZ	Czech Republic	KP	North Korea	PT	Portugal	YU	Yugoslavia
DE	Germany	KR	South Korea	PW	Palau	ZA	South Africa
DJ	Djibouti	KW	Kuwait	PY	Paraguay	ZM	Zambia
DK	Denmark	KY	Cayman Islands	QA	Qatar	ZR	Zaire
DM	Dominica	KZ	Kazakhstan	RE	Reunion (French)	ZW	Zimbabwe
DO	Dominican Republic	LA	Laos	RO	Romania		
DZ	Algeria	LB	Lebanon	RU	Russian Federation		
EC	Ecuador			RW	Rwanda		
EE	Estonia			SA	Saudi Arabia		
EG	Egypt			SB	Solomon Islands		
EH	Western Sahara						

## Troubleshooting

Check the following guide for the possible cause of a problem before contacting service.

Symptom	Cause	Solution
No power.	<ul style="list-style-type: none"> <li>The power cord is disconnected.</li> </ul>	<ul style="list-style-type: none"> <li>Plug the power cord into the wall outlet securely.</li> </ul>
No picture.	<ul style="list-style-type: none"> <li>The TV is not set to receive Recorder signal output.</li> </ul>	<ul style="list-style-type: none"> <li>Select the appropriate video input mode on the TV so the picture from the DVD Recorder appears on the TV screen.</li> </ul>
	<ul style="list-style-type: none"> <li>The video cable is not connected securely.</li> </ul>	<ul style="list-style-type: none"> <li>Connect the video cable securely.</li> </ul>
	<ul style="list-style-type: none"> <li>The connected TV power is turned off.</li> </ul>	<ul style="list-style-type: none"> <li>Turn on the TV.</li> </ul>
No sound.	<ul style="list-style-type: none"> <li>The equipment connected with the audio cable is not set to receive Recorder signal output.</li> </ul>	<ul style="list-style-type: none"> <li>Select the correct input mode on the audio receiver so you can listen to the sound from the Recorder.</li> </ul>
	<ul style="list-style-type: none"> <li>The audio cables are not connected securely.</li> </ul>	<ul style="list-style-type: none"> <li>Connect the audio cable securely.</li> </ul>
	<ul style="list-style-type: none"> <li>The power of the equipment connected with the audio cable is turned off.</li> </ul>	<ul style="list-style-type: none"> <li>Turn on the equipment connected with the audio cable.</li> </ul>
	<ul style="list-style-type: none"> <li>The audio connecting cord is damaged.</li> </ul>	<ul style="list-style-type: none"> <li>Replace it with new one.</li> </ul>
The playback picture is poor.	<ul style="list-style-type: none"> <li>The disc is dirty.</li> </ul>	<ul style="list-style-type: none"> <li>Clean the disc.</li> </ul>
The Recorder does not start playback.	<ul style="list-style-type: none"> <li>No disc is inserted.</li> </ul>	<ul style="list-style-type: none"> <li>Insert a disc.</li> </ul>
	<ul style="list-style-type: none"> <li>An unplayable disc is inserted.</li> </ul>	<ul style="list-style-type: none"> <li>Insert a playable disc. (Check the disc type, color system, and regional code.)</li> </ul>
	<ul style="list-style-type: none"> <li>The disc is placed upside down.</li> </ul>	<ul style="list-style-type: none"> <li>Place the disc with the playback side down.</li> </ul>
	<ul style="list-style-type: none"> <li>The disc is not placed within the guide.</li> </ul>	<ul style="list-style-type: none"> <li>Place the disc on the disc tray correctly inside the guide.</li> </ul>
	<ul style="list-style-type: none"> <li>The disc is dirty.</li> </ul>	<ul style="list-style-type: none"> <li>Clean the disc.</li> </ul>
	<ul style="list-style-type: none"> <li>The Rating level is set.</li> </ul>	<ul style="list-style-type: none"> <li>Cancel the Rating function or change the rating level.</li> </ul>
The picture from the external input is distorted	<ul style="list-style-type: none"> <li>The video signal from the external component is copy-protected.</li> </ul>	<ul style="list-style-type: none"> <li>You cannot connect via this recorder. Connect the component directly to your TV.</li> </ul>
Some channels are skipped over when using ▲ / ▼.	<ul style="list-style-type: none"> <li>Those channels are not stored in the recorder.</li> </ul>	<ul style="list-style-type: none"> <li>Restore channels. See "Program Edit" on pages 21-22.</li> </ul>
The picture or sound of broadcasting channel is weak or missing.	<ul style="list-style-type: none"> <li>Aerial or cables are loose.</li> </ul>	<ul style="list-style-type: none"> <li>Tighten connections or replace cable.</li> </ul>
Camcorder image is not shown.	<ul style="list-style-type: none"> <li>Camcorder is off.</li> </ul>	<ul style="list-style-type: none"> <li>Turn camcorder on and operate properly.</li> </ul>
Camcorder image via A/V input or DV IN to Recorder is not shown on TV screen.	<ul style="list-style-type: none"> <li>Recorder INPUT SELECT is incorrect.</li> </ul>	<ul style="list-style-type: none"> <li>Use ▲ or ▼ to select input channel (AV1, AV2, AV3, DV, etc.)</li> </ul>

## Troubleshooting (Continued)

English

Symptom	Cause	Solution
Can't play a disc recorded using this recorder on another player.	• Some players will not play even a finalized disc recorded in Video mode.	• No solution.
	• Discs recorded with copy-once material cannot be played on other players.	• No solution.
Cannot record or did not record successfully.	• The remaining blank space on the disc is insufficient.	• Use another disc.
	• The source you are trying to record is copy protected.	• You cannot record the source.
	• When setting the recording channel, the channel is tuned on the TV's own tuner.	• Select the channel on the recorder's built-in TV tuner.
Timer recording is not possible.	• Clock in Recorder is not set to correct time.	• Set clock to correct time. See "Clock Set" on page 23.
	• Timer has been programmed incorrectly.	• Reprogram Timer. See "Timer Recording" on page 46-47.
	• Timer record indicator light does not appear after programming timer.	• Reprogram Timer.
	• The set is not in standby mode.	• Put the set to standby mode after Timer recording had been programmed.
Stereo Audio Record and/or Playback is not present.	• TV is not Stereo-compatible.	• No solution.
	• Broadcast program is not in stereo format.	• No solution.
	• Recorder A/V Out jacks are not connected to TV A/V In jacks.	• Make A/V connections. Stereo is available only via A/V output from Recorder.
	• Recorder Audio/Video Out is not selected for viewing at the TV.	• Select AUX or A/V source as TV input.
The remote control does not work properly.	• The remote control is not pointed at the remote sensor of the Recorder.	• Point the remote control at the remote sensor of the Recorder.
	• The remote control is too far from the Recorder.	• Operate the remote control within 7 m.
	• There is an obstacle in the path of the remote control and the Recorder.	• Remove the obstacle.
	• The batteries in the remote control are exhausted.	• Replace the batteries with new ones.

### Moisture Condensation

Moisture condensation can occur:	In locations where moisture condensation may occur:
<ul style="list-style-type: none"> <li>• When the Recorder is moved from a cold place to a warm place.</li> <li>• Under extremely humid conditions.</li> </ul>	<ul style="list-style-type: none"> <li>• Keep the Recorder plugged into an AC power outlet with POWER On. This will help prevent condensation.</li> <li>• When condensation has occurred, wait a few hours for the Recorder to dry before using it.</li> </ul>

# Specifications

## General

Power requirements	AC 220-230V, 50 Hz
Power consumption	35W
Dimensions (approx.)	430 X 78.5 X 354 mm (w x h x d)
Mass (approx.)	5.7 kg
Operating temperature	5°C to 35°C
Operating humidity	5 % to 90 %
Television system	PAL B/G, PAL I/I, SECAM D/K colour system
Recording format	PAL

## System

Laser	Semiconductor laser, wavelength 650 nm
Video head system	Double azimuth 4 heads, helical scanning
Signal system	PAL

## Recording

Recording format	DVD+RW/+R Video format
Recordable discs	DVD+ReWritable, DVD+Recordable, DVD+Recordable (Double Layer)
Recordable time	DVD (4.7GB) : Approx. 1 hour (XP mode), 2 hours (SP mode), 4 hours (LP mode), 6 hours (EP mode) DVD+R DL (8.5GB) : Approx. 1 hour 50 minutes (XP mode), 3 hours 40 minutes (SP mode), 7 hours 10 minutes (LP mode), 11 hours (EP mode)
<b>Video recording format</b>	
Sampling frequency	27MHz
Compression format	MPEG 2
<b>Audio recording format</b>	
Sampling frequency	48kHz
Compression format	Dolby Digital

## Playback

Frequency response	DVD (PCM 48 kHz): 8 Hz to 22 kHz, CD: 8 Hz to 20 kHz DVD (PCM 96 kHz): 8 Hz to 44 kHz
Signal-to-noise ratio	More than 100 dB (AUDIO OUT connector)
Harmonic distortion	Less than 0.008% (AUDIO OUT connector)
Dynamic range	More than 95 dB (AUDIO OUT connector)

## Inputs

AERIAL IN	Aerial input, 75 ohms
VIDEO IN	1.0 Vp-p 75 ohms, sync negative, RCA jack x 1 / SCART x 2
AUDIO IN	0 dBm more than 47 kohms, RCA jack (L, R) x 1 / SCART x 2
DV IN	4 pin (i.LINK/IEEE 1394 standard)
S-VIDEO IN	(Y) 1.0 V (p-p), 75 Ω, negative sync, Mini DIN 4-pin x 1 (C) 0.3 V (p-p) 75 Ω

## Outputs

S-VIDEO OUT	(Y) 1.0 V (p-p), 75 Ω, negative sync, Mini DIN 4-pin x 1 (C) 0.3 V (p-p) 75 Ω
COMPONENT VIDEO OUT	(Y) 1.0 V (p-p), 75 Ω, negative sync, RCA jack x 1 (Pb)/(Pr) 0.7 V (p-p), 75 Ω, RCA jack x 2
Audio output (digital audio)	0.5 V (p-p), 75 Ω, RCA jack x 1
Audio output (analog audio)	2.0 Vrms (1 KHz, 0 dB), 600 Ω, RCA jack (L, R) x 1 / SCART

- Design and specifications are subject to change without notice.
- Manufactured under license from Dolby Laboratories. "Dolby" and the double-D symbol are trademarks of Dolby Laboratories.

P/NO : 3834RV0032R

## Free Manuals Download Website

<http://myh66.com>

<http://usermanuals.us>

<http://www.somanuals.com>

<http://www.4manuals.cc>

<http://www.manual-lib.com>

<http://www.404manual.com>

<http://www.luxmanual.com>

<http://aubethermostatmanual.com>

Golf course search by state

<http://golfingnear.com>

Email search by domain

<http://emailbydomain.com>

Auto manuals search

<http://auto.somanuals.com>

TV manuals search

<http://tv.somanuals.com>