

CONTENTS

1. HOW TO CONNECT YOUR VIDEO RECORDER	4	Selecting the recording speed (SP or LP)	21
How to connect your video recorder to the TV set	4	Automatic recording from a satellite receiver (SAT RECORDING)	21
Connecting with a scart cable without	5	Switching on 'Direct Record'	22
Connecting without a scart cable	6		
Connecting a decoder or other equipment	6	7. PROGRAMMED RECORDING (TIMER)	23
2. INSTALLING YOUR VIDEO RECORDER	7	'VPS' (Video Programming System) and 'PDC' (Programme Delivery Control)	23
Initial installation	7	Programming a recording (with 'VIDEO Plus+')	23
Allocating a decoder	7	Programming a recording (without 'VIDEO Plus+')	24
Manual TV channel search	8	How to check or change a programmed recording (TIMER)	25
Satellite receiver	8	How to clear a programmed recording (TIMER)	26
Special installation functions	9	'NexTVView Link'	26
Automatic TV Channel Allocation	9	8. ADDITIONAL FUNCTIONS	27
Automatic TV channel search (Autoinstall)	10	Changing the TV system	27
Monitor function	10	Child lock	27
Sorting and clearing TV channels manually	10	Switching the 'on-screen display' (OSD) on or off	28
Setting the time and date	11	Switching to 16:9 wide screen picture	28
3. IMPORTANT NOTES FOR OPERATION	12	Switching the remote control command	29
General information	12	Continuous playback	29
Saving energy	12	Automatic switch-off (tuner mode)	30
Emergency interrupt	12	Reducing picture disturbance	31
The symbols on your video recorder display	12	Switching off the modulator	31
Summary of user guide	13	Using your video recorder remote control with your TV set	32
User guide (OSD)	13	Manual audio control	32
4. THE TAPE MANAGER (TM)	14	Recording audio only	32
Adding a cassette to the Tape Manager	14	Audio dubbing	33
Searching for a title	14	Selecting the sound track	33
Searching for a blank part of the tape	15	Synchronous editing (synchro-edit)	34
Editing the title	15	Connecting the video recorder and the camera recorder	34
Copying the Tape Manager memory	16	Starting synchro-edit	34
5. PLAYBACK FUNCTIONS	17	Variant 1, the video recorder is to control the camera recorder	35
Playing a cassette	17	Variant 2, the camera recorder is to control the video recorder	35
Playing NTSC cassettes	17	Setting the 'preroll time'	35
Tape position indication	17	9. Before you call an engineer	36
Searching for tape position with the picture (picture search)	17	10. GLOSSARY	37
Still picture/Slow motion	18	Technical terms used	37
The JOG/SHUTTLE functions on the video recorder	18		
Searching for tape position without the picture (wind and rewind)	18		
Instant View	18		
Automatic search for a tape position (index search)	18		
Selecting the picture setting	19		
Picture interference	19		
Cleaning the video heads	19		
6. MANUAL RECORDING	20		
Recording without automatic switch-off	20		
Recording with automatic switch-off (OTR one-touch-recording)	20		
Protecting your recordings	20		
Auto-assembling	20		



OPERATING INSTRUCTIONS IN BRIEF

The remote control

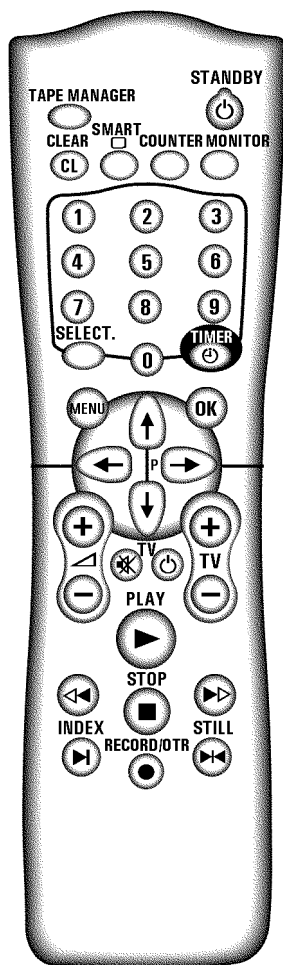

- TAPE MANAGER** **TapeManager**: To call up the Tape Manager
- STANDBY** **Switch off**: To switch off set, interrupt menu function, interrupt a programmed recording (TIMER), child lock on or off
- CLEAR (CL)** **Delete**: To delete last entry/Clear programmed recording (TIMER)
- SMART** **SMART**: To adjust the picture setting during playback
- COUNTER** **Counter**: To select the display of the tape position
- MONITOR** **TV monitor**: To switch between TV reception and VCR playback
- 0-9** **Number buttons**: 0 - 9
- SELECT** **Select**: To select a function
- TIMER** **TIMER**: To programme a TIMER or alter or clear a programmed TIMER
- MENU** **Menu**: To call up or end main menu
- OK** **Store/Confirm**: To store or confirm entry
- ←** **Select**: Cursor left
- **Select**: Cursor right

↑P **Select**: One line or programme number up

P↓ **Select**: One line or programme number down

PLAY▶ **Playback**: To play a cassette

◀◀ **Rewind**: During STOP and STANDBY: rewind, during PLAYBACK: reverse scanning

STOP■ **Pause/Stop**: To stop the tape, except during TIMER-recording

▶▶ **Forward wind**: During STOP and STANDBY: forward wind, during PLAYBACK: forward scanning

INDEX▶ **Index search**: In combination with **◀◀** / **▶▶**: to search for previous or next recording on the cassette.

RECORD/OTR● **Record**: To record the programme selected

STILL▶◀ **Still picture**: To stop the tape and show a still picture

Additional TV functions

▲+ **TV volume**: TV volume up

▲- **TV volume**: TV volume down

TV* **TV sound off**: To switch the sound on or off

TV⏻ **Switch off**: To switch off the TV

TV+ **TV Programme number**: TV programme number up

TV- **TV Programme number**: TV programme number down



Front of the set

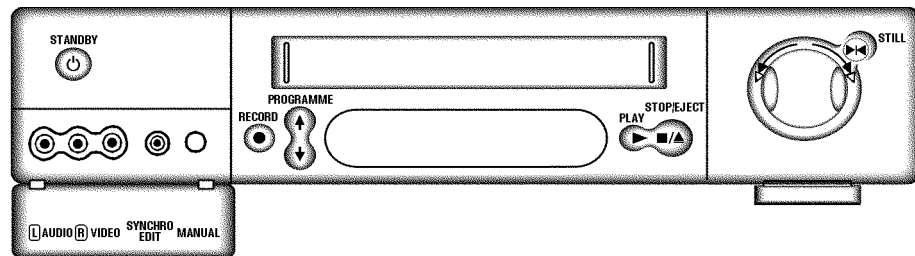

STANDBY **Standby** : To switch off, interrupt function, interrupt TIMER recording

RECORD **Record**: To record the programme selected at this moment

PROGRAMME **Programme number Plus**: Programme number up

PROGRAMME **Programme number Minus**: Programme number down

PLAY **Playback** : To play back a recorded cassette

STOP/EJECT **Pause/Stop**: To stop the tape, except during TIMER-recording

STILL **Still picture**: To stop the tape and display the actual position on the tape as a still picture

Rotary control: turn left: during STOP and STANDBY: rewind, during PLAYBACK: reverse scanning
turn right: during STOP and STANDBY: wind, during PLAYBACK: forward scanning

Behind the flap at the lefthand corner on the front:

AUDIO R **Audio input socket left/right**: To connect a camera recorder or video recorder (programme number 'E3')

VIDEO **Video input socket** : To connect a camera recorder or video recorder ('E3')

SYNCHRO EDIT **EDIT input socket** : To connect a suitable camera recorder

MANUAL **Manual sound control** : To switch between automatic sound control and manual sound control

Back of the set

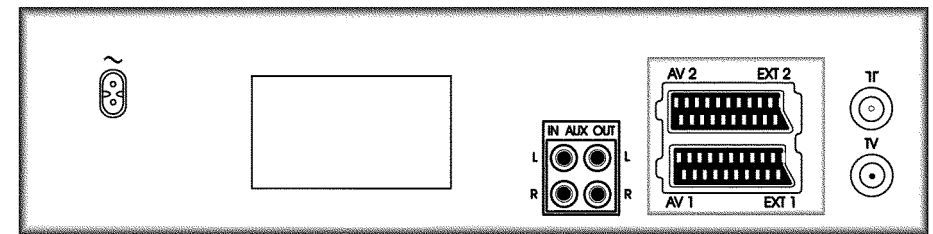

Mains socket: To connect the mains cable

AUX IN L R **Audio input socket, left/right** : To connect a HiFi-set (programme number 'AUX')

AUX OUT L R **Audio output socket, left/right** : To connect a HiFi-set

EXT.2 AV 2 **Scart socket 2**: To connect a satellite receiver, decoder, video recorder, etc. (programme number 'E2')

EXT.1 AV 1 **Scart socket 1**: To connect the TV set (programme number 'E1')

Aerial input socket: To connect the aerial cable

Aerial output socket: To connect the TV set

OPERATING INSTRUCTIONS PHILIPS VR860/07

Congratulations! You now own one of the most sophisticated and simple-to-use video recorders (VCR) on the market. With this VCR you can record and play VHS-standard cassettes.



Please take the time to read this operating manual before using your video recorder.











So that you can identify your machine in the event of theft, enter the serial number (PROD.NO) here. The serial number is printed on the type plate fixed at the rear of the set.

MODEL NO. VR860/07

PROD.NO:

This product complies with the requirements of the Directive 73/23/EEC + 89/336/EEC + 93/68/EEC.

Safety instructions and other notes

-  **Danger: High voltage!**
Do not remove the top cover as there is a risk of an electrical shock!
-  The video recorder does not contain any components that can be repaired by the customer. When the appliance is connected to the power supply there are some components that are constantly operational. To switch off the video recorder completely you must disconnect it from the power supply.
-  Make sure that air can circulate freely through the ventilation slots on the video recorder.
-  Make sure that no objects or liquids enter the video recorder. If liquid is spilt into it, disconnect the video recorder immediately from the power supply and call the After-sales Service for advice.
-  The video recorder should **not be used immediately after transportation** from a cold to a hot area or vice versa, or in conditions of extreme humidity.
After unpacking the video recorder, it should be allowed to **acclimatize for at least three hours** before installation.
-  These operating instructions have been printed on nonpolluting paper.
-  Deposit old batteries at the relevant collection points.
-  Please make use of the facilities available in your country for disposing of the packaging of the video recorder in a way that helps to protect the environment.
-  This electronic equipment contains many materials that can be recycled. Please inquire about the possibilities for recycling your old set.
-  VIDEO Plus+ and PlusCode are registered trademarks of Gemstar Development Corporation. The VIDEO Plus+ system is manufactured under licence from Gemstar Development Corporation.

Technical information

- Measurements in cm (W / H / D):** 43.5 / 9.3 / 29.0
- Power consumption (Standby) :** less than 4W (Saving energy mode)
- Voltage :** 220-240V/50Hz
- Number of heads :** 4 Video / 2 Audio
- Winding time:** approx. 90 seconds (Cassette E-180)
- Recording/Playback time :** SP (Standard Play) 4 hours (Cassette E-240) / LP (Long Play) 8 hours (Cassette E-240)

Interference

The Department of Trade and Industry operates a Radio Investigation Service to help TV licence holders improve reception of BBC and ITC programmes where these are being spoilt by interference.
If your dealer cannot help, ask at a Main Post Office for the booklet 'How to Improve Television and Radio Reception'.

List of accessories

- Operating instructions
- Remote control and batteries
- Aerial cable
- Mains cable
- Quick install guide
- Scart cable (AV-Euro cable)



Special functions on your video recorder

Crystal Clear Video

This system ensures that your picture will be of the best possible quality. This is made possible by a combination of Philips' very latest technologies: Natural Colour, Smart Picture, Digital Studio Picture Control and laser-cut video heads.

Natural Colour Digital Studio Picture Control

Natural Colour produces detailed pictures in clear colours.

Philips has developed a system which produces the best possible playback quality. It reduces disturbance on old, worn video cassettes, and emphasises the detail on very good quality cassettes.

Smart Picture

This function allows you to save the playback settings that suit you best. Select your own personal settings for the type of film you are currently watching.

TAPE MANAGER

By pressing the button once you obtain both simply and conveniently an overview of your entire video archive. You never need to search again because the tape manager stores all recordings and knows on which cassette they are located.

easy LINK

Philips provides the best possible connection between your video recorder and other home cinema equipment.

Plug & Play

When you connect your video recorder to your television and plug it into the mains, you will be welcomed with an OSD picture. All you have to do is follow the instructions in the "intelligent help line" for the next step. Enjoy the Automatic TV channel search/save function and the automatic time adjustment.

Multibrand TV control

You can operate the main functions on your television using your video recorder remote control, even if your television is not a Philips one.



We guarantee that your video recorder will switch to the new millennium with no problems whatsoever.

Automatic Satellite Recording

Recordings made on your video recorder can be controlled by an external satellite receiver.

Follow TV

This function automatically transfers all the television channel settings onto your video recorder.

Direct Record

Your video recorder can ascertain which channel is currently playing on your television and record from it at the touch of a button.

VIDEO *Plus*⁺

Simple programming system for video recorders. Makes programming as easy as making a telephone call. Simply enter the programme code which you will find in your listings magazine.

TURBO DRIVE

The precision tape drive from Philips with short rewind times and automatic tape length recognition.

1. HOW TO CONNECT YOUR VIDEO RECORDER

Important for the United Kingdom

This machine is fitted with an approved moulded 13 Amp plug. To change a fuse in this type of plug, please follow these instructions.

- 1 Take off the fuse cover and take out the fuse.
- 2 Put in a new fuse which should be a BS1362 3A, A.S.T.A. or BSI approved type.
- 3 Refit the fuse cover.

If the plug fitted is not suitable for your socket, cut it off and fit another type.

If the plug you fit contains a fuse, it should be a 3Amp fuse. If you fit a plug which does not need a fuse, make sure the fuse on your fuse box is not greater than 5 Amps.

 Note: Please destroy the plug you have cut off so that it cannot be used in a 13 Amp socket somewhere else.

How to connect a plug

The wires in the lead from the video recorder are coloured as follows.

- * Blue - 'neutral' ('N').
- * Brown - 'live' ('L').

- 4 Connect the blue wire to the terminal in the plug which is marked with the letter 'N' or coloured black.
- 5 Connect the brown wire to the terminal in the plug which is marked with the letter 'L' or coloured red.
- 6 Do not connect either of the wires to the terminal in the plug which is marked with the letter 'E', the symbol \perp or coloured green or green and yellow.

Before you refit the plug cover, make sure that the grip at the bottom of the plug is clamped over the plastic cover of the lead, not just over the two wires.

How to connect your video recorder to the TV set

We recommend the use of a scart cable. This will give you the best picture and sound quality.

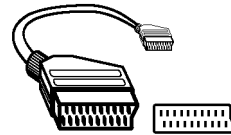

When you install your video recorder for the first time, please read:



- The section 'Connecting with scart cable and Easy Link/NexTView', when your TV set is equipped with 'Easy Link/NexTView'.
- The section 'Connecting with scart cable without Easy Link/NexTView', when your TV set is not equipped with 'Easy Link/NexTView'.
- The section 'Connecting without a scart cable', if you are not using a scart cable.

Connecting with scart cable and 'Easy link/NexTView'



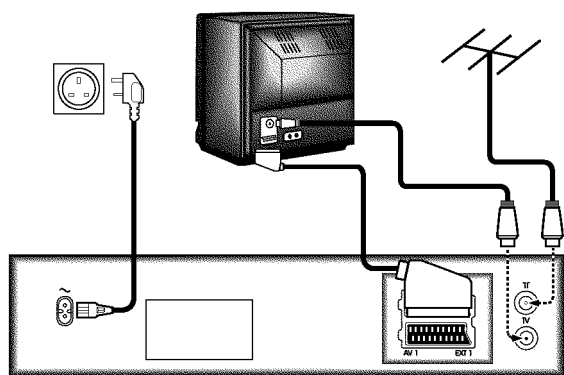



With the function 'Easy Link/NexTView', your video recorder can exchange information with the television (see instruction manual TV set.). With 'Easy Link/NexTView' the TV channels from the TV will automatically be loaded.

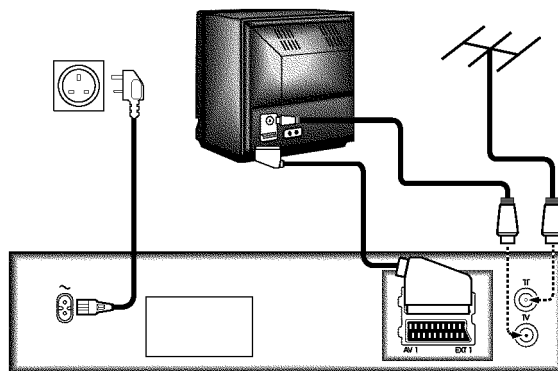

- 1 Switch off the TV set.
- 2 Remove the aerial cable plug from your TV set and insert it into the  socket at the back of the video recorder.
- 3 Plug one end of the aerial cable provided into the  socket on the video recorder and the other end into the aerial input socket on your TV set.
- 4 Plug one end of the special scart cable provided into the **EXT.1 AV.1** scart socket at the back of the video recorder and the other end into the scart socket on your TV set (see instruction manual TV set).
- 5 Switch on the TV set.
- 6 Insert one end of the mains cable into the mains socket  at the back of the video recorder and the other end into the wall socket.
- 7 The video recorder will automatically load all TV channels stored on your TV, in the same sequence. This may take several minutes. When all information has been copied, the following text will appear on the TV screen: 'EASY LINK LOADING COMPLETE'.
- 8 Check if time and date are correct. Read the section 'Setting Time/Date' in the chapter 'INSTALLING YOUR VIDEO RECORDER'.

Connecting with a scart cable without 'Easy Link/NexTView'



- 1 Switch off the TV set.
- 2 Remove the aerial cable plug from your TV set and insert it into the  socket at the back of the video recorder.
- 3 Plug one end of the aerial cable provided into the  socket on the video recorder and the other end into the aerial input socket on your TV set.
- 4 Plug one end of the scart cable into the **EXT.1 AV.1** scart socket at the back of the video recorder and the other end into the scart socket on your TV set (see instruction manual TV set).
- 5 Switch on the TV set.
- 6 Insert one end of the mains cable into the mains socket  at the back of the video recorder and the other end into the wall socket.
- 7 If your TV set **automatically switches** to programme number e.g.: 'EXT', '0', or 'AV', this text will appear on the TV screen:

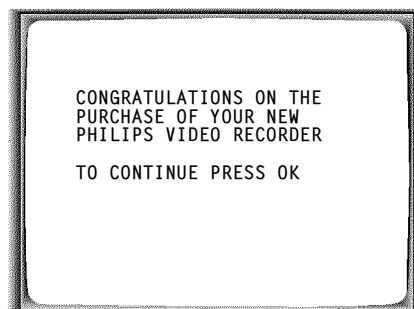

i If your TV set does not switch to programme number e.g.: 'EXT', '0', or 'AV' automatically, select the programme number for the video recorder manually (see instruction manual TV set).

8 Then read 'Initial installation' in chapter 'INSTALLING YOUR VIDEO RECORDER'.

Connecting without a scart cable

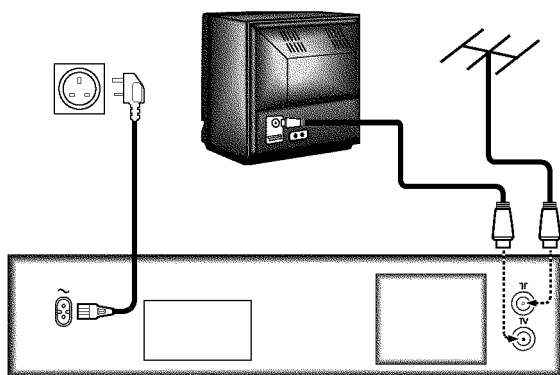

- 1** Switch off the TV set.
- 2** Remove the aerial cable plug from your TV set and insert it into the **TV** socket at the back of the video recorder.
- 3** Plug one end of the aerial cable provided into the **TV** socket on the video recorder and the other end into the aerial input socket on your TV set.
- 4** Insert one end of the mains cable into the mains socket  at the back of the video recorder and plug the other end into the wall socket.
- 5** Switch on your TV set and select the programme number that you have chosen for video playback (see instruction manual TV set).
- 6** Tune in the TV set until this picture appears.

i The video recorder will now be sending a welcoming text on channel 35 or 583MHz:

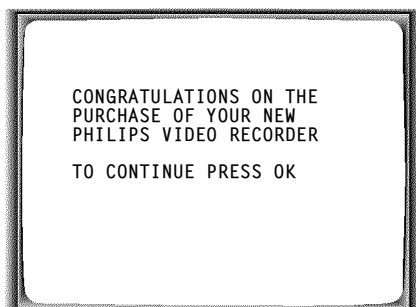

7 When the TV has been tuned read the paragraph 'Initial installation' in the chapter 'INSTALLING YOUR VIDEO RECORDER'.

Connecting a decoder or other equipment

You can connect additional equipment to the **EXT.2 AV 2** socket. For example: a decoder, a satellite receiver or a camera recorder.

You can connect a HIFI-stereo set to the sockets **AUX OUT L R** (audio output left/right) and **AUX IN L R** (audio input left/right).

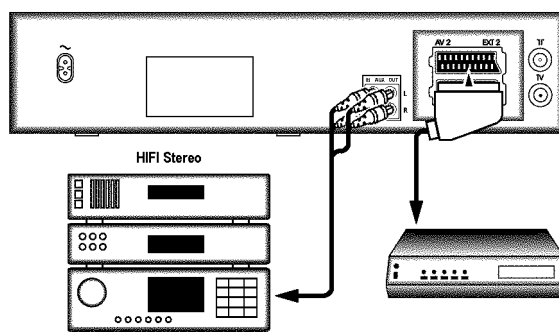

2. INSTALLING YOUR VIDEO RECORDER

Initial installation

- 1 Open up the battery compartment of your remote control and place the batteries in it as shown in the picture.

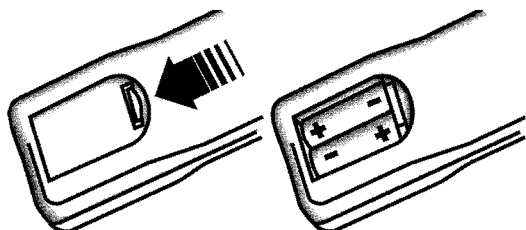

- 2 Close the battery compartment.
- 3 Confirm the picture on the TV screen with the **OK** button on the remote control.
- 4 If you have connected the aerial to the video recorder, press the **OK** button. 'Autoinstall' starts. This picture will appear on the screen:



Wait until all TV channels have been found. This can take several minutes.

- 5 When 'AUTOINSTALL' is complete, 'AUTOINSTALL COMPLETE' will appear on the TV screen.
 - ▶ If the autoinstall procedure is interrupted, please read 'Automatic TV channel search (Autoinstall)' in the chapter 'INSTALLING YOUR VIDEO RECORDER' to start autoinstall again.
- 6 To end, press the **MENU** button. The initial installation is now complete. Check the time and date. Please read 'Setting the time and date' in this chapter.
 - ▶ If you have connected a decoder, you must install it as described in the next section.
 - ▶ If you have connected a satellite receiver, please read the section 'satellite receiver'.

Allocating a decoder

Some TV stations will send coded TV channels, that you can only watch when you use a decoder. You can connect such a decoder (descrambler) to your video recorder. With the following function, the connected decoder will automatically be activated for the TV programme you want to watch.

- ▶ With 'Connecting with scart cable and 'Easy Link/NexTView' the decoder must be activated for the TV set.

- 1 Switch on the TV set. If required, select the programme number for the video recorder.
- 2 Choose the television channel on which you wish to use the decoder with the **↑P** or **P↓** buttons on the video recorder or the number buttons **0-9** on the remote control.
- 3 Press the **MENU** button on the remote control. The main menu will appear.
- 4 Select the line 'INSTALLATION' with the **P↓** or **↑P** button and confirm with the **→** button.
- 5 Select the line 'MANUAL SEARCH' with the **P↓** or **↑P** button and confirm with the **→** button.
- 6 Select the line 'DECODER' with the **P↓** or **↑P** button.

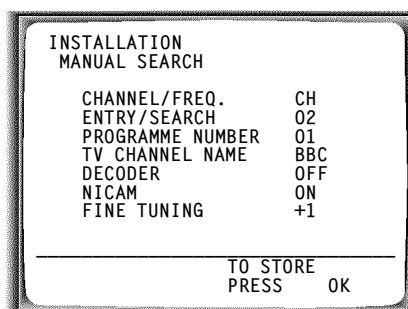

- 7 Select function 'ON' with the **←** or **→** button. When you select 'OFF', the function will be switched off.
- 8 Confirm with the **OK** button.
- 9 To end, press the **MENU** button. Your decoder has now been allocated to this TV channel.
 - ▶ When the function is switched on, 'DEC' appears in the display.

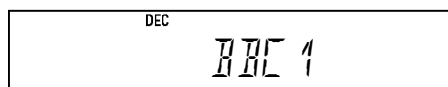

Manual TV channel search

In certain cases the 'Automatic TV channel search' may not be able to find all of the TV channels (e.g. coded TV channels). In that case, use this manual method to set the channels.

i With 'Connecting with scart cable and 'Easy Link/NexTVView' the videorecorder automatically takes the TV channels from the TV set. This is why some lines are not functional.

- 1** Switch on the TV set. If required, select the programme number for the video recorder.
- 2** Press the **[MENU]** button. The main menu appears.
- 3** Select the line 'INSTALLATION' with the **[P↓]** or **[↑P]** button and confirm with the **[→]** button.
- 4** Select the line 'MANUAL SEARCH' with the **[P↓]** or **[↑P]** button and confirm with the **[→]** button.

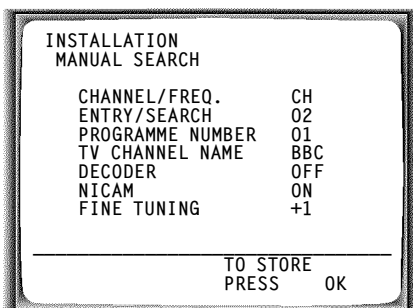

- 5** In the line 'CHANNEL/FREQ.', select the display for:
'FREQ.': frequency
'CH': channel
'S-CH': special channel
- 6** If you know the frequency or channel of the desired TV channel, you can enter the data in line 'ENTRY/SEARCH' with the digit buttons **[0-9]**.
i If you don't know the frequency or channel of the TV channel of your choice, press the **[→]** button to start the channel search.
- 7** In the line 'PROGRAMME NUMBER' select the programme number you want e.g.: '01' with the **[←]** or **[→]** button.
- 8** If you want to change the TV channel name, press the **[→]** button in line 'TV CHANNEL NAME'.

- 9** Select the character you want to change with the **[←]** or the **[→]** button. Change the character with the **[P↓]** or the **[↑P]** button. Select the next character in the same way.
- 10** Keep pressing the **[→]** button until the cursor disappears.
- 9** In the line 'NICAM', select function 'ON' or 'OFF' with the **[→]** or **[←]** button.
- 10** If you want to change the automatic tv channel setting, select the line 'FINE TUNING'.
With the **[←]** or **[→]** button you can vary the automatic tv channel setting. **Important:** This re-tuning is only necessary and useful in **special cases**, e.g.: when there are stripes on the picture with cable-TV systems.
- 11** Press the **[OK]** button to store the TV channel.
i If you want to search for further TV channels, start again at step **6**.
- 12** To end, press the **[MENU]** button.

Satellite receiver

You can receive channels from the satellite receiver via the scart socket **[EXT.2 AV 2]**.



To do this, select the channel number 'E2' by pressing the buttons **[↑P]** or **[P↓]**. You will have to select the channels to be received by the satellite receiver on the receiver itself.

Special installation functions

You can select one of the following installation functions in order to adapt the video recorder to your own specific requirements.

Automatic TV Channel Allocation (FOLLOW TV)

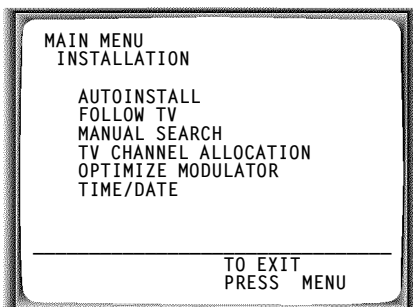

With this function the video recorder maintains the same channel sequence as on the TV set, in case you connected your videorecorder to a TV set **without scart cable**. This only functions if the video recorder (socket **EXT.1 AV 1**) and the TV set are **connected with a scart cable**.

-  Additional equipment connected to socket **EXT.2 AV 2** must be **switched off**.
 -  With 'Connecting with scart cable and 'Easy Link/NexTView', this function will start the data transfer.
- 1** Switch on the TV set. If required, select the programme number for the video recorder.
 - 2** Press the **[MENU]** button. The main menu appears.
 - 3** Select the line 'INSTALLATION' with the **[P↓]** or **[↑P]** button and confirm with the **[→]** button.

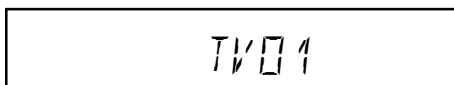

- 4** Select the line 'FOLLOW TV' with the **[P↓]** or **[↑P]** button and confirm with the **[→]** button. Take notice of the message on the TV screen.
- 5** Press the **[OK]** button. 'TV01' appears in the video recorder display.



- 6** Select programme number '1' on the TV set.
- 7** Confirm with the **[OK]** button on the video recorder-remote control. The video recorder compares the TV channels on the TV set and the video recorder. If the video recorder found the same TV channel as the TV set, then it stores it at 'P01'.
 -  When 'NOTV' (no signal from TV set) appears in the display, the TV channels can not be allocated automatically. In this case, read paragraph: 'Manual TV channel allocation'.
- 8** Wait until e.g.: 'TV02' appears.
- 9** Select the next programme number, e.g.: '2' on the TV set.
- 10** Confirm with the **[OK]** button on the video recorder-remote control.
 -  If you have allocated the wrong TV channel, you can go back one step with the **[←]** button.
- 11** Repeat steps **8** to **10** until all TV channels have been allocated.
- 12** To end, press the **[MENU]** button.

Automatic TV channel search (Autoinstall)

The video recorder will search for all TV channels. It stores TV channels found in the following sequence: BBC 1, BBC 2, ITV, CH 4, CH 5, SKY, others.

If you want to start the automatic TV channel search again, then follow the instructions below.

- 1 Switch on the TV set. If required, select the programme number for the video recorder.
- 2 Press the **MENU** button on the remote control. The main menu will appear.
- 3 Select the line 'INSTALLATION' with the **P↓** or **↑P** button and confirm with the **→** button.
- 4 Select the line 'AUTOINSTALL' with the **P↓** or **↑P** button.
- 5 Press the **→** button. The 'Automatic TV channel search' starts.

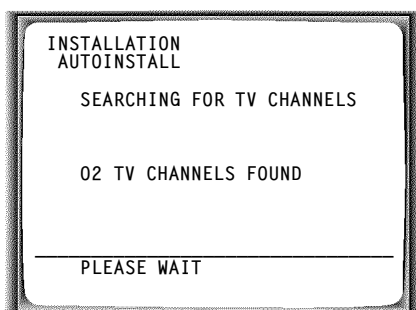

- 6 When Autoinstall is complete, 'AUTOINSTALL COMPLETE' will appear on the display.
- 7 The time and date information have been set.

How to search for a TV channel manually, you can read in the section 'Manual TV channel search'.

Monitor function

You can switch backwards and forwards between TV picture and video recorder picture with the **MONITOR** button. But this only works when you use a scart cable to connect the video recorder to your TV set and if your TV set responds to this switch-over.

Sorting and clearing TV channels manually

You can assign any programme number to a TV channel that you have stored and you can also delete unwanted TV channels.

i With 'Connecting with Easy Link/NexTVView' the video recorder automatically loads the TV channels from the TV set. That is why you cannot select this manual function.

- 1 Switch on the TV set. If required, select the programme number for the video recorder.
- 2 Press the **MENU** button. The main menu appears.
- 3 Select the line 'INSTALLATION' with the **P↓** or **↑P** button and confirm with the **→** button.
- 4 Select the line 'TV CHANNEL ALLOCATION' with the **P↓** or **↑P** button and confirm with the **→** button.

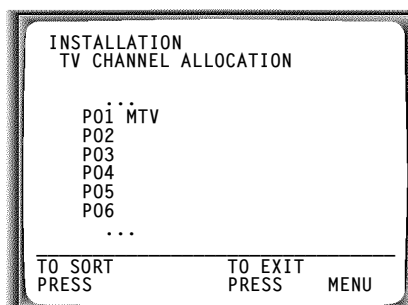

- 5 With the **P↓** or **↑P** button, select the TV channel to which you want to allocate a programme number (starting with 'P01').
- 6 To confirm, press the **→** button.
i If you want to delete a TV channel, press the **CLEAR (CL)** button.
- 7 With the **P↓** or **↑P** button, shift the TV channel to the programme number you wish to allocate to this TV channel and press the **←** button. The video recorder will add the TV channel.
- 8 Repeat steps **5** to **7** until you have allocated a programme number to all TV channels.
- 9 To store, press the **OK** button.
- 10 To end, press the **MENU** button.

Setting the time and date

If a TV channel which transmits TXT/PDC is stored under programme number 'P01', time and date will automatically be taken from the TXT/PDC information.

If the time in the video recorder display is not correct or if '-- : --' appears in the display, please set the clock manually.



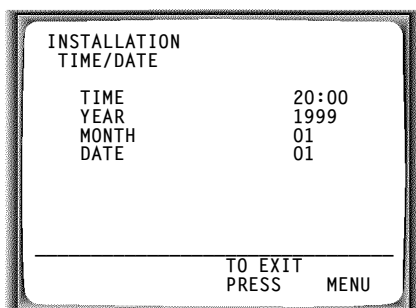

- 1** Switch on the TV set. If required, select the programme number for the video recorder.
- 2** Press the **MENU** button on the remote control. The main menu will appear.
- 3** Select the line 'INSTALLATION' with the **P↓** or **↑P** button and confirm with the **→** button.
- 4** Select the line 'TIME/DATE' with the **P↓** or **↑P** button and confirm with the **→** button.



- 5** Check the time in line 'TIME'. If required, please change the time with the **0-9** buttons on the remote control.
- 6** Check 'YEAR', 'MONTH' and 'DATE' in the same way. Switch between the fields with the **P↓** or **↑P** button.
- 7** Confirm the new information with the **OK** button.
- 8** To end, press the **MENU** button.

3. IMPORTANT NOTES FOR OPERATION

General information

-  You can switch on with the **STOP** button, the **0-9** buttons or by putting in a cassette.
-  If you do not use the video recorder for a few minutes, it will switch to standby automatically. Please read the section 'Automatic switch-off' in chapter ADDITIONAL FUNCTIONS.
-  If you have switched the video recorder off with the **STANDBY** button, the time will show in the display, for instance, '18:00'. If the clock has not been set, '---:--' will appear.
-  Keep your video recorder connected to the mains at all times to ensure that programmed recordings can be made and that the television works normally.
-  If the video recorder is not plugged into the mains, it will usually store TV channels and timer information for a year, and date information for seven hours.

Saving energy

There are two ways to switch to standby.

Switching to standby with clock display: Switch to standby using the **STANDBY** button. The time will be displayed.

To save energy: Press the **STANDBY** button twice. The time will disappear from the display.

Emergency interrupt

You can use the **STANDBY** button on the video recorder or the remote control to interrupt any function.











So if you are having operating problems, you can just interrupt the function and start again.

And you can practise operating your set without any worries. No matter which buttons you press, you cannot damage it.

The symbols on your video recorder display



These symbols can light up on your video recorder display:

- VPS/PDC** Video programming system / programme delivery control: when a VPS or PDC code is being transmitted.

-  This is where the current operating mode is shown as a symbol.
-  When you are recording a programme.
-  When you have programmed a recording or when a programmed recording is being made.
- LP** When you play a tape that has been recorded in LP (Long Play).

-  When you have put a cassette in the video recorder.
-  When you have switched on the child lock.
-  When a satellite recording has been programmed.
- DEC** When a decoder has been allocated to the TV channel you have currently selected.

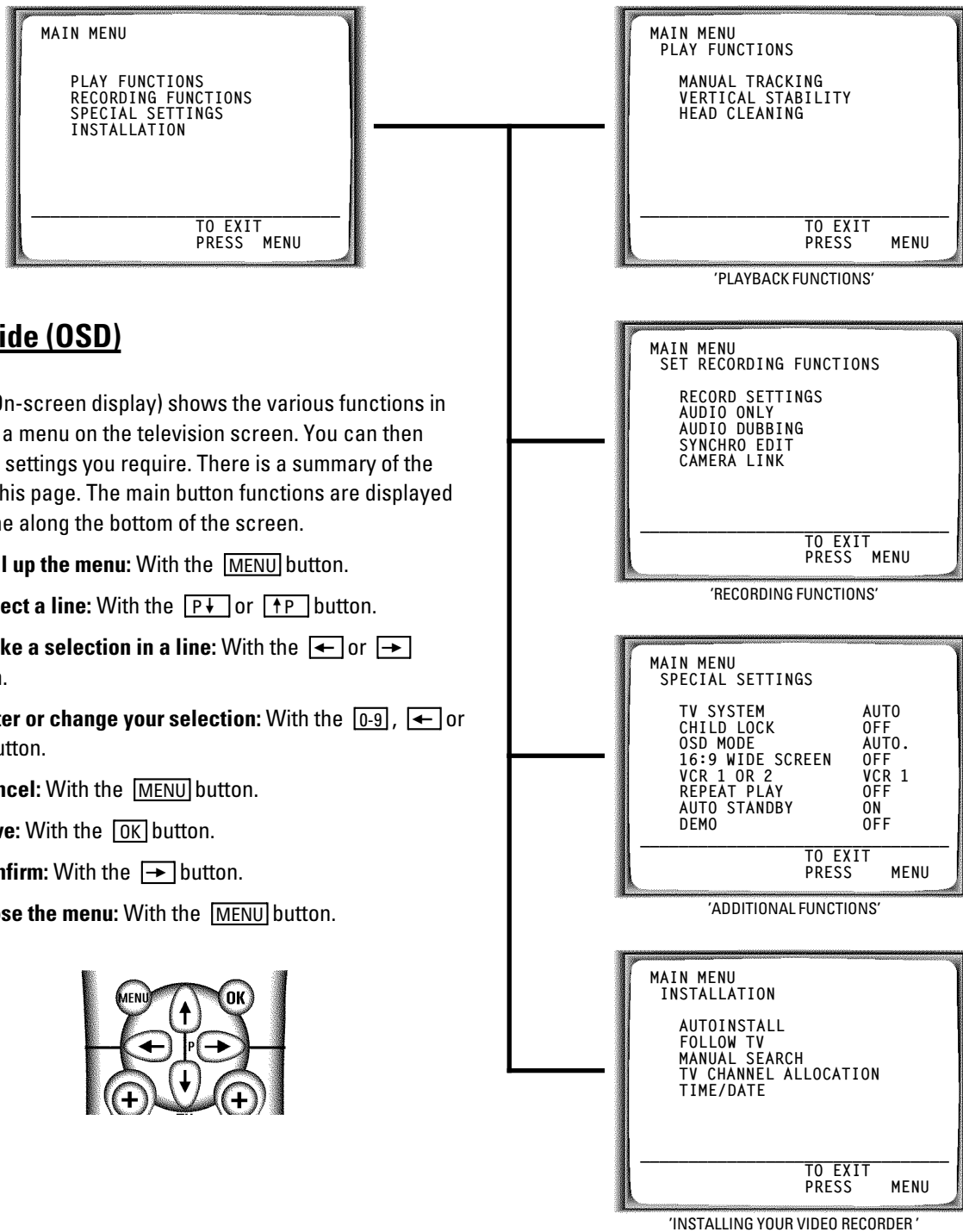
- h** Display of programme number / tape position / channel name / function.
- m** Tape position in hours.
- s** Tape position in minutes.
- HiFi** Tape position in seconds, but only if the display mode 'COUNTER' has been selected.
- NICAM** When you play a cassette that has been recorded with hifi sound, or when a hifi sound is transmitted.
- L R** When the video recorder recognizes a Nicam audio signal.
-  This shows the sound track you have selected.
-  This shows the audio control (L-left channel/R-right channel).

Summary of user guide

The OSD menu offers the following functions. More details on each can be found in the appropriate chapter.



User guide (OSD)

The OSD (On-screen display) shows the various functions in the form of a menu on the television screen. You can then choose the settings you require. There is a summary of the menus on this page. The main button functions are displayed in a help line along the bottom of the screen.

- To call up the menu:** With the **MENU** button.
- To select a line:** With the **P↓** or **↑P** button.
- To make a selection in a line:** With the **←** or **→** button.
- To enter or change your selection:** With the **0-9**, **←** or **→** button.
- To cancel:** With the **MENU** button.
- To save:** With the **OK** button.
- To confirm:** With the **→** button.
- To close the menu:** With the **MENU** button.

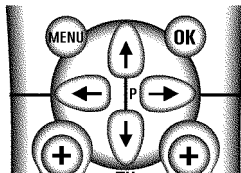

4. THE TAPE MANAGER (TM)

With the tape manager (TM) you have a complete overview of all recordings made with this video recorder. Moreover, with the tape manager (TM) you have fast and simple access to every **recording made** with this video recorder.

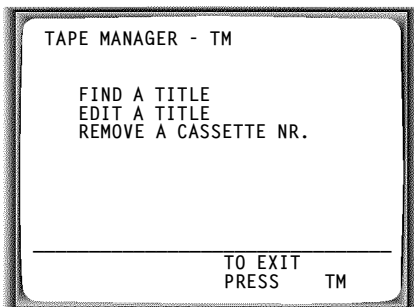

We recommend reading the section entitled 'Adding a cassette to the Tape Manager' so as to keep your preparations to a minimum.

- ▶ Don't use a Tape Manager cassette for recording on other video recorders.

Adding a cassette to the Tape Manager

Only new (blank) cassettes can be added to the Tape Manager. A cassette that has been recorded on can not be added to the Tape Manager.

- ▶ With this video recorder however, new recordings can be made as often as you wish on a cassette added to the tape manager. The titles of these recordings are stored automatically in the tape manager.

- 1 Switch the television on. Select the channel number for the video recorder if necessary.
- 2 Insert a new, blank cassette in the video recorder. The video recorder will briefly check the cassette inserted. 'CHECKING CASSETTE' will appear on the screen. If the cassette is new (blank), will appear on the screen:

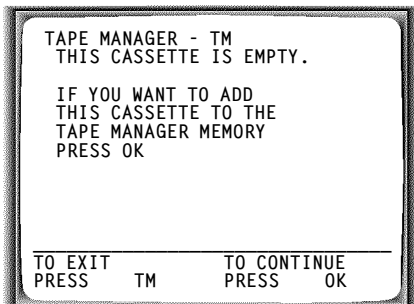

- ▶ If the cassette has already been registered in the Tape Manager, the cassette number and all the titles stored on this cassette will appear on the screen.

- ▶ If you put a cassette into the machine that has been recorded on, but has not been registered in the Tape Manager, no information will appear on the screen.

- 3 Confirm with the **OK** button.
- 4 The cassette number will be added to the Tape Manager:

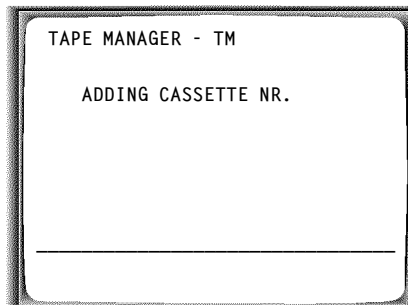

The cassette number will now be displayed and the cassette will be ejected automatically.

- 5 The cassette is now stored in the tape manager under the displayed cassette number. Write the cassette number that is shown on the screen on your cassette.

- ▶ You can store up to 150 cassettes. You can store a maximum number of 210 titles in the Tape Manager.

Searching for a title

You can easily search for the title of a recording stored in the Tape Manager. When the video recorder finds the title, playback will start automatically at the beginning of the recording searched for.

- 1 Press the **TAPE MANAGER** button on the remote control.
- 2 Select the line 'FIND A TITLE'.
- 3 Confirm with the **→** button.

- ▶ If you have inserted a cassette that is not stored in the Tape Manager you can choose between the 'THIS CASSETTE' or 'TM-MEMORY' lines by pressing the **P↓** button.

- ▶ If you confirm 'THIS CASSETTE' with the **→** button, the video recorder will check the cassette inserted. This can take some time. A list of all recordings on this cassette will appear on the screen. Continue at step **5**.

- ▶ If you confirm 'TM-MEMORY' with the **→** button, continue at the next step.

- 4 Using the **→** or **←** button, you can easily see the contents of the various cassettes in line 'CASSETTE NUMBER'.

- i** A list of the titles on the selected cassette will be displayed on the screen.

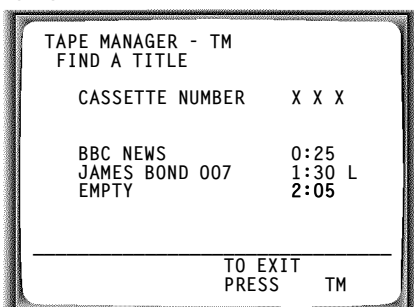

i **Explanation:**

XXX = cassette number
 BBC NEWS = title
 0:25 = Length of the recording
 L = Long Play recording

- Press the **↑P** or **↓P** button to select the title you require.

- Confirm with the **OK** button.

- i** If the cassette is not in the video recorder, for example, 'INSERT CASSETTE NUMBER XXX' will appear on the screen. Insert the corresponding cassette into the video recorder.

- The video recorder will search for the desired title and will start playback automatically.

Searching for a blank part of the tape

To make a recording, you can search for a blank part of the tape (at least 1 minute of blank tape), for example, after an existing recording on the tape.

This only works with cassettes with cassettes which have been stored in the Tape Manager.

- Press the **TAPE MANAGER** button on the remote control.

- Select the line 'FIND A TITLE' with the **↑P** or **↓P** button. 'FIND A TITLE'

- Confirm with the **→** button.

- i** If you have put a cassette in the machine which is not registered in the Tape Manager, select the line 'TM-MEMORY' with the **↓P** button.

- In the line 'CASSETTE NUMBER' you can select a different cassette number with the **→** or **←** button.

- i** A list of the titles on the selected cassette will be displayed on the screen.

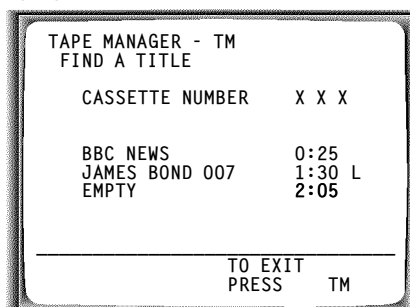

- Select the title 'EMPTY' with the **↑P** or **↓P** button. The time remaining to the end of the cassette is displayed next to the title 'EMPTY'.

- Confirm with the **OK** button.

- i** If the required cassette has not been inserted into the video recorder, for example, 'INSERT CASSETTE NUMBER XXX' will appear on the screen. Put the required cassette in the machine.

- Once the video recorder has found the position on the tape it will stop automatically.

Editing the title

The title of a recording is automatically recorded if it is broadcast by the television channel. Otherwise the date and time of the recording are stored as the title. You can edit the title according to your own personal wishes.

- Press the **TAPE MANAGER** button on the remote control.

- Select the 'EDIT A TITLE' line. Confirm with the **→** button. A listing of all the recordings on the cassette in the machine will be displayed on the screen.

- i** In line 'CASSETTE NUMBER' you can select a different cassette number with the **→** or **←** button.

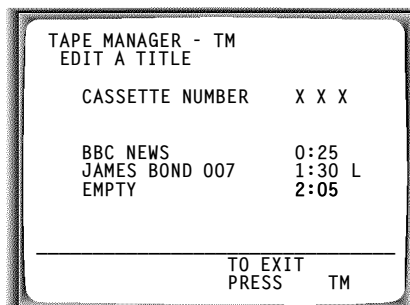

- Select the title you require with the **↑P** or **↓P** button.

- 4 Press the button.
- 5 Select the symbol you want to change with the or button.
- 6 Change the symbol at the symbol position with the or button.
- 7 Save the new title with the button.

If you want to change more titles, repeat step 3 through 6 .

Removing a cassette number

Every cassette is stored with a number in the Tape Manager. You can delete this cassette number from the Tape Manager, so that you can use this cassette for special recording functions (for instance, synchro edit or dubbing). You can delete cassette numbers that you don't need anymore to create space for new cassettes.

- 1 Press the button on the remote control.
- 2 Select the line 'REMOVE A CASSETTE NR.'. Confirm by pressing .
- 3 Select the cassette you require by pressing the or button and press . will appear on the screen.

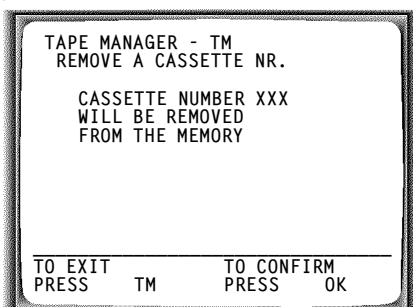

- 4 Confirm the cassette number with the button.
 - The word 'CASSETTE NUMBER XXX REMOVED FROM MEMORY' will appear on the screen when the cassette number has been removed.
 - The cassette will now be removed from the Tape Manager.

Copying the Tape Manager memory

If you cannot or do not want to use your video recorder (VCR A) any more, you can transfer the Tape Manager memory to another video recorder (VCR B).

- Video recorder (VCR B) must also be equipped with the Tape Manager. The Tape Manager of VCR B must be empty.

- 1 Switch off VCR A and VCR B with the button. Please note, that no cassette is inserted in either one of the machines.
- 2 Connect the socket on VCR A to the socket on VCR B.

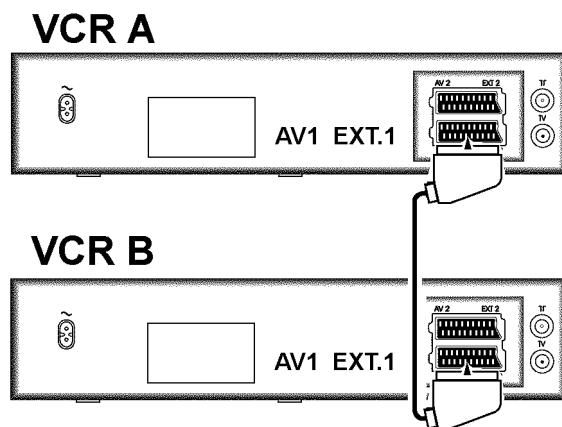

- 3 On VCR A, press the and buttons at the same time.
- 4 On VCR B, press the and buttons at the same time. 'TM' will appear in the display.
 - A search symbol will appear in the display while the information is being copied. This may take a few minutes.
- 5 When the transfer is finished, the display will read 'OK'.
 - If 'NO E' appears in the display on VCR B, there are already some cassettes stored in the Tape Manager. To end, press the .
 - If 'NO D' appears in the display on VCR B, there are no cassettes stored in the Tape Manager on VCR A. Finish with the .
 - If 'ERR.' appears in the display on VCR B, this means that an error was detected during the information transfer. Repeat the transfer starting with step 1 .
- 6 When the transfer is finished, both video recorders will switch off automatically. Remove the scart cable.

5. PLAYBACK FUNCTIONS

Playing a cassette

- 1 Put a cassette into the cassette slot. 'C' will appear on the display.

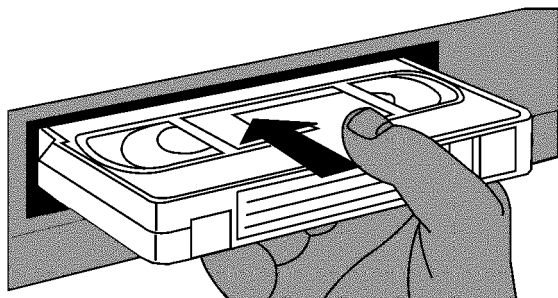

- i The cassette is being checked. Wait until the search symbol in the display has gone out. You can find more information on the Tape Manager in the chapter 'The Tape Manager (TM)'.

- 2 Press the **PLAY ▶** button.
- 3 To stop, press the **STOP ■** button.
- 4 To eject the cassette, press the **STOP/EJECT ■/▲** button on the video recorder.

- i Some hired cassettes may have a poor picture or poor sound quality. This is not a fault in your machine. Please read the section 'Selecting the picture setting (SMART PICTURE)', or 'Eliminating picture interference'.

- i Some functions switch off automatically after a while (for example, pause, still picture, picture search). This helps to protect the cassette and avoids wasting power.

Playing NTSC cassettes

With this set you can playback cassettes that have been recorded on another video recorder in the NTSC standard (for example, American cassettes). But this only works for PAL-television sets which are suitable for a picture frequency of 60 Hz.

When you play an NTSC cassette '60HZ' will appear on the display.

- i Some special features (for example, still picture) are not possible while you are playing an NTSC cassette.

Tape position indication





By pressing the **OK** button, you can show the present tape position on the TV screen.

- 1 During playback press the **COUNTER** button.
 - 2 Select one of the following options with the **COUNTER** button:
 - 'TIME USED' to indicate the time used on the tape
 - 'TIME LEFT' to indicate the time left on the tape
 - 'COUNTER' to indicate the actual position on the tape
- i To reset the tape position to '0:00:00', press the **CLEAR (CL)** button.
 - i This video recorder will automatically recognise the length of the tape.
 - i When you put in a cassette, the video recorder must first calculate the playing time for 'TIME USED' or 'TIME LEFT'. Therefore, the display first shows '0' and then shows the playing time after the tape has been running for a few seconds.
 - i If the video recorder does not find a recording at a particular tape position with 'COUNTER' switched on, the counter will stop.

Searching for tape position with the picture (picture search)

- 1 While a cassette is playing, press the **◀◀** (reverse) or **▶▶** (forward) button once or several times.
 - 2 To stop at a certain picture, press the **PLAY ▶** button.
- i During picture search, the picture quality may not be so good and there will be no sound.

Still picture/Slow motion





- 1 Press the  button. A still picture will appear on the screen.
- 2 Each time you press  again, the picture will move on one step.
- 3 When you hold the  button, the tape will be played in slow motion.
- 4 When you press the  button several times, you have a choice of several playback speeds. During slow motion there will be no sound.

The JOG/SHUTTLE functions on the video recorder

You will find a large rotary knob (Shuttle)  on the video recorder.



- 1 Switch the function on with the  button on the video recorder. You will see a still picture.
- 2 The outer (shuttle) ring enables you to select different tape speeds for the picture search.

Searching for tape position without the picture (wind and rewind)

- 1 Stop the tape with the  button.
- 2 Press the  (reverse) or  (forward) button. If you want to carry out this function on your video recorder, turn the large knob (shuttle)  to the left or to the right.
- 3 To stop at a certain place on the tape, press the  button.



Instant View

With this function you can switch to picture search during wind and rewind.

- 1 If you hold the  (rewind) or  (wind) button during wind or rewind, you will switch to picture search.
 If you want to carry out this function on your video recorder, turn the large knob to the left or to the right while you wind or rewind the tape.
- 2 When you release the button or the knob, the video recorder will automatically switch back to rewind or wind.

Automatic search for a tape position (index search)

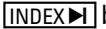
At the start of each recording, the video recorder will write an index code on the tape.

- 1 Press the  button and then the  button to select the next code mark or the  button for the previous code mark.
- 2 When the video recorder finds the code mark, it will automatically switch to play.

Selecting the picture setting (SMART PICTURE)

You can change the picture setting while a tape is playing.

- 1 Press the **SMART** button. This will show the current picture setting.
- 2 Press the **SMART** button again to select the picture setting of your choice.
'NATURAL': for all types of movies (natural picture)
'DISTINCT': for fast movement, sport (detailed picture)
'SOFT': for hired tapes (interference is suppressed)
'SHARP': for cartoons (sharp picture)

 This picture setting will not change until you eject the cassette.

Picture interference

If the picture quality is poor when you play a cassette, please follow these instructions.

Tracking during playback

- 1 During playback, press the **MENU** button.
- 2 Select the line 'PLAY FUNCTIONS' with the **P↓** or **↑P** button and confirm with the **→** button.
- 3 Select the line 'MANUAL TRACKING' with the **P↓** or **↑P** button.
- 4 Hold the **←** or **→** button until the playback quality is at its best.
- 5 Confirm with the **OK** button.
- 6 To end, press the **MENU** button. This setting will remain until you remove the cassette.

Tracking during still picture

If the still picture vibrates vertically, you can improve the still picture as follows:

- 1 During still picture, press the **MENU** button.
- 2 Select the line 'PLAY FUNCTIONS' with the **P↓** or **↑P** button and confirm with the **→** button.
- 3 Select the line 'VERTICAL STABILITY' with the **P↓** or **↑P** button.
- 4 Hold the **←** or **→** button until the picture quality is at its best.
- 5 Confirm with the **OK** button.
- 6 To end, press the **MENU** button.

 Please note, however, that interference may still occur with poor quality cassettes.

Cleaning the video heads

If horizontal lines appear on the screen when you play a cassette, you should clean the video heads.



- 1 During playback, press the **MENU** button.
- 2 Select the line 'PLAY FUNCTIONS' with the **P↓** or **↑P** button and confirm with the **→** button.
- 3 Select the line 'HEAD CLEANING' with the **P↓** or **↑P** button.
- 4 Press the **OK** button. 'HEAD CLEANING IN PROGRESS' appears on the screen.
- 5 Wait a few seconds, until the message disappears and then press the **MENU** button.



6. MANUAL RECORDING

Use 'Manual Recording' to make a spontaneous recording (for example, a programme currently being shown).

- If you want to start and stop a recording manually, read the section: 'Recording without automatic switch-off'.
- If you want to start a recording manually but have it stopped automatically, read the section: 'Recording with automatic switch-off'.
- If you want a recording to be controlled automatically by a satellite receiver, read the section entitled 'Automatic recording from a satellite receiver'.

Recording without automatic switch-off

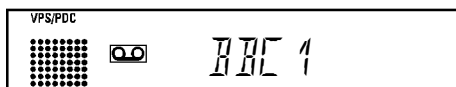

- 1** Insert a cassette.
 -  The cassette is being checked. Wait until the search symbol in the display has gone out. More information on the Tape Manager can be found in the chapter 'The Tape Manager (TM)'.

- 2** Use the  or  button to select the programme number (or channel name) you want to record. On the display appears:

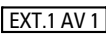
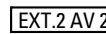

-  Programme numbers 'E1' and 'E2' are for recording from other sources (through scart sockets  and ). Programme number 'E3' is for recording from the front sockets.

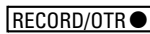

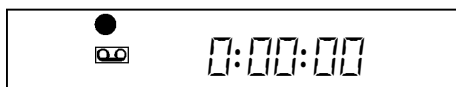

-  Programme number 'AUX' is provided for audio recordings via sockets .

- 3** To start recording, press the  button on the remote control or  on the video recorder. On the display you will see:

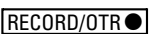
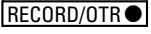

- 4** Stop recording with the  button.

Recording with automatic switch-off (OTR one-touch-recording)

- 1** Put a cassette in the machine.
 -  The cassette is being checked. Wait until the search symbol in the display has gone out.
- 2** Use the  or  button to select the programme number (channel name) you want to record.
- 3** Press the  button on the remote control.
- 4** Press the  button again and again until the display on the video recorder shows the desired end time or length of the recording.
 -  To cancel this information, press the  button.

Protecting your recordings

So that you don't accidentally delete an important recording, remove the special tab on the narrow side of the cassette with a screwdriver or slide the special tab to the left. Later, if you no longer want to protect your recording, you can seal the gap again with sticky tape or slide the special tab to the right.

Auto-assembling

You can use the auto-assembling function to join individual recordings without any major picture disturbance between them.

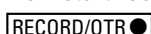
- 1** While the cassette is playing, search for the correct position on the tape.
- 2** Stop the cassette by pressing the  button. 'II' will appear in the display.
- 3** Now start recording as usual by pressing the  button on the remote control.

Selecting the recording speed (SP or LP)

You can reduce the recording speed by half. This makes it possible to record, for example, eight-hours instead of four-hours on an 'E240' (four-hour) cassette.

- 1 Switch on the TV set and, if required, select the programme number for the video recorder.
- 2 Press the **MENU** button. The main menu appears.
- 3 Select the line 'RECORDING FUNCTIONS' with the **P↓** or **↑P** button, and confirm with the **→** button.
- 4 Select the line 'RECORD SETTINGS' with the **P↓** or **↑P** button, and confirm with the **→** button.
- 5 Select the line 'RECORDING SPEED' with the **P↓** or **↑P** button.
- 6 Select the required recording speed with the **←** or **→** button.
 - i> 'LP': Long Play = half recording speed (double recording time).
'SP': Standard Play = normal recording speed.
 - i> The picture quality will be adversely affected when recording at half recording speed ('LP').
 - i> For playback, the correct recording speed will automatically be selected.
- 7 Confirm with the **OK** button.
- 8 To end, press the **MENU** button.

Automatic recording from a satellite receiver (SAT RECORDING)

You can only use this function, when you have a satellite receiver, which can control other equipment by a 'programming' function through a scart cable.

- 1 Switch on the TV set. If required, select the programme number for the video recorder.
- 2 Press the **MENU** button. The main menu appears.
- 3 Select the line 'RECORDING FUNCTIONS' with the **P↓** or **↑P** button, and confirm with the **→** button.
- 4 Select the line 'RECORD SETTINGS' with the **P↓** or **↑P** button, and confirm with the **→** button.
- 5 Select the line 'SAT RECORDING' with the **P↓** or **↑P** button.
- 6 Select the required scart socket 'E1' or 'E2' with the **←** or **→** button.
If you want to switch off the function, select 'OFF' with the **→** or **←** button.
- 7 Confirm with the **OK** button.
- 8 Use a scart cable to connect the scart socket you selected on the video recorder (**EXT.1 AV1** or **EXT.2 AV2**) to the corresponding scart socket on the satellite receiver.
- 9 Insert a cassette.
 - i> The cassette is being checked. Wait until the search symbol in the display has gone out.
- 10 Switch off with the **STANDBY** button. The video recorder is now ready to record. The beginning and end of the recording is controlled via one of the scart sockets.
 - i> When this function is switched on and the video recorder is switched off, '⊗' will appear on the video recorder display.

Switching on 'Direct Record'

When this function is switched on, the video recorder will automatically record the programme selected on the television by means of a scart cable.

 **The video recorder must be switched off .**

 With 'Connecting with scart cable and 'Easy Link/NexTView', the video recorder will also take the programme number from the TV set automatically with the video recorder switched on.

- 1** Switch on the TV set. If required, select the programme number for the video recorder.
- 2** Press the **MENU** button. The main menu appears.
- 3** Select the line 'RECORDING FUNCTIONS' with the **P↓** or **↑P** button, and confirm with the **→** button.
- 4** Select the line 'RECORD SETTINGS' with the **P↓** or **↑P** button, and confirm with the **→** button.
- 5** Select the line 'DIRECT RECORD' with the **P↓** or **↑P** button.
- 6** Select the function 'ON' with the **←** or **→** button. If you select 'OFF', the function will be switched off.
- 7** Confirm with the **OK** button.
- 8** To end, press the **MENU** button.
- 9** Switch off with the **STANDBY** button.
- 10** On the TV set, select the programme number you want make the recording from.
- 11** Press the **RECORD/OTR** button with the video recorder **switched off**.

 Don't select another programme number on your TV set, until the 'search symbol' in the display of your video recorder disappears. This can take up to one minute.

 When 'NOTV' appears in the display, the programme number could not be found. The video recorder switches off automatically. In this case, read the section 'Recording without automatic switch-off'.

7. PROGRAMMED RECORDING (TIMER)

Use programmed recording to automatically start and stop a recording at a later date.

To make a programmed recording, your video recorder needs to know:

- * the date you want to make the recording;
- * the programme number for the TV channel you want to record;
- * the start and stop time of the recording;
- * VPS/PDC on or off
- * the recording speed (SP/LP)

The video recorder stores all the information in a TIMER block. You can programme up to 6 TIMER blocks a month in advance.

'VPS' (Video Programming System) and 'PDC' (Programme Delivery Control)

With 'VPS and PDC', the TV station controls the start time and the length of the recording. This means that the video recorder switches itself on and off at the **right time** even if a TV programme you want to record begins earlier or finishes later than expected.

You must enter the start time **exactly to the minute**.

If you want to programme a time that is different from the VPS or PDC time, you must switch off VPS or PDC.

Programming a recording (with 'VIDEO Plus+')

All the information required for a programming is contained in the PlusCode-programming number.

VIDEO Plus+

- 1 Switch on the TV set and select the programme number for the video recorder.
- 2 Press the **TIMER** button on the remote control. The programming mode selected last is marked.
- 3 Select the line 'VIDEPLUS PROGRAMMING' with the **P↓** or **↑P** button and confirm with the **→** button.

- 4 Enter the entire PlusCode-programming number (up to 9 digits) printed in your TV guide next to the start time of a TV programme.

For example, 5-234-89 or 5 234 89

Enter 523489 for the PlusCode-programming number.



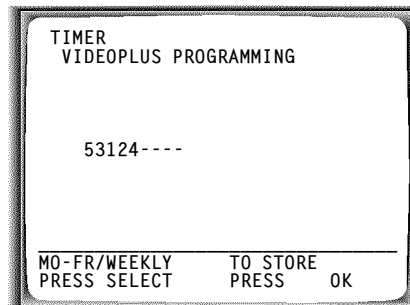



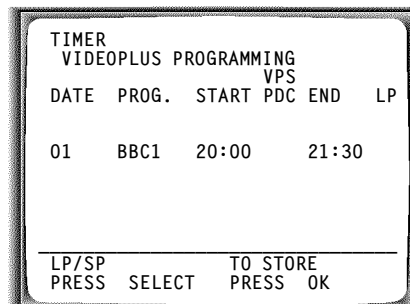





If you make a mistake, you can clear your instructions with the **CLEAR (CL)** button.



- 5 Use the **SELECT** button to select daily or weekly programming.
'MO - FR': recordings every day from Monday to Friday.
'WEEKLY': recordings every week on the same day of the week.
- 6 Confirm with the **OK** button. Your programming details will then appear on the TV screen.







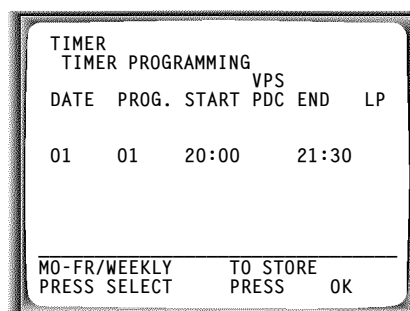

- ▶ You need to confirm the programme number the first time you programme your video recorder with VIDEO Plus+.
- ▶ If VIDEO Plus+ does not recognise the TV channel, 'PLEASE ENTER PROGRAMME NUMBER' will appear on the TV screen. Instead of 'PLEASE ENTER PROGRAMME NUMBER', you can select the programme number you want with the number buttons **0-9** and confirm with the **OK** button.
- ▶ If 'VIDEO PLUS CODE WRONG' appears on the TV screen, this means you entered an incorrect PlusCode number or the incorrect date. Correct your instructions or end with the **TIMER** button.
- ▶ If 'WEEKEND PROGRAMMING - NOT POSSIBLE' appears on the TV screen, the date was incorrectly entered. 'Daily' programming can only be used for recordings to be made from Mondays to Fridays.

-  Use the **[SELECT]** button to switch 'VPS/PDC' on or off in 'START'.
 -  Use the **[SELECT]** button to select the recording speed 'SP' or 'LP' in 'END'.
- 7** Confirm with the **[OK]** button when the information is correct.
-  The programming information has been stored in a TIMER block.
- 8** To end, press the **[TIMER ⏸]** button.
- 9** Make sure that the cassette you have put in can be recorded on.
-  The cassette is being checked. Wait until the search symbol in the display has gone out. More information on the Tape Manager can be found in the chapter 'The Tape Manager (TM)'.
- 10** Switch off with the **[STANDBY ⏸]** button. The programmed recording will only function when the video recorder is **switched off** with the **[STANDBY ⏸]** button.
-  If any of the TIMER blocks are in use, '⏸' will light up on the video recorder display.
 -  While a programmed recording is being made, you cannot operate your video recorder manually. If you want to cancel the programmed recording, press the **[STANDBY ⏸]** button.
 -  If the video recorder is switched on a few minutes before a programmed recording is supposed to begin, 'SWITCH TO STANDBY - TIMER RECORDING' will flash on the TV screen.
 -  If you reach the end of the cassette during a recording, the video recorder will automatically eject the cassette.
 -  If you forget to load a cassette, 'NO CASSETTE' will appear on the TV screen and '⏸' will flash on the video recorder display.
 -  If you have put in a cassette which cannot be used for recording, the video recorder will automatically eject it.
 -  If 'TIMER FULL' appears on the TV screen when you press the **[TIMER ⏸]** button, you have used up all the available TIMER blocks. If you want to clear or check a TIMER block, select it with the **[↑P]** or **[P↓]** button.
 -  Programme number 'AUX' is provided for audio recordings via sockets **[AUX IN L R]**.

Programming a recording (without 'VIDEO Plus+')

- 1** Switch on the TV set and select the programme number for the video recorder.
- 2** Press the **[TIMER ⏸]** button on the remote control. The programming mode selected last is marked.
- 3** Select the line 'TIMER PROGRAMMING' with the **[P↓]** or **[↑P]** button and confirm with the **[→]** button.



- 4** Select the entry field with the **[←]** or **[→]** button.
- 5** Enter information with the **[P↓]** or **[↑P]** button or with the digit buttons **[0-9]**.
 -  Under 'DATE', use the **[SELECT]** button to select daily or weekly programming.
 - 'MO - FR': Recording from Monday to Friday.
 - 'MO': Recordings every week on the same day.
 -  Under 'START', use the **[SELECT]** button to switch 'VPS or PDC' on or off.
 -  Under 'END', use the **[SELECT]** button to select the recording speed 'SP' or 'LP'.
- 6** Confirm with the **[OK]** button when the information is correct.
 -  The programming information has been stored in a TIMER block.
- 7** To end, press the **[TIMER ⏸]** button.
- 8** Make sure that the cassette you have put in can be recorded on.
 -  The cassette is being checked. Wait until the search symbol in the display has gone out. More information on the Tape Manager can be found in the chapter 'The Tape Manager (TM)'.

- 9** Switch off with the **STANDBY** button.
The programmed recording will only function when the video recorder is **switched off** with the **STANDBY** button.
- i** If any of the TIMER blocks are in use, 'Ⓞ' will light up on the video recorder display.
 - i** While a programmed recording is being made, you cannot operate your video recorder manually. If you want to cancel the programmed recording, press the **STANDBY** button.
 - i** If the video recorder is switched on a few minutes before a programmed recording is supposed to begin, 'SWITCH TO STANDBY - TIMER RECORDING' will flash on the TV screen.
 - i** If you reach the end of the cassette during a recording, the video recorder will automatically eject the cassette.
 - i** If you forget to load a cassette, 'NO CASSETTE' will appear on the TV screen and 'Ⓞ' will flash on the video recorder display.
 - i** If you have put in a cassette which cannot be used for recording, the video recorder will automatically eject it.
 - i** If 'TIMER FULL' appears on the TV screen when you press the **TIMER** button, you have used up all the available TIMER blocks. If you want to clear or check a programmed recording (TIMER block), press the **→** button and select the TIMERR block with the **↑P** or **P↓** button.
 - i** Programme numbers 'E1' and 'E2' are for recordings from other sources (through scart socket **EXT.1 AV1** or **EXT.2 AV2**).

How to check or change a programmed recording (TIMER)

- 1** Switch on the TV set and select the programme number for the video recorder.
- 2** Press the **TIMER** button on the remote control. The programming mode selected last is marked.
- 3** Select the line 'TIMER LIST' with the **P↓** or **↑P** button and confirm with the **→** button.
- 4** Select the programmed recording (TIMER) you want to check or change with the **↑P** or **P↓** button.
- 5** Press the **→** button.
- 6** Select the entry field with the **←** or **→** button.
- 7** Change any information with the **P↓** or **↑P** button or with the **0-9** buttons.
 - i** Under 'END', use the **SELECT** button to select the recording speed 'SP' or 'LP'.
- 8** Confirm with the **OK** button.
- 9** To end, press the **TIMER** button.
- 10** Make sure that the cassette you have put in can be recorded on. Switch off with the **STANDBY** button.
 - i** The programmed recording will only function when the video recorder is **switched off** with the **STANDBY** button.

How to clear a programmed recording (TIMER)

- 1** Switch on the TV set and select the programme number for the video recorder.
- 2** Press the **TIMER** button on the remote control. The programming mode selected last is marked.
- 3** Select the line 'TIMER LIST' with the **P↓** or **↑P** button and confirm with the **→** button.
- 4** Select the programmed recording (TIMER) you want to clear with the **P↓** or **↑P** button.
- 5** Press the **CLEAR (CL)** button.
- 6** Confirm with the **OK** button.
- 7** Switch off with the **TIMER** button.

'NexTView Link'

This video recorder is equipped with the function 'NexTView Link'. If your television is also equipped with this function, you can mark TV programmes on the television for programming. These TV programmes will automatically be transmitted to a TIMER block on the video recorder. If you clear the marking of the TV programme on the television, the corresponding TIMER block on the video recorder will also be cleared. For more information, read the instruction manual of your TV set.

8. ADDITIONAL FUNCTIONS

Changing the TV system

If you play back recordings made on a different kind of tape (for example, NTSC standard), the automatic TV system switch-over may lead to colour interferences. You can switch off the 'automatic TV system switch-over' as follows.

- 1 Switch on the TV set. If required, select the programme number for the video recorder.
- 2 Press the **[MENU]** button. The main menu appears.
- 3 Select the line 'SPECIAL SETTINGS' with the **[P↓]** or **[↑P]** button and confirm with the **[→]** button.

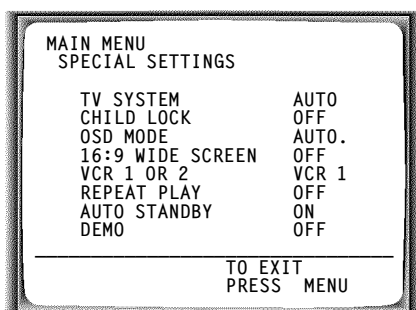

- 4 In the line 'TV SYSTEM' select the required TV system with the **[←]** or **[→]** button.
- 5 Confirm with the **[OK]** button.
- 6 To end, press the **[MENU]** button.
 - i▶** If colour interference still occurs, you can switch to 'B/W' (black and white) in line 'TV SYSTEM'.

Child lock

This function will prevent unauthorised use of your video recorder. All button-functions will be locked.

i▶ You can make programmed recordings while the child lock is on.

- 1 Switch on the TV set. If required, select the programme number for the video recorder.
- 2 Press the **[MENU]** button. The main menu appears.
- 3 Select the line 'SPECIAL SETTINGS' with the **[P↓]** or **[↑P]** button and confirm with the **[→]** button.

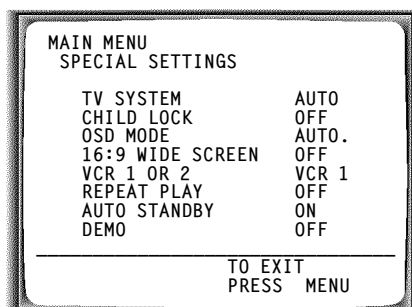

- 4 In the line 'CHILD LOCK' select 'ON' with the **[←]** or **[→]** button.
- 5 Confirm with the **[OK]** button.
- 6 To end, press the **[MENU]** button.
 - 'σπ' appears in the video recorder display. Keep the remote control in a safe place.
- 7 If you want to switch off the child lock, select 'OFF' in line 'CHILD LOCK'. 'σπ' disappears from the video recorder display.
 - i▶** If a button is pressed with activated child lock, 'σπ' flashes in the display for a few seconds.

You may also activate the child lock with the remote control. Press the **[STANDBY ⏻]** button on the remote control for a few seconds, until 'σπ' appears in the video recorder display. Switch the child lock off in the same way.

Switching the 'on-screen display' (OSD) on or off

You can switch the on-screen display of the current operating information on or off.

- 1 Switch on the TV set. If required, select the programme number for the video recorder.
- 2 Press the **MENU** button. The main menu appears.
- 3 Select the line 'SPECIAL SETTINGS' with the **P↓** or **↑P** button and confirm with the **→** button.

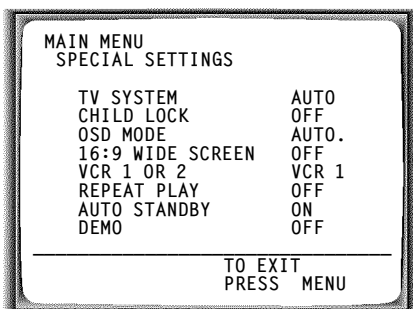

- 4 Select the line 'OSD MODE' with the **P↓** or **↑P** button.
- 5 Select one of the options indicated with the **→** or **←** button.
'AUTO.': OSD information appears for a few seconds each time an operating mode is selected and then disappears.
'OFF': OSD information is switched off.
'ON': OSD information is switched on.
- 6 Confirm with the **OK** button.
- 7 To end, press the **MENU** button.
 With the **OK** button you can superimpose the on-screen display of current operating mode on the TV screen.

Switching to 16:9 wide screen picture

If you are using a cassette with 16:9 wide screen recordings, you can switch this function 'ON'. The TV set will now automatically switch to wide screen. This only works if you have connected the TV set and the video recorder with a scart cable and if your TV set is suitable for wide screen.

- 1 Switch on the TV set. If required, select the programme number for the video recorder.
- 2 Press the **MENU** button. The main menu appears.
- 3 Select the line 'SPECIAL SETTINGS' with the **P↓** or **↑P** button and confirm with the **→** button.
- 4 If you have a TV set in wide-screen format, select 'ON' in line '16:9 WIDE SCREEN'. If not, select 'OFF'.
- 5 Confirm with the **OK** button.
- 6 To end, press the **MENU** button.

Switching the remote control command

If you have two video recorders with the same remote control command, you can change the remote control command of the handset and the remote control command of one of the video recorders.

- 1 Switch on the TV set. If required, select the programme number for the video recorder.
- 2 Press the **MENU** button. The main menu appears.
- 3 Select the line 'SPECIAL SETTINGS' with the **P↓** or **↑P** button and confirm with the **→** button.

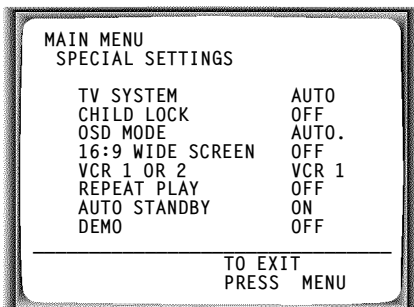

- 4 Select the line 'VCR 1 OR 2' with the **P↓** or **↑P** button.
- 5 Select 'VCR 1' or 'VCR 2' with the **←** or **→**.
- 6 Confirm with the **OK** button.
- 7 On the remote control, press the **SELECT** button and the digit button **2** **at the same time** to switch the remote control to 'VCR 2'.
 - i> If you want to switch back to 'VCR 1, press the **SELECT** button and the digit button **1** **at the same time**.
- 8 Confirm with the **OK** button.
 - i> If the menu does not disappear, the video recorder didn't recognise the remote control command. Repeat step **7**.
 - i> After you changed the batteries in the remote control, it will switch back to 'VCR 1'.
 - i> If e.g.: 'VCR ONLY RESPONDS TO VCR 2 COMMANDS' appears on the TV screen or 'VCR 2' appears in the video recorder display after pressing a button for a few seconds, you must switch the remote control to 'VCR 2'.
- 9 To end, press the **MENU** button.

Continuous playback

You can automatically play a cassette again and again. When the video recorder reaches the end of the tape or the end of the recording, it will rewind and start again.

- 1 Press the **MENU** button. The main menu appears.
- 2 Select the line 'SPECIAL SETTINGS' with the **P↓** or **↑P** button. Confirm with the **→** button.

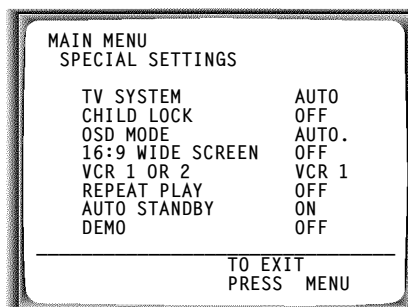

- 3 Select the line 'REPEAT PLAY' with the **P↓** or **↑P** button.
- 4 Select 'ON' with the **←** or **→** button. If you select 'OFF', the function will be switched off.
- 5 Confirm with the **OK** button.
- 6 Press the **MENU** button.
- 7 Put a cassette in the machine.
 - i> The cassette is being checked. Wait until the search symbol in the display has gone out. More information on the Tape Manager can be found in the chapter 'The Tape Manager (TM)'.
- 8 Start the continuous playback with the **PLAY▶** playback button.

Automatic switch-off (tuner mode)

If you do not use the video recorder for a few minutes in certain modes (e.g.: STOP), it will switch to standby automatically. You can cancel this function to use the video recorder as a television receiver (tuner).

- 1** Switch on the TV set and select the programme number for the video recorder.
- 2** Press the **MENU** button. The main menu appears.
- 3** Select the line 'SPECIAL SETTINGS' with the **P↓** or **↑P** button and confirm with the menu button **→**.
- 4** Select the line 'AUTO STANDBY' with the **P↓** or **↑P** button.
- 5** Select 'OFF' with the **←** or **→** button. If you select 'ON', the function will be switched on.
- 6** Confirm with the **OK** button.
- 7** To end, press the **MENU** button.

i A **TIMER recording** only works when the video recorder is **switched to standby**.

The 'DEMO' function



When the 'DEMO' function is switched on and the video recorder **switched off**, several menus will be demonstrated on the TV screen. This has no influence on operating the video recorder.

- 1** Switch on the TV set and select the programme number for the video recorder.
- 2** Press the **MENU** button. The main menu appears.
- 3** Select the line 'SPECIAL SETTINGS' with the **P↓** or **↑P** button and confirm with the **→** button.
- 4** In the line 'DEMO', select 'ON' with the **→** or **←** button. If you select 'OFF' the function will be switched off.
- 5** Confirm with the **OK** button.
- 6** To end, press the **MENU** button.





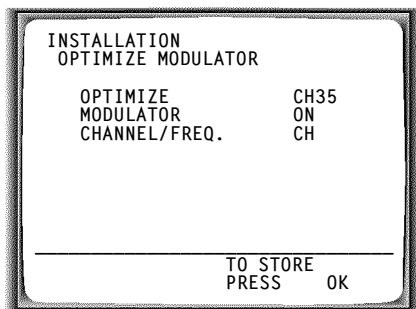

i The 'DEMO' function is not possible during a 'TIMER recording' and during an 'Automatic recording from a satellite receiver'.

Reducing picture disturbance ('optimizing the modulator')

You may experience picture disturbance if you have not used a scart cable to connect your video recorder and TV. This is because another TV station in your reception area may already be using UHF-channel CH35 or 583MHz.

- 1 Make sure that there is **no** cassette in the video recorder. On the video recorder, **simultaneously** hold the **STOP/EJECT**  and the **PLAY**  button for a few seconds until e.g.: 'CH35' or '583' appears in the display. The video recorder will transmit a test picture on UHF-channel 35(or frequency 583Mhz).









- 2 In line 'CHANNEL/FREQ.' select the indication for channel 'CH' or frequency 'FREQ.', using the  or  button.
- 3 Select the line 'OPTIMIZE' with the  or  button. Press the  button.
- 4 When the video recorder finds a 'free' TV channel, the channel or frequency will be indicated.
 -  You can also enter the channel or frequency directly with the digit buttons **[0-9]**.
- 5 Tune in the TV set in this channel or frequency.
- 6 Confirm the channel or frequency indicated with the **[OK]** button.
- 7 To end, press the **[MENU]** button.

Switching off the modulator

If you cannot clear picture or sound interference, you can switch off the built-in modulator. You should only do this if you have connected the video recorder to the TV set with a scart cable.







-  With the function 'Easy Link/NexTView' the modulator will be switched off automatically.



- 1 Switch on the TV set and select the programme number for the video recorder.
- 2 Make sure that **no** cassette is in the video recorder. On the video recorder, press the **STOP/EJECT**  and **PLAY**  button **at the same time** for several seconds, until, for example, 'CH35' or '583' appears on the video recorder display.
- 3 Select the line 'MODULATOR' on the TV screen or 'M ON' in the display with the  or  button.
- 4 With the  or  button, select the function 'OFF' on the TV screen or 'MOFF' (modulator off) in the display. Select 'ON' on the TV screen or 'M ON' (modulator on) in the display to switch the modulator back on.
- 5 Confirm with the **[OK]** button.
- 6 To end, press the **[MENU]** button.

Using your video recorder remote control with your TV set

Your video recorder remote control can transmit several commands to TV sets of different makes.

By using the **TV** buttons on the panel in the middle of the control, you can:

-  increase the TV volume
-  reduce the TV volume
-  switch off sound
-  switch off the TV set
-  next programme number
-  previous programme number





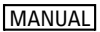

- 1** Hold the  button and enter the correct remote control command with the digit buttons .

You will find a list of all available remote control commands on the last page of this manual.

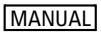
-  If the selected code does not work with your TV set, or if the make of your TV is not in the list, you can try out the codes one after the other.











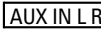

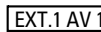

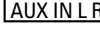

Manual audio control

With the  button you can switch to manual audio control.

- 1** Press the  button on the video recorder. The current selection appears in the display.
- 2** Keep pressing the  button until 'MAN' (manual audio control) appears in the display.
- 3** With the  and  buttons adjust the recording level so that the '0 dB' mark lights up during the loudest parts of the recording.
 -  At step **2** you can switch back to 'AUTO.' (automatic audio control) with the  button.

Recording audio only

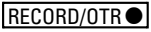
You can use your video recorder as a HiFi tape recorder. You can record the sound from e.g. a HiFi unit or a second video recorder.

- 1** Switch on the TV set and select the programme number for the video recorder.
- 2** Put a cassette in the machine.
 -  For this function, use a cassette whose number is not stored in the Tape Manager (TM). More information on removing the cassette number from the Tape Manager (TM) can be found in the chapter 'The Tape Manager (TM)'.
- 3** Use an audio cable (cinch cable) to connect your HiFi (stereo) unit with the  socket at the back of the video recorder.
 -  You can also use the  or  sockets or the front  sockets for audio-only recordings.
- 4** Select the programme number from which the 'only audio' recording should be made, using the  or  button (e.g.: 'AUX' for the  socket).
- 5** Press the  button. The main menu appears.
- 6** Select the line 'RECORDING FUNCTIONS' with the  or  button and confirm with the  button.
- 7** Select the line 'AUDIO ONLY' with the  or  button and confirm with the  button.
- 8** To start sound recording, press the  button.
- 9** To stop recording, press the  button.
- 10** To end, press the  button.

Audio dubbing

This function enables you to replace (dub) the sound track of an existing recording with another sound track. To do this, connect an audio source (e.g.: a CD-player) to one of the input sockets (for example, **L AUDIO R**).

- 1** Switch the television on and select the channel number for the video recorder.
- 2** Put the cassette for dubbing in the machine.
 -  For this function, use a cassette whose number is not stored in the Tape Manager (TM). More information on removing the cassette number from the Tape Manager (TM) can be found in the chapter 'The Tape Manager (TM)'.
- 3** Press the **MENU** button. The main menu appears.
- 4** Select the line 'RECORDING FUNCTIONS' with the **P↓** or **↑P** button and confirm with the **→** button.
- 5** Select the line 'AUDIO DUBBING' with the **P↓** or **↑P** button and confirm with the **→** button.
- 6** Select the programme number for the audio source (e.g.: 'E3'). Switch on the external audio source. During playback, locate the position on the tape at which the audio dubbing is to end.
- 7** Press the **STILL▶◀** button. 'STILL' appears on the TV screen.
- 8** Press the **CLEAR (CL)** button. '0:00:00' appears on the TV screen.
- 9** Locate the position at which the audio dubbing is to start.
- 10** Press the **STILL▶◀** button. 'STILL' appears on the TV screen.
- 11** Press the **STOP■** button.
- 12** Press the **RECORD/OTR●** button. The video recorder will start to record the sound transmitted from the audio source. The audio recording stops **automatically** when the counter reaches '0:00:00'.



 The normal (linear) sound track is re-recorded, the stereo sound will remain.

- 13** To end audio dubbing, press the **MENU** button.

 To play back the dubbing sound track, read the next section 'Selection the sound track'.

Selecting the sound track

You can select the required sound track when you play a cassette. This is of particular interest when the audio transmissions are multilingual.

- 1** Press the **SELECT** button. The current setting will appear on the TV screen.
- 2** By pressing the **SELECT** button several times you can select from the five possibilities displayed ('STEREO', 'RIGHT', 'LEFT', 'MONO', 'MIXED').
 -  Dubbed sound recordings can be replayed with the 'MONO' or 'MIXED' setting.
 - 'MONO': Dubbed (linear) sound track.
 - 'MIXED': Original sound (hi-fi sound track) together with dubbed sound (linear sound track).
 -  If the cassette does not have stereo sound recorded on it, the video recorder will automatically switch to mono.

Synchronous editing (synchro-edit)

You can synchronously copy between this video recorder and an appropriately equipped camera recorder. Both units are started at the same time with the help of a synchronous impulse and an adjustable start delay (=preroll time).

Connecting the video recorder and the camera recorder.

- 1 Connect the two units with a synchro-edit cable (socket **SYNCHRO EDIT** on the left front of the video recorder). Connect the video/audio source to the input sockets (programme number 'E3') of the video recorder. Please also observe the instruction manual of the camera recorder.
- 2 Switch on the TV set. If required, select the programme number for the video recorder.
- 3 Press the **MENU** button. The main menu appears.
- 4 Select the line 'RECORDING FUNCTIONS' with the **P↓** or **↑P** button and confirm with the **→** button.
- 5 Select the line 'CAMERA LINK' with the **P↓** or **↑P** button.
- 6 Switch the **camera recorder** to 'still picture' (playback-pause).
- 7 Confirm with the **→** button. The video recorder now checks the connected camera recorder type.
- The following message appears on the TV screen: 'VIDEO RECORDER TO CONTROL CAMERA' when the video recorder controls the camera recorder or 'CAMERA TO CONTROL VIDEO RECORDER' when the camera recorder controls the video recorder.

Starting synchro-edit

- 1 Switch on the TV set. If required, select the programme number for the video recorder.
 -  For this function, use a cassette whose number is not stored in the Tape Manager (TM). More information on removing the cassette number from the Tape Manager (TM) can be found in the chapter 'The Tape Manager (TM)'.

- 2 Press the **MENU** button. The main menu appears.
- 3 Select the line 'RECORDING FUNCTIONS' with the **P↓** or **↑P** button and confirm with the **→** button.
- 4 Select the line 'SYNCHRO EDIT' with the **P↓** or **↑P** button and confirm with the **→** button.
- 5 The OSD corresponding to the connected camera recorder type appears on the TV screen.
- 6 Search the beginning of the recording on the video recorder.
- 7 Press the **STILL▶◀** button. 'STILL' appears on the TV screen.
- 8 Use the **SELECT** button to select the OSD for the camera recorder.
- 9 Search the beginning of the recording on the camera recorder.
- 10 Switch the camera recorder to 'still picture' (playback-Pause).

The way copying is started depends on the camera recorder type used:

Variant 1: when the video recorder controls the camera recorder, or

Variant 2: when the camera recorder controls the video recorder.

Variant 1, the video recorder is to control the camera recorder

- 1** Start copying with the **RECORD/OTR** button on the video recorder.
The camera recorder starts 'PLAYBACK' and at the same time the video recorder starts 'RECORDING'.
- 2** Stop copying with the **STOP** button on the video recorder.
- 3** End copying with the **MENU** button.

Variant 2, the camera recorder is to control the video recorder

- 1** Start copying with the corresponding button on the camera recorder.
The camera recorder starts 'PLAYBACK' and at the same time the video recorder starts 'RECORDING'.
- 2** Stop copying with the PAUSE or STILL button on the camera recorder.
- 3** End copying with the **MENU** button.

Setting the 'preroll time'

When the beginning of the recording is missing, the 'preroll time' was too long. Select a shorter 'preroll time'.
If recording started too early, the 'preroll time' was too short. Select a longer 'preroll time'. You can select a 'preroll time' between 1:00 and 5:00 seconds.

- 1** Press the **MENU** button.
- 2** Select the line 'RECORDING FUNCTIONS' with the **P↓** or **↑P** button and confirm with the **→** button.
- 3** Select the line 'RECORD SETTINGS' with the **P↓** or **↑P** button and confirm with the **→** button.
- 4** In line 'PREROLL TIME', adjust the 'preroll time' with the **→** or **←** button.
 - i** You can also directly enter the 'preroll time' with the digit buttons **0-9**.
 - i** With the **CLEAR (CL)** button you can reset the 'preroll time' to that of the identified camera recorder type.
- 5** Confirm with the **OK** button.
- 6** To end, press the **MENU** button.

9. Before you call an engineer

If, contrary to expectation, you have any problems using this video recorder, it may be caused by one of the reasons mentioned below. You can also call the **customer service centre** in your country. Be prepared to give the model and production number to the customer service. Have the model number (MODEL NO) and the production number (PROD.NO) of your video recorder ready.

You will find the phone number in the enclosed guarantee leaflet.

Your video recorder does not respond to any button being pressed:

- There is no power supply: check the power supply
- A programmed recording is currently being made: cancel the programmed recording with the **STANDBY** button.
- Child lock is on: switch the child lock off.
- There is a technical problem: switch off the mains power supply for 30 seconds, then switch it on again. If this does not have any effect, you can:
 1. Switch off the mains power supply again.
 2. Then switch it on **whilst holding down** the **STANDBY** button on the video recorder.
 3. Release the button when '---' appears on the video recorder display. All the information stored (TV channels, time and date, TIMER) will be cleared.

Cassette is jammed in the video recorder:

- Don't use force. Pull out the mains plug for a moment.

Remote control does not work:

- Remote control not pointed toward the video recorder: point it at the video recorder.
- Batteries have run out: change the batteries.
- You are using the wrong remote control command: read 'Switching remote control command' in chapter 'ADDITIONAL FUNCTIONS'.

No picture when you play a cassette:

- There is no recording on the cassette: change the cassette.
- You have chosen the wrong programme number on the TV for playing cassette: on the TV, select the correct programme number for the video recorder.
- The cable connecting the TV set and the video recorder has come loose: check the cable.

Poor picture quality when you play a cassette:

- Your TV set is not properly adjusted.
- The cassette badly worn or of poor quality: use new cassette.
- Tracking is not properly adjusted or the video heads are dirty: turn to chapter 'PLAYBACK' and read the section 'Cleaning the video heads'.
- Read the section 'Selecting the picture setting (SMART PICTURE)', or 'Picture interference'.

The video recorder will not record:

- The TV channel you want to record is not stored or you selected the wrong programme number: check TV channels stored.
- You have loaded a cassette which cannot be recorded on: undo the erase protection on the cassette.

Programmed recording does not work:

- You have not set the TIMER properly: check the TIMER blocks.
- You have programmed the wrong time or date: check time and date.
- You have put in a cassette that cannot be recorded on: undo the erase protection on the cassette.
- After a 'programmed recording with 'VIDEO Plus+' the programme number of the TIMER block will not agree with the required programme number: when you have confirmed the PlusCode programming number, confirm the TIMER block by pressing the **TIMER** button. Then change the programme number displayed in the 'PROG.' entry field and confirm by pressing the **TIMER** button.

There is picture or sound interference on TV reception:

- Turn to chapter 8 and read 'Reducing picture disturbance ('optimizing the modulator') and 'Switching off the modulator'.
- Have your aerial checked.

10. GLOSSARY

Technical terms used

Current tape position : The part of the tape currently being played.

External source : A device connected via a socket (for example, scart socket) which is transmitting audio/video signals to the video recorder.

Index marking : A marking which is automatically made on the tape at the beginning of every recording. This marking (recording ID) can be searched for with the Index search function.

Scart cable : Also known as a Euro-AV cable. This standard cable is an easy method of connecting various audio and video devices, computer screens and televisions. Other signals in addition to audio and video signals can be transmitted on it.

TV system : There are various systems for transmitting television signals, for example, PAL, SECAM, PAL BG, SECAM DK, SECAM L/L, NTSC etc. The system used by your television depends on which country you are in.

TXT : Also known as Teletext, Fasttext, Videotext, FLOF etc.

OTR : One touch recording. This function enables you to select the switch-off time in intervals of 30 minutes.

Modulator : An electronic component in a video recorder which allows audio and video signals to be transmitted via the aerial cable. Your television receives the signal in the same way as a signal from a television station.

Modulator frequency : This frequency or channel indicates the frequency or channel on which the audio or video signal is transmitted.

UHF frequency range : Channels 21 to 69. The video recorder 'broadcasts' on channel 35/frequency 583 MHz. This frequency or channel can be changed. See the section 'Reducing picture disturbance ('optimizing the modulator').

OSD (On-screen display) : The largest possible display area for the video recorder - the screen on your television set.

Remote codes

Acura	02	GoldStar	15, 20, 27	Proline	31
Adyson	5, 20	Goodmans	07, 10, 20, 29, 36	Protech	02, 12, 20, 23, 25, 38
Akai	18, 33	Gorenje	35	Quelle	03, 04, 33
Akura	21, 25	Graetz	33	Questa	07
Alba	02, 07, 21	Granada	10, 18, 20	Rank Arena	07
Allorgan	28	Grandin	26	Rediffusion	33
Amplivision	20	Grundig	17	Rex	25
Amstrad	02	HCM	02, 26	Roadstar	02, 21, 25, 38
Anitech	02	Hanseatic	01, 30, 33	SEG	07, 20, 25
Arcam	19, 20	Hinari	02, 07, 21	SEI	12, 28
Asuka	21	Hisawa	26	Saba	15
Audiosonic	15	Hitachi	05, 07, 08, 13, 15, 20, 22	Saisho	02, 04, 25
BPL	26	HuanYu	19, 36	Salora	33
BSR	28	Hypson	25, 26	Sambers	12
BTC	21	ICE	20, 25	Samsung	01, 02, 20, 25, 27, 35
Basic Line	02, 21	ICeS	21	Sandra	19
Baur	03, 33	ITT	33	Sanyo	04, 07, 10, 18
Beko	35	Imperial	23, 35, 38	Schaub Lorenz	33
Binatone	20	Inno Hit	10	Schneider	21, 23, 37
Blaupunkt	17	Interfunk	23, 33	Sei-Sinudyne	03
Blue Sky	21	Intervision	12, 20, 25	Sentra	06
Blue Star	26	Isukai	21	Sharp	07, 11
Bondstec	23	JVC	07, 09	Shorai	28
Boots	20	Kaisui	02, 19, 20, 21, 26	Siarem	12
Brandt	15	Kathrein	01	Siemens	17
Britannia	19	Kingsley	19	Silver	07
Bush	02, 07, 21, 26, 28, 36	Koyoda	02	Sinudyne	12, 28
CGE	23	Leyco	10, 25, 28	Solavox	05
CS Electronics	19	Lloytron	05	Sonitron	18
CTC	23	Luxor	33	Sonoko	02
Carrefour	07	M Electronic	02, 13, 15, 20, 32, 36, 41	Sonolor	18
Cascade	02	Magnadyne	12, 23	Sony	03, 04, 07
Cimline	02	Magnafon	12	Soundwave	38
Clatronic	23, 35	Manesth	20, 25, 30	Standard	02, 20, 21
Condor	30, 35	Marantz	01	Sunkai	28, 31
Contec	02, 07, 19	Matsui	02, 04, 06, 07, 10, 18, 20, 28	Susumu	21
Crown	02, 35, 38	Memorex	02	Tandy	10, 20, 21
Cybertron	21	Metz	34	Tashiko	07, 20
Daewoo	02, 36	Mitsubishi	07, 14, 16	Tatung	10, 20
Dainichi	21	Mivar	19, 27	Tec	20, 23
Dayton	02	Multitech	02, 12, 19	Technema	30
De Graaf	18	Neckermann	01	Technics	24
Decca	10	Nikkai	05, 06, 10, 19, 21, 25	Telefunken	15
Dixi	02	Nobliko	12	Telemeister	30
		Nokia	33, 41	Teletech	02
Dual Tec	20	Nordmende	15	Teleton	20
Elite	21, 30	Oceanic	33	Tensai	21, 28, 29, 30
Elta	02	Orion	28, 30, 31	Texet	19, 21
Emerson	33	Osaki	05, 10, 20, 21, 25	Thomson	15
Ferguson	15	Oso	21	Thorn	06, 10, 33
Fidelity	19, 33	Osume	05, 10	Tomashi	26
Finlandia	18, 32	Otake	29	Toshiba	06, 07
Finlux	10, 13, 32	Otto Versand	01, 03, 07, 20, 30	Uher	30
Firstline	02, 19, 20, 23, 28, 31	Palladium	35, 38	Ultravox	12
Fisher	18, 20, 35	Panama	20, 25	Universum	13, 25, 32, 35
		Panasonic	24, 34	Videosat	23
Formenti	30	Pathe Cinema	19, 30	Videotechnic	20
Frontech	23, 25	Pausa	02	Visa	02
Fujitsu	10	Perdio	30	Vision	30
Funai	25, 28	Phase	05	Waltham	20
GEC	10, 20	Philco	23	Watson	30
GPM	21	Philips	01, 36	Watt Radio	12
Geloso	02	Pioneer	15	Wega	07
Genexxa	21	Profex	02, 33	White Westinghouse	19, 30
				Yoko	20, 25

VR860/07

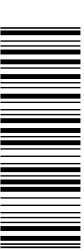

3103 166 22262
9185/010

Free Manuals Download Website

<http://myh66.com>

<http://usermanuals.us>

<http://www.somanuals.com>

<http://www.4manuals.cc>

<http://www.manual-lib.com>

<http://www.404manual.com>

<http://www.luxmanual.com>

<http://aubethermostatmanual.com>

Golf course search by state

<http://golfingnear.com>

Email search by domain

<http://emailbydomain.com>

Auto manuals search

<http://auto.somanuals.com>

TV manuals search

<http://tv.somanuals.com>