

**PHILIPS**

**NORELCO**

***Beard and  
Moustache  
Trimmer***



**T765**

**Rechargeable  
Cordless**

Register your product  
and get support at

[www.philips.com/norelco](http://www.philips.com/norelco)

# IMPORTANT SAFETY INSTRUCTIONS

When using an electrical appliance, basic safety precautions should always be followed, including the following:

**Read all instructions before using this appliance.**

## DANGER

**To reduce the risk of electric shock:**

1. Do not reach for a Trimmer that has fallen into water. Unplug immediately.
2. Do not use while bathing or in a shower.
3. Do not place or store Trimmer where it can fall or be pulled into a tub or sink. Do not place in or drop into water or other liquid.
4. Always unplug this Trimmer from the electrical outlet immediately after (re)charging.
5. Unplug Trimmer before cleaning.
6. When **discarding** Trimmer, unplug Trimmer to remove rechargeable battery. See Battery Removal instructions.

## WARNING

**To reduce the risk of burns, fire, electric shock or injury to persons:**

1. Close supervision is necessary when this appliance is used by, on, or near children or invalids.
2. Use this Trimmer for its intended household use as described in this manual. Do not use attachments not recommended by Philips Electronics North America Corporation.
3. Never operate this Trimmer if it has a damaged cord or plug, if it is not working properly, if it has been dropped, damaged, or dropped into water. For assistance call 1-800-243-3050.
4. Keep the Trimmer and cord away from heated surfaces.
5. Never drop or insert any object into any opening. Keep air openings free of lint, hair, etc.
6. Do not charge or plug in Trimmer outdoors or where aerosol (spray) products are being used or where oxygen is being administered.
7. Do not use this Trimmer with a damaged or broken cutter, as facial injury may occur.
8. Always attach plug to Trimmer first, then into outlet. To disconnect, turn ON/OFF switch to "OFF" position (switch is down), then remove plug from outlet.
9. To prevent possible damage to the cord, do not wrap cord around the Trimmer.
10. Never put Trimmer in direct sunlight or store in a pouch at a temperature above 140°F.
11. This Trimmer is for use on human facial hair only. Do not use this Trimmer for any other purpose.

# SAVE THESE INSTRUCTIONS

**IMPORTANT:** The power plug contains a transformer. Do not cut off the power plug to replace it with another plug as this will cause a hazardous condition.

**IMPORTANT: YOUR TRIMMER CONTAINS A NICKEL-CADMIUM RECHARGEABLE BATTERY.**

See Battery Removal Instructions.

## Put It To The Test

Like many new products, your Philips Norelco Trimmer may take a little getting used to. If you are using an electric Trimmer for the first time, or if you've been using a different brand, take the time to acquaint yourself with your new Trimmer.

Your Trimmer features the Patented AccuControl System combined with an adjustable Zoom Lock to make trimming facial hairs goof-proof.

Throw your scissors away and put your new Trimmer to the test. We guarantee precise, professional results or Philips Norelco will refund you the full purchase price, as long as the request is received within 45 days of purchase.

## AccuControl System

The Patented Philips Norelco AccuControl System puts you in complete control while trimming your facial hairs with no prior experience needed. The flexing Guide Comb adjusts automatically to hug the contours of your face for a trim that is both even and accurate. And, it's easy to maneuver over those hard-to-reach areas such as the throat and chin. The patented Zoom Lock Hair Length Selector allows you to choose among 9 preset hair lengths and locks into position so you can control the exact hair length you desire or vary the length of your facial hair. The Philips Norelco AccuControl System with Patented Zoom Lock Hair Length Selector for professional, goof-proof results every time or your money back.

## Charging

Charge the Trimmer fully before you start using it for the first time or after a long period of disuse. This Trimmer will not operate corded directly from the electric outlet.

## To Charge / Recharge

- ▶ (Re)charging requires 10 hours.
  - ▶ Use only the cord provided.
  - ▶ Battery performance is best if you recharge only when the battery is (almost) completely empty.
  - ▶ Charging or recharging at temperatures below 40°F or higher than 95°F adversely affects life time of battery.
  - ▶ Continuously recharging Trimmer will reduce life of battery.
- 1** Be certain Trimmer is OFF (fig. 1).
  - 2** Connect cord to Trimmer. Plug into any 120V AC outlet. Use only the cord provided (fig. 2).
    - ▶ An adaptor plug may be necessary for cord usage in some foreign countries. Use an attachment plug adaptor of the proper configuration for power outlet.

Do not charge Trimmer for more than 24 hours.

- 3** Green Charging Indicator Light on the adaptor will go on to indicate the Trimmer is charging (fig. 3).

It will take approximately 10 hours to fully charge the battery.

- 4** Disconnect the cord and unplug from electrical outlet.

## Optimize The Working Life Of The Battery

---

- ▶ After Trimmer has been charged for the first time, do not recharge Trimmer between trimming sessions. Continue using it until the battery is completely empty.
- ▶ Discharge the battery completely twice a year by letting the motor run until it stops.
- ▶ Do not charge for more than 24 hours.
- ▶ Do not keep cord permanently plugged in.
- ▶ If Trimmer hasn't been used for a long period of time, Trimmer must be recharged for 10 full hours.

## Cordless Trimming

- 1** Charge according to directions. Unplug Trimmer from outlet and remove cord.
- 2** Slide ON/OFF switch ON to begin trimming.
- 3** If the battery is empty and you want to trim your beard, charge the Trimmer for at least 90 minutes and you will have enough power for one use (10 minutes).

## Trimming

- ▶ Use this Trimmer for its intended household use as described in this manual.
- ▶ Always comb the beard and/or moustache with a fine comb before you start trimming.
- ▶ If you are trimming for the first time, be careful. Do not move the Trimmer too fast. Make smooth and gentle movements.

### Trimming with AccuControl Guide Comb Attachment

---

- ▶ Guide Comb Attachment must be on Trimmer in order to use the Zoom Lock.
- 1** Turn the Zoom Lock to the desired trimming length setting (see table). The setting will appear in the window below the Zoom Lock (fig. 4).
    - ▶ If you are trimming for the first time, start by using the maximum trimming length setting (#9) to prevent accidentally trimming hairs too short. As you become familiar with the settings, adjust Zoom Lock to desired trimming length. Zoom Lock will “click” into position at each setting.
  - 2** Switch the Trimmer ON.
  - 3** To trim in the most effective way, move the Trimmer against the direction of hair growth. Make sure the surface of the Guide Comb always stays in contact with the skin (fig. 5).

NOTE: Since all hairs do not grow in the same direction, you may want to try different trimming positions (i.e., upwards, downwards, or across). Practice is best for optimum results.

- 4** If cut hairs have accumulated in the Guide Comb, turn Trimmer off, remove the Comb Attachment and blow and/or shake the hair out of the comb. The selected trimming length setting will not change when you do this (fig. 6).

## Features

- A Patented AccuControl System with Removable Guide Comb Attachment
  - B Selected Hair Length Setting Window
  - C Precision Patented Zoom Lock with 9 Pre-select Settings
  - D 3-Dimensional Rounded Stainless Steel Cutter Blades
  - E On/Off Switch
  - F Cleaning Brush
- Charging Indicator Light on Adaptor  
Full Two-Year Warranty  
45-Day Money-Back Guarantee

## Trimming Length Settings Table

#1	Stubble Length or Closely Cropped	.06 in/1.5mm
#2	Short	.1 in/2.5mm
#3		.16 in/4mm
#4		.22 in/5.5mm
#5	Medium	.3 in/7.5mm
#6		.38 in/9.5mm
#7		.48 in/12mm
#8		.60 in/15mm
#9	Long	.72 in/18mm

## Trimming For “Stubble” Look

- 1** Be certain Guide Comb is on Trimmer and use setting #1 to result in a “stubble” look (fig. 7).

### Trimming Without Guide Comb Attachment

Remove Guide Comb Attachment if you are:

- ▶ Defining hair lines
- ▶ Trimming nape of neck
- ▶ Removing single, unwanted hairs

- 1** Be certain Trimmer is in the OFF position.
- 2** Remove the Guide Comb Attachment by pulling it off the Trimmer (fig. 8).

Never pull off the Guide Comb Attachment by grasping the flexible top portion. Always pull off by the bottom part of attachment.

- 3** Switch the Trimmer ON.
- 4** Make well-controlled movements. Touch the hair lightly with the Trimmer (fig. 9).

## Replacing Guide Comb Attachment On Trimmer

---

- 1** Be certain Trimmer is in OFF position.
- 2** Replace Guide Comb Attachment until it “clicks” into position. The Guide Comb Attachment can be placed on Trimmer only one way. If it does not fit properly, reverse it.

NOTE: The Zoom Lock can be on any setting when removing or replacing Attachment.

### Cleaning

- ▶ Always switch Trimmer OFF before cleaning.
- ▶ Do not use abrasives, scourers or liquids such as alcohol, benzene, bleach or acetone to clean the Trimmer.
- ▶ Never clean, remove or replace Guide Comb Attachment with motor ON.
- ▶ Do not apply pressure to cutters.
- ▶ Do not touch cutters with hard objects as this may damage them.
- ▶ Do not use while bathing, showering or immerse the Trimmer in water or other liquids as damage to Trimmer may occur.

### During Use:

---

- ▶ If cut hairs have accumulated in the Guide Comb area, turn Trimmer off, pull Guide Comb Attachment off Trimmer and remove hairs by shaking and/or blowing.

### Once A Week:

---

- 1** Make sure the Trimmer is switched OFF and disconnected from the electrical outlet.
- 2** Remove the Guide Comb Attachment.
- 3** Open the cutting unit (fig. 10).
- 4** Clean the cutting unit and the inside of the Trimmer with the brush supplied (fig. 11).
- 5** Close the cutting unit by pushing it back into place on the Trimmer until you hear a click (fig. 12).

# Features

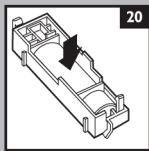
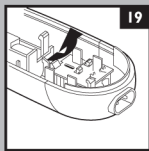
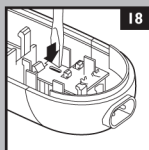
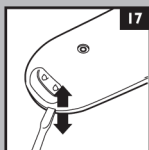
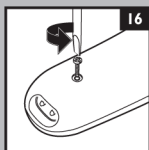
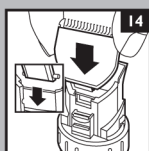
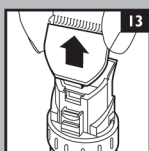
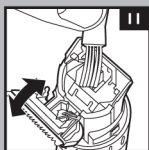
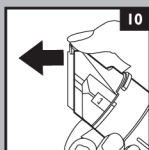
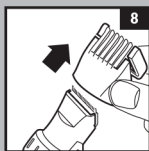
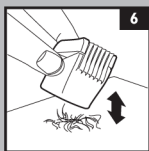
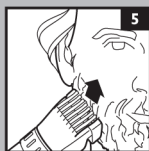
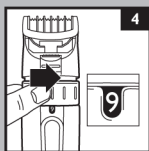
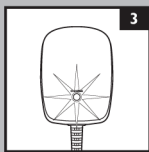
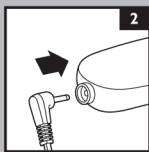
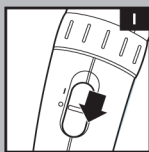
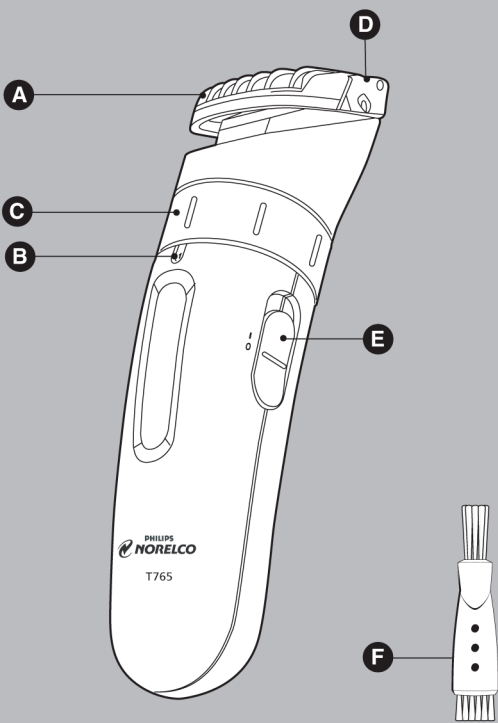



## Replacing The Cutting Unit

If your cutters become damaged or worn, do not continue using the Trimmer. Replace cutters immediately.

- 1** Open the cutting unit.
- 2** Remove the old cutting unit by pulling it upwards (fig. 13).
- 3** Place the two notches of the new cutting unit into the guiding slots (fig. 14).
- 4** Push the cutting unit back onto the Trimmer until you hear a 'click'.

This Trimmer has no other user-serviceable parts. For assistance call 1-800-243-3050.

## Storage

- ▶ Be sure Trimmer is turned off and remove cord from outlet and Trimmer before storing in a safe, dry location where it will not be crushed, banged, or subject to damage.
- ▶ Do not wrap cord around Trimmer when storing.
- ▶ Store cord in a safe location where it will not be cut or damaged.
- ▶ Do not place or store Trimmer where it can fall or be pulled into a tub or sink, water or other liquid.

## Assistance

For assistance, call toll free:

**1-800-243-3050**

**or visit our website:**

**[www.philips.com/norelco](http://www.philips.com/norelco)**

Information is available 24 hours a day, 7 days a week.

## Battery Removal

- ▶ This Philips Norelco Trimmer contains rechargeable Nickel-Cadmium batteries, which must be recycled or disposed of properly (fig. 15).
- ▶ Batteries should only be removed when Trimmer is to be discarded.
- ▶ For assistance, call toll free: 1-800-243-3050 or visit our website: [www.philips.com/norelco](http://www.philips.com/norelco).

- 1** Unplug electrical cord from outlet and Trimmer before dismantling Trimmer.
- 2** Allow the Trimmer to run until the battery is empty/depleted.
- 3** Turn Trimmer OFF.
- 4** Unscrew the screw on the back of the trimmer (fig. 16).

Note: You may use a narrow flat blade screwdriver.

- 5** Separate the 2 housing parts with a screwdriver (fig. 17).
- 6** Insert screwdriver in small slot on the circuit board, marked with an arrow (fig. 18). Push screwdriver down until parts of the printed circuit board break off.
- 7** Press the hook and remove the battery-holder including the rechargeable battery (fig. 19).
- 8** Separate the rechargeable battery from the battery holder using a screwdriver (Fig. 20).
- 9** Remove battery. Do not attempt to replace battery. Insulate battery ends by covering with tape and/or place battery in a small plastic bag.
- 10** Discard your Trimmer. Do not attempt to plug electrical cord into the outlet or recharge the Trimmer after the battery has been removed.

- 11** Contact your local town or city officials for battery disposal information or call

**1-800-8-BATTERY** or [www.rbrbc.com](http://www.rbrbc.com) for

battery drop-off locations.

## Full Two-Year Warranty

Philips Electronics North America Corporation warrants each new Philips Norelco product, Model T765 against defects in materials or workmanship for a period of two years (cutters for up to four years) from the date of purchase, and agrees to repair or replace any defective product without charge.

**IMPORTANT:** This warranty does not cover damage resulting from accident, misuse or abuse, lack of reasonable care, the affixing of any attachment not provided with the product or loss of parts or subjecting the product to any but the specific voltage.\* Use of unauthorized replacement parts will void this warranty.

**PHILIPS ELECTRONICS NORTH AMERICA CORPORATION WILL NOT PAY FOR WARRANTY SERVICE PERFORMED BY A NON-AUTHORIZED REPAIR SERVICE AND WILL NOT REIMBURSE THE CONSUMER FOR DAMAGE RESULTING FROM WARRANTY SERVICE PERFORMED BY A NON-AUTHORIZED REPAIR SERVICE.**

**NO RESPONSIBILITY IS ASSUMED FOR ANY SPECIAL, INCIDENTAL OR CONSEQUENTIAL DAMAGES.**

In order to obtain warranty service, simply go to [www.philips.com/norelco](http://www.philips.com/norelco) or call 1-800-243-3050 for assistance. It is suggested that for your protection you return shipments of product by insured mail, insurance prepaid. Damage occurring during shipment is not covered by this warranty. **NOTE:** No other warranty, written or oral, is authorized by Philips Electronics North America Corporation. This warranty gives you specific legal rights, and you may also have other rights which vary from state to state. Some states do not allow the exclusion or limitation of incidental or consequential damages, so the above exclusion and limitations may not apply to you.

\*Read enclosed instructions carefully.

Manufactured for: Philips Consumer Lifestyle  
A Division of Philips Electronics North America Corporation  
1600 Summer Street - 5th Floor, Stamford, CT 06905-5125



This symbol on the product's nameplate means it is LISTED listed by Underwriters Laboratories, Inc.

Norelco is a Registered Trademark of Philips Electronics North America Corporation.

AccuControl and Zoom Lock are Trademarks of Philips Electronics North America Corporation.

PHILIPS is a Registered Trademark of Koninklijke Philips Electronics N.V.

© 2008 Philips Electronics North America Corporation. All Rights Reserved.



## Registration

Congratulations on your purchase and welcome to Philips Norelco!

To fully benefit from the support that Philips Norelco offers, register your product at

[www.philips.com/norelco](http://www.philips.com/norelco). All Manuals Search And Download from [www.Son manuals.com](http://www.Son manuals.com)

**PHILIPS****NORELCO**

## **45-DAY MONEY-BACK GUARANTEE**

If you are not fully satisfied with your Philips Norelco Beard and Moustache Trimmer, send the product back and we'll refund you the full purchase price.

***The Trimmer must be shipped prepaid by insured mail, insurance prepaid, and have the original sales receipt, indicating purchase price and the date of purchase, enclosed. We cannot be responsible for lost mail. The Trimmer must be postmarked no later than 45 days after the date of purchase. Philips Norelco reserves the right to verify the purchase price of the Trimmer and limit refunds not to exceed suggested retail price.***

To obtain Money-Back Guarantee Return Authorization Form, call 1-800-243-3050 for assistance. Please allow 4-6 weeks for delivery of check.

## Free Manuals Download Website

<http://myh66.com>

<http://usermanuals.us>

<http://www.somanuals.com>

<http://www.4manuals.cc>

<http://www.manual-lib.com>

<http://www.404manual.com>

<http://www.luxmanual.com>

<http://aubethermostatmanual.com>

Golf course search by state

<http://golfingnear.com>

Email search by domain

<http://emailbydomain.com>

Auto manuals search

<http://auto.somanuals.com>

TV manuals search

<http://tv.somanuals.com>