

LaserMFD

LFF 6050



GB User Manual

PHILIPS

Dear customer

For your security and comfort, we urge you to carefully read the chapter **Security** before attempting use.

In buying this multifunction machine, you have opted for a quality Philips product. Your device satisfies all of the different needs of a modern office automation tool.

This machine allows you to scan in colour, to fax, print and copy in black and white. You can connect the multifunction device to your PC (Microsoft Windows 2000/XP/Vista).

Install the software included to use the multifunction device as a printer. Besides, you can scan, edit and save documents through your PC. If you have a WLAN adaptor (optional) you can communicate with a personal computer wirelessly.

WLAN is an optional working only with a specific adaptor that you can obtain from your retailer. You will find further information on our website: www.sagem-communications.com.

The multifunction machine lets you connect a USB-DECT base to one of the USB ports of the device and register DECT handsets to this base. You can then make and receive calls with the registered DECT handsets using the multifunction machine telephone line (standard cordless telephone use).

Voice communication is an optional working only with a specific USB DECT dongle that you can obtain from your retailer. You will find further information on our website: www.sagem-communications.com.

Thanks to its navigator and its multitask access, it is powerful, user-friendly and easy to use.

The LFF6050 multifunction machines come with a 600 dpi scanner and a black and white laser printer offering a printing speed of 20 ppm. The Companion Suite Pro software provided allows you to use your multifunction machine as a scanner and a printer from a personal computer. It also gives you the ability to manage your multifunction machine.

Consumables

Refer to section **Specifications**, page 79.

Contents

Dear customer	1		
Consumables	1		
Security	1	Copy	19
Security directives	1	Simple copy	19
EMC	1	ECO mode copy	19
Note to users in the United States of America	1	Advanced copying	19
Declaration of Conformity	1	ID Card Copy mode	20
EME Compliance for Canada	2	Special setup for the copying	20
Laser Safety Information	2	Resolution setup	20
For Europe/Asia	2	Zoom setup	21
For North America	2	Collated copy setup	21
Positions of Safety labels on the machine	3	Analysis origin setup	21
Symbols for the main power switch	3	Contrast setup	21
Regulatory Information	4	Brightness setup	21
Certifications in Europe	4	Paper type setup	21
CE Marking Traceability Information (For EU Countries Only)	4	Paper tray selection	22
		Sheet-feed analysis margins setup	22
		Flat-bed analysis margins setup	22
		Left and right printing margins setup	22
		Top and bottom printing margins setup	22
		Format paper setup	22
Environment	5	Fax	23
The packaging	5	Fax transmission	23
Batteries and rechargeable batteries	5	Print a header page	23
The product	5	Immediate transmission	23
		Delayed transmission	23
		Transmission with auto redial	24
Software use license	6	Fax reception	24
Definition	6	Relay broadcast	24
License	6	Fax answering machine	25
Property	6	Saving an access code	25
Duration	6	Activating / Deactivating the answering machine	25
Warranty	6	Printing fax messages stored in the memory	25
Responsibility	6	Fax rerouting	25
Development	6	Activating rerouting	25
Applicable law	7	Setting the re-direction contact	26
Registered trademarks	7	Printing rerouted documents	26
Prohibited reproductions	7	Rerouting fax messages to a USB memory key	26
		Activating rerouting	26
		Printing rerouted documents	26
Installation	8	Transmission waiting queue	26
Location conditions	8	Performing immediate transmission from the waiting queue	26
Cautions of use	8	Consulting or modifying the waiting queue	27
Safety information	9	Deleting a transmission on hold	27
Safety During Operation	9	Printing a document in waiting or in deposit	27
Power Supply	10	Printing the waiting queue	27
For Fax or Telephone	10	Cancelling a transmission in progress	27
Paper recommendations	10	MailBoxes (MBX Fax)	27
Loading paper in the main unit tray	10	Creating an MBX	27
Handling of paper	10	Modifying the features of a MBX	28
Humidity control	10	Printing the contents of a MBX	28
Handling the unit	10	Deleting a MBX	28
Operator shocks	10	Printing the MBX list	28
Moving the unit	10	MBX deposit in your fax	28
Handling the Toner Cartridge	10	MBX deposit in a remote fax	28
Rules for use symbols	11		
Terminal description	12		
Command panel	13		
Accessing terminal menus	13		
Packaging contents	14		
Device installation	14		
Installing the document feeder	14		
Feed cassette paper insertion	14		
Cartridge installation	15		
Paper delivery stop	16		

<i>MBX polling from a remote fax</i>	28	<i>Connect your WLAN adaptor</i>	43
<i>Deposit and Polling</i>	29	<i>Configure your network</i>	43
<i>Placing a document in deposit</i>	29	<i>Creating or rejoining a network</i>	43
<i>Polling a deposited document</i>	29	<i>Referring to or changing your network parameters</i>	44
SMS	30	<i>An example of how an AD-HOC network may be set up</i>	45
<i>SMS Parameters</i>	30	<i>Setting up a multifunction machine</i>	45
<i>Presentation of the sender</i>	30	<i>Setting up the PC</i>	46
<i>SMS Center transmission number</i>	30	USB memory key	47
<i>Sending an SMS</i>	30	<i>Use of the USB memory key</i>	47
Parameters/Setup	31	<i>Print your documents</i>	47
<i>Date/Time</i>	31	Print the list of files located in the key	47
<i>Summer time / Winter time setting</i>	31	Print the files located in the key	47
<i>Your fax number/Your name</i>	31	<i>Delete your files located in the key</i>	48
<i>Type of network</i>	32	<i>Analyse the USB memory key content</i>	48
<i>Geographical settings</i>	32	<i>Save a document on a USB memory key</i>	48
<i>Country</i>	32	Telephony (option)	50
<i>Telecommunication Network</i>	32	<i>Connecting the USB-DECT base</i>	50
<i>Language</i>	32	<i>Registering DECT handsets</i>	50
<i>Local prefix</i>	32	<i>Customising telephony settings</i>	51
<i>Transmission report</i>	33	<i>Modifying the flash duration (R key)</i>	51
<i>Document feed type</i>	33	<i>Unregistering DECT handset</i>	51
<i>Economy period</i>	33	PC Features	52
<i>Reception Mode</i>	34	<i>Introduction</i>	52
<i>Reception without paper</i>	34	<i>Configuration requirements</i>	52
<i>Number of copies</i>	34	<i>Software installation</i>	52
<i>Fax or PC reception</i>	34	<i>Installing the full software package</i>	52
<i>Adjust to page</i>	35	<i>Installing drivers only</i>	54
<i>Received faxes reduction mode</i>	35	<i>Installing the drivers using the Companion Suite Pro software</i>	54
<i>Technical Parameters</i>	35	<i>Installing the drivers manually</i>	55
<i>Printing the functions guide</i>	36	<i>Connections</i>	56
<i>Printing the logs</i>	36	<i>Multifunction Terminal's Supervision</i>	57
<i>Print the list of setups</i>	37	<i>Checking the connection between the PC and the multifunction machine</i>	57
<i>Lock the machine</i>	37	<i>Companion Director</i>	57
<i>Lock the keyboard</i>	37	<i>Graphical presentation</i>	57
<i>Lock the numbers</i>	37	<i>Utilities and applications activation</i>	57
<i>Lock the SMS service</i>	37	<i>Companion Monitor</i>	57
<i>Lock the Media service</i>	37	<i>Graphical presentation</i>	57
<i>Read the counters</i>	37	<i>Device management</i>	57
<i>Sent pages counter</i>	37	<i>Selecting the current device</i>	57
<i>Received pages counter</i>	38	<i>Status of the connection</i>	58
<i>Scanned pages counter</i>	38	<i>Device parameters</i>	58
<i>Printed pages counter</i>	38	<i>Removing a device</i>	58
<i>Display the consumables status</i>	38	<i>Display the consumable status</i>	58
<i>Calibrate your scanner</i>	38	<i>Companion Suite Pro functionalities</i>	59
Directory	39	<i>Document analysis</i>	59
<i>Creating subscribers record</i>	39	<i>Analysis with Scan To</i>	59
<i>Creating subscribers list</i>	39	<i>Character recognition software (OCR)</i>	59
<i>Modifying a record</i>	39	<i>Printing</i>	60
<i>Deleting a record or a list</i>	39	<i>Printing on the multifunction machine</i>	60
<i>Printing the directory</i>	40	<i>Printing in duplex mode with the multifunction machine</i>	60
<i>Saving/Restoring the directory (Smart card option)</i>	40	<i>Address book</i>	61
Games and Calendar	41	<i>Add a contact to the terminal address book</i>	61
<i>Sudoku</i>	41	<i>Add a group to the terminal address book</i>	61
<i>Print a grid</i>	41	<i>Manage the address book</i>	62
<i>Print the solution to a grid</i>	41	<i>Modify the information related to a contact</i>	62
<i>Calendar</i>	41	<i>Modify a group</i>	62
Network features	42		
<i>Type of radio network</i>	42		
<i>Radio infrastructure network</i>	42		
<i>Radio ad-hoc network</i>	42		
<i>Radio networks (WLAN)</i>	42		

Delete a contact or a group from the address book	62	Specifications	79	Contents
Print the address book	62	<i>Physical specifications</i>	79	
<i>Import or export an address book</i>	62	<i>Electrical specifications</i>	79	
Save / Export your address book	62	<i>Environmental specifications</i>	79	
Import an address book	62	<i>Peripheral specifications</i>	79	
Fax communications	63	<i>Consumable specifications</i>	80	
<i>Presentation of the Fax window</i>	63			
<i>Send a fax</i>	63			
Send a fax from the hard disk or the terminal	63			
Send a fax from an application	64			
<i>Receive a fax</i>	64			
<i>Follow-up of fax communications</i>	64			
The outbox	64			
The send memory (items sent)	65			
The outbox log	65			
The inbox log	65			
Fax parameters	65			
Access to fax parameters	65			
Description of the tab Logs and Reports	65			
Description of the tab Fax Parameters	66			
Cover page	66			
Creating a cover page template	66			
Creating a cover page	68			
Description of the tab Cover page	69			
SMS Communications	69			
<i>Presentation of the SMS window</i>	69			
<i>Send an SMS</i>	70			
<i>Follow-up of SMS</i>	70			
The outbox	70			
The outbox log	70			
The sent item memory (items sent)	71			
SMS Parameters	71			
Access to SMS parameters	71			
Description of the tab Logs and reports	71			
Software Uninstallation	71			
<i>Uninstall the software from your PC</i>	71			
<i>Uninstall the drivers from your PC</i>	71			
Uninstall the drivers using the Companion Suite Pro software	72			
Uninstall the drivers manually	72			
Maintenance	73			
Service	73			
<i>General information</i>	73			
<i>Toner cartridge replacement</i>	73			
<i>Issues with smart cards</i>	74			
Cleaning	74			
<i>Scanner reading system cleaning</i>	74			
Printer cleaning	74			
<i>Printer external cleaning</i>	74			
<i>Document-feeder roller cleaning</i>	74			
Printer issues	75			
<i>Error messages</i>	75			
Paper jam	75			
Scanner issues	76			
Miscellaneous issues	76			
Communication errors	76			
<i>Transmission from the feeder</i>	76			
<i>Transmission from memory</i>	76			
<i>Communication error codes</i>	76			
<i>General codes</i>	76			
PC printing issues	77			
<i>PC printing via USB connection</i>	77			
<i>PC printing via WLAN connection</i>	78			
Firmware update	78			

Security

Security directives

Before turning on your device, check that the outlet that you are going to plug it into conforms to the indications shown on the information plate (voltage, current, power network frequency) located on your device. This device shall be connected to a single phase power network. The device shall not be installed on bare ground.

Batteries and rechargeable batteries, packaging and electric and electronic equipment (EEE), shall be thrown away, as specified by the Instructions of the ENVIRONMENT chapter of this manual.

Because of the device model, the power connector is the only way to disconnecting the device from the power network, that is why it is imperative to apply the following safety measures: your device shall be connected to a power outlet located nearby. The outlet shall be easily accessible.

Your device is delivered with a grounded power cord. It is imperative to connect a grounded connector to a grounded outlet connected to the building earthing.

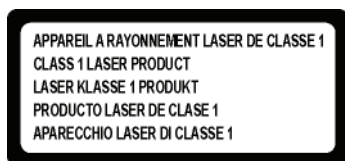

Repairs-maintenance: Repairs and maintenance should only be carried out by a qualified technician. No user serviceable parts inside the machine. To reduce the risk of electrical shock, you shall not proceed with these operations yourself, because by opening or removing the lids, you could expose yourself to two hazards:

- The laser beam can cause irreversible eye damage.
- Avoid contact with powered parts because it can lead to electrical shock with unfortunate consequences.

For installation conditions and safe use precautions, refer to chapter **Installation**, page 8.

EMC

Note to users in the United States of America

This equipment has been tested and found to comply with the limits for a Class B digital device, pursuant to Part 15 of the FCC Rules. These limits are designed to provide reasonable protection against harmful interference in a residential installation.

This equipment generates, uses and can radiate radio frequency energy and, if not installed and used in accordance with the instructions, may cause harmful interference to radio communications. However, there is no guarantee that interference will not occur in a particular installation.

If this equipment does cause harmful interference to radio or television reception, which can be determined by turning the equipment off and on, the user is encouraged to try to correct the interference by one more of the following measures:

1. Reorient or relocate the receiving antenna.
2. Increase the separation between the equipment and receiver.
3. Connect the equipment into an outlet on a circuit different from that to which the receiver is connected.
4. Consult the dealer or an experienced radio / TV technician for help.

Declaration of Conformity

This device complies with Part 15 of the FCC Rules. Operation is subject to the following two conditions:

1. This device may not cause harmful interference, and
2. this device must accept any interference received, including interference that may cause undesired operation.

EME Compliance for Canada

This Class "B" digital apparatus complies with Canadian ICES-003.

Cet appareil numérique de la classe "B" est conforme à la norme NMB-003 du Canada.

Laser Safety Information

CAUTION: Use of controls, adjustments, or performance of procedures other than those specified in this guide may result in hazardous light exposure.

This equipment complies with international safety standards and is classified as a Class 1 Laser Product.

With specific reference to lasers, the equipment complies with laser product performance standards set by governmental, national, and international agencies as a Class 1 Laser Product. It does not emit hazardous light, as the beam is totally enclosed during all phases of customer operation and maintenance.

For Europe/Asia

This machine complies with IEC 60825-1:1993+A1:1997+A2:2001 standard, is classified as laser class 1 product and is safe for office/EDP use. It contains one class 3B laser diode, 10.72 mW max, 770-795 nm and other class 1 LEDs (280 μ W at 639 nm).

Direct (or indirect reflected) eye contact with the laser beam might cause serious eye damage. Safety precautions and interlock mechanisms have been designed to prevent any possible laser beam exposure to the operator.

For North America

CDRH Regulations.

This equipment complies with the FDA performance standards for laser products except for deviations pursuant to Laser Notice No.50, dated 24 June 2007 and contains 1 class 3B laser diode, 10.72 milliwatt, 770-795 nanometer wavelength and other class 1 LEDs (280 μ W at 639 nm).

This equipment does not emit hazardous light, since the beam is totally enclosed during all customer modes of operation and maintenance.

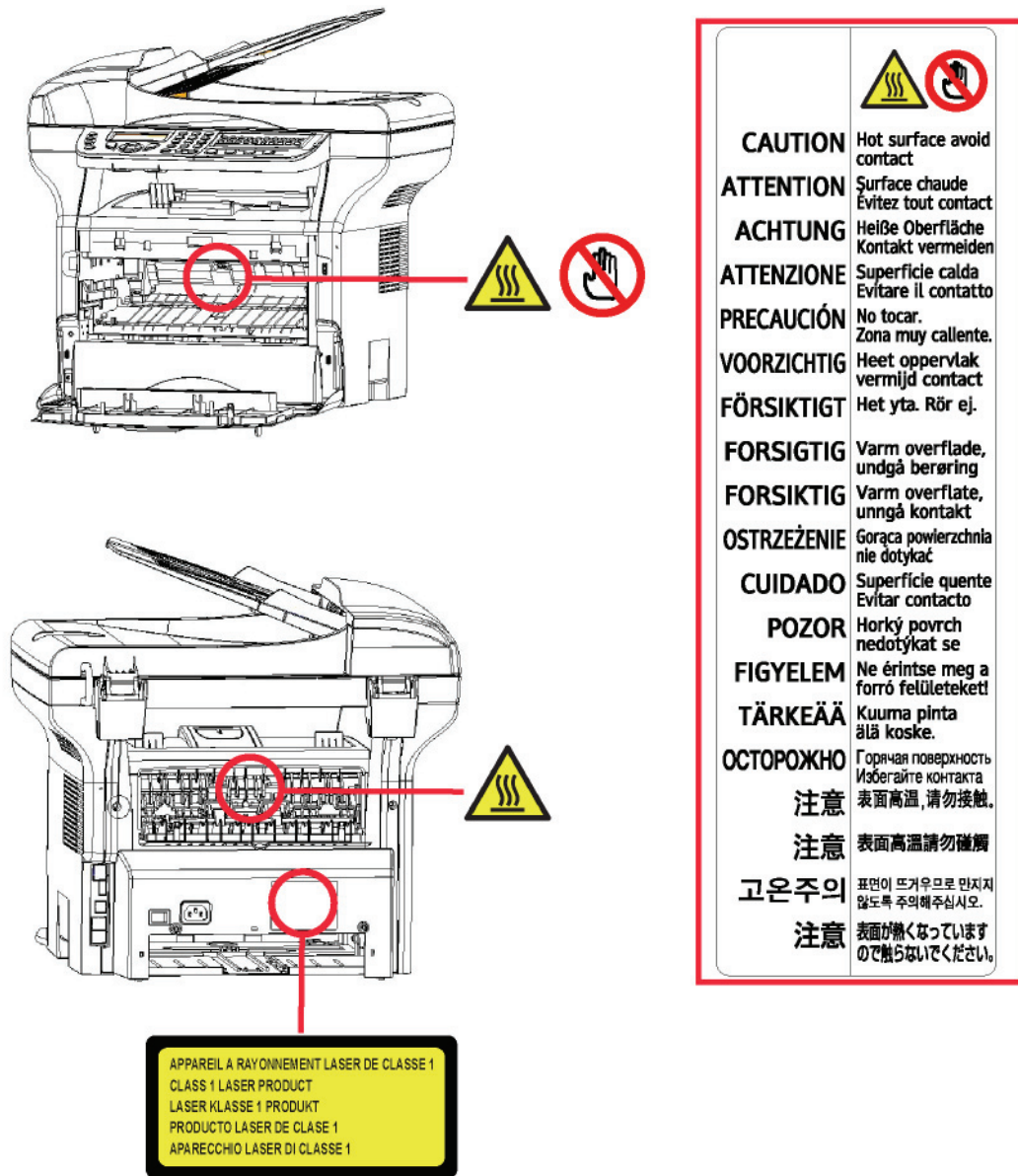

Positions of Safety labels on the machine

The device has warning labels at the positions shown below. For your safety, you must never touch these surfaces when you remove a paper jam or when you replace the Toner cartridge.



Symbols for the main power switch

In accordance with IEC 60417, this machine uses the following symbols for the main power switch:

-  means POWER ON.
-  means POWER OFF.

Regulatory Information

Certifications in Europe

CE The CE mark applied to this product, symbolizes Sagem Communications SAS (hereafter designated as Sagem Communications)'s declaration of conformity with the following applicable European Union Directives, as of the dates indicated:

December 12, 2006: Council Directive 2006/95/EC as amended. Approximation of the laws of the member states related to low voltage equipment.

December 15, 2004: Council Directive 2004/108/EC as amended. Approximation of the laws of the member states related to electromagnetic compatibility.

March 9, 1999: Council Directive 99/5/EC, on radio equipment and telecommunications terminal equipment and the mutual recognition of the conformity.

The conformity declaration is available on www.sagem-communications.com, see the support section or at the following address:

Sagem Communications - Customer relations department
27, rue Leblanc - 75512 PARIS CEDEX 15 - France

CE Marking Traceability Information (For EU Countries Only)

Manufacturer:

Sagem Communications
Le Ponant de Paris
27 rue Leblanc
75015 PARIS - FRANCE

Environment

The preservation of the environment is of importance to the manufacturer. The manufacturer wishes to service the installations with respect to the environment and has chosen to integrate the environmental performance in the whole lifecycle of its products, throughout manufacturing, release, use and disposal.

The packaging



The (green point) logo indicates that a contribution is given to an approved national organization to improve the packaging salvage and recycling infrastructures.

To make recycling easier, follow local rules and regulations concerning sorting and disposal of such waste.

Batteries and rechargeable batteries

If your product contains batteries or rechargeable batteries, these shall be disposed of at the designated collecting centers.

The product



The crossed bin symbol on the product indicates that it belongs to the electric and electronic equipment family.

Therefore, according to European regulations you are requested to dispose of it at the selected collection areas:

- to distribution centers in case of equivalent equipment purchase,
- to the available local collecting centers (dump, selective collection, etc.).

In doing so, you will participate in the "Waste of Electric and Electronic Equipment reuse and development scheme" which will help prevent potential effects on the environment and human health.



The purpose of the International ENERGY STAR® Program is to promote the development and popularization of energy-efficient office equipment.

As an ENERGY STAR® Partner, Sagem Communications has determined that this product meets the ENERGY STAR® guidelines for energy efficiency.

Your machine will be delivered with the timer for switching to Power Save Mode from the last copy/print out, set at 5 or 15 minutes, depending on the model. A more detailed description of this feature can be found in the Machine Setup Section of this guide.

Software use license

CAREFULLY READ ALL THE TERMS AND CONDITIONS OF THE PRESENT LICENSE BEFORE OPENING THE SEALED ENVELOPE CONTAINING THE SOFTWARE. OPENING THIS ENVELOPE INDICATES THAT YOU ACCEPT THESE TERMS AND CONDITIONS.

In case you should not accept the terms of this license, the CD-ROM packaging should be returned to the retailer unopened, along with the other components of the product. The purchase price of this product will be refunded. No refunds will be made for products if the CD-ROM packaging have been opened, if components are missing or if the reimbursement request is made after ten (10) days from the purchase date, your receipt is the proof of purchase.

Definition

The Software designates programs and associated documentation.

License

- This license allows you to use this Software on personal computers on a local network. You only have permission to use this Software to print on one multifunction machine; you can not lend the Software or authorize anyone to use it.
- You are allowed to make a back up copy.
- This license is non-exclusive and non-transferable.

Property

The manufacturer or its providers hold the Software property right. You only become the owner of the CD-ROM. You shall not modify, adapt, decompile, translate, create any derived piece, rent or sell the Software or the documentation. Any rights not explicitly approved are reserved by the manufacturer or its providers.

Duration

This license remains valid until cancelled. You can cancel it by destroying the program and the documentation as well as any other copies of them. This license will automatically be canceled in case you do not respect the terms of this license. If the license is rendered invalid, you agree to destroy all copies of the program and the associate documentation.

Warranty

The Software is provided "as is" with no warranties what so ever, whether expressed or implied, including without limitation, any warranties of merchantability or fitness for a particular purpose; all the risks concerning the results and performance of this Software are assumed by the buyer. In case the program should appear defective, all the repair and service expenses will be covered by the buyer.

Nevertheless, the license holder benefits from the following warranty: we guarantee that the CD-ROM on which the Software is recorded is free from hardware or manufacturing faults if used in normal conditions, the guarantee is valid for ninety (90) days from the delivery date, the copy of the receipt being the proof of purchase. In case of a CD-ROM fault that due to accident or misuse, the CD-ROM will not be replaced as per the warranty.

Responsibility

If the CD-ROM is not working properly, send it to the retailer together with a copy of the receipt. It is the retailer's sole responsibility to replace the CD-ROM. Nobody, not even the manufacturer who is involved in the creation, realization, merchantability and delivery of this program would be responsible for direct, indirect or immaterial damages, such as, but not limited to, loss of information, loss of time, execution loss, loss of revenue, loss of customers, due to the use or inability to use the program.

Development

With a constant concern for improvement, the manufacturer reserves the right to modify the Software specifications without any notice. In case of modification, your user right does not give you access to free updates.

Applicable law

This license is under the French law. Any dispute following the interpretation or execution of this license will be submitted to the Paris Court.

Given the continuous technology development, the manufacturer reserves the right to modify the technical specifications indicated for this product, at any time, without prior notice, and/or to stop manufacturing of the product. All the names of the products and brands that could be trademarks registered by their respective owners are recognized in the present document.

Registered trademarks

Given the technical evolution, Sagem Communications reserves the right to modify the technical specifications of this product and/or to stop its manufacturing at any time and without notice. Companion Suite Pro is a registered trademark of Sagem Communications.

Adobe® and the Adobe® products referred to here are registered trademarks of Adobe Systems Incorporated.

PaperPort11SE is a registered trademark of ScanSoft.

Microsoft® Windows 2000®, Microsoft® Windows Server 2003®, Microsoft® Windows XP®, Microsoft® Windows Vista® and any other Microsoft® product referred to here are registered trademarks of Microsoft Corporation registered and/or used in the United States and/or in other countries.

All the other brands or products referred to as examples or in order to give additional information are registered trademarks of their respective owners.

The informations contents of this user manual are subject to change without notice.

Prohibited reproductions

Do not copy or print any item for which reproduction is prohibited by law.

Copying or printing the following items is generally prohibited by local law:

- bank notes;
- checks;
- bonds;
- stock certificates;
- bank drafts;
- passports;
- driver's licenses.

The preceding list is meant as a guide only and is not inclusive. If you have any questions concerning the legality of copying or printing certain items, consult with your legal advisor.

Installation

Location conditions

By choosing an appropriate location, you preserve the longevity of the machine. Check that the selected location has the following characteristics:

- Choose a well ventilated location.
- Make sure not to obstruct the ventilation grids located on the left and right sides of the device. During the installation, make sure to place the machine thirty centimeters away from the surrounding objects so all the lids can be easily opened.
- Make sure that this location does not present any ammonia nor any other organic gasses emission hazard.
- The ground outlet (refer to the security notices presented in the **Security** chapter) to which you plan to connect the machine must be located close to this one and have an easy access.
- **Make sure that the machine is not directly exposed to sun light.**
- Make sure not to place the machine in an area exposed to an air flow generated by an air conditioning, heating or ventilation system, nor in an area subject to large temperature or humidity variations.
- Choose a solid and horizontal surface on which the machine will not be exposed to intense vibrations.
- **Keep the machine away from any object that could obstruct its ventilation ports.**
- Do not place the machine close to hangings or any other flammable objects.
- Choose a location where splashes of the water and other liquids are limited.
- Make sure that this location is dry, clean and dust free.

Cautions of use

Take into account the important precautions below when using the machine.

Running environment:

- Temperature: 10 °C to 27 °C [50 °F to 80.6 °F] with an ambient humidity included between 15 to 80% (up to 32°C [89.6 °F] with an ambient humidity included between 15 to 54%).

Terminal:

The section below describes the precautions to be taken when using the machine:

- Never turn the machine off and never open the lids while printing.
- Never use gas or flammable liquids, or objects generating magnetic field close to the machine.
- When you unplug the power cord, always hold the connector without pulling the cord. A damaged cord presents a potential fire hazard or an electric shock hazard.
- Never touch the power cord with wet hands. You risk getting an electric shock.
- Always unplug the power cord before moving the machine. Otherwise, you could risk having the cord damaged and create a fire hazard or an electric shock hazard.
- Always unplug the power cord when you plan not to use the machine for a long period of time.
- Never put objects on the power cord, never pull it and never fold it. This could cause a fire hazard or an electric shock hazard.
- Always make sure that the machine is not sitting on the power cord or any other electric device communication cables. Make sure also that neither cord nor cable is introduced to the machine inner mechanism. This would expose you to a machine malfunction risk or to a fire hazard.
- Make sure that the printer is unplugged from the power outlet before connecting or disconnecting an interface cable to the printer (use a shielded interface cable).
- Never try to remove any fixed pane or hood. The machine contains high voltage circuits. Any contact with these circuits can cause an electric shock risk.
- Never try to modify the machine. This could cause a fire hazard or an electric shock hazard.
- Always make sure that paper clips, staples or other small metallic items do not get inside the machine via the ventilation ports or other ports. Such items create fire hazards or electric shock hazards.
- Prevent water and any other liquid from spilling on the machine or near to it. Any contact of the machine with water or liquid can cause a fire hazard or an electric shock hazard.

- If liquid or metallic item gets accidentally inside the machine, turn it off immediately, unplug the power cord and contact your retailer. Otherwise, you will face a fire hazard or an electric shock hazard.
- In case of heat, smoke, unusual smell or abnormal noise emissions, turn the machine off, unplug the power cord immediately and contact your retailer. Otherwise, you will face a fire hazard or an electric shock hazard.
- Avoid using the machine during an "electric storm", this can cause an electric shock hazard due to lightning.
- Never move the terminal during printing.
- Always lift the terminal when you wish to move it.





Make sure to place the machine in well ventilated premises. When in operation, the printer generates a small amount of ozone. An unpleasant smell can come from the printer if it is used intensively in poorly ventilated premises. For a secure use, make sure you place the machine in well ventilated premises.

Safety information

When using your product, the following safety precautions should always be followed.

Safety During Operation

In this information slip, the following symbols are used:

 WARNING:	Indicates a potentially hazardous situation which, if instructions are not followed, could result in death or serious injury.
 CAUTION:	Indicates a potentially hazardous situation which, if instructions are not followed, may result in minor or moderate injury or damage to property.

WARNING

- Connect the power cord directly into a wall outlet and never use an extension cord.
- Disconnect the power plug (by pulling the plug, not the cable) if the power cable or plug becomes frayed or otherwise damaged.
- To avoid hazardous electric shock or laser radiation exposure, do not remove any covers or screws other than those specified in the Operating instructions.
- Turn off the power and disconnect the power plug (by pulling the plug, not the cable) if any of the following conditions exists:
 - You spill something into the product.
 - You suspect that your product needs service or repair.
 - Your product's cover has been damaged.
- Do not incinerate spilled toner or used toner. Toner dust might ignite when exposed to an open flame.
- Disposal can take place at our authorised dealer or at appropriate collection sites.
- Dispose of the used toner cartridge (or bottle) in accordance with the local regulation.

CAUTION

- Protect the product from dampness or wet weather, such as rain, snow, and so on.
- Unplug the power cord from the wall outlet before you move the product. While moving the product, you should take care that the power cord will not be damaged under the product.
- When you disconnect the power plug from the wall outlet, always pull the plug (not the cable).
- Do not allow paper clips, staples, or other small metallic objects to fall inside the product.
- Keep toner (used or unused), toner cartridge (or bottle), ink (used or unused) or ink cartridge out of reach of children.

- Be careful not to cut yourself on any sharp edges when you reach inside the product to remove misfed sheets of paper or masters.
- For environmental reasons, do not dispose of the product or expended supply wastes at household waste collection point. Disposal can take place at our authorised dealer or at appropriate collection sites.
- Our products are engineered to meet the high standards of quality and functionality, and we recommend that you only use the expendable supplies available at an authorised dealer.

Power Supply

The socket-outlet shall be installed near the product and shall be easily accessible.

For Fax or Telephone

- Do not use this product near water, for example near bath tub, wash bowl, kitchen sink or laundry tub, in a wet basement or near a swimming pool.
- Avoid using a telephone (other than a cordless type) during an electrical storm. There may be a remote risk of an electric shock from lightning.
- Do not use a telephone in the vicinity of a gas leak to report the leak.

Paper recommendations

Loading paper in the main unit tray

- Insert paper with the face down, and adjust paper guides to the paper format to avoid feed failure, skewing, and paper jams.
- Amount of loaded paper must not exceed the loading mark. If the loading mark is exceeded, this may cause feed failure, skewing, and paper jams.
- Adding paper in the pile must be avoided because it may cause double feeding.
- When withdrawing the cassette from the main unit, always support it with both hands to avoid dropping it.
- If you use paper already printed by your machine or another printer, the printing quality may not be optimal.

Handling of paper

- Curling must be corrected before printing.
- Curls must not exceed 10 mm.
- Care must be taken with storage to prevent feed faults and image defects due to leaving the paper in conditions of high humidity.

Humidity control

- Paper which has become damp, or paper which has been left unused for a very long time, must not be used.
- After opening the paper, it must be kept in a plastic bag.
- Paper with wavy ends, paper which is creased, paper with crumples, and any other non-normal paper must not be used.

Handling the unit

Operator shocks

During printing, shocks must not be applied to the paper feed cassette, tray, cover, and other parts of the machine.

Moving the unit

When moving the unit on a desk, it must be lifted, and not dragged.

Handling the Toner Cartridge

- Must not be stood on the side, or held upside down.
- Must not be shaken strongly.

Rules for use symbols



WARNING

Indicates important safety notes.

Ignoring these notes could result in serious injury or death. Be sure to read these notes. They can be found in the Safety information section of this manual.



CAUTION

Indicates important safety notes.

Ignoring these notes could result in moderate or minor injury, or damage to the machine or to property. Be sure to read these notes. They can be found in the Safety information section of this manual.



Important

Indicates points to pay attention to when using the machine, and explanations of likely causes of paper misfeeds, damage to originals, or loss of data. Be sure to read these explanations.



Note

Indicates supplementary explanations of the machine's functions, and instructions on resolving user errors.

Terminal description

Front and Back sides

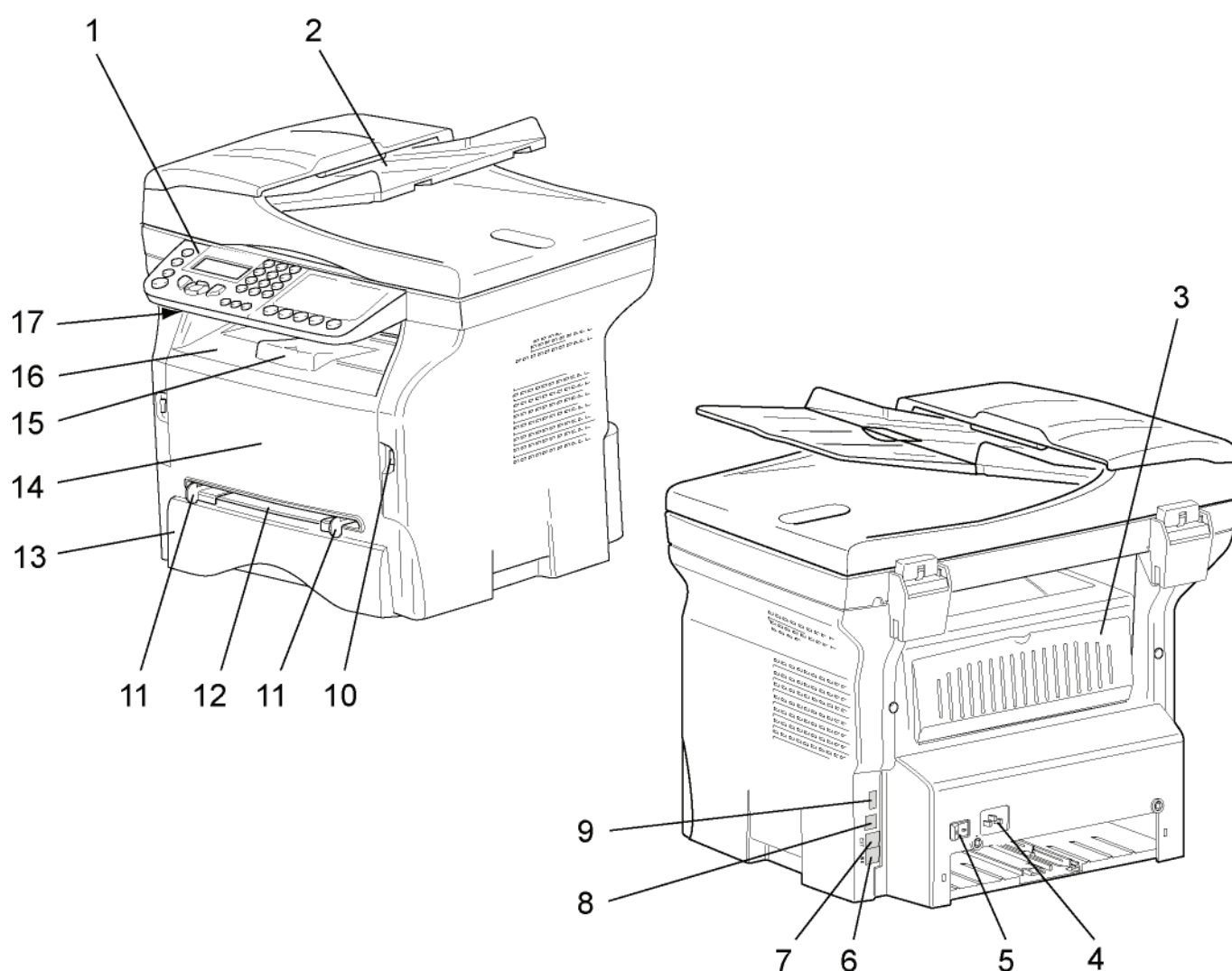

- | | |
|--|--|
| 1. Control panel | 10. Master USB connection (USB key) |
| 2. Document feeder | 11. Manual paper feed setup guides |
| 3. Paper jam cover | 12. Manual input tray |
| 4. Power supply cord connection | 13. Paper tray |
| 5. On/Off switch | 14. Cartridge access cover |
| 6. LINE socket - telephone cable connection | 15. Fold-down stopper for paper delivery |
| 7. EXT. socket - connection for external telephone devices | 16. Paper output |
| 8. Slave USB connection (for PC) | 17. Smart card insertion point |
| 9. Master USB connection (USB key) | |

Command panel

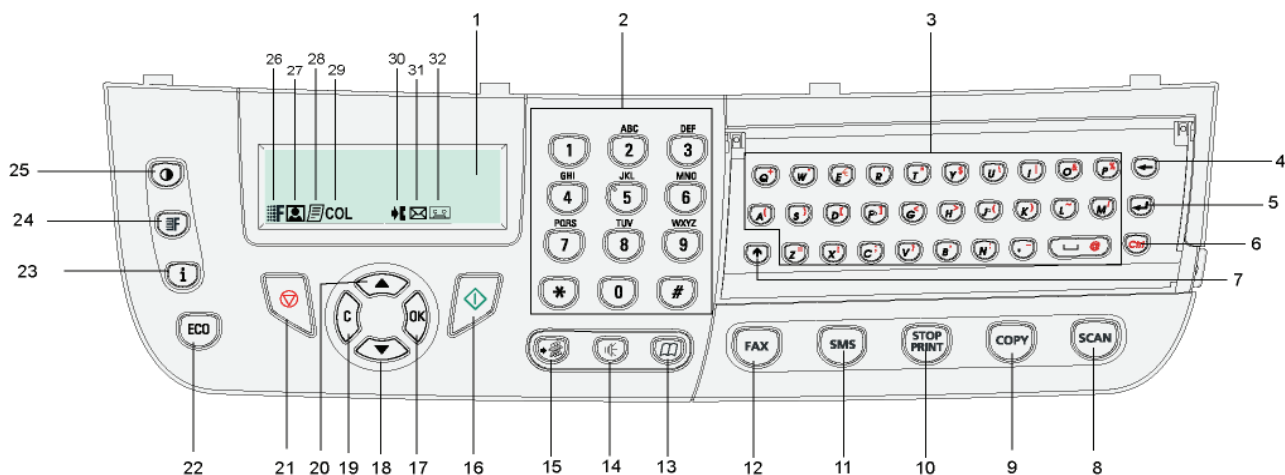

1. Screen.
2. Digital keypad.
3. Alphabetical keypad.
4. Key : deletes the character to the left of the cursor.
5. Key : input or line feed.
6. Key : access to special characters.
7. Key : Shift.
8. Key : document analysis to the PC or a media (USB key).
9. Key : local copy.
10. Key : stops the current PC print job.
11. Key : sending of an SMS (Short Message Service).
12. Key : sending of a fax.
13. Key : access to directory and quick dial numbers.
14. Key : line manual connection, listen for tone during fax sending.
15. Key : multiple contact sending (fax, e-mail or SMS).
16. Key : Validation.
17. Key **OK**: confirms the displayed selection.
18. Key : menu access and navigation down the menus.
19. Key **C**: back to the previous menu and input correction.
20. Key : navigation up the menus.
21. Key : stops the current operation.
22. Key : sets up the activation delay and toner save in copy mode.
23. Key : access to print menu (print functions list, machine settings, etc.).
24. Key : analysis resolution setup.
25. Key : contrast setup.
26. Icon : resolution "Copy: **Quality Text** / Fax: **SFine**".
27. Icon : resolution "**Photo**".
28. Icon : resolution "Copy: **Text** / Fax: **Fine**".
29. Icon **COL**: colour mode.
30. Icon : activity on the telephone line.
31. Icon : Fax mode.
32. Icon : external answering machine mode.

Accessing terminal menus

All terminal functions and settings are available via the menu and are associated to a specific menu command. For example, the menu command 51 launches the printing of the functions list (the functions list stores the list of all terminal menus, sub-menus and their identification number).

Two methods are available to access menu items: the step by step method or the shortcut method.

To print the functions list with the Step by step method:

- 1 Press .
- 2 Use the or button to browse the menu and select **5 - PRINT**. Confirm with **OK**.
- 3 Use the or button to browse the menu **PRINT** and select **51-FUNCTIONS LIST**. Confirm with **OK**.

To print the functions list with the shortcut method:

- 1 Press .
- 2 Enter 51 with the numerical keypad to directly print the functions list.

Packaging contents

The packaging contains the items listed below:

Multifunction device

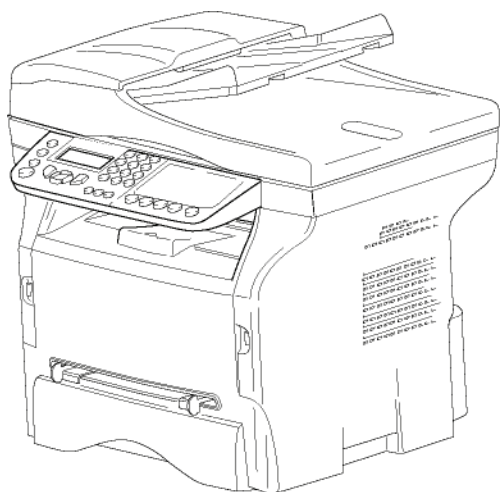

1 toner cartridge



1 Installation guide



1 PC installation CD ROM and 1 OCR PC software CD ROM (depending on model)

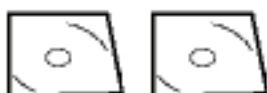

1 power cord



1 telephone cord



Device installation

- 1 Unpack the device.
- 2 Install the device respecting the security notices stated at the beginning of this booklet.
- 3 Remove all stickers from the machine.
- 4 Remove the plastic protection film from the screen.

Installing the document feeder

- 1 Secure the document feeder by fitting the two clips (B) in the notches (A) provided for this purpose.

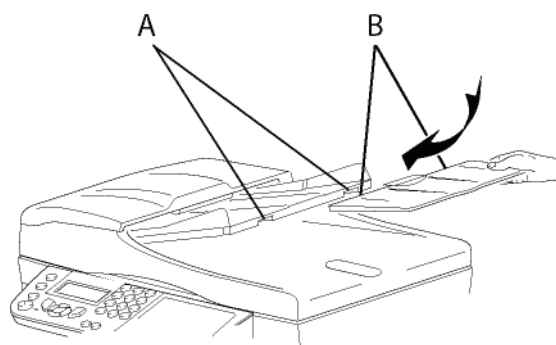

Feed cassette paper insertion



Important

Before inserting paper, refer to the paragraph **Paper recommendations**, page 10.

Your device accepts a number of formats and types of papers (refer to the paragraph **Specifications**, page 79).



Important

You can use paper weighing between **60 and 105 g/m²**.

- 1 Remove the paper feed cassette completely.

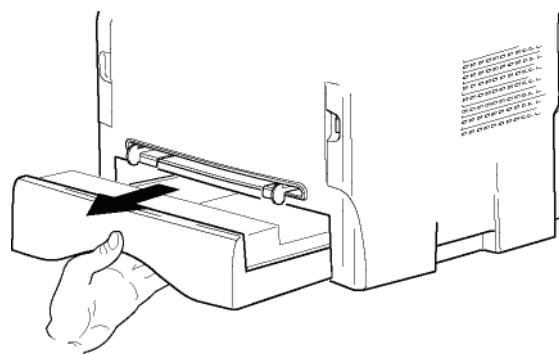

- 2 Push the lower panel down until it clicks.

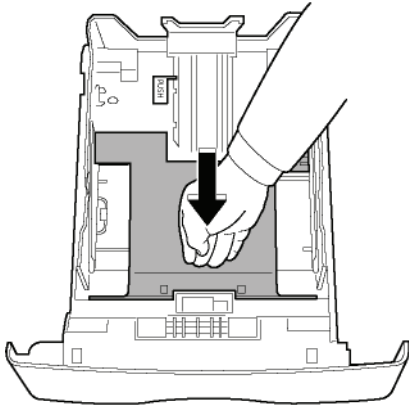

- 3 Setup the back side feed cassette stop by pushing the "PUSH" lever (A). Then adjust the lateral paper guides to the paper format by pushing lever (B) located on the left guide. Adjust the length paper guide to the paper format by pushing lever (C).

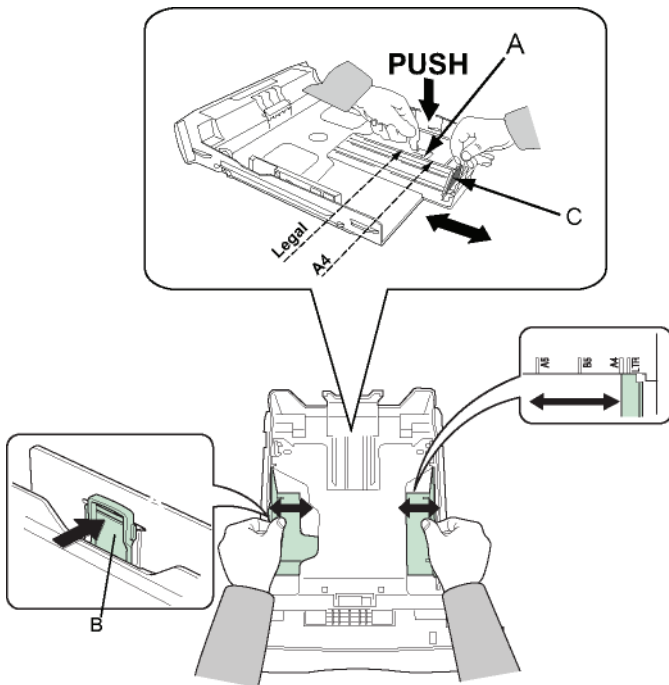

- 4 Take a paper stack, pull the paper off and align it on a flat surface.

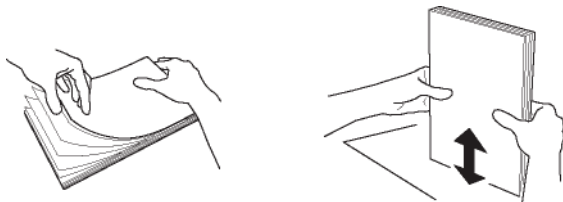

- 5 Put the paper stack in the feed cassette (200 sheets of 80 g/m² paper for instance).
6 Put the feed cassette back in its location.

Cartridge installation

- 1 Stand in front of the machine.
2 Push the left and right sides of the cover and pull it towards you at the same time.

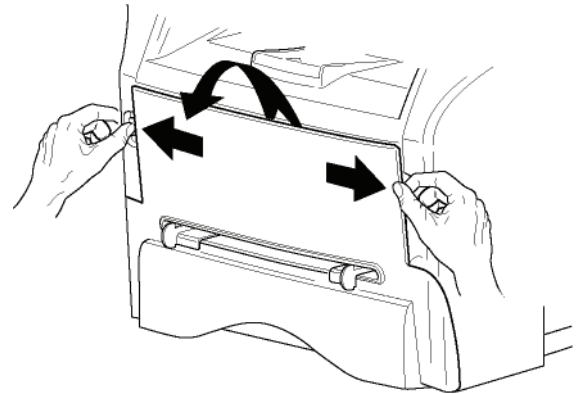

- 3 Unpack the new cartridge. Gently roll the cartridge 5 or 6 times to distribute the toner evenly inside the cartridge. Thoroughly rolling the cartridge will assure the maximum copies per cartridge. Hold it by its handle.

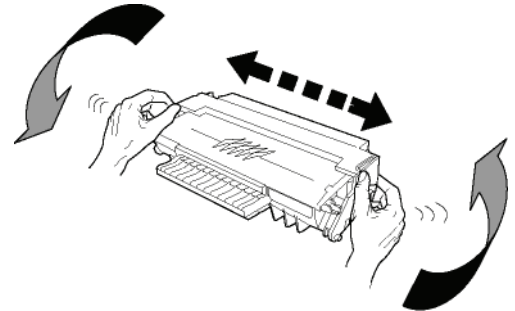

- 4 Insert the cartridge in its slot by pushing it until it clicks (last move down) as shown on the picture below.

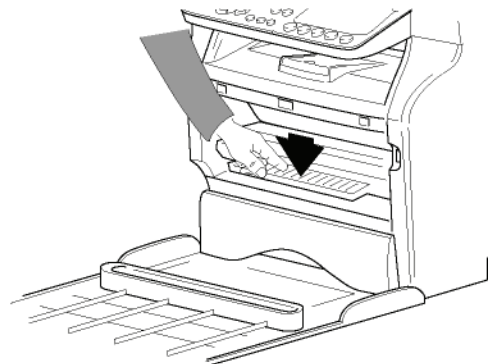
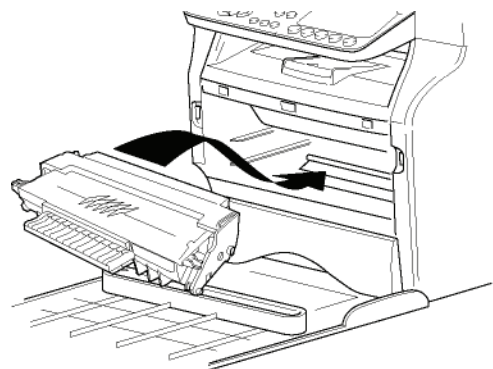

- 5 Close the cover.

Paper delivery stop

Adjust the paper delivery stop, depending on the format of the document to be printed. Do not forget to raise the flap to prevent the sheets from falling down.

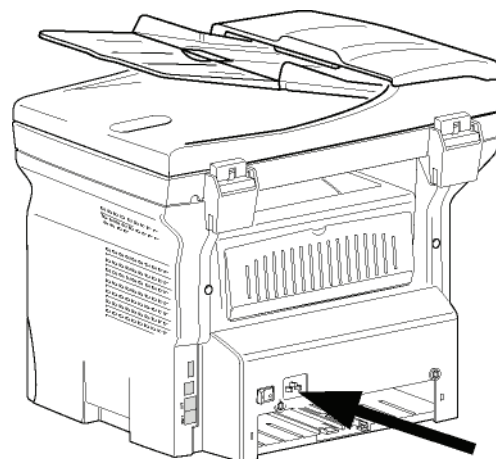
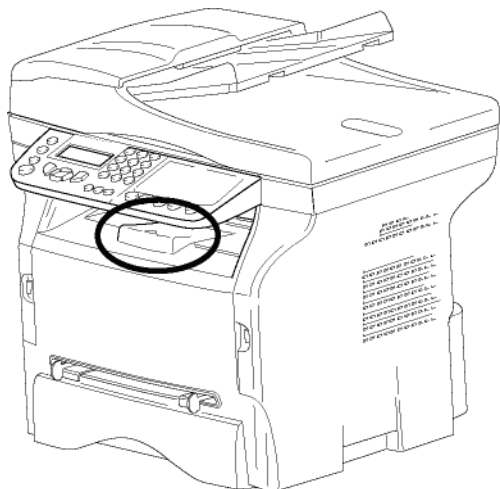

Starting your device

Device connection



WARNING

Before plugging the power cord, it is imperative to refer to the **Security directives, page 1.**

- 1 Plug the end of the telephone line into the terminal socket and the other end into the wall telephone socket.

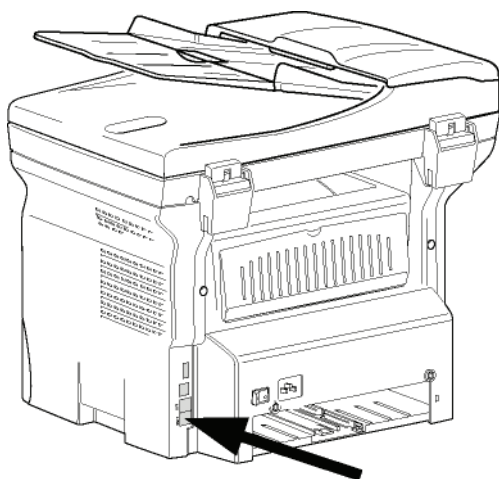

- 2 Make sure that the On/Off switch is on Off (O position).
- 3 Connect the power cord to the device. Plug the power cord to outlet on the wall.



WARNING

The power cord is used as a power unit cut off. As a precaution, the outlet shall be located close to the device and be of easy access in case of danger.

- 4 Press the On/Off button to turn on the device (I position).

Device initial setup

After a few seconds, when the machine has warmed up, the **Easy Install** function is launched and the LCD screen displays the following message:



1 - FRANCAIS
2 - ENGLISH

The **Easy Install** function will help you configure your machine by guiding you through the basic settings.

If you wish to modify the setting displayed, press the **OK** button. If you do not want to modify the displayed setting, press the **C** button: the **Easy Install** function then displays the next basic setting.



Note

If you do not want to carry out the initial setup, press the  button. A confirmation message appears. Press the  button again to confirm. To manually modify and customise the machine settings, refer to **Parameters/Setup, page 31.**

- 1 Select the desired language using the \blacktriangle or \blacktriangledown buttons and confirm with **OK**.
- 2 To set the country, press the **OK** button.

SET COUNTRY
YES=OK - NO=C

- 3 Select your country in the list displayed using the ▲ or ▼ buttons and confirm with **OK**.



If none of the options in the list is suitable, select the "OTHER" option.

- 4 If you have set the country to "Other", you may need to set the public telephone NETWORK to use. Press the **OK** button to specify it.

SET NETWORK
YES=OK - NO=C

Select the telephone network to use in the list displayed using the ▲ or ▼ buttons and confirm with **OK**.

If none of the options in the list is suitable, select the "OTHER X" option:

- OTHER 1 = TRB21
- OTHER 2 = US
- OTHER 3 = Russia
- OTHER 4 = Jordan
- OTHER 5 = Israel
- OTHER 6 = TRB21



Important

- 5 To set the date and time, press the **OK** button.

DATE/TIME
YES=OK - NO=C

- 6 Enter the numbers of the required date and time one after another using the numerical keypad. The date format depends on the country you have selected: for instance, DDMMYY for France, MMDDYY for the USA. Use the **C** button to correct an entry. Press **OK** to confirm.

- 7 To specify the fax number and machine name, press the **OK** button. This information will appear on your transmitted documents when the "Sending Header" function is activated.

NAME/NUMBER
YES=OK - NO=C

- 8 Enter your fax number (20 digits max.) using the numerical keypad. To type the "+" sign, press simultaneously the **CTRL** and **Q** keys. Use the **C** button to correct an entry. Press the **OK** button to confirm.
- 9 Enter your machine name (20 characters max.) using the alphanumerical keypad. Press the **OK** button to confirm.
- 10 If you are connecting your machine to a private network, behind a company's PABX, you may need to specify a local prefix. This prefix will be then used to exit the company's telephone network. To set up this function, press the **OK** button.

PREFIX
YES=OK - NO=C

- 11 Enter the minimal size of the company's outside numbers (1 to 30) using the numerical keypad. This setting is used to differentiate internal telephone numbers from external telephone numbers.

For example, if you are installing the machine in France, behind your company's PABX, enter 10 (10 digits being the standard telephone number length for France).

Use **C** to correct an entry.

Press the **OK** button to confirm.

- 12 Enter the local prefix number (10 characters max.) using the numerical keypad.

This prefix will automatically be added when an external number is dialled.

To insert a pause for dial tone ("/" sign), press simultaneously the **CTRL** and **M** keys, or long press the 0 (zero) key on the numerical keypad until the "/" sign is displayed.

Use the **C** button to correct an entry.

Press the **OK** button to confirm.

The setup is now complete and the functions list is automatically printed out.

The LCD screen displays the message **PAPER EMPTY** if no paper has been loaded in the paper tray (see **Loading paper in the main unit tray**, page 10). Once paper has been loaded, printing will resume.

Paper insertion in the manual input tray



Important

*Before inserting paper, refer to the paragraph **Paper recommendations**, page 10.*

The manual input tray allows you to use various paper formats with greater grammage than the one used in the paper feed cassette (refer to the paragraph **Specifications**, page 79).

Only one sheet or envelope can be fed at a time.



Important

*You can use paper weighing between **52 and 160 g/m²**.*

- 1 Spread the manual feed guides to the maximum.

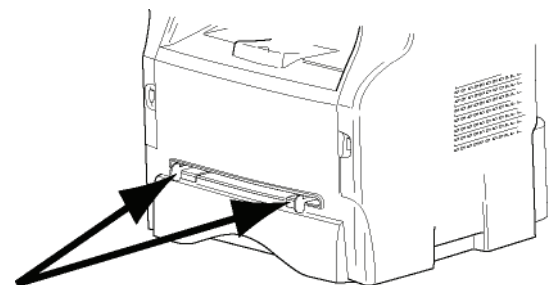

- 2 Insert a sheet or an envelope in the manual input tray.

- 3 Adjust the paper guides against the right and left edges of the sheet or the envelope.
- 4 Print making sure that the chosen paper format corresponds to the selected format on the printer (refer to **Copy**, page 19).

Use of envelopes

- Feeding can be done only through the manual feed.
- Recommended area should be the area which excludes 15 mm from the leading edge, 10 mm from both the left and right edges, and the rear edge.
- A few lines may be given in solid print at the part of being overlapped.
- Envelopes which are not recommended may lead to improper printing (refer to the paragraph **Specifications**, page 79).
- Curled envelope after printing should be fixed manually.
- Small crumples on the edge of the wide side of envelopes, smearing, or less clear printing may appear on the reverse side.
- Set envelope by pressing the folding line of four edges properly after releasing air inside.
- Set envelope in a proper position after aligning in case it is bent or warped.
- Paper conditioning is not allowed. And it should be used under normal office environment.

Copy

Your machine has the function to make one or more copies.

You can also set up several parameters in order to make copies at your will.

Simple copy



In this case, the default parameters are applied.

- 1 Place the document to be copied in the automatic document feeder, printed face on the top.
or
Place the document to be copied face down on the glass, respecting the indications around the glass.
- 2 Press the  button twice. The copy is made using the default parameters.

ECO mode copy



The ECO mode enables you to reduce the amount of toner consumed on the page so as to save your printing costs.

When the ECO mode is used, the toner consumption is reduced and the print density becomes lighter.

- 1 Place the document to be copied in the automatic document feeder, printed face on the top.
or
Place the document to be copied face down on the glass, respecting the indications around the glass.
- 2 Press the  button.
- 3 Press the  button.

Advanced copying

The sophisticated copy allows to do custom setups for the current copy.

 **Note** You can start copy by pressing the  button at any time in below steps.

- 1 Place the document to be copied in the automatic document feeder, face printed on the top.
or
Place the document to be copied face down on the glass, respecting the indications around the glass.

 **Note** After step 1, you can directly enter the number of copies with the numerical keypad and press the **OK** button to validate. Then refer to step 4.

- 2 Press the  button.

- 3 Enter the number of copies that you want and confirm with the **OK** button.
- 4 Choose the paper tray **AUTOMATIC** or **MANUAL** with the buttons \blacktriangle or \blacktriangledown , then confirm with the **OK** button.
- 5 Choose with the buttons \blacktriangle or \blacktriangledown the printing option (see examples below) depending on the copy mode that you want:
 - Mosaic mode (document feeder): **1 Page onto 1**, **2 Pages onto 1**, or **4 Pages onto 1**.

MOSAIC Copy mode

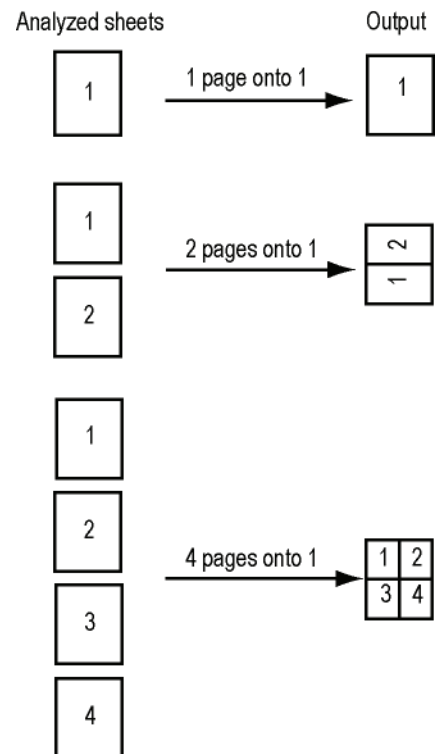

- Poster mode (flat-bed scanner): **1 Page to 1**, **1 Page to 4** or **1 page to 9**.

POSTER Copy mode

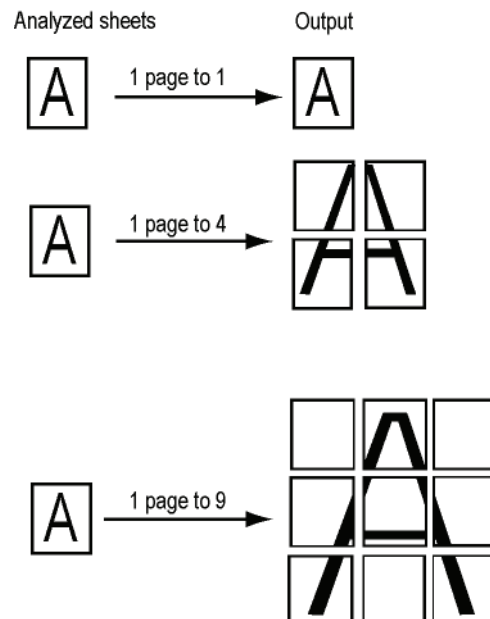

Confirm with the **OK** button.

- 6 Adjust the desired zoom level, from **25% TO 400%** with the buttons \blacktriangle or \blacktriangledown , confirm with the **OK** button (only available in **1 Page to 1** copy mode).
- 7 Adjust the desired origin values with the digital keyboard buttons \blacktriangle or \blacktriangledown then confirm with the **OK** button.
- 8 Choose the resolution depending on the printing quality that you want **AUTO, TEXT, QUALITY TEXT** or **PHOTO** with the buttons \blacktriangle or \blacktriangledown , then confirm with the **OK** button.
- 9 Adjust the contrast level with the buttons \blacktriangle or \blacktriangledown , then confirm with the **OK** button.
- 10 Adjust the desired brightness level with the buttons \blacktriangle or \blacktriangledown , then confirm with the **OK** button.
- 11 Choose the paper type **NORMAL, THICK** with the buttons \blacktriangle or \blacktriangledown , then confirm with the **OK** button.
- 7 Adjust the contrast level with the buttons \blacktriangle or \blacktriangledown , then confirm with the **OK** button.
- 8 Adjust the desired brightness level with the buttons \blacktriangle or \blacktriangledown , then confirm with the **OK** button.
- 9 Choose the paper type **NORMAL, THICK** with the buttons \blacktriangle or \blacktriangledown , then confirm with the **OK** button. The LCD screen displays the following message:

**PUT ID CARD
THEN OK**

- 10 Place your identity card or any other official document against the glass of the flatbed scanner, as shown below:

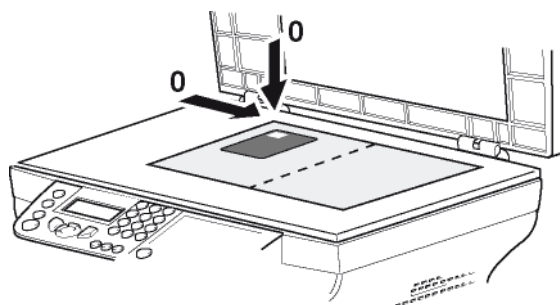

- 11 Press the **OK** button. The document is scanned then the LCD screen displays the following message:

**TURN UP DOC
THEN OK**

- 12 Turn your document over then confirm with the **OK** button.

The machine prints out a copy of your document.

Special setup for the copying

Setups done through this menu become the device **default setups** after you confirm.



*When the quality of the printing is not satisfying, you can proceed to a calibration (see **Calibrate your scanner**, page 38).*

Resolution setup

The **RESOLUTION** parameter allows you to setup the photocopy resolution.

▼ 841 - ADVANCED FCT/COPY/RESOLUTION

- 1 Press \blacktriangledown , enter **841** using the keypad.
- 2 Choose the resolution with the buttons \blacktriangle or \blacktriangledown according to the following table:

Parameter	Signification	Icon
AUTO	Low resolution.	none
TEXT	Standard resolution for documents containing text and graphics.	

ID Card Copy mode

The ID CARD copy function is used for copying both sides of an identity card or driver's license type document on an A4 format sheet (original document size < A5) or on a Letter format sheet (original document size < Statement).

The LCD screen displays useful operating instructions (when the original document should be placed, when the document should be turned over, etc.) and asks for your confirmation to proceed with the operation.

This function is available only if the document to be copied is placed on the flatbed scanner, and if no paper is detected in the automatic document feeder. Zoom and Origin adjustments are not available in this copy mode.



- 1 Make sure that there is no document in the automatic document feeder.
- 2 Press the button.
- 3 Enter the desired number of copies and confirm with the **OK** button.
- 4 Choose the paper tray **AUTOMATIC** or **MANUAL** with the buttons \blacktriangle or \blacktriangledown , then confirm with the **OK** button.



Copying in ID Card mode is only possible on A4 (original document size < A5) or Letter (original document size < Statement) paper size. Make sure that the selected paper tray uses the correct paper size.

- 5 Choose the copying option **ID CARD** with the buttons \blacktriangle or \blacktriangledown and confirm with the **OK** button.
- 6 Choose the resolution depending on the desired printing quality **AUTO, TEXT, QUALITY TEXT** or **PHOTO** with the buttons \blacktriangle or \blacktriangledown , then confirm with the **OK** button. For optimal results with ID documents, select the **PHOTO** resolution.

Parameter	Signification	Icon
QUALITY TEXT	Optimal resolution for documents containing text.	
PHOTO	Optimal resolution for documents containing photographs.	

3 Confirm your choice by pressing the **OK** button.

4 Quit this menu by pressing the button.



You can also change the resolution by pressing the button.

Zoom setup

The **ZOOM** parameter allows you to reduce or enlarge an area of a document by choosing the origin and the zoom level to apply to the document, from 25 to 400 %.

▼ 842 - ADVANCED FCT/COPY/ZOOMING

- 1 Press \blacktriangledown , enter **842** using the keypad.
- 2 Enter the desired zoom level with the alphanumerical keypad or choose among predefined values with the buttons \blacktriangle and \blacktriangledown .
- 3 Confirm your choice by pressing the **OK** button.
- 4 Quit this menu by pressing the button.

Collated copy setup

The **COLLATED** parameter allows you to assemble or disassemble your copies.

▼ 843 - ADVANCED FCT/COPY/COLLATED

- 1 Press \blacktriangledown , enter **843** using the keypad.
- 2 Select the desired option with the buttons \blacktriangle and \blacktriangledown according to the following table:

Parameter	Signification
COLLATED	The printer assembles the copies of the original document. E.g.: if you make three copies of a 10-page document, the document is copied from page 1 to 10 three times over.
UNCOLLATED	The printer does not assemble the copies of the original document. E.g.: if you make three copies of a 10-page document, page 1 is copied three times, then page 2, then page 3, etc.

3 Confirm your choice by pressing the **OK** button.

4 Quit this menu by pressing the button.

Analysis origin setup

If you want, you can change the origin of the scanner.

By entering new values for X and Y in mm ($X < 209$ and $Y < 280$), you move the analysed area as shown on the diagram below.

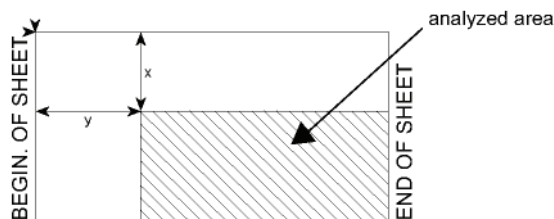

▼ 844 - ADVANCED FCT/COPY/ORIGIN

- 1 Press \blacktriangledown , enter **844** using the keypad.
- 2 Select the X and Y coordinates with the buttons \blacktriangle or \blacktriangledown .
- 3 Setup the desired coordinates with the numerical keypad or the buttons \blacktriangle and \blacktriangledown .
- 4 Confirm your choice by pressing the **OK** button.
- 5 Quit this menu by pressing the button.

Contrast setup

The **CONTRAST** parameter allows to choose the photocopy contrast.

▼ 845 - ADVANCED FCT/COPY/CONTRAST

- 1 Press \blacktriangledown , enter **845** using the keypad.
- 2 Setup the desired level of contrast with the buttons \blacktriangle and \blacktriangledown .
- 3 Confirm your choice by pressing the **OK** button.
- 4 Quit this menu by pressing the button.

Brightness setup

The **BRIGHTNESS** parameter allows to lighten or darken your output.

▼ 846 - ADVANCED FCT/COPY/BRIGHTNESS

- 1 Press \blacktriangledown , enter **846** using the keypad.
- 2 Setup the desired brightness with the buttons \blacktriangle and \blacktriangledown .
- 3 Confirm your choice by pressing the **OK** button.
- 4 Quit this menu by pressing the button.

Paper type setup

▼ 851 - ADVANCED FCT/SCAN. & PRINT/PAPER TYPE

- 1 Press \blacktriangledown , enter **851** using the keypad.
- 2 Select the paper **NORMAL** or **THICK** that you use with the buttons \blacktriangle and \blacktriangledown .
- 3 Confirm your choice by pressing the **OK** button.
- 4 Quit this menu by pressing the button.

Paper tray selection

The **Automatic** selection can have two meanings depending on the paper format defined on the paper trays. The following table describes the different cases.

	Default tray	Tray used for copy
Same paper format in the trays	AUTOMATIC	Selection between the main tray and the manual tray.
	MANUAL	The manual tray is used.
Different paper format in the trays	AUTOMATIC	The main tray is used.
	MANUAL	The manual tray is used.

▼ 852 - ADVANCED FCT/SCAN. & PRINT/TRAY PAPER

- 1 Press ▼, enter **852** using the keypad.
- 2 Select the default paper tray to use, **AUTOMATIC** or **MANUAL**, with the buttons ▲ and ▼.
- 3 Confirm by pressing the **OK** button.
- 4 Quit this menu by pressing the  button.

Sheet-feed analysis margins setup

If you want to, you can offset the lateral margins of the document to the left or right during the analysis with your sheet-feed scanner.

▼ 853 - ADVANCED FCT/SCAN. & PRINT/ S.F. MARGINS

- 1 Press ▼, enter **853** using the keypad.
- 2 Setup the left / right margins offsets (by 0.5 mm steps) with the buttons ▲ and ▼.
- 3 Confirm by pressing the **OK** button.
- 4 Quit this menu by pressing the  button.

Flat-bed analysis margins setup

If you want to, you can offset the lateral margins of the document to the left or right during the analysis with your flat-bed scanner.

▼ 854 - ADVANCED FCT/SCAN. & PRINT/ FLATBED MARG

- 1 Press ▼, enter **854** using the keypad.
- 2 Setup the left / right margins offsets (by 0.5 mm steps) with the buttons ▲ and ▼.
- 3 Confirm by pressing the **OK** button.
- 4 Quit this menu by pressing the  button.

Left and right printing margins setup

If you want to, you can offset the lateral margins of the document to the left or right during printing.

▼ 855 - ADVANCED FCT/SCAN. & PRINT/ PRINTER MARG

- 1 Press ▼, enter **855** using the keypad.
- 2 Setup the left / right margins offsets (by 0.5 mm steps) with the buttons ▲ and ▼.
- 3 Confirm by pressing the **OK** button.
- 4 Quit this menu by pressing the  button.

Top and bottom printing margins setup

If you want to, you can offset the lateral margins of the document towards the top or the bottom during printing.

▼ 856 - ADVANCED FCT/SCAN. & PRINT/TOP PRINT.

- 1 Press ▼, enter **856** using the keypad.
- 2 Setup the top / bottom margins offsets (by 0.5 mm steps) with the buttons ▲ and ▼.
- 3 Confirm by pressing the **OK** button.
- 4 Quit this menu by pressing the  button.

Format paper setup

This menu allows you to define the default paper format of the manual tray and the main tray. You can also setup the default scanning width.

▼ 857 - ADVANCED FCT/SCAN. & PRINT/ PAPER FORMAT

- 1 Press ▼, enter **857** using the keypad.
- 2 Select the paper tray for which you want to define a default paper format with the buttons ▲ and ▼.
- 3 Confirm by pressing the **OK** button.
- 4 Choose the paper format with the buttons ▲ or ▼ according to the following table:

Paper tray	Available paper format
MAN. TRAY	A5, Statement, A4, Legal and Letter
AUTO. TRAY	A5, Statement, A4, Legal and Letter
SCANNER	LTR/LGL and A4

- 5 Confirm by pressing the **OK** button.
- 6 Quit this menu by pressing the  button.

Fax

This chapter describes all the fax processing and configuration functions.
You will also find a section describing fax mailboxes.

Fax transmission

Print a header page

A header page is stored in your terminal. To send your fax using this header page, you can print it at any time and fill in your details.

- 1 Select **▼ 30 - FAX /HEADER PAGE**.
- 2 Select:
 - 301 - LOCAL**, to print a header page according to the language configured on the terminal,
 - 302 - INTERNAT**, to print a bilingual header page, the language of the country configured on the terminal and English. The separator between the two languages is "/".



Note

If English is the language configured on the terminal, the header page will only be printed in English.



Example of the international header page:

FAX

A / TO :	FAX :
DE / FROM :	TELEPHONE :
DATE :	PAGES :

OBJET / SUBJECT

Immediate transmission

- 1 Place the document to be copied in the automatic document feeder, face printed on the top.
or
Place the document to be copied face down on the glass, respecting the indications around the glass.
- 2 Enter the fax number then press  or .
- 3 If you are using the flatbed scanner, you can scan more than one page. Place the next page on the scanner, select **NEXT** and confirm with **OK**. Select **DONE** when all pages have been scanned.

The  icon flashes during the call phase, it stays lit when both faxes are in communication.

At the end of transmission the initial screen is displayed.



Note

You can modify transmission options when sending a fax. To do so, press **OK** after entering the fax number.

Delayed transmission

This function allows you to transmit a document at a later time.

To program a postponed transmission you need to identify the subscriber number, transmission time, feeder type and number of pages.

To delay the transmission time of your document :

- 1 Place the document to be copied in the automatic document feeder, face printed on the top.
or
Place the document to be copied face down on the glass, respecting the indications around the glass.



Important

Make sure that the document in the feeder tray or on the scanner window is properly located in order to avoid sending blank or incorrect pages.

- 2 Select **▼ 31 - FAX / TRANSMISSION**.
- 3 Enter the subscriber number you wish to program at a different time or choose your dialling mode and confirm with **OK**.
- 4 Next to the current time, enter the new time and confirm with **OK**.
- 5 Adjust the contrast and confirm with **OK**.
- 6 Select the feed type, **FEEDER** or **MEMORY** and confirm with **OK**.
- 7 You may enter the number of pages before transmission and confirm with **OK**.
- 8 Confirm postponed transmission by pressing .
- 9 If you are using the flatbed scanner, you can scan more than one page. Place the next page on the scanner, select **NEXT** and confirm with **OK**. Select **DONE** when all pages have been scanned.

Your document is stored and will be sent at the new time.



Transmission with auto redial

This function allows you to monitor the dialling operation during a fax transmission. In this case, the maximum transmission rate will be 14400 bps.

This function allows for example:

- to hear if the subscriber's fax is engaged and if so, choose the moment when the line is clear to start the document transmission.
- to control the communication progress in case of uncertain numbers, etc.

To take the line manually:

- 1 Place the document in the fax feeder.
- 2 Press .
- 3 If necessary, set the sound level using the ▼ or ▲ keys.
- 4 Enter the subscriber number.
As soon as you hear the remote fax tone, the line is clear and you can start the transmission.
- 5 Press  to start the document transmission.

If your machine is set in order to print a transmission report, the reduced copy of the document first page will not be printed and it notifies you that the communication is manual (see **Transmission report**, page 33).

Fax reception

Fax reception depends on the parameter settings of your machine.

The following parameters let you customize the printing of received faxes:

- **Reception Mode**, page 34;
- **Reception without paper**, page 34;
- **Number of copies**, page 34;
- **Fax or PC reception**, page 34;
- **Received faxes reduction mode**, page 35;
- **Technical Parameters**, page 35.



Important

The printing is not possible on A5 (or Statement) paper format.

The following tables give which tray is used to print received fax depending on the default tray and the paper format in both trays.

Default tray set to **Manual**:

Manual tray paper format	Main tray paper format	Action
A4,Letter and Legal	A4,Letter and Legal	The fax is printed on manual tray.
A4,Letter and Legal	A5, Statement	The fax is printed on manual tray.
A5, Statement	A4,Letter and Legal	The paper on manual tray is incompatible. The fax is printed on the main tray.
A5, Statement	A5, Statement	An error message is displayed on the screen. The paper on manual tray is incompatible.

Default tray set to **Automatic**:

Manual tray paper format	Main tray paper format	Action
A4,Letter and Legal	A4,Letter and Legal	The fax is printed with an automatic selection of tray.
A4,Letter and Legal	A5, Statement	An error message is displayed on the screen. The paper on automatic tray is incompatible.
A5, Statement	A4,Letter and Legal	The fax is printed on the main tray.
A5, Statement	A5, Statement	An error message is displayed on the screen. The paper on automatic tray is incompatible.

Relay broadcast

Your fax machine (initiator) can relay a document, in other words, transmit a document to your subscribers via a remote fax and with a precise relay list.

To do this the initiator fax and the remote fax must both have the relay function.

To relay you need to supply the remote fax with the document and the relay list number. The remote fax will then transmit this document to all subscribers on the list.

Once the relay is activated by your fax and as soon as the document is received by the remote fax, the document is printed before relaying to all subscribers on the list.

To activate relay from your fax machine:

- 1 Insert the document to relay.



Important

Make sure that the document in the feeder tray or on the scanner window is properly located in order to avoid sending blank or incorrect pages.

- 2 Select **▼ 37 - FAX / BROADCAST**.
- 3 Enter the remote fax number where you will relay to or choose your dialling mode and press **OK**.
- 4 Enter the relay list number used by the remote fax and press **OK**.
- 5 You may enter the time you wish to transmit the document next to the current time and press **OK**.
- 6 If you wish to modify the document feed type, select one of the options **FEEDER** or **MEMORY**, then press **OK**.
- 7 If you wish, you may enter the number of pages of your documents before transmitting.
- 8 Activate relay by pressing .
- 9 If you are using the flatbed scanner, you can scan more than one page. Place the next page on the scanner, select **NEXT** and confirm with **OK**. Select **DONE** when all pages have been scanned.

The document in the feeder will be relayed either immediately or at a later time (according to your choice) to the remote fax which will relay the document.

Fax answering machine

The Fax answering machine allows you to keep confidential documents in storage and to avoid printing them as you receive them.

The  indicator light lets you know the state of your Fax answering machine:

- Light on: the answering machine is on.
- Blinking: your fax has documents in storage or is in the process of receiving faxes.
- Light off: memory full, the terminal cannot receive any more documents.

You can assure document confidentiality by using the 4 digit access code. Once saved, you will require this access code for:

- printing fax messages in memory,
- activating or deactivating the fax answering machine.

Saving an access code

▼ 383 - FAX / FAX ANSW. / ANSWER CODE

- 1 Press **▼**, enter **383** using the keypad.
- 2 Enter the code (4 digits) and confirm with **OK**.
- 3 Quit this menu by pressing the button.

Activating / Deactivating the answering machine

▼ 382 - FAX / FAX ANSW. / ACTIVATION

- 1 Press **▼**, enter **382** using the keypad.
- 2 If you saved an access code for your fax answering machine, enter it and confirm with **OK**.
- 3 Select the required answering machine option, **ON** or **OFF**, and confirm your choice with **OK**.
- 4 Quit this menu by pressing the button.

Printing fax messages stored in the memory



Important

The printing is not possible on A5 (or Statement) paper format.

▼ 381 - FAX / FAX ANSW. / PRINT

- 1 Press **▼**, enter **381** using the keypad.
- 2 If you saved an access code for your fax answering machine, enter it and confirm with **OK**.

Documents received and stored in the memory are printed.

Fax rerouting

This function is used to reroute faxes received to a directory contact. To use this function, you have to perform two operations:

- 1 Activate rerouting.
- 2 Set the rerouting address of the fax.

Activating rerouting



Important

*Make sure that the subscriber exists in the directory (see **Directory**, page 39).*

▼ 391 - FAX / REROUTING / ACTIVATION

- 1 Press **▼**, enter **391** using the keypad.
- 2 Using the keys **▼** and **▲** within the navigator, select option **ON**.
- 3 Using the keys **▼** and **▲** within the navigator, select the subscriber from the directory.
- 4 Confirm with **OK**.
- 5 Quit this menu by pressing the button.

If the option **OFF** is selected, the menus **392** and **393** will not be included in the functions overview, when it is printed out.

Setting the re-direction contact

▼ 392 - FAX / REROUTING / CALL NUMBER

- 1 Press **▼**, enter **392** using the keypad.
- 2 Using the keys **▼** and **▲** within the navigator, select the subscriber from the directory.
- 3 Confirm with **OK**.
- 4 Quit this menu by pressing the  button.

Printing rerouted documents

▼ 393 - FAX / REROUTING / COPY

- 1 Press **▼**, enter **393** using the keypad.
- 2 Using the keys **▼** and **▲** within the navigator, select the **COPY** option (local printout of the information relayed to your device) either **ON** or **OFF**.
- 3 Confirm with **OK**.
- 4 Quit this menu by pressing the  button.

Rerouting fax messages to a USB memory key

This function allows you to reroute received fax messages directly in the folder MFPrinter Laser Pro LL2\FAX on a USB memory key connected to your terminal. The folder MFPrinter Laser Pro LL2\FAX is created by the application. The USB memory key then becomes the terminal reception memory.

Fax messages that are rerouted are therefore saved on the USB memory key with format Tiff and are named as follows: "FAXYYMMDDHHMMSS" where YYMMDDHHMMSS corresponds to the fax reception date and time.

You can also print fax messages rerouted to your USB memory key automatically by activating menu **052 PRINT**.

Activating rerouting



Important

Before activating this function, connect the USB memory key to the terminal.

▼ 051 - MEDIA / FAX ARCHIVING / ACTIVATION

- 1 Press **▼**, enter **051** using the keypad.
- 2 Using the keys **▼** and **▲** within the navigator, select option **ON** and confirm your choice with **OK**.
- 3 Quit this menu by pressing the  button.

Printing rerouted documents



Important

The printing is not possible on A5 (or Statement) paper format.



Important

This menu is only accessible when the function FAX ARCHIVING is activated.

▼ 052 - MEDIA / FAX ARCHIVING / PRINT

- 1 Press **▼**, enter **052** using the keypad.
- 2 Using the keys **▼** and **▲**, select the option **ON** to print all rerouted documents automatically.
- 3 Confirm your choice with **OK**.
- 4 Quit this menu by pressing the  button.

Transmission waiting queue

This function lets you obtain a recap of all documents queuing, for transmission, including those in deposit or in delayed transmission, etc.

It allows you to:

- **Consult** or **modify** the waiting queue. In this waiting queue the documents are coded the following way: Order number in the queue / document status / subscriber's telephone number. Documents may have the following status:
 - **TX**: transmission
 - **REL**: relay
 - **DOC**: in deposit
 - **POL**: polling
 - **MBX**: send to mailbox
 - **PMB**: mailbox polling
 - **TR**: ongoing commands
 - **SMS**: SMS transmission
- **Immediately perform** a transmission from the waiting queue,
- **Print a document** in storage, waiting to be transmitted or in deposit,
- **Print the waiting queue**, in order to get the status of each document in the queue, by either:
 - queue order number,
 - document name or number,
 - scheduled transmission time (fax),
 - operation type regarding the document: transmission from memory, delayed transmission, deposit,
 - number of pages of the document,
 - document size (percentage of space stored in memory)
- **Cancel** a transmission request in the waiting queue.

Performing immediate transmission from the waiting queue

▼ 61 - COMMANDS / PERFORM

- 1 Press **▼**, enter **61** using the keypad.
- 2 Select the document in the waiting queue.
- 3 Confirm your choice with **OK** or  to immediately perform the selected transmission.

Consulting or modifying the waiting queue

▼ 62 - COMMANDS / MODIFY

- 1 Press **▼**, enter **62** using the keypad.
- 2 In the waiting queue select the required document and confirm your choice with **OK**.
- 3 You may now modify the parameters of the given document then confirm your modifications by pressing .

Deleting a transmission on hold

▼ 63 - COMMANDS / CANCEL

- 1 Press **▼**, enter **63** using the keypad.
- 2 In the waiting queue select the desired document and confirm your choice with **OK**.

Printing a document in waiting or in deposit

▼ 64 - COMMANDS / PRINT

- 1 Press **▼**, enter **64** using the keypad.
- 2 In the waiting queue select the desired document and confirm your choice with **OK**.

Printing the waiting queue

▼ 65 - COMMANDS / PRINT LIST

Press **▼**, enter **65** using the keypad.



Note

You can also print the waiting queue with menu **▼ 57 - PRINT / COMMANDS**.



A document called **** COMMAND LIST **** is printed.

Canceling a transmission in progress

Canceling a transmission in progress is possible no matter what the type of transmission but varies depending on whether the transmission is a single call number or a multi-call number.

- For a single call number from the memory, the document is erased from the memory.
- For a multi-call number, only the call number in progress at the time of the cancellation is erased from the transmission queue.

To cancel transmission in progress:

- 1 Press . A message will ask you to confirm cancellation.
- 2 Press  to confirm cancellation in progress.

If your machine is set to print a transmission report, it will print that the communication was cancelled by the user.

MailBoxes (MBX Fax)

There are 32 mailboxes (MBX), enabling you to transmit documents in complete confidence using an access code (named MBX code), to all subscribers equipped with a fax compatible to yours.

MBX 00 is public. It is handled directly by the terminal to record the messages of the fax TAD as soon as this is put into service.

MBX's 01 to 31 are private. Each is password-protected. They can be used to receive documents confidentially.

The use and access to MBX 01 - 31 are conditioned by the initialisation, defined by a MBX code (if needed) and a mnemonic (its S.I.D.).

Later you may:

- modify the features of an MBX,
- print the contents of an MBX, only possible if the MBX contains one or more documents (with a star next to the MBX). When the contents of an MBX have been printed it becomes empty,
- delete an MBX, only if the MBX is initialised and empty,
- print the list of your fax machine's MBX's.

You may receive and send through an MBX in complete confidentiality.

When depositing a document into your MBX, the access code is not needed. All documents deposited in a MBX are added to the ones already present.

In polling, the MBX's are only accessible with an MBX code.

You may perform MBX deposits or polls by:

- depositing a document in a fax MBX,
- transmitting to deposit a document in a remote fax MBX,
- performing document poll from a remote fax.

Creating an MBX

▼ 71 - MAILBOXES / CREATE MBX

- 1 Press **▼**, enter **71** using the keypad.
- 2 Select a free MBX out of the 31 MBX or directly enter the number of a free MBX and confirm with **OK**.
- 3 Select option **MAILBOX CODE** and press **OK**. Value 0000 is always displayed.
- 4 Enter the code of your choice, if needed, and press **OK**.
- 5 Select option **MAILBOX NAME** and press **OK**.
- 6 Enter this MBX's S.I.D. (20 characters max.) and press **OK**. The MBX is initialised. If you wish to initialise another, press **C** and repeat the same procedure.
- 7 To exit the MBX, press .

Modifying the features of a MBX

▼ 71 - MAILBOXES / CREATE MBX

- 1 Press **▼**, enter **71** using the keypad.
- 2 Select the desired MBX out of the 31 MBX's, or enter the number of the MBX directly and press **OK**.
- 3 Enter the code of this MBX, if there is one, and confirm with **OK**.
- 4 Select the menu **MAILBOX CODE** or **MAILBOX NAME**, then confirm your choice with **OK**.
- 5 Perform data modification of the menu and confirm with **OK**.

If needed, repeat the last two steps for the other menu.

Printing the contents of a MBX

▼ 73 - MAILBOXES / PRINT MBX

- 1 Press **▼**, enter **73** using the keypad.
- 2 Select the desired MBX out of the 31 MBX's, or enter the number of the MBX directly and press **OK**.
- 3 Enter the code of this MBX, if there is one, and confirm with **OK**.

All documents found in the MBX are printed and the MBX is emptied.

Deleting a MBX

Before deleting an MBX, you need to make sure it is empty, by printing its content.

▼ 74 - MAILBOXES / DELETE MBX

- 1 Press **▼**, enter **74** using the keypad.
- 2 Select the desired MBX out of the 31 MBX's, or enter the number of the MBX directly and press **OK**.
- 3 Enter the code of this MBX, if there is one, and confirm with **OK**.
- 4 Press **OK** to confirm the MBX deletion.

The MBX is deleted and will appear as a free MBX in the list.

Printing the MBX list

▼ 75 - MAILBOXES / PRT MBX LIST

Press **▼**, enter **75** using the keypad.



Note

You can also print the MBX list with menu
▼ 58 - PRINT / LIST MBX.

The list gives the status of each MBX.

MBX deposit in your fax

- 1 Insert the document in the fax machine's feeder.
- 2 Select **▼ 72 - MAILBOXES / DEPOSIT MBX**.
- 3 Select the desired MBX out of the 31 MBX's, or enter the number of the MBX directly and press **OK**.

The document is placed in the feeder and saved in the selected MBX.

MBX deposit in a remote fax

- 1 Insert the document in the fax machine's feeder.
- 2 Select **▼ 35 - FAX / MBX SENDING**.
- 3 Enter your subscriber's number for MBX deposit or choose your dialling mode and validate with **OK**.
- 4 Enter the subscriber's MBX number and confirm with **OK**.
- 5 If you wish to delay transmission, enter the new transmission time next to the current time and press **OK**.
- 6 If you wish to modify the document feed type, select one of the options **FEEDER** or **MEMORY**, and press **OK**.
- 7 If you wish, you may enter the number of pages of your document before transmitting and confirm with **OK**.
- 8 Confirm the transmission request to a remote MBX fax by pressing .

In the case of an immediate transmission, the document is sent immediately.

If the document is set for a postponed transmission, the document will be stored in the memory and sent at the requested time.

MBX polling from a remote fax

▼ 36 - FAX / MBX POLLING



Note

Please check for remote fax compatibility.

- 1 Press **▼**, enter **36** using the keypad.
- 2 Enter your subscriber's number for MBX polling or choose your dialling mode and confirm with **OK**.
- 3 Enter the subscriber MBX number and press **OK**.
- 4 Enter this MBX access code and press **OK**.
- 5 If you wish to delay the poll time, enter the departure time next to the current time and press **OK**.
- 6 Confirm the MBX poll request by pressing .

As soon as the remote fax is subscribed, either immediately or later, the document(s) in the remote fax MBX are received in your fax.

Deposit and Polling

You may **deposit** a document in your fax and keep it available to one or more subscribers who can obtain a fax of this document by calling your fax with the **POLL** function.

Setting the machine for document deposits, you must define the type:

- **SIMPLE**- it may be polled only once from the memory or feeder,
- **MULTIPLE**- it may be polled as many times as necessary from the memory.

Setting the machine for polled documents, you must define the poll number, then depending on the type of poll you may:

- launch an immediate poll,
- program a delayed poll with a chosen time,
- launch a multi-poll, either immediately or later.

Placing a document in deposit

- 1 Insert the document to deposit in the feeder.
- 2 Select **▼ 34 - FAX / POLLING TX**.
- 3 Choose the deposit type, according to the table below:



Menu	Procedure
Simple	<ol style="list-style-type: none"> 1 Select FEEDER or MEMORY. 2 If necessary, adjust the contrast and confirm with OK. 3 Enter the number of pages that you wish to deposit.
Multiple	<ol style="list-style-type: none"> 1 If necessary, adjust the contrast and confirm with OK. 2 Enter the number of pages that you wish to deposit.

- 4 Confirm deposit by pressing **OK**.

Polling a deposited document

▼ 33 - FAX / POLLING RX

- 1 Select **▼ 33 - FAX / POLLING RX**.
- 2 Enter the number of the party whose document you want to poll or choose your dialling mode.
You can poll several documents using the key .
- 3 Depending on the type of poll, you should:

Menu	Procedure
Immediate poll	<ol style="list-style-type: none"> 1 Press .
Delayed poll	<ol style="list-style-type: none"> 1 Press OK. 2 Next to the current time, enter the time you wish to poll the document and press .

SMS



Important The SMS service is dependent upon the country and the service provider.

Thanks to the **SMS** button, you can send an SMS to subscribers all over the world. An SMS (Short Message Service) is a service which permits short written messages to be sent to mobile phones or other SMS-compatible devices.

The number of characters you can send per message is dependent upon the service provider and the country you are sending your SMS from (e.g. France 160 characters, Italy 640 characters).



Note There is a special scale of charges for the SMS service.

SMS Parameters

Presentation of the sender

This setting allows you to show the name or the number of the sender when sending an SMS.

▼ 41 - SMS SERVICE / SENDER

- 1 Press ▼, enter **41** using the keypad.
- 2 Select the required presentation of the sender option, **ON** or **OFF**, using the ▼ or ▲ keys.
- 3 Validate with **OK**.



SMS Center transmission number

This setting allows you to enter the transmission number for the SMS Server. Your Internet provider will provide you with this number.

▼ 421 - SMS SERVICE / INIT. SMS / SERVER

- 1 Press ▼, enter **421** using the keypad.
- 2 Enter the number of the transmission server using the numerical keypad.
- 3 Validate with **OK**.

Sending an SMS

- 1 Press the  key.
- 2 Write your SMS using the alphabetical keypad. To do so, an editor is at your disposal:
 - for upper case letters, use the ↑ key,
 - to move inside the data entry field, use ▼ and ▲,
 - to move in the text from one word to another, press **CTRL** and one of the navigator keys (▼ or ▲).
 - to go to the next line, use ↵,
 - to delete a character (by moving the cursor to the left), use ← or C.
- 3 Validate with **OK**.
- 4 Dial the number of the recipient (mobile phone or any other SMS-compatible device) in one of the following ways:
 - dial the number using the numerical keypad,
 - enter the first letters of the recipient name,
 - press the  key until the required name appears (names are classified in alphabetical order).

Your SMS may be sent to only one person or to several people. To send an SMS:

- to only one person, press **OK** to confirm.
- to several people:
 - 5 Press the  key and enter the next recipient's number.
 - 6 Repeat the operations as many times as required (10 persons max.). Press **OK** to validate the last recipient; "**SENDING SMS**" is displayed as the SMS is being sent.
- If **SMS** appears, then the SMS has been put on hold and a further attempt will take place a couple of minutes later. To immediately execute or cancel transmission, refer to paragraph **Transmission waiting queue**, page 26.
- To check the SMS has been sent properly, you may print the transmission/reception log (refer to paragraph **Printing the logs**, page 36).

Parameters/ Setup

You can setup your machine as you like depending on the use. You will find in this chapter description of the functions.

You can print the functions guide and the available setup of your multifunction machine.



Note

Your machine is continuously being updated, new functions are regularly made available.

To benefit, visit our website www.sagem-communications.com. You can also use the update function available with the Companion Suite Pro software to download the latest online updates (see **Firmware update**, page 78).

Date/Time

At any moment you may change the date and time on your multifunction machine.

Depending on the country configured on the machine, the date format is of type DDMMYY (e.g.: France) or MMDDYY (e.g.: USA).

▼ 21 - SETUP / DATE/TIME

- 1 Press ▼, enter **21** using the keypad. Confirm with **OK**.
- 2 Enter the numbers of the required time and date one after another (for example November 8 2004 at 9h33, press 0811040933 or 1108040933) and press **OK** to confirm.
- 3 To exit this menu, press .

Summer time / Winter time setting

This menu lets you choose to change to summer / winter time automatically or not.



Important

This function is only available if the country configured on the machine is part of the European Union.

The **21>DATE/TIME** menu includes 2 submenus:

Manual mode

▼ 211 - SETUP / DATE/TIME / MODIFY

Your multifunction machine will prompt you to change the date and time via the numerical keypad.

Automatic mode

▼ 212 - SETUP / DATE/TIME / AUTO ADJUST

If you select **OFF** and confirm with **OK**, the summer / winter time will not be changed automatically. For the machine to be set to the new time, you will need to use the **211 MODIFY** menu.

If you select **ON** and confirm with **OK**, you will not have to care about any change at the end of March (+1h) and October (-1h). You will just be informed of this change by a message on the screen.

The default parameter is **OFF**.

Warning message

On automatic changing to summer / winter time, a message will be displayed to inform you that the multifunction machine time has been changed.

25-03-07 02:01
CHECK TIME

or

28-10-07 02:01
CHECK TIME

Your next action on the multifunction keypad will cause the message to be automatically cleared.

Your fax number/Your name

Your multifunction machine will print out your fax number and your name on each document it transmits if you save these settings.

To benefit from this feature, you must set **SENDING HEADER** to **ON** (see **Technical Parameters**, page 35).



Important

The **SENDING HEADER** feature is by default activated on the US model and cannot be modified.

To save your fax number and name:

▼ 22 - SETUP / NUMBER/NAME

- 1 Press ▼, enter **22** using the keypad.
- 2 Enter your fax number (20 digits max.) and press **OK** to confirm.
- 3 Enter your name (20 characters max) then press **OK** to confirm.

For example, if you want to type the letter C, press the key **C** until it appears on the screen.

- 4 To exit this menu, press .

Type of network

You can connect your fax to either a PSTN or a private network such as private automatic branch exchange (PABX). You must select the network which is the most convenient.

To select the type of network:

▼ 251 - SETUP / TEL. NETWORK / NETWORK TYPE

- 1 Press \blacktriangledown , enter **251** using the keypad.
- 2 Select option **PABX** or **PSTN** then confirm your choice with **OK**.
- 3 To exit this menu, press .

If you are connecting your machine to a private network, behind a company's PABX, you may need to specify a local prefix (see **Local prefix**).

Geographical settings

These settings will enable you to use your machine in different preset countries using different languages.

Country

By choosing a country, you initialise:

- the settings for the public telephone network,
- the language by default.

To select the country:

▼ 201 - SETUP / GEOGRAPHICAL / COUNTRY

- 1 Press \blacktriangledown , enter **201** using the keypad.
- 2 Select the required option and press the **OK** key to confirm.
- 3 To exit this menu, press .



If none of the options in the list is suitable, select the "OTHER" option.

Telecommunication Network

This setting enables you to manually set the type of public telephone network (PSTN) for a country, so that your machine can communicate over the public telephone network in compliance with the applicable standards.

By default, setting a country using the ▼201 command automatically sets the type of PSTN to use in the selected country.



*These settings are different from the **NETWORK TYPE**, which allows you to choose between public and private network.*

To manually select the type of public telephone network:

▼ 202 - SETUP / GEOGRAPHICAL / NETWORK

- 1 Press \blacktriangledown , enter **202** using the keypad.
- 2 Select the required option and press the **OK** key to confirm.
- 3 To exit this menu, press .

If none of the options in the list is suitable, select the "OTHER X" option:

- OTHER 1 = TRB21
- OTHER 2 = US
- OTHER 3 = Russia
- OTHER 4 = Jordan
- OTHER 5 = Israel
- OTHER 6 = TRB21



Important

Language

This setting enables you to choose the menu language of your choice. By default, the multifunction machine is set to English.

To select the language:

▼ 203 - SETUP / GEOGRAPHICAL / LANGUAGE

- 1 Press \blacktriangledown , enter **203** using the keypad.
- 2 Select the required language using \blacktriangledown and \blacktriangle , then press the **OK** key to confirm.
- 3 To exit this menu, press .

Local prefix

This function is used when your fax is installed with a private network, behind a company's PABX. It allows you to program an additional automatic **local prefix** (to be defined), enabling you to automatically exit the company's telephone network system, but only under certain conditions:

- the company's internal numbers, where a prefix is not required, must be short numbers less than the **minimal size** (to be defined, for example France has 10 digits),
- the outside numbers requiring a prefix, must be long numbers greater or equal to the **minimal size** (to be defined, for example France has 10 digits).

Programming your fax with the local prefix consists of two steps:

- 1 defining the **minimal size** (or equal) of the company's outside numbers,
- 2 defining the outgoing **local prefix** of the company's telephone network. This prefix will automatically be added as soon as an external number is dialled.

**Important**

If you define a local prefix, do not add it to the numbers stored in the directory, it will be automatically dialed with each number.

▼ 252 - SETUP / TEL. NETWORK / PREFIX

- 1 Press **▼**, enter **252** using the keypad.
- 2 Enter the required minimal **SIZE NUMBER** of the company's outside numbers and confirm with **OK**. The minimal size will range between 1 and 30.
- 3 Enter the required outgoing local **PREFIX** of the company's telephone network (maximum 10 characters) and confirm with **OK**.

**Note**

*To insert a pause for dial tone ("/" sign), press simultaneously the **CTRL** and **M** keys, or long press the 0 (zero) key on the numerical keypad until the "/" sign is displayed.*

- 4 To exit this menu, press

Transmission report

You may print a **transmission report** for all communications over the telephone network (PSTN).

You may choose between more than one criteria for printing reports:

- **ON**: a report is given when the transmission was properly performed or when it is completely abandoned (but there is only one report per request),
- **OFF**: no transmission report, however, your fax will note all transmissions that took place in its log,
- **ALWAYS**: a report is printed with each transmission,
- **ON ERROR**: a report is printed only if the transmission failed or is abandoned.

With each transmission report from memory, a reduced version of the first page is automatically reproduced.

To select the report type:

▼ 231 - SETUP / SEND / SEND REPORT

- 1 Press **▼**, enter **231** using the keypad.
- 2 Select the required option **ON**, **OFF**, **ALWAYS** or **ON ERROR** and confirm your choice with **OK**.
- 3 To exit this menu, press .

Document feed type

You may choose the way you want to feed your documents:

- from **memory**, transmission will take place only after memory storage of the document and dialling. It allows you to get your originals back quickly to free up the machine.
- from the **feeder** of the sheet-feed scanner, transmission will occur after dialling and paper scanning. It allows transmission of larger documents.

To select the way you want to feed your documents:

▼ 232 - SETUP / SEND / MEMORY SEND.

- 1 Press **▼**, enter **232** using the keypad.
- 2 Select the option **MEMORY** or **FEEDER** and confirm your choice with **OK**.
In feeder mode, reduced images will not appear on the transmission report.
- 3 To exit this menu, press .

Economy period

This function allows you to defer a fax transmission to "off-peak hours" and thus reduce the cost of your communications.

The **economy period**, via the telephone network (at off-peak hours), is preset by default from 7.00 pm to 7.30 am. Nevertheless you may change this time slot.

To modify the economy period:

▼ 233 - SETUP / SEND / ECO PER.

- 1 Press **▼**, enter **233** using the keypad.
- 2 Enter the hours of the new economy period (for example 19:00-07:30) and confirm your choice with **OK**.
- 3 To exit this menu, press .

To use the economy period:

▼ 32 - FAX / ECO TRANS.

- 1 Select **▼ 32 - FAX / ECO TRANS**.
- 2 Enter the call number and confirm with **OK**.
- 3 Adjust the contrast and confirm with **OK**.
- 4 Select the feed type, **FEEDER** or **MEMORY** and confirm with **OK**.
- 5 You may enter the number of pages before transmission and confirm with **OK**.
- 6 If you are using the flatbed scanner, you can scan more than one page. Place the next page on the scanner, select **NEXT** and confirm with **OK**. Select **DONE** when all pages have been scanned.

Reception Mode

This function enables you, if you have an external device (telephone, answering machine) plugged in to the EXT socket on your terminal, via USB or to the telephone plug adapter, to select the device receiving faxes and/or voice messages.

You may choose between the following reception modes :

- **MANUAL** : the terminal does not receive any documents automatically. When you answer your telephone and realise that you are receiving a fax, you should press the  button on the terminal to receive the fax.
- **FAX** : the Fax reception mode is launched on the terminal systematically.
- **FAX-ANSWER.** : the terminal handles reception of fax messages automatically, the external device handles reception of telephone communications automatically. Press the #0 buttons on your telephone to cancel fax detection.
- **FAX-TEL** : the terminal handles reception of fax messages automatically, the DECT base (and registered handsets) handles reception of telephone communications automatically. Press the #0 buttons on your telephone to cancel fax detection.

To set the reception mode:

▼ 241 - SETUP / RECEPTION / MODE

- 1 Press ▼ , enter **241** using the keypad.
- 2 Select the required option and confirm with **OK**.
- 3 To exit this menu, press .

*If you have connected a telephone to the EXT socket on your terminal or to a telephone plug adaptor, we recommend that you set the reception mode to **MANUAL**.*

*If you have connected a DECT base to the USB port of your terminal, we recommend that you set the reception mode to **FAX-TEL**.*



When you receive a call, you pick up using this telephone and you hear the particular fax tone. You can:

- press the  button on your terminal or buttons #7 on your telephone to receive the fax.

Reception without paper

Your fax offers you the possibility to either accept or refuse document reception if your printer is unavailable (no paper...).

If your fax printer is unavailable, you may choose between two modes of reception:

- reception mode **WITHOUT PAPER**, your fax saves the incoming messages in the memory,
- reception mode **WITH PAPER**, your fax refuses all incoming subscribers.

To select the reception mode:

▼ 242 - SETUP / RECEPTION / REC. PAPER

- 1 Press ▼ , enter **242** using the keypad.
- 2 Select the option **WITH PAPER** or **WITHOUT PAPER** and confirm your choice with **OK**.
- 3 To exit this menu, press .

Paper out is indicated by a beep and a message on the screen.



Received faxes are then stored in memory (icon  flashing) to be printed as soon as you add paper into the feeder.

Number of copies

You may print incoming documents more than once (1 to 99).

To set the number of each document received:

▼ 243 - SETUP / RECEPTION / NBR OF COPIES

- 1 Press ▼ , enter **243** using the keypad.
- 2 Enter the wanted number of copies and confirm with **OK**.
- 3 To exit this menu, press .

At each document reception, your fax will print the number of copies requested.

Fax or PC reception

This menu, combined with a software program installed on your PC will enable you to select the machine you wish to receive the documents on:

- fax,
- PC,
- PC if available, fax otherwise.

▼ 244 - SETUP / RECEPTION / PC RECEPT.

For more details, please refer to **Fax communications**, page 63 in chapter PC Features.

Adjust to page

This menu allows you to print out received faxes automatically adjusting them to the page format. Received faxes are then automatically reduced or enlarged to fit the page format which is used on the machine.

To turn adjust to page mode on:

▼ 245 - SETUP / RECEPTION / AUTO ADJUST.

- 1 Press ▼, enter **245** using the keypad.
- 2 Select the option **ON** or **OFF** and confirm with **OK**.
- 3 To exit this menu, press .

Received faxes reduction mode

This menu allows you to reduce received faxes for printing. This adjustment can be automatic or manual.

Automatic mode:

This mode automatically resizes received faxes.

To set automatic mode:

▼ 246 - SETUP / RECEPTION / REDUCTION

- 1 Press ▼, enter **246** using the keypad.
- 2 Select **AUTOMATIC** and confirm with **OK**.
- 3 To exit this menu, press .

Manual mode:

The machine proposes a 70 to 100 % reduction. Outside these values, the machine beeps for error. This fixed reduction will be used when printing received documents, regardless of the used paper format.

To set the manual mode:

▼ 246 - SETUP / RECEPTION / REDUCTION

- 1 Press ▼, enter **246** using the keypad.
- 2 Select **FIXED** and confirm with **OK**.
- 3 Enter the reduction value (between 70 and 100) and confirm with **OK**.
- 4 To exit this menu, press .

Technical Parameters

As delivered your machine is preset by default. However, you may adjust it to meet your requirements by resetting the technical parameters.

To set the technical parameters:

▼ 29 - SETUP / TECHNICALS

- 1 Press ▼, enter **29** using the keypad.
- 2 Select the desired parameter and confirm with **OK**.

- 3 With the keys ▼ or ▲, modify the parameter settings by following the table below and press **OK**.

Parameter	Signification
1 - Scanning mode	Default value of the scan mode resolution for the documents to be transmitted.
2 - TX header	<p>Important: this parameter is by default activated on the US model and cannot be modified.</p> <p>If this parameter is on, your header will appear on all documents sent to your subscribers with your name, number, date and number of pages.</p> <p>Warning: If you send a fax from the document loader, the transmission header will not appear on the document your correspondent receives.</p>
3 - TX speed	<p>Transmission speed for outgoing documents.</p> <p>For a quality telephone line (compatible, no echo), communications occur at maximum speed.</p> <p>However, it may be necessary to restrict the transmission speed for some calls.</p>
4 - Echo protect	If this parameter is on, the on-line echo will be reduced during long distance calls.
6 - EPT mode	For some long distance calls (satellite), the on-line echo may disturb the call.
7 - COM. display	Choice between transmission speed displayed or number of the page in progress.
8 - Eco energy	<p>Choosing the printer standby delay: the printer will switch to standby after a delay (in minutes) of NON-operation or during the period of time of your choice.</p> <p>Note: you can also access this parameter by pressing the  key from the idle screen.</p>
10 - RX header	If this parameter is on, all documents received by your fax will include the subscriber's header with his/her name, number (if available) fax print date and the page number.

Parameter	Signification
11 - RX speed	Transmission speed for incoming documents. For a quality telephone line (compatible, no echo), communications occur at maximum speed. However, it may be necessary to restrict the transmission speed for some calls.
12 - Rings	Number of rings to automatically start your machine.
13 - Discard size	The Discard Size parameter only defines the printing of received faxes. The number of lines of a document can be too high for the printing paper format. This parameter defines the threshold beyond which the extra lines are printed on a second page. Below this threshold, extras lines are deleted. If you choose ON , the threshold is set on 3 centimeters. If you choose OFF , the threshold is set on 1 centimeter.
20 - E.C.M.	This parameter helps correct the calls made on disturbed telephone lines. It is used when the lines are weak or too noisy. Transmission times may be longer.
25 - TEL Impedance	This parameter lets you choose between a complex impedance and a 600 Ohm impedance, depending on the telephone network your terminal is connected to.
80 - Toner save	Makes printing lighter to save toner cartridge ink.
90 - RAW Port	RAW network print port connection.
91 - Printer error timeout	Time-out before document being printed is deleted following a print error in PC print mode.
92 - Printer wait timeout	Wait time-out for data from PC before the task is deleted in PC print.
93 - Replace format	Page format change. This parameter allows you to print a LETTER format document on A4 pages using the LETTER/A4 setting.
96 - NBR. WEP Keys	Number of WEP keys allowed (from 1 to 4).

Printing the functions guide



Important

The printing is not possible on A5 (or Statement) paper format.

▼ 51 - PRINT / FUNCTIONS LIST

Press ▼, enter **51** using the keypad.

The printing of the functions guide starts.



Note

*You can also access the **PRINT** menu by pressing the  button.*

Printing the logs



Important

The printing is not possible on A5 (or Statement) paper format.

The incoming and outgoing logs list the last 30 transmissions (incoming and outgoing) made by your machine.

An automatic print out will take place after every 30 transmissions. However, you may request a print out at any time.

Each log (incoming or outgoing) contains a table with the following information:

- date and time of the incoming or outgoing document,
- subscriber's number or E-mail address,
- transmission mode (**Normal**, **Fine**, **SFine** or **Photo**),
- number of pages sent or received,
- call duration,
- incoming or outgoing results: noted **CORRECT** if properly transmitted,
or
information codes for special calls (polling, manual subscribers, etc.)
- reason for call error (example: your subscriber does not answer).

To print the logs:

▼ 54 - PRINT / LOGS

Press ▼, enter **54** using the keypad.

The printing of the logs starts. The incoming and outgoing logs are printed on the same page.



Note

*You can also access the **PRINT** menu by pressing the  button.*

Print the list of setups



Important

The printing is not possible on A5 (or Statement) paper format.

To print the list of setups:

▼ 56 - PRINT / SETUP

Press ▼, enter **56** using the keypad.

The printing of the list of setups starts.



Note

*You can also access the **PRINT** menu by pressing the button.*

Lock the machine

This function prevents non-authorized people from accessing the machine. An access code will be required every time someone wants to use the device. After each use, the device will lock automatically.

Before that you have to enter a lock code.

▼ 811 - ADVANCED FCT / LOCK / LOCKING CODE

- 1 Press ▼, enter **811** using the keypad.
- 2 Enter your lock code (4 digits) with the keyboard, confirm with **OK**.



Important

If a code is already registered, enter the old code before typing the new one.

- 3 Enter again your lock code (4 digits) with the keyboard, confirm with **OK**.
- 4 Quit this menu by pressing the button.

Lock the keyboard

Every time you use your machine, you will have to enter your code.

▼ 812 - ADVANCED FCT / LOCK / LOCK KEYBD.

- 1 Press ▼, enter **812** using the keypad.
- 2 Enter the four-digit locking code with the keypad.
- 3 Press **OK** to confirm.
- 4 With the buttons ▼ or ▲, choose **ON** and confirm with **OK**.
- 5 Quit this menu by pressing the button.

Lock the numbers

This function locks dialling and the numerical keypad is disabled. Transmissions are only possible from numbers included in the directory.

To access the number interlocking option:

▼ 813 - ADVANCED FCT / LOCK / LOCK NUMBER

- 1 Press ▼, enter **813** using the keypad.

- 2 Enter the four-digit locking code with the keypad.
- 3 Press **OK** to confirm.
- 4 With the buttons ▼ or ▲, choose **DIRECT ONLY** and confirm with **OK**.
- 5 Quit this menu by pressing the button.

Lock the SMS service

This function prevents access to the SMS service.

To access the SMS service locking menu:

▼ 815 - ADVANCED FCT / LOCK / LOCK SMS

- 1 Press ▼, enter **815** using the keypad.
- 2 Enter the four-digit locking code with the keypad.
- 3 Press **OK** to confirm.
- 4 With the buttons ▼ or ▲, choose **ON** and confirm with **OK**.
- 5 Quit this menu by pressing the button.

Lock the Media service

This function prevents access to the Media service. The access code will be required every time someone wants to use the USB key functions:

- analyse the contents of a connected USB key,
- print from a USB key, delete files,
- archive received faxes on a USB key.

To access the Media service locking menu:

▼ 816 - ADVANCED FCT / LOCK / LOCK MEDIA

- 1 Press ▼, enter **816** using the keypad.
- 2 Enter the four-digit locking code with the keypad.
- 3 Press **OK** to confirm.
- 4 With the buttons ▼ or ▲, choose **ON** and confirm with **OK**.
- 5 Quit this menu by pressing the button.

Read the counters

This function allows you to view the activity counters for your machine at any time.

According to your needs, you can read the counters for:

- sent pages,
- received pages,
- scanned pages,
- printed pages.

Sent pages counter

To view the number of pages sent from your machine:

▼ 821 - ADVANCED FCT / COUNTERS / SENT PAGES

- 1 Press ▼, enter **821** using the keypad.
- 2 The number of sent pages appears on the screen.
- 3 Quit this menu by pressing the button.

Received pages counter

To view the number of pages received on your machine:

▼ 822 - ADVANCED FCT / COUNTERS / RECEIVED PG

- 1 Press ▼, enter **822** using the keypad.
- 2 The number of received pages appears on the screen.
- 3 Quit this menu by pressing the  button.

Scanned pages counter

To view the number of pages scanned on your machine:

▼ 823 - ADVANCED FCT / COUNTERS / SCANNED PAGE

- 1 Press ▼, enter **823** using the keypad.
- 2 The number of scanned pages appears on the screen.
- 3 Quit this menu by pressing the  button.

Printed pages counter

To view the number of pages printed on your machine:

▼ 824 - ADVANCED FCT / COUNTERS / PRINTED PG

- 1 Press ▼, enter **824** using the keypad.
- 2 The number of printed pages appears on the screen.
- 3 Quit this menu by pressing the  button.

Display the consumables status

You can read at any time the remaining toner in the cartridge. This level appears in percentage.

▼ 86 - ADVANCED FCT / CONSUMABLES

- 1 Press ▼, enter **86** using the keypad.
- 2 The available toner percentage appears on the screen.
- 3 Quit this menu by pressing the  button.

Calibrate your scanner

You can do this operation when the quality of photocopied documents is not satisfactory anymore.

▼ 80 - ADVANCED FCT / CALIBRATION

- 1 Press ▼, enter **80** using the keypad. Confirm with **OK**.
- 2 The scanner is triggered and a calibration is done automatically.
- 3 At the end of the calibration, the machine comes back to the screen saver.

Directory

Your multifunction machine lets you create a directory by memorising subscriber records and subscriber lists. Your machine can store up to 250 subscriber records, which you can group in 20 subscriber lists.

For all subscriber records or subscriber lists you may create, consult, modify or delete contents. You can also print the directory.

Furthermore, your machine lets you create and manage your phone directory from your PC Kit. For more information on this feature, refer to chapter **PC Features**, page 52.

Creating subscribers record

To create subscribers record:

▼ 11 - DIRECTORY / NEW CONTACT

- 1 Press ▼, enter **11** using the keypad.
- 2 Enter the **NAME** of your contact with the alphanumeric keypad (20 characters maximum), confirm with **OK**.
- 3 Enter the **TEL** number of your contact with the numerical keypad (30 digits maximum), confirm with **OK**.
- 4 Choose the **RECORD NO** from your directory with the numerical keypad or accept the displayed number, and confirm with **OK**.
- 5 Select **W. ASSOC. KEY** if you want to assign a shortcut key (letter) to your subscriber record. The first available letter appears, use ▼ or ▲ to choose another letter. Confirm with **OK**.
- 6 Select the appropriate transmission **RATE** to send faxes among the values 2400, 4800, 7200, 9600, 12000, 14400 and 33600 using ▼ or ▲. Confirm with **OK**.
The maximum speed can be used if the telephone line is of good quality, meaning appropriate, without echo.

If your multifunction machine is connected to a PABX, you may insert a pause for dial tone after the outgoing local prefix dialling.



Important

*To insert a pause for dial tone ("") sign), press simultaneously the **CTRL** and **M** keys, or long press the 0 (zero) key on the numerical keypad until the "" sign is displayed.*

*For more details, refer to **Local prefix**, page 32.*

Creating subscribers list

To create subscribers list:

▼ 12 - DIRECTORY / NEW GROUP

- 1 Press ▼, enter **12** using the keypad.
- 2 Enter the **LIST NAME** with the alphanumeric keypad (20 characters maximum), confirm with **OK**.
- 3 **CALLED NUMBER**: use ▼ or ▲ to select from existing records the contacts of your list and confirm with **OK**. Repeat this operation for each subscriber you want to add to your list.
- 4 Enter the **GROUP NUMBER** assigned to your list with the numerical keypad or accept the displayed number, and confirm with **OK**.



Important

*In the directory, the letter **G** placed next to a name identifies a subscribers group.*

Modifying a record

To modify a subscribers record or list:

▼ 13 - DIRECTORY / MODIFY

- 1 Press ▼, enter **13** using the keypad.
- 2 With ▼ or ▲, browse the directory and select the record or list you want to modify by pressing **OK**.
- 3 With ▼ or ▲, browse the entries of the selected record or list. Press **OK** when the entry you want to modify appears on screen.
- 4 The cursor appears at the end of the line. Press **C** to delete characters.
- 5 Enter the new entry and confirm with **OK**.
- 6 Repeat the operations for each line you want to modify.

Deleting a record or a list

To delete a subscribers record or list:

▼ 14 - DIRECTORY / CANCEL

- 1 Press ▼, enter **14** using the keypad.
- 2 With ▼ or ▲, browse the directory and select the record or list you want to delete by pressing **OK**.
- 3 Press **OK** to confirm the deletion.
- 4 Repeat the operations for each record or list you want to delete.

Printing the directory



Important

The printing is not possible on A5 (or Statement) paper format.

To print the directory:

▼ **15 - DIRECTORY / PRINT**

Press ▼, enter **15** using the keypad.

The printing of the directory starts, in alphabetical order.



Note

*You can also print the directory with menu ▼ **55 - PRINT / DIRECTORY**.*

Saving/Restoring the directory (Smart card option)

This function enables you to save the contents of your directory on a Smart card and restore them on your machine.



Important

This function is only available to service technician with Smart card.

To **save** the contents of your directory on your Smart card:

▼ **161 - DIRECTORY / SAVE/LOAD / SAVE**

- 1 Press ▼, enter **16** using the keypad.
- 2 Select **SAVE** to save directory entries on the Smart card and confirm with **OK**.
- 3 Insert your Smart card.

To **restore** the contents of your directory from your Smart card:

▼ **162 - DIRECTORY / SAVE/LOAD / LOAD**

- 1 Press ▼, enter **16** using the keypad.
- 2 Select **LOAD** to restore directory entries from the Smart card and confirm with **OK**.
- 3 Confirm with **OK**.
- 4 Insert your Smart card.

Games and Calendar

Sudoku

Sudoku is a Japanese puzzle. The game is in a grid format of three squares by three squares to be distributed in fields in zones of 3 × 3. Depending on the level of difficulty, more or fewer numbers are already entered at the start of the game. The aim of the game is to distribute the numbers 1 to 9 between the boxes in such a way that each number appears only once in each row, column and in each of the nine grids. There is only one solution.

Print a grid

There are 400 Sudoku grids available in total, 100 for each difficulty level.

 **Important** *The printing is not possible on A5 (or Statement) paper format.*

▼ 521 - PRINT / SUDOKU / PRINT GRID

- 1 Press ▼, enter **5** using the keypad. Confirm with **OK**.



Note

*You can also access the **PRINT** menu by pressing the  button.*

- 2 Select **SUDOKU** using the ▼ or ▲ button.
- 3 Confirm with **OK**.
- 4 Select **PRINT GRID** using the ▼ or ▲ button.
- 5 Select the level of difficulty **EASY, MEDIUM, HARD, EVIL** using the ▼ or ▲ button.
- 6 Confirm with **OK**.
- 7 Choose the grid you want by entering the number on the numeric keypad (1 to 100).
- 8 Confirm with **OK**.
- 9 Choose the number of copies you want by entering a number from 1 to 9 on the numeric keypad.
- 10 Confirm with **OK**.

The number of copies of the grid requested is printed.

Print the solution to a grid

 **Important** *The printing is not possible on A5 (or Statement) paper format.*

▼ 522 - PRINT / SUDOKU / PRT SOLUTION

- 1 Press ▼, enter **5** using the keypad. Confirm with **OK**.



Note

*You can also access the **PRINT** menu by pressing the  button.*

- 2 Select **SUDOKU** using the ▼ or ▲ button.

- 3 Confirm with **OK**.
- 4 Select **PRT SOLUTION** using the ▼ or ▲ button.
- 5 Select the level of difficulty **EASY, MEDIUM, HARD, EVIL** using the ▼ or ▲ button.
- 6 Confirm with **OK**.
- 7 Choose the grid you want by entering the number on the numeric keypad (1 to 100).
- 8 Confirm with **OK**.
- 9 Choose the number of copies you want by entering a number from 1 to 9 on the numeric keypad.
- 10 Confirm with **OK**.

The number of copies of the solution to the grid requested is printed.

Calendar

This function enables you to print the calendar for a year of your choice.

 **Important** *The printing is not possible on A5 (or Statement) paper format.*

▼ 53 - PRINT / CALENDAR

- 1 Press ▼, enter **5** using the keypad. Confirm with **OK**.



Note

*You can also access the **PRINT** menu by pressing the  button.*

- 2 Select **CALENDAR** using the ▼ or ▲ button.
- 3 Confirm with **OK**.
- 4 Choose the year you want to print as calendar by entering the number on the numeric keypad (for example: 2009).



Note

*The year must be between 1900 and 2099. Use the **C** key to correct an entry.*

- 5 Confirm with **OK**.

The calendar of the year requested is printed.

Network features

You may connect your multifunction terminal to a wireless network.

However, practical knowledge of your computer configuration is required to set up a network.

You can connect your machine to a PC using a USB cable or make a wireless connection (via radio) with a PC or network.



Important
If you have a WLAN adaptor, you can incorporate your machine as a network printer into a radio network. This works only with an approved adaptor that you can obtain from our ordering department. For further information, contact www.sagem-communications.com.

Type of radio network

A radio network or WLAN (Wireless Local Area Network) is created when at least two computers, printers or other peripheral devices communicate with each other in a network via radio waves (high frequency waves). The transmission of data in the radio network is based on the standards 802.11b and 802.11g. According to how the network is set up, it may be described as an infrastructure network or an ad-hoc network.



CAUTION

Beware, when you are using a wireless connection, that certain items of medical equipment, sensitive or security systems may be affected by the radio transmissions of your device; in all cases, please follow safety guidelines closely.

Radio infrastructure network

In an infrastructure network, several devices communicate via a central access point (a gateway or router). All data is sent to the access point (gateway or router) from where it is re-distributed.

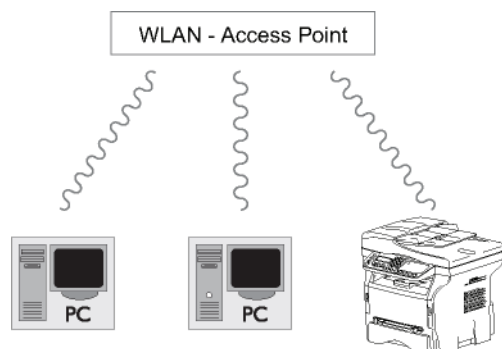

Radio ad-hoc network

In an ad-hoc network, the devices communicate directly with each other without passing through an access point. The speed of communication across the whole radio network is as fast as the weakest connection in the network. The speed of communication is also dependent on spatial distance between transmitter and receiver, as well as the number of barriers, such as walls or ceilings.



Important

Please note that in ad-hoc mode, the WPA/WPA2 encryption method is not available.

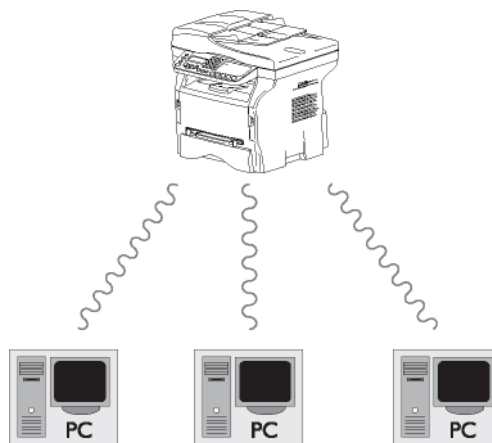

Radio networks (WLAN)

Three steps are necessary to incorporate your machine into a radio network (WLAN):

- 1 Configure the network to your PC.
- 2 Set up the parameters for your machine so that it can function in a network.
- 3 Having set up the parameters for your device, install the Companion Suite Pro software onto your PC with the necessary printer drivers.

Once the machine is incorporated into a WLAN network, you can from your PC:

- print documents on the multifunction machine from your usual applications,
- scan colour, grey scale or black and white documents on your PC.

The PC and all other devices must have their parameters set up to the same network as the multifunction machine. All the details needed for setting up the device, such as the network names (SSID), type of radio network, encryption key, IP address or subnetwork mask, must match the specifications of the network.



Important

You will find these details on your PC or on the Access Point.

To find out how to set up the parameters for your PC, please consult the users' manual for your WLAN adaptor. For large networks, please seek the advice of your network administrator.

You can be sure of perfect communication if you use an approved adaptor in conjunction with your PC.

**Note**

All of the latest printer drivers for the approved adaptor may be found on our website together with further information:

www.sagem-communications.com.

Connect your WLAN adaptor

Your machine belongs to a new generation of terminals that you can incorporate into a WLAN network using a WLAN USB key.

Your machine's network radio adaptor transmits data using the radio protocol IEEE 802.11g; it can also be incorporated into an existing IEEE 802.11b network.

When connecting to your machine, only use the approved adaptor. Other transmitting or receiving adaptors may damage your device.

**Important**

Irrespective of whether you use your machine in an infrastructure or ad-hoc network, you must set up certain network and security parameters (for example, the Service-Set-ID (SSID) and the encryption key). These must match the network's specifications.

- 1 Plug your WLAN USB key into the USB port of your machine.

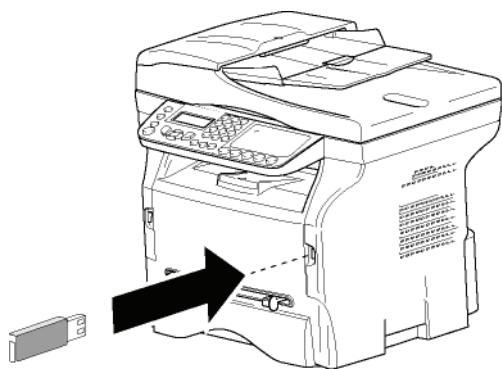

Configure your network

**Note**

We recommend that the settings of your WLAN network should only be changed by a person with a good knowledge of the configuration of your computer.

Creating or rejoining a network

Before attempting to use a WLAN adaptor on your machine, you must enter the parameters that will allow a WLAN network to recognise your machine.

On your machine you will find simple instructions that guide you step by step through the set-up of your network. Just follow them!

▼ 281 - SETUP / WLAN / CONFIG. ASS.

- 1 Type in ▼, select the menu **SETUP** using the keys ▼ or ▲ and confirm with **OK**.
- 2 Select **WLAN** using the keys ▼ or ▲ and confirm with **OK**.
- 3 Select **CONFIG. ASS.** using the keys ▼ or ▲ and confirm with **OK**.
The machine searches for existing networks.
- 4 Select your existing network, or select **NEW NETWORK** to create it, using the keys ▼ or ▲ and confirm with **OK**.

**Note**

If you choose an existing network, steps 5 and 6 (and possibly 7) are carried out automatically.

- 5 **SSID** appears on the screen, enter the name of your network using the numerical keypad, pressing the keys one after the other until you obtain the name you want (32 characters maximum) and confirm with **OK**.
- 6 **AD-HOC MODE** or **INFRA. MODE** appear on the screen. Go back to the beginning of the chapter and make your choice.
Select one of these modes and confirm with **OK**.
 - If you choose AD-HOC mode, the sub-menu **CHANNEL** appears, enter a figure between 1 and 13 (1 to 11 for the US) and confirm with **OK**.
- 7 Select your encryption method, **OFF**, **WEP** or **WPA**, and confirm with **OK**:

**Important**

Please note that in ad-hoc mode, the WPA/WPA2 encryption method is not available.

- If you choose **WEP**, enter the WEP key that you are using on your network.

**Note**

The WEP key number may be configured in the menu: ▼ 29 - **SETUP / TECHNICALS / WEP KEYS NBR**.

- If you choose **WPA**, enter the WPA or WPA2 key that you are using on your network.

- 8 **IP CONF.: MANU** or **IP CONF.: AUTO** appear on the screen.
If you choose to set up the system manually, go to the next paragraph and enter the parameters **IP ADDRESS**, **SUBNET MASK** and **GATEWAY**.
- 9 At the end of this procedure, you return to the main menu of **CONFIG. ASS.**
- 10 Exit this menu by pressing the  key.

Once the network has been set up, the LED of the WLAN USB key should be on.

Referring to or changing your network parameters

Each of the parameters of your network may be changed as your network develops.

▼ 2822 - SETUP / WLAN / PARAMETERS / IP ADDRESS

- 1 Type in ▼, select the menu **SETUP** using the keys ▼ or ▲ and confirm with **OK**.
- 2 Select **WLAN** using the keys ▼ or ▲ and confirm with **OK**.
- 3 Select **PARAMETERS** using the keys ▼ or ▲ and confirm with **OK**.
- 4 Select **IP ADDRESS** using the keys ▼ or ▲ and confirm with **OK**.
- 5 The number of your IP address will appear in the format **000.000.000.000**. Enter the new IP address for your machine in the format displayed and confirm with **OK**.
- 6 Exit this menu by pressing the  key.

▼ 2823 - SETUP / WLAN / PARAMETERS / SUBNET MASK

- 1 Type in ▼, select the menu **SETUP** using the keys ▼ or ▲ and confirm with **OK**.
- 2 Select **WLAN** using the keys ▼ or ▲ and confirm with **OK**.
- 3 Select **PARAMETERS** using the keys ▼ or ▲ and confirm with **OK**.
- 4 Select **SUBNET MASK** using the keys ▼ or ▲ and confirm with **OK**.
- 5 The number of your subnet mask will appear in the format **000.000.000.000**. Enter the new submask of your machine in the format displayed and confirm with **OK**.
- 6 Exit this menu by pressing the  key.

▼ 2824 - SETUP / WLAN / PARAMETERS / GATEWAY

- 1 Type in ▼, select the menu **SETUP** using the keys ▼ or ▲ and confirm with **OK**.
- 2 Select **WLAN** using the keys ▼ or ▲ and confirm with **OK**.

- 3 Select **PARAMETERS** using the keys ▼ or ▲ and confirm with **OK**.
- 4 Select **GATEWAY** using the keys ▼ or ▲ and confirm with **OK**.
- 5 The number of your gateway will appear in the format **000.000.000.000**. Enter the new gateway for your machine in the format displayed and confirm with **OK**.
- 6 Exit this menu by pressing the  key.

▼ 2825 - SETUP / WLAN / PARAMETERS / SSID

- 1 Type in ▼, select the menu **SETUP** using the keys ▼ or ▲ and confirm with **OK**.
- 2 Select **WLAN** using the keys ▼ or ▲ and confirm with **OK**.
- 3 Select **PARAMETERS** using the keys ▼ or ▲ and confirm with **OK**.
- 4 Select **SSID** using the keys ▼ or ▲ and confirm with **OK**.
- 5 The name of your network will appear on the screen. Enter the new name of your network and confirm with **OK**.
- 6 Exit this menu by pressing the  key.

▼ 2826 - SETUP / WLAN / PARAMETERS / MODE

- 1 Type in ▼, select the menu **SETUP** using the keys ▼ or ▲ and confirm with **OK**.
- 2 Select **WLAN** using the keys ▼ or ▲ and confirm with **OK**.
- 3 Select **PARAMETERS** using the keys ▼ or ▲ and confirm with **OK**.
- 4 Select **MODE** using the keys ▼ or ▲ and confirm with **OK**.
- 5 The symbol >>, tells you that your network is in active mode.
- 6 Select one of the modes and confirm with **OK**.
 - If you choose the AD-HOC MODE, the sub-menu **CHANNEL** will appear; enter a number between 1 and 13 (1 to 11 for the US) and confirm with **OK**.
- 7 Exit this menu by pressing the  key.

Important

In an AD-HOC network, the devices communicate directly with each other without passing through an access point. The speed of communication across the whole AD-HOC radio network is as fast as the weakest connection in the network. The speed of communication is also dependent on spatial distance between transmitter and receiver, as well as the number of barriers, such as walls or ceilings.

▼ 2827 - SETUP / WLAN / PARAMETERS / SECURITY

This parameter allows you to make your network secure by setting the encryption method to use in your WLAN network.

- 1 Type in ▼, select the menu **SETUP** using the keys ▼ or ▲ and confirm with **OK**.
- 2 Select **WLAN** using the keys ▼ or ▲ and confirm with **OK**.
- 3 Select **PARAMETERS** using the keys ▼ or ▲ and confirm with **OK**.
- 4 Select **SECURITY** using the keys ▼ or ▲ and confirm with **OK**.
- 5 Choose **WEP**, **WPA** or **OFF** and confirm with **OK**.
 - If you choose **WEP**, enter a password:
 - In a 64 bit security configuration, the password must contain five characters exactly.
 - In a 128 bit security configuration, the password must contain 13 characters exactly.

You may also enter the password using the hexadecimal system, if this is the case:

- For a 64 bit security configuration, the password must contain exactly 10 hexadecimal characters.
- For a 128 bit security configuration, the password must contain exactly 26 hexadecimal characters.



Note

- If you choose **WPA**, enter a WPA or WPA2 password (min. 8 characters to 63 characters max.). The password can contain alphanumerical characters - numbers and letters - and any other symbol available on the keypad. The only invalid character is "€" (euro currency sign).

- 6 Exit this menu by pressing the  key.

▼ 2828 - SETUP / WLAN / PARAMETERS / HOSTNAME

The machine name allows you to identify your machine on the network via a PC (for example with the name "PRINT-NETWORK-1").

- 1 Type in ▼, select the menu **SETUP** using the keys ▼ or ▲ and confirm with **OK**.
- 2 Select **WLAN** using the keys ▼ or ▲ and confirm with **OK**.
- 3 Select **PARAMETERS** using the keys ▼ or ▲ and confirm with **OK**.
- 4 Select **HOSTNAME** using the keys ▼ or ▲ and confirm with **OK**.
- 5 Type in the desired name (15 characters maximum) and confirm with **OK**.
- 6 Exit this menu by pressing the  key.

Once your connection has been set up, you must install the network printer driver on your PC so that you can print your documents.

Refer to the paragraph **Software installation**, page 52.

An example of how an AD-HOC network may be set up

An example of how to configure an Ad-hoc network without security protection using the following parameters:

- network name: "house"
- radio type: "ad-hoc"
- channel: "1"
- PC's IP address: "169.254.0.1"
- PC's subnetwork mask: "255.255.0.0"
- PC's gateway: "0.0.0.0"
- IP address of the multifunction machine: "169.254.0.2"
- subnetwork mask of the multifunction machine: "255.255.0.0"
- multifunction machine's gateway: "0.0.0.0"

Setting up a multifunction machine

- 1 Plug the WLAN USB key into the USB connector of the multifunction machine.
- 2 Type in ▼, select the menu **SETUP** using the keys ▼ or ▲ and confirm with **OK**.
- 3 Select **WLAN** using the keys ▼ or ▲ and confirm with **OK**.
- 4 Select **CONFIG. ASS.** using the keys ▼ or ▲ and confirm with **OK**.
- 5 Select **NEW NETWORK** using the keys ▼ or ▲ and confirm with **OK**.
- 6 **SSID** appears on the screen, enter "house" using the numerical keypad and confirm with **OK**.
- 7 Select the mode **AD-HOC MODE** and confirm with **OK**.
- 8 Enter "1" in the field **CHANNEL** and confirm with **OK**.
- 9 Select **OFF** and confirm with **OK**.
- 10 Select **IP CONF.: MANU** and confirm with **OK**.
- 11 Enter "169.254.0.2" in the field **IP ADDRESS** and confirm with **OK**.
- 12 Enter "255.255.0.0" in the field **SUBNET MASK** and confirm with **OK**.
- 13 Enter "0.0.0.0" in the field **GATEWAY** and confirm with **OK**.
- 14 At the end of this process, you return to the main menu of **ASS. CONFIG.**
- 15 Exit this menu by pressing the  key.

Once the network has been set up, the LED of the WLAN USB key should be on.

You must now set up the PC.

Setting up the PC

For this section, refer to the instructions supplied by the manufacturer of the WLAN USB key to help you to find and join the "house" network.

- 1 You may need to install the software for the WLAN USB key on the PC, if this has not already been done.
- 2 Plug WLAN USB key into a USB port on the PC.
- 3 Use the software of the WLAN USB key to detect the network.
- 4 Join the network "**house**" once this has been detected.
- 5 Now set up the WLAN network connection of your PC.

**Note**

To guide you through this stage, refer to the paragraph "Setting the parameters for a connection" in the manufacturer's instructions.

To do this, you must configure the element **Protocol Internet (TCP/IP)** for the WLAN connection that has been created. If this element is set up in such a way as to obtain an IP address automatically, you must change it to manual mode to set up the TCP/IP address ("169.254.0.1" in our example), the subnet mask ("255.255.0.0" in our example) and the default gateway ("0.0.0.0" in our example).

- 6 Enter **OK**.

USB memory key

You can connect a USB memory Key on the front side of your machine. The files stored in TXT, TIFF and JPEG formats will be analysed and you will be able to use the following actions:

- print the stored files contained in your USB memory key¹,
- delete the files contained in your USB memory key,
- run an analysis on the contents of the inserted USB memory key,
- digitalise a document on your USB memory key,
- fax archiving (see section **Rerouting fax messages to a USB memory key**, page 26).

Use of the USB memory key



Important

Always respect the insertion way when you connect a USB memory key to the machine.
Do not disconnect your USB memory key while the machine is reading its contents or writing contents.

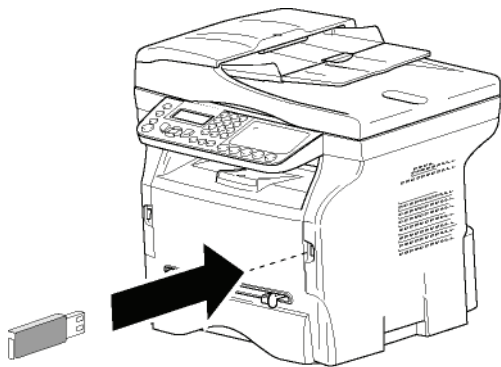

Print your documents



Important

The printing is not possible on A5 (or Statement) paper format.

You can print the stored files or a list of the files located in the USB memory key.

Print the list of files located in the key

To print the list of files located in the key:

▼ 01 - MEDIA / PRINT DOC. / LIST

- 1 Insert the USB memory key on the front side of the machine respecting the insertion way.
MEDIA ANALYSIS appears on the screen.
- 2 Select **PRINT DOC.** with the ▼ or ▲ buttons and confirm with **OK**.

1. It may be possible that some TIFF files of your USB memory key cannot be printed due to data format limitation.

- 3 Select **LIST** with the ▼ or ▲ buttons and confirm with **OK**.
- 4 The list is shown in a table with the following information:
 - the analysed files are indexed in an incremental 1 by 1 order,
 - the files name with their extension,
 - the date of the files last save,
 - the files size in Kbytes.

Print the files located in the key

To print the files located in the key:

▼ 01 - MEDIA / PRINT DOC. / FILE

- 1 Insert the USB memory key on the front side of the machine respecting the insertion way.
MEDIA ANALYSIS appears on the screen.
- 2 Select **PRINT DOC.** with the ▼ or ▲ buttons and confirm with **OK**.
- 3 Select **FILE** with the ▼ or ▲ buttons and confirm with **OK**.
- 4 You have three possibilities to print your files:
 - **ALL**, to print all the files located in the USB memory key.
Select **ALL** with the ▼ or ▲ buttons and confirm with **OK**. The printing is started automatically.
 - **SERIES**, to print a series of files located in the USB memory key.
Select **SERIES** with the ▼ or ▲ buttons and confirm with **OK**.
FIRST FILE and the first indexed file appears on the screen. Select with the ▼ or ▲ buttons the first file of the series to print and confirm with **OK**. A star (*) appears on the left side of the file.
LAST FILE appears on the screen. Select with the ▼ or ▲ buttons the last file of the series to print and confirm with **OK**.

Press the  button.

COPIES NUMBER appears on the screen, enter the desired number of copies with the numerical keypad and confirm with **OK**.
Select the printing format (for JPEG files): **A4** or **LETTER** (depending on model), or **PHOTO** and confirm with **OK**.
Select the printing format: **THICK** or **NORMAL** and confirm with **OK** to start printing.

- **SELECTION**, to print one or several files located in the USB memory key.
Select with the ▼ or ▲ buttons the file to print and confirm with **OK**. A star (*) appears on the left side of the file.
Repeat this step for each file you want to print.

Press the  button.

COPIES NUMBER appears on the screen, enter the desired number of copies with the numerical keypad and confirm with **OK**.

Select the printing format (for JPEG files): **A4** or **LETTER** (depending on model), or **PHOTO** and confirm with **OK**.

Select the printing format: **THICK** or **NORMAL** and confirm with **OK** to start printing.

- 5 Quit this menu by pressing the  button.

Delete your files located in the key

You can delete files located in your USB memory key.

▼ 06 - MEDIA / DELETE / MANUAL

- 1 Insert the USB memory key on the front side of the machine respecting the insertion way.
MEDIA ANALYSIS appears on the screen.
- 2 Select **DELETE** with the ▼ or ▲ buttons and confirm with **OK**.
- 3 Select **MANUAL** with the ▼ or ▲ buttons and confirm with **OK**.
- 4 You have three possibilities to delete your files:
 - **ALL**, to delete all the files located in the USB memory key.
Select **ALL** with the ▼ or ▲ buttons and confirm with **OK**.
You come back to the previous menu.
 - **SERIES**, to delete a series of files located in the USB memory key.
Select **SERIES** with the ▼ or ▲ buttons and confirm with **OK**.
FIRST FILE and the first indexed file appears on the screen. Select with the ▼ or ▲ buttons the first file of the series to delete and confirm with **OK**. A star (*) appears on the left of the file.
LAST FILE appears on the screen, select with the ▼ or ▲ buttons the last file of the series to delete and confirm with **OK**. A star (*) appears on the left side of the file.

Press the  button.

You come back to the previous menu.

- **SELECTION**, to delete only one or several files located in the USB memory key.
Select with the ▼ or ▲ buttons the file to delete and confirm with **OK**. A star (*) appears on the left side of the file.
Repeat this step for each file you want to delete.

Press the  button.

You come back to the previous menu.

- 5 Quit this menu by pressing the  button.

Analyse the USB memory key content

After a period of inactivity, your machine will return to the main menu. To view the USB memory key again please proceed as follows:

▼ 07 - MEDIA / MEDIA ANALYSIS

- 1 Press ▼, enter **07** using the keypad.
- 2 The USB memory key analysis is started.
- 3 You can print or delete the detected files located in your USB memory key. Refer to the previous chapters.

Save a document on a USB memory key

This function allows you to digitise and save a document directly in the folder MFPrinter Laser Pro LL2\SCAN on a USB memory key. The folder MFPrinter Laser Pro LL2\SCAN is created by the application.



Important

*Before digitalising a document, make sure that your USB memory key has sufficient disk space. If not, you can delete manually the files, see section **Delete your files located in the key**, page 48.*

- 1 Place the document to be copied face down on the glass.
- 2 Insert the USB memory key on the front side of the machine respecting the insertion way.
The USB memory key analysis is started.
When the analysis is finished, the **MEDIA** menu is displayed.
- 3 Select **SCAN TO** with the ▼ or ▲ buttons then confirm with the **OK** button.

You can also access this function in two other ways:



Important

- by pressing the  button then by selecting **SCAN-TO-MEDIA**.
- by pressing the ▼ button from the screen saver then by typing **03** on the numerical keypad.

- 4 Choose between **B&W SCAN** or **COLOUR SCAN** with the ▼ or ▲ buttons and confirm with **OK**.
- 5 With the alphanumerical keypad, give a name to the scan file (up to 20 characters) and confirm with **OK**.
- 6 Choose the scan format between **IMAGE** and **PDF**, and confirm to start the scan and the recording of the document.
IMAGE allows to have the same kind of file as a photo. **PDF** is a format for the digital documents creation.



With the **IMAGE** format, if you have selected:

- **BLACK&WHITE**, the picture will be saved in TIFF format.
- **COLOUR**, the picture will be saved in JPEG format.

You can choose the image resolution that will be digitized to the USB memory key; the default resolution is AUTO.

 **Important**

Press the  button several times and select the resolution you require:

- Scanning in **BLACK&WHITE**:
 -  icon: text resolution.
 -  icon: photo resolution.
 - no icon: auto resolution.
- Scanning in **COLOUR**:
 -  icon: text resolution.
 - no icon: auto resolution.

The beginning button  immediately starts the scan and sends a file to the support with the parameters defined in the analysis format.

Telephony (option)

The machine lets you connect a USB-DECT base to one of the USB ports of the device and register DECT handsets to this base.

You can then make and receive calls with the registered DECT handsets using the machine telephone line (standard cordless telephone use).



The telephony feature is an optional working only with a specific USB DECT dongle that you can obtain from your retailer.

You will find further information on our website:
www.sagem-communications.com.

Because the machine and the DECT base use the same telephone line, **please consider the following points**:

- the telephony feature only supports voice calls. SMS service is not available on registered handsets, as well as Caller Identification Display (CID) and notification, even if DECT devices used support this function.
- when a handset is used, the line is busy. As a result, the machine cannot perform fax or SMS communication operations. Sending and receiving resumes when the line is freed.
- print and scan operations may take slightly more time when performed during a DECT communication.
- the machine and registered handset(s) cannot share directories.

Connecting the USB-DECT base

Connect your DECT base to one of the USB ports of the machine:

- to the front USB port

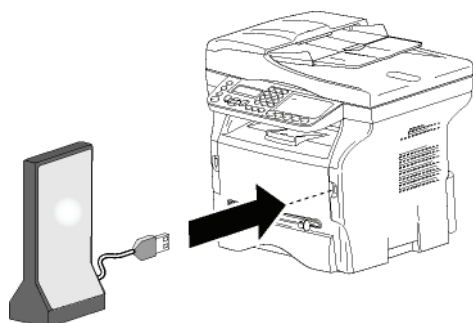

- to the rear USB port

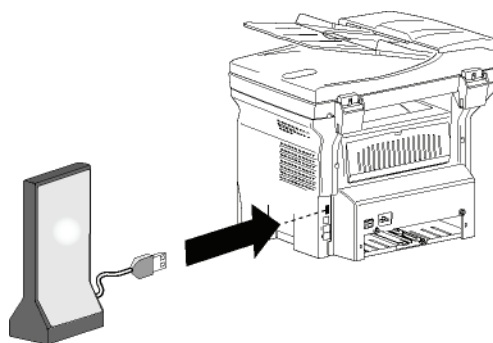

You can now make and receive calls with the handset supplied with the DECT base. As the telephone line is now used for both communication (fax, SMS) and telephony features, you may need to adjust the machine reception settings (see **Reception Mode**, page 34).

Registering DECT handsets

By default, the USB-DECT base comes with one registered handset. To register additional handsets (GAP compatible) to the base, you will need to put both the base and the handset in registration mode.



Important

This menu is available only if the USB-DECT base is connected to the machine.

To register a handset to the DECT base:

▼ 891 - ADVANCED FCT / DECT / REGISTER

- 1 Put the handset in registration mode.



Note

To know the exact registration procedure of the handset, please refer to its documentation.

- 2 On the machine, press ▼, enter **89** using the keypad and confirm with **OK**.
- 3 Select **REGISTER** using the ▼ or ▲ button and confirm with **OK**.
The machine starts searching for the handset.

During the registration process (up to one minute), the LCD screen displays **HANDSET REGISTRATION**. The message disappears once registration is complete.



Important

If the registration process fails (for example, the handset left the registration mode too soon), the machine emits a 3-beep signal. In this case, repeat the procedure from step 1.

Customising telephony settings

This function lets you set the handset ringing time upon call reception.

This parameter, used to define for how long the handset(s) rings before terminating a call, is by default set to 30 seconds.



Important

This menu is available only if the USB-DECT base is connected to the machine.

▼ 893 - ADVANCED FCT / DECT / RINGING TIME

- 1 Press ▼, enter **89** using the keypad. Confirm with **OK**.
- 2 Select **RINGING TIME** using the ▼ or ▲ button and confirm with **OK**.
- 3 Enter the desired time in seconds (15 to 60) using the numerical keypad.
- 4 Confirm with **OK**.
- 5 To exit this menu, press .

Modifying the flash duration (R key)

If you connect your machine to a private automatic branch exchange or use it in a foreign country, you may need to modify the flash duration in order to use your telephone correctly with regard to the following functionalities: outgoing 2nd call, incoming 2nd call, conference call.

Contact your administrator, who will supply the appropriate time period, and proceed to the new settings.

▼ 894 - ADVANCED FCT / DECT / FLASH TIME

- 1 Press ▼, enter **89** using the keypad. Confirm with **OK**.
- 2 Select **FLASH TIME** using the ▼ or ▲ button and confirm with **OK**.
- 3 Select the desired time in milliseconds (80 to 600) using the ▼ or ▲ button.
- 4 Confirm with **OK**.
- 5 To exit this menu, press .

Unregistering DECT handset

This function is used to unregister a handset from the DECT base. You will no longer be able to make or receive calls with a handset once you unregister it.



Important

This menu is available only if the USB-DECT base is connected to the machine.

▼ 892 - ADVANCED FCT / DECT / UNREGISTER

- 1 Press ▼, enter **89** using the keypad. Confirm with **OK**.

- 2 Select **UNREGISTER** using the ▼ or ▲ button and confirm with **OK**.
The LCD screen displays the list of handsets registered to the DECT base.
- 3 Select the handset to unregister using the ▼ or ▲ button and confirm with **OK**.
- 4 Confirm with **OK**.
- 5 To exit this menu, press .

PC Features

Introduction

The Companion Suite Pro software allows the connection of a personal computer with a compatible multifunction machine.

From the PC, you can:

- manage the multifunction machine, allowing you to set it up according to your needs,
- print your documents on the multifunction machine from your usual applications,
- scan colour, grey scale or black and white documents and edit them on your PC, or process them into text using the character recognition software (OCR).

Configuration requirements

The minimum configuration requirements for your personal computer are:

Supported operating systems:

- Windows 2000 with at least Service Pack 4,
- Windows XP x86 (Home and Pro) with at least Service Pack 1,
- Windows 2003 server for printing driver only,
- Windows Vista.

Processor:

- 800 MHz for Windows 2000,
- 1 GHz for Windows XP x86 (Home and Pro),
- 1 GHz for Windows Vista.

A CD-ROM drive

A free USB port

600 Mbytes of available disk space for the installation
RAM memory:

- 128 Mbytes minimum for Windows 2000,
- 192 Mbytes minimum for Windows XP x86 (Home and Pro),
- 1 GByte for Windows Vista.

Software installation

This section describes the following installation procedures:

- full installation of the Companion Suite Pro software,
- installation of the drivers only.

Installing the full software package

Turn your PC on. Open an account session with the administration rights.

- 1 Open the CD-ROM drive, insert the installation CD-ROM and close the drive.
- 2 An installation procedure is automatically run (Auto run). If it does not, double-click on setup.exe at the CD-ROM's root.
- 3 A screen titled **COMPANION SUITE PRO LL2** appears. This screen allows you to install and uninstall the software, access the product's user guides or browse the CD-ROM contents.
- 4 Place your cursor on **INSTALL PRODUCTS** and confirm with left-click of the mouse.



- 5 The Products Installation screen appears. Place your cursor on **ALL PRODUCTS** and confirm by left-click with the mouse.

The full installation copies on your hard disk the software required for the good execution of the Companion Suite Pro kit, which is:

- Companion Suite Pro (machine management software, printer drivers, scanner, ...),
- Adobe Acrobat Reader,
- PaperPort.

You may already be the owner of a version of the software available in the installation CD-ROM.

*In this case use the **CUSTOMIZED** installation, select the software that you want to install on your hard drive and confirm your choice.*



Note



- 6 The welcome screen appears. Click on the **NEXT** button to launch the installation of the Companion Suite Pro in your PC.

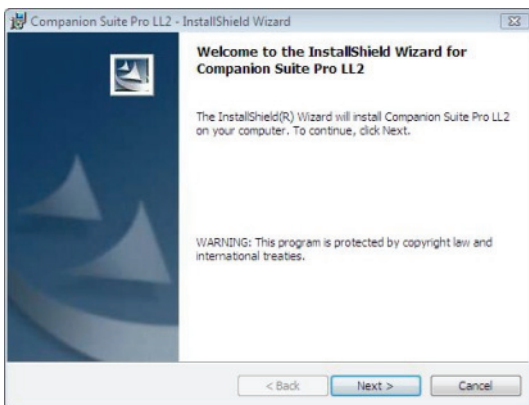

- 7 To continue, you need to accept the proposed license agreement.



- 8 Click on the **NEXT** button.

- 9 The final installation is ready to be executed. Click on the **INSTALL** button.

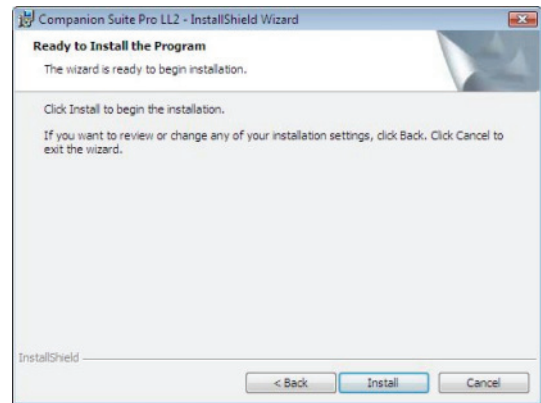

The following screen appears to indicate the progression of the installation.



- 10 Click on **OK** to finish the installation.

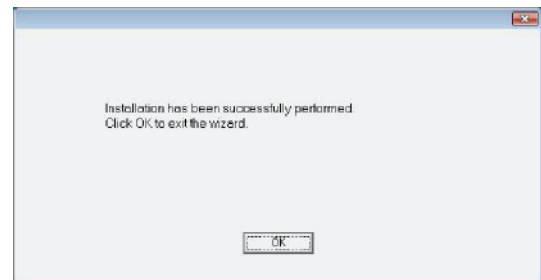

Your Companion Suite Pro kit is successfully installed on your PC.

You can now connect your multifunction machine, refer to paragraph **Connections**, page 56.

You can start the multifunction machine's management software from the menu **START > ALL PROGRAMS > COMPANION SUITE > COMPANION SUITE PRO LL2 > COMPANION DIRECTOR** or by clicking on the icon **COMPANION - DIRECTOR** located on your desktop.

Installing drivers only

This section describes the following installation procedures:

- installation of drivers using the Companion Suite Pro software,
- manual installation of drivers.

Installing the drivers using the Companion Suite Pro software

Turn your PC on. Open an account session with the administration rights.

- 1 Open the CD-ROM drive, insert the installation CD-ROM and close the drive.
- 2 An installation procedure is automatically run (Auto run). If it does not, double-click on setup.exe at the CD-ROM's root.
- 3 A screen titled **COMPANION SUITE PRO LL2** appears. This screen allows you to install and uninstall the software, access the product's user guides or browse the CD-ROM contents.
- 4 Place your cursor on **INSTALL PRODUCTS** and confirm with left-click of the mouse.

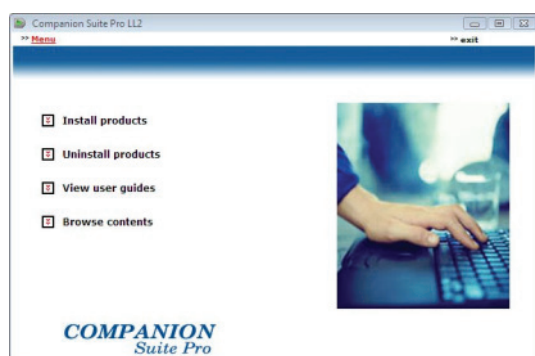

- 5 The Products Installation screen appears. Place your cursor on **CUSTOMIZED** and confirm by left-click with the mouse.



- 6 Place your cursor on **COMPANION SUITE PRO LL2** and confirm with left-click of the mouse.

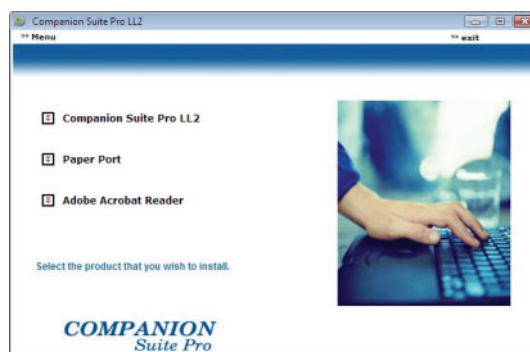

- 7 The welcome screen appears. Click on the **NEXT** button to launch the installation of the Companion Suite Pro kit on your PC.

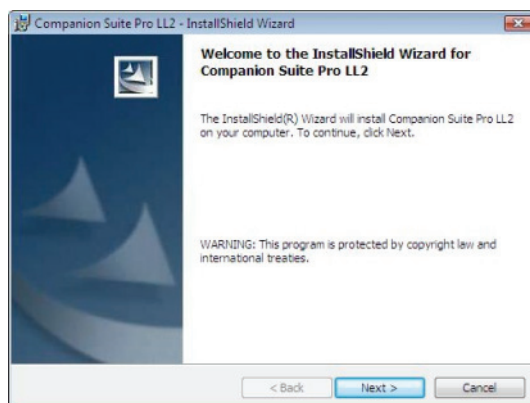

- 8 To continue, you need to accept the proposed license agreement.



- 9 Click on the **NEXT** button.
- 10 Select **INSTALL DRIVERS** in the list and click on the **NEXT** button.

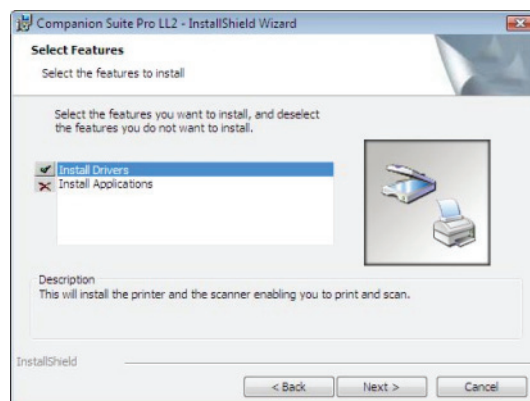

- 11 Select the destination folder for installation and click on the **NEXT** button.

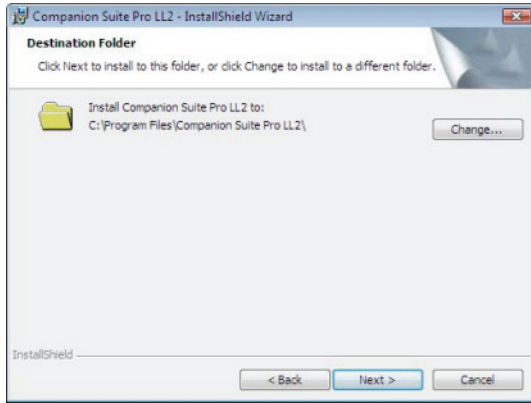

- 12 The final installation is ready to be executed. Click on the **INSTALL** button.

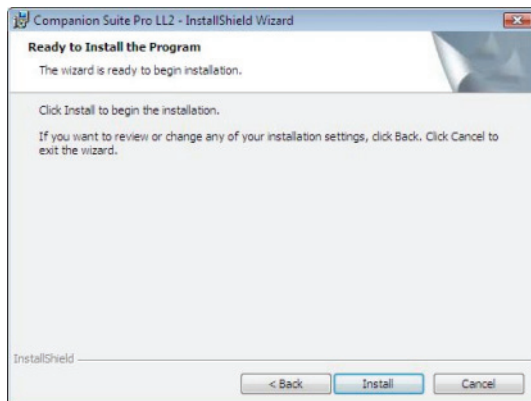

- 13 A screen informs you of the installation progress.

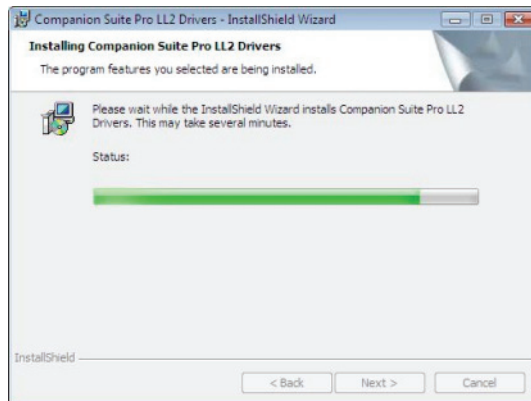

- 14 Click on **OK** to finish the installation.

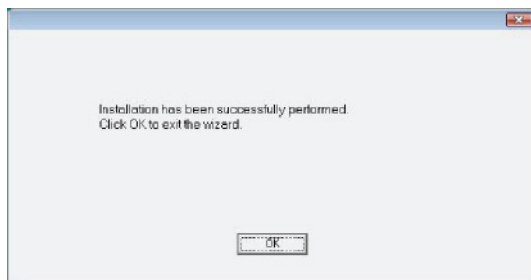

The Companion Suite Pro software is now installed on your PC.

You can now connect your multifunction machine, refer to paragraph **Connections**, page 56.

Installing the drivers manually

You can install the printer and scan drivers manually without running any setup software.



Note

This installation mode is only possible on Windows 2000, XP and Vista.

- 1 Locate your USB cable connectors and connect as shown below on the picture.

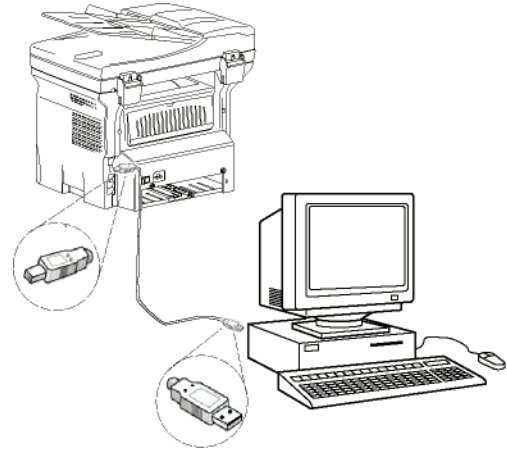

- 2 Power on your multifunction machine. The PC detects the device.
- 3 Click on **LOCATE AND INSTALL DRIVER SOFTWARE (RECOMMENDED)**.

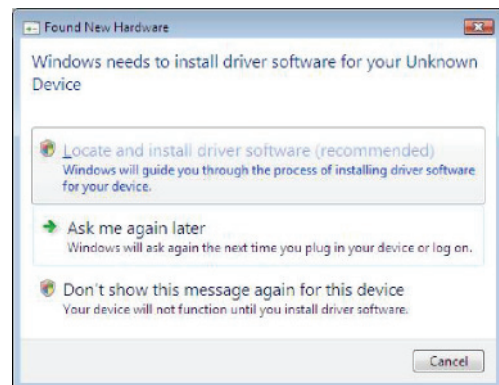

The following screen appears:

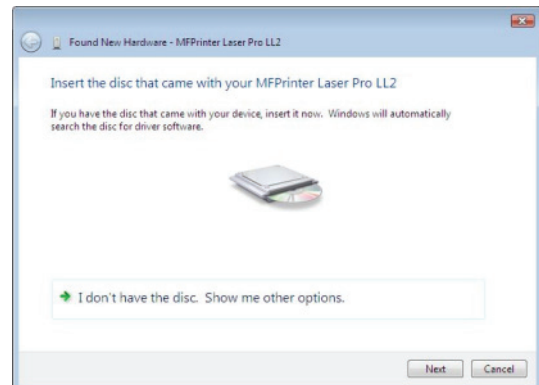

- 4 Open the CD-ROM drive, insert the installation CD-ROM and close the drive. The drivers are detected automatically.

- 5 Select LASER PRO LL2 in the list and click on **NEXT**.

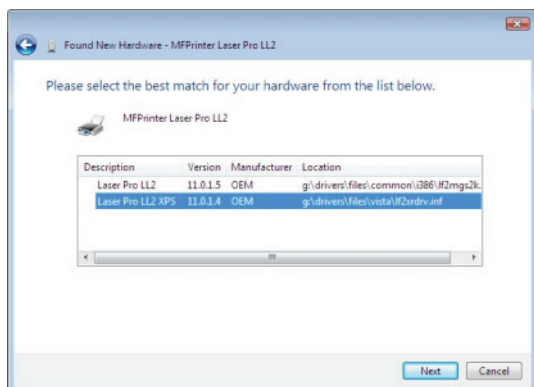

- 6 A screen informs you that the drivers have been installed. Click on the **CLOSE** button.

- 2 Power on your multifunction machine.
The PC detects the device and the drivers are automatically installed.
- 3 Once the installation is finished, a message indicates that the drivers are installed correctly.

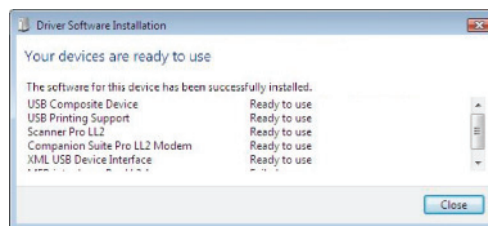

You can now use the multifunction machine to print or scan your documents.

You can now use the multifunction machine to print or scan your documents.

Connections

Make sure that your multifunction machine is powered off. The connection between the PC and the machine requires a USB 2.0 shielded cable no more than 3 meters long.

*It is recommended to install the Companion Suite Pro software first and then to connect the USB cable to your machine (see **Installing the full software package**, page 52).*

! Important

*If you connect the USB cable before installing the Companion Suite Pro software the recognition system (plug and play) identifies automatically that new hardware has been added. To start your machine drivers installation, refer to paragraph **Installing the drivers manually**, page 55 and follow the instructions on screen. When you use this procedure, only printing and scanning functions are activated.*

- 1 Locate your USB cable connectors and connect as shown below on the picture.

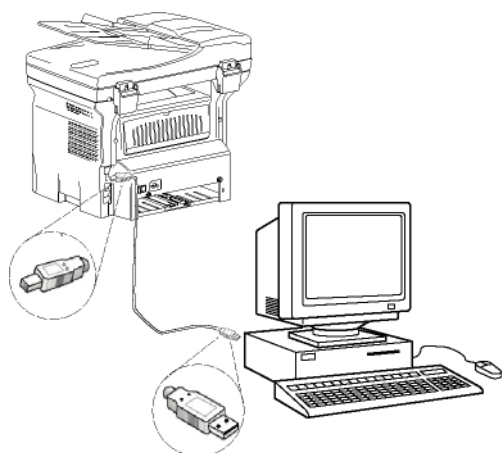

Multifunction Terminal's Supervision

The software that you have installed contains two multifunction machine management applications, **COMPANION DIRECTOR** and **COMPANION MONITOR**, which allow you to:

- check whether the multifunction machine is connected to your PC,
- monitor the multifunction machine activities,
- monitor the status of the multifunction machine consumables from the PC,
- quickly access the graphic editor applications.

To manage the multifunction machine, run the Companion Director application by clicking on the icon located on your desktop or from the menu **START > ALL PROGRAMS > COMPANION SUITE > COMPANION SUITE PRO LL2 > COMPANION DIRECTOR**.

Checking the connection between the PC and the multifunction machine

To check if the connection between the devices is good, run the **COMPANION MONITOR** software from the icon located on the desktop and check that the same information is displayed on the multifunction machine.

Companion Director

This graphical Interface allows you to run the utilities and the software to manage your multifunction machine.

Graphical presentation

Run the application by clicking on the **COMPANION DIRECTOR** icon located on your desktop or from the menu **START > ALL PROGRAMS > COMPANION SUITE > COMPANION SUITE PRO LL2 > COMPANION DIRECTOR**.



Utilities and applications activation

The Companion Suite Pro graphical interface allows you to run the following utilities and software:

- get **HELP** from the current documentation,
- run the **PAPERPORT** software (Doc Manager).

To run a software or utility contained in the Companion Suite Pro kit, place the cursor on it and left-click with the mouse.

Companion Monitor

Graphical presentation

Run the application by clicking on the **COMPANION MONITOR** icon located on your desktop or from the menu **START > ALL PROGRAMS > COMPANION SUITE > COMPANION SUITE PRO LL2 > COMPANION MONITOR**.

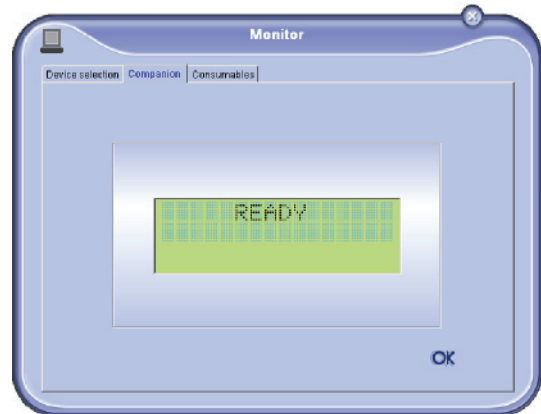

From this screen you can monitor the information or configure your multifunction machine from the tabs:

- **DEVICE SELECTION:** Displays the list of devices managed by the PC.
- **COMPANION:** Presents the multifunction machine screen (USB connection only).
- **CONSUMABLES:** Displays the consumables status.

Device management

This tab shows the list of devices managed by the PC.

Selecting the current device

Only one device at a time may be connected to the PC. The current device may be selected by clicking on the radio button corresponding to the device.

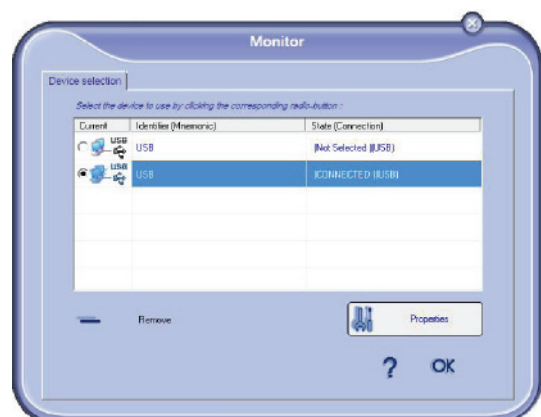

Status of the connection

The status of the connection between the current device and the PC is indicated by a colour. The following table defines the possible states of the connection.

Colour	State
Yellow	Connection in progress.
Green	Connection established.
Red	The PC cannot connect to the device. Check the USB connection.

Device parameters

- 1 Select a device by clicking on its line in the list and click on **PROPERTIES** to configure the scanning parameters to be applied for this device when you use the **SCAN TO** function.

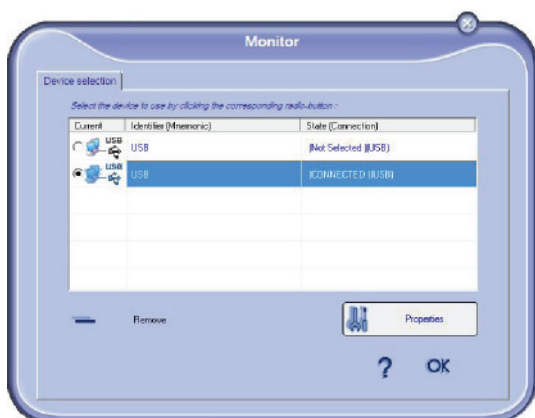

- 2 Select the desired scan **MODE** in the drop-down menu.

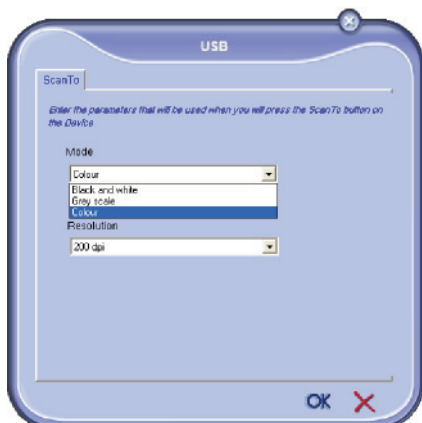

- 3 Select the desired scan **RESOLUTION** in the drop-down menu.

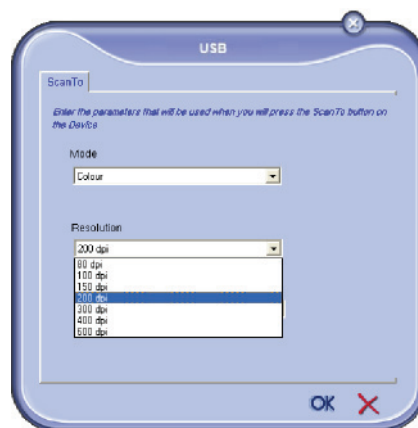

- 4 Click **OK** to confirm the new parameters.

Removing a device

- 1 Select the device from the list and click the minus sign or **REMOVE** button.
- 2 To confirm the removal of the device, click **YES**. To cancel the removal, click **NO**.

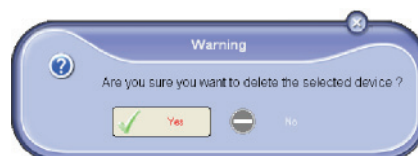

The device is no longer displayed in the list.

Display the consumable status

The following information will be available from the **CONSUMABLES** tab:

- current consumables status,
- number of printed pages,
- number of scanned pages,
- number of sent and received pages.

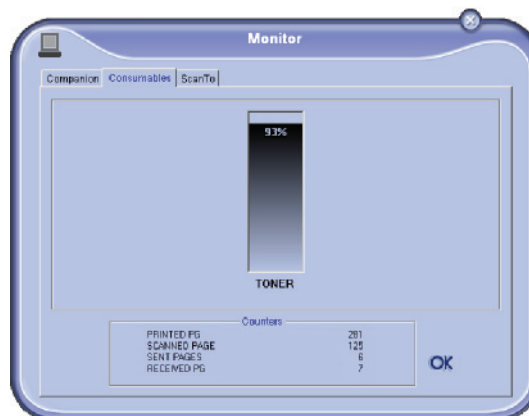

Companion Suite Pro functionalities

Document analysis

The document analysis can be carried out in two ways:

- either by the **SCAN TO** function (application accessible from the Companion Director window or from the **SCAN** button on the machine),
- or directly from a standard compatible application.

Analysis with Scan To

Run the application by clicking on the **COMPANION DIRECTOR** icon located on your desktop or from the menu **START > ALL PROGRAMS > COMPANION SUITE > COMPANION SUITE PRO LL2 > COMPANION DIRECTOR**.



- 1 Click on the **SCAN TO** graphical image or press the **SCAN** button on your machine and select **SCAN-TO-PC**.
- 2 You can follow the ongoing digitisation on a screen.

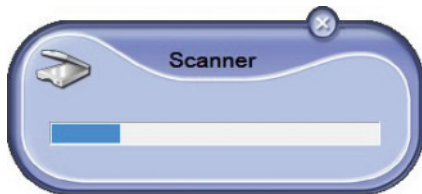

- 3 At the end of the digitisation, the scanned picture appears in the PaperPort window.

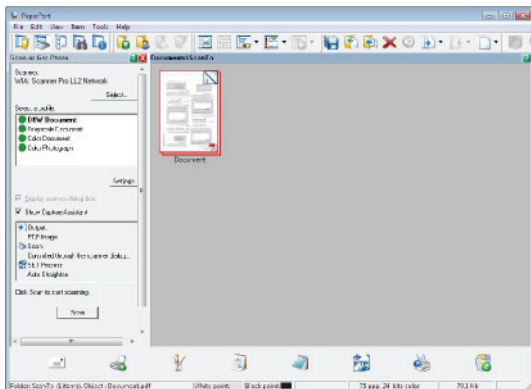

Note

If the PaperPort software is not installed on your hard drive, the scanned picture will appear on your desktop in TIFF format.

To scan a document from PaperPort:

- 1 Click on **FILE > SCAN**.
- 2 Select the desired scanner, document feeder or flatbed.

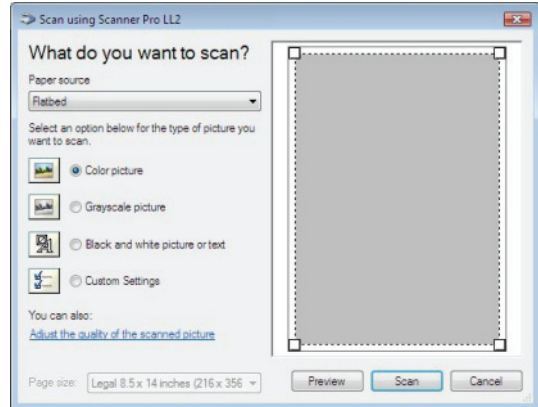

- 3 Customise the advanced properties of the digitisation by clicking on the **ADJUST THE QUALITY OF THE SCANNED PICTURE** link.
- 4 Adjust the desired parameters and click on the **OK** button.

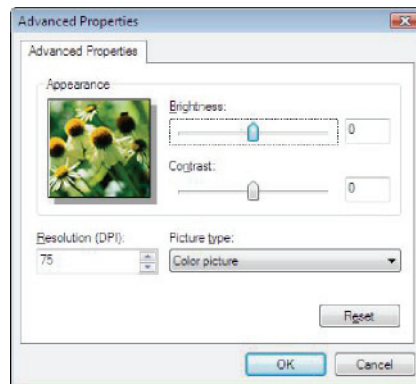

- 5 Click on the **SCAN** button, you can follow the ongoing digitisation on a screen.

Character recognition software (OCR)

The character recognition function allows to create a usable data file for desktop applications from a hardcopy document or from a picture.

The character recognition only works for printed characters, such as printer outputs or typed text. Nevertheless you can request for a handwritten text block to be kept intact (a signature for instance) by outlining it.

Given your machine environment and the character recognition from your machine, the OCR is done with a Drag&drop of a document from the PaperPort to the

Notepad icon .

**Note**

For more details about the usage of this software, check the online help of the product.

Printing

You have the possibility to print your documents via the USB connection or the WLAN connection.

During the installation of the Companion Suite Pro software, the **LASER PRO LL2** printer driver will be installed automatically onto your PC.

Printing on the multifunction machine

Printing a document on the multifunction machine from your PC is like printing a document in Windows.

- 1 Use the **PRINT** command from the **FILE** menu of the currently open application on the screen.
- 2 Select the **LASER PRO LL2** printer.

Printing in duplex mode with the multifunction machine

The machine offers the possibility to print a document in manual duplex mode from your PC.

In manual duplex, the print quality and paper transport are not guaranteed.

- If some trouble occurred to the paper during the print of the first side, such as wrinkle, dog ear or staple, do not use the paper for manual duplex.

- When you load paper, please true up the end of paper on a flat surface.

For best results, we recommend that you use 80 g/m² A4 paper or 20 lbs/m² Letter paper.

**CAUTION**

To print a document in manual duplex mode:

**Important**

The duplex printing mode is available only in a paper format managed by the paper tray. The manual tray cannot be used to print in duplex mode.

- 1 Use the **PRINT** command from the **FILE** menu of the currently open application on the screen.
- 2 Select the **LASER PRO LL2** printer.

- 3 Check the **Duplex** box and choose among the two binding modes:

Binding mode	Printing
Long sides	
Short sides	

- 4 Click on the **OK** button to begin printing.
- 5 The machine prints the odd pages (from the higher odd page to page 1) and the LCD screen displays:

**** PRINTING ****
**** PC ****

- 6 Once the odd pages are printed, the LCD screen displays the message ****PUT THE PRINTED SHEETS IN THE PAPER TRAY WITH THE PRINTED SIDE VISIBLE...:**

**** PUT THE PRIN**
... AND PRESS <OK>

**Important**

The PC generates and prints a page explaining how to reload the sheets for a duplex job. Read this page carefully and place it back with the other sheets.

It is very important that you return the explanation sheet to the paper tray to continue printing correctly.

- 7 Place the sheets in the paper tray as indicated on the explanation page and below. The following illustrations describe the necessary operations depending on the selected binding mode:

- Long sides

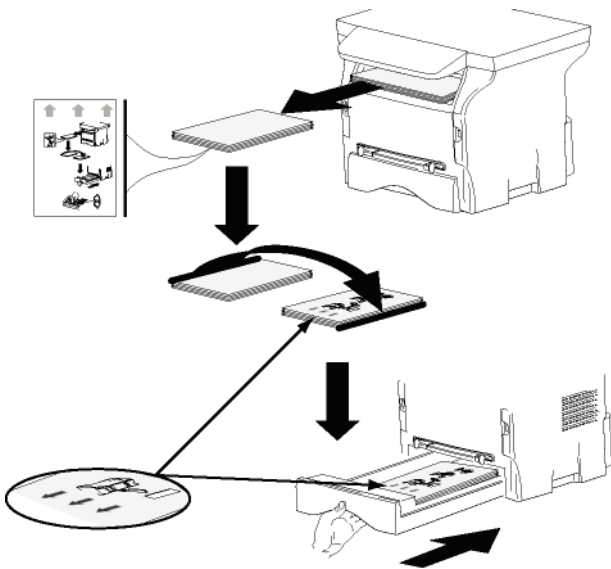

- Short sides

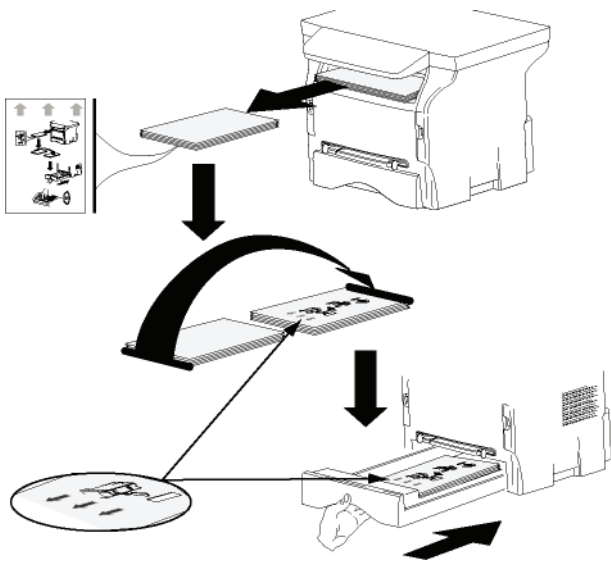

- 8 Press **OK** on the command panel to resume printing.
- 9 Even pages are printed on the other side of the sheets. Once all pages are printed, remove the explanation sheet.



If a paper jam or a paper format error occurs, the job is cancelled. You must then resubmit the print job.

Address book

The address book enables you to store the numbers of the contacts you call the most frequently. The purpose of this function is to facilitate dialling your contact's number when you want to send an SMS or fax. If you want, you can print the list of numbers stored in the address book.

You also have the possibility of creating groups of contacts from the address book. Like this, you can group together all contacts from, for example, a given company or the same service, etc, to which you frequently send common documents.

Add a contact to the terminal address book

- 1 Click on the link **ADDRESS BOOK** of the window **COMPANION DIRECTOR**. The address book is displayed on the screen.

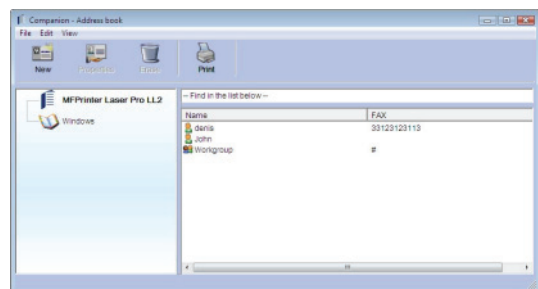

- 2 Select the terminal address book.
- 3 Click on **NEW** and select **CONTACT** in the displayed menu. The input window for the contact data is displayed.



- 4 Enter the contact name as well as the fax or GSM telephone number, the fax transmission rate with this person and the associated quick dial key. Click on **OK**.

The new contact is added to the list.

Add a group to the terminal address book

- 1 Click the link **ADDRESS BOOK** of the window **COMPANION DIRECTOR**.

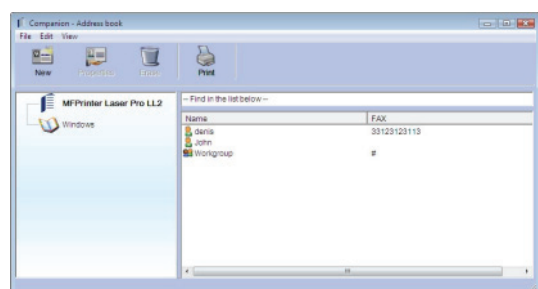

- 2 Select the terminal address book.
- 3 Click **NEW** and select **GROUP** in the displayed menu.

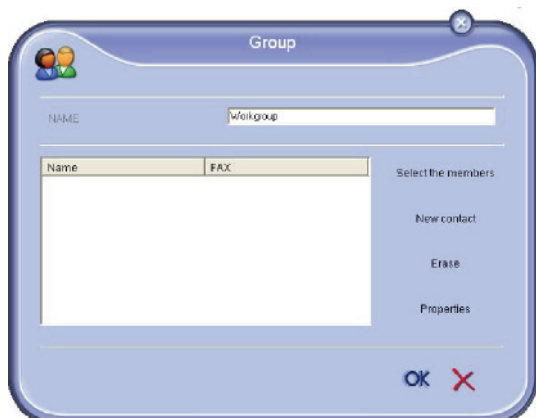

- 4 Enter the name of the group. The group may consist of contacts from the address book or new contacts.

1st case: group members are from the address book.

Click **SELECT THE MEMBERS**.

The selection window is displayed.

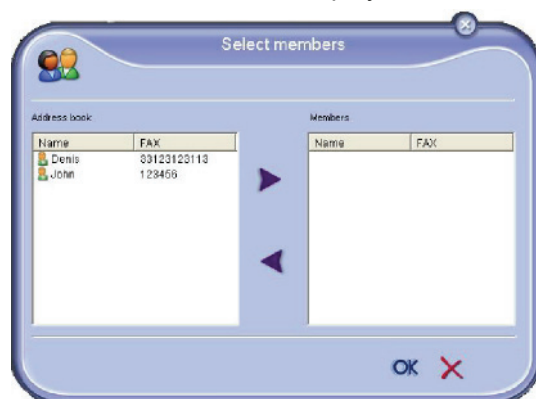

Select a contact or a group in the zone **ADDRESS BOOK**, click on ► (to add a contact to the group you can also double click on it). Click on **OK**.

2nd case: adding new contacts.

Click on **NEW** then add the personal data of the new contact, as in the procedure for adding a contact.

- 5 As soon as the group is complete, click on **OK**.

The new group is added to the list.

Manage the address book

When you are working in the address book, you can perform different operations:

- print a list of contacts in your address book,
- delete a contact or a group in your address book,
- search for a contact or a group of contacts in the address book using the first letters of the name,
- check the datasheet of a contact or a group in order to modify it.

Modify the information related to a contact

- 1 Select the contact whose data you want to modify, using the mouse.
- 2 Click on **PROPERTIES**.
- 3 Make the necessary changes in the window **ADDRESS BOOK**.
- 4 Click on **OK**.

Modify a group

- 1 Select the group in the address book list.
- 2 Click on **PROPERTIES**.
- 3 Make the necessary changes.
- 4 Click on **OK**.

Delete a contact or a group from the address book

- 1 Select the name of the contact or the name of the group you want to delete, using the mouse.
- 2 Click on **DELETE**.



Important

When a contact is deleted from the address book, it is automatically deleted from any group in which it may be included.

Print the address book

- 1 Click on **PRINT**.
The list of the address book is printed on the terminal (if no contact is selected).

Import or export an address book

Save / Export your address book

This operation lets you save your address book to a file in EAB format.

- 1 Select **EXPORT** in the menu **FILE** of the window **ADDRESS BOOK**.
- 2 Enter the name of the file and select the destination directory, then click on **SAVE**.

Import an address book

Importing an address book makes it possible to exchange address book entries between two devices without having to enter contacts one by one manually. Address books can be imported from files in EAB format. EAB files are automatically generated during export.



Important

The whole address book will be replaced by the imported address book.

- 1 Select **IMPORT** in the menu **FILE** of the window **ADDRESS BOOK**.
- 2 Select the file to import, click on **OPEN**.

Fax communications

The fax communication enables you to:

- send documents as faxes from one of the scanners of your terminal, from the hard disk or from the screen of your PC,
- receive fax documents,
- monitor communications through various services: the inbox, the outbox, the sent items, the outbox log and the inbox log.

Parameters are available to modify the way your terminal works with regard to fax communications. You can modify these parameters to adapt the fax communications to your requirements. For this procedure, refer to paragraph **Fax parameters**, page 65.

Presentation of the Fax window

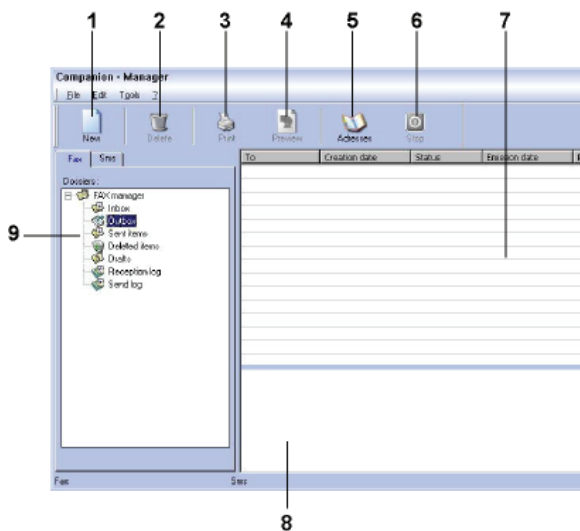



Item	Action
1	Create a new fax to send.
2	Delete a fax using one of the fax manager directories. Except for directories SENT LOG and RECEPTION LOG for which the effect of this command is to delete the entire log
3	Print a fax from one of the Fax manager directories.
4	Display a fax with the Viewer.
5	Access to the address book.
6	Stop fax sending (only enabled for the outbox).
7	Display all faxes in the selected directory in the Fax manager.
8	Fax preview.
9	Fax manager directories.

Send a fax

Send a fax from the hard disk or the terminal

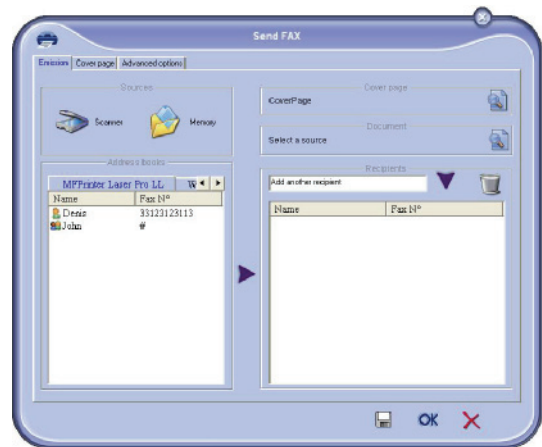
- 1 Click the icon  of the window COMPANION DIRECTOR.
- 2 Click **NEW** then click **FAX**.



- 3 In the zone **SOURCES**, select **SCANNER** if your document is in paper format or **MEMORY** if the document is a computer file located on your hard disk (this file must be in TIFF or FAX format).
- 4 To send your fax to a contact, enter his/her number in the field **RECIPIENTS** and click on ▼ or select a contact (or group) from one of the address books in the field **ADDRESS BOOK** and click on the button ►. Repeat this operation as many times as necessary (use the button  to delete a contact from the list of contacts).
- 5 If necessary, adjust the advanced options (send later and resolution) in the tab **ADVANCED OPTIONS**.

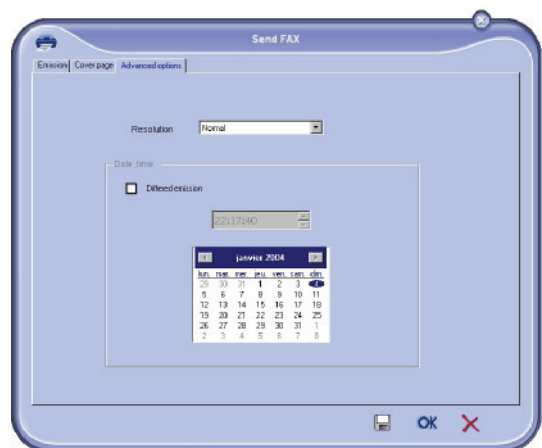

- 6 To add a cover page, select the tab **COVER PAGE** then click the box **WITH THE COVER PAGE**. Select the cover page you want to add from the drop-down menu, or create a new one. For more information, refer to paragraph **Cover page**, page 66.
- 7 Click **OK** to send your fax to all contacts in your list of contacts.

Your send request can then be checked, if necessary, in the outbox.

Send a fax from an application

This method is used to directly send a document you have created using a desktop software without printing it beforehand.

- 1 From your desktop software, select **FILE > PRINT**.

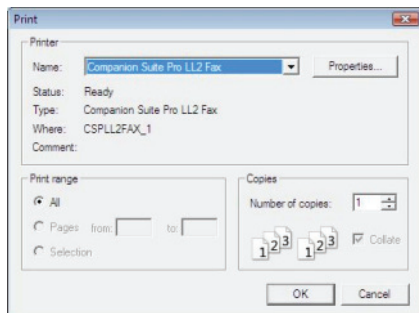

- 2 Select the printer **COMPANION SUITE PRO LL2 FAX** and click **OK**.
The fax window is displayed.

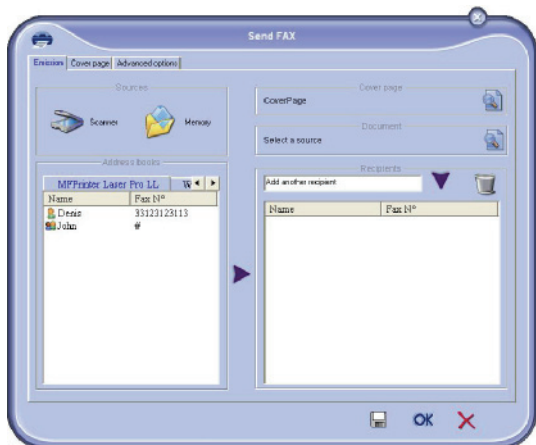

- 3 To send your fax to a contact, enter his/her number in the field **RECIPIENTS** and click on ▼ or select a contact (or a group) from one of the address books in the field **ADDRESS BOOK** and click the button ►. Repeat this operation as many times as necessary (use the button 🗑 to delete a contact from the list of contacts).
- 4 If necessary, adjust the advanced options (send later and resolution) in the tab **ADVANCED OPTIONS**.
- 5 To add a cover page, select the tab **COVER PAGE** then click the box **WITH THE COVER PAGE**. Select the cover page you want to add from the drop-down menu, or create a new one. For more information, refer to paragraph **Cover page**, page 66.
- 6 Click **OK** to send your fax to all contacts in your list of contacts.

Your send request can then be checked, if necessary, in the outbox.

Receive a fax

The window **Companion Manager** and **Companion Director** show, using different messages, the reception of a fax. The icon ➡ is displayed at the bottom of the window **Companion Manager** and the icon ↻ appears in the task bar.

You can automatically print faxes on reception. To do this, you have to define this parameter, refer to paragraph **Fax parameters**, page 65.

Follow-up of fax communications

Follow-up of fax communications is by means of:

- an outbox,
- an inbox,
- a sent item memory,
- an outbox log,
- an inbox log.

These services enable you to always know exactly what communications are taking place on the terminal, whether sending or receiving.

The outbox and inbox logs are automatically printed when their contents fill a page. After automatic printout, the terminal creates a new log.

The outbox

In the fax outbox, there are the following:

- the requests being sent,
- the send later requests,
- the requests for which one or more send attempts have already been made, and which will soon be redialed,
- the rejected requests (calls not put through).

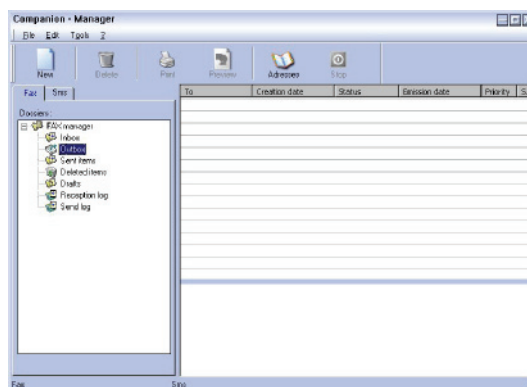

The requests are classed in the order in which they are executed.

The rejected requests are filed at the end of the list so that they are more accessible if you want to work with them (request a new send) or delete them.

The send memory (items sent)

The sent memory is used to keep all faxes you have sent.

The information in the send memory is:

- the recipient of the fax,
- the date the fax was created,
- the date the fax was sent,
- the size of the fax.

The outbox log

The outbox log is used to keep a history of all fax communications (successful or rejected) that your Terminal processes. The log is printed automatically as soon as its contents fill a page.



Important

*The button **DELETE** deletes the entire log, and not simply the selected message(s).*

The information held in the log is:

- the recipient of the fax,
- the date the fax was sent,
- the status (sent, rejected ...).

The inbox log

The inbox log is used to keep a history of all faxes received by your Terminal. The log is printed automatically as soon as its contents fill a page.



Important

*The button **DELETE** deletes the entire log, and not simply the selected message(s).*

The information held in the inbox log is:

- the sender of the fax,
- the date and reception of the fax,
- the status.

Fax parameters

Access to fax parameters

- 1 Click on the icon  of the window COMPANION DIRECTOR.
- 2 Select **TOOLS > OPTION > FAX**.
- 3 Make the adjustments required, referring to the description of parameters below and click **OK**.

Description of the tab LOGS AND REPORTS

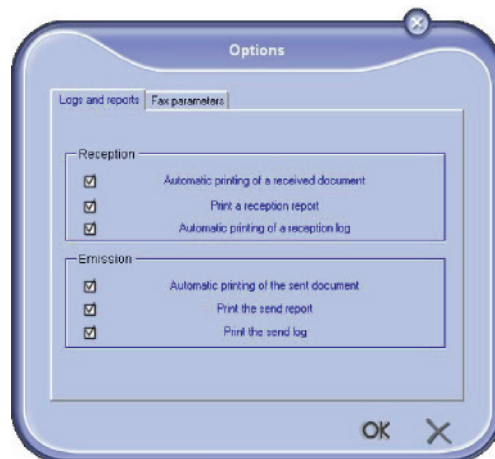

Option	Description
Automatic printing of a received document	The fax is automatically printed when received.
Printing of a inbox report	A report is printed out for each fax received.
Printing of inbox log	The log is automatically printed when its contents fill a page.
Automatic printing of a sent document	The fax is automatically printed when it is sent.
Printing of an outbox report	An outbox report is printed after each fax is sent.
Printing of the outbox log	The log is automatically printed when its contents fill a page.

Description of the tab FAX PARAMETERS

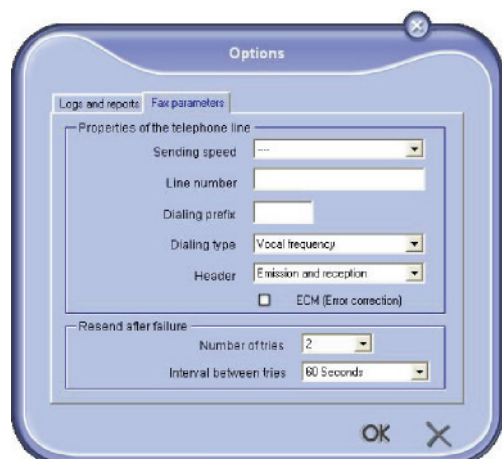

Option	Description
Transmission speed	Fax default transmission speed.
Line number	Number of the line where your terminal is connected.
Dialling prefix	This dialling prefix shall be automatically inserted in front of the number before sending on this line.
Type of dialing	Must be parametered according to the type of switchboard your terminal is connected to.
Header	Displays a Communication Identification Line (LIC) on the documents you send or on the documents you receive.
ECM	Corrects communication errors due to line disturbance. This option ensures that received documents are integral. On the other hand, communication times may be longer if the line is bad.
Number of attempts	Number of attempts the Terminal must make if send fails.
Interval between attempts	Duration between two send attempts.

Cover page

The cover page is part of a fax document automatically generated by your terminal, on which there is information concerning the sender, the recipient, the date, the time sent, comments, etc...

This page may be sent alone or in front of a fax document, but always at the same time as the document. A document may be sent with a cover page from the multifunction terminal or from the central processing unit. In the latter case, some of the information in the cover page may be provided by yourself when making the send request. It is necessary to create model cover pages before sending a document using them. On the other hand, once the cover page is created, a model cover page may be used for all documents sent.

Your terminal offers the possibility of creating and customizing some model cover pages which you can choose when sending a fax.

Creating a cover page template

Creating a cover page creates a template which fields (fax number, comment, subject and so on) will be automatically filled by the Fax Application depending on the information provided for each recipient of a document.

To create this cover page template, there are two major steps:

- **First step:** Create a background image with the logos and the layout that you wish.
- **Second step:** Add the field that you want to be displayed in the cover page: fax number, comment, subject and so on. As mentioned before, these fields will be filled by Fax application at emission time.

For the first step, there are two methods to create the background image.

You can either

- Option **(A)**: Draw this background image in your preferred application (such as Word, Excel,...),

OR

- Option **(B)**: Scan a sheet of paper containing the layout of the cover page.

Details about Option A and B:

- Option **(A)**: Open the application that you want to use to edit the background (Word, Wordpad...). Draw the background image then print this document in the printer named "Companion Suite Fax". At that point the MFSendFax dialog is displayed:

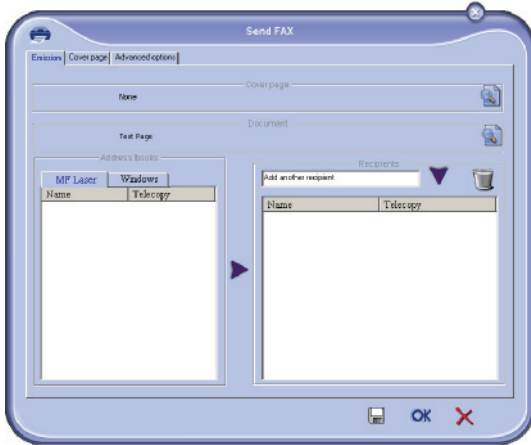

Add any recipient to the recipient list, click on the tab **ADVANCED OPTIONS**, select resolution **FINE** as shown below:

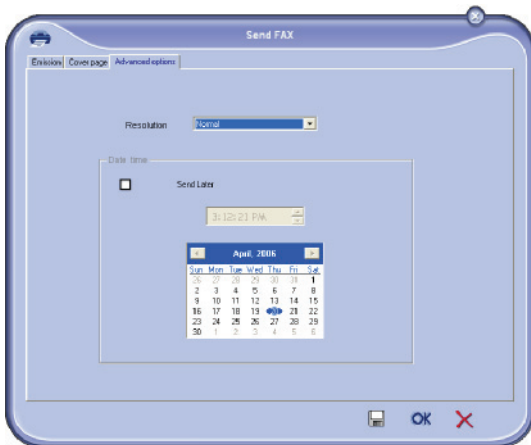

Finally click on the button **SAVE AS DRAFT** in the lower right corner (floppy disk icon). The background image is created in the directory C:\Program Files\Companion Suite Pro LL 2\Documents\FAX\Temporary and has the file extension .fax

- Option **(B)**: Launch **MFMANAGER**, select **NEW FAX**, select the scanner source as shown below:

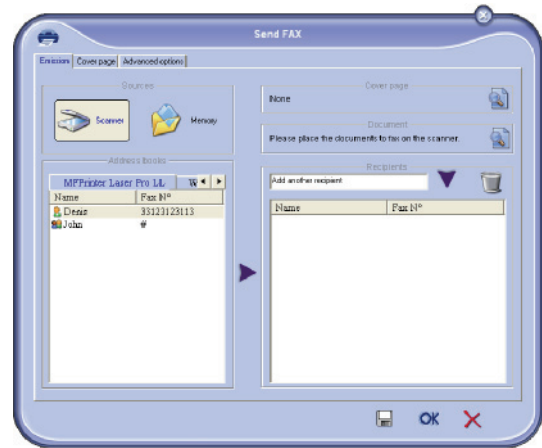

Add any recipient to the recipient list, click on the tab **ADVANCED OPTIONS**, select resolution **FINE** as shown below:

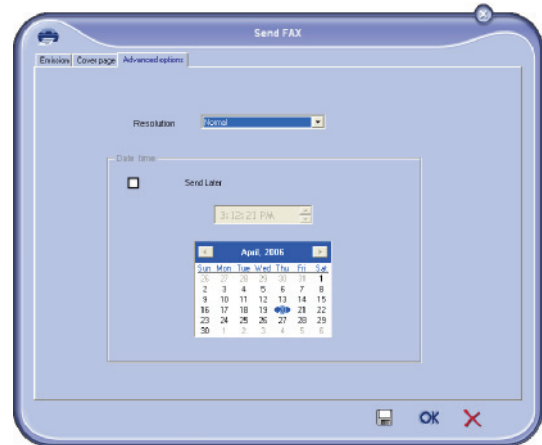

Finally click on the button **SAVE AS DRAFT** in the lower right corner (floppy disk icon). The background image is created in the directory C:\Program Files\Companion Suite Pro LL 2\Documents\FAX\Temporary and has the file extension .fax.

Whether you choose Option **A** or **B**, you end up with a background image with extension .fax, which is located in C:\Program Files\Companion Suite Pro LL 2\Documents\FAX\Temporary.

➔ You can now proceed to the second step right below.

For the second step:

Now that the background image is created in directory in C:\Program Files\Companion Suite Pro LL 2\Documents\FAX\Temporary, you can add the fields on top of the background image.

Please follow the procedure below:

- Launch MFManager, select New Fax, click on the tab Cover Page, and check the check box named With the cover page.
- Click on the button New, this displays a new window with the title Creation of the cover page.
- Press the button Open in the toolbar, change the file filter to *.fax and browse to the directory C:\Program Files\Companion Suite Pro LL 2 \Documents\FAX \Temporary that contains the background image that you have created in the First step.
- Click on the button Fields in the toolbar, a window pops up allowing you to add the fields on top of the background image.
- Click on the button Save to save the Cover Page template and exit this window.
- The window New Fax is displayed, you can now choose the Cover Page template that you want to use. When you double click the preview image in the lower right corner, another window pops up giving you a preview of the cover page with the fields filled with the recipient's information.

Creating a cover page

It is necessary to create a model cover page before sending a fax with it.

- From the tab **COVER PAGE**, click on the button **NEW**.
- Select the model cover page you have created using the menu **FILE**.

A window with the model cover page you have created is displayed:

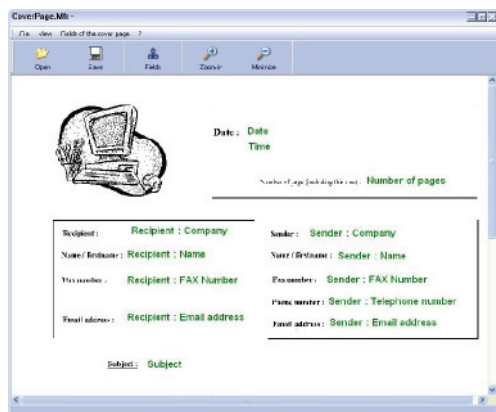

- Click on the icon  to display the available fields.



To add a field, proceed as follows:

- Select the field you want to insert by clicking the field palette. A stamp replaces the cursor of your mouse.
- Click the location where you want to put the field on the model.
- You can move or enlarge the field as you like.



Adjust the size of your field so that the text is readable.

- As soon as fields are inserted, save the cover page.

This cover page can be selected in the tab **COVER PAGE** of the fax send window.

Description of the tab COVER PAGE

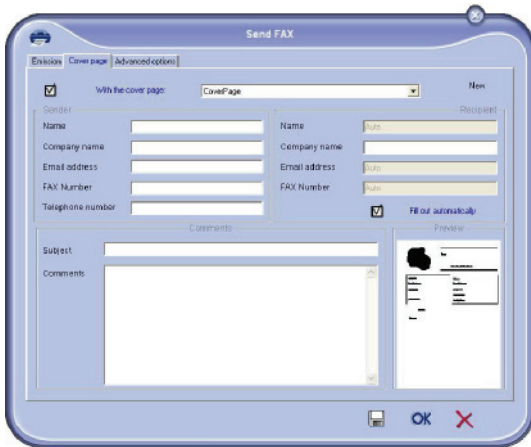

Field	Description
Name of the cover page	Either the name of the page selected by default or the page you have selected to use.
Sender	You can enter information concerning the sender.
Recipient	You can enter information concerning the recipient. If the word Auto is entered in one of the fields, the field is updated during sending if the recipient is listed in the address book, favourites, a group or a distribution list.
Comments	This is an editing window with all the basic functions of a text editor so that you can enter a text which will be sent in the cover page.
Preview of the model	The preview enables you to see the cover page you are going to send.

SMS Communications

From your PC, you can send SMS to a single recipient or to multiple recipients using the distribution groups. Communications being sent are monitored by means of the outbox, the outbox log and the outbox memory (items sent).



Important

The SMS service is available depending on the countries and the operators.

Presentation of the SMS window

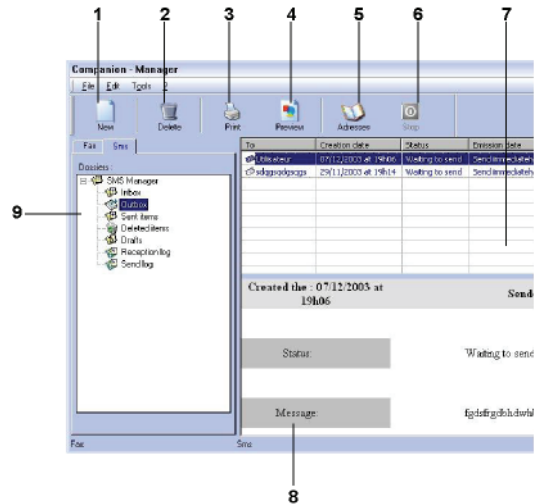

Item	Action
1	Write an SMS.
2	Delete an SMS from one of the SMS manager directories. Except for the directory SEND LOG for which the effect of this command is to delete the entire log.
3	Print an SMS from one of the SMS manager directories.
4	Display an SMS with the Viewer.
5	Access to the address book.
6	Stop SMS sending (only enabled for the outbox).
7	Displays all SMSs in the directory selected in the Fax manager.
8	SMS preview.
9	SMS manager directories.

Send an SMS

- 1 Click on the icon SMS  of the window **COMPANION DIRECTOR**.
- 2 Click on **NEW** then on **SMS**.

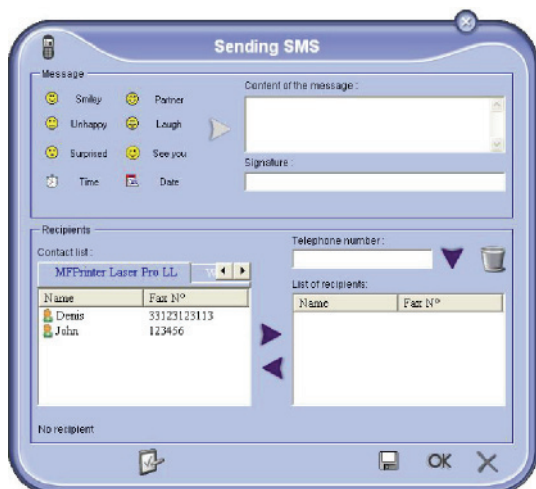

- 3 Enter your message in the field **CONTENT OF MESSAGE** provided for this purpose. You can use the **buttons** and the "**smiley**" located to the left of the input field to customize your message, or to automatically insert the date and time.
- 4 To send your SMS to a contact, enter his/her number in the field **TELEPHONE NUMBER** and click on ▼ or select a recipient (or group) from one of the address directory in the field **CONTACT LIST** and click on ►.

Repeat this operation as many times as necessary (use the button  to delete a contact from the list of contacts).

- 5 If necessary, adjust the advanced parameters (to send later or give priority to the SMS) by pressing the button **ADVANCED PARAMETERS** ().



- 6 Click on **OK** to send your SMS to all contacts in your list of contacts.

Your send request can then be checked, if necessary, in the outbox.

Follow-up of SMS

SMS communications are monitored by means of:

- an outbox,
- a sent item memory,
- an outbox log.

These services make it possible to have complete information on the terminal activity with regard to communications.

The outbox log is automatically printed when its contents fill a page. After this automatic printing, the terminal creates a new log.

The outbox

The following is grouped in the SMS outbox:

- requests being sent,
- send later requests,
- requests for which one or more send attempts have already been made, and which will soon be redialed,
- requests which have been rejected.

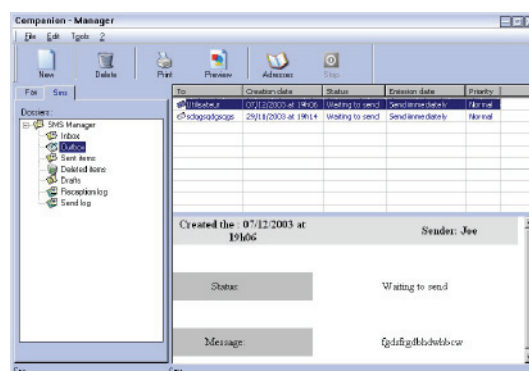

The outbox log

The outbox log is used to keep the entire history of SMS communications (successful or rejected) that have been processed by your terminal. The log is printed automatically as soon as its contents fill a page.



Important

The button **DELETE** deletes the entire log, and not simply the selected message(s).

The information held in the log is:

- the SMS recipient,
- the date of sending of the SMS,
- the status (sent, rejected,...).

The sent item memory (items sent)

The sent item memory is used to keep a copy of all SMS messages you have sent.

The information in the sent item memory is:

- the SMS recipient,
- the date of creation of the SMS,
- the date of sending of the SMS,
- the size of the SMS.

SMS Parameters

Access to SMS parameters



- 1 Click the icon SMS of the window **COMPANION DIRECTOR**.
- 2 Select **TOOLS > OPTIONS > SMS**.
- 3 Make the adjustments required, referring to the description of the parameters below and click **OK**.

Description of the tab LOGS AND REPORTS

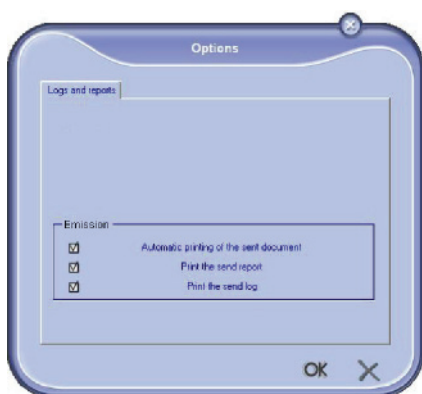

Option	Description
Automatic printing of a sent document	The SMS is automatically printed when it is sent.
Printing of a send report	An outbox report is printed after each SMS is sent.
Printing of the outbox log	The log is automatically printed when its contents fill a page.

Software Uninstallation

This section describes the following procedures:

- full uninstallation of the Companion Suite Pro software,
- uninstallation of the drivers only.

Uninstall the software from your PC

Turn your PC on. Open an account session with the administration rights.

Run the programs removal from the menu **START > ALL PROGRAMS > COMPANION SUITE > COMPANION SUITE PRO LL2 > UNINSTALL**.

- 1 A confirmation screen appears. Click on the **YES** button to continue the Companion Suite Pro program removal.

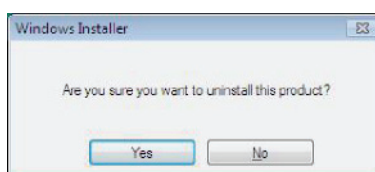

- 2 The uninstall program is launched. You can cancel the removal by clicking on **CANCEL**.

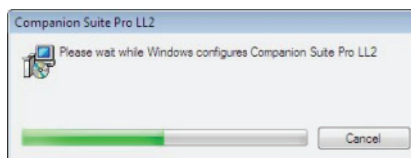

- 3 Click on the **OK** button.

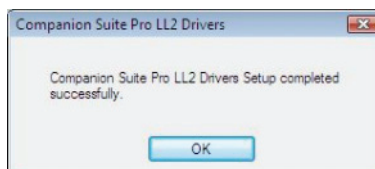

- 4 You need to restart your system at the end of the procedure. Click on the **YES** button.

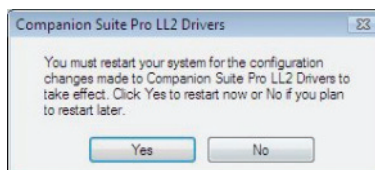

Uninstall the drivers from your PC

Turn your PC on. Open an account session with the administration rights.

Depending on the installation mode used, select the required uninstallation mode:

- If you have installed the drivers with the Companion Suite Pro software, see paragraph Uninstall the drivers using the Companion Suite Pro software.
- If you have installed the drivers manually, see paragraph Uninstall the drivers manually.

Uninstall the drivers using the Companion Suite Pro software

Run the programs removal from the menu **START > ALL PROGRAMS > COMPANION SUITE > COMPANION SUITE PRO LL2 > UNINSTALL**.



Note

You can also uninstall **COMPANION SUITE PRO LL2** drivers using the Windows function **ADD/REMOVE PROGRAMS** from the control panel.

- 1 A confirmation screen appears. Click on the **YES** button to continue the **COMPANION SUITE PRO LL2** drivers program removal.

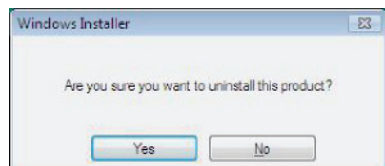

- 2 The uninstall program is launched. You can cancel the removal by clicking on **CANCEL**.

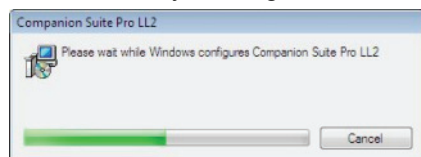

Uninstall the drivers manually

The following drivers must be removed:

- print driver
- scan driver
- modem driver

To remove the print driver:

- 1 Open the **PRINTERS** window (**START > CONTROL PANEL > PRINTERS AND FAXES** or **START > CONTROL PANEL > HARDWARE AND SOUND > PRINTERS**, depending the operating system).
- 2 Delete the **LASER PRO LL2** icon.
- 3 In the **PRINTERS** window, right-click with the mouse and select **RUN AS ADMINISTRATOR > SERVER PROPERTIES**.
- 4 Select the **DRIVERS** tab.
- 5 Select the **LASER PRO LL2** driver and click on the **REMOVE** button.

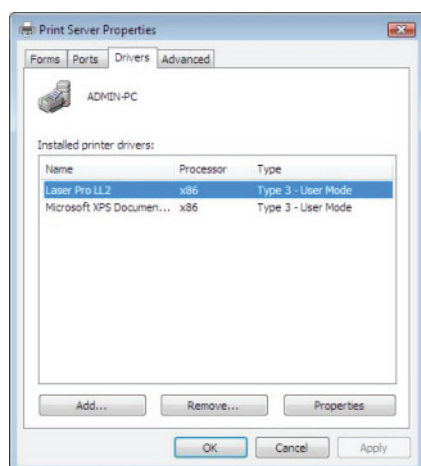

- 6 Select the option **REMOVE DRIVER AND DRIVER PACKAGE** and click on the **OK** button.



- 7 A confirmation screen appears. Click on the **YES** button to continue.
- 8 Click on the **DELETE** button to confirm the removal.

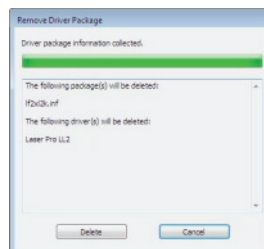

To remove scan and modem drivers:

- 1 Open the **DEVICE MANAGER** window (**START > CONTROL PANEL > SYSTEM > HARDWARE > DEVICE MANAGER** or **START > CONTROL PANEL > HARDWARE AND SOUND > DEVICE MANAGER**, depending on the operating system).

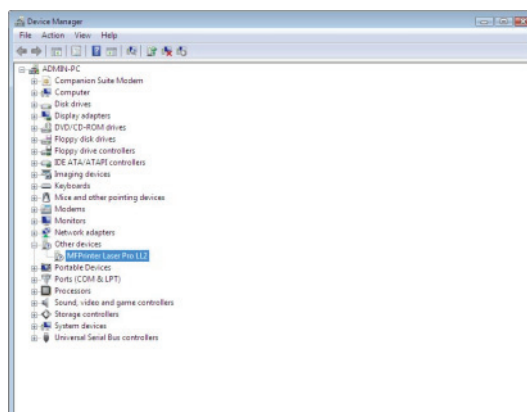

- 2 In the **OTHER DEVICES** sub-menu, select the **MF PRINTER LASER PRO LL2** item and click on the right button of the mouse.
- 3 Select **UNINSTALL** on the menu and left-click with the mouse.

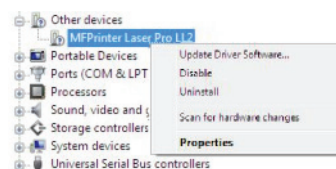

- 4 Click on the **OK** button to confirm the removal.
- 5 In the **IMAGING DEVICES** sub-menu, select the **SCANNER PRO LL2** item and right-click with the mouse.
- 6 Select **UNINSTALL** on the menu and left-click with the mouse.
- 7 Click on the **OK** button to confirm the removal.

Maintenance

Service

General information



CAUTION

For your safety, it is imperative to refer to the security directives presented in chapter **Security**, page 1.

To ensure that your machine is kept in the best conditions, it is recommended that you periodically clean the inner parts.

Please respect the following rules while using this machine:

- Do not leave the scanner cover open.
- Do not try to lubricate the device.
- Do not close the scanner cover violently or do not apply vibrations to the machine.
- Do not open the cartridge access cover while printing.
- Do not try to disassemble the machine.
- Do not use paper which has stayed in the tray for too long.

Toner cartridge replacement

Your machine comes with a current consumable management system. It tells you if your toner cartridge is close to its end of cycle.

The following messages will appear on your machine screen when the toner cartridge reaches the critical threshold (less than 10% toner cartridge left) and when it is empty:

**TONER NEAR
END**

**TONER EMPTY
REPLACE <OK>**

You can however change the toner cartridge at any time, before it reaches its end of cycle.



Important

Always use the smart card provided when replacing the toner cartridge. The smart card contains the information necessary to reset the level of toner. Replacing the toner cartridge without using a smart card may result in the consumable management system being inaccurate.

To replace the toner cartridge, proceed as shown below.

- 1 Insert the smart card provided with the new toner cartridge as shown on the picture below.

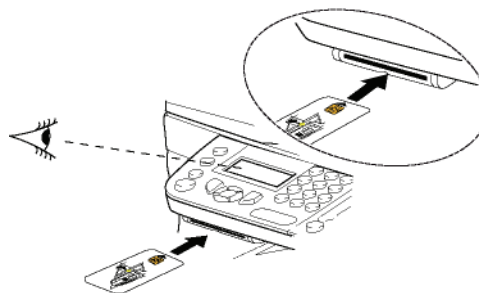

The following message appears:

**CHANGE TONER?
YES=OK - NO=C**

- 2 Press **OK**.

The following message appears:

**OPEN FRONT COVER
REPLACE TONER**

- 3 Stand in front of the device.
- 4 Push on the left and right sides of the cover and pull it towards you.
- 5 Raise and remove the toner cartridge from the machine.
- 6 Unpack the new cartridge and insert it into the slot as indicated in the diagram below.

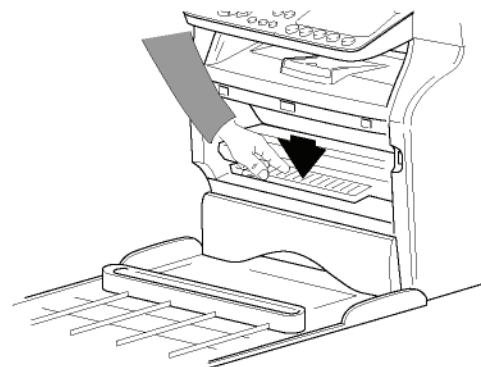
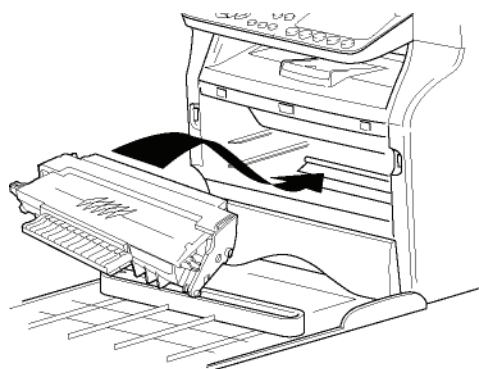

- 7 Close the cover.

The following message appears:

**HAVE YOU CHANGED
THE TONER? <OK>**

- 8 Press **OK**.

A wait message appears.

**PLEASE
WAIT**

The smart card is read.

**NEW TONER
REMOVE CARD**

- 9 Remove the smart card from the reader, your machine is ready to print again.

Issues with smart cards

If you use a smart card that has already been used, the machine will display:

**PLEASE
WAIT**

then,

**REMOVE CARD
ALREADY USED**

If you use a defective smart card, the machine will display:

**PLEASE
WAIT**

then,

**UNKNOWN CARD
REMOVE CARD**

If the **C** button is pressed while the smart card is being read, the machine displays:

**ACTION CANCELLED
REMOVE CARD**

Cleaning

Scanner reading system cleaning

When one or more vertical lines appear on the copies, clean the glass of the scanner.

- 1 Open the scanner cover until it is standing in vertical position.
- 2 Wipe the glass with a soft lint-free cloth soaked with mild alcohol.
- 3 Close the scanner cover.
- 4 Make a copy to check that the symptoms have disappeared.

Printer cleaning

Dust, dirtiness and paper debris on the external and internal surfaces of the printer can affect its operation. We advise that it is cleaned regularly.

Printer external cleaning

Clean the external part of the printer with a soft cloth soaked in mild detergent.

Document-feeder roller cleaning

Clean the roller of the document feeder when:

- one or more vertical lines appear on the copies of documents placed on the document feeder (presence of debris, ink, glue, etc., in the paper transport mechanism).
- the message ****YOU SHOULD CLEAN THE ROLLER OF THE SCANNER FEEDER. PLEASE REFER TO USER MANUAL. PRESS <STOP> WHEN THE ROLLER IS CLEANED**** warns you that the document feeder cannot transport paper sheets anymore (dust, dirt or debris obstructing the rollers). Press **OK** to clear the message on the screen.

To clean the document feeder roller, proceed as shown below:

- 1 Press the On/Off button to turn off the device (0 position) and unplug the power cord.
- 2 Open the document-feeder scanner cover.

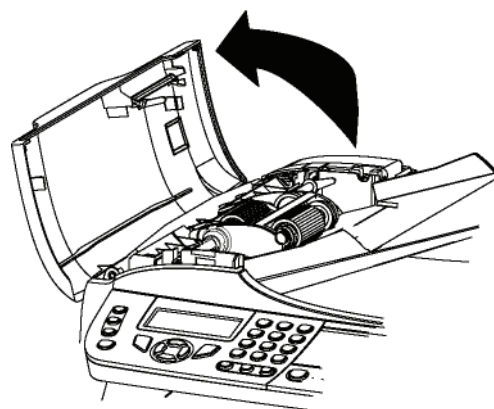

- 3 Clean the rollers of the document feeder and the two idler rollers located on the mobile part of the scanner with a soft lint-free cloth dampened with mild alcohol. To clean them, rotate them in the same direction as during paper transport.

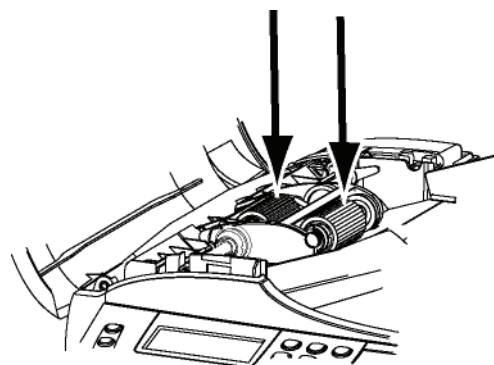

- 4 Wipe the rollers with a soft, dry lint-free cloth until they are dry.
- 5 Close the document-feeder scanner cover.
- 6 Plug the power cord to outlet on the wall and press the On/Off button to turn on the device (I position).
- 7 Make a copy to check that the symptoms have disappeared.

Printer issues

Error messages

When the printer encounters any of the problems described below, the corresponding message is shown on the machine display.

Message	Action
CHECK TONER	Check the presence of a toner cartridge in the machine.
TONER NEAR END	Indicates that your consumable will need changing soon.
REPLACE PAPER	Add paper in tray.
HEATING	Message displayed when starting the machine.
CLOSE COVER PRINTER	The printer front cover is open, close it.
TONER EMPTY REPLACE <OK>	Replace the toner cartridge.
PAPER JAM REMOVE TONER	A sheet of paper is jammed in the machine. Take out the toner cartridge and remove the jammed paper sheet. Take out the paper tray and remove the jammed paper sheet. Then open and close the consumable cover.
PAPER JAM EXTERNAL TRAY	A sheet of paper is jammed in the machine. Open the paper jam cover. Remove the jammed paper sheet. Then open and close the consumable cover.
PAPER EMPTY	Add paper in the paper tray.
INFORMATION **You should clean the roller of the scanner feeder. Please refer to user manual. Press <STOP> when the roller is cleaned**.	The document feeder cannot transport paper sheets anymore (dust, dirt or debris obstructing the rollers). Clean the roller of the document feeder.



Note

After one of the error messages listed above is displayed, it may happen that the active print job is cancelled (see **PC printing issues**, page 77). In case of printing of received fax, the print job is always restarted after clearing of the error.

Paper jam

When printing, a sheet of paper may get stuck in the printer or the paper tray and cause a paper jam.

In case of a paper jam in the machine, the following message appears:

PAPER JAM EXTERNAL TRAY

- 1 Open the paper jam cover located at the back of the machine.
- 2 Remove the jammed sheet of paper and close the cover.

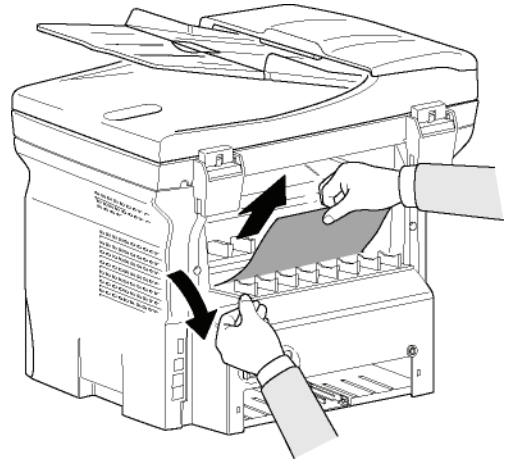

- 3 Open and close the front cover. The printer starts again automatically.



CAUTION

The fusion unit can reach a very high temperature during the operation. To prevent any harm, do not touch this area. For details, refer to **Positions of Safety labels on the machine**, page 3.

In case of paper jam, the following message appears:

PAPER JAM REMOVE TONER

- 1 Remove the toner cartridge and check if a sheet is jammed.
- 2 Remove the sheet of paper which causes the paper jam.
- 3 Put the toner cartridge in the machine, or remove the paper tray and remove the sheet of paper which causes the paper jam.
- 4 Check that the paper sheets in the paper tray are correctly placed.

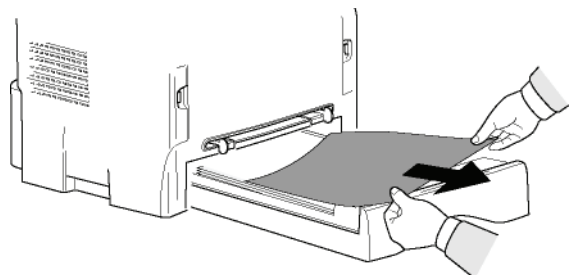

- 5 Replace the paper tray in the machine.

Scanner issues

When a paper jam occurs, the following message appears:

**REMOVE DOCUMENT
STOP TO CONFIRM**

- 1 Open the document feeder scanner cover.

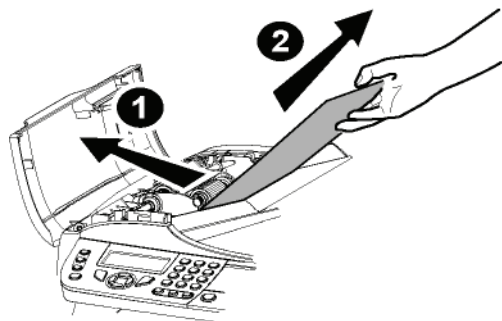

- 2 Remove the jammed paper without tearing it.
- 3 Close the document feeder scanner cover.
- 4 Press .

Miscellaneous issues

When turning on the terminal, nothing is displayed on the screen.

Check the connection between the power cord and the outlet.

The terminal does not detect the presence of the document inserted in the scanner document feeder. The message READY does not appear on the screen. At the start and during scanning, REMOVE DOCUMENT appears on the screen.

- 1 Remove the document or press button .
- 2 Check the thickness of the document (50 sheets of paper of 80 g/m²).
- 3 Iron out the sheets if needed.
- 4 Help the sheets along.

The terminal does not receive any faxes.

- 1 Check that the telephone line cable is correctly plugged in.
- 2 Check that there is a tone signal on the telephone line by means of the button .

You receive a blank page.

- 1 Make a photocopy of a document; if it is correct then your fax is functioning normally.
- 2 Call back the subscriber and have him / her resend the document. It was probably sent with the sheet inserted backwards.

You cannot send a fax.

- 1 Check that the telephone line cable is correctly plugged in.
- 2 Check the tone by pressing the button .
- 3 Check the prefix is correctly programmed and used.

Communication errors

If the communication fails, the terminal advises you of an automatic retry later.



Example of what is displayed:

Current time
Time of next try

FRI 12 DEC 20:13
0142685014 20:18

Transmission from the feeder

You have the choice between:

- waiting until the transmission takes place at the given time,
- restarting the transmission immediately by pressing ,
- abandoning transmission by pressing . To eject the document, press  again.

Transmission from memory

You have the choice between:

- waiting until the transmission takes place at the given time,
- restarting the transmission using the transmission queue. In this case, for a document composed of several pages, the transmission will take place from the page where the error occurred (see **Performing immediate transmission from the waiting queue**, page 26),
- abandoning the transmission by deleting the corresponding command in the transmission line (see **Deleting a transmission on hold**, page 27).

The terminal makes at most 5 automatic redials. The non-transmitted document is automatically deleted from the memory and a transmission report is then printed together with an error code and the cause for transmission failure (see the communication error codes).

Communication error codes

The communication error codes appear in the logs and transmission reports.

General codes

Code 01 - Busy or no fax answer

This code appears after 6 unsatisfactory attempts. Call later.

Code 03 - User break

A communication has been stopped by the user pressing the button .

Code 04 - Non programmed number

A number saved as a one-touch key or abbreviated number is not valid, check it. (Example: a delayed transmission was programmed with a one-touch key and this key has been deleted in the meantime).

Code 05 - Scanning default

An incident occurred with the scanner, for example, the sheet is jammed.

Code 06 - Printer default

An incident occurred in the printer: no paper, paper jam, opened cover... In the reception mode, this incident appears only if the reception parameter is switched to **WITHOUT PAPER**.

Code 07 - Disconnected

The link has been cut (bad line). Check the number and try again.

Code 08 - Quality

The document you sent was not well received. Contact your subscriber to see if you need to send again.

Code 0A - No document to be polled

You tried to poll a document from a subscriber who had not prepared his/her document (no deposit) or the password entered was incorrect.

Code 0B - Wrong number of pages

There is a difference between the number of pages indicated during preparation for the transmission and the number of pages sent. Check the number of pages in the document.

Code 0C - Received document error

Ask the subscriber who called you to check the length of his/her document (it may be too long to be completely received).

Code 0D - Transmission failed

Ask the sender to resend the document.

Code 13 - Memory full

Your fax can no longer receive since its memory is full. There are too many received unprinted documents or too many documents in the transmission line. Print the received documents and delete or transmit immediately the documents in the transmission line.

Code 14 - Memory full

Received document memory full. Print all received documents.

Code 15 - Unknown mailbox number

You wish to deposit a document in a subscriber's mailbox. The mailbox number does not exist.

Code 16 - No Relay Bcst list Nr x

You requested a document relay from a remote fax but the fax has not programmed the list of subscribers requested.

Code 17 - Unknown mailbox number

You wish to recover a document from a subscriber's mailbox. The mailbox number does not exist.

Code 18 - Relay Bcst impossible

You requested a document relay from a remote fax which does not have the relay broadcast function.

Code 19 - Subscriber has stopped

The communication has been stopped by your subscriber. (Example: a fax wanted to poll your fax but there is no document deposited).

Code 1A - Disconnected

The transmission has not started. The telephone line is busy.

Code 1B - Transmission failed

During transmission: start again.

During reception: ask your subscriber to resend the document.

Code 50 - Server error

Check the number configured for the SMS server or a communication error occurred during data transmission.

PC printing issues

This section details how the machine handles a print request after having encountered an issue (paper jam, connection loss, etc.).

Refer to the sections below to know if the printing of your document will resume or will be cancelled, depending on:

- the connection to the PC,
- the problem encountered during printing.

PC printing via USB connection

Issue encountered	Print request handling
Paper empty	Once the problem is resolved, printing resumes from the first non-printed page.
No paper feed	Once the problem is resolved, printing resumes from the first non-printed page. Exception: If the document was to be printed in manual duplex mode, the printing of the document is cancelled.
Paper jam	
Paper format problem	
Toner empty	The printing of the active document is cancelled. Documents waiting to be printed, however, will print after the toner cartridge is replaced.
Pause requested from the spooler	The machine switches to idle mode after a timeout (30 seconds by default). The printing of the active document is cancelled. Documents waiting to be printed, however, will be printed.
Loss of USB connection	Once the problem is resolved, the printing of the document restarts from the beginning, regardless of the number of pages already printed before the connection loss.

PC printing via WLAN connection

Issue encountered	Print request handling
Paper empty	Once the problem is resolved, printing resumes from the first non-printed page.
No paper feed	Once the problem is resolved, printing resumes from the first non-printed page.
Paper jam	Exception: If the document was to be printed in manual duplex mode, the printing of the document is cancelled.
Paper format problem	The printing of the active document is cancelled. Documents waiting to be printed, however, will be printed. or Printing resumes from the first non-printed page.
Pause requested from the spooler	The machine switches to idle mode after a timeout (30 seconds by default). The printing of the active document is cancelled. Documents waiting to be printed, however, will be printed.
Loss of WLAN connection	Once the problem is resolved, the printing of the document restarts from the beginning, regardless of the number of pages already printed before the connection loss.

Firmware update

Updating the machine firmware requires that the Companion Suite Pro software be installed on your PC, and that the PC is connected to the machine (see **PC Features**, page 52).

Visit our website www.sagem-communications.com to check if firmware updates are available for your machine, and download the appropriate update file on your PC.

Then, access the update utility (**START > ALL PROGRAMS > COMPANION SUITE > COMPANION SUITE PRO LL2 > COMPANION - FIRMWARE UPDATE**), select the downloaded file and launch the update.

Please check www.sagem-communications.com for new versions of this manual after the software is updated.

Specifications

Physical specifications

Dimensions: 412 x 447 x 386 mm
 Weight: 13 kg

Electrical specifications

Power supply (see rating plate): Single phase 220-240 V - 50/60 Hz - 4.5 A
 Electric consumption: 12 W typical in powersave
 35 W typical in standby
 450 W average during printing (900W peak)

Environmental specifications

Operating temperature: 10 °C to 27 °C [50 °F to 80.6 °F] with an ambient humidity included between 15 to 80% (up to 32°C [89.6 °F] with an ambient humidity included between 15 to 54%)

Peripheral specifications

Printer

Type: Laser (on normal paper)
 Resolution: 600 dpi
 Speed: 20 ppm maximum^a
 Preheating time: 21 sec.
 First page out time: 13 sec.

- a. Printing speed may vary depending on used operating systems, computer specifications, software applications, connection modes (USB or WLAN), paper formats as well as file types and sizes.

Copier

Type: Autonomous Black and White
 Copy speed: 20 ppm maximum
 Resolution: 600 dpi
 Multiple copies: 99 pages maximum
 Zoom range: 25 % to 400 %

Scanner

Type: Colour scanner
 Document feeder capacity: 50 sheets
 Colour depth: 36 bits
 Resolution: 600 dpi (optical)
 2400 dpi (interpolated)
 Software compatibility: TWAIN, WIA
 Maximum paper format: Letter

Printing supports

Main paper tray capacity: 250 sheets maximum (60 g/m²), 200 sheets maximum (80 g/m²)
 Output tray capacity: 50 sheets
 Main tray paper format: A4, A5, Statement, Legal, Letter
 60 to 105 g/m² paper
 Paper format for manual printing: A4, A5, Statement, Legal, Letter, B5, exec, A6
 52 to 160 g/m² paper

PC connection

Slave USB 2.0 port (PC connection)
 Master USB 2.0 port (Wlan connection, reader, USB memory key reader, USB-DECT base dongle - option)
 Operating System: Windows 2000 ≥ SP4, Windows XP x86 ≥ SP1, Windows Vista, Windows 2003 server (for printing only)

Consumable specifications

Reference paper

Scanner : Inapa tecno SPEED A4
Printer : Ricoh T6200 A4

Toner cartridge

Reference PFA821
PFA822

Specifications are subject to changes for improvement without notice.

Customer Information

We constantly strive to develop our products according to the highest quality standards and with the greatest possible user-friendliness.

In your user manual you will find all the information required to use your machine. If you nevertheless require assistance in addition to the user manual, our call centre is available. Our employees are trained experts who would be happy to answer your questions.

We can assist you more quickly if you do not call us from the machine, rather an external telephone. Keep a printout of the settings as well as the serial number of the machine handy. The serial number can be found on the type plate.

Should problems with the PC connection arise, have the following information to hand when you contact technical customer services: hardware configuration of your computer, operating system installed and security programmes used (anti-virus programmes, firewall). Then we can help you more quickly.

United Kingdom

Telephone: 08 71 - 075 07 11 (0,10 £/minute)

Fax: 08 70 - 124 02 02

Use only PHILIPS accessories. The warranty does not cover damages to the machine resulting from the use of other consumable materials.

In United Kingdom, you can order PHILIPS accessories by telephone via our toll-free telephone number.

United Kingdom

Telephone: 08 00 - 358 08 07

E-Mail: dti.faxinfo@sagem.com

Internet: www.sagem-communications.com

We hope that you will enjoy using your new product!



PHILIPS and the PHILIPS' Shield Emblem are registered trademarks of Koninklijke Philips Electronics N.V. and are used by SAGEM COMMUNICATIONS under license from Koninklijke Philips Electronics N.V.

SAGEM COMMUNICATIONS

Printing Terminals

Headquarters : Le Ponant de Paris

27, rue Leblanc · 75015 Paris · FRANCE

Tél. : +33 1 58 11 77 00 · Fax : +33 1 58 11 77 77

www.sagem-communications.com

Limited company · Capital 158.291.895 Euros · 440 294 510 RCS PARIS

LFF6050
GB · INT
253118301-A

Free Manuals Download Website

<http://myh66.com>

<http://usermanuals.us>

<http://www.somanuals.com>

<http://www.4manuals.cc>

<http://www.manual-lib.com>

<http://www.404manual.com>

<http://www.luxmanual.com>

<http://aubethermostatmanual.com>

Golf course search by state

<http://golfingnear.com>

Email search by domain

<http://emailbydomain.com>

Auto manuals search

<http://auto.somanuals.com>

TV manuals search

<http://tv.somanuals.com>