

MAGIC 5 eco



PPF 631

PPF 632

PPF 675

EN User Manual

PHILIPS

Dear Customer,

With the purchase of this device, you have chosen a quality PHILIPS product brand. Their device fulfils the most varied requirements for private use or in your office and business everyday.

Your device is delivered with an already inserted free ink film for a few test pages. For this film, you do not require any Plug'n'Print card (= chip card with information regarding ink film capacity).

In the telephone book of your machine, you can save entries with multiple numbers and collect multiple entries into groups. You can assign various ring tones to the entries.

You can assign short dial numbers to frequently dialled telephone numbers. You can load these numbers quickly with the short dial button and the number buttons.

The built-in answering machine (model-specific) stores up to 30 minutes of messages. You can record internal and external voice messages (= memos). Using remote message retrieval, you can call new messages from each telephone. With the VIP code, callers can also reach you even while the answering machine is switched on.

You can send fax messages in different resolutions to one or more recipients or a group. You can also poll faxes and prepare documents for polling.

Five fax templates, which you can use, are stored in your device. With these templates you can quickly create, for example, a short fax note or an invitation.

Select the resolution for text and photo in order to copy documents with your machine. You can also create multiple copies.

You can send SMS messages from your machine if this service is activated for your telephone line (this function is not supported in all countries and networks, model-specific). Received SMS messages can be managed with the extensive functions of the SMS menu.

Activate notification by SMS to receive an SMS message, for instance on your mobile phone, when calls, fax transmissions or other messages arrive in your absence (this function is not supported in all countries and networks, model-specific).

If you want, your device can print Sudoku puzzles in four different difficulty levels with solution.

We hope you enjoy your machine and its many functions!

About this User Manual

With the installation guide on the following pages, you can start using your machine quickly and easily. Detailed descriptions can be found in the following sections of this user manual.

Read the entire user manual carefully. Follow all safety instructions in order to ensure proper operation of your machine. The manufacturer accepts no liability if these instructions are not followed.

Multiple models of this machine series are described in this user manual. Please note that some functions are only available with specific models.

Symbols Used



Warns about dangers for people, damage to the device or other objects as well as possible loss of data. Injuries or damage can result from improper handling.



This symbol designates tips that will help you to use your machine more effectively and easily.

Table of Contents

Dear Customer,	2
About this User Manual	2
1 General Safety Information	4
2 Overview	5
Overview of the Menu Functions	5
Device Overview	6
Panel	7
3 Initial Operation	8
Package Contents	8
Attaching the Paper Tray	8
Inserting Paper	8
Connecting the Handset	8
Connecting the Telephone Cable	9
Connecting the Power Cable	9
Initial Installation	9
4 Telephone Functions	10
Making Telephone Calls on the Machine	10
Getting outside line	10
Chain Dialling	10
Insert dialling pause	10
Calling additional telephone functions	10
Hands-Free	11
Recording a telephone conversation	11
Telephone Book of the Machine	11
Groups	11
Short Dialling	12
Calling Line Identification (CLIP)	12
Missed Calls	12
5 Answering Machine	13
Switching On and Off	13
Editing the Outgoing Message	13
Listening to Messages	13
Deleting Messages	14
Setting up Forwarding and Remote Access	14
Using the Remote Control	14
Remote Control Functions	15
Recording Internal Memos	15
Modifying the Settings	15
6 Fax	16
Sending a Fax	16
Manually Sending a Fax	16
Direct inward dialling or selecting sub-address	16
Listening while a connection is established	17
Broadcasting	17
Delayed Fax Transmission	17
Receiving Faxes	17
Receiving fax automatically (fax only reception mode)	17
Receiving fax manually	17
Polling Faxes	17
Using Fax Templates	18
7 Copier	19
Inserting Documents	19
Creating a Copy	19
Creating Multiple Copies	19

8 SMS	20
SMS Requirements	20
Sending an SMS	20
Notification by SMS	20
Receiving an SMS	20
Reading an SMS	20
Loading SMS Functions	20
Printing SMS Messages	21
Deleting SMS Messages	21
Modifying the Settings	21
9 Fun and Games	22
Sudoku	22
10 Settings	23
Entering the Date and Time	23
Selecting the Language	23
Selecting the Country	23
Entering Your Number	23
Entering Your Name	23
Setting the Contrast	23
Lowering the Transmission Speed	23
Switching Page Adjustment On and Off	23
Setting line interruption	23
Setting the Ring Tone	24
Setting the Fax Switch	24
Printing Lists and Help Pages	25
Starting the Initial Installation	25
11 Telephone Lines and Additional Devices	26
Configuring Telephone Lines and Services	26
Connecting Additional Devices	26
Using Additional Telephones (Easylink)	26
12 Service	28
Checking the Ink Film Reserve	28
Changing the ink film	28
Fixing a Paper Jam	29
Fixing a Document Jam	30
Cleaning	30
Checking the Firmware Version	31
Using Service Codes	31
Power Cycling	32
13 Appendix	34
Technical Data	34
Declaration of Conformity (DoC)	34

1 General Safety Information

Your device has been tested in conformity with standards EN 60950-1 and IEC 60950-1 and should only be operated with telephone systems and power equipment that meet these standards. The device was built exclusively for use in the indicated sales region.

Do not make any changes or settings that are not described in this user manual.

Setting Up the Machine

The device should rest securely on a stable, flat surface. If the device should fall, it can be damaged or can cause injury to people, especially small children. Position all cables in such a way that no one will stumble on them, thus avoiding possible injuries to persons or damage to the device itself.

The distance between the device and other devices or objects must be at least 15 centimetres; this also applies to the use of additional cordless telephones. Do not place the device in the vicinity of radios or televisions.

Lock the cover of the device completely into place when opening the device. You could be injured if the cover falls while you are working on the device.

Protect the device against direct sunlight, heat, large temperature fluctuations and moisture. Do not place the device in the vicinity of heaters or air conditioners. Observe the information on temperature and humidity in the technical data.

The device must have sufficient ventilation and may not be covered. Do not put your device in closed cabinets or boxes. Do not place the machine on soft surfaces such as tablecloths or carpets and do not cover the ventilation slits. Otherwise, the device can overheat and catch on fire.

In the event that the device becomes too hot, or if you see smoke coming from the device, you must immediately pull the power cable out of the power socket. Have your device examined by trained professionals at a technical service location. To prevent the spread of fire, open flames should be kept away from the device.

Do not plug in the device in moist rooms. Never touch the mains cable, the mains connection or the telephone socket with wet hands.

Do not allow liquids to enter into the device. Disconnect the device from the power socket if liquids or foreign objects have entered the device and have your device examined by trained professionals at a technical service location.

Do not allow children to handle the device without supervision. The packing materials should be kept out of the hands of children.

The telephone handset of the device is magnetic. Caution, small metallic objects (paper clips) may be retained if placed near or on the telephone handset.

Power Supply

Check whether the mains voltage of your device (indicated on the type label) matches the mains voltage available at the setup location.

Use only the power and telephone cables supplied.

Set up your device so that the power socket is easily accessible. The device does not have an on/off button. In an emergency, disconnect your device from the power supply by pulling the power plug.

Never touch the power or telephone cable if the insulation is damaged.

Disconnect your device from the power and telephone networks during an electrical storm. If this is not possible, do not use the device during an electrical storm.

Before cleaning the surface of your device, disconnect it from the power and telephone networks. Never use liquid, gaseous or easily flammable cleansers (sprays, abrasives, polishes, alcohol).

Only clean the display with a dry, soft cloth. If the display breaks, a mildly corrosive liquid may escape. Avoid all contact with your skin and eyes.

In the event of a power failure, your device will not function; saved data is retained.

Repairs

Should disruptions occur, follow the instructions on the display and on the error report.

Do not make any repairs to the device yourself. Improper maintenance can result in injuries or damage to the device. Only have your device repaired by an authorised service centre.

Do not remove the type label from your device; this would void the warranty.

Consumable Materials

Use only original consumable materials. These are available from a specialised retailer or through our order service (see back side of this user manual). Other consumable materials could damage the device or shorten its service life.

Dispose of old consumable materials according to the waste regulations of your country.

2 Overview

Overview of the Menu Functions

The following functions are available on your device. There are two ways in which you can call functions:

Navigating in the menu: Press **OK** or one of the two arrow keys **▲/▼** to open the function menu. Page through **▲/▼** menu entries. Use **OK** to select a function. Press **C** to return to the previous menu level. Press **STOP** to close the menu and return to the starting mode.

Calling functions directly: You can call a menu function directly using the function number. Press **OK** and enter the appropriate function number using the numeric keypad. Confirm using **OK**. You will find the function number in the following list.

 Press **1** and **6** to print a list of all functions and settings of your device.

1 Telephone book

1 1	Looking up an entry.....	page 10
1 2	New entry.....	page 11
1 3	Creating group.....	page 11
1 4	Short dial.....	page 12
1 5	Modifying an entry.....	page 11
1 6	Deleting entries.....	page 11
1 7	Printing entries.....	page 25

2 Calls

2 1	Received calls.....	page 10
2 2	Outgoing calls.....	page 10
2 3	Printing entries.....	page 25
2 4	Setting line interruption (Hook-Flash-period) (function is not supported in all countries and networks).....	page 23

3 Fax

3 1	Polled reception.....	page 17
3 2	Polling send.....	page 18
3 3	Sending fax later.....	page 17
3 4	Sending to multiple recipients (= broadcast).....	page 17
3 5	Printing fax journal.....	page 25
3 6	Printing transmission report.....	page 25
3 7	Print reduced in size.....	page 23
3 8	Reducing transmission speed.....	page 23

4 Miscellaneous

4 1	Printing call list.....	page 25
4 2	Switching notification tone for call waiting on/off (PPF 675).....	page 11
4 3	Using fax templates.....	page 18

4 4	Setting the contrast.....	page 23
4 5	Using service codes.....	page 31
4 6	Checking the ink film reserve.....	page 28
4 7	Checking the firmware version.....	page 31
4 8	Sudoku.....	page 22

5 Fax switch

5 1	Configuring day mode.....	page 24
5 2	Configuring night mode.....	page 24
5 3	Setting the timer.....	page 24
5 4	Easylink.....	page 27
5 5	Setting the ring tones.....	page 24

6 SMS

(PPF 675)

6 1	Sending SMS.....	page 20
6 2	Reading SMS.....	page 20
6 3	Printing SMS.....	page 21
6 4	Deleting SMS.....	page 21
6 5	Notification by SMS.....	page 20
6 6	SMS access.....	page 21

7 Answering Machine

(PPF 675)

7 1	Switches answering machine on/off.....	page 13
7 2	Listening to messages.....	page 13
7 3	Recording internal memos.....	page 15
7 4	Setting the recording duration.....	page 15
7 5	Editing the announcement.....	page 13
7 6	Using announcement without recording message (= external memo).....	page 13
7 7	Forwarding messages.....	page 14
7 8	Entering the VIP code.....	page 15
7 9	Entering access code.....	page 14

9 Settings

9 1	Entering the date and time.....	page 23
9 2	Selecting the language.....	page 23
9 3	Selecting the country.....	page 23
9 4	Entering number.....	page 23
9 5	Entering name.....	page 23
9 6	Configuring telephone lines and services.....	page 26

Device Overview

- ❶ Handset
- ❷ Paper tray
- ❸ Document feeder (writing facing up)
- ❹ Panel with display
- ❺ -Socket—Connection socket for the telephone handset
- ❻ **EXT**-Socket—Connection socket for additional devices
- ❼ **LINE**-Socket—Connection socket for telephone cable

- ❶ Scanner glass
- ❷ Rollers of the automatic document feeder
- ❸ Rests of the intake rollers
- ❹ Document guide / scanner film
- ❺ Cover for scanner and automatic document feeder
- ❻ Toothed wheel for tightening the ink film
- ❼ Ink film roll in the rear ink film compartment
- ❸ Ink film roll in the front ink film compartment
- ❹ Slot for the Plug'n'Print card
- ❷ Locks for the cover of the scanner and automatic document feeder

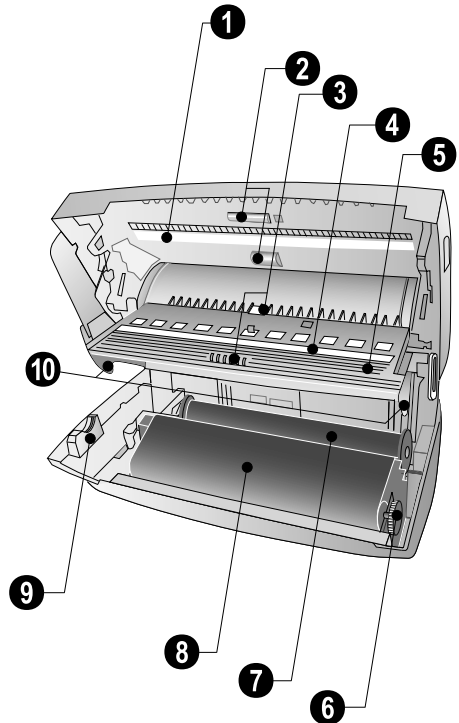
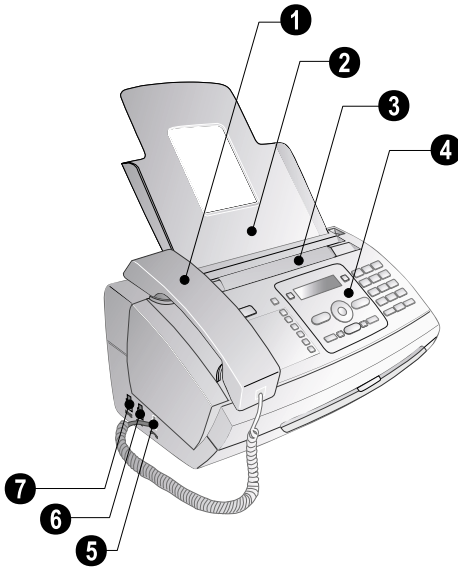

Panel

—Lights up, if new messages are received / list of the new messages with submenus / blinks in the case of device error (for example no ink film)

—Press briefly: Load short dial entries. Selecting the entries with the / or numeric keys / press and hold: Assign a new short dial entry

A-Z—Press briefly: Calling up the telephone book entries. Selecting the entries with the / / press and hold: saving new entries

—Setting the timer and the fax reception modes (= fax switch). Modes set on the display (day), (night), **F** (only fax reception, this function is not supported in all countries and networks). Activated timer is indicated with

STOP—Function abort / return to the starting mode / documents eject / (PPF 675): ending message playback

C—Return to the previous menu level / press briefly: deleting individual characters / press and hold: deleting complete input / (PPF 675): during a playback: deleting individual message / in the starting mode: deleting all messages

/ —Calling the menu functions / navigation within the menu / selecting options / moving the cursor / adjusting the volume level

OK—Calling the menu functions / confirming input

START—Press briefly: Starting transmission of messages / press and hold: Starting fax polling

(PPF 675)—Calling answering machine menu

—Press briefly: Printing help pages and setting lists / press and hold: Starting initial installation process

COPY—Press briefly: creating a copy / press and hold: creating multiple copies / (PPF 675): printing SMS

—Setting higher resolution for faxes and copying (RESOL. : STANDARD, RESOL. : FINE, RESOL. : PHOTO)

(PPF 675)—Calling the SMS menu (function is not supported in all countries and networks)

Numeric keypad—Inputting digits, characters and special characters / press and hold: Recalling short dial numbers

—Press briefly: Toggling between the list of the last 10 dialled numbers (= redial list) / press and hold: List of last ten callers (caller list)

—Dialling with the handset replaced / (PPF 675): hands-free

R—Press briefly: insert short line interruption (Hook Flash) as office index on PABX or for calling special functions in the public telephone network (PSTN)/long press: Inserting dialling pause

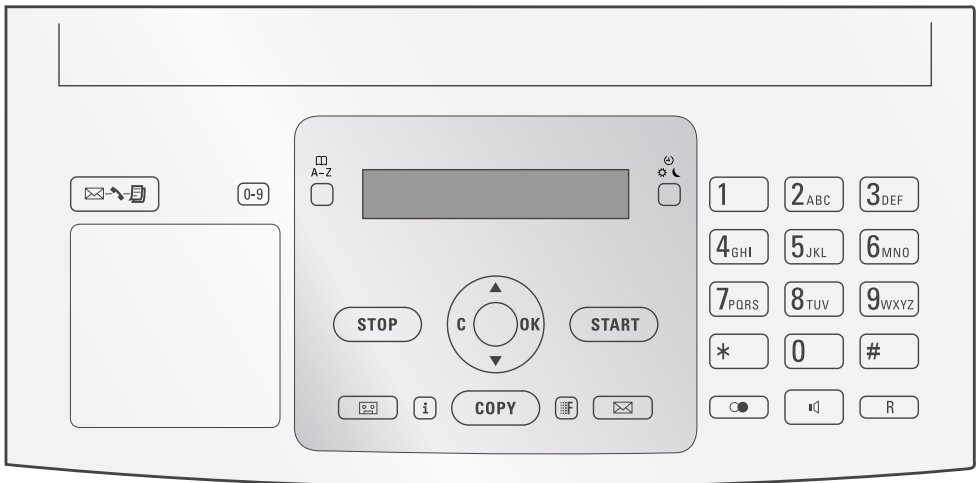

3 Initial Operation

Package Contents

- 1 Device
 - 2 Telephone handset
 - 3 Spiral cable for telephone handset
 - 4 Paper tray
 - 5 Mains cable with plug (country-specific)
 - 6 Telephone cable with plug (country-specific)
- User manual with installation guide (not depicted)

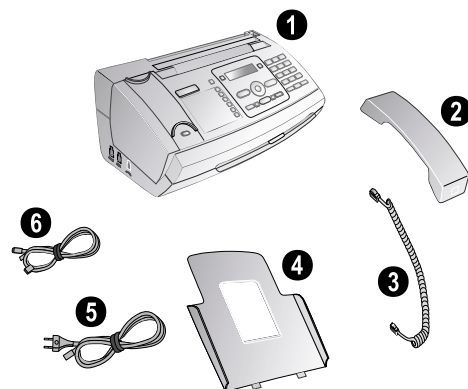

If one of the parts is missing or damaged, please contact your retailer or our customer service.

Attaching the Paper Tray

Insert the paper tray into the openings behind the paper feed mechanism.

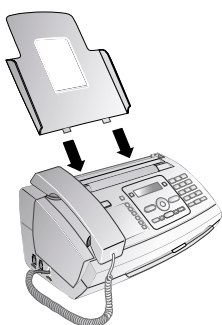

Inserting Paper

Before you can receive documents or make copies, you must load paper into the device. Please use only appropriate paper in standard format **A4** (210 × 297 millimetre · preferably 80 g/m²). Follow the specifications in the technical data.

Separate the paper sheets by fanning them out, then align them by tapping edge of the stack lightly against a flat surface. This will prevent several sheets of paper from being drawn in all at once.

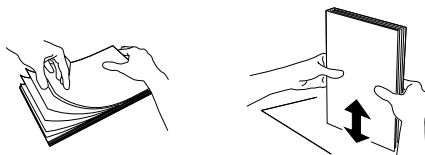

- 1 Fold open the lever on the right beside the paper feed towards front.
- 2 Insert paper in the paper feeder. You can insert **maximum 50 sheets** (A4 · 80 g/m²).
- 3 Fold open the lever on the right beside the paper feed backward in order to enclose the paper.

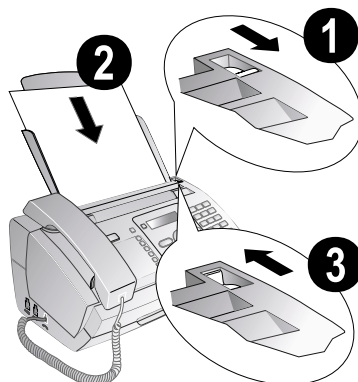

Connecting the Handset

Plug one end of the spiral cable into the socket on the telephone handset. Insert the other end into the socket designated with the  symbol.

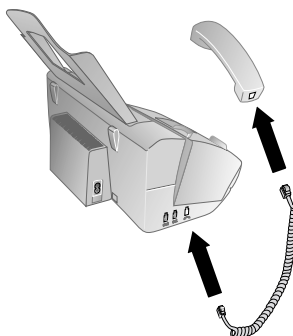

Connecting the Telephone Cable

 Your device is an analogue fax device (Group 3). It is not an ISDN device (Group 4), and therefore it cannot be operated directly on an ISDN connection. In order to do this, you need either an analogue adapter or a connection for analogue terminals.

Connect the telephone cable to the device by inserting it in the socket designated with **LINE** (RJ-11-Connector). Insert the telephone plug into your PTT line socket.

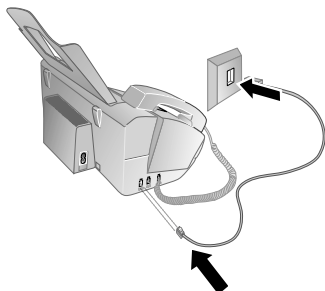

 If you connect your device as extension to a telephone system, you must set it for working as an extension (also see Chapter "Telephone connections and additional devices, page 26).

Connecting the Power Cable

 Check whether the mains voltage of your device (indicated on the type label) matches the mains voltage available at the setup location.

Insert the mains cable into the connection located on the rear side of the device. Connect the mains cable to the electrical socket.

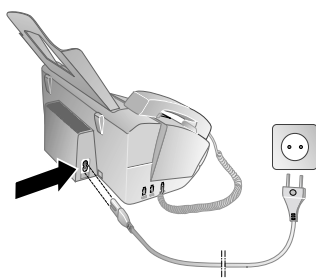

Initial Installation

After you connect your device to the mains voltage, the initial installation commences. Press **[1]**. Your device prints a help page.

Selecting the Language

- 1 Use **▲/▼** to select the desired display language.
- 2 Confirm with **OK**.

Selecting the Country

 Always set the country in which you are operating the machine. Otherwise, your machine is not adapted to the telephone network. If your country is not included in the list, you must select a different setting and use the correct telephone cable for the country. Consult your retailer.

- 1 Use **▲/▼** to select the country in which you are operating the machine.
- 2 Confirm with **OK**.

After this input, the machine prints another help page and checks the telephone line.

Entering Your Number

Your name and number are added together with date, time and page number at the top edge of each fax transmission (= header).

- 1 Enter your number. Using **[#]** or **[*]** you can enter a plus sign.
- 2 Confirm with **OK**.

Entering Your Name

- 1 Enter your name. You can enter characters using the numeric keys (see button labels). Enter special characters using **[0]**. Press the respective button several times until the desired character or special character appears on the display.

 You can move the cursor using **▲/▼**. Use **C** to delete individual characters.

- 2 Confirm with **OK**.

After the input, the machine prints an overview of the functions.

Entering the Time and Date

- 1 Enter the time, e.g. **[1][4][0][0]** for 2 pm.
- 2 Enter the date (two digits each) e.g. **[0][8][0][6][0][7]** for 8 June 2007.
- 3 Confirm with **OK**.

 You can restart the initial installation process any time. Press **[1]** and **[2]**.

4 Telephone Functions

 Press **[1]** and **[3]** to print an overview of the telephone book functions.

For information on how to connect additional telephones and which functions are available to you, please refer the chapter on Telephone Connections and Additional Devices, Page 26.

 In the fax only reception mode (F on the display) the device rings twice. Then the fax reception switches on. You can only accept an incoming telephone call whilst it is ringing (also see chapter Setting the Fax Switch, page 24) (this function is not supported in all countries and networks).

Making Telephone Calls on the Machine

Dial the desired telephone number. There are multiple ways to do this. Then lift up the handset.

 You can also lift up the receiver first, then dial a number. The dialling process begins immediately.

Manual dialling: Dial the desired telephone number with the number pad.

Telephone book:

1 Press **[A-Z]**

 You can also load telephone book entries by pressing **OK**, **[1]****[1]** and **OK**.

2 Select an entry using **▲/▼**. Enter the starting letters with the numeric keypad to quickly navigate through the telephone book.

 You can save an entry multiple times with the same name but in a different category. In the telephone book, the first letter of the category appears after the entry.

Short dial: Press **[0-9]**. Select the desired entry using **▲/▼** or with the numeric keys.

 You can also load short dial entries by holding the respective number button pressed (for at least two seconds).

Redial list: Press **☎**. Use **▲/▼** to select an entry from the list of the dialled numbers.

 You can also load the redial list by pressing **OK**, **[2]****[2]** and **OK**.

Caller list: Press and hold **☎** (at least two seconds). Use the **▲/▼** to select an entry from the list of callers.

 You can also load the caller list by pressing **OK**, **[2]****[1]** and **OK**.

 For this function to work, the caller line identification (CLIP) must be activated for your telephone connection (country and network dependent). The number and name will not be shown if the caller suppresses his number.

Getting outside line

Private branch exchanges (PABX) are typical in many offices and some households. You must dial an outside line access code in order to get a connection to the public telephone network (PSTN) from a PABX.

Enter the outside line access code with which you reach the public telephone network before you enter the desired number or select a stored entry. The outside line access code is usually **[0]**.

 In rare cases, the outside line access code may be a different number or a two-digit number. For older telephone systems, the outside line access code can be R (= Flash). Press **R** to enter this outside line access code. If the connection to the public telephone network is not possible, contact your telephone system supplier.

 If you operate your device permanently at an extension, store the outside line access code with the 96 function (see page 26).

Chain Dialling

You can combine and edit manually entered digits and saved entries, before the dialling process starts. If you have saved, for example, the telephone number prefix of an inexpensive telephone service provider (call-by-call) as a telephone book entry, select this entry and manually enter the subsequent telephone number or select another saved entry.

Insert dialling pause

It may be necessary to insert a dial pause in telephone number, for example, for a direct-inward dialling number, a sub-address or in a long distance number. Hold **R** pressed (for at least two seconds). **—** appears on the display. The second part of the number is dialled only after a short pause.

Calling additional telephone functions

(Function is not supported in all countries and networks)

You can use additional telephone functions with your device for example call on hold, three-way call or forwarding. Contact your telephone company to inquire whether or not these functions are available for your connection. The signal to the switchboard to call these services is a short line interruption (Hook Flash). Press the **R** key to call the additional telephone functions.

Making a Second Call

1 During a call, press **R**.

2 Enter the desired number using the numeric keypad or select a saved entry.

 Press **R**, to toggle between the calls.

Switching Between Calls

Press **R**, to toggle between the calls.

Receiving a Second Call

During a call, you can be informed about another call by a notification tone (= call waiting) if your telephone company offers this service. The notification tone for call waiting on the device is switched off in the factory.

During a call, press **R** to accept the new call.

 For this function to work, the caller line identification (CLIP) must be activated for your telephone connection (country and network dependent). The number and name will not be shown if the caller suppresses his number.

Switching notification tone for call waiting on/off

- 1 Press **OK**, **[4]** **[2]** and **OK**.
- 2 Use **▲/▼**, to select whether you would like to turn the call waiting on or off.
- 3 Confirm using **OK**.

Hands-Free (PPF675)

- 1 Press **[M]** to dial without lifting up the handset. You will hear a dial tone from the loudspeaker.
- 2 Enter the desired number using the numeric keypad or dial a saved entry. The dialling process begins immediately. Any incorrectly entered numbers can no longer be changed now.

 Put the handset near the device with the microphone facing up in order to achieve an optimum communication.

Recording a telephone conversation (PPF675)

You can record a telephone conversation. After recording, the **[M]** button flashes, and you can hear the recording like a message on the answering machine.

 You must inform your caller when recording a telephone conversation.

- 1 During a call, press **[2]**. The recording begins.
- 2 Press **[2]** again to end the recording.

Telephone Book of the Machine

In the telephone book of your device, you can save entries with multiple numbers and collect multiple entries into groups. You can assign various ring tones to the entries. Follow the specifications in the technical data.

 You can move the cursor using **▲/▼**. Use **C** to delete individual characters. Press **STOP** to close the menu and return to the starting mode.

Saving entry

- 1 Hold **[A-Z]** pressed (for at least two seconds).

 You can also call the function by pressing **OK**, **[1]** **[2]** and **OK**.

- 2 Enter the name. You can enter characters using the numeric keys (see button labels). Enter special characters using **[0]**. Press the respective button several times until the desired character or special character appears on the display.
- 3 Confirm with **OK**.
- 4 Using **▲/▼**, select the category for which you would like to enter a number: **CATEGORY: HOME**, **CATEGORY: WORK**, **CATEGORY: MOBILE** or **CATEGORY: FAX**.
- 5 Confirm with **OK**.
- 6 Enter the telephone number.
- 7 Confirm with **OK**.
- 8 You can assign a ring tone to the number. Use the number buttons **[0]** to **[9]** to select a ring tone. Using **▲/▼**, set the volume.
- 9 Confirm with **OK**. The entry is saved.

 In some countries and networks the individual ring tone of an entry only works when the device rings for the second time. The first ring will be the standard ring tone.

Edit Entry

- 1 Press **OK**, **[1]** **[5]** and **OK**.
- 2 Using **▲/▼** select the entry which you would like to edit.
- 3 Confirm with **OK**.
- 4 Edit the name.
- 5 Confirm with **OK**.
- 6 Using **▲/▼**, select the category for which you would like to enter a number: **CATEGORY: HOME**, **CATEGORY: WORK**, **CATEGORY: MOBILE** or **CATEGORY: FAX**.
- 7 Confirm with **OK**.
- 8 Enter the telephone number.
- 9 Confirm with **OK**.
- 10 You can assign a ring tone to the number. Use the number buttons **[0]** to **[9]** to select a ring tone. Using **▲/▼**, set the volume.
- 11 Confirm with **OK**. The entry is saved.

Deleting an Entry

- 1 Press **OK**, **[1]** **[6]** and **OK**.
- 2 Using **▲/▼** select the entry which you would like to delete.
- 3 Confirm with **OK**.
- 4 Confirm **DELETE: YES** with **OK**.

Groups

You can combine several telephone book entries into a group. A message is sent to all members of this group in succession.

Adding Group Entries

- 1 Press **OK**, **[1][3]** and **OK**.
- 2 Use **▲/▼** to select the group you would like to create.
- 3 Confirm with **OK**. You can add entries to the group, display the members of the group, delete the group or send a fax to the group.
- 4 Using **▲/▼** select **ADD MEMBER?**.
- 5 Confirm with **OK**.
- 6 Use **▲/▼** to select the entry you would like to add to the group.
- 7 Confirm with **OK**.
- 8 Repeat steps **4** to **6** to add additional entries to the group.
- 9 Press **STOP** to end the input.

Displaying Group Entries

- 1 Press **OK**, **[1][3]** and **OK**.
- 2 Use **▲/▼** to select the group you would like to display.
- 3 Confirm with **OK**.
- 4 Using **▲/▼** select **VIEW MEMBERS?**.
- 5 Confirm with **OK**.
- 6 Page through the entries of the group with **▲/▼**.
- 7 Press **STOP** twice to return to the starting mode.

Deleting Individual or All Group Entries

Deleting an Individual Entry

- 1 Press **OK**, **[1][3]** and **OK**.
- 2 Using **▲/▼** select the group from which you would like to delete entries.
- 3 Confirm with **OK**.
- 4 Using **▲/▼** select **DELETE MEMBER?**.
- 5 Confirm with **OK**.
- 6 Using **▲/▼** select the entry which you would like to delete.
- 7 Confirm with **OK**.
- 8 Using **▲/▼** select **DELETE: YES**.
- 9 Confirm with **OK**. The entry is deleted.



Deleting a Group

- 1 Press **OK**, **[1][3]** and **OK**.
- 2 Using **▲/▼** select the group you would like to delete.
- 3 Confirm with **OK**.
- 4 Using **▲/▼** select **DELETE MEMBER?**.
- 5 Confirm with **OK**.
- 6 Using **▲/▼** select **DELETE: ALL**.
- 7 Confirm with **OK**. All entries in the group are deleted.



Short Dialling

You can assign short dial numbers to frequently dialled telephone numbers. You can load these numbers quickly with the short dial button and the number buttons.

Assigning or Changing a Short Dial Entry

- 1 Hold **[0-9]** pressed (for at least two seconds).
 You can also call the function by pressing **OK**, **[1][4]** and **OK**.
- 2 Use **▲/▼** or the respective number button to select the short dial number you would like to assign or change.
 If you select a short dial number that is already assigned, the entry is overwritten.
- 3 Confirm with **OK**.
- 4 Use **▲/▼** to select the telephone book entry you would like to assign as a short dial entry.
- 5 Confirm with **OK**.

Deleting a Short Dial Entry

-  This function not only deletes the short dial entry, it also deletes the entire entry from the telephone book. Overwrite the short dial entry if you would like to change the assignment.
- 1 Press **[0-9]**.
 You can also call the function by pressing **OK**, **[1][4]** and **OK**.
 - 2 Use **▲/▼** or the respective number button to select the entry you would like to delete.
 - 3 Press **C**.
 - 4 Confirm the deletion with **OK**.

Calling Line Identification (CLIP) (Function is not supported in all countries and networks)

The number of an incoming call appears on the display. For this function to work, the Calling Line Identification Presentation (CLIP) must be activated for your telephone connection. Enquire with your telephone company. Caller Line Identification may be associated with a fee.



 If the Caller Line Identification does not work even though the function is activated for your telephone connection, check if you have set the correct country (also see Chapter Settings, page 23).

 The functionality and availability of the Caller Line Identification Presentation (CLIP) depends on your telephone company. Your telephone company could have no CLIP data transmission or very specific data transmission format which is not supported by this product.

In some networks the machine will set itself up automatically. The Caller Line Identification (CLIP) may only work from the second call.

Missed Calls

If you received a call while away, the **[☒-☑]** - button flashes.

- 1 Press **[☒-☑]**.
- 2 Using **▲/▼**, you can page through the list of missed calls.
 If you have received additional messages, first select the missed calls using **▲/▼** and confirm with **OK**.
- 3 To call back, pick up the handset.
 Your machine displays the name with which you have saved the number in the telephone book. The number and name will not be shown if the caller suppresses his number.

5 Answering Machine

(Model-dependent)

 Press **[1]** and **[3]** to print an overview of the answering machine functions.

 In the fax only reception mode (F on the display) the answering machine of the device is switched off. You cannot switch on the answering machine in this mode (also see chapter Setting the Fax Switch, page 24) (this function is not supported in all countries and networks).

Switching On and Off

 If you do not record a personal announcement, the answering machine uses the anonymous announcement set by the factory.

Press **[2]** three times to turn the answering machine on or off. If the answering machine is turned on, the symbol  appears on the display.

 You can also call the function by pressing **OK**, **[7]** **[1]** and **OK**.

Editing the Outgoing Message

 During playback, press **C** and **OK** in order to delete the currently playing outgoing message. Using **▲/▼**, set the volume. Stop the playback with **STOP**.

Recording the Outgoing Message

1 Press **[2]**.

2 Use **▲/▼** to select **OUTGOING MSG..**

3 Confirm using **OK**.

 You can also call the function by pressing **OK**, **[7]** **[5]** and **OK**.

4 Dial using **▲/▼** **MESSAGE: RECORD.**

5 Confirm using **OK**.

6 Press **OK** to record an outgoing message. Wait for the confirmation tone before you say your text.

 The outgoing message must be longer than ten seconds and shorter than twenty seconds.

7 Press **OK** to end the recording. The recording is played back.

 If the volume of the outgoing message is too low, rerecord the same. For recording, lift up the handset of the device and speak the text into the microphone.

Listening to the Outgoing Message

1 Press **[2]**.

2 Use **▲/▼** to select **OUTGOING MSG..**

3 Confirm using **OK**.

 You can also call the function by pressing **OK**, **[7]** **[5]** and **OK**.

4 Using **▲/▼** select **MESSAGE: PLAY.**

5 Confirm with **OK**. The outgoing message is played back.

Using the Anonymous Outgoing Message

You can replace your personal outgoing message with the factory default anonymous message.

1 Press **[2]**.

2 Use **▲/▼** to select **OUTGOING MSG..**

3 Confirm using **OK**.

 You can also call the function by pressing **OK**, **[7]** **[5]** and **OK**.

4 Using **▲/▼** select **MESSAGE: DEFAULT.**

5 Confirm with **OK**. The outgoing message is played back.

Using the Outgoing Message Without Recording of Messages

You can record an outgoing message which the caller hears for which no message can be recorded in reply (= external memo).

1 Press **[2]**.

2 Dial using **▲/▼** **EXTERN. MEMO.**

3 Confirm using **OK**.

 You can also call the function by pressing **OK**, **[7]** **[6]** and **OK**.

4 Use **▲/▼** to select whether you would like the outgoing message to be switched on/off without recording the message.

5 Confirm using **OK**.

 When you record an outgoing message, you are asked, if you would like to use the old outgoing message or would like to record a new one. Confirm using **OK**.

6 **Recording a new outgoing message:** Press **OK** to record the outgoing message. Wait for the confirmation tone before you say your text.

 The outgoing message must be longer than ten seconds.

7 Press **OK** to end the recording. The recording is played back.

 If the volume of the outgoing message is too low, rerecord the same. For recording, lift up the handset of the device and speak the text into the microphone.

Listening to Messages

 Press **[#]** to play the next message. With the number keys, you can load the desired message directly. During playback, press **C** and **OK** in order to delete the currently playing outgoing message. Using **▲/▼**, set the volume. Stop the playback with **STOP**.

Listening to New Messages

If new messages have been received on the answering machine, the  button blinks. The number of the new messages is shown on the display.

1 Press .

2 Confirm with **OK**.

3 The new messages are played back.

Listening to Messages Again

- 1 Press **[2]**.
- 2 Using **▲/▼** select **MESSAGES**.
- 3 Confirm with **OK**.
 You can also call the function by pressing **OK**, **[7]** **[2]** and **OK**.
- 4 Using **▲/▼** select **MESSAGE: PLAY**.
- 5 Confirm with **OK**. The messages are played back.

Deleting Messages

Deleting an Individual Message

During playback, press **C** and **OK** in order to delete the currently playing outgoing message.

Deleting Heard Messages

 Messages not yet heard must be heard first before deleting them.

- 1 Press **[2]**.
- 2 Using **▲/▼** select **MESSAGES**.
- 3 Confirm with **OK**.
 You can also call the function by pressing **OK**, **[7]** **[2]** and **OK**.
- 4 Using **▲/▼** select **MESSAGE: DELETE**.
- 5 Confirm with **OK**. The heard messages are deleted.



 You can also delete the already heard messages by pressing **C** and **OK** in the starting mode.

Setting up Forwarding and Remote Access

Entering Access Code

You must enter an access code to be able to receive transferred messages, or listen to and control your answering machine from other telephones.



 The remote control is switched off with the factory-installed access code (**0000**). Change the access code to switch on the remote control. If you want to switch the remote control off enter the factory-installed code **0000** again.

- 1 Press **[2]**.
- 2 Using **▲/▼** select **ACCESS CODE**.
- 3 Confirm with **OK**.
 You can also call the function by pressing **OK**, **[7]** **[9]** and **OK**.
- 4 Enter a four-digit code.
 The access code may not be identical to the VIP code.
- 5 Confirm with **OK**.

Forwarding Messages

The machine forwards messages to a specified telephone number. Once the configured number of messages is reached, the machine calls the number. If the call is an-

swered, a greeting text is played. Then the person on the line must enter the access code. If no code is entered or an incorrect code is entered three times, the machine hangs up.

- 1 Press **[2]**.
- 2 Using **▲/▼** select **FORWARDING**.
- 3 Confirm with **OK**.
 You can also call the function by pressing **OK**, **[7]** **[7]** and **OK**.
- 4 Use **▲/▼** to select whether you would like to switch forwarding on or off.
- 5 Confirm with **OK**.
- 6 Enter the number to which the received messages should be forwarded.
- 7 Confirm with **OK**.
- 8 Use **▲/▼** to select how many messages should be collected and forwarded together.
- 9 Confirm with **OK**.
 When you record a message, you are asked, if you would like to use the old message or would like to record a new one. Confirm using **OK**.
- 10 **Recording a new outgoing message:** Press **OK** to record an outgoing message. Wait for the confirmation tone before you say your text.
- 11 Press **OK** to end the recording. The recording is played back.

Using the Remote Control

With a telephone call, you can listen to and delete messages, record a new outgoing message or switch the answering machine on or off.

 The telephone on this connection must be set to tone dialling. Press a button within 50 seconds, otherwise the connection is cut-off (country and network dependent).

- 1 Call your telephone number.
- 2 Wait until the answering machine switches on and plays back the outgoing message.
- 3 Enter the access code.
- 4 The machine interrupts the outgoing message and plays new messages. If no new messages have been received, you will hear two confirmation tones.
 If you select the **5/2** option for the number of rings of the answering machine, the answering machine switches on after two rings, when you have received new messages. If there are no new messages, the device rings five times. If the device does not pick up after two rings, you have no new messages. You can terminate the remote access without incurring any telephone costs.
- 5 The functions below are available via the number buttons.
- 6 Hang up to end the remote control session.

Remote Control Functions

 Occasionally the answering machine might not react to your entry—for example while you are listening to a message. Cancel the current function by pressing **8**. Select the next function with the appropriate number button.

Listening to Messages

Hearing current message again: Press **1**.

Listening to all messages: Press **2**.

Listening to next message: Press **3**.

Deleting Messages

To delete the current message: Press **6** while listening to the message.

Deleting all messages: Press **6** after listening to all the messages.

Press **6** again within five seconds to confirm the deletion.

Outgoing Message

Listening to the outgoing message Press **5**.

Recording a new outgoing message:

- 1 Press **4**.
- 2 Wait for the confirmation tones.
- 3 Press **4**.
- 4 Wait for the long confirmation tone before beginning with the text.
- 5 Press **4** to end the recording.

Control Functions

Aborting last function: Press **8**.

Switching off answering machine Press **7**.

Switching on answering machine Press **9**.

 If the answering machine is switched off you have to enter the access code while the fax switch analyzing the incoming signal. After the 4th ring the tone heard changes (factory settings of the number of rings for fax switch, also see Chapter Setting the Fax Switch page 24). Press **9**, to activate the answering machine. Afterwards you can call additional functions.

Recording Internal Memos

You can record voice messages (= memos), which can be played as messages. The limit on duration of recording set for messages applies even to the recording duration of memos.

 The configured recording length for incoming messages also limits the length of the internal memos.

- 1 Press **29**.
- 2 Dial using **▲/▼** **QUICK NOTE**.
- 3 Confirm using **OK**.

 You can also call the function by pressing **OK**, **7** **3** and **OK**.

- 4 Press **OK** to record a voice message. Wait for the confirmation tone before you say your text.

- 5 Press **OK** to end the recording. The recording is played back. After that the  button starts flashing. The voice message is displayed as a new message.

 If the volume of the outgoing message is too low, rerecord the same. For recording, lift up the handset of the device and speak the text into the microphone.

Modifying the Settings

Entering the VIP Code

If callers enter the VIP code, the machine continues to ring, even if the answering machine has taken over the call. With this function, certain persons can reach you even if you have set the number of rings to zero.

 The VIP code may not be identical to the access code for remote control.

- 1 Press **29**.
- 2 Using **▲/▼** select **VIP CODE**.
- 3 Confirm with **OK**.

 You can also call the function by pressing **OK**, **7** **8** and **OK**.

- 4 Enter a four-digit code.
- 5 Confirm with **OK**.

Setting the Recording Length

You can limit the length of the incoming messages and internal memos.

- 1 Press **29**.
- 2 Using **▲/▼** select **RECORD. TIME**.
- 3 Confirm with **OK**.

 You can also call the function by pressing **OK**, **7** **4** and **OK**.

- 4 Use **▲/▼** to select the desired recording length or unlimited time (automatic).
- 5 Confirm with **OK**.

6 Fax

Press **1** and **4** to print the instructions for sending faxes and for fax switch settings.

Do not insert any documents into the machine that...

... are wet, have been edited with correction fluid, are soiled or have a coated surface.

... are written on with a soft pencil, with paint, chalk or charcoal.

... originate from newspapers or magazines (printing ink).

... are held together with office or notebook staples or with tape or glue.

... are pasted with note papers.

... are creased, crumpled or torn.

Use documents with sizes **A5** or **A4** with 60 to 100 g/m² weight. You can insert **up to 10 documents** at a time.

Press **STOP** to eject the documents without sending them.

Sending a Fax

- 1 Insert the documents face up into the document feeder. The top most document will be fed in first.

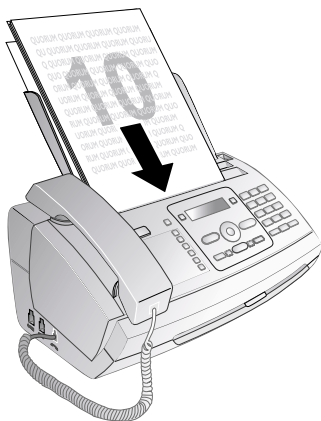

- 2 Set the desired resolution. You can choose between **RESOL. : STANDARD** (for documents without special features), **RESOL. : FINE** (for texts with small print or drawings) and **RESOL. : PHOTO** (for photos). Press **[RESOL.]**. The configured resolution appears on the display. Press **[RESOL.]** again to change the resolution.

They can adjust the preset contrast (also see Chapter "Settings", page 23).

- 3 Dial the desired number. There are several ways to do this:
- 4 Press **START**.

If the subscriber is busy, the device dials the number again after some time. Press **STOP**, in order to cancel the transmission process. After the transmission, the machine prints out a transmission report depending on the settings.

Manual dialling: Dial the desired telephone number with the number pad.

Telephone book:

- 1 Press **[PHONE BOOK]**.

You can also load telephone book entries by pressing **OK**, **[1]** and **OK**.

- 2 Select an entry using **▲/▼**. Enter the starting letters with the numeric keypad to quickly navigate through the telephone book.

You can save an entry multiple times with the same name but in a different category. In the telephone book, the first letter of the category appears after the entry.

Short dial: Press **[0-9]**. Select the desired entry using **▲/▼** or with the numeric keys.

You can also load short dial entries by holding the respective number button pressed (for at least two seconds).

Redial list: Press **[RECALL]**. Use **▲/▼** to select an entry from the list of the dialled numbers.

You can also load the redial list by pressing **OK**, **[2]** and **OK**.

Caller list: Press and hold **[RECALL]** (at least two seconds). Use the **▲/▼** to select an entry from the list of callers.

You can also load the caller list by pressing **OK**, **[2]** and **OK**.

For this function to work, the caller line identification (CLIP) must be activated for your telephone connection (country and network dependent). The number and name will not be shown if the caller suppresses his number.

Manually Sending a Fax

- 1 Insert the document.
- 2 Enter the desired number using the numeric keypad or select a saved entry.
- 3 Press **[START]**.
- 4 Press **START**.

Direct inward dialling or selecting sub-address

You can send a fax to a direct-inward dialling number or a sub address or call from a direct-inward dialling number or sub address - for example to use a certain service of a fax database provider. For this purpose, attach the direct-inward dialling number or sub address with a short dialling pause to the fax number.

- 1 Enter the desired number using the numeric keypad or select a saved entry.
- 2 Hold **R** pressed (for at least two seconds).
- 3 Enter the direct-inward dialling number or sub address.
- 4 Press **START**. The direct-inward dialling number or sub address is dialled only after a short pause.
- 5 Enter the desired number using the numeric keypad or select a saved entry.
- 6 **Selecting a saved entry:** Confirm the selected entry using **OK**.
- 7 Press **START**. The device goes into standby mode and transmits the fax at the entered time. You can continue to make telephone calls and receive faxes.

Listening while a connection is established

(PPF 631, PPF 632)

You can listen while a connection is established, for example if a fax transmission constantly fails.

Enter the desired number using the numeric keypad or select a saved entry. Press **⏸**.

 Hands-free operation is not possible with this function. You cannot answer if the subscriber picks up.

Broadcasting

You can send one fax to multiple recipients in succession.

Entering Recipients Individually

- 1 Insert the document.
- 2 Press **OK**, **[3][4]** and **OK**. The document is now read.
- 3 Enter the desired number using the numeric keypad or select a saved entry.
- 4 Confirm with **OK**.
- 5 Enter the next telephone numbers.
- 6 Confirm with **OK**. You can enter up to 25 recipients.
- 7 Press **START**. The device transmits the fax message successively to all recipients.

Sending a Fax to a Group

- 1 Insert the document.
- 2 Press **OK**, **[1][3]** and **OK**.
- 3 Use **▲/▼** to select the group to which you would like to send a fax.
- 4 Confirm with **OK**.
- 5 Using **▲/▼** select **SEND FAX?**.
- 6 Confirm with **OK**.

 If your machine cannot reach a recipient, the fax message is sent to the other recipients. After the machine has called all recipients, it once again dials the numbers that previously could not be reached.

Delayed Fax Transmission

If you would like to make use of the lower telephone tariffs or if the recipient can be reached at some specific time only, you can send the fax at a later time – within 24 hours.

- 1 Insert the document.
- 2 Press **OK**, **[3][3]** and **OK**.
- 3 Enter the time, at which the document should be transmitted, e.g. **[1][4][0][0]** for 2 pm.
- 4 Confirm with **OK**.

 Press **STOP** to eject the document. This interrupts the standby mode.

Receiving Faxes

If you have not changed the factory settings, received faxes will be printed out automatically. If no paper or no ink film is inserted, the machine saves the incoming faxes. The  - button blinks. Once paper or a new ink film is inserted, the saved faxes are printed out.

 Check whether you have inserted and clamped in the paper correctly. The lever on the right next to the paper feed mechanism must be pushed back.

If the message memory is full, no additional messages can be received. A warning appears on the display. Observe the information in the technical data.

 If there are problems with printing out saved fax messages, a service code is available (see also section Service, page 31).

Receiving fax automatically (fax only reception mode)

(Function is not supported in all countries and networks)

You should select this mode if you primarily receive faxes at your device. In the fax only reception mode (**F** on the display) the device rings twice. Then the fax reception switches on. You can only accept an incoming telephone call whilst it is ringing. You cannot switch on the answering machine in this mode (also see chapter Setting the Fax Switch, page 24).

Receiving fax manually

Select manual reception under number of rings of the fax switch (see Chapter Setting the Fax Switch, page 24). The device will not receive faxes on its own. This setting is useful, when you want to receive faxes via a modem connected to a computer.

You can start fax reception manually, by pressing **START**.

Polling Faxes

With the fax polling function, you can retrieve faxes that lie ready in the dialled fax machine. You can also provide documents on your machine to be polled by others.

Polling Faxes Directly

- 1 Enter the desired number using the numeric keypad or select a saved entry.
- 2 Hold **START** pressed (for at least two seconds).

Polling Secure Faxes

With this function, you can poll faxes that are protected with a code.

- 1 Press **OK**, **[3]****[1]** and **OK**.
- 2 Enter the code.
- 3 Confirm with **OK**.
- 4 Enter the desired number using the numeric keypad or select a saved entry.
- 5 Press **START**.

Sending Faxes via Polling

 Protect your document against unauthorised access with a code.

A caller who knows the code can poll the fax from your device. You can continue to make telephone calls and receive faxes.

- 1 Insert the document.
- 2 Press **OK**, **[3]****[2]** and **OK**.
- 3 Enter a code (max. 20 characters).
- 4 Confirm with **OK**.

 Press **STOP** to eject the document. This interrupts the standby mode.

Using Fax Templates

Five fax templates, which you can use, are stored in your device. With these templates you can quickly create, for example, a short fax note or an invitation.

- 1 Press **OK**, **[4]****[3]** and **OK**.
- 2 Use **▲/▼** to select the template you would like to print.
- 3 Confirm with **OK**. The device prints the template.
- 4 Fill the template and send it to the desired recipient per fax.

7 Copier



 Press **1** and **5** to print help for copying.

Use documents with sizes **A5** or **A4** with 60 to 100 g/m² weight. You can insert **up to 10 documents** at a time.

Inserting Documents

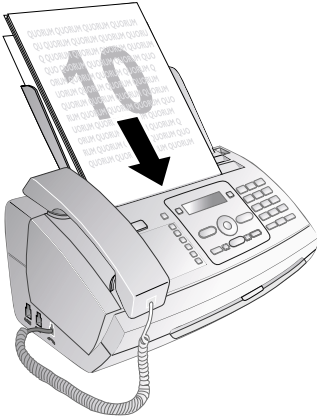
- 1 Insert the documents face up into the document feeder. The top most document will be fed in first.





- 2 Set the desired resolution. You can choose between **RESOL. : STANDARD** (for documents without special features), **RESOL. : FINE** (for texts with small print or drawings) and **RESOL. : PHOTO** (for photos). Press . The configured resolution appears on the display. Press  again to change the resolution.

 They can adjust the preset contrast (also see Chapter "Settings", page 23).

Creating a Copy

Press **COPY** briefly. The copy is created.

Creating Multiple Copies

- 1 Hold **COPY** pressed (for at least two seconds).
- 2 Enter the number of times you would like to copy the document (maximum of 15 copies).
- 3 Press **COPY**.
- 4 Using / select whether to reduce or enlarge the document in size when copying. You can magnify up to 200 percent or reduce to as small as 50 percent of the original size.
- 5 Confirm with **OK**. The copy is created.

 Press **STOP** to eject the documents without copying them.

8 SMS

(Model-dependent)

(Function is not supported in all countries and networks)

 Press **[1]** and **[8]** to print the instructions for SMS functions.

SMS Requirements

Your device is preset for using the SMS (Short Messaging Service) services. Caller Line Identification (CLIP) must be activated for the SMS to work. It is possible that you will not be able to send and receive SMS messages from a private branch exchange (depending on the country and network).

 Should you face problems in sending SMS, the reason for the same could be that you are using a secret number or that the device is connected to an old ISDN System.

 Ask your telephone service provider...

... whether you must register for the SMS Service.

... to which mobile telephone service providers you can send SMS

... which costs are applicable.

... which functions are available.

Sending an SMS

1 Press **[✉]**.

2 Confirm with **OK**.

 You can also call the function by pressing **OK**, **[6]****[1]** and **OK**.

 The last five SMS messages written remain saved as templates. Press **[C]** until the desired message appears.

3 You can enter characters using the numeric keys (see button labels). Press **[0]** to enter space or special characters.

You can enter 160 characters.

 You can move the cursor using **▲/▼**. Use **C** to delete individual characters. Press and hold **C** (at least two seconds) to delete the entire text. Press **COPY** to print the message before sending it.

4 Confirm with **OK**.

5 Enter the desired number using the numeric keypad or select a saved entry.

 You can send an SMS message to up to five recipients. Press **OK** after entering the number.

6 Press **[✉]**. The message is sent.

Notification by SMS

You can have an SMS message sent to a telephone number of your choice when faxes or SMS messages are received or the answering machine receives calls or voice messages in your absence.

1 Press **OK**, **[6]****[5]** and **OK**.

2 Use **▲/▼** to select whether you would like to be informed about new SMS messages.

3 Confirm with **OK**.

4 Use **▲/▼** to select whether you would like to be informed about calls in your absence.

5 Confirm with **OK**.

6 Use **▲/▼** to select whether you would like to be informed about new fax messages.

7 Confirm with **OK**.

8 Use **▲/▼** to select whether you would like to be informed about new messages on the answering machine.

9 Confirm with **OK**.

10 Enter the number to which the SMS should be sent.

11 Confirm with **OK**. A message appears on the display stating the notification by SMS is activated.

Receiving an SMS

 Check whether you have inserted and clamped in the paper correctly. The lever on the right next to the paper feed mechanism must be pushed back.

Received SMS messages are printed out automatically. If you have turned the automatic printing function off, the SMS messages will be stored. Your machine stores up to 30 received SMS messages.

Reading an SMS

After reception of a new SMS message, the **[✉]** button lights up.

1 Press **[✉]**.

2 Select the SMS using **▲/▼**.

3 Press **[✉]**. The Read SMS menu opens.

Loading Previously Read SMS Messages

1 Press **OK**, **[6]****[2]** and **OK**.

2 Using **▲/▼** select the SMS that you would like to read. Unread SMS messages are marked with a *.

3 Confirm with **OK**.

 You can move the cursor using **▲/▼**. Press **COPY** to print the SMS message.

4 Press **STOP** to return to the SMS list.

 Press **OK** to call additional SMS functions.

Loading SMS Functions

1 While reading an SMS message, press **OK** to load additional SMS functions.

2 Use **▲/▼** to select an option: You can display information about the SMS message, print or delete the message, forward the message to another recipient or send an SMS response. You can return to the list of SMS messages, or view the next or previous SMS message.

3 Confirm with **OK**.

Printing SMS Messages

- 1 Press **OK**, **[6][3]** and **OK**.
- 2 Using **▲/▼** select the SMS that you would like to print.
PRINT: ALL—Prints all received and composed SMS messages that you have saved
PRINT: INBOX—Prints all received SMS messages
PRINT: OUTBOX—Prints all sent SMS messages that you have saved
PRINT: NEW—Prints all unread SMS messages
- 3 Confirm with **OK**.



If you would like to print an individual SMS message, load the message. Press **COPY** to print the message.

Deleting SMS Messages

If the message memory is full, the device cannot receive any more messages. Delete SMS messages to free up memory.

- 1 Press **OK**, **[6][4]** and **OK**.
- 2 Use **▲/▼** to select the SMS messages you would like to delete:
DELETE: ALL SMS—Deletes all received and composed SMS messages that you have saved
DELETE: READ SMS—Deletes all read SMS messages
DELETE: SENT SMS—Deletes all sent SMS messages that you have saved
- 3 Confirm with **OK**.
- 4 Confirm the deletion with **OK**.



If you would like to delete an individual SMS message, load the message. Press **OK**, and using **▲/▼** to select **DELETE**. Confirm with **OK**.

Modifying the Settings

Changing Send and Receive Numbers

All numbers that you need to send and receive SMSs are stored in your device. In case you moved to another telephone service provider, you must change these numbers. You can set your device for two SMS service providers.

- 1 Press **OK**, **[6][6]** and **OK**.
- 2 Use **▲/▼** to select the SMS service provider that you would like to set.
- 3 Confirm using **OK**.
- 4 Enter the number for sending SMSs.
- 5 Confirm using **OK**.
- 6 Enter the number for receiving SMSs.
- 7 Confirm using **OK**.
- 8 Use **▲/▼** to select the SMS service provider through which you would like to send SMSs.
- 9 Confirm using **OK**.



You can receive SMS messages via both providers.

Switching Off Automatic Printing

You can deactivate the automatic printing of SMS messages.

- 1 Press **OK**, **[6][6]** then **OK** repeatedly until **PRINT SMS: YES** appears on the display.
- 2 Using **▲/▼** indicate whether you would like to turn printing on or off.
- 3 Confirm with **OK**.

Switching SMS Reception On and Off

If you are using a cordless telephone with SMS function on the same telephone line, then the specific device at which you will receive an SMS message will depend on the specific manufacturer. Only one of the devices will receive the SMS message. Try to turn off the SMS reception on your cordless telephone. If this is not possible, switch off SMS reception on the machine. You can continue to send SMS messages even while SMS reception is switched off.

Switching SMS Reception Off

- 1 Press **OK**, **[4][5]** and **OK**.
- 2 Enter the service code **[3][1][2][0][7]**.
- 3 Confirm with **OK**.
- 4 Using **▲/▼** select **SURE: YES**.
- 5 Confirm with **OK**.



If you have entered the incorrect code, you can cancel the entry with **SURE: NO**.

Switching SMS Reception On

- 1 Press **OK**, **[4][5]** and **OK**.
- 2 Enter the service code **[4][1][2][0][6]**.
- 3 Confirm with **OK**.
- 4 Using **▲/▼** select **SURE: YES**.
- 5 Confirm with **OK**.



If you have entered the incorrect code, you can cancel the entry with **SURE: NO**.

9 Fun and Games

 Press **[1]** and **[7]** to print the instructions for the Games and Fun functions of your device.

Sudoku

Sudoku is a Japanese number puzzle. The game has 3×3 squares divided into 3×3 fields. Depending on the difficulty level, lesser or more digits are already given at the beginning of the game. The aim of the game is to fill digits from 1 to 9 in the game field in such a way that each digit appears only once in a row, a column and each of the nine blocks. There is only one solution.

 The solution of the last printed game is saved. The solutions of earlier games are no longer available.

Printing a Game

- 1 Press **OK**, **[4]****[8]** and **OK**.
- 2 Using **▲/▼** select **SUDOKU: NEW**.
- 3 Confirm with **OK**.
- 4 Using **▲/▼** select the difficulty level.
- 5 Confirm with **OK**.
- 6 Enter, how many copies of the Sudoku you would like to print (maximum 9 copies).
- 7 Confirm with **OK**.
- 8 Using **▲/▼** select if you would like to print the solution.
- 9 Confirm with **OK**.

Printing the Last Game Again

- 1 Press **OK**, **[4]****[8]** and **OK**.
- 2 Using **▲/▼** select **SUDOKU: LAST**.
- 3 Confirm with **OK**.
- 4 Enter, how many copies of the Sudoku you would like to print (maximum 9 copies).
- 5 Confirm with **OK**.
- 6 Using **▲/▼** select if you would like to print the solution.
- 7 Confirm with **OK**.

Printing the Solution

- 1 Press **OK**, **[4]****[8]** and **OK**.
- 2 Using **▲/▼** select **SUDOKU: SOLUTION**.
- 3 Confirm with **OK**.

Sudoku for Every Day

You can have a new Sudoku automatically printed each day.

- 1 Press **OK**, **[4]****[8]** and **OK**.
- 2 Using **▲/▼** select **SUDOKU: AUTO**.
- 3 Confirm with **OK**.
- 4 Enter the time, e.g. **[1]****[4]** **[0]****[0]** for 2 pm.
- 5 Confirm with **OK**.
- 6 Using **▲/▼** select the difficulty level.
- 7 Confirm with **OK**.

8 Enter, how many copies of the Sudoku you would like to print (maximum 9 copies).

9 Confirm with **OK**.

10 Using **▲/▼** select if you would like to print the solution.

11 Confirm with **OK**.

12 Using **▲/▼** indicate whether you would like to turn printing on or off.

13 Confirm with **OK**.

 You can turn off the daily Sudoku print by selecting the function as described above and by switching off the automatic printing under point 12.

10 Settings

 You can move the cursor using ▲/▼. Use **C** to delete individual characters. Press **STOP** to close the menu and return to the starting mode.

Entering the Date and Time

- 1 Press **OK**, [9][1] and **OK**.
- 2 Enter the time, for example [1][4] [0][0] for 2 o'clock p.m.
- 3 Enter the date (two digits for each field), for example [0][8] [0][6] [0][7] for June 8th, 2007.
- 4 Confirm with **OK**.

 You must check the time and date after a short power failure. Confirm with **OK**.

Selecting the Language

- 1 Press **OK**, [9][2] and **OK**.
- 2 Use ▲/▼ to select the desired display language.
- 3 Confirm with **OK**.

Selecting the Country

 Always set the country in which you are operating the machine. Otherwise, your machine is not adapted to the telephone network. If your country is not included in the list, you must select a different setting and use the correct telephone cable for the country. Consult your retailer.

 When you select a new country, all settings are reset to the factory defaults for that country. Saved data is retained. Check the number entered for the header.

- 1 Press **OK**, [9][3] and **OK**.
- 2 Use ▲/▼ to select the country in which you are operating the machine.
- 3 Confirm with **OK**.
- 4 Using ▲/▼ select **SURE: YES**.
- 5 Confirm with **OK**.

Entering Your Number

Your name and number are added together with date, time and page number at the top edge of each fax transmission (= header).

- 1 Press **OK**, [9][4] and **OK**.
- 2 Enter your number. Using [#] or [*] you can enter a plus sign.
- 3 Confirm with **OK**.

Entering Your Name

- 1 Press **OK**, [9][5] and **OK**.
- 2 Enter your name. You can enter characters using the numeric keys (see button labels). Enter special characters using [0]. Press the respective key several times until the desired character or special character appears on the display.
- 3 Confirm using **OK**.

Setting the Contrast

For copying and printing of fax messages, you can select different contrast levels.

- 1 Press **OK**, [4][4] and **OK**.
- 2 Using ▲/▼, select the desired contrast:

CONTR. : LIGHT—For brighter copies and fax transmission

CONTR. : NEUTRAL—For all types of originals (for example white text on black background or documents with coloured background)

CONTR. : OPTIMISED (Factory settings)—Optimized adaptation for text and photo printing

CONTR. : DARK—For darker copies and fax transmission (for example documents with faint printing)

- 3 Confirm with **OK**.

 The changed settings are stored as new default settings. If you select a special function for a one-time process, take care to restore the default settings or factory settings after that.

Lowering the Transmission Speed

The machine adapts the transmission speed to the line quality. This may take some time, especially for overseas connections. Set a lower transmission speed if you are sending faxes into networks with poor line quality.

- 1 Press **OK**, [3][8] and **OK**.
- 2 Use ▲/▼ to set whether you would like to use a lower transmission speed.
- 3 Confirm with **OK**.

Switching Page Adjustment On and Off

In order that no information is lost, received faxes are reduced in size when printed.

- 1 Press **OK**, [3][7] and **OK**.
- 2 Use ▲/▼ to select whether you would like to switch size reduction on or off.
- 3 Confirm with **OK**.

Setting line interruption

(Function is not supported in all countries and networks)

The necessary length of the short line interruption (Hook Flash) depends on the country and telephone network. The Hook Flash period is set in the device by the factory, if you have selected the correct country, in which you operate your device. If you cannot call special functions or dial outside from an extension, you must probably change the Hook Flash time (country and network-dependent). Inquire with your telephone company or find out by trial and error with which settings these services function.

- 1 Press **OK**, **[2][4]** and **OK**.
- 2 Using the **▲/▼** key, select the length of the Hook Flash signal to the switching centre in the public switched telephone network (PSTN). Change this setting, if you cannot call additional telephone functions such as call on hold, three-way call or forwarding.
- 3 Confirm with **OK**.
- 4 Using the **▲/▼** key, select the length of the Hook Flash signal to the switching centre of a private automatic branch exchange (PABX). If the outside line access code of your telephone system is **R** (= Flash), set here-with the length of the signal for getting the outside line.

 If your device is not connected to a PABX or if your PABX system uses another outside line access code (for example **[0]**), this setting has no effect.

- 5 Confirm with **OK**.

Setting the Ring Tone

Selecting the Ring Tone

You can select from among ten different ring tones.

- 1 Press **OK**, **[5][5]** and **OK**.
- 2 Use the number buttons **[0]** to **[9]** to select a ring tone. Using **▲/▼**, set the volume.
- 3 Confirm with **OK**.

Setting the Volume

You can adjust the volume of the ring tone when the device is ringing or when you set the ring tone. You can save different volumes for the ***** (day) and **☾** (night) modes, (also see Chapter Fax Switch). Using **▲/▼** you can set adjust the volume when the device is ringing.

Setting the Fax Switch

The built-in fax switch of your device distinguishes between fax messages and telephone calls. Faxes are automatically received, telephone calls can be received—even on additionally connected devices. While the device is checking the call, it continues to ring.

You can set how often the device should ring before picking up separately for the modes ***** (day) and **☾** (night). This makes it possible for you to receive faxes silently at night without getting disturbed.

Press **☺/☼/☾** to switch between day and night mode. With the activated timer **⌚**, the device switches between the modes ***** (day) and **☾** (night) at the configured times.

In the fax only reception mode (**F** on the display) the device rings twice. Then the fax reception switches on (this function is not supported in all countries and networks).

Configuring Day Mode

- 1 Press **OK**, **[5][1]** and **OK**.
- 2 (Only for devices with built-in answering machine): Using **▲/▼** select the number of rings for the answering machine. The answering machine responds after these many number of rings.

 If you select the **5/2** option for the number of rings of the answering machine, the answering machine switches on after two rings, when you have received new messages. If there are no new messages, the device rings five times. If the device does not pick up after two rings, you have no new messages. You can terminate the remote access without incurring any telephone costs.

- 3 Confirm with **OK**.
- 4 (Only for devices without built-in answering machine): Using **▲/▼** select the total number of rings. The device stops the ring after these total number of rings and accepts a call or a possible silent fax.
- 5 Confirm with **OK**.
- 6 Use **▲/▼** to select the number of rings for the fax switch. After the number of rings, the fax switch switches on and distinguishes between fax transmissions and telephone calls. While the device is checking the call, it continues to ring.
- 7 Confirm with **OK**.
- 8 Using **▲/▼**, set the volume.
- 9 Confirm with **OK**.

 Older devices do not transmit any fax-tone (= CNG tone) as an announcement for fax transmission (= silent fax transmission). If the total number of rings has been set to a value using **7**, silent fax transmissions cannot be received automatically.

Configuring Night Mode

- 1 Press **OK**, **[5][2]** and **OK**.
- 2 Configure the same settings as for the day mode (see steps **2** to **9**).

Setting the Timer

The timer switches between the modes ***** (day) and **☾** (night) at the configured times.

- 1 Press **OK**, **[5][3]** and **OK**.
- 2 Enter the time at which the machine should switch to ***** (day) mode, for example **[0][6][0][0]** for 6 o'clock a.m.
- 3 Confirm with **OK**.
- 4 Enter the time at which the machine should switch to **☾** (day) mode, for example **[2][2][0][0]** for 2 o'clock a.m.
- 5 Confirm with **OK**.

Setting the Fax Only Reception Mode (Function is not supported in all countries and networks)

You should select this mode if you primarily receive faxes at your device. In the fax only reception mode the device rings twice. Then the fax reception switches on. You can only accept an incoming telephone call whilst it is ringing. The answering machine of the device is switched off. You cannot switch on the answering machine in this mode.

Press **☺/☼/☾** several times until **F** appears on the display.

Special Settings

Silent Fax Reception

If you would like to accept a fax without preceding rings, set the number of rings of the fax switch to 0.

Switching Off All Rings

If you don't want to be disturbed, e.g. in the night, by any incoming calls, you can set the number of rings to 0. The device switches immediately to silent fax reception.

Printing Lists and Help Pages

Printing Numbers and Entries

The list of numbers and entries contains the last ten calls received and numbers dialled as well as the saved entries and groups.

Press **OK**, **[2][3]** and **OK**. The list is printed.

Printing the Call List

The call list contains the last 50 numbers dialled.

- 1 Press **OK**, **[4][1]** and **OK**.
- 2 Using **▲/▼** indicate whether you would like to turn printing on or off.
- 3 Confirm with **OK**.
- 4 **Switch on printing:** Use **▲/▼**, to select whether the call list should be printed immediately or after every 50 calls.
- 5 Confirm with **OK**.

Printing the Telephone Book

Press **OK**, **[1][7]** and **OK**. The machine prints a list with the telephone book entries and saved assignments.

Printing Fax Journal

The fax journal is a list of the last ten faxes sent and received.

- 1 Press **OK**, **[3][5]** and **OK**.
- 2 Using **▲/▼** indicate whether you would like to turn printing on or off.
- 3 Confirm with **OK**.
- 4 **Switch on printing:** Use **▲/▼**, to select whether the fax journal should be printed immediately or after every ten transmissions.
- 5 Confirm with **OK**.

Printing Transmission Report

After every transmission, the machine prints out a transmission report. If a transmission error occurs, an error report is printed out. You can switch off printing of the transmission report.

- 1 Press **OK**, **[3][6]** and **OK**.
- 2 Using **▲/▼** indicate whether you would like to turn printing on or off.
- 3 Confirm with **OK**.

Printing Help Pages

Help 1 · Overview

Press **[i]** and **[1]** to print an overview of the help pages.

Help 3 · Telephone Book

Press **[i]** and **[3]** to print an overview of the telephone book and answering machine functions (model dependent).

Help 4 · Fax Transmission

Press **[i]** and **[4]** to print instructions for sending fax messages and for configuring the fax switch.

Help 5 · Copier

Press **[i]** and **[5]** to print the help for copying.

Help 6 · Function List

Press **[i]** and **[6]** to print a list of all functions and settings of your machine.

Help 7 · Games and Fun

Press **[i]** and **[7]** to print the instructions for the Games and Fun functions of your device.

Help 8 · SMS

Press **[i]** and **[8]** to print the instructions for SMS functions (depending on the model).

Starting the Initial Installation

- 1 Press **[i]** and **[2]**.
- 2 The machine prints out a help page and starts the initial installation process.

11 Telephone Lines and Additional Devices

Configuring Telephone Lines and Services

PABX Systems

Private branch exchanges (PABX) are typical in many of offices and some households. You must dial an outside line access code in order to get a connection to the public telephone network (PSTN) from a PABX.

 An additional telephone connected to the machine on a telephone socket is not considered an extension.

- 1 Press **OK**, **[9][6]** and **OK**.
- 2 In some countries you can set the dialling process to pulse dialling or tone dialling (DTMF tones). Use **▲/▼** to select the desired dialling process.
 Only use pulse dialling if tone dialling is not yet activated for your telephone line.
- 3 Confirm with **OK**.
- 4 Use **▲/▼** to set whether you operate your device on an extension.
- 5 Confirm with **OK**.
- 6 **Configuring an extension:** Enter the outside line access code with which you reach the public telephone network. This is usually **[0]**.

 In rare cases, the outside line access code may be a different number or a two-digit number. For older telephone systems, the outside line access code can be R (= Flash). Press **R** to enter this outside line access code. If the connection to the public telephone network is not possible, contact your telephone system supplier.

- 7 Confirm with **OK**.
- 8 When finished, the device tests the telephone line. Confirm with **OK**.
- 9 Your device checks whether it can establish a connection with the public telephone network. If it cannot establish the connection, you are once again asked for input.

DSL Connection

In the event that you use a DSL modem: Connect the machine after the modem. For additional information, please consult the operating manual of your DSL system.

ISDN Connection

Your device is an analogue fax device (Group 3). It is not an ISDN device (Group 4), and therefore it cannot be operated directly on an ISDN connection. In order to do this, you need either an analogue adapter or a connection for analogue terminals. Details for ISDN connections can be found in the instructions provided with the terminal adapter or the dial-up router.

Voice-Mailbox

You cannot simultaneously use the answering machine facility of your telephone service provider (= voice-mail box) and receive faxes on your devices. Get the mail-box function for your telephone connection deactivated or set the number of rings for the fax switch to lower than **5** on your device (also see Chapter Setting the Fax Switch, Page 24). When the fax switch accepts the call, the mail-box of the service provider does not step in. Enquire with your telephone company.

Connecting Additional Devices

You can operate additional devices on a telephone line, such as cordless telephones, answering machines, modems or charge counters.

 If you are using a cordless telephone with SMS function on the same line, then the specific device at which you will receive an SMS message will depend on the specific manufacturer. Only one of the devices will receive the SMS message. Try to turn off the SMS reception on your cordless telephone.

Connection to the Machine

You can connect additional devices directly to your device. Insert the telephone cable of the additional device into the **EXT**- socket (RJ-11-connection) on the device.

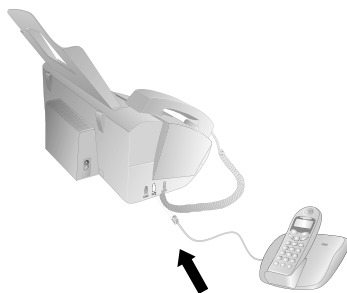

 We recommend direct connection to the device because this allows the fax switch to function optimally and to control the additional devices.

Connection to the Telephone Line

In order for the fax switch to function, the machine must be first in the series if multiple devices are connected to the same telephone socket. Follow the correct order.

 If you have multiple telephone sockets for the same telephone line, the machine must be connected to the first telephone socket.

Using Additional Telephones (Easylink)

With the Easylink function you can control your device with additional telephones. To use this function, additional telephones must be set to the tone dialling mode (DTMF/MFV tones) (for this purpose see the operating manual of your additional telephone).

Starting Fax Reception

If you pick up at an additional device and hear that you are receiving a fax (whistling tone or silence), you can start the fax reception by pressing **[*][5]** on the additional telephone or pressing **START** on the device.

Taking Over the Line

If you pick up on an additional telephone and the machine continues to ring or attempts to receive a fax, you can disconnect the machine from the line. Press **[*][*]** on the additional telephone.

Changing Code

 Only change the codes if it is absolutely necessary. The codes must begin with **[*]** or **[#]** and must be different.

- 1 Press **OK**, **[5][4]** and **OK**.
- 2 Enter the new code for starting fax reception.
- 3 Confirm with **OK**.
- 4 Enter the new code for taking over the line on an additional device.
- 5 Confirm with **OK**.

Using an External Answering Machine

For the best operation, the answering machine must be connected to the **EXT** socket of the device. The numbers of rings set for the external answering machine should be less than the one set under **FAX RINGS** by at least two.

Example of the setting:

```

Number of Rings of the External Answering Machine... 1
FAX RINGS ..... 3

```

(also see Chapter Setting the Fax Switch, page 24)

 The outgoing message should be shorter than ten seconds. Avoid music in the outgoing message.

If the external answering machine has a “conserving function” (i.e. a function that changes the number of rings as soon as new messages have been recorded), deactivate this function.

If the external answering machine records fax signals, but your device cannot receive faxes, inspect the connection of the external answering machine

12 Service

 Should disruptions occur, follow the instructions on the display and on the error report.

EN

Checking the Ink Film Reserve

- 1 Press **OK**, **[4]** **[6]** and **OK**.
- 2 The number of pages that can still be printed with the ink film is shown on the display.
- 3 Press **STOP** to return to the starting mode.

If the ink film used up or if there is no ink film in the machine, a message appears on the display.

Changing the ink film

 Use only original consumable materials. These are available from a specialised retailer or through our order service (see back side of this user manual). Other consumable materials can cause damage to the device.

 Follow the instructions on the packaging of the consumable materials.

For receiving or copying documents, an ink film must be inserted in your device. Your device is delivered with an already inserted free ink film for a few test pages. For this film, you do not require any Plug'n'Print card (= chip card with information regarding ink film capacity). For every next ink film that you insert, you must load the capacity memory with the included Plug'n'Print card.

- 1 Remove the paper from the paper feeder and take the paper tray out of the device.
- 2 Open the device by lifting the panel using grip in the centre and folding it up.

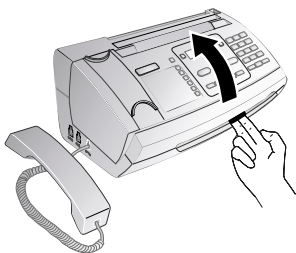

 Lock the cover of the device completely into place when opening the device. You could be injured if the cover falls while you are working on the device.

- 3 Grip the rear ink film roll at both the sides and place it next to the front ink film roll.

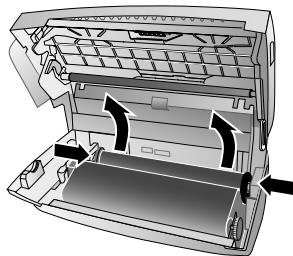

- 4 Remove both the rolls from the device. The used ink film cannot be reused.



 The messages and copies you have printed out can be read from used ink films. Consider data protection issues when disposing of used ink films.

- 5 Pull the used Plug'n'Print card out of the plug socket on the left hand side next to the ink film tray. The Plug'n'Print card cannot be reused.

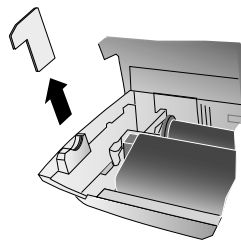

- 6 Carefully remove the rubber bands from the new ink film. Make sure that the film is not damaged!

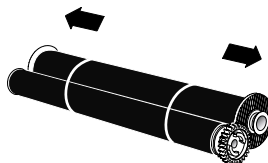

- 7 Place the larger roll with the ink film in the rear ink film tray. The blue gear wheel must be on the right hand side.

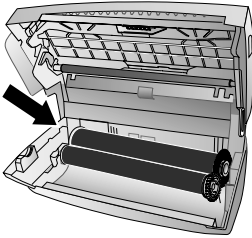

- 8 Place the smaller roll without ink film in the front tray. The blue gear wheel must be on the right hand side and the pin must be inserted in the depression on the left hand side.

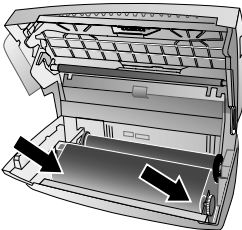

- 9 Break the chip card from the Plug'n'Print card. Insert the chip card in the plug socket on the left hand side next to the ink film tray.

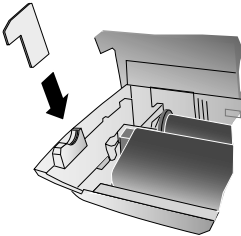

- 10 Turn the blue gear wheel forward to tension the ink film. The ink film must not have any creases.

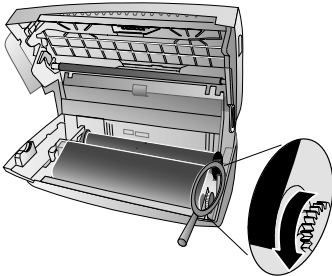

- 11 Close the device. Insert the paper tray in the opening provided for it behind the paper feeder. Insert paper again.

Fixing a Paper Jam

- 1 Remove the paper from the paper feeder and take the paper tray out of the device.
- 2 Open the device by lifting the panel using grip in the centre and folding it up.



- ⚠** Lock the cover of the device completely into place when opening the device. You could be injured if the cover falls while you are working on the device.

- 3 Carefully pull the paper out.

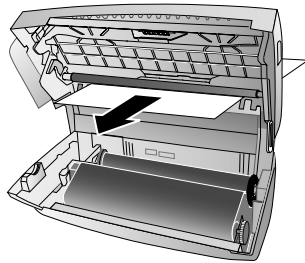

- 4 Turn the blue gear wheel forward to tension the ink film. The ink film must not have any creases.

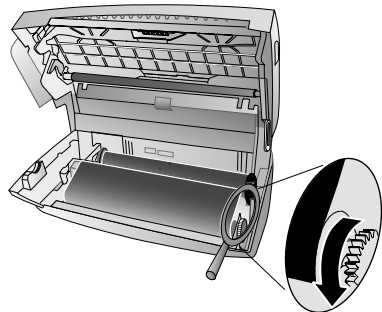

- 5 Close the device. Insert the paper tray in the opening provided for it behind the paper feeder. Insert paper again.

Fixing a Document Jam

- 1 Remove the paper from the paper feeder and take the paper tray out of the device.
- 2 Open the device by lifting the panel using grip in the centre and folding it up.

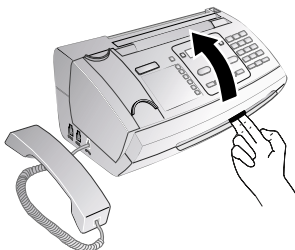

⚠ Lock the cover of the device completely into place when opening the device. You could be injured if the cover falls while you are working on the device.

- 3 Open the scanner cover and the cover of the automatic document cover by first pushing the support (A) and then the support (B) inside. The cover (C) folds below.

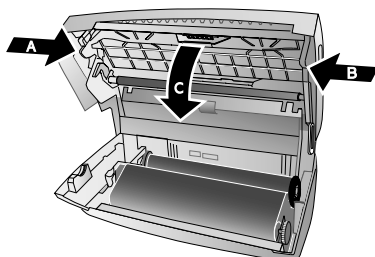

- 4 Carefully pull the document to the front or to the back out of the device.

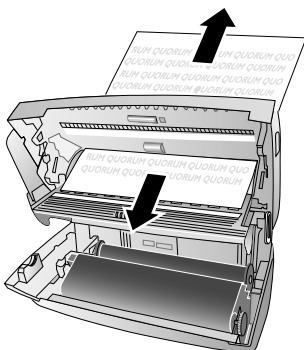

- 5 Close the scanner cover and the cover of the automatic document feeder. Both the supports must securely snap into place.

- 6 Turn the blue gear wheel forward to tension the ink film. The ink film must not have any creases.

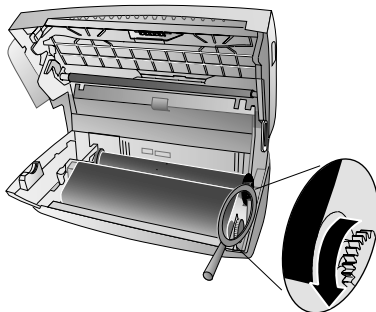

- 7 Close the device. Insert the paper tray in the opening provided for it behind the paper feeder. Insert paper again.

Cleaning

⚠ Unplug the device from the power socket before cleaning it. Use a soft, lint-free cloth. Never use liquid or easily flammable cleansers (sprays, abrasives, polishes, alcohol, etc.). Do not allow any moisture to reach the interior of the device.

💡 Special fax cleaning sheets are available as accessories from our call centre. Insert a sheet into the document feeder. Press **STOP**, the page is ejected. Repeat this process at a few times.

- 1 Remove the paper from the paper feeder and take the paper tray out of the device.
- 2 Open the device by lifting the panel using grip in the centre and folding it up.



⚠ Lock the cover of the device completely into place when opening the device. You could be injured if the cover falls while you are working on the device.

- 3 Open the scanner cover and the cover of the automatic document cover by first pushing the support (A) and then the support (B) inside. The cover (C) folds below.

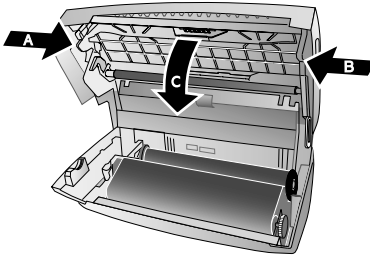

- 4 Lightly wipe the upper side of the scanner glass (A) and the lower side of the document feeder/scanner film (= white plastic plate) (B) with a cloth.

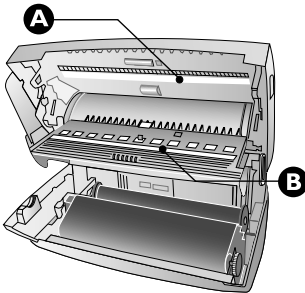

- 5 Clean the feed roller (A) and the underside of the support pad of the feeder roller (B) with a soft, lint-free cloth moistened with cleaning alcohol (96 percent). Rotate the feed roller; You must clean the entire roller.

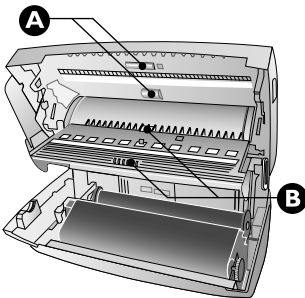

- 6 Close the scanner cover and the cover of the automatic document feeder. Both the supports must securely snap into place.

- 7 Turn the blue gear wheel forward to tension the ink film. The ink film must not have any creases.

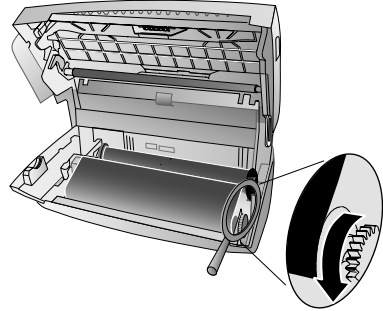

- 8 Close the device. Insert the paper tray in the opening provided for it behind the paper feeder. Insert paper again.

Checking the Firmware Version

- 1 Press **OK**, **4** **7** and **OK**.
- 2 The model designation and the configured country appear on the display.
- 3 Confirm with **OK**.
- 4 The information on the firmware version of the device is displayed.
- 5 Confirm with **OK**.

Using Service Codes

The service codes delete all the changed settings and your device is reset to factory settings. It may be possible that the device with the changed settings reacts differently than expected.

⚠ Only use the service codes if this is absolutely necessary. Some service codes also delete saved messages and telephone book entries.

- 1 Press **OK**, **4** **5** and **OK**.
- 2 Enter a service code:
 - 7 1 1 7**—Deletes all changed settings and saved data. The device is reset to factory settings and the initial installation process is started.
 - 7 1 4 0**—Deletes all changed settings. Saved data and telephone book entries remain intact.
 - 7 2 2 7**—Deletes saved faxes, when there are problems with printing.
- 3 Confirm with **OK**.
- 4 Using **▲/▼** select **SURE: YES**.
- 5 Confirm with **OK**.

⚠ If you have entered the incorrect code, you can cancel the entry with **SURE: NO**.

Power Cycling

If a problem occurs that cannot be corrected with the instructions in this user manual (see also the help below), follow the steps given here.

- 1 Pull out the power plug.
- 2 Wait at least ten seconds, then plug the power plug back into the socket.
- 3 If the error occurs again, please contact our technical customer service or your retailer. Follow the instructions on the display and on the error report.

General information	
The time and date flash on the display.	You must check the time and date after a short power failure. Confirm using OK .
Problems when faxing or printing	
Faxes sent are of poor quality.	Change the resolution from RESOL. : STANDARD to RESOL. : FINE or RESOL. : PHOTO . Change the contrast. Clean the scanner and the document feed slot. Test the device by making a copy of the document. If the device is in order, the fax machine of the recipient is defective.
The device produces black lines when sending or printing.	Clean the scanner and the document feed slot.
Copy is blank.	Insert the documents face up into the document feeder.
Printing is interrupted.	Paper or document jam, no paper or ink film. Follow the instructions on the display and in the error report. There could be a small pause after printing several pages. The device continues printing automatically.
No printing	Check if you have inserted clamped paper correctly. The lever on the right hand side next to the paper feeder must be folded backwards.
Documents are not properly fed.	Clean the scanner and the document feed slot.
Problems with the connection	
The device rings once, remains silent for a short while and starts ringing again.	This is absolutely normal. The fax switch checks the call after the first ring. If it is a voice call, the device continues to ring.
No dial tone	Check the installation of the device. Connect the telephone cable to the socket marked LINE . Insert the telephone plug into your telephone connection socket.
Fax transmissions are constantly interrupted.	Try to send the fax manually: Press ⏏ and dial the number. If the recipient is using an answering machine, wait until you hear a whistling tone. Press START . It is possible that the recipient's machine is not ready to receive.

Problems with the connection	
You hear a whistling tone or silence in the handset.	The call is a fax: Press START on the device. In addition, press [*][5] on the telephone. Hang up.
No fax reception or a short fax audio signal as message on the answering machine	Using function 51, set the number of rings for the fax switch to 4 and the total number or the number of rings for the answering machine (model dependent) to 5 (see Page 24). You cannot simultaneously use the answering machine facility of your telephone service provider (= voice-mail box) and receive faxes on your devices(see page 26).

13 Appendix

Technical Data

Dimensions (L × H × W) 313 × 129 × 197 mm
Weight 1,9 kg
Power Supply 220–240 V - / 50–60 Hz
Power Consumption
Stand-by mode < 1,5 W
Transmission < 20 W
Recommended Ambient Temperature..... 18–28 °C
Relative humidity 20–80% (non-condensing)
Type of connection..... PSTN · PABX
Dialling mode.Tone / pulse dialling (country dependent)
CLIP/New Zealand
The device does not support CLIP function when cadences DA4 is used and have limited CLIP function for cadence DA3.

Standards

Safety..... EN 60950-1
Emissions EN 55022 Class B
Immunity to electrical noiseEN 55024

Scanner

Scan width..... 212 mm
Horizontal resolution.....8 dots/mm
Vertical resolution Standard: 3,85 lines/mm
..... Fine: 7,7 lines/mm

Memory

Telephone book..... up to 50 entries (PPF 631, PPF 632)
..... up to 200 entries (PPF 675)
Voice messages..... up to 30 minutes (PPF 675)
Fax messages
up to 15 pages (standard test letter) (PPF 631, PPF 632)
..... up to 50 pages (standard test letter) (PPF 675)
SMS messages..... up to 30 SMS messages

Paper

Capacity 50 sheets
Size..... A4 · 210 × 297 mm
Thickness 0,07–0,11 mm
Weight60–90 g/m²

Document Feeder

Capacity 10 sheets
Breadth..... 148–212 mm
Length 100–600 mm
Thickness 0,06–0,15 mm

Fax

Type..... Group 3
CompatibilityITU-TT.30
Data compressionMH · MR
Modulation V.21 · V.27ter · V.29 (PPF 631, PPF 632)
..... V.17 · V.21 · V.27ter · V.29 (PPF 675)
Transfer Speed
9.600 bps (PPF 631, PPF 632)
..... 14.400 bps (PPF 675)

Technical specifications subject to change without notice.



The CE symbol confirms conformity with the EU directives that apply to the device.

Declaration of Conformity (DoC)

Hereby, **Sagem Communications Austria GmbH** declares that this **PPF 631, PPF 632, PPF 675** is in compliance with the essential requirements and other relevant provisions of Directive 1999/5/EC.

You can find the complete Declaration of Conformity on our website www.sagem-ca.at/doc



As a participant in the ENERGY STAR programme, Sagem Communications Austria GmbH has made sure that this machine complies with the ENERGY STAR requirements.

Environment: Respect of environment is a key objective of Sagem. Sagem uses environmentally friendly processes to run its operations and has chosen to integrate strong environmental constraints in the full lifecycle of its products including manufacturing, product use and end of life.



Packaging: To facilitate packaging recycling, please conform to your local selective recycling rules.

Batteries: Old batteries have to be deposited in designated collection areas.



Product: The crossed out dustbin logo on your product signifies it is classified as Electrical and Electronic Equipment covered by special disposal regulations.

To enforce recycling, recovery of The Waste Electrical and Electronic Equipment (WEEE) and to protect the environment and human health, European regulations requires that you selectively collect waste equipment using one of the following options:

- Your retailer will take your equipment back if you are buying a replacement product.
- Waste equipment can also be deposited in designated collection areas.

This user manual was printed on recycled paper bleached without chlorine. This satisfies the highest standards for low environmental impact. The cardboard packaging used and the packaging inserts of paper and cardboard can be disposed of as waste paper. The plastic foil may be submitted for recycling or disposed of with waste not intended for recycling, depending on the requirements in your country.

Trademarks: The references mentioned in this manual are trademarks of the respective companies. The lack of the symbols ® and ™ does not justify the assumption that these dedicated terms are free trademarks. Other product names used herein are for identification purposes only and may be trademarks of their respective owners. Sagem disclaims any and all rights in those marks.

The reproduction of certain documents (e.g. by scanning, printing, copying) is prohibited in many countries. The list of such documents below is not intended to be complete, it only offers a general overview. In case of doubt, consult your legal advisor.

- Passports (personal identification)
- Entrance and exit visa papers (immigration papers)
- Military service documents
- Bank notes, travel checks, payment orders
- Postage stamps, tax stamps (stamped or unstamped)
- Loan papers, certificates of deposit, bonds
- Documents protected by copyright

Follow the statutory regulations of your country with regard to the legal validity of fax transmissions – particularly in connection with the validity of signatures, meeting delivery deadlines or disadvantages resulting from the loss of quality in the transmission, etc.

Take care to maintain the statutory regulations of your country regarding telecommunications secrecy and data privacy.

This product is intended for use on an analogue public telecommunications network (PSTN) and in the country specified on the packaging. Use in other countries can result in faulty functioning.

For more information, please contact the technical service centre for your country. Should problems arise during use of your machine, please contact your retailer first.

Neither Sagem nor its affiliates shall be liable to the purchaser of this product or third parties for damages, losses, costs, or expenses incurred by the purchaser or third parties as a result of accident, misuse, or abuse of this product or unauthorized modifications, repairs, or alterations to this product, or failure to strictly comply with Sagem operating and maintenance instructions.

Sagem shall not be liable for any damages or problems arising from the use of any options or any consumable materials other than those designated as original Sagem products or Sagem approved products.

Sagem shall not be held liable for any damage resulting from electromagnetic interference that occurs from the use of any interface cables other than those designated as Sagem products.

All rights reserved. No part of this publication may be reproduced, stored in a retrieval system or transmitted in any form or by any means, electronic, mechanical, photocopying, recording, or otherwise, without the prior written per-

mission of Sagem. The information contained herein is designed only for use with this product. Sagem is not responsible, if this information is applied to other devices.

This user manual is a document that does not represent a contract.

Errors, printing errors and changes are reserved.

Copyright © 2008 Sagem Communications Austria GmbH

E-Mail: dti.faxinfo@sagem.com

Internet: www.sagem-communications.com



PHILIPS and the PHILIPS' Shield Emblem are registered trademarks of Koninklijke Philips Electronics N.V. and are used by SAGEM COMMUNICATIONS under license from Koninklijke Philips Electronics N.V.

SAGEM COMMUNICATIONS

Printing Terminals

Headquarters : Le Ponant de Paris
27, rue Leblanc · 75015 Paris · FRANCE
Tél. : +33 1 58 11 77 00 · Fax : +33 1 58 11 77 77
www.sagem-communications.com
Limited company · Capital 167.038.185 Euros · 440 294 510 RCS PARIS

PPF 631 · 632 · 675
INT-EN
253120976-A

Free Manuals Download Website

<http://myh66.com>

<http://usermanuals.us>

<http://www.somanuals.com>

<http://www.4manuals.cc>

<http://www.manual-lib.com>

<http://www.404manual.com>

<http://www.luxmanual.com>

<http://aubethermostatmanual.com>

Golf course search by state

<http://golfingnear.com>

Email search by domain

<http://emailbydomain.com>

Auto manuals search

<http://auto.somanuals.com>

TV manuals search

<http://tv.somanuals.com>