

Register your product and get support at
www.philips.com/welcome

MAGIC 5

PPF 725

PPF 755



EN User Manual

PHILIPS

Dear Customer

With the purchase of this device, you have chosen a quality PHILIPS product brand. Their device fulfils the most varied requirements for private use or in your office and business everyday.

Your device is delivered with an already inserted free ink film for a few test pages. For this ink film, you do not require any Plug'n'Print card (= chip card with information regarding ink film capacity).

In the telephone book of your device, you can save entries with multiple numbers and collect multiple entries into groups. You can assign various ring tones to the entries.

You can assign short dial numbers to frequently dialled telephone numbers. You can load these numbers quickly with the short dial key and the number keys.

The built-in answering machine (model dependent) stores up to 30 minutes of messages. You can record internal and external voice messages (= memos). Using remote message retrieval, you can call new messages from each telephone. With the VIP code, callers can also reach you even while the answering machine is switched on.

You can send fax messages in different resolutions to one or more recipients or a group. You can also poll faxes and prepare documents for polling.

Five fax templates, which you can use, are stored in your device. With these templates you can quickly create, for example, a short fax note or an invitation.

Select the resolution for text and photo in order to copy documents with your device. You can also create multiple copies.

You can send SMS messages from your device if this service is activated for your telephone line (this function is not supported in all countries and networks, model dependent). Received SMS messages can be managed with the extensive functions of the SMS menu.

Activate notification by SMS to receive an SMS message, for instance on your mobile phone, when calls, fax transmissions or other messages arrive in your absence (this function is not supported in all countries and networks, model dependent).

If you want, your device can print Sudoku puzzles in four different difficulty levels with solution.

We hope you enjoy your device and its many functions!

About this User Manual

With the installation guide on the following pages, you can start using your device quickly and easily. Detailed descriptions can be found in the following sections of this user manual.

Read the entire user manual carefully. Follow all safety instructions in order to ensure proper operation of your device. The manufacturer accepts no liability if these instructions are not followed.

Multiple models of this device series are described in this user manual. Please note that some functions are only available with specific models.

Symbols Used



Troubleshooting

This symbol designates tips that will help you to use your device more effectively and easily.



DANGER!

Warns about dangers for people, damage to the device or other objects as well as possible loss of data. Injuries or damage can result from improper handling.

DANGER!

Table of Contents

1	General Safety Information	4	7	Copier	23
				Inserting Documents	23
2	Overview	5		Making a Copy	23
	Overview of the Menu Functions	5		Creating Multiple Copies	23
	Device Overview	7			
	Panel	8	8	SMS	24
3	Initial Operation	9		SMS Requirements	24
	Packing Contents	9		Sending SMS	24
	Attaching Paper Tray	9		Notification by SMS	24
	Loading Paper	9		Receiving SMS Messages	24
	Connecting the Handset	10		Reading SMS Messages	24
	Connecting the Telephone Cable	10		Calling SMS Functions	25
	Connecting the Mains Cable	10		Printing SMS Messages	25
	Initial Installation	10		Deleting SMS Messages	25
				Modifying the Settings	25
4	Telephone Functions	12	9	Fun and Games	27
	Placing a Call on the Device	12		Sudoku	27
	Calling Additional Telephone Functions	12	10	Settings	28
	Getting Outside Line	13		Entering the Date and Time	28
	Chain Dialling	13		Selecting the Language	28
	Insert Dialling Pause	13		Selecting the Country	28
	Hands-Free	13		Entering Number	28
	Recording a Telephone Conversation	13		Entering Name	28
	Telephone Book of the Device	13		Adjust contrast	28
	Groups	14		Reducing Transmission Speed	29
	Short Dial	15		Switching Page Adjustment On and Off	29
	Calling Line Identification (CLIP)	15		Setting the Ring Tones	29
	Missed Calls	15		Setting the Fax Switch	29
				Printing Lists and Help Pages	30
				Starting Initial Installation	30
5	Answering Machine	16	11	Telephone Lines and Additional Devices	31
	Switching On and Off	16		Configuring Telephone Lines and Services	31
	Editing the Outgoing Message	16		Connecting Additional Devices	31
	Listening to Messages	17		Using Additional Telephones (Easylink)	32
	Deleting Messages	17	12	Service	33
	Setting up Forwarding and Remote Access	17		Checking the Ink Film Reserve	33
	Using Remote Access	18		Changing the Ink Film	33
	Remote Control Functions	18		Fixing a Paper Jam	34
	Recording Internal Memos	19		Fixing a Document Jam	35
	Modifying the Settings	19		Cleaning	36
				Checking the Firmware Version	37
6	Fax	20		Using Service Codes	37
	Sending a Fax	20		Power Cycling	37
	Sending Fax Manually	21		Troubleshooting	38
	Direct Inward Dialling or Selecting Sub-address	21	13	Appendix	39
	Eavesdropping while Connection is Established	21		Technical Data	39
	Sending to Multiple Recipients (= Broadcasting)	21			
	Sending Fax Later	22			
	Fax Reception	22			
	Receiving Fax Manually	22			
	Polling Faxes	22			
	Using Fax Templates	22			

I General Safety Information

Your device has been tested in conformity with standards EN 60950-1 and IEC 60950-1 and should only be operated with telephone systems and power equipment that meet these standards. The device was built exclusively for use in the indicated sales region.

Do not make any changes or settings that are not described in this user manual. Physical injury or damage to the device or loss of data can result from improper handling. Take note of all warning and safety notes indicated.

Setting Up the Device

The device should be placed securely on a stable, flat surface. If the device should fall, it can be damaged or can cause injury to people, especially small children. Position all cables in such a way that no one will stumble on them, thus avoiding possible injuries to persons or damage to the device itself. If the device is dropped it should be inspected by a technical service center.

The distance between the device and other devices or objects must be at least 15 centimetres; this also applies to the use of additional cordless telephones. Do not place the device in the vicinity of radios or televisions.

Lock the cover of the device completely into place when opening the device. You could be injured if the cover falls while you are working on the device.

Protect the device against direct sunlight, heat, large temperature fluctuations and moisture. Do not place the device in the vicinity of heaters or air conditioners. Observe the information on temperature and humidity in the technical data.

The device must have sufficient ventilation and may not be covered. Do not put your device in closed cabinets or boxes. Do not place the machine on soft surfaces such as tablecloths or carpets and do not cover the ventilation slits. Otherwise the device could overheat or catch fire.

In the event that the device becomes too hot, or if you see smoke coming from the device, you must immediately pull the power cable out of the power socket. Have your device examined by trained professionals at a technical service location. To prevent the spread of fire, open flames should be kept away from the device.

Do not plug in the device in moist rooms. Never touch the mains cable, the mains connection or the telephone socket with wet hands.

Do not allow liquids to enter into the device. Disconnect the device from the power socket if liquids or foreign objects have entered the device and have your device examined by trained professionals at a technical service location.

Do not allow children to handle the device without supervision. The packing materials should be kept out of the hands of children.

The telephone handset of the device is magnetic. Caution, small metallic objects (paper clips) may be retained if placed near or on the telephone handset.

Power Supply

Check whether the mains voltage of your device (indicated on the type label) matches the mains voltage available at the setup location.

Use only the power and telephone cables supplied.

Set up your device so that the power socket is easily accessible. The device does not have an on/off key. In an emergency, disconnect your device from the power supply by pulling the power plug.

Never touch the power or telephone cable if the insulation is damaged. Replace damaged wires immediately. Use suitable cables only; if necessary please contact our technical customer service or your retailer.

Disconnect your device from the mains and telephone network during an electrical storm in order to avoid electrical surge damage. If this is not possible, do not use the device during an electrical storm.

Before cleaning the surface of your device, disconnect it from the power and telephone networks. Use a soft, lint-free cloth. Never use liquid, gaseous or easily flammable cleansers (sprays, abrasives, polishes, alcohol). Do not allow any moisture to reach the interior of the device.

Only clean the display with a dry, soft cloth. If the display breaks, a mildly corrosive liquid may escape. Avoid all contact with your skin and eyes.

In the event of a power failure, your device will not function; saved data is retained.

Repairs

Should disruptions occur, follow the instructions on the display and on the error report.

Do not make any repairs to the device yourself. Improper maintenance can result in injuries or damage to the device. Only have your device repaired by an authorised service centre.

Do not remove the type label from your device; this would void the warranty.

Consumable Materials

Use only original consumable materials. These are available from a specialised retailer or through our order service (see back side of this user manual). Other consumable materials could damage the device or shorten its service life.

Dispose of old consumable materials according to the waste regulations of your country.

2 Overview

Overview of the Menu Functions

The following functions are available on your device. There are two ways in which you can call functions:

Navigating in the Menu: Press **OK** or one of the two arrow keys **▲/▼**, to open the function menu. Page through **▲/▼** menu entries. Use **OK** to select a menu function. Press **C** to return to the previous menu level. Press **ⓧ** to close the menu and return to the starting mode.

Calling Functions Directly: You can call a menu function directly using the function number. Press **OK** and enter the appropriate function number using the numeric keypad. Confirm with **OK**. You will find the function number in the following list.



Printing the Functions List

Press **i** and **6** to print a list of all functions and settings of your device.

I Telephone Book

- 1 1** Looking up an Entry ... page 12
- 1 2** New Entry ... page 13
- 1 3** Creating Group ... page 14
- 1 4** Short Dial ... page 15
- 1 5** Changing Entries ... page 14
- 1 6** Deleting Entries ... page 14
- 1 7** Printing Entries ... page 30

2 Calls

- 2 1** Calls Received ... page 12
- 2 2** Outgoing Calls ... page 12
- 2 3** Printing Entries ... page 30

3 Fax

- 3 1** Polling ... page 22
- 3 2** Polling Send ... page 22
- 3 3** Sending Fax Later ... page 22
- 3 4** Sending to Multiple Recipients (= Broadcasting) ... page 21
- 3 5** Printing Fax Journal ... page 30
- 3 6** Printing Transmission Report ... page 30
- 3 7** Print reduced in size ... page 29
- 3 8** Reducing Transmission Speed ... page 29

4 Miscellaneous

- 4 1** Printing Call Log ... page 30
- 4 2** Switching notification tone for call waiting on/off (PPF 755) ... page 13
- 4 3** Using Fax Templates ... page 22
- 4 4** Adjust contrast ... page 28
- 4 5** Using Service Codes ... page 37
- 4 6** Checking the Ink Film Reserve ... page 33
- 4 7** Checking the Firmware Version ... page 37
- 4 8** Sudoku ... page 27

5 Fax Switch

- 5 1** Setting the Day Mode ... page 29
- 5 2** Setting the Night Mode ... page 29
- 5 3** Setting the Timer ... page 29
- 5 4** Easylink ... page 32
- 5 5** Setting the Ring Tones ... page 29

6 SMS

- 6 1** Sending SMS ... page 24
- 6 2** Reading SMS Messages ... page 24
- 6 3** Printing SMS Messages ... page 25
- 6 4** Deleting SMS Messages ... page 25
- 6 5** Notification by SMS ... page 24
- 6 6** SMS Access ... page 25

7 Answering Machine

(PPF 755)

- 7 1** Switches answering machine on/off ... page 16
- 7 2** Listening to Messages ... page 17
- 7 3** Recording Internal Memos ... page 19
- 7 4** Setting the Recording Duration ... page 19
- 7 5** Editing the Outgoing Message ... page 16
- 7 6** Using announcement without recording message (= external memo) ... page 16
- 7 7** Forwarding Messages ... page 17
- 7 8** Entering the VIP Code ... page 19
- 7 9** Entering Access Code ... page 17

9 Settings

- 9 1** Entering the Date and Time ... page 28
- 9 2** Selecting the Language ... page 28
- 9 3** Selecting the Country ... page 28
- 9 4** Entering Number ... page 28
- 9 5** Entering Name ... page 28
- 9 6** Configuring Telephone Lines and Services ... page 31

Device Overview

- ❶ Handset
- ❷ Paper tray
- ❸ Document feeder (writing facing up)
- ❹ Panel with display
- ❺  socket—Connection socket for the telephone handset
- ❻ **EXT** socket—Connection socket for additional devices
- ❼ **LINE** socket—Connection socket for telephone cable

- ❶ Scanner glass
- ❷ Rollers of the automatic document feeder
- ❸ Rests of the intake rollers
- ❹ Document guide / scanner film
- ❺ Cover for scanner and automatic document feeder
- ❻ Toothed wheel for tightening the ink film
- ❼ Ink film roll in the rear ink film compartment
- ❸ Ink film roll in the front ink film compartment
- ❹ Slot for the Plug'n'Print card
- ❷ Locks for the cover of the scanner and automatic document feeder

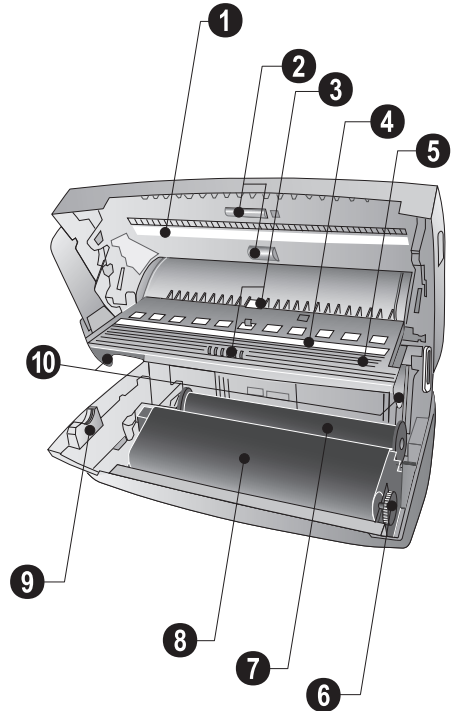
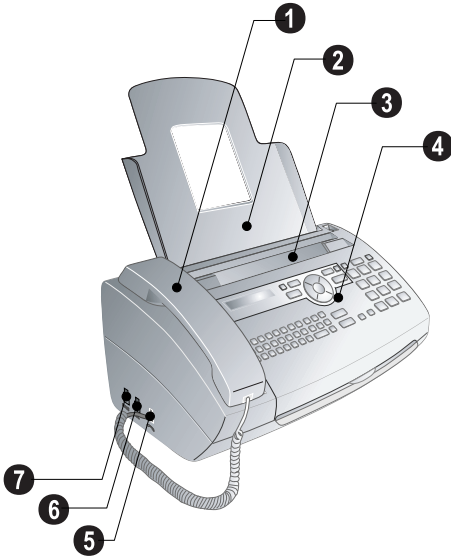

Panel

—Press briefly: Calling up the telephone book entries. Selecting the entries with the ▲/▼ / press and hold: saving new entries

—Setting the timer and the fax reception modes (= fax switch). Modes set on the display * (day), ☾ (night). Activated timer is indicated with

—Calling the SMS menu (function is not supported in all countries and networks)

(PPF 755)—Calling answering machine menu

—Press briefly: Load short dial entries. Selecting the entries with the ▲/▼ or numeric keys / press and hold: Assign a new short dial entry

—Function abort / return to the starting mode / documents eject / (PPF755): ending message playback

C—Return to the previous menu level / press briefly: deleting individual characters / press and hold: deleting complete input / (PPF 755): during a playback: deleting individual message / in the starting mode: deleting all messages

▲/▼—Calling the menu functions / navigation within the menu / selecting options / moving the cursor / adjusting the volume level

OK—Calling the menu functions / confirming input

—Press briefly: Starting transmission of messages / press and hold: Starting fax polling

Letter keypad—Entering characters. Entering capital letters by pressing and holding ↑ key. Deleting using ←. Entering a break using ↵. Entering a space using ␣. Entering special characters by pressing and holding **CTRL** key.

Quick search/entering initial letters with the letter keypad: Enter the initial letters with the letter keypad to quickly navigate through the telephone book.

—Lights up, if new messages are received / list of the new messages with submenus / blinks in the case of device error (for example no ink film)

COPY—Press briefly: creating a copy / press and hold: creating multiple copies / printing SMS

RES—Setting higher resolution for faxes and copying (RESOL. : STANDARD, RESOL. : FINE, RESOL. : PHOTO)

—Press briefly: Printing help pages and setting lists / press and hold: Starting initial installation process

—Press briefly: Toggling between the list of the last 10 dialled numbers (= redial list) / press and hold: List of last ten callers (caller list)

—(PPF 725): Dialling with the handset replaced / (PPF 755): hands-free

R—Press briefly: insert short line interruption (Hook Flash) as office index on PABX or for calling special functions in the public telephone network (PSTN)/long press: Inserting dialling pause

Numeric keypad—Inputting digits, characters and special characters / press and hold: Recalling short dial numbers

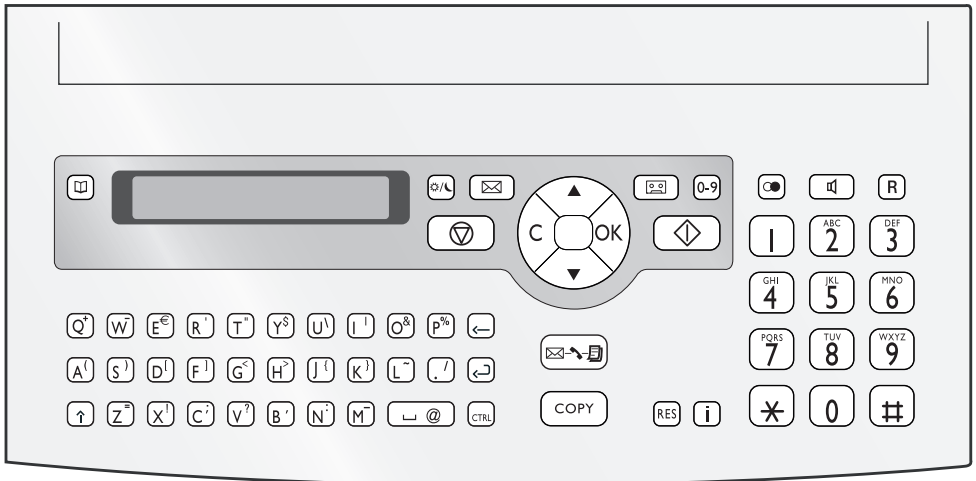

3 Initial Operation

Packing Contents

- ❶ Device
 - ❷ Telephone handset
 - ❸ Spiral cable for telephone handset
 - ❹ Paper tray
 - ❺ Mains cable with plug (country-specific)
 - ❻ Telephone cable with plug (country-specific)
 - ❼ Additional document support
- User manual with installation guide (not depicted)



Missing Package Contents

If any of the parts are missing or damaged, please contact your retailer or our customer service.

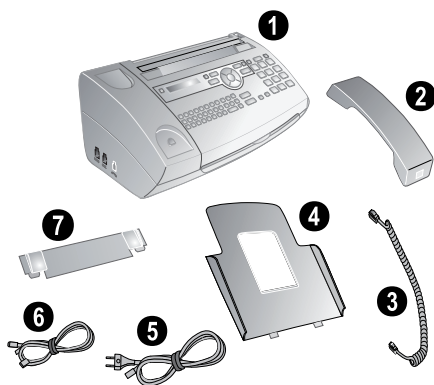

Attaching Paper Tray

Insert the paper tray in the opening provided for it behind the paper feeder.

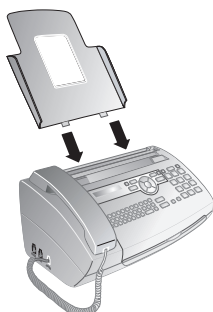

Loading Paper

Before you can receive documents or make copies, you must load paper into the device. Please use only appropriate paper in standard format **A4** (210 × 297 millimetre · preferably 80 g/m²). Follow the specifications in the technical data.



Loading Paper

Separate the paper sheets by fanning them out, then align them by tapping edge of the stack lightly against a flat surface. This will prevent several sheets of paper from being drawn in all at once.

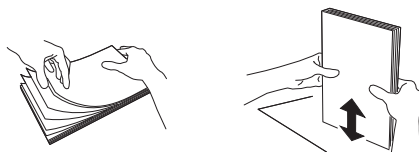

1. Fold open the lever on the right beside the paper feed towards front.
2. Insert paper in the paper feeder. In the paper tray you can insert **maximum 50 sheets (A4 · 80 g/m²)**.
3. Fold open the lever on the right beside the paper feed backward in order to enclose the paper.

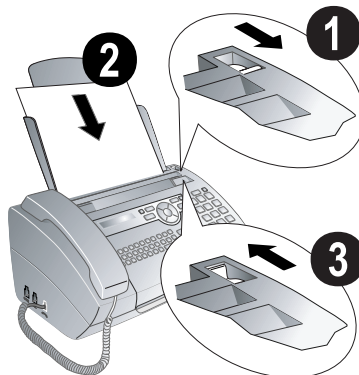

Connecting the Handset

Plug one end of the spiral cable into the socket on the telephone handset. Insert the other end into the socket designated with the ☞ symbol.

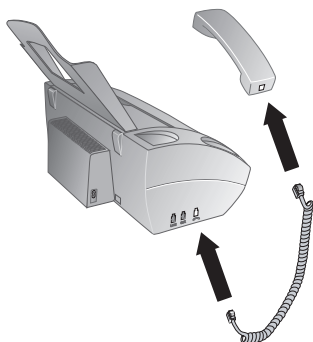

Connecting the Telephone Cable

Analogue Fax Machine

Your device is an analogue fax device (Group 3). It is not an ISDN device (Group 4), and therefore it cannot be operated directly on an ISDN connection. In order to do this, you need either an analogue adapter or a connection for analogue terminals.

Connect the telephone cable to the device by inserting it in the socket designated with **LINE** (RJ-11-Connector). Insert the telephone plug into your PTT line socket.

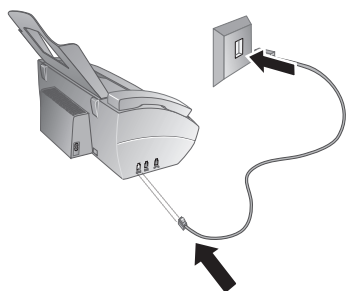

Connection to Private Automatic Branch Exchange

If you connect your device as extension to a telephone system, you must set it for working as an extension (see also chapter *Telephone Lines and Additional Devices*, page 31).

Connecting the Mains Cable

CAUTION!



Mains Voltage at the Site of Installation!

Check whether the mains voltage of your device (indicated on the type label) matches the mains voltage available at the setup location.

Insert the mains cable into the connection located on the rear side of the device. Plug the power cable into the electrical outlet.

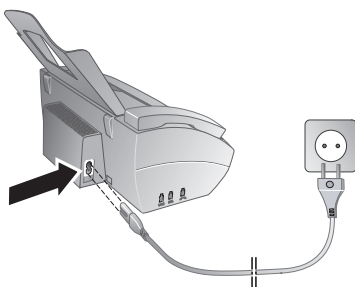

Initial Installation

After you connect your device to the mains voltage, the initial installation commences. Press . Your device prints a help page.

Selecting the Language

1. Use ▲/▼ to select the desired display language.
2. Confirm with **OK**.

Selecting the Country

CAUTION!



Setting the Country Correctly!

You must set the country in which you are operating the device. Otherwise your device is not adapted to the telephone network. If your country is not included in the list, you must select a different setting and use the correct telephone cable for the country. Consult your retailer.

1. Use ▲/▼ to select the country in which you are operating the device.
2. Confirm with **OK**.

After this input, the device prints another help page and checks the telephone line.

Entering Number

Your name and number are added together with date, time and page number at the top edge of each fax transmission (= header).

1. Enter your number. Using **[#]** or **[*]** you can enter a plus sign.
2. Confirm with **OK**.

Entering Name

1. Enter the name using the letter keypad. Enter capital letters by pressing and holding **↑** key. You can delete individual characters using **←**. You can enter space using **␣**. Press **CTRL** and the respective letter key to enter the special character printed above it.



Navigating in the Editor

You can move the cursor using **▲/▼**. Use **C** to delete individual characters.

2. Confirm with **OK**.

Entering the Date and Time

1. Enter the time, e.g. **[1][4][0][0]** for 2 pm.
2. Enter the date (two digits each) e.g. **[0][8][0][6][0][7]** for 8 June 2007.
3. Confirm with **OK**.



Starting Initial Installation Process

You can restart the initial installation process any time. Press **[1]** and **[2]**.

4 Telephone Functions

i **Printing Telephone Book Functions**
Press **1** and **3** to print an overview of the telephone book functions.

For information on how to connect additional telephones and which functions are available to you, please refer the chapter on Telephone Lines and Additional Devices, (see also chapter *Telephone Lines and Additional Devices*, page 31).

Placing a Call on the Device

Dial the desired number. There are several ways to do this: Then pick up the handset.

i **Direct Dialling**
You can also lift up the receiver first, then dial a number. The dialling process begins immediately.

Manual Dialling: Dial the desired number using the numeric keypad.

Telephone Book:

1. Press **□□**.

i **Access Function**
You can also search for an entry in the telephone book by pressing **OK**, **1****1** and **OK**.

2. Select an entry using **▲/▼**. Enter the starting letters with the numeric keypad to quickly navigate through the telephone book.

i **Multiple Categories for One Entry**
You can save an entry multiple times with the same name but in a different category. In the telephone book, the first letter of the category appears after the entry.

Quick search/entering initial letters with the letter keypad: Enter the initial letters with the letter keypad to quickly navigate through the telephone book.

Short Dial: Press **0-9**. Select the desired entry using **▲/▼** or with the numeric keys.

i **Access Function**
You can also load short dial entries by holding the respective number key pressed (for at least two seconds).

Redial List: Press **☉**. Use **▲/▼** to select an entry from the list of the dialled numbers.

i **Access Function**
You can also load the redial list by pressing **OK**, **2****2** and **OK**.

Caller List: Press and hold **☉** (at least two seconds). Use the **▲/▼** to select an entry from the list of callers.

i **Access Function**
You can also load the caller list by pressing **OK**, **2****1** and **OK**.

i **Calling Line Identification (CLIP)**
For this function to work, the Caller Line Identification (CLIP) must be activated for your telephone line (country and network dependent). The number and name will not be shown if the caller suppresses his number.

Calling Additional Telephone Functions

(PPF 755)
(Function is not supported in all countries and networks)

You can use additional telephone functions with your device for example call toggling, three-way call or call forwarding. Contact your telephone company to inquire whether or not these functions are available for your connection. The signal to the switchboard to call these services is a short line interruption (Hook Flash). How to call up the functions, depends on your telephone company and may vary from the description found below.

Making a Second Call

1. During a call, press **R**.
2. Enter the desired number using the numeric keypad or select a saved entry.

Switching Between Calls (= Call Toggling)

Press **R**, to toggle between the calls.

Receiving a Second Call

During a call, you can be informed about another call by a notification tone (= call waiting) if your telephone company offers this service. The notification tone for call waiting on the device is switched off in the factory.

During a call, press **R** to accept the new call.

i **Calling Line Identification (CLIP)**
For this function to work, the Caller Line Identification (CLIP) must be activated for your telephone line (country and network dependent). The number and name will not be shown if the caller suppresses his number.

Switching Notification Tone for Call Waiting On/Off

1. Press **OK**, **[4]** **[2]** and **OK**.
2. Use **▲/▼**, to select whether you would like to turn the call waiting on or off.
3. Confirm with **OK**.

Getting Outside Line

Private branch exchanges (PABX) are typical in many offices and some households. You must dial an outside line access code in order to get a connection to the public telephone network (PSTN) from a PABX.

Enter the outside line access code with which you reach the public telephone network before you enter the desired number or select a stored entry. The outside line access code is usually **[0]**.

Incorrect Outside Line Access Code

In rare cases, the outside line access code may be a different number or a two-digit number. For older telephone systems, the outside line access code can be R (= Flash). Press **R** to enter this outside line access code. If the connection to the public telephone network is not possible, contact your telephone system supplier.

Connection to Private Automatic Branch Exchange

If you operate your device permanently on an extension, save the outside line access code **96** (see also chapter *Configuring Telephone Lines and Services*, page 31).

Chain Dialling

You can combine and edit manually entered digits and saved entries, before the dialling process starts. If you have saved, for example, the telephone number prefix of an inexpensive telephone service provider (call-by-call) as a telephone book entry, select this entry and manually enter the subsequent telephone number or select another saved entry.

Insert Dialling Pause

It may be necessary to insert a dial pause in telephone number, for example, for a direct-inward dialling number, a sub-address or in a long distance number. Hold **R** pressed (for at least two seconds). – appears on the display. The second part of the number is dialled only after a short pause.

Hands-Free

(PPF 755)

1. Press **☎** to dial without lifting up the handset. You will hear a dial tone from the loudspeaker.
2. Enter the desired number using the numeric keypad or select a saved entry. The dialling process begins immediately. At this stage, any numbers that have been incorrectly entered can no longer be changed.

Hands-Free

Put the handset near the device with the microphone facing up in order to achieve an optimum communication.

Recording a Telephone Conversation

(PPF 755)

You can record a telephone conversation. After recording, the **[☎-R]** key flashes, and you can hear the recording like a message on the answering machine.

CAUTION!

 **Recording a Telephone Conversation!**
You must inform your caller when recording a telephone conversation.

1. During a call, press **[☎-R]**. The recording begins.
2. Press **[☎-R]** again to end the recording.

Telephone Book of the Device

In the telephone book of your device, you can save entries with multiple numbers and collect multiple entries into groups. You can assign various ring tones to the entries. Follow the specifications in the technical data.

Navigating in the Editor

You can move the cursor using **▲/▼**. Use **C** to delete individual characters. Press **☑** to close the menu and return to the starting mode.

Saving Entry

1. Hold **[☎]** pressed (for at least two seconds).

Access Function

You can also call the function by pressing **OK**, **[1]** **[2]** and **OK**.

2. Enter the name using the letter keypad. Enter capital letters by pressing and holding **↑** key. You can delete individual characters using **←**. You can enter space using **␣**. Press **CTRL** and the respective letter key to enter the special character printed above it.

Navigating in the Editor

You can move the cursor using **▲/▼**. Use **C** to delete individual characters.

3. Confirm with **OK**.

4. Using ▲/▼, select the category for which you would like to enter a number: CATEGORY: HOME, CATEGORY: WORK, CATEGORY: MOBILE or CATEGORY: FAX.
 5. Confirm with **OK**.
 6. Enter the telephone number.
 7. Confirm with **OK**.
 8. You can assign a ring tone to the number. Use the number keys [0] to [9] to select a ring tone. Using ▲/▼, set the volume.
 9. Confirm with **OK**. The entry is saved.
6. Use ▲/▼ to select the entry you would like to add to the group.
 7. Confirm with **OK**.
 8. Repeat steps 4 to 6 to add additional entries to the group.
 9. Press Ⓞ to end the input.

Edit Entry

1. Press **OK**, [1][5] and **OK**.
2. Using ▲/▼ select the entry which you would like to edit.
3. Confirm with **OK**.
4. Edit the name.
5. Confirm with **OK**.
6. Using ▲/▼, select the category for which you would like to enter a number: CATEGORY: HOME, CATEGORY: WORK, CATEGORY: MOBILE or CATEGORY: FAX.
7. Confirm with **OK**.
8. Enter the telephone number.
9. Confirm with **OK**.
10. You can assign a ring tone to the number. Use the number keys [0] to [9] to select a ring tone. Using ▲/▼, set the volume.
11. Confirm with **OK**. The entry is saved.

Deleting an Entry

1. Press **OK**, [1][6] and **OK**.
2. Using ▲/▼ select the entry which you would like to delete.
3. Confirm with **OK**.
4. Confirm DELETE: YES with **OK**.

Groups

You can combine several telephone book entries into a group. A message is sent to all members of this group in succession.

Adding Group Entries

1. Press **OK**, [1][3] and **OK**.
2. Use ▲/▼ to select the group you would like to create.
3. Confirm with **OK**. You can add entries to the group, display the members of the group, delete the group or send a fax to the group.
4. Select with ▲/▼ ADD MEMBER?.
5. Confirm with **OK**.

Displaying Group Entries

1. Press **OK**, [1][3] and **OK**.
2. Use ▲/▼ to select the group you would like to display.
3. Confirm with **OK**.
4. Select with ▲/▼ VIEW MEMBERS?.
5. Confirm with **OK**.
6. Page through the entries of the group with ▲/▼.
7. Press Ⓞ twice to return to the starting mode.

Deleting Individual or All Group Entries

Deleting an Individual Entry

1. Press **OK**, [1][3] and **OK**.
2. Using ▲/▼ select the group from which you would like to delete entries.
3. Confirm with **OK**.
4. Select with ▲/▼ DELETE MEMBER?.
5. Confirm with **OK**.
6. Using ▲/▼ select the entry which you would like to delete.
7. Confirm with **OK**.
8. Select with ▲/▼ DELETE: YES.
9. Confirm with **OK**. The entry is deleted.

Deleting a Group

1. Press **OK**, [1][3] and **OK**.
2. Using ▲/▼ select the group you would like to delete.
3. Confirm with **OK**.
4. Select with ▲/▼ DELETE MEMBER?.
5. Confirm with **OK**.
6. Select with ▲/▼ DELETE: ALL.
7. Confirm with **OK**. All entries in the group are deleted.

Short Dial

(model dependent)

You can assign short dial numbers to frequently dialed telephone numbers. You can load these numbers quickly with the short dial key and the number keys.

Assigning or Editing Short Dial Entry

1. Hold **[0-9]** pressed (for at least two seconds).



Access Function

You can also call the function by pressing **OK**, **[1]****[4]** and **OK**.

2. Use **▲/▼** or the respective number key to select the short dial number you would like to assign or change.

CAUTION!



Overwriting Short Dial Entries!

If you select a short dial number that is already assigned, the entry is overwritten.

3. Confirm with **OK**.
4. Use **▲/▼** to select the telephone book entry you would like to assign as a short dial entry.
5. Confirm with **OK**.

Deleting a Short Dial Entry

CAUTION!



The Telephone Book Entry is Deleted!

This function not only deletes the short dial entry, it also deletes the entire entry from the telephone book. Overwrite the short dial entry if you would like to change the assignment.

1. Press **[0-9]**.



Access Function

You can also call the function by pressing **OK**, **[1]****[4]** and **OK**.

2. Use **▲/▼** or the respective number key to select the entry you would like to delete.
3. Press **C**.
4. Confirm the deletion with **OK**.

Calling Line Identification (CLIP)

(Function is not supported in all countries and networks)

The number of an incoming call appears on the display. For this function to work, the Calling Line Identification Presentation (CLIP) must be activated for your telephone line. Enquire with your telephone company. Caller Line Identification may be associated with a fee.



Setting the Country Correctly

If the Caller Line Identification does not work even though the function is activated for your telephone line, check if you have set the correct country (see also chapter *Selecting the Country*, page 28).

Missed Calls

If you received a call while away, the **[☒-☒]** - key flashes.

1. Press **[☒-☒]**.
2. Using **▲/▼**, you can page through the list of missed calls.



Additional Messages

If you have received additional messages, first select the missed calls using **▲/▼** and confirm with **OK**.

3. To call back, pick up the handset.



Displaying Telephone Book Names

Your device displays the name with which you have saved the number in the telephone book. The number and name will not be shown if the caller suppresses his number.

5 Answering Machine

(model dependent)

-  **Printing Answering Machine Functions**
Press **[1]** and **[3]** to print an overview of the answering machine functions.

Switching On and Off

-  **Using Anonymous Outgoing Messages**
If you do not record a personal announcement, the answering machine uses the anonymous announcement set by the factory.



Press **[2]** three times to turn the answering machine on or off. If the answering machine is turned on, the symbol  appears on the display.

-  **Access Function**
You can also call the function by pressing **OK**, **[7]** **[1]** and **OK**.

Editing the Outgoing Message

-  **Recording the Outgoing Message**
During playback, press **C** and **OK** in order to delete the currently playing outgoing message. Using **▲/▼**, set the volume. Stop the playback with **⏏**.

Recording the Outgoing Message

- Press **[2]**.
 - Select with **▲/▼** **OUTGOING MSG.**.
 - Confirm with **OK**.
-  **Access Function**
You can also call the function by pressing **OK**, **[7]** **[5]** and **OK**.
- Select with **▲/▼** **MESSAGE: RECORD**.
 - Confirm with **OK**.
 - Press **OK** to record an outgoing message. Wait for the confirmation tone before you say your text.
-  **Length of Outgoing Message**
The outgoing message must be longer than ten seconds and shorter than twenty seconds.
- Press **OK** to end the recording. The recording is played back.
-  **Recording the Outgoing Message**
If the volume of the outgoing message is too low, rerecord the same. For recording, lift up the telephone handset of the device and speak the text into the microphone.

Playing Back the Outgoing Message

- Press **[2]**.
 - Select with **▲/▼** **OUTGOING MSG.**.
 - Confirm with **OK**.
-  **Access Function**
You can also call the function by pressing **OK**, **[7]** **[5]** and **OK**.
- Select with **▲/▼** **MESSAGE: PLAY**.
 - Confirm with **OK**. The outgoing message is played back.



Using Anonymous Outgoing Messages

You can replace your personal outgoing message with the factory default anonymous message.

- Press **[2]**.
 - Select with **▲/▼** **OUTGOING MSG.**.
 - Confirm with **OK**.
-  **Access Function**
You can also call the function by pressing **OK**, **[7]** **[5]** and **OK**.
- Select with **▲/▼** **MESSAGE: DEFAULT**.
 - Confirm with **OK**. The outgoing message is played back.

Using Announcement without Recording Message

You can record an outgoing message which the caller hears for which no message can be recorded in reply (= external memo).

- Press **[2]**.
 - Use **▲/▼** to select **EXTERN. MEMO**.
 - Confirm with **OK**.
-  **Access Function**
You can also call the function by pressing **OK**, **[7]** **[6]** and **OK**.
- Use **▲/▼** to select whether you would like the outgoing message to be switched on/off without recording the message.
 - Confirm with **OK**.
-  **Overwriting Existing Outgoing Message**
When you record an outgoing message, you are asked, if you would like to use the old outgoing message or would like to record a new one. Confirm with **OK**.

6. **Recording a New Outgoing Message:** Press **OK** to record an outgoing message. Wait for the confirmation tone before you say your text.



Length of Outgoing Message

The outgoing message must be longer than ten seconds.

7. Press **OK** to end the recording. The recording is played back.

Listening to Messages



Listening to Messages

Press **[#]** to play the next message. With the number keys, you can load the desired message directly. During playback, press **C** and **OK** in order to delete the currently playing outgoing message. Using **▲/▼**, set the volume. Stop the playback with **⏻**.

Listening to New Messages

If new messages have been received on the answering machine, the **[📞]** key blinks. The number of the new messages is shown on the display.

1. Press **[📞]**.
2. Confirm with **OK**.
3. The new messages are played back.

Playing Messages again

1. Press **[📞]**.
2. Select with **▲/▼** MESSAGES.
3. Confirm with **OK**.



Access Function

You can also call the function by pressing **OK**, **[7]****[2]** and **OK**.

4. Select with **▲/▼** MESSAGE: PLAY.
5. Confirm with **OK**. The messages are played back.

Deleting Messages

Deleting Individual Message

During playback, press **C** and **OK** in order to delete the currently playing outgoing message.

Deleting Messages already Played



Deleting New Messages

Messages not yet heard must be heard first before deleting them.

1. Press **[📞]**.
2. Select with **▲/▼** MESSAGES.
3. Confirm with **OK**.



Access Function

You can also call the function by pressing **OK**, **[7]****[2]** and **OK**.

4. Select with **▲/▼** MESSAGE: DELETE.
5. Confirm with **OK**. The heard messages are deleted.



Deleting Heard Messages

You can also delete the already heard messages by pressing **C** and **OK** in the starting mode.

Setting up Forwarding and Remote Access

Entering Access Code

You must enter an access code to be able to receive transferred messages, or listen to and control your answering machine from other telephones.



Remote Control On/Off

The remote control is switched off with the factory-installed access code (0000). Change the access code to switch on the remote control. If you want to switch the remote control off enter the factory-installed code (0000) again.

1. Press **[📞]**.
2. Select with **▲/▼** ACCESS CODE.
3. Confirm with **OK**.



Access Function

You can also call the function by pressing **OK**, **[7]****[9]** and **OK**.

4. Enter a four-digit code.

CAUTION!



No Identically PIN Codes!

The access code may not be identical to the VIP code.

5. Confirm with **OK**.

Forwarding Messages

The device forwards messages to a specified telephone number. Once the configured number of messages is reached, the device calls the number. If the call is answered, a greeting text is played. Then the person on the line must enter the access code. If no code is entered or an incorrect code is entered three times, the device hangs up.

1. Press **[📞]**.
2. Select with **▲/▼** FORWARDING.
3. Confirm with **OK**.



Access Function

You can also call the function by pressing **OK**, **[7]****[7]** and **OK**.

4. Use **▲/▼** to select whether you would like to switch forwarding on or off.
5. Confirm with **OK**.
6. Enter the number to which the received messages should be forwarded.
7. Confirm with **OK**.

8. Use ▲/▼ to select how many messages should be collected and forwarded together.
 9. Confirm with **OK**.
-  **Overwriting Existing Outgoing Message**
- When you record a message, you are asked, if you would like to use the old message or would like to record a new one. Confirm with **OK**.
10. **Recording a new outgoing message:** Press **OK** to record an outgoing message. Wait for the confirmation tone before you say your text.
 11. Press **OK** to end the recording. The recording is played back.

Using Remote Access

You can hear and delete new messages, record a new outgoing message or switch answering machine on or off with a telephone call.

 **Tone Dialling**

The telephone on this connection must be set to tone dialling. Press a key within 50 seconds, otherwise the connection is cut-off (country and network dependent).

1. Call your number.
2. Wait, until the answering machine switches on and plays the outgoing message.
3. Enter the access code.
4. The device interrupts the outgoing message and plays new messages. If no new messages have been received, you will hear two confirmation tones.

 **Conserving Function of Fax Reception Mode**

If you select the 5/2 option for the number of rings of the answering machine, the answering machine switches on after two rings, when you have received new messages. If there are no new messages, the device rings five times. If the device does not pick up after two rings, you have no new messages. You can terminate the remote access without incurring any telephone costs.

5. The functions listed below are available using the numeric keys.
6. Hang up to end the remote access.

Remote Control Functions

 **Aborting Current Function**

Occasionally the answering machine might not react to your entry—for example while you are listening to a message. Cancel the current function by pressing **6**. Select the next function with the appropriate number key.

Listening to Messages

- Hearing Current Message Again:** Press **1**.
- Listening to All Messages:** Press **2**.
- Listening to Next Message:** Press **3**.

Deleting Messages

- To Delete the Current Message:** Press **6** while listening to the message.
- Deleting All Messages:** Press **6** after listening to all the messages.
- Press **6** again within five seconds to confirm the deletion.

Outgoing Message

- Listening to the Outgoing Message** Press **5**.
- Recording a New Outgoing Message:**

1. Press **4**.
2. Wait for the confirmation tones.
3. Press **4**.
4. Wait for the long confirmation tone before beginning with the text.
5. Press **4** to end the recording.

Control Functions

- Aborting Last Function:** Press **8**.
- Switching Off Answering Machine** Press **7**.
- Switching On Answering Machine** Press **9**.

 **Conserving Function of Fax Reception Mode**

If the answering machine is switched off you have to enter the access code while the fax switch analyzing the incoming signal. After the 4th ring the tone heard changes (factory settings of the number of rings for fax switch) (see also chapter *Setting the Fax Switch*, page 29). Press **9**, to activate the answering machine. Afterwards you can call additional functions.

Recording Internal Memos

You can record voice messages (= memos), which can be played as messages. The limit on duration of recording set for messages applies even to the recording duration of memos.

Recording Length for Memos

The configured recording length for incoming messages also limits the length of the internal memos.

1. Press **[29]**.
2. Use **▲/▼** to select **QUICK NOTE**.
3. Confirm with **OK**.

Access Function

You can also call the function by pressing **OK**, **[7][3]** and **OK**.

4. Press **OK** to record a voice message. Wait for the confirmation tone before you say your text.
5. Press **OK** to end the recording. The recording is played back. After that the **[☒][9]** key starts flashing. The voice message is displayed as a new message.

Modifying the Settings

Entering the VIP Code

If callers enter the VIP code, the device continues to ring, even if the answering machine has taken over the call. With this function, certain persons can reach you even if you have set the number of rings to zero.

CAUTION!



No Identically PIN Codes!

The VIP code may not be identical to the access code for remote control.

1. Press **[29]**.
2. Select with **▲/▼** **VIP CODE**.
3. Confirm with **OK**.

Access Function

You can also call the function by pressing **OK**, **[7][8]** and **OK**.

4. Enter a four-digit code.
5. Confirm with **OK**.

Setting the Recording Duration

You can limit the length of the incoming messages and internal memos.

1. Press **[29]**.
2. Select with **▲/▼** **RECORD. TIME**.
3. Confirm with **OK**.



Access Function

You can also call the function by pressing **OK**, **[7][4]** and **OK**.

4. Use **▲/▼** to select the desired recording length or unlimited time (automatic).
5. Confirm with **OK**.

6 Fax



Printing Informations for Fax Transmission

Press **1** and **4** to print instructions for sending fax messages and for configuring the fax switch.

CAUTION!



Unsuitable Documents!

Do not insert any documents into the device that ...

... are wet, have been edited with correction fluid, are soiled or have a coated surface.

... that are written on with a soft pencil, with paint, chalk or charcoal.

... originate from newspapers or magazines (printing ink).

... that are held together with office or notebook staples or with tape or glue.

... are pasted with note papers.

... are creased, crumpled or torn.

Use documents with sizes **A5** or **A4** with 60 to 100 g/m² weight. You can insert **up to ten documents** at a time.



Cancel Transmission

Press **⏏** to eject the documents without sending them.

Sending a Fax

1. Insert the additional document support on the document feeder.

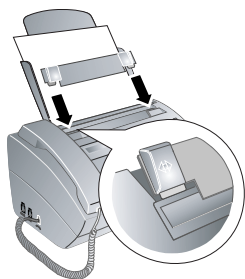

2. Insert the documents face up into the document feeder. The top most document will be fed in first.

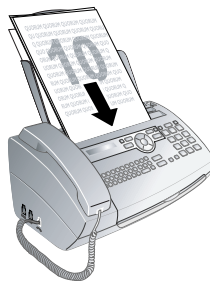

3. Set the desired resolution. You can choose between **RESOL. : STANDARD** (for documents without special features), **RESOL. : FINE** (for texts with small print or drawings) and **RESOL. : PHOTO** (for photos). Press **RES**. The configured resolution appears on the display. Press **RES** again to change the resolution.



Adjust contrast

You can adjust the preset contrast (see also chapter *Adjust contrast*, page 28).

4. Dial the desired number. There are several ways to do this:
5. Press **⏏**.



Automatic Redial

If the subscriber is busy, the device dials the number again after some time. Press **⏏**, in order to cancel the transmission process. After the transmission, the device prints out a transmission report depending on the settings.

Manual Dialling: Dial the desired number using the numeric keypad.

Telephone Book:

1. Press **☐**.



Access Function

You can also search for an entry in the telephone book by pressing **OK**, **1****1** and **OK**.

2. Select an entry using **▲/▼**. Enter the starting letters with the numeric keypad to quickly navigate through the telephone book.



Multiple Categories for One Entry

You can save an entry multiple times with the same name but in a different category. In the telephone book, the first letter of the category appears after the entry.

Quick search/entering initial letters with the letter keypad: Enter the initial letters with the letter keypad to quickly navigate through the telephone book.

Short Dial: Press [0-9]. Select the desired entry using ▲/▼ or with the numeric keys.



Access Function

You can also load short dial entries by holding the respective number key pressed (for at least two seconds).

Redial List: Press **OK**. Use ▲/▼ to select an entry from the list of the dialled numbers.



Access Function

You can also load the redial list by pressing **OK**, [2] [2] and **OK**.

Caller List: Press and hold **OK** (at least two seconds). Use the ▲/▼ to select an entry from the list of callers.



Access Function

You can also load the caller list by pressing **OK**, [2] [1] and **OK**.



Calling Line Identification (CLIP)

For this function to work, the Caller Line Identification (CLIP) must be activated for your telephone line (country and network dependent). The number and name will not be shown if the caller suppresses his number.

Sending Fax Manually

1. Insert the document.
2. Enter the desired number using the numeric keypad or select a saved entry.
3. Press **OK**.
4. Press **OK**.

Direct Inward Dialling or Selecting Sub-address

You can send a fax to a direct-inward dialling number or a sub address or call from a direct-inward dialling number or sub address - for example to use a certain service of a fax database provider. For this purpose, attach the direct-inward dialling number or sub address with a short dialling pause to the fax number.

1. Enter the desired number using the numeric keypad or select a saved entry.
2. Hold **R** pressed (for at least two seconds).
3. Enter the direct-inward dialling number or sub address.
4. Press **OK**. The direct-inward dialling number or sub address is dialled only after a short pause.

Eavesdropping while Connection is Established

(PPF 725)

You can listen while a connection is established, for example if a fax transmission constantly fails.

Enter the desired number using the numeric keypad or select a saved entry. Press **OK**.



No Hands-free Operation Possible

Hands-free operation is not possible with this function. You cannot answer if the subscriber picks up.

Sending to Multiple Recipients (= Broadcasting)

You can send one fax to multiple recipients in succession.

Entering Recipients Individually

1. Insert the document.
2. Press **OK**, [3] [4] and **OK**. The document is now read.
3. Enter the desired number using the numeric keypad or select a saved entry.
4. Confirm with **OK**.
5. Enter the next telephone numbers.
6. Confirm with **OK**. You can enter up to 25 recipients.
7. Press **OK**. The device transmits the fax message successively to all recipients.

Sending a Fax to a Group

1. Insert the document.
2. Press **OK**, [1] [3] and **OK**.
3. Use ▲/▼ to select the group to which you would like to send a fax.
4. Confirm with **OK**.
5. Select with ▲/▼ **SEND FAX?**.
6. Confirm with **OK**.



Transmission to Multiple Recipients

If your device cannot reach a recipient, the fax message is sent to the other recipients. After the device has called all recipients, it once again dials the numbers that previously could not be reached.

Sending Fax Later

If you would like to make use of the lower telephone tariffs or if the recipient can be reached at some specific time only, you can send the fax at a later time—within 24 hours.

1. Insert the document.
2. Press **OK**, **[3][3]** and **OK**.
3. Enter the time, at which the document should be transmitted, e.g. **[1][4][0][0]** for 2 pm.
4. Confirm with **OK**.
5. Enter the desired number using the numeric keypad or select a saved entry.
6. **Selecting a Saved Entry:** Confirm the selected entry using **OK**.
7. Press **◇**. The device goes into standby mode and transmits the fax at the entered time. You can continue to make telephone calls and receive faxes



Cancel a Scheduled Fax Transmission

Press **⏏** to eject the document. This interrupts the standby mode.

Fax Reception

If you have not changed the factory settings, received faxes will be printed out automatically. If no paper or no ink film is inserted, the device saves the incoming faxes. The **[Fax/Print]** key blinks. Once paper or a new ink film is inserted, the saved faxes are printed out.



Paper Not Inserted Correctly

Check if you have inserted clamped paper correctly. The lever on the right hand side next to the paper feeder must be folded backwards.

If the message memory is full, no additional messages can be received. A warning appears on the display. Follow the specifications in the technical data.



Delete Fax Messages Sent

If there are problems with printing out saved fax messages, a service code is available (see also chapter *Using Service Codes*, page 37).

Receiving Fax Manually

Select manual reception under number of rings of the fax switch (see also chapter *Setting the Fax Switch*, page 29). The device will not receive faxes on its own. This setting is useful, when you want to receive faxes via a modem connected to a computer.

You can start fax reception manually, by pressing **◇**.

Polling Faxes

With the fax polling function, you can retrieve faxes that lie ready in the dialled device. You can keep a document ready in your device, which can be polled by others.

Polling Faxes Directly

1. Enter the desired number using the numeric keypad or select a saved entry.
2. Hold **◇** pressed (for at least two seconds).

Polling Secure Faxes

With this function, you can poll faxes that are protected with a code.

1. Press **OK**, **[3][1]** and **OK**.
2. Enter the code.
3. Confirm with **OK**.
4. Enter the desired number using the numeric keypad or select a saved entry.
5. Press **◇**.

Polling Send of Faxes

CAUTION!



Unauthorised Fax Polling!

Protect your document against unauthorised polling with a code.

A caller who knows the code can poll the fax from your device. You can continue to make telephone calls and receive faxes

1. Insert the document.
2. Press **OK**, **[3][2]** and **OK**.
3. Enter a code (max. 20 characters).
4. Confirm with **OK**.



Cancel a Scheduled Fax Transmission

Press **⏏** to eject the document. This interrupts the standby mode.

Using Fax Templates

Five fax templates, which you can use, are stored in your device. With these templates you can quickly create, for example, a short fax note or an invitation.

1. Press **OK**, **[4][3]** and **OK**.
2. Use **▲/▼** to select the template you would like to print.
3. Confirm with **OK**. The device prints the template.
4. Fill the template and send it to the desired recipient per fax.

7 Copier



Printing Informations for Copying

Press **i** and **5** to print the help for copying.

Use documents with sizes **A5** or **A4** with 60 to 100 g/m² weight. You can insert **up to ten documents** at a time.

Inserting Documents

1. Insert the additional document support on the document feeder.

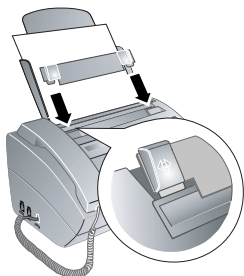

2. Insert the documents face up into the document feeder. The top most document will be fed in first.

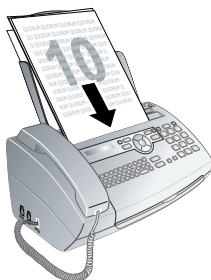

3. Set the desired resolution. You can choose between **RESOL. : STANDARD** (for documents without special features), **RESOL. : FINE** (for texts with small print or drawings) and **RESOL. : PHOTO** (for photos). Press **RES**. The configured resolution appears on the display. Press **RES** again to change the resolution.



Adjust contrast

You can adjust the preset contrast (see also chapter *Adjust contrast*, page 28).

Making a Copy

Press **COPY** briefly. The copy is created.

Creating Multiple Copies

1. Hold **COPY** pressed (for at least two seconds).
2. Enter the number of times you would like to copy the document (maximum of 15 copies).
3. Press **COPY**.
4. Using **▲/▼** select whether to reduce or enlarge the document in size when copying. You can magnify up to 200 percent or reduce to as small as 50 percent of the original size.
5. Confirm with **OK**. The copy is created.



Cancel Copying

Press **⏏** to eject the documents without copying them.

8 SMS

(model dependent)

(Function is not supported in all countries and networks)

-  **Printing Instructions for SMS Functions**
Press **[1]** and **[8]** to print the instructions for SMS functions.

SMS Requirements

Your device is preset for using the SMS (Short Messaging Service) services. Caller Line Identification (CLIP) must be activated for the SMS to work. It is possible that you will not be able to send and receive SMS messages from a private branch exchange (depending on the country and network).

-  **SMS with Secret Number**
Should you face problems in sending SMS, the reason for the same could be that you are using a secret number or that the device is connected to an old ISDN System.

-  **SMS Requirements**
Ask your telephone service provider ...
... whether you must register for the SMS Service.
... to which mobile telephone service providers you can send SMS
... which costs are applicable.
... which functions are available.

Sending SMS

- Press **[✉]**.
- Confirm with **OK**.
 **Access Function**
You can also call the function by pressing **OK**, **[6]** **[1]** and **OK**.

-  **SMS Templates**
The last five SMS messages written remain saved as templates. Press **[C]** until the desired message appears.

- Enter the text using the letter keypad. Enter capital letters by pressing and holding **↑** key. You can delete individual characters using **←**. You can enter space using **[]**. You can enter a line break using **↵**. Press **CTRL** and the respective letter key to enter the special character printed above it.

You can enter 160 characters.

-  **Navigating and Printing**
You can move the cursor using **▲/▼**. Use **C** to delete individual characters. Press and hold **C** (at least two seconds) to delete the entire text. Press **COPY** to print the message before sending it.

- Confirm with **OK**.

- Enter the desired number using the numeric keypad or select a saved entry.

-  **Sending to Multiple Recipients (= Broadcasting)**
You can send an SMS message to up to five recipients. Press **OK** after entering the number.

- Press **[✉]**. The message is sent.

Notification by SMS

You can have an SMS message sent to a telephone number of your choice when faxes or SMS messages are received or the answering machine receives calls or voice messages in your absence.

- Press **OK**, **[6]** **[5]** and **OK**.
- Use **▲/▼** to select whether you would like to be informed about new SMS messages.
- Confirm with **OK**.
- Use **▲/▼** to select whether you would like to be informed about calls in your absence.
- Confirm with **OK**.
- Use **▲/▼** to select whether you would like to be informed about new fax messages.
- Confirm with **OK**.
- Use **▲/▼** to select whether you would like to be informed about new messages on the answering machine.
- Confirm with **OK**.
- Enter the number to which the SMS should be sent.
- Confirm with **OK**. A message appears on the display stating the notification by SMS is activated.

Receiving SMS Messages

-  **Paper Not Inserted Correctly**
Check if you have inserted clamped paper correctly. The lever on the right hand side next to the paper feeder must be folded backwards.

Received SMS messages are printed out automatically. If you have turned the automatic printing function off, the SMS messages will be stored. Your device can store up to 30 SMSs.

Reading SMS Messages

After reception of a new SMS message, the **[✉]** **[☰]** key lights up.

- Press **[✉]** **[☰]**.
- Select the SMS using **▲/▼**.
- Press **[✉]** **[☰]**. The Read SMS menu opens.

Loading Previously Read SMS Messages

1. Press **OK**, **[6][2]** and **OK**.
2. Using **▲/▼** select the SMS that you would like to read. Unread SMS messages are marked with a *.
3. Confirm with **OK**.



Navigating and Printing

You can move the cursor using **▲/▼**. Press **COPY** to print the SMS message.

4. Press **⊙** to return to the SMS list.



Calling Further SMS Functions

Press **OK** to call additional SMS functions.

Calling SMS Functions

1. While reading an SMS message, press **OK** to load additional SMS functions.
2. Use **▲/▼** to select an option: You can display information about the SMS message, print or delete the message, forward the message to another recipient or send an SMS response. You can return to the list of SMS messages, or view the next or previous SMS message.
3. Confirm with **OK**.

Printing SMS Messages

1. Press **OK**, **[6][3]** and **OK**.
2. Using **▲/▼** select the SMS message you would like to print.

PRINT: ALL—Prints all received and composed SMS messages that you have saved

PRINT: INBOX—Prints all received SMS messages

PRINT: OUTBOX—Prints all sent SMS messages that you have saved

PRINT: NEW—Prints all unread SMS messages

3. Confirm with **OK**.



Printing an Individual SMS message

If you would like to print an individual SMS message, load the message. Press **COPY** to print the message.

Deleting SMS Messages

If the message memory is full, the device cannot receive any more messages. Delete SMS messages to free up memory.

1. Press **OK**, **[6][4]** and **OK**.
2. Use **▲/▼** to select the SMS messages you would like to delete:

DELETE: ALL SMS—Deletes all received and composed SMS messages that you have saved

DELETE: READ SMS—Deletes all read SMS messages

DELETE: SENT SMS—Deletes all sent SMS messages that you have saved

3. Confirm with **OK**.
4. Confirm the deletion with **OK**.



Deleting Single SMS Message

If you would like to delete an individual SMS message, load the message. Press **OK**, and using **▲/▼** select **DELETE**. Confirm with **OK**.

Modifying the Settings

Changing Transmitting and Receiving Numbers

All numbers that you need to send and receive SMSs are stored in your device. In case you moved to another telephone service provider, you must change these numbers. You can set your device for two SMS service providers.

1. Press **OK**, **[6][6]** and **OK**.
2. Use **▲/▼** to select the SMS service provider that you would like to set.
3. Confirm with **OK**.
4. Enter the number for sending SMSs.
5. Confirm with **OK**.
6. Enter the number for receiving SMSs.
7. Confirm with **OK**.
8. Use **▲/▼** to select the SMS service provider through which you would like to send SMSs.
9. Confirm with **OK**.



Receiving SMS Messages

You can receive SMS messages via both providers.

Turning Off the Automatic Printing

You can deactivate the automatic printing of SMS messages.

1. Press **OK**, **6** **6** then **OK** repeatedly until **PRINT SMS: YES** appears on the display.
2. Using **▲/▼** indicate whether you would like to turn printing on or off.
3. Confirm with **OK**.

Switching SMS Reception On and Off

If you are using a cordless telephone with SMS function on the same telephone line, then the specific device at which you will receive an SMS message will depend on the specific manufacturer. Only one of the devices will receive the SMS message. Try to turn off the SMS reception on your cordless telephone. If this is not possible, switch off SMS reception on the device. You can continue to send SMS messages even while SMS reception is switched off.

Switching SMS Reception Off

1. Press **OK**, **4** **5** and **OK**.
2. Enter the service code **3** **1** **2** **0** **7**.
3. Confirm with **OK**.
4. Select with **▲/▼** **SURE: YES**.
5. Confirm with **OK**.



Cancelling Entry

If you have entered the incorrect code, you can cancel the entry with **SURE: NO**.

Switching SMS Reception On

1. Press **OK**, **4** **5** and **OK**.
2. Enter the service code **4** **1** **2** **0** **6**.
3. Confirm with **OK**.
4. Select with **▲/▼** **SURE: YES**.
5. Confirm with **OK**.



Cancelling Entry

If you have entered the incorrect code, you can cancel the entry with **SURE: NO**.

9 Fun and Games



Printing informations for the Games and Fun functions

Press **[1]** and **[7]** to print the instructions for the Games and Fun functions of your device.

Sudoku

Sudoku is a Japanese number puzzle. The game has 3×3 squares divided into 3×3 fields. Depending on the difficulty level, lesser or more digits are already given at the beginning of the game. The aim of the game is to fill digits from 1 to 9 in the game field in such a way that each digit appears only once in a row, a column and each of the nine blocks. There is only one solution.



Last Solution Available

The solution of the last printed game is saved. The solutions of earlier games are no longer available.

Printing a Game

1. Press **OK**, **[4]** **[8]** and **OK**.
2. Select with **▲/▼** SUDOKU: NEW
3. Confirm with **OK**.
4. Using **▲/▼** select the difficulty level.
5. Confirm with **OK**.
6. Enter, how many copies of the Sudoku you would like to print (maximum 9 copies).
7. Confirm with **OK**.
8. Using **▲/▼** select if you would like to print the solution.
9. Confirm with **OK**.

Printing the Last Game Again

1. Press **OK**, **[4]** **[8]** and **OK**.
2. Select with **▲/▼** SUDOKU: LAST.
3. Confirm with **OK**.
4. Enter, how many copies of the Sudoku you would like to print (maximum 9 copies).
5. Confirm with **OK**.
6. Using **▲/▼** select if you would like to print the solution.
7. Confirm with **OK**.

Printing the Solution

1. Press **OK**, **[4]** **[8]** and **OK**.
2. Select with **▲/▼** SUDOKU: SOLUTION.
3. Confirm with **OK**.

Sudoku for Every Day

You can have a new Sudoku automatically printed each day.

1. Press **OK**, **[4]** **[8]** and **OK**.
2. Select with **▲/▼** SUDOKU: AUTO.
3. Confirm with **OK**.
4. Enter the time, e.g. **[1]** **[4]** **[0]** **[0]** for 2 pm.
5. Confirm with **OK**.
6. Using **▲/▼** select the difficulty level.
7. Confirm with **OK**.
8. Enter, how many copies of the Sudoku you would like to print (maximum 9 copies).
9. Confirm with **OK**.
10. Using **▲/▼** select if you would like to print the solution.
11. Confirm with **OK**.
12. Using **▲/▼** indicate whether you would like to turn printing on or off.
13. Confirm with **OK**.



Switching Off Function

You can turn off the daily Sudoku print by selecting the function as described above and by switching off the automatic printing under point 12.

10 Settings



Navigating in the Editor

You can move the cursor using ▲/▼. Use **C** to delete individual characters. Press **⏏** to close the menu and return to the starting mode.

Entering the Date and Time

1. Press **OK**, **[9][1]** and **OK**.
2. Enter the time, e.g. **[1][4][0][0]** for 2 pm.
3. Enter the date (two digits each) e.g. **[0][8][0][6][2][7]** for 08.06.27.
4. Confirm with **OK**.



Time and Date After a Short Power Failure

You must check the time and date after a short power failure. Confirm with **OK**.

Selecting the Language

1. Press **OK**, **[9][2]** and **OK**.
2. Use ▲/▼ to select the desired display language.
3. Confirm with **OK**.

Selecting the Country

CAUTION!



Setting the Country Correctly!

You must set the country in which you are operating the device. Otherwise your device is not adapted to the telephone network. If your country is not included in the list, you must select a different setting and use the correct telephone cable for the country. Consult your retailer.

CAUTION!



Settings will be Deleted!

When you select a new country, all settings are reset to the factory defaults for that country. Saved data remains intact. Check the number entered for the header.

1. Press **OK**, **[9][3]** and **OK**.
2. Use ▲/▼ to select the country in which you are operating the device.
3. Confirm with **OK**.
4. Select with ▲/▼ **SURE: YES**.
5. Confirm with **OK**.

Entering Number

Your name and number are added together with date, time and page number at the top edge of each fax transmission (= header).

1. Press **OK**, **[9][4]** and **OK**.
2. Enter your number. Using **[#]** or **[*]** you can enter a plus sign.
3. Confirm with **OK**.

Entering Name

1. Press **OK**, **[9][5]** and **OK**.
2. Enter the name using the letter keypad. Enter capital letters by pressing and holding **↑** key. You can delete individual characters using **←**. You can enter space using **␣**. Press **CTRL** and the respective letter key to enter the special character printed above it.



Navigating in the Editor

You can move the cursor using ▲/▼. Use **C** to delete individual characters.

3. Confirm with **OK**.

Adjust contrast

For copying and printing of fax messages, you can select different contrast levels.

1. Press **OK**, **[4][4]** and **OK**.
2. Using ▲/▼, select the desired contrast:
 - CONTR.:LIGHT** For brighter copies and fax transmission
 - CONTR.:NEUTRAL**—For all types of originals (for example white text on black background or documents with coloured background)
 - CONTR.:OPTIMISED** (Factory settings)—Optimized adaptation for text and photo printing
 - CONTR.:DARK** For darker copies and fax transmission (for example documents with faint printing)
3. Confirm with **OK**.



Modifying the Basic Settings

The changed settings are stored as new default settings. If you select a special function for a one-time process, take care to restore the default settings or factory settings after that.

Reducing Transmission Speed

The device adapts the transmission speed to the line quality. This may take some time, especially for overseas connections. Set a lower transmission speed if you are sending faxes into networks with poor line quality.

1. Press **OK**, **3** **8** and **OK**.
2. Use **▲/▼** to set whether you would like to use a lower transmission speed.
3. Confirm with **OK**.

Switching Page Adjustment On and Off

In order that no information is lost, received faxes are reduced in size when printed.

1. Press **OK**, **3** **7** and **OK**.
2. Use **▲/▼** to select whether you would like to switch size reduction on or off.
3. Confirm with **OK**.

Setting the Ring Tones

Selecting the Ring Tone

You can select from among ten different ring tones.

1. Press **OK**, **5** **5** and **OK**.
2. Use the number keys **0** to **9** to select a ring tone. Using **▲/▼**, set the volume.
3. Confirm with **OK**.

Adjust volume level

You can adjust the volume of the ring tone when the device is ringing or when you set the ring tone. You can save different volumes for the * (day) and ☾ (night) modes (see also chapter *Setting the Fax Switch*, page 29).

Using **▲/▼** you can set adjust the volume when the device is ringing.

Setting the Fax Switch

The built-in fax switch of your device distinguishes between fax messages and telephone calls. Faxes are automatically received, telephone calls can be received—even on additionally connected devices. While the device is checking the call, it continues to ring.

You can set how often the device should ring before picking up separately for the modes * (day) and ☾ (night). This makes it possible for you to receive faxes silently at night without getting disturbed.

Press **☼/☾** to switch between day and night mode. With the activated timer **⌚**, the device switches between the modes * (day) and ☾ (night) at the configured times.

Setting the Day Mode

1. Press **OK**, **5** **1** and **OK**.
2. (Only for devices with built-in answering machine): Using **▲/▼** select the number of rings for the answering machine. The answering machine responds after these many number of rings.



Conserving Function of Fax Reception Mode

If you select the **5/2** option for the number of rings of the answering machine, the answering machine switches on after two rings, when you have received new messages. If there are no new messages, the device rings five times. If the device does not pick up after two rings, you have no new messages. You can terminate the remote access without incurring any telephone costs.

3. Confirm with **OK**.
4. (Only for devices without built-in answering machine): Use **▲/▼** select the total number of rings. The device stops the ring after these total number of rings and accepts a call or a possible silent fax.
5. Confirm with **OK**.
6. Use **▲/▼** to select the number of rings for the fax switch. After the number of rings, the fax switch switches on and distinguishes between fax transmissions and telephone calls. While the device is checking the call, it continues to ring.
7. Confirm with **OK**.
8. Using **▲/▼**, set the volume.
9. Confirm with **OK**.



Silent Fax Transmission

Older devices do not transmit any fax-tone (= CNG tone) as an announcement for fax transmission (= silent fax transmission). If the total number of rings has been set to a value using **7**, silent fax transmissions cannot be received automatically.

Setting the Night Mode

1. Press **OK**, **5** **2** and **OK**.
2. Configure the same settings as for the day mode (see steps **2** to **9**).

Setting the Timer

The timer switches between the modes * (day) and ☾ (night) at the configured times.

1. Press **OK**, **5** **3** and **OK**.
2. Enter the time at which the device should switch to * (day) mode, for example **0** **6** **0** **0** for 6 o'clock a.m.
3. Confirm with **OK**.
4. Enter the time at which the device should switch to ☾ (night) mode, for example **2** **2** **0** **0** for 10 o'clock p.m.
5. Confirm with **OK**.

Special Settings

Silent Fax Reception

If you would like to accept a fax without preceding rings, set the number of rings of the fax switch to 0.

Switching Off All Rings

If you don't want to be disturbed, e.g. in the night, by any incoming calls, you can set the number of rings to 0. The device switches immediately to silent fax reception.

Printing Lists and Help Pages

Printing Numbers and Entries

The list of numbers and entries contains the last ten calls received and numbers dialled as well as the saved entries and groups.

Press **OK**, **[2][3]** and **OK**. The list is printed.

Printing Call Log

The call log contains the last 50 dialled numbers.

1. Press **OK**, **[4][1]** and **OK**.
2. Using **▲/▼** indicate whether you would like to turn printing on or off.
3. Confirm with **OK**.
4. **Switch on printing:** Use **▲/▼**, to select whether the call list should be printed immediately or after every 50 calls.
5. Confirm with **OK**.

Printing the Telephone Book

Press **OK**, **[1][7]** and **OK**. The device prints a list with the telephone book entries and saved assignments.

Printing Fax Journal

The fax journal is a list of the last ten faxes sent and received.

1. Press **OK**, **[3][5]** and **OK**.
2. Using **▲/▼** indicate whether you would like to turn printing on or off.
3. Confirm with **OK**.
4. **Switch on printing:** Use **▲/▼**, to select whether the fax journal should be printed immediately or after every ten transmissions.
5. Confirm with **OK**.

Printing Transmission Report

After every transmission, the device prints out a transmission report. If a transmission error occurs, an error report is printed out. You can switch off printing of the transmission report.

1. Press **OK**, **[3][6]** and **OK**.
2. Using **▲/▼** indicate whether you would like to turn printing on or off.
3. Confirm with **OK**.

Printing Help Pages

Help 1 · Overview

Press **[1]** and **[1]** to print an overview of the help pages.

Help 3 · Telephone Book

Press **[1]** and **[3]** to print an overview of the telephone book and answering machine functions (model dependent).

Help 4 · Fax Transmission

Press **[1]** and **[4]** to print instructions for sending fax messages and for configuring the fax switch.

Help 5 · Copier

Press **[1]** and **[5]** to print the help for copying.

Help 6 · Function List

Press **[1]** and **[6]** to print a list of all functions and settings of your device.

Help 7 Games and Fun

Press **[1]** and **[7]** to print the instructions for the Games and Fun functions of your device.

Help 8 · SMS

Press **[1]** and **[8]** to print the instructions for SMS functions (model dependent).

Starting Initial Installation

1. Press **[1]** and **[2]**.
2. The device prints out a help page and starts the initial installation process.

II Telephone Lines and Additional Devices

Configuring Telephone Lines and Services

PABX Systems

Private branch exchanges (PABX) are typical in many offices and some households. You must dial an outside line access code in order to get a connection to the public telephone network (PSTN) from a PABX.

Additional Telephone No Extension

An additional telephone connected to the device on a telephone socket is not considered an extension.

1. Press **OK**, **[9]** **[6]** and **OK**.
2. In some countries you can set the dialling process to pulse dialling or tone dialling (DTMF tones). Use **▲/▼** to select the desired dialling process.

Selecting the Dialling Process

Only use pulse dialling if tone dialling is not yet activated for your telephone line.

3. Confirm with **OK**.
4. Use **▲/▼** to set whether you operate your device on an extension.
5. Confirm with **OK**.
6. **Configuring an extension:** Enter the outside line access code with which you reach the public telephone network. This is usually **[0]**.

Incorrect Outside Line Access Code

In rare cases, the outside line access code may be a different number or a two-digit number. For older telephone systems, the outside line access code can be **R** (= Flash). Press **R** to enter this outside line access code. If the connection to the public telephone network is not possible, contact your telephone system supplier.

7. Confirm with **OK**.
8. When finished, the device tests the telephone line. Confirm with **OK**.
9. Your device checks whether it can establish a connection with the public telephone network. If it cannot establish the connection, you are once again asked for input.

DSL Connection

In the event that you use a DSL modem: Connect the device to the slot intended for analogue telephones/fax machines! For additional information, please consult the operating manual of your DSL system. Ask your telephone or internet service provider if necessary.

ISDN Connection

Your device is an analogue fax device (Group 3). It is not an ISDN device (Group 4), and therefore it cannot be operated directly on an ISDN connection. In order to do this, you need either an analogue adapter or a connection for analogue terminals. Details for ISDN connections can be found in the instructions provided with the terminal adapter or the dial-up router.

Voice Mailbox

You cannot simultaneously use the answering machine facility of your telephone service provider (= voice-mail box) and receive faxes on your devices. Get the mailbox function for your telephone line deactivated or set the number of rings for the fax switch to lower than **5** on your device (see also chapter *Setting the Fax Switch*, page 29). When the fax switch accepts the call, the mailbox of the service provider does not step in. Enquire with your telephone company.

Connecting Additional Devices

You can operate additional devices on a telephone line, such as cordless telephones, answering machines, modems or charge counters.

SMS Reception with Additional Telephone

If you are using cordless telephone with SMS function on the same connection, then the specific device at which you will receive an SMS message will depend on the specific manufacturer. Only one of the devices will receive the SMS message. Try to turn off the SMS reception on your cordless telephone.

Connection to the Device

You can connect additional devices directly to your device. Insert the telephone cable of the additional device into the **EXT** socket (RJ-11-connection) on the device.



i Direct Connection Recommended

We recommend direct connection to the device because this allows the fax switch to function optimally and to control the additional devices.

Connection to the Telephone Line

In order for the fax switch to function, the device must be first in the series if multiple devices are connected to the same telephone socket. Follow the correct order.

i Connection to the First Telephone Socket

If you have multiple telephone sockets for the same telephone line, the device must be connected to the first telephone socket.

Using Additional Telephones (Easylink)

With the Easylink function you can control your device with additional telephones. To use this function, additional telephones must be set to the tone dialling mode (DTMF/MFV tones) (for this purpose see the operating manual of your additional telephone).

Starting Fax Reception

If you pick up at an additional device and hear that you are receiving a fax (whistling tone or silence), you can start the fax reception by pressing ***|5** on the additional telephone or pressing **⏏** on the device.

Taking Over the Line

If you pick up on an additional telephone and the device continues to ring or attempts to receive a fax, you can disconnect the device from the line. Press ***|*** on the additional telephone.

Changing Code

CAUTION!



Changing Easylink Codes!

Only change the codes if it is absolutely necessary. The codes must begin with ***|*** or **#|*** and must be different.

1. Press **OK**, **5|4** and **OK**.
2. Enter the new code for starting fax reception.
3. Confirm with **OK**.
4. Enter the new code for taking over the line on an additional device.
5. Confirm with **OK**.

Using an External Answering Machine

For the best operation, the answering machine must be connected to the **EXT** socket of the device. The numbers of rings set for the external answering machine should be less than the one set under **FAX RINGS** by at least two.

Example of the setting:

Number of Rings of the External Answering Machine |
FAX RINGS3

(see also chapter *Setting the Fax Switch*, page 29)



External Answering Machine

The outgoing message must be shorter than ten seconds. Avoid music in your announcement.

If the external answering machine has a “conserving function” (i.e. a function that changes the number of rings as soon as new messages have been recorded), switch it off.

If the external answering machine records fax signals, but your device cannot receive faxes, inspect the connection of the external answering machine.

12 Service



Troubleshooting

Should disruptions occur, follow the instructions on the display and on the error report.

Checking the Ink Film Reserve

1. Press **OK**, **[4]** **[6]** and **OK**.
2. The number of pages that can still be printed with the ink film is shown on the display.
3. Press **⏪** to return to the starting mode.

If the ink film used up or if there is no ink film in the device, a message appears on the display.

Changing the Ink Film

CAUTION!



Use Original Consumable Materials!

Use only original consumable materials. These are available from a specialised retailer or through our order service (see back side of this user manual). Other consumable materials can cause damage to the device.

CAUTION!



Observe Packaging Instructions

Follow the instructions on the packaging of the consumable materials.

For receiving or copying documents, an ink film must be inserted in your device. Your device is delivered with an already inserted free ink film for a few test pages. For this ink film, you do not require any Plug'n'Print card (= chip card with information regarding ink film capacity). For every next ink film that you insert, you must load the capacity memory with the included plug'n'play card.

1. Remove the paper from the paper feeder and take the paper tray out of the device.
2. Open the device by lifting the panel using grip in the centre and folding it up.



DANGER!

Device can Close with a Snap!

Lock the cover of the device completely into place when opening the device. You could be injured if the cover falls while you are working on the device.

3. Grip the rear ink film roll at both the sides and place it next to the front ink film roll.

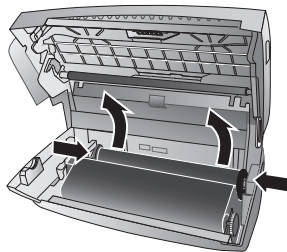

4. Remove both the rolls from the device. The used ink film cannot be reused.

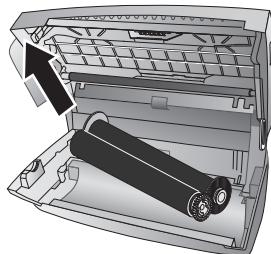

CAUTION!



Data on Used Ink Films!

The messages and copies you have printed out can be read from used ink films. Consider data protection issues when disposing of used ink films.

5. Pull the used Plug'n'Print card out of the plug socket on the left hand side next to the ink film tray. The Plug'n'Print card cannot be reused.

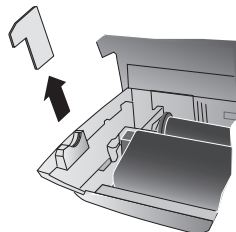

6. Carefully remove the rubber bands from the new ink film. Make sure that the film is not damaged!

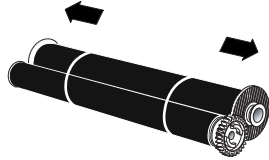

7. Place the larger roll with the ink film in the rear ink film tray. The blue gear wheel must be on the right hand side.

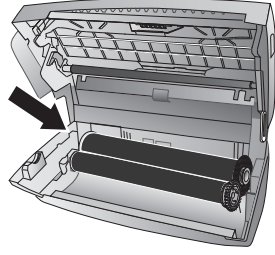

8. Place the smaller roll without ink film in the front tray. The blue gear wheel must be on the right hand side and the pin must be inserted in the depression on the left hand side.

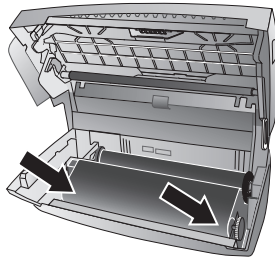

9. Break the chip card from the Plug'n'Print card. Insert the chip card in the plug socket on the left hand side next to the ink film tray.

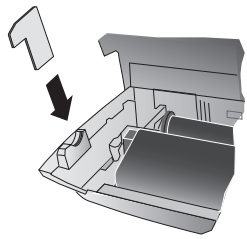

10. Turn the blue gear wheel forward to tension the ink film. The ink film must not have any creases.

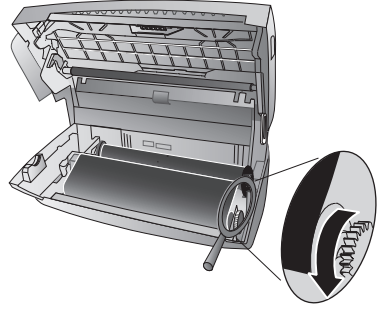

11. Close the device. Insert the paper tray in the opening provided for it behind the paper feeder. Insert paper again.

Fixing a Paper Jam

- 1. Remove the paper from the paper feeder and take the paper tray out of the device.
- 2. Open the device by lifting the panel using grip in the centre and folding it up.

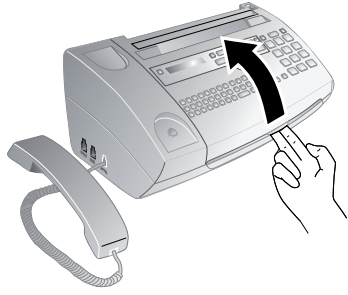

DANGER!

 **Device can Close with a Snap!**

Lock the cover of the device completely into place when opening the device. You could be injured if the cover falls while you are working on the device.

3. Carefully pull out the paper.

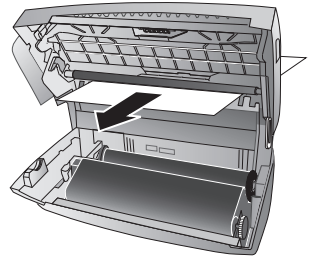

- Turn the blue gear wheel forward to tension the ink film. The ink film must not have any creases.

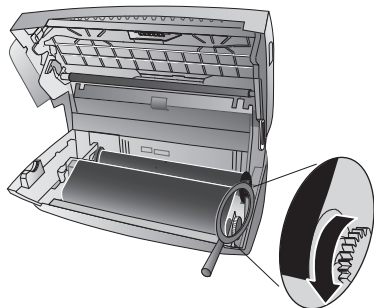

- Close the device. Insert the paper tray in the opening provided for it behind the paper feeder. Insert paper again.

Fixing a Document Jam

- Remove the paper from the paper feeder and take the paper tray out of the device.
- Open the device by lifting the panel using grip in the centre and folding it up.

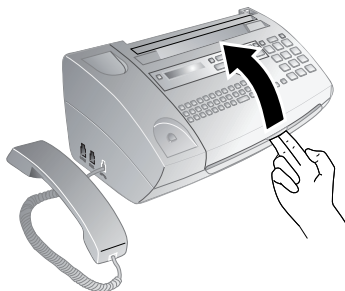

DANGER!



Device can Close with a Snap!

Lock the cover of the device completely into place when opening the device. You could be injured if the cover falls while you are working on the device.

- Open the scanner cover and the cover of the automatic document feeder by first pushing the support (A) and then the support (B) inside. The cover (C) falls freely.

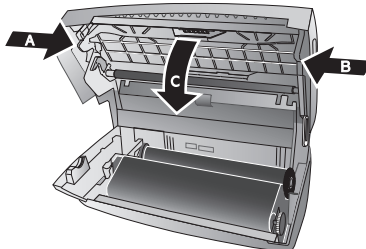

- Carefully pull the document to the front or to the back out of the device.

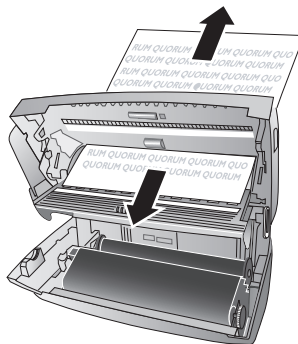

- Close the scanner cover and the cover of the automatic document feeder. Both the supports must securely snap into place.
- Turn the blue gear wheel forward to tension the ink film. The ink film must not have any creases.

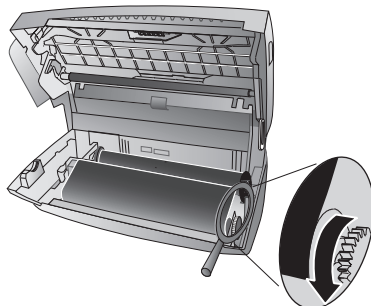

- Close the device. Insert the paper tray in the opening provided for it behind the paper feeder. Insert paper again.

Cleaning

DANGER!



Instructions for Cleaning!

Unplug the device from the power socket before cleaning it. Use a soft, lint-free cloth. Never use liquid or easily flammable cleansers (sprays, abrasives, polishes, alcohol, etc.). Do not allow any moisture to reach the interior of the device.



Fax Cleaning Sheets

Special fax cleaning sheets are available as accessories from our call centre. Insert a sheet into the document feeder. Press ; the page is ejected. Repeat this process at a few times.

1. Remove the paper from the paper feeder and take the paper tray out of the device.
2. Open the device by lifting the panel using grip in the centre and folding it up.

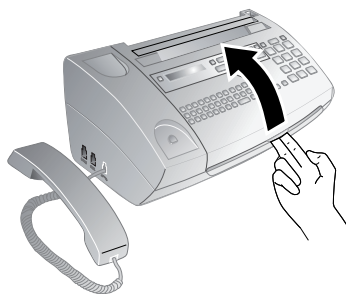

DANGER!



Device can Close with a Snap!

Lock the cover of the device completely into place when opening the device. You could be injured if the cover falls while you are working on the device.

3. Open the scanner cover and the cover of the automatic document feeder by first pushing the support (A) and then the support (B) inside. The cover (C) falls freely.

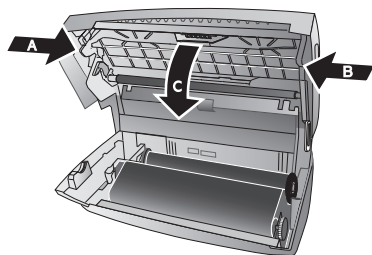

4. Lightly wipe the upper side of the scanner glass (A) and the lower side of the document feeder/scanner film (= white plastic plate) (B) with a cloth.

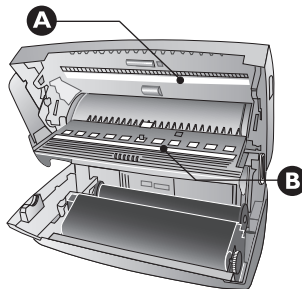

5. Clean the feed roller (A) and the underside of the support pad of the feeder roller (B) with a soft, lint-free cloth moistened with cleaning alcohol (96 percent). Rotate the feed roller; You must clean the entire roller.

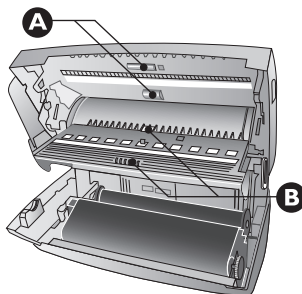

6. Close the scanner cover and the cover of the automatic document feeder. Both the supports must securely snap into place.
7. Turn the blue gear wheel forward to tension the ink film. The ink film must not have any creases.

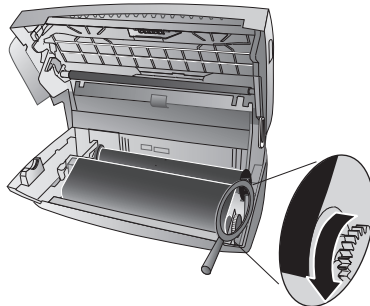

8. Close the device. Insert the paper tray in the opening provided for it behind the paper feeder. Insert paper again.

Checking the Firmware Version

1. Press **OK**, **[4][7]** and **OK**.
2. The model designation and the configured country appear on the display.
3. Confirm with **OK**.
4. The information on the firmware version of the device is displayed.
5. Confirm with **OK**.

Using Service Codes

The service codes delete all the changed settings and your device is reset to factory settings. It may be possible that the device with the changed settings reacts differently than expected.

CAUTION!



Settings will be Deleted!

Only use the service codes if this is absolutely necessary. Some service codes also delete saved messages and telephone book entries.

1. Press **OK**, **[4][5]** and **OK**.
2. Enter a service code:
 - [7][1][1][7]**—Deletes all changed settings and saved data. The device is reset to factory settings and the initial installation process is started.
 - [7][1][4][0]**—Deletes all changed settings. Saved data and telephone book entries remain intact.
 - [7][2][2][7]**—Deletes saved faxes, when there are problems with printing.
3. Confirm with **OK**.
4. Select with **▲/▼ SURE: YES**.
5. Confirm with **OK**.



Cancelling Entry

If you have entered the incorrect code, you can cancel the entry with **SURE: NO**.

Power Cycling

If a problem occurs that cannot be corrected with the instructions in this user manual (see also the help below), follow the steps given here.

1. Pull out the power plug.
2. Wait at least ten seconds, then plug the power plug back into the socket.
3. Follow the instructions on the display and in the error report. If the problem repeats, please contact our technical customer service or your retailer.

Troubleshooting

EN

General Information	
The time and date flash on the display.	You must check the time and date after a short power failure. Confirm with OK .
Problems when Faxing or Printing	
Faxes sent are of poor quality.	Change the resolution from RESOL. : STANDARD to RESOL. : FINE or RESOL. : PHOTO. Change the contrast. Clean the scanner and the document feed slot. Test the device by making a copy of the document. If the device is in order, the device of the recipient might be defective.
The device produces black lines when sending or printing.	Clean the scanner and the document feed slot.
Copy is blank.	Insert the documents face up into the document feeder.
Printing is interrupted.	Paper or document jam, no paper or ink film. Follow the instructions on the display and in the error report. There could be a small pause after printing several pages. The device continues printing automatically.
No printing	Check if you have inserted clamped paper correctly. The lever on the right hand side next to the paper feeder must be folded backwards.
Documents are not properly fed.	Clean the scanner and the document feed slot.
Problems with the Connection	
The device rings once, remains silent for a short while and starts ringing again.	This is absolutely normal. The fax switch checks the call after the first ring. If it is a voice call, the device continues to ring.
No dial tone	Check the installation of the device. Connect the telephone cable to the socket marked LINE . Insert the telephone plug into your PTT line socket.
Fax transmissions are constantly interrupted.	Try to send the fax manually: Press \square , and dial the number. If the recipient is using an answering machine, wait until you hear a whistling tone. Press \diamond . It is possible that the recipient's device is not ready to receive.
You hear a whistling tone or silence in the handset.	The call is a fax: Press \diamond on the device. Press \star 5 on the additional telephone. Hang up.
No fax reception or a short fax audio signal as message on the answering machine	Using function 51, set the number of rings for the fax switch to 4 and the total number or the number of rings for the answering machine (model dependent) to 5 (see also chapter <i>Setting the Fax Switch</i> , page 29). You cannot simultaneously use the answering machine facility of your telephone service provider (= voice-mail box) and receive faxes on your devices (see also chapter <i>Voice Mailbox</i> , page 31).

I3 Appendix

Technical Data

Dimensions (L × H × W)	303 × 126 × 195 mm
Weight	1,9 kg
Mains Connection	220–240 V~ / 50–60 Hz
Power Consumption	
Stand-by Mode	< 1,0 W
Transmission	< 20 W
Recommended Ambient	18–28 °C
Relative Humidity	20–80% (non-condensing)
Connection Type	PSTN · PABX
Dialling Mode	Tone / pulse dialling (country dependent)

Standards

Safety	EN 60950-1
Emissions	EN 55022 Class B
Immunity	EN 55024

Scanner

Scan Width	212 mm
Horizontal Resolution	8 dots/mm
Vertical Resolution	
Standard:	3,85 lines/mm
Fine:	7,70 lines/mm

Memory

Telephone Book	up to 50 entries (PPF 725)
	up to 200 entries (PPF 755)
Voice Messages	up to 30 minutes (PPF 755)
Fax Messages	up to 50 pages (standard test letter)
SMS Messages	up to 30

Paper

Capacity	50 sheets
Size	A4 · 210 × 297 mm
Thickness	0,07–0,11 mm
Weight	60–90 g/m ²

Document Feed Slot

Capacity	10 sheets
Width	148–212 mm
Length	100–600 mm
Thickness	0,06–0,15 mm

Fax

Type	Group 3
Compatibility	ITU-T.T.30
Data Compression	MH · MR
Modulation	V.21 · V.27ter · V.29 (PPF 725)
	V.17 · V.21 · V.27ter · V.29 (PPF 755)
Transfer Speed	9.600 bps (PPF 725)
	14.400 bps (PPF 755)

Technical specifications subject to change without notice.

You can find the complete warranty conditions on our website www.fax.philips.com



The CE symbol confirms conformity with the EU directives that apply to the device.

Declaration of Conformity (DoC)

Hereby, **Sagemcom Documents SAS** declares that this **PPF 725, PPF 755** is in compliance with the essential requirements and other relevant provisions of the Directives 2006/95/EG and 2009/125/CE.

You can find the complete Declaration of Conformity on our website www.fax.philips.com



As a participant in the ENERGY STAR programme, Sagemcom Documents SAS has made sure that this device complies with the ENERGY STAR requirements.



Packaging: To facilitate packaging recycling, please conform to your local selective recycling rules.

Batteries: Old batteries have to be deposited in designated collection areas.



Product: The crossed out dustbin logo on your product signifies it is classified as Electrical and Electronic Equipment covered by special disposal regulations.

To enforce recycling, recovery of The Waste Electrical and Electronic Equipment (WEEE) and to protect the environment and human health, European regulations requires that you selectively collect waste equipment using one of the following options :

- Your retailer will take your equipment back if you are buying a replacement product.

Waste equipment can also be deposited in designated collection areas.

The paper and cardboard packaging used can be disposed of as recyclable paper. Have the plastic wrapping and Styrofoam packaging recycled or dispose of it in the non-recyclable waste, depending on the requirements in your country.

Trademarks: The references mentioned in this manual are trademarks of the respective companies. The lack of the trademarks ® and ™ does not justify the assumption

that these dedicated terminologies are free trademarks. Other product names used herein are for identification purposes only and may be trademarks of their respective owners. Sagemcom disclaims any and all rights in those marks.

The reproduction of certain documents (e.g. by scanning, printing, copying) is prohibited in many countries. The list of such documents below is not intended to be complete, it only offers a general overview. In case of doubt, consult your legal advisor.

- Passports (personal identification)
 - Entrance and exit visa papers (immigration papers)
 - Military service documents
 - Bank notes, travel checks, payment orders
 - Postage stamps, tax stamps (stamped or unstamped)
 - Loan papers, certificates of deposit, bonds
 - Documents protected by copyright

Follow the statutory regulations of your country with regard to the legal validity of fax transmissions—particularly in connection with the validity of signatures, meeting delivery deadlines or disadvantages resulting from the loss of quality in the transmission, etc.

Take care to maintain the statutory regulations of your country regarding telecommunications secrecy and data privacy.

This product is intended for use on an analogue public telecommunications network (PSTN) and in the country specified on the packaging. Use in other countries can result in faulty functioning.

For more information, please contact the technical service centre for your country. Should problems arise during use of your device, please contact your retailer first.

Neither Sagemcom nor its affiliates shall be liable to the purchaser of this product or third parties for damages, losses, costs, or expenses incurred by the purchaser or third parties as a result of accident, misuse, or abuse of this product or unauthorized modifications, repairs, or alterations to this product, or failure to strictly comply with Sagemcom operating and maintenance instructions.

Sagemcom shall not be liable for any damages or problems arising from the use of any options or any consumable materials other than those designated as original Sagemcom products or Sagemcom approved products.

Sagemcom shall not be held liable for any damage resulting from electromagnetic interference that occurs from the use of any interface cables other than those designated as Sagemcom products.

All rights reserved. No part of this publication may be reproduced, stored in a retrieval system or transmitted in any form or by any means, electronic, mechanical, photocopying, recording, or otherwise, without the prior written permission of Sagemcom. The information contained herein is designed only for use with this product. Sagemcom is not responsible, if this information is applied to other devices.

This user manual is a document that does not represent a contract.

Errors, printing errors and changes are reserved.

Copyright © 2012 Sagemcom Documents SAS

Customer Information

As part of our continuing quest for total customer satisfaction, all of our products are made with ease-of-use and reliability in mind.

In your user manual you will find all the information required to use your machine. If, after consulting your user manual, you still require assistance, you should contact our Call Centre. Our personnel are highly trained specialists who can ensure that you receive the maximum benefit from your product.

We can assist you more quickly if you do not call us from the machine, rather an external telephone. Keep a printout of the settings as well as the serial number of the machine handy. The serial number can be found on the type label.

United Kingdom

Telephone: 08 45 - 090 03 15

Fax: 08 70 - 124 02 02

You can order original accessories from our homepage or—in some countries (see below)—per telephone on our toll-free number.

Use only original consumable materials. The warrantee does not cover damages to the device resulting from other consumables.

United Kingdom

Telephone: 0800 - 358 08 07

E-Mail: support.service@sagemcom.com

Internet: www.fax.philips.com



PHILIPS and the PHILIPS' Shield Emblem are registered trademarks of Koninklijke Philips Electronics N.V. and are used by Sagemcom under license from Koninklijke Philips Electronics N.V.

Sagemcom Documents SAS

Documents Business Unit

Headquarters : 250, route de l'Empereur
92500 Rueil-Malmaison Cedex · FRANCE
Tel: +33 (0)1 57 61 10 00 · Fax: +33 (0)1 57 61 10 01
www.sagemcom.com

Simplified Joint Stock Company · Capital 8.479.978 € · 509 448 841 RCS Nanterre

PPF 725 · PPF 755
UK · INT
253499967-A

Free Manuals Download Website

<http://myh66.com>

<http://usermanuals.us>

<http://www.somanuals.com>

<http://www.4manuals.cc>

<http://www.manual-lib.com>

<http://www.404manual.com>

<http://www.luxmanual.com>

<http://aubethermostatmanual.com>

Golf course search by state

<http://golfingnear.com>

Email search by domain

<http://emailbydomain.com>

Auto manuals search

<http://auto.somanuals.com>

TV manuals search

<http://tv.somanuals.com>