



**LCD TV**

## Directions for Use

Important!  
Return your  
Warranty  
Registration Card  
within 10 days.  
See why inside.

### **Need help? Call us!**

*Philips representatives are ready to help you with any questions about your new product. We can guide you through Connections, First-time Setup, or any of the Features. We want you to start enjoying your new product right away!*

**FOR FAST HELP PLEASE CALL,  
1-800-531-0039**

**or**

**Visit us on the web at  
[www.philips.com](http://www.philips.com)**

*Let's make things better.*



**PHILIPS**

# Return your Warranty Registration card today to ensure you receive all the benefits you're entitled to.

Once your PHILIPS purchase is registered, you're eligible to receive all the privileges of owning a PHILIPS product. So complete and return the Warranty Registration Card enclosed with your purchase at once. And take advantage of these important benefits.

## Warranty Verification

Registering your product within 10 days confirms your right to maximum protection under the terms and conditions of your PHILIPS warranty.

## Owner Confirmation

Your completed Warranty Registration Card serves as verification of ownership in the event of product theft or loss.

## Model Registration

Returning your Warranty Registration Card right away guarantees you'll receive all the information and special offers which you qualify for as the owner of your model.

Congratulations on your purchase, and welcome to the "family!"

# PHILIPS



Dear PHILIPS product owner:

Thank you for your confidence in PHILIPS. You've selected one of the best-built, best-backed products available today. And we'll do everything in our power to keep you happy with your purchase for many years to come.

As a member of the PHILIPS "family," you're entitled to protection by one of the most comprehensive warranties and outstanding service networks in the industry.

What's more, your purchase guarantees you'll receive all the information and special offers for which you qualify, plus easy access to accessories from our convenient home shopping network.

And most importantly you can count on our uncompromising commitment to your total satisfaction.

All of this is our way of saying welcome—and thanks for investing in a PHILIPS product.

Sincerely,

Lawrence J. Blanford  
President and Chief Executive Officer

P.S. Remember, to get the most from your PHILIPS product, you must return your Warranty Registration Card within 10 days. So please mail it to us right now!

## Know these safety symbols



This "bolt of lightning" indicates uninsulated material within your unit may cause an electrical shock. For the safety of everyone in your household, please do not remove product covering.

The "exclamation point" calls attention to features for which you should read the enclosed literature closely to prevent operating and maintenance problems.

WARNING: TO PREVENT FIRE OR SHOCK HAZARD, DO NOT EXPOSE THIS EQUIPMENT TO RAIN OR MOISTURE.

CAUTION: To prevent electric shock, match wide blade of plug to wide slot, and fully insert.

ATTENTION: Pour éviter les chocs électriques, introduire la lame la plus large de la fiche dans la borne correspondante de la prise et pousser jusqu'au fond.

**PHILIPS** Visit our World Wide Web Site at <http://www.philips.com>

# IMPORTANT SAFETY INSTRUCTIONS

## Read before operating equipment

1. Read these instructions.
  2. Keep these instructions.
  3. Heed all warnings.
  4. Follow all instructions.
  5. Do not use this apparatus near water.
  6. Clean only with a dry cloth.
  7. Do not block any of the ventilation openings. Install in accordance with the manufacturers instructions.
  8. Do not install near any heat sources such as radiators, heat registers, stoves, or other apparatus (including amplifiers) that produce heat.
  9. Do not defeat the safety purpose of the polarized or grounding-type plug. A polarized plug has two blades with one wider than the other. A grounding type plug has two blades and third grounding prong. The wide blade or third prong are provided for your safety. When the provided plug does not fit into your outlet, consult an electrician for replacement of the obsolete outlet.
  10. Protect the power cord from being walked on or pinched particularly at plugs, convenience receptacles, and the point where they exit from the apparatus.
  11. Only use attachments/accessories specified by the manufacturer.
  12.  Use only with a cart, stand, tripod, bracket, or table specified by the manufacturer, or sold with the apparatus. When a cart is used, use caution when moving the cart/apparatus combination to avoid injury from tip-over.
  13. Unplug this apparatus during lightning storms or when unused for long periods of time.
  14. Refer all servicing to qualified service personnel. Servicing is required when the apparatus has been damaged in any way, such as power-supply cord or plug is damaged, liquid has been spilled or objects have fallen into apparatus, the apparatus has been exposed to rain or moisture, does not operate normally, or has been dropped.
  15. This product may contain lead and mercury. Disposal of these materials may be regulated due to environmental considerations. For disposal or recycling information, please contact your local authorities or the Electronic Industries Alliance: [www.eiae.org](http://www.eiae.org)
  16. **Damage Requiring Service** - The appliance should be serviced by qualified service personnel when:
    - A. The power supply cord or the plug has been damaged; or
    - B. Objects have fallen, or liquid has been spilled into the appliance; or
    - C. The appliance has been exposed to rain; or
    - D. The appliance does not appear to operate normally or exhibits a marked change in performance; or
    - E. The appliance has been dropped, or the enclosure damaged.
- 17. Tilt/Stability** - All televisions must comply with recommended international global safety standards for tilt and stability properties of its cabinet design.
- Do not compromise these design standards by applying excessive pull force to the front, or top, of the cabinet which could ultimately overturn the product.
  - Also, do not endanger yourself, or children, by placing electronic equipment/toys on the top of the cabinet. Such items could unsuspectingly fall from the top of the set and cause product damage and/or personal injury.
- 18. Wall or Ceiling Mounting** - The appliance should be mounted to a wall or ceiling only as recommended by the manufacturer.
- 19. Power Lines** - An outdoor antenna should be located away from power lines.
- 20. Outdoor Antenna Grounding** - If an outside antenna is connected to the receiver, be sure the antenna system is grounded so as to provide some protection against voltage surges and built up static charges.
- Section 810 of the National Electric Code, ANSI/NFPA No. 70-1984, provides information with respect to proper grounding of the mast and supporting structure, grounding of the lead-in wire to an antenna discharge unit, size of grounding connectors, location of antenna-discharge unit, connection to grounding electrodes, and requirements for the grounding electrode. See Figure below.
- 21. Object and Liquid Entry** - Care should be taken so that objects do not fall and liquids are not spilled into the enclosure through openings.
- 22. Battery Usage CAUTION** - To prevent battery leakage that may result in bodily injury, property damage, or damage to the unit:
- Install all batteries correctly, with + and - aligned as marked on the unit.
  - Do not mix batteries (old and new or carbon and alkaline, etc.).
  - Remove batteries when the unit is not used for a long time.

**Note to the CATV system installer:** This reminder is provided to call the CATV system installer's attention to Article 820-40 of the NEC that provides guidelines for proper grounding and, in particular, specifies that the cable ground shall be connected to the grounding system of the building, as close to the point of cable entry as practical.

### Example of Antenna Grounding as per NEC - National Electric Code

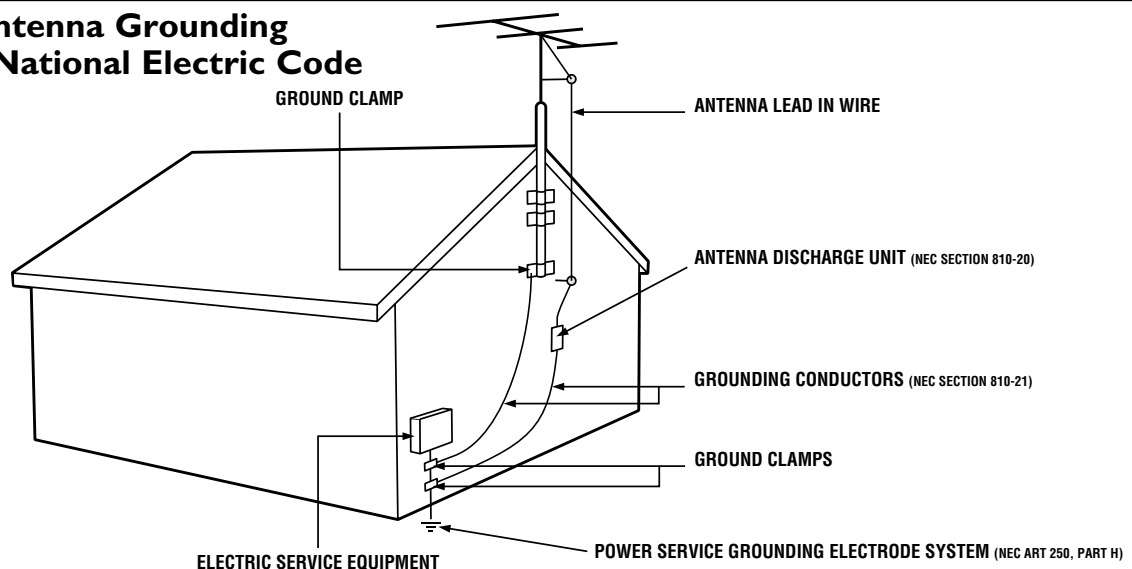

## PRECAUTIONS

### Additional Safety Precautions:

- Do not shift or move the LCD TV around when it is powered on.
- Do not connect any AC/DC adapter to your LCD TV that does not originally come with the television. Only use the recommended part or parts that are approved by Philips Consumer Electronics.
- Caution: Do not use any cover or enclose the AC/DC adapter with any objects like a cloth or box which might shorten the life of the equipment.
- Do not touch, push or rub the surface of the LCD screen with any sharp or hard objects.
- When the surface of the LCD screen becomes dusty, wipe it gently with an absorbent cotton cloth or other soft material like chamois. DO NOT use acetone, toluene or alcohol to clean the surface of the screen. These chemicals will cause damage.
- Wipe off water, or saliva as soon as possible. Long exposure time to liquids can cause deformation and color fading of the LCD screen.
- Be careful of condensation when temperature changes occur. Condensation can cause damage to the LCD screen and electrically parts. After condensation fades, spots or blemishes will be present on the LCD screen.

### Positioning the LCD Television:

- Place the LCD TV on a solid, sturdy base or stand. Be sure the stand is strong enough to handle the weight of the LCD TV.
- Try to leave at least 6" of space around each side of the LCD TV cabinet to allow for proper ventilation.
- Do not place the LCD TV near a radiator or other sources of heat.
- Do not place the LCD TV where it can be exposed to rain or excessive moisture.

### Recycling Procedure/End of Life Disposal:

- To minimize harm to the environment, the batteries supplied with the LCD TV do not contain mercury or nickel cadmium. If possible, when disposing of batteries, use recycling means available in your area.
- The LCD TV uses materials that can be recycled. To minimize the amount of waste in the environment, check your area for companies that will recover used televisions for dismantling and collection of reusable materials, or contact your dealer for TV recycling tips.
- Please dispose of the carton and packing material through the proper waste disposal management in your area.

**NOTE: It is possible that this owner's manual may be used with several different television models. Not all features (and drawings) discussed in this manual will necessarily match those found with your television system. While every effort is made to give the consumer the most accurate information possible regarding this product, normal changes in production could occur affecting the images and onscreen menu procedures outlined in this manual. This is normal and does not require you contacting your dealer or requesting service.**

# CONTENTS

## Introduction

Welcome/Registration of Your TV	2
Safety Instructions	3
Precautions	4
Table of Contents	5

## Install Menu

How to use the Language Control	6
How to use the Tuner Mode Control	7
How to Auto Program TV Channels	8
How to Add or Delete Channels (Channel Edit)	9
How to use the AutoChron™ Control	10
How to use the Name Control (Channel Label)	11

## Picture Menu

How to use the Picture Adjustment Controls	12
--	----

## Sound Menu

How to use the Equalizer Controls	13
How to use the Balance Control	14
How to use the AVL Control	15
How to use the Incredible Surround Control	16
Setting the TV to receive Stereo programming	17
Setting the TV to receive SAP (Secondary Audio Programming)	18
How to use the Audio Out Control	19
Turning the TV Speakers on or off	20

## Features Menu

How to use the Timer Controls	21
How to use the Mode Select Control	22
How to set the Active Control	23
Understanding the AutoLock™ Controls	24
Setting up the AutoLock™ Access Code	25
How to Block Channels	26
How to Clear All Blocked Channels at the Same Time	27
Blocking Programming Based on Movie Ratings	28
Blocking Programming Based on TV Ratings	29
Other AutoLock™ Blocking Options	30
Using the AutoLock™ Review Screen	31

## Remote Control Use

How to use the Closed Captioning Control	32
How to use the Widescreen Control (Format)	33
How to use the Program List Feature	34
Setting the Sleptimer Control	35
Setting the AutoPicture™ Control	36
Setting the AutoSound™ Control	37
Using the Surf Control	38
Programming the Remote Control for Accessory Devices	
Direct Access Method	39
Code Entry Method	40
Search Code Method	41
Remote Code List	42-44
Accessory Device Remote Control Buttons	45

## FM Radio Mode

Using FM Mode Information	46-52
---------------------------	-------

## HD (High Definition) Mode

How to use the HD Mode and it's Features	53-56
--	-------

## PC Mode

How to use the PC Mode Features	57-58
---------------------------------	-------

## General Information

Troubleshooting Tips	59
Cleaning and Care	59
Glossary of Terms	60
Index	61
Factory Service Location	62-63
Warranty	64

### *Here are a few of the features built into your new Television:*

**Active Control™** continuously measures and corrects all incoming signals to help provide the best picture quality. This feature monitors and corrects both the sharpness control and noise reduction control.

**Audio/Video Jack Panels** allows direct connections with VCRs, DVDs, PCs or other devices, providing quality TV picture and sound playback.

**Audio Volume Leveler (AVL) Control** keeps the TV sound at an even level. Peaks and valleys that occur during program changes or commercial breaks are reduced, making for a more consistent, comfortable sound.

**AutoChron™** automatically sets the right time of day and maintains it with digital precision through brownouts, power failures, and even Daylight Savings Time adjustments.

**AutoLock™** allows you to block the viewing of certain channels or programs with certain ratings if you do not want your children to view inappropriate materials.

**Auto Programming** scans (when activated) for all available channels from regular antenna or cable signals and stores only active broadcast stations in the TV's memory.

**AutoPicture™** allows you to change the picture settings (color, tint, contrast, etc.) for various types of programming, such as sports, movies, multimedia (games), or weak signals with the push of one button.

**AutoSound™** allows you to select from three factory-set controls and a personal control that you set according to your own preferences through the onscreen Sound menu. The three factory-set controls (Voice, Music, and Theatre) enable you to tailor the TV sound so as to enhance the particular programming you are watching.

**Closed Captioning** allows the viewer to read TV program dialogue or voice conversations as onscreen text.

**Infrared Remote Control** works your TV and other remote-controlled devices, such as VCRs, DVD players, cable converters, and satellite receivers.

**Surf Button** allows you to easily switch among only the channels that are of interest to you (the ones that you have programmed into the TV's Surf control through the onscreen menu).

**Timer** allows you to set your TV to turn itself ON and OFF once or daily like an alarm clock.

Active Control, Auto Lock, Auto Picture, Auto Sound, are all registered trademarks of Philips Consumer Electronics Company.  
Copyright © 2003 All rights reserved.



# HOW TO USE THE LANGUAGE CONTROL

*For or Spanish- and French-speaking TV owners, an onscreen LANGUAGE option is present. The LANGUAGE control enables you to set the TV's onscreen menu to be shown in either English, Spanish, or French.*

- 1** Press the **MENU** button on the remote control to show the onscreen menu.
- 2** Press the **CURSOR DOWN** button repeatedly until **INSTALL** is highlighted.
- 3** Press the **CURSOR RIGHT** button to shift the menu to the left and highlight **LANGUAGE**.
- 4** Press the **CURSOR RIGHT** button to highlight the **LANGUAGE** control options.
- 5** Press the **CURSOR UP** or **CURSOR DOWN** button to select **ENGLISH**, **ESPANOL** (Spanish), or **FRANCAIS** (French).
- 6** Press the **STATUS/EXIT** button to clear the menu from the screen.

## HELPFUL HINT

Remember, the LANGUAGE control makes only the TV's onscreen MENU items appear in English, Spanish, or French text. It does not change the other onscreen text features, such as Closed Captioning (CC), with TV shows.

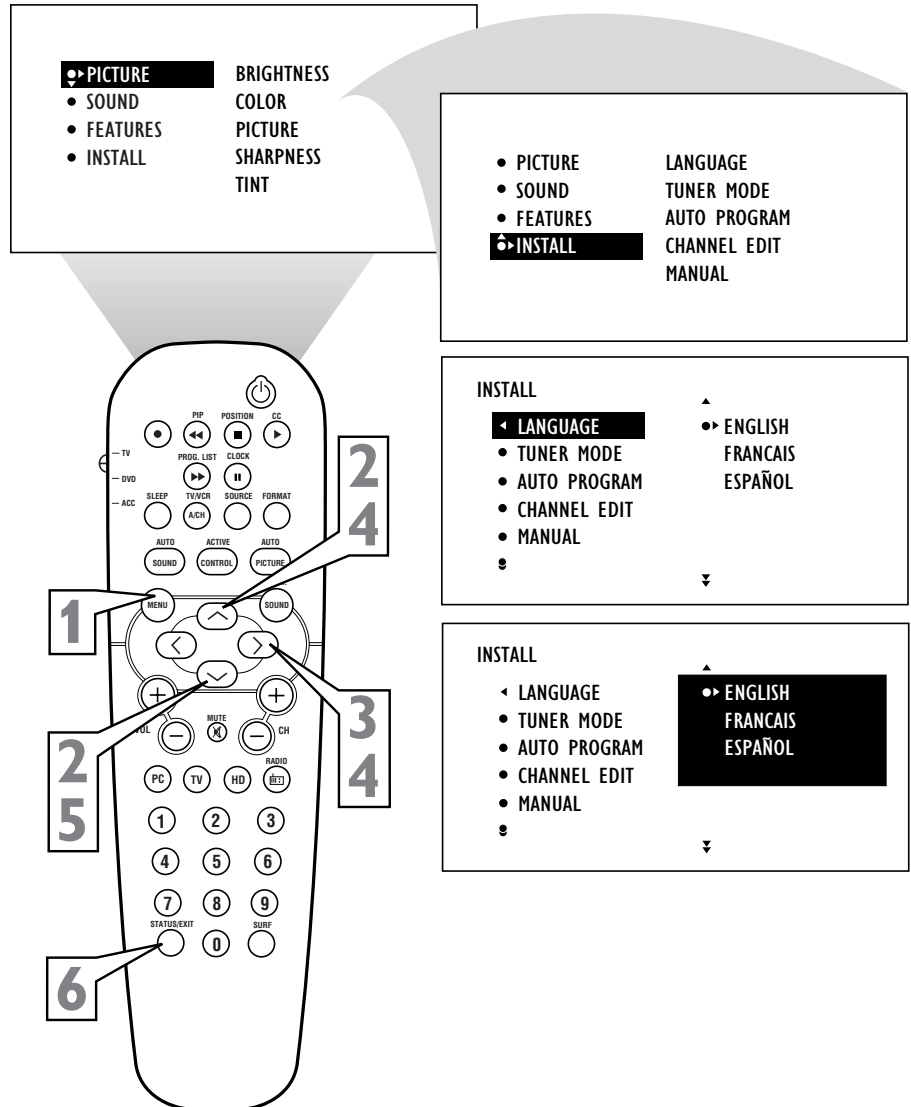

# How to Use the Tuner Mode Control



The **TUNER MODE** allows you to change the TV's signal input to **CABLE**, **ANTENNA**, or **AUTO** mode. It's important for the TV to know if you want to receive channels from a cable TV signal or a normal antenna signal.

**NOTE:** The **AUTO** mode setting helps the TV determine the type of signal or channels being received when **AUTO PROGRAM** is activated.

- 1** Press the **MENU** button on the remote control to show the onscreen menu.
- 2** Press the **CURSOR DOWN** button repeatedly until **INSTALL** is highlighted.
- 3** Press the **CURSOR RIGHT** button to shift the menu to the left.
- 4** Press the **CURSOR DOWN** button to highlight the **TUNER MODE** control.
- 5** Press the **CURSOR RIGHT** button to highlight the tuner options.
- 6** Press the **CURSOR UP** or **CURSOR DOWN** button to select **CABLE**, **ANTENNA** or **AUTO**.  
If **TUNER MODE** is set to **AUTO**, Auto Program (see below) will detect whether or not cable input is present.
- 7** Press the **STATUS/EXIT** button to clear the menu from the screen.

## HELPFUL HINT

When **CABLE** is selected, channels 1–125 are available.

When **ANTENNA** is selected, channels 2–69 are available.

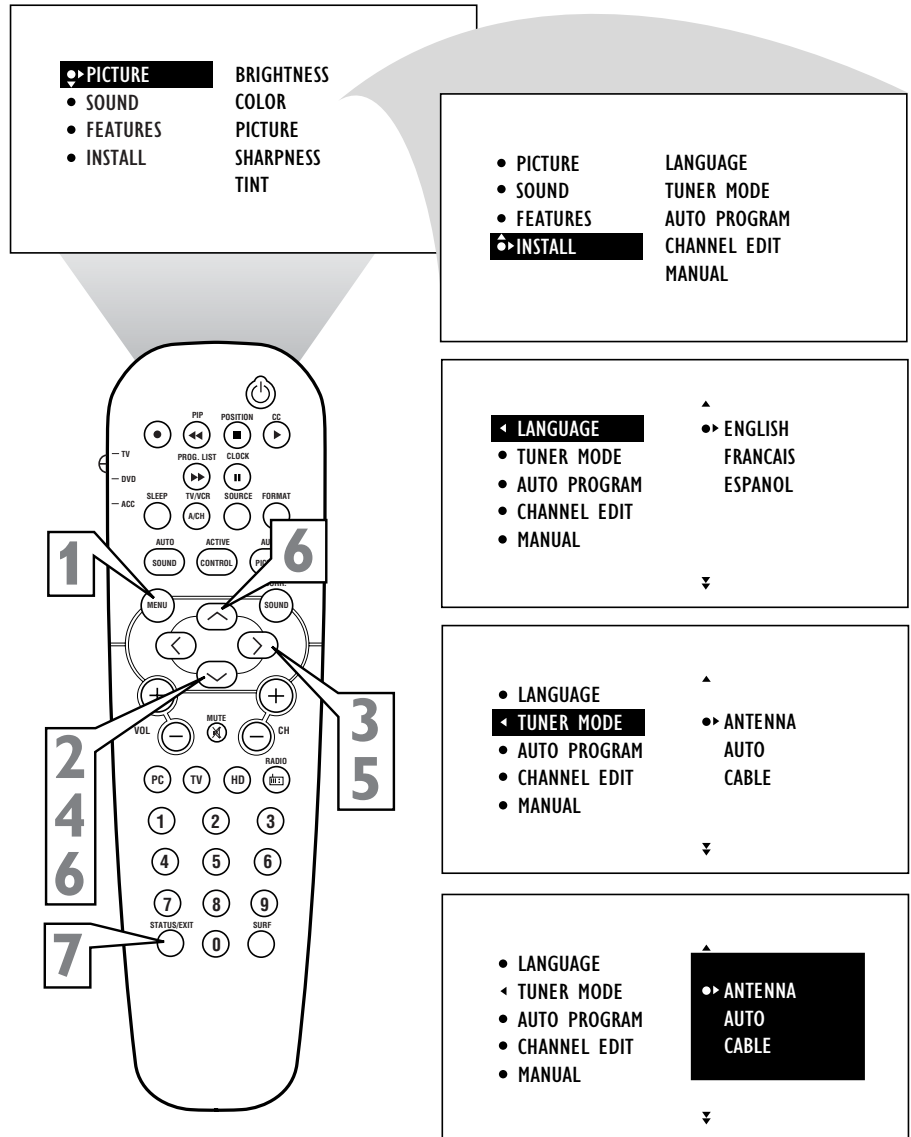



# How to AUTO PROGRAM TV CHANNELS

Your TV can automatically set itself for local area (or cable TV) channels. This makes it easy for you to select only the TV stations in your area by pressing the CHANNEL (+) or (-) button.

- 1** Press the **MENU** button on the remote control to show the onscreen menu.
- 2** Press the **CURSOR DOWN** button repeatedly until **INSTALL** is highlighted.
- 3** Press the **CURSOR RIGHT** button to shift the menu to the left. **LANGUAGE** will be highlighted.
- 4** Press the **CURSOR DOWN** button repeatedly until the **AUTO PROGRAM** control is highlighted.
- 5** Press the **CURSOR RIGHT** button to start the Auto Program scanning of channels.
- 6** Press the **STATUS/EXIT** button to clear the menu from the screen.

## HELPFUL HINT

After you've run Auto Program, check out the results. Press the CHANNEL (+) or (-) button and see which channels you can select.

Remember, an antenna or cable TV signal must first be connected to your TV (see instructions for making connections on page 1 of this guide).

▶ PICTURE	BRIGHTNESS
• SOUND	COLOR
• FEATURES	PICTURE
• INSTALL	SHARPNESS
	TINT

• PICTURE	LANGUAGE
• SOUND	TUNER MODE
• FEATURES	AUTO PROGRAM
▶ INSTALL	CHANNEL EDIT
	MANUAL

INSTALL	
▶ LANGUAGE	▶ ENGLISH
• TUNER MODE	FRANCAIS
• AUTO PROGRAM	ESPANOL
• CHANNEL EDIT	
• MANUAL	

INSTALL	
• LANGUAGE	
• TUNER MODE	
▶ AUTO PROGRAM	▶ SEARCH
• CHANNEL EDIT	
• MANUAL	

INSTALL	
• LANGUAGE	
• TUNER MODE	
▶ AUTO PROGRAM	
• CHANNEL EDIT	
• MANUAL	
	ANTENNA
	▶ PLEASE WAIT
	— —
	CHANNEL 20



# HOW TO ADD OR DELETE CHANNELS (CHANNEL EDIT CONTROL)



**C**HANNEL EDIT makes it easy for you to add or delete channels from the list of channels stored in the TV's memory.

- 1** Press the **MENU** button on the remote control to show the onscreen menu.
- 2** Press the **CURSOR DOWN** button repeatedly until **INSTALL** is highlighted.
- 3** Press the **CURSOR RIGHT** button to shift the menu to the left. **LANGUAGE** will be highlighted.
- 4** Press the **CURSOR DOWN** button repeatedly until the **CHANNEL EDIT** control is highlighted.
- 5** Press the **CURSOR RIGHT** button to access the **CHANNEL EDIT** menu.
- 6** Press the **CURSOR UP** or **CURSOR DOWN** button to scroll through the list of available channels. Or press the number buttons on your remote control to select a specific channel (for example, press 0 and then 2 to select channel 2).
- 7** With the channel you want to edit selected, press the **CURSOR RIGHT** button to mark the channel as **SKIPPED**. The channel you've marked **SKIPPED** will not appear when you are changing from channel to channel while watching TV.

**NOTE:** When you want to add a channel that has been marked **SKIPPED**, press the **CURSOR UP** or **CURSOR DOWN** button to highlight the channel; then press the **CURSOR RIGHT** button to remove the word **SKIPPED**.

The diagram illustrates the steps to add or delete channels using the remote control and the TV's onscreen menu. The remote control has callouts 1 through 7 pointing to the MENU, CURSOR DOWN, CURSOR RIGHT, CURSOR UP, and CURSOR DOWN buttons respectively.

The onscreen menu sequence is as follows:

- Initial Menu:**
  - PICTURE (highlighted)
  - SOUND
  - FEATURES
  - INSTALL
  - BRIGHTNESS
  - COLOR
  - PICTURE
  - SHARPNESS
  - TINT
- Second Menu:**
  - PICTURE
  - SOUND
  - FEATURES
  - INSTALL (highlighted)
  - LANGUAGE
  - TUNER MODE
  - AUTO PROGRAM
  - CHANNEL EDIT
  - MANUAL
- Third Menu:**
  - INSTALL
  - LANGUAGE (highlighted)
  - TUNER MODE
  - AUTO PROGRAM
  - CHANNEL EDIT
  - MANUAL
  - ENGLISH
  - FRANCAIS
  - ESPAÑOL
- Fourth Menu:**
  - INSTALL
  - LANGUAGE
  - TUNER MODE
  - AUTO PROGRAM
  - CHANNEL EDIT (highlighted)
  - MANUAL
  - 2
  - 3
  - 4
  - 5
- Fifth Menu:**
  - INSTALL
  - LANGUAGE
  - TUNER MODE
  - AUTO PROGRAM
  - CHANNEL EDIT (highlighted)
  - MANUAL
  - 2
  - 3
  - 4
  - 5
- Sixth Menu:**
  - INSTALL
  - LANGUAGE
  - TUNER MODE
  - AUTO PROGRAM
  - CHANNEL EDIT (highlighted)
  - MANUAL
  - 2
  - 3
  - 4
  - 5
- Final Menu:**
  - INSTALL
  - LANGUAGE
  - TUNER MODE
  - AUTO PROGRAM
  - CHANNEL EDIT (highlighted)
  - MANUAL
  - 2
  - 3
  - 4
  - 5
  - SKIPPED

## HELPFUL HINT

The channels available for you to edit are the ones that the **AUTO PROGRAM** feature found through a search of your TV antenna or cable TV signals. Channels not found during the search are marked **SKIPPED**.



# How to Use the AutoChron™ CONTROL

AutoChron™ can automatically set the TV's onscreen clock. Because the time is received from a broadcast signal, you must be sure that a cable TV or antenna signal is present before you attempt to use the AutoChron™ feature.

- 1 Press the **MENU** button on the remote to show the onscreen menu.
- 2 Press the **CURSOR DOWN** button repeatedly until **INSTALL** is highlighted.
- 3 Press the **CURSOR RIGHT** button to shift the menu to the left. **LANGUAGE** will be highlighted.
- 4 Press the **CURSOR DOWN** button until the AutoChron control is highlighted.
- 5 Press the **CURSOR RIGHT** button to start the AutoChron™ feature. Then just follow the onscreen instructions to set the clock.
- 6 Press the **CURSOR RIGHT** button to select **AUTO**. Within a few seconds, a menu for choosing your time zone will appear.
- 7 Press the **CURSOR UP** or **CURSOR DOWN** button to highlight your correct time zone.
- 8 With your correct time zone highlighted, press the **CURSOR RIGHT** button. Within a few seconds, you will be given the option to choose whether you want to select Daylight Savings Time. If your time zone uses Daylight Savings Time, select **YES**.
- 9 Enter your local **PBS** channel or any local channel that transmit the current time, and press the **CURSOR RIGHT** button to start the searching process. If the AutoChron™ features finds the current time you are done. If it doesn't find the current time, re-enter an other channel and search again.

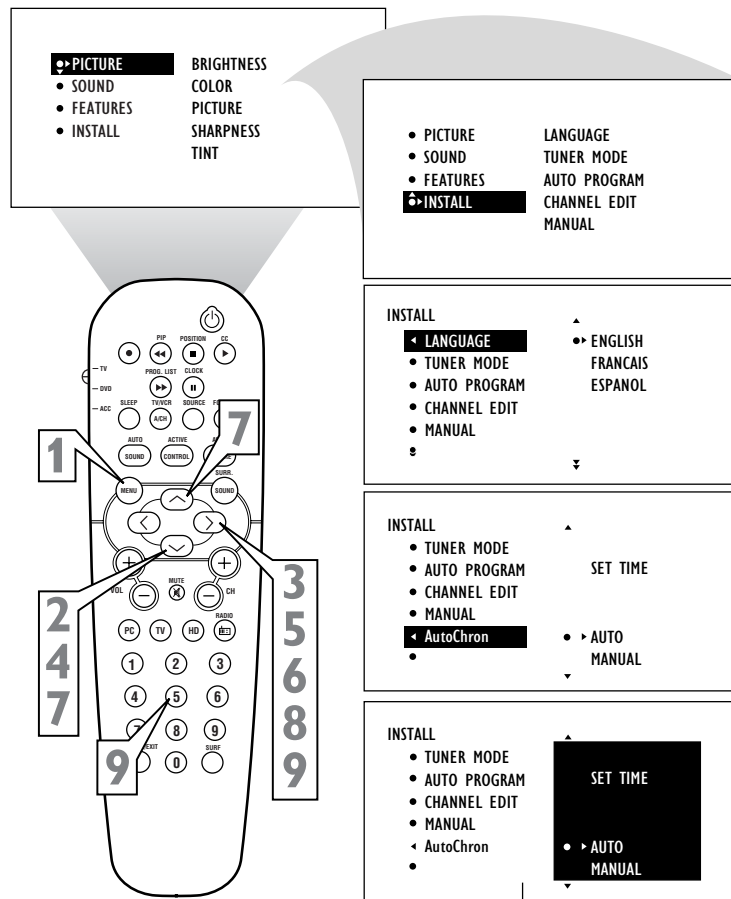

**HELPFUL HINT**

When turned ON, the AutoChron™ feature can affect the start up of your television. When the power button is press and the AutoChron™ feature is set to the **AUTO** position, the TV will scan the channels for a PBS channel to set the clock automatically. It may take **SEVERAL** seconds before the TV powers itself ON.

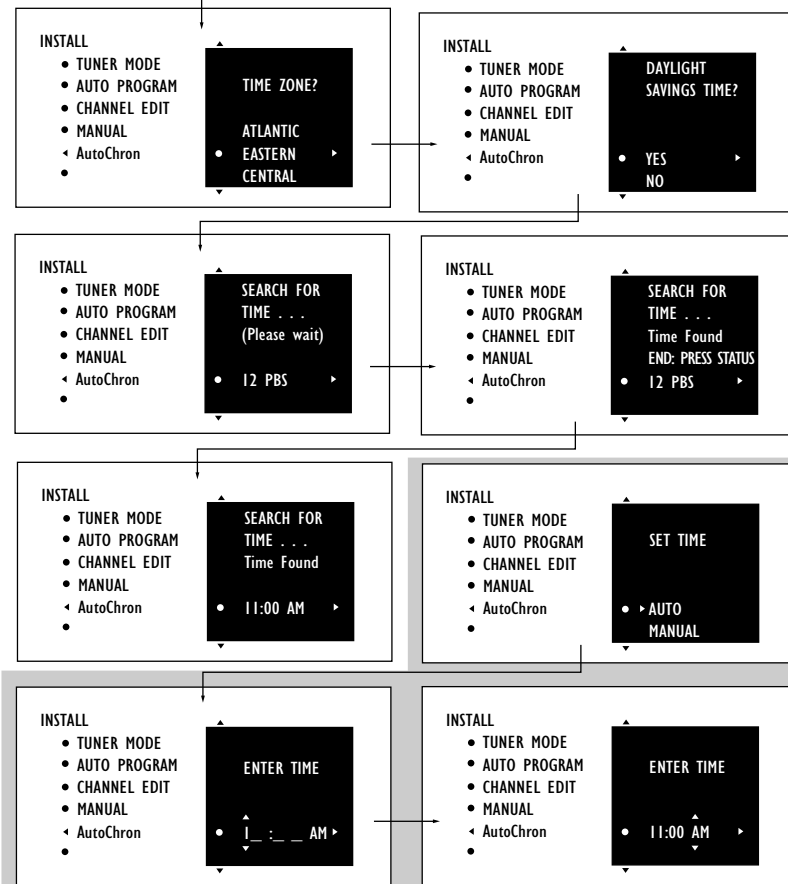

Setting AutoChron™ Manually

# HOW TO USE THE NAME CONTROL (CHANNEL LABEL)



The channel NAME feature allows you to list the “call” letters of your favorite stations beside their channel numbers when they appear on the screen. The TV has in memory a list of the 50 most popular channel names (for example, ABC, NBC, FOX, etc.). You also can enter a custom name (up to five characters).

Tune to a specific channel that you want to add a label to, then;

- 1** Press the **MENU** button on the remote control to show the onscreen menu.
- 2** Press the **CURSOR DOWN** button repeatedly until **INSTALL** in highlighted.
- 3** Press the **CURSOR RIGHT** button to shift the menu to the left. **LANGUAGE** will be highlighted.
- 4** Press the **CURSOR DOWN** button repeatedly until the **NAME** control is highlighted.
- 5** Press the **CURSOR RIGHT** button to highlight the **NAME** options area.
- 6** Press the **CURSOR RIGHT** button again; then press the **CURSOR UP** or **CURSOR DOWN** button to scroll through a list of options for the first character (A through Z, 0 through 9). Press the **CURSOR RIGHT** button and repeat for the second, third, fourth, and fifth characters
- 7** After you have selected a name for the channel, press the **MENU** button to save the name in the TV’s memory.
- 8** Press the **STATUS/EXIT** button to clear the menu from the screen.

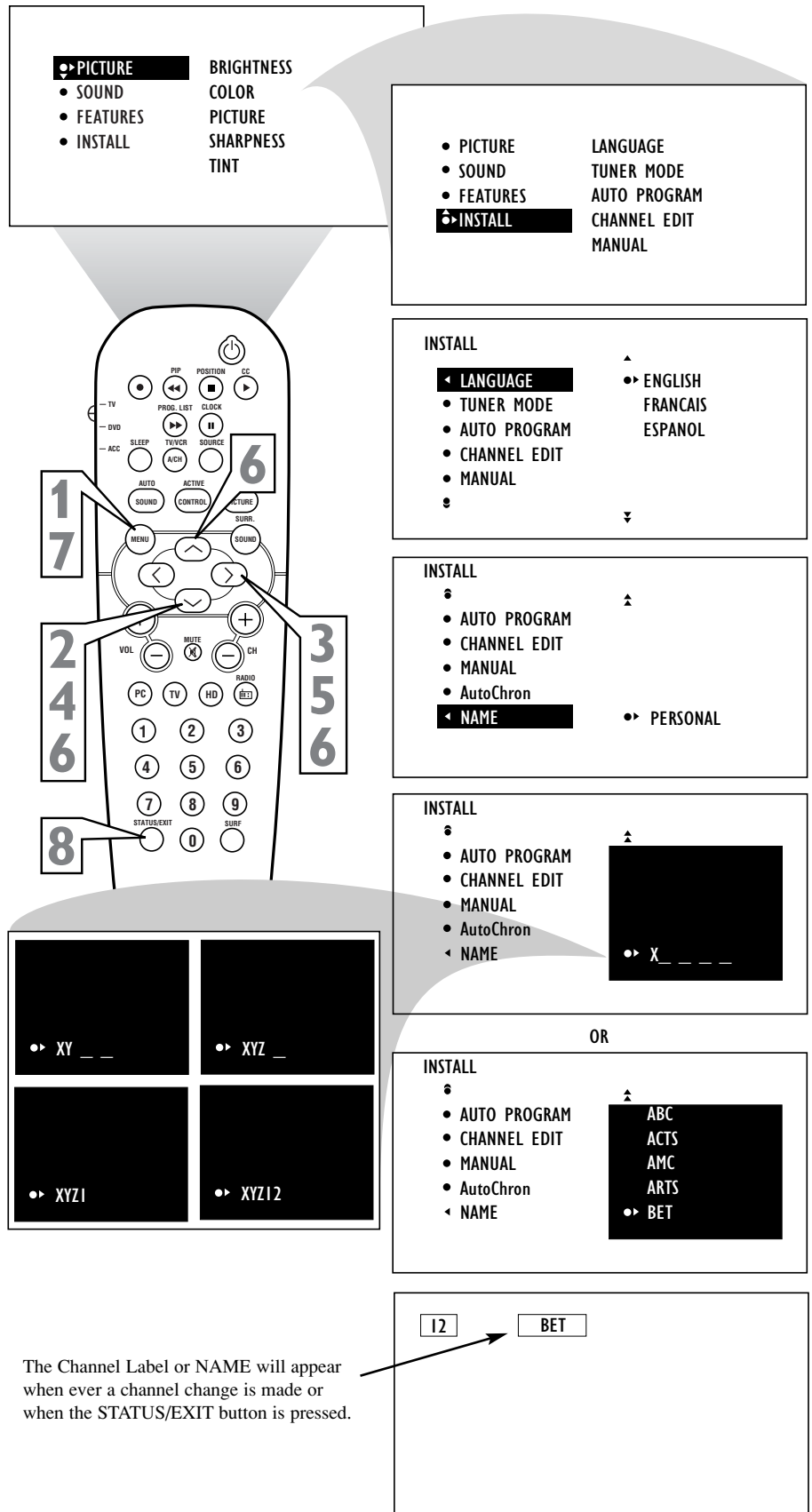

**HELPFUL HINT**  
The five characters that the channel NAME feature allows you to input can be letters, a dash character, or the numbers 0 through 9.

The Channel Label or NAME will appear when ever a channel change is made or when the STATUS/EXIT button is pressed.



# HOW TO USE THE PICTURE ADJUSTMENT CONTROLS

To adjust your TV picture controls, select a channel and follow these steps.

- 1** Press the **MENU** button on the remote control to show the onscreen menu. PICTURE will be highlighted.
- 2** Press the **CURSOR RIGHT** and the menu will shift to the left. BRIGHTNESS will be highlighted and an adjustment bar will be shown to the right.
- 3** Use the **CURSOR LEFT** or **RIGHT** to adjust the BRIGHTNESS level of the picture.
- 4** After adjusting the BRIGHTNESS control, press the **CURSOR DOWN** to select another picture adjustment: COLOR, PICTURE, SHARPNESS, TINT, COLOR TEMP, DNR, or CONTRAST +. Press the **CURSOR LEFT** or **RIGHT** to adjust the selected control.
- 5** Press the **STATUS/EXIT** button to remove the menu from the screen.

**NOTE:** The menu will show only five items at a time, so you will need to continue scrolling with the CURSOR DOWN to adjust the TINT, COLOR TEMP, DNR, or CONTRAST +.

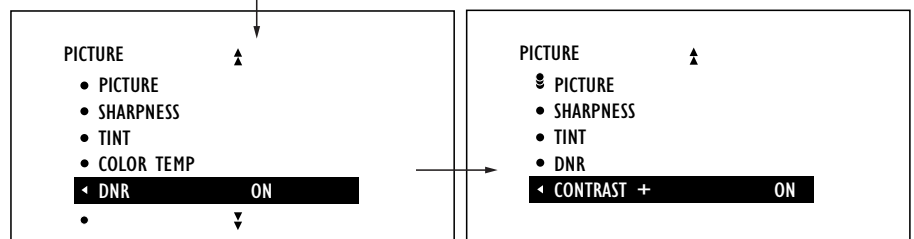
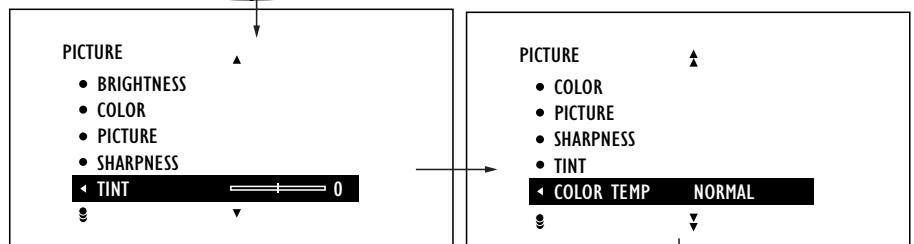
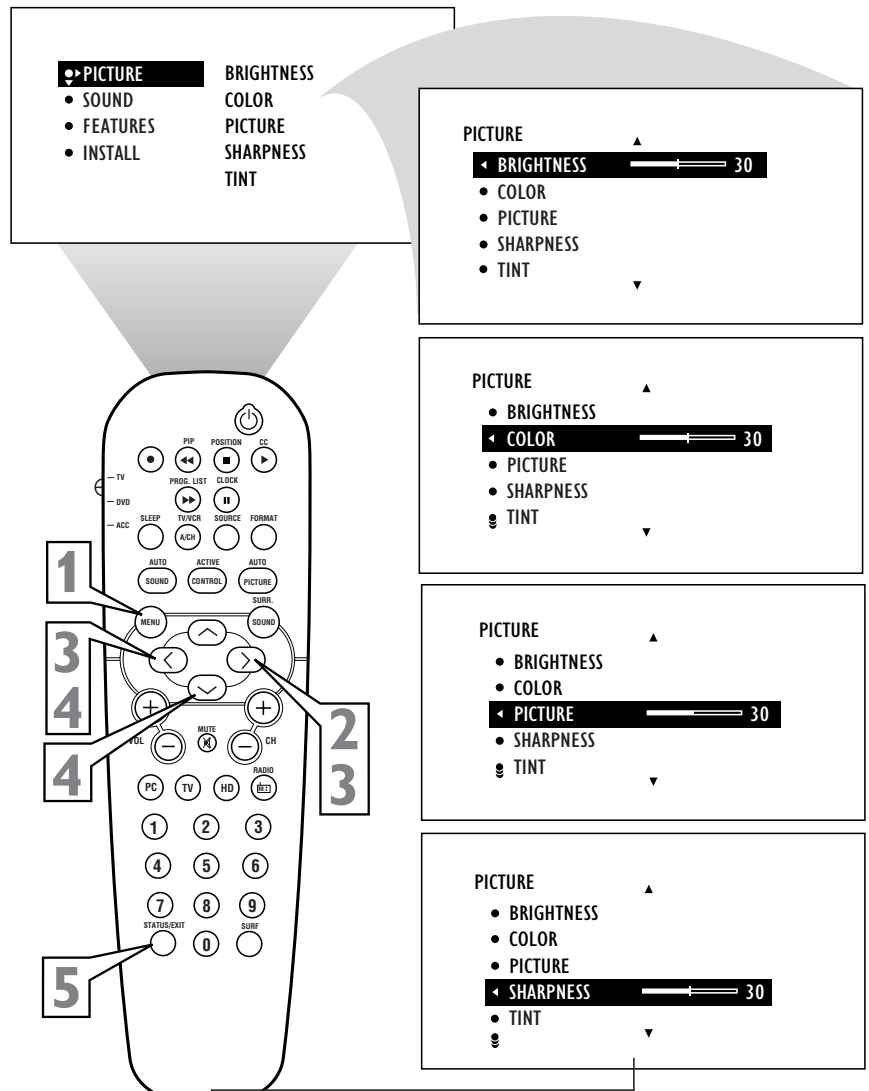

## HELPFUL HINT

Remember, when the bar scale is centered , the control settings are at normal, mid-range levels. Picture adjustments are described here.

**NOTE:** The SHARPNESS and TINT Controls will not be available for adjustments when tuned to the CVI Inputs (CVI Channel).

**BRIGHTNESS** – adds or subtracts light from the darkest part of the picture.

**COLOR** – adds or eliminates color.

**PICTURE** – improves the detail of the lightest parts of the picture.

**SHARPNESS** – improves the detail in the picture.

**TINT** – adjusts the picture to obtain natural skin tones.

**COLOR TEMP** – offers NORMAL (keeps whites, white), COOL (makes whites, bluish), or WARM (makes whites, reddish) picture preferences.

**DNR** – can help eliminate slightly “speckled” picture (an indication of signal noise in the picture).

**CONTRAST +** – helps to “sharpen” the picture quality. The black portions of the picture become richer in darkness and the whites become brighter.

# How to Use the EQUALIZER CONTROLS



The Equalizer Controls allow you to adjust the sound frequencies to suit the type of programming be watched.

- 1** Press the **MENU** button on the remote control to show the onscreen menu.
- 2** Press the **CURSOR DOWN** button repeatedly until **SOUND** in highlighted.
- 3** Press the **CURSOR RIGHT** button to shift the menu to the left. **EQUALIZER** will be highlighted.
- 4** Press the **CURSOR RIGHT** button to highlight the **EQUALIZER** options area.
- 5** Press the **CURSOR UP** or **DOWN** buttons to highlight any of the frequency options.
- 6** Press the **CURSOR RIGHT** or **LEFT** buttons to adjust the control slider to the level desired.
- 7** Once all the Equalizer controls have been set, press the **STATUS/EXIT** button to clear the menu from the screen.

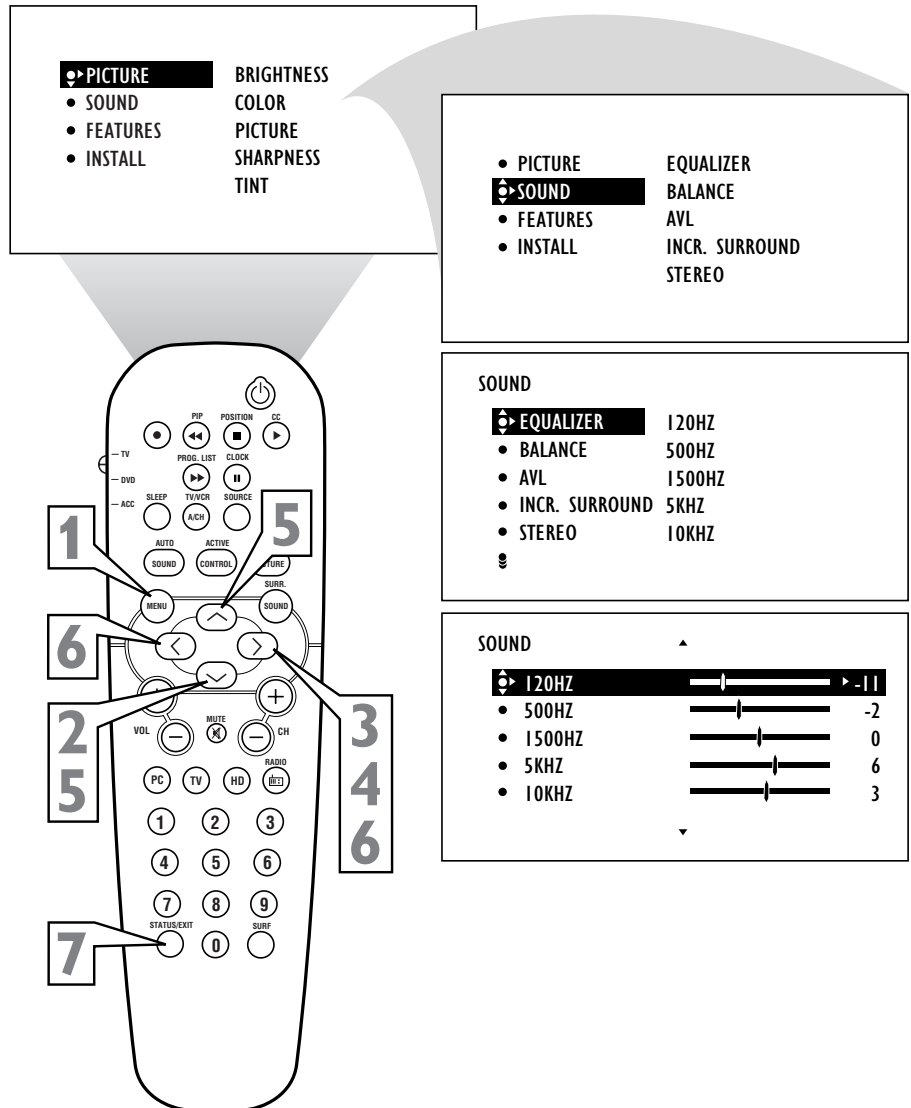



# How to Use the Balance Control

The Balance Control will allow you to adjust the sound levels between the right and left speaker output.

- 1** Press the **MENU** button on the remote control to show the onscreen menu. PICTURE will be highlighted.
- 2** Press the **CURSOR DOWN** button repeatedly until SOUND is highlighted.
- 3** Press the **CURSOR RIGHT** button to shift the menu to the left. EQUALIZER will be highlighted.
- 4** Press the **CURSOR DOWN** to highlight the BALANCE control.
- 5** Press **CURSOR RIGHT** or **LEFT** buttons to adjust the sound between the right and left speakers.
- 6** Press the **STATUS/EXIT** button to remove the menu from the screen.

## HELPFUL HINT

When the Balance Control slider is at a setting of "0", both left and right speakers should have equal sound level between them.

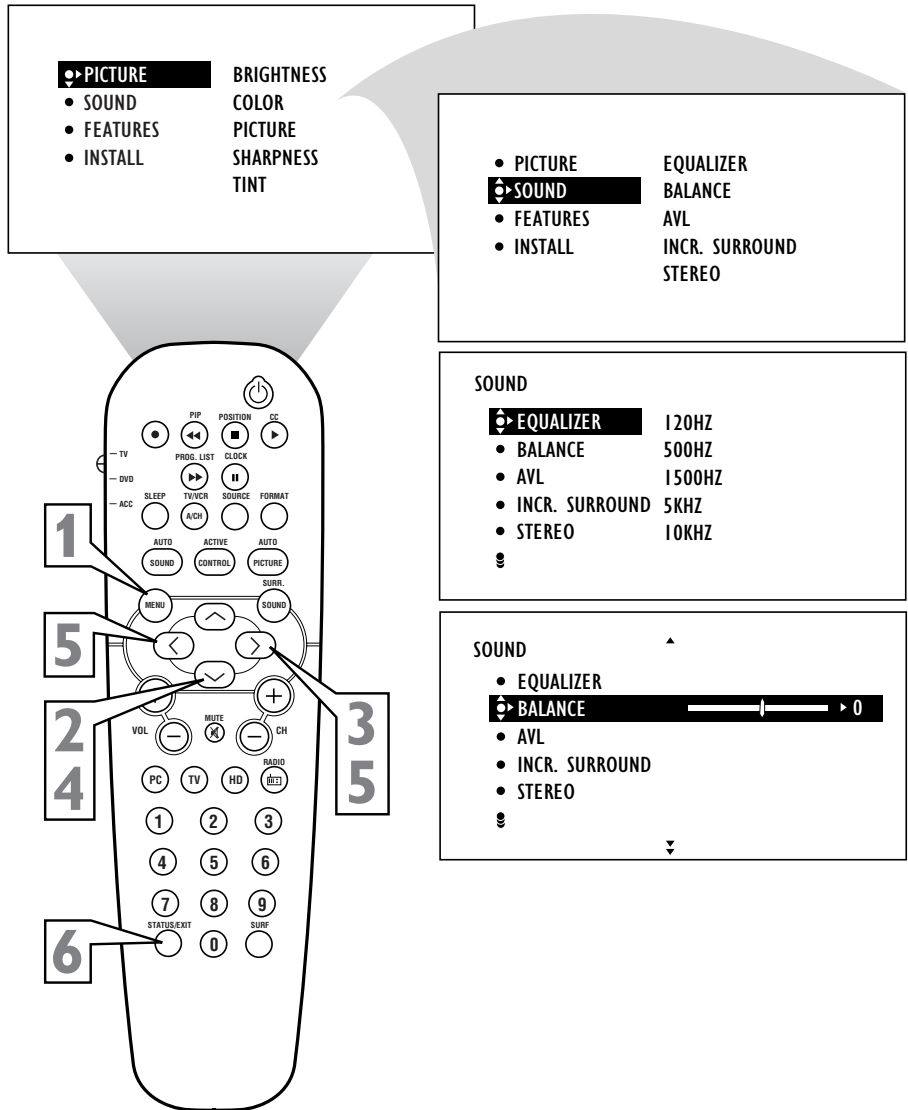

# HOW TO USE THE AVL CONTROL



*In most cases, the volume levels coming from broadcast programming or commercials are never the same. With the AVL (Audio Volume Leveler) control turned ON, you can have the TV level out sound that is being heard. This makes for a more consistent sound by reducing the peaks and valleys that occur during program changes or commercial breaks. To turn the AVL ON, follow these steps.*

- 1** Press the **MENU** button on the remote control to show the onscreen menu.
- 2** Press the **CURSOR DOWN** to highlight **SOUND**.
- 3** Press the **CURSOR RIGHT** and the menu will shift to the left. **EQUALIZER** will be highlighted and an adjustment bar will be shown to the right.
- 4** Press the **CURSOR DOWN** repeatedly until **AVL** is highlighted.
- 5** Press the **CURSOR RIGHT** or **LEFT** to toggle **AVL ON** or **OFF**.
- 6** Press the **STATUS/EXIT** button to remove the menu from the screen.

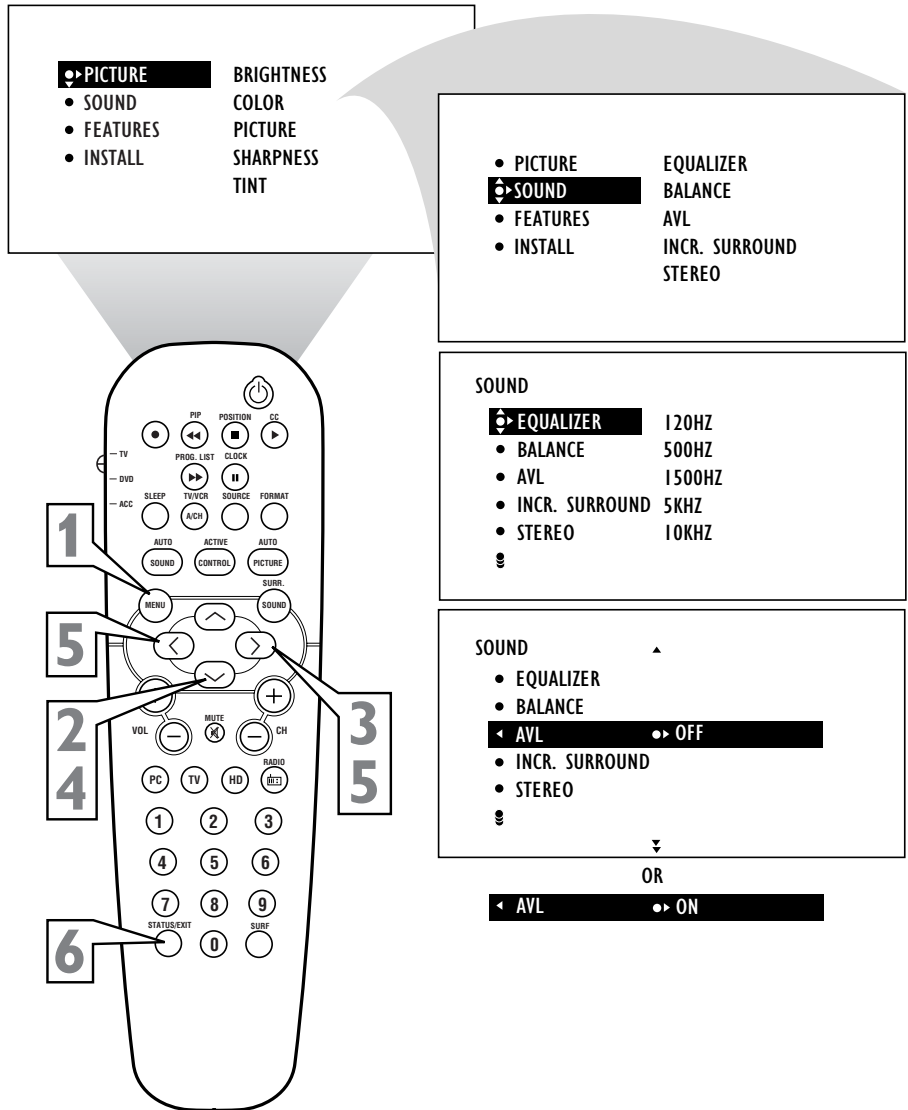



# HOW TO USE THE INCREDIBLE SURROUND CONTROL

The Incredible Surround feature adds greater depth and dimension to both monaural (MONO) and stereo TV sound. With the control set to INCR. SURROUND (Incredible Surround), the TV's speakers can add even wider sound separation to normal broadcasts.

- 1** Press the **MENU** button on the remote control to show the onscreen menu.
- 2** Press the **CURSOR DOWN** to highlight SOUND.
- 3** Press the **CURSOR RIGHT** and the menu will shift to the left. **EQUALIZER** will be highlighted and an adjustment bar will be shown to the right.
- 4** Press the **CURSOR DOWN** repeatedly until **INCR. SURROUND** is highlighted. (Incredible Surround)
- 5** Press the **CURSOR RIGHT** or **LEFT** to toggle the **INCR. SURROUND** control settings.
  - If signal is Stereo:** Select **STEREO**, or **INCR. SURROUND**.
  - If signal is MONO:** Select **MONO**, or **SPATIAL**.
- 6** Press the **STATUS/EXIT** button to remove the menu from the screen.
- 7** You can also change the **INCR. SURROUND** onscreen menu control settings by **pressing the SURR. (surround) SOUND button** on the remote control.

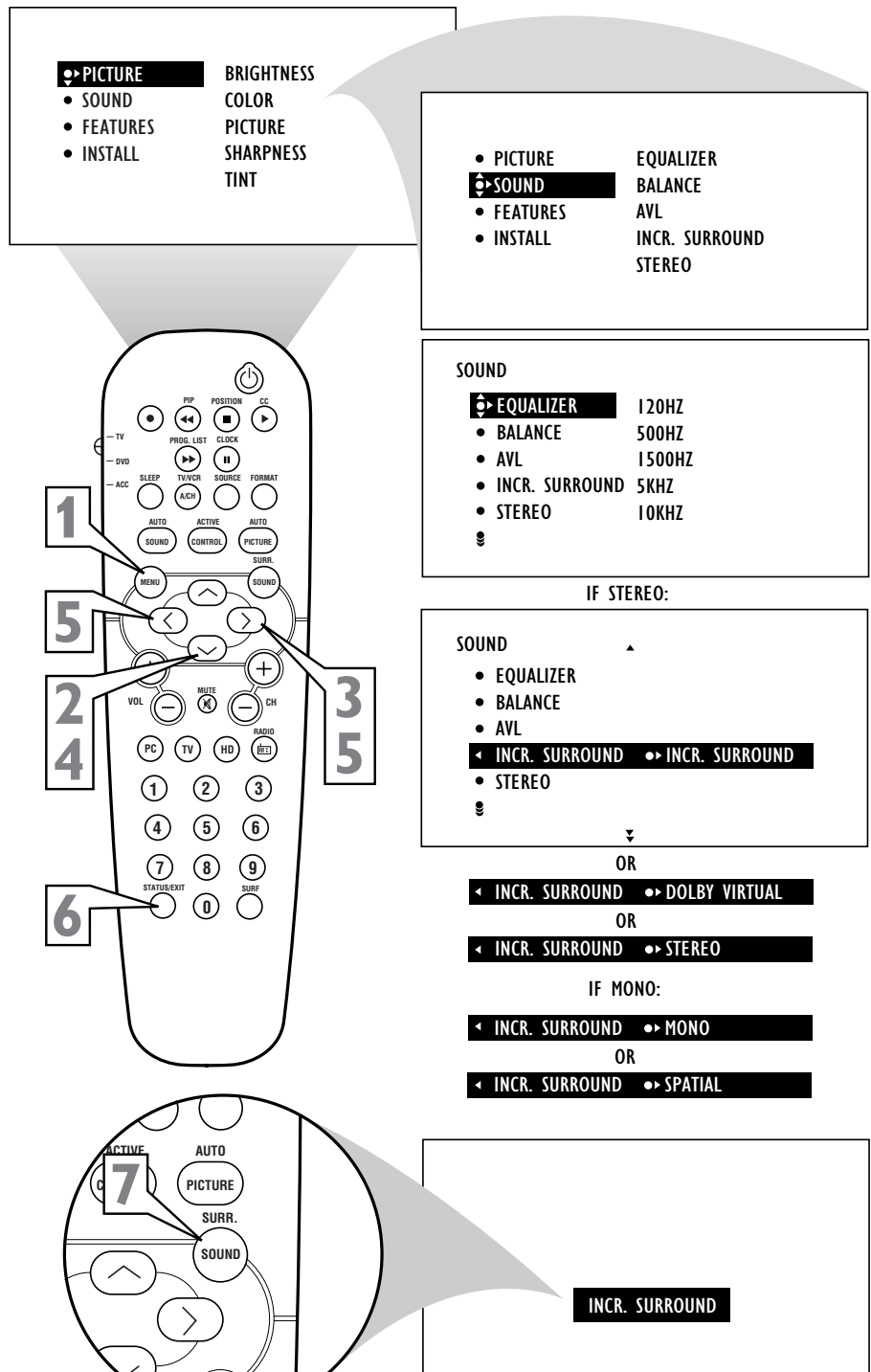

## HELPFUL HINT

**SPATIAL** – widens the sound, simulating a broader, fuller sound.

**INCR. SURROUND** – widens the sound, simulating a broader, fuller sound.

**DOLBY\* VIRTUAL (with Virtual Dolby Surround signals)** simulates the surround-sound experience from two speakers using Dolby Pro Logic\* providing the listener with the sensation of being surrounded by additional speakers.



# HOW TO SET THE TV TO RECEIVE STEREO PROGRAMMING



You can receive broadcast stereo TV programs. The TV has both an amplifier and twin speakers through which the stereo sound can be heard.

- 1** Press the **MENU** button on the remote control to show the onscreen menu.
- 2** Press the **CURSOR DOWN** to highlight **SOUND**.
- 3** Press the **CURSOR RIGHT** and the menu will shift to the left. **EQUALIZER** will be highlighted and an adjustment bar will be shown to the right.
- 4** Press the **CURSOR DOWN** repeatedly until **STEREO** is highlighted.
- 5** Press the **CURSOR RIGHT** or **LEFT** to toggle the **STEREO** control to Stereo or Mono.
- 6** Press the **STATUS/EXIT** button to remove the menu from the screen.

## HELPFUL HINT

Remember, if stereo is not present on a selected show and the TV is placed in the **STEREO** mode, the sound coming from the set will remain monaural.

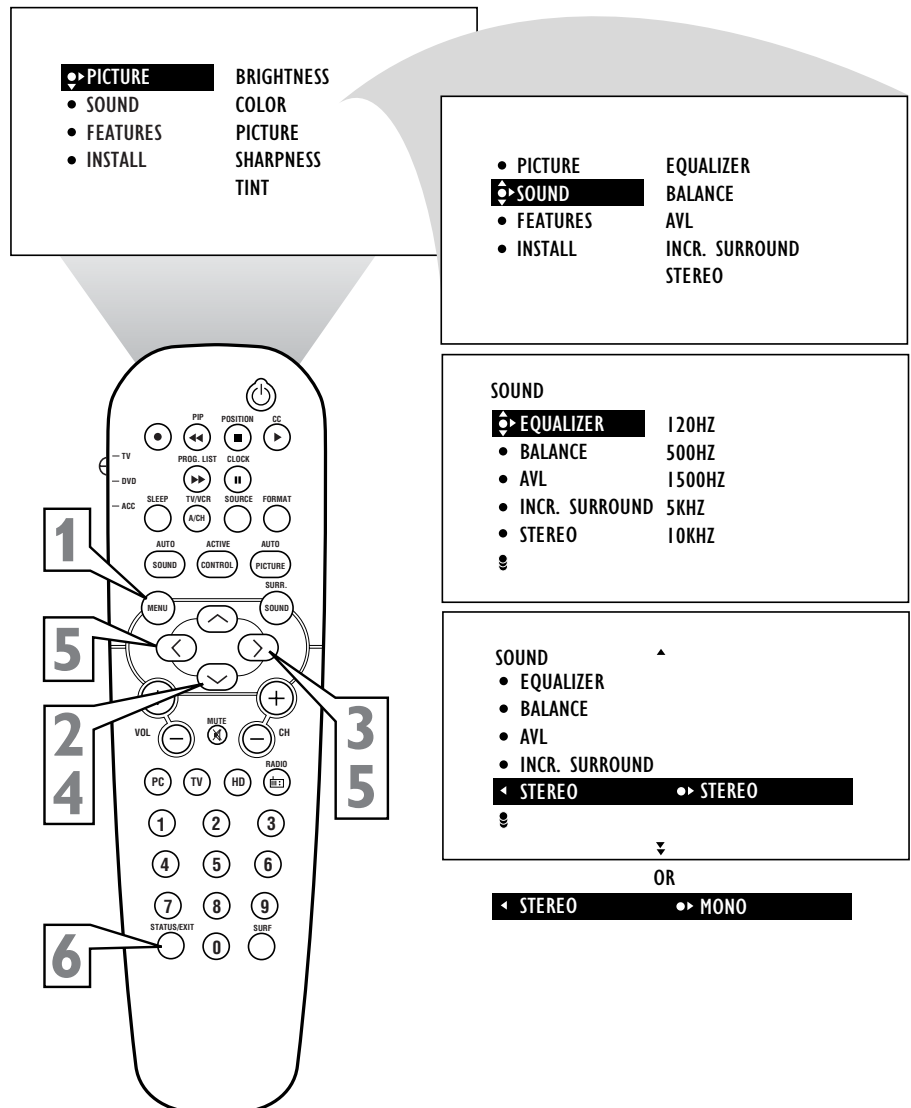



# How to Set the TV to Receive SAP (Secondary Audio Programming)

SAP is an additional part of the stereo broadcast system. Sent as a third audio channel, an SAP can be heard apart from the current TV program sound. TV stations are free to use SAP for any number of purposes.

- 1 Press the **MENU** button on the remote control to show the onscreen menu.
- 2 Press the **CURSOR DOWN** to highlight **SOUND**.
- 3 Press the **CURSOR RIGHT** and the menu will shift to the left. **EQUALIZER** will be highlighted and an adjustment bar will be shown to the right.
- 4 Press the **CURSOR DOWN** repeatedly until **SAP** is highlighted.
- 5 Press the **CURSOR RIGHT** or **LEFT** to toggle the SAP control to On or Off.

**Note:** If SAP is not broadcasted on the selected program your watching, **NOT AVAILABLE** will appear in the onscreen menu option.

- 6 Press the **STATUS/EXIT** button to remove the menu from the screen.

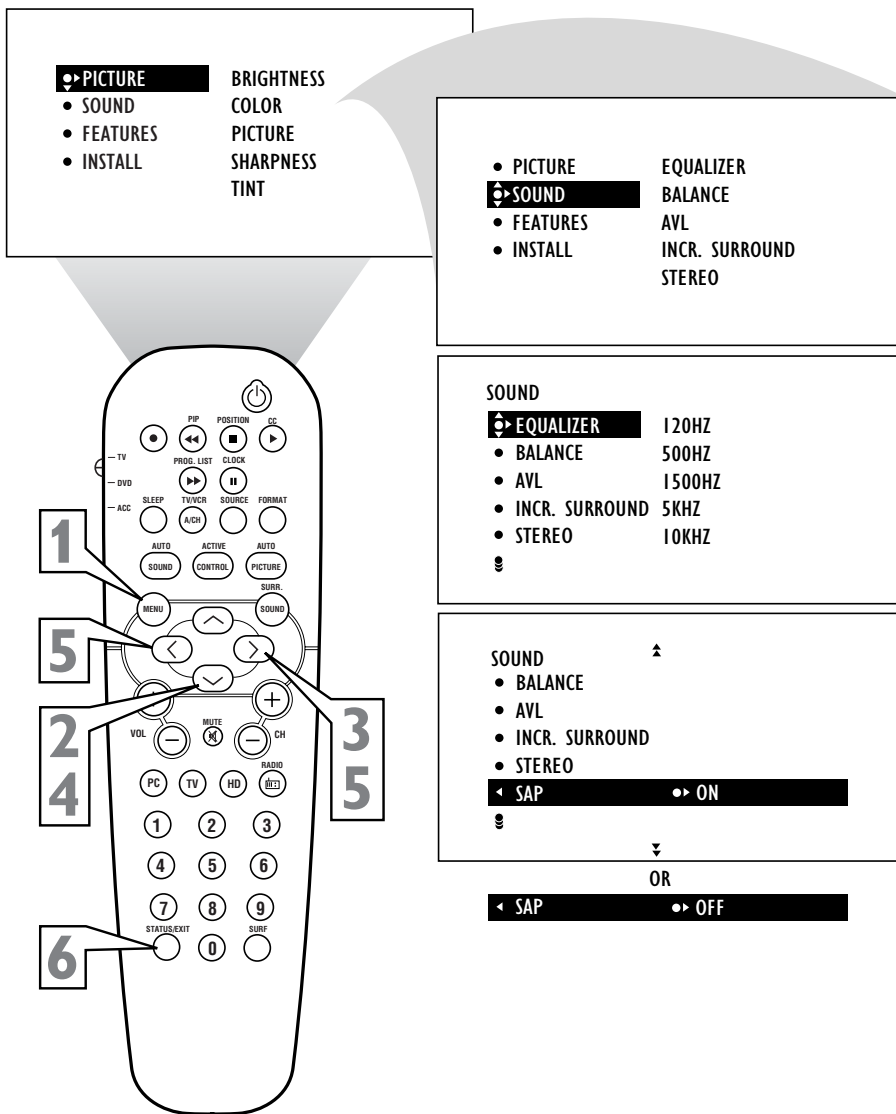

## HELPFUL HINT

If an SAP signal is not present with a selected program, the SAP option cannot be selected. Also, if SAP is selected on a channel (with SAP) and you select another channel, when you return to the original channel, SAP will be OFF. You will have to reselect the SAP feature.



If you have connected the TV's AUDIO OUTPUT jacks to the AUDIO INPUT jacks on a stereo receiver (see the Quick Use Guide for connection instructions), set AUDIO OUT to either VARIABLE or FIXED to determine whether you adjust the volume at the stereo or at the TV. If you select VARIABLE, change the volume at the TV using the TV's remote control. If you select FIXED, adjust the volume at the stereo using the stereo's controls. To select FIXED or VARIABLE, follow these steps.

- 1 Press the **MENU** button on the remote control to show the onscreen menu.
- 2 Press the **CURSOR DOWN** to highlight **SOUND**.
- 3 Press the **CURSOR RIGHT** and the menu will shift to the left. **EQUALIZER** will be highlighted and an adjustment bar will be shown to the right.
- 4 Press the **CURSOR DOWN** repeatedly until **AUDIO OUT** is highlighted.
- 5 Press the **CURSOR RIGHT** or **LEFT** to toggle the **AUDIO OUT** control to Fixed or Variable.
- 6 Press the **STATUS/EXIT** button to remove the menu from the screen.

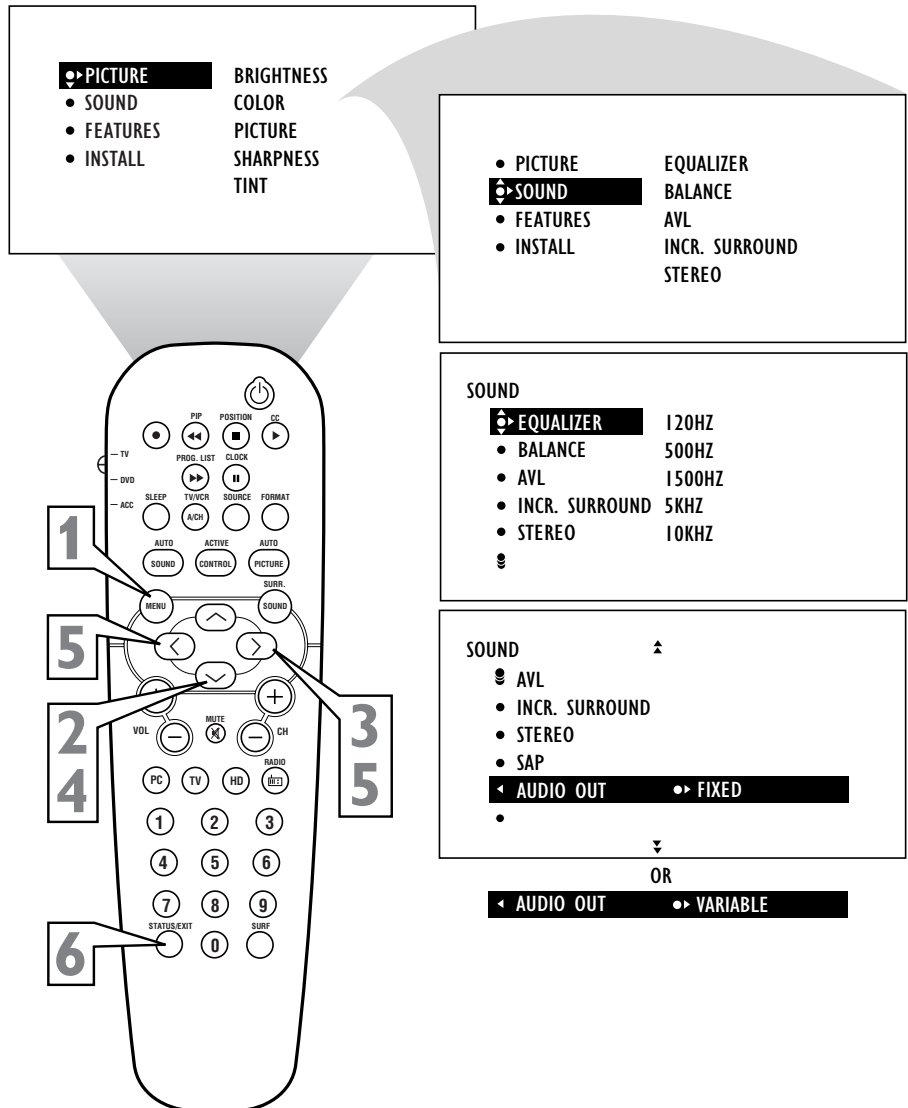

## HELPFUL HINT

**FIXED** – If **FIXED** is selected, the sound coming from the TV and being heard through an external audio system is not adjustable with the television's volume controls. The volume would have to be adjusted at the audio system.

**VARIABLE** – If **VARIABLE** is selected, the sound coming from the TV and being heard through an external audio system can be adjusted at the TV using the Volume + or – buttons on the television or remote control.

The connection instructions for an external audio system can be found in the Quick Use Guide supplied with your TV.



# HOW TO TURN THE TV SPEAKERS ON OR OFF

Using the TV's Audio (Monitor) Output jacks or the External Speaker connections, the TV speakers can be turned off allowing the television sound to be heard only from the external audio system or the external speakers.

- 1** Press the **MENU** button on the remote control to show the onscreen menu.
- 2** Press the **CURSOR DOWN** to highlight **SOUND**.
- 3** Press the **CURSOR RIGHT** and the menu will shift to the left. **EQUALIZER** will be highlighted and an adjustment bar will be shown to the right.
- 4** Press the **CURSOR DOWN** repeatedly until **TV SPEAKERS** is highlighted.
- 5** Press the **CURSOR RIGHT** or **LEFT** to toggle the **TV SPEAKERS** On or Off.
- 6** Press the **STATUS/EXIT** button to remove the menu from the screen.

## HELPFUL HINT

Be sure to first refer to the Quick Use Guide supplied with your TV to connect an external audio system to the television's Monitor Output (audio) jacks.

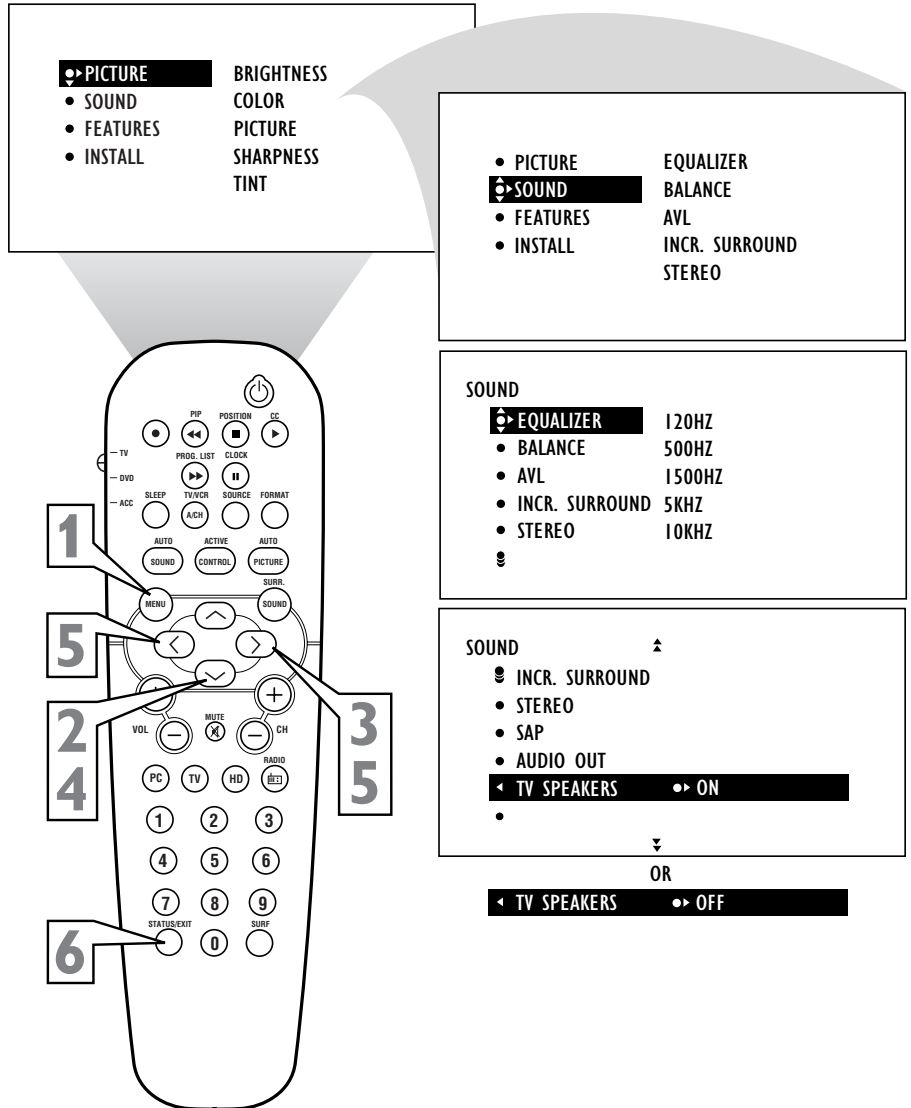

# HOW TO USE THE TIMER CONTROLS



Your television comes with an on-screen clock. The TV also can be set to turn on or off at a specific time and tune to a specific channel when it powers its self on.

- 1** Press the **CLOCK** button on the remote control to show the **TIMER** onscreen menu.
- 2** Press the **CURSOR RIGHT** button and the **TIMER** options will shift to the left. **TIME** will be highlighted.
- 3** Press the **CURSOR UP** or **DOWN** buttons repeatedly to highlight one of the **TIMER** controls. These controls are the **TIME**, **START TIME**, **STOP TIME**, **CHANNEL**, **ACTIVATE**, or **DISPLAY**.
- 4** Press the **CURSOR RIGHT** or **LEFT** button to make adjustments or set the control options.

**TIME:** Enter the current time with the numbered buttons. Use the Cursor Right button to move to the AM/PM area and use the Cursor Left and Right buttons to toggle AM or PM.

**START TIME:** Use the Numbered buttons to enter a start-up time for the TV to turn on or tune a specific channel.

**STOP TIME:** Use the Numbered buttons to enter a time for the TV to shut itself off.

**CHANNEL:** Use the Numbered buttons or the CH + or – buttons to select a specific channel for the TV to tune to at the specific Start Time.

**ACTIVATE:** Set the Timer to perform its function **ONCE** or **DAILY**.

**DISPLAY:** Set to **ON** or **OFF**. When **ON**, the time will be displayed **ALL** the time the TV is **ON**. When **OFF**, the time will only appear when the **STATUS/EXIT** button is pressed.

- 5** Press the **STATUS/EXIT** button to remove the menu from the screen.

FEATURES  
TIMER  
◀ TIME ▶ 12:03AM

- START TIME
- STOP TIME
- CHANNEL
- ACTIVATE
-

FEATURES  
TIMER  
• TIME  
◀ START TIME ▶ --|--

- STOP TIME
- CHANNEL
- ACTIVATE
-

FEATURES  
TIMER  
• TIME  
• START TIME  
◀ STOP TIME ▶ --|--

- CHANNEL
- ACTIVATE
-

FEATURES  
TIMER  
• TIME  
• START TIME  
• STOP TIME  
◀ CHANNEL ▶ 8

- ACTIVATE
-

FEATURES  
TIMER  
• TIME  
• START TIME  
• STOP TIME  
• CHANNEL  
◀ ACTIVATE ▶ OFF

OR

◀ ACTIVATE ▶ ON

FEATURES  
TIMER  
• START TIME  
• STOP TIME  
• CHANNEL  
• ACTIVATE  
◀ DISPLAY ▶ OFF

OR

◀ DISPLAY ▶ ON



# How to Use the Mode Select Control

The Mode Select Control will allow you to use set the TV into the TV, FM, HD, or PC Modes. Depending on how the TV will be used, these modes may have their own onscreen menus controls to optimize there use when used with computers, radios, or high-definition receivers.

- 1** Press the **MENU** button on the remote control to show the onscreen menu.
- 2** Press the **CURSOR DOWN** to highlight FEATURES.
- 3** Press the **CURSOR RIGHT** and the menu will shift to the left. **TIMER** will be highlighted.
- 4** Press the **CURSOR DOWN** repeatedly until **MODE SELECT** is highlighted.
- 5** Press the **CURSOR RIGHT** button to shift the menu to the left. the first option, **FM RADIO** will be highlighted.
- 6** Press the **CURSOR UP or DOWN** buttons to highlight the desired mode option (**FM RADIO**, **HD**, or **PC**).
- 7** Press the **CURSOR RIGHT** button to change the TV to the desired mode. Please refer to each specific mode later in this manual.
- 8** Press the **STATUS/EXIT** button to remove the menu from the screen.

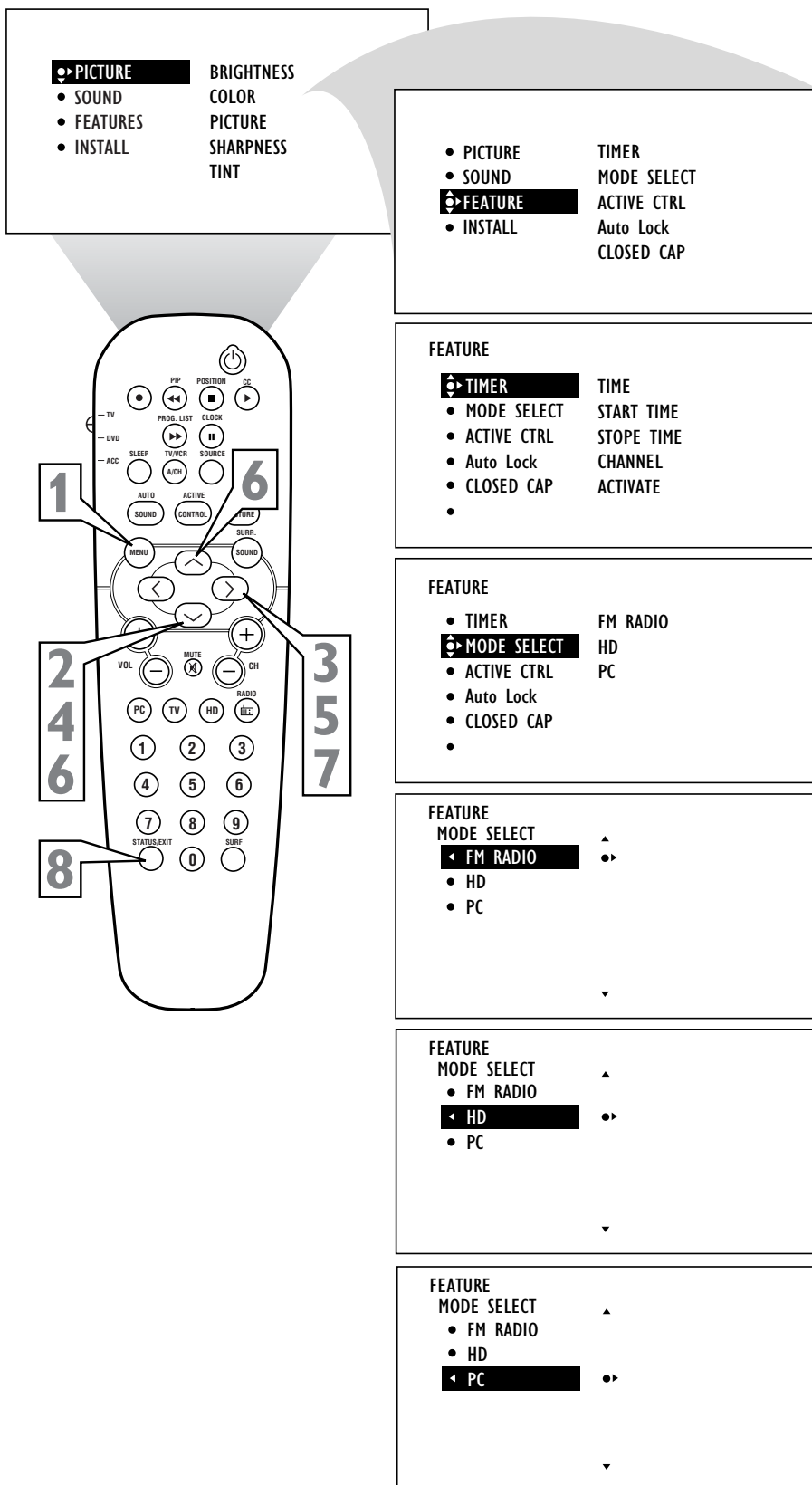

## HELPFUL HINT

Specific information regarding each of the **MODE SELECT** options can be found later in this manual.

**FM RADIO** - refer to page 46-49.

**HD** - refer to page 50-53.

**PC** - refer to page 54.

# HOW TO SET THE ACTIVE CONTROL



The Active Control monitors and adjusts incoming video signals to help provide the best picture quality.

When you choose to turn the Active Control ON, the picture sharpness and noise reduction are controlled automatically. Active Control adjusts these picture settings continuously and automatically.

- 1** Press the **MENU** button on the remote control to show the onscreen menu.
  - 2** Press the **CURSOR DOWN** to highlight FEATURES.
  - 3** Press the **CURSOR RIGHT** and the menu will shift to the left. **TIMER** will be highlighted.
  - 4** Press the **CURSOR DOWN** repeatedly until **ACTIVE CTRL** (control) is highlighted.
  - 5** Press the **CURSOR RIGHT** button repeatedly to toggle the control options. Choose from: **ON**, **ON + DISPLAY**, or **OFF**
  - 6** Press the **STATUS/EXIT** button to remove the menu from the screen.
- 7** You can also press the **ACTIVE CONTROL** button on the remote control to toggle the **ACTIVE CONTROL ON**, **ON + DISPLAY**, or **OFF** directly.

**PICTURE**

- SOUND
- FEATURES
- INSTALL

**BRIGHTNESS**

**COLOR**

**PICTURE SHARPNESS**

**TINT**

- PICTURE
- SOUND
- FEATURE**
- INSTALL

**TIMER**

**MODE SELECT**

**ACTIVE CTRL**

AutoLock

CLOSED CAP

**FEATURES**

**TIMER**

- MODE SELECT
- ACTIVE CTR
- AutoLock
- CLOSED CAP
- 

**TIME**

START TIME

STOP TIME

CHANNEL

ACTIVATE

**FEATURES**

- TIMER
- MODE SELECT
- ACTIVE CTRL**    **• OFF**
- Auto Lock
- CLOSED CAP
- 

OR

**• ACTIVE CTRL**    **• ON**

OR

**• ACTIVE CTRL**    **• ON + DISPLAY**

**ACTIVE CONTROL**

**SHARPNESS**    45

**NOISE REDUCTION**    38

**BLACK EXPANDER**    ON

**WHITE EXPANDER**    OFF

## HELPFUL HINT

Toggle the **ACTIVE CONTROL** to **ON + DISPLAY** with the remote control and a screen display will appear showing the Active Control in work. You will see the sharpness and noise reduction settings changing to provide the best possible picture quality.

When **ACTIVE CONTROL** is set to **ON + DISPLAY**, this screen will be displayed briefly whenever a channel change occurs.



# UNDERSTANDING THE AUTOLOCK™ CONTROLS

The AutoLock™ feature receives and processes data sent by broadcasters or other program providers that contain program content advisories. When programmed by the viewer, a TV with AutoLock™ can respond to the content advisories and block program content that may be found objectionable (such as offensive language, violence, sexual situations, etc.). This is a great feature to censor the type of programming children may watch.

In the AutoLock™ section, you'll learn how to block channels and programming that is not rated, is unrated, or has no rating. You will also find out how to turn these blocking features ON or OFF. Following are brief explanations of some terms and ratings related to the AutoLock™ feature.

## AutoLock™ offers various Blocking Options from which to choose:

**BLOCKING:** The BLOCKING control is what can be thought of as the “master switch” for AutoLock™. This control affects the settings you have chosen for blocking programs according to movie ratings or TV ratings, or for blocking programs that have no rating or are unrated. When the BLOCKING control is OFF, the blocking or censoring of programs is disabled. When the BLOCKING control is ON, blocking will occur according to the settings you have chosen.

**NO RATING:** ALL programming with no content advisory data can be blocked if NO RATING is set to ON.

*Programming that has No Rating is not encoded with any rating information from the MPAA or the Parental Guidelines. Any programming could fall into this category.*

**You also can block individual channels or block programming** based on ratings of the MPAA and TV broadcasters. (See a description of the ratings on this page.)

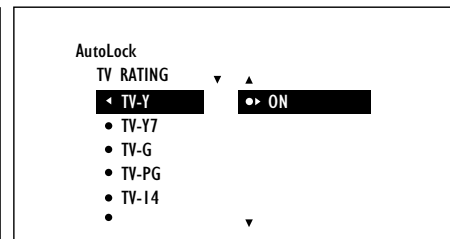
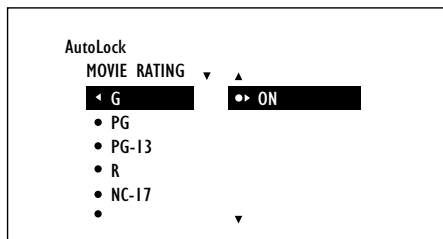

## MOVIE RATINGS

(MOTION PICTURE ASSOCIATION OF AMERICA)

**G: General Audience** - All ages admitted. Most parents would find this programming suitable for all ages. This type of programming contains little or no violence, no strong language, and little or no sexual dialogue or sexual situations.

**PG: Parental Guidance Suggested** - This programming contains material that parents may find unsuitable for younger children. It may contain one or more of the following: Moderate violence, some sexual situations, infrequent coarse language, or some suggestive dialogue.

**PG-13: Parents Strongly Cautioned** - This programming contains material that parents may find unsuitable for children under the age of 13. It contains one or more of the following: violence, sexual situations, coarse language, or suggestive dialogue.

**R: Restricted** - This programming is specifically designed for adults. Anyone under the age of 17 should view this programming only with an accompanying parent or adult guardian. It contains one or more of the following: intense violence; intense sexual situations; strong, coarse language; or intensely suggestive dialogue.

**NC-17: No one under the age of 17 will be admitted.** - This type of programming should be viewed by adults only. It contains graphic violence; explicit sex; or crude, indecent language.

**X: Adults Only** - This type of programming contains one or more of the following: very graphic violence, very graphic and explicit or indecent sexual acts, very coarse and intensely suggestive language.

## TV PARENTAL GUIDELINES

(TV BROADCASTERS)

**TV Y: TV-Y: (All children -- This program is designed to be appropriate for all children.)** Designed for a very young audience, including children ages 2-6. This type of programming is not expected to frighten younger children.

**TV Y7: TV-Y7: (Directed to Older Children -- This program is designed for children ages 7 and above.)** It may be more appropriate for children who have acquired the development skills needed to distinguish between make-believe and reality. This programming may include mild fantasy and comic violence (FV).

**TV G: TV-G: (General Audience -- Most parents would find this program suitable for all ages.)** This type of programming contains little or no violence, no strong language, and little or no sexual dialogue or sexual situations.

**TV PG: TV-PG: (Parental Guidance Suggested -- This program contains material that parents may find unsuitable for younger children.)** This type of programming contains one or more of the following: Moderate violence (V), some sexual situations (S), infrequent coarse language (L), or some suggestive dialogue (D).

**TV 14: TV-14: (Parents Strongly Cautioned - This program contains some material that many parents would find unsuitable for children under 14 years of age.)** This type of programming contains one or more of the following: intense violence (V); intense sexual situations (S); strong, coarse language (L); or intensely suggestive dialogue (D).

**TV MA: TV-MA: (Mature Audience Only -- This program is specifically designed to be viewed by adults and therefore may be unsuitable for children under 17.)** This type of programming contains one or more of the following: graphic violence (V); explicit sexual situations (S); or crude, indecent language (L).



# SETTING UP THE AUTOLOCK™ ACCESS CODE



**A**utoLock™ allows parents to block out or “censor” any channels they think children should not watch. A channel blocked by the AutoLock™ control cannot be viewed until a correct access code is used to unlock the channel for viewing. First, let’s set your AutoLock access code.

- 1** Press the **MENU** button on the remote control to show the onscreen menu.
- 2** Press the **CURSOR DOWN** button to highlight **FEATURES**.
- 3** Press the **CURSOR RIGHT** button and the menu will shift to the left. **TIMER** will be highlighted.
- 4** Press the **CURSOR DOWN** button repeatedly until **AutoLock** is highlighted.
- 5** Press the **CURSOR RIGHT** button to highlight **ACCESS CODE**.
- 6** Press **0,7,1,1** on the remote control. **INCORRECT** will appear on the screen.
- 7** Press **0,7,1,1** on the remote control again. **ENTER NEW CODE** will appear on the screen.
- 8** Enter a new four-digit code using the number buttons. **CONFIRM CODE** will appear on the screen.
- 9** Enter your new four-digit code again. **CORRECT** will flash on the screen briefly and the highlight bar goes back to **AutoLock**.
- 10** Press the **STATUS/EXIT** button to remove the menu from the screen.

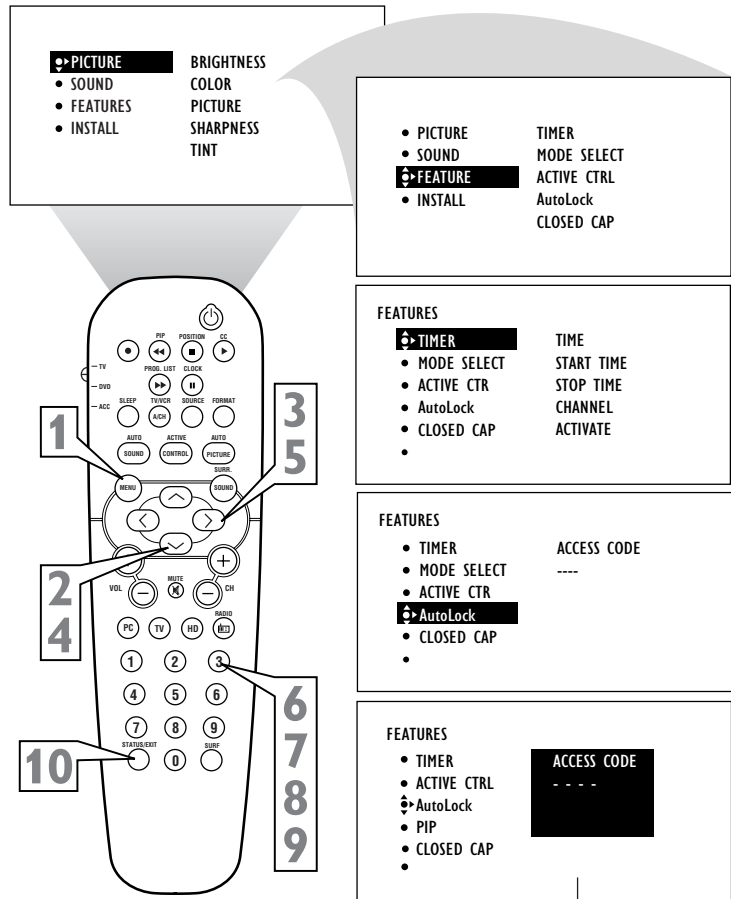

## HELPFUL HINT

Remember that 0711 is the default AutoLock™ code. If your access code has been changed by someone other than you (a child, for example) or you have forgotten the code, you can always get in by inputting the default code.

**NOTE TO PARENTS:** It isn’t possible for your child to unblock a channel without knowing your access code or changing it to a new one. If your code has been changed without your knowledge, then you will become aware that blocked channels may have been viewed.



# How to BLOCK CHANNELS USING AUTOLOCK™

After your personal access code has been set (see the previous page), you are ready to select the channels or inputs you want to block out or censor.

- 1** Press the **MENU** button on the remote control to show the onscreen menu.
- 2** Press the **CURSOR DOWN** button to highlight **FEATURES**.
- 3** Press the **CURSOR RIGHT** button and the menu will shift to the left. **TIMER** will be highlighted.
- 4** Press the **CURSOR DOWN** button repeatedly until **AutoLock** is highlighted.
- 5** Press the **CURSOR RIGHT** button to highlight **ACCESS CODE**.
- 6** Enter your four-digit **ACCESS CODE**. **CORRECT** will flash very briefly and the menu will move to the left with **BLOCK CHANNEL** highlighted.
- 7** Press the **CURSOR RIGHT** button to highlight the TV's available channels.
- 8** Press the **CURSOR UP** or **DOWN** button to highlight the channel you want to block.
- 9** Press the **CURSOR RIGHT** button to block the channel. A padlock image appears to the right of the channel number.

Repeat steps 7 and 8 for any channels you want to block from viewing.

- 10** Press the **STATUS/EXIT** button to remove the menu from the screen.

## HELPFUL HINT

Remember that 0711 is the default AutoLock™ code. If your access code has been changed by someone other than you (a child, for example) or you have forgotten the code, you can always get in by inputting the default code.

**NOTE:** You also can block out the use of the A/V external inputs on the rear of the TV. This stops the viewing of VCR, DVD, and other sources that can be shown through the A/V input jacks.

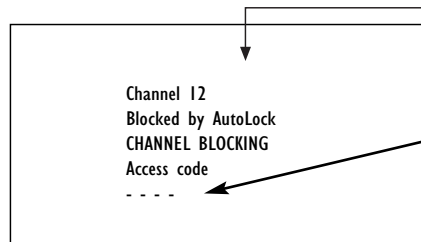
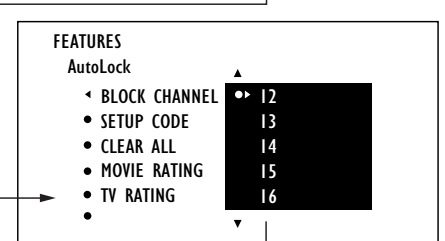
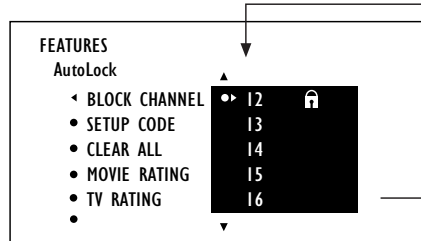
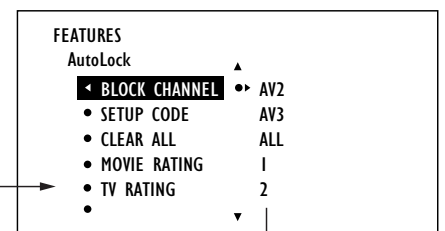
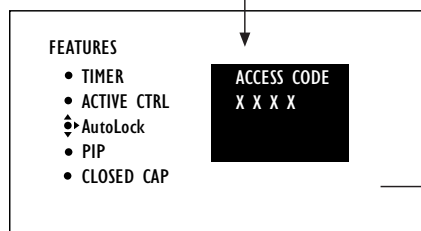
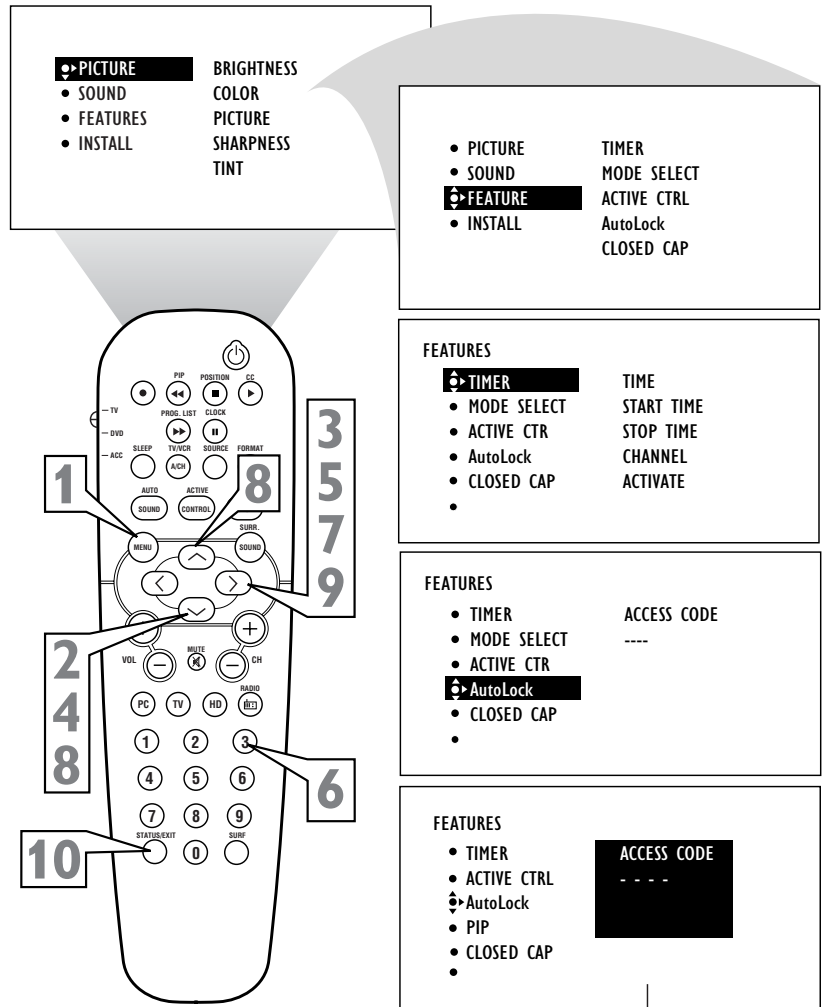

If a channel is blocked by the **BLOCK CHANNEL** option, the TV will display the screen shown to the right. To watch the channel, enter your access code or change the **BLOCK CHANNEL** option back to off.

# HOW TO CLEAR ALL BLOCKED CHANNELS AT THE SAME TIME



Various onscreen messages will appear when someone tries to view blocked programming. The message is determined by how the current programming is blocked. You may view the blocked programming and turn OFF the AutoLock™ feature by using the Clear All control or by entering your access code

- 1** Press the **MENU** button on the remote control to show the onscreen menu.
- 2** Press the **CURSOR DOWN** button to highlight **FEATURES**.
- 3** Press the **CURSOR RIGHT** button and the menu will shift to the left. **TIMER** will be highlighted.
- 4** Press the **CURSOR DOWN** button repeatedly until **AutoLock** is highlighted.
- 5** Press the **CURSOR RIGHT** button to highlight **ACCESS CODE**.
- 6** Enter your four-digit **ACCESS CODE** and the menu will move to the left with **BLOCK CHANNEL** highlighted.
- 7** Press the **CURSOR DOWN** button until **CLEAR ALL** is highlighted.
- 8** Press the **CURSOR RIGHT** twice. The **CLEAR ALL** option will display the word **CLEARED**. All blocked channels and programming are now viewable.
- 9** Press the **STATUS/EXIT** button to remove the menu from the screen.

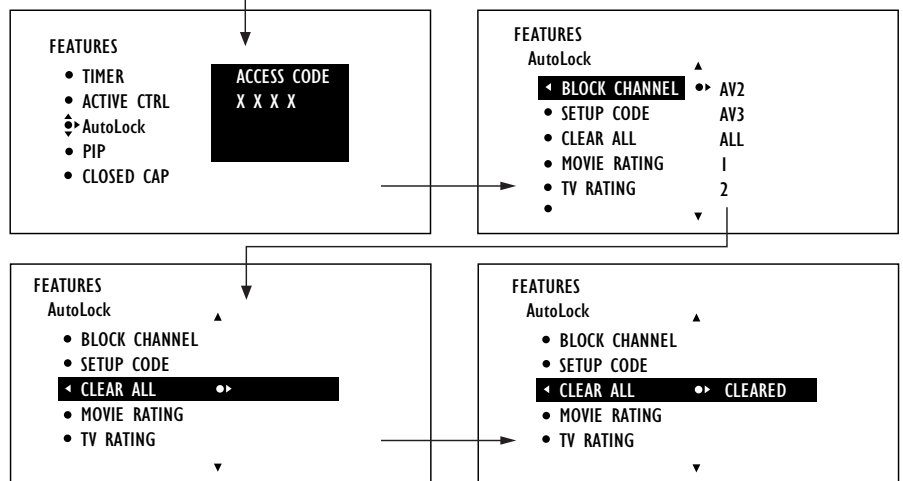
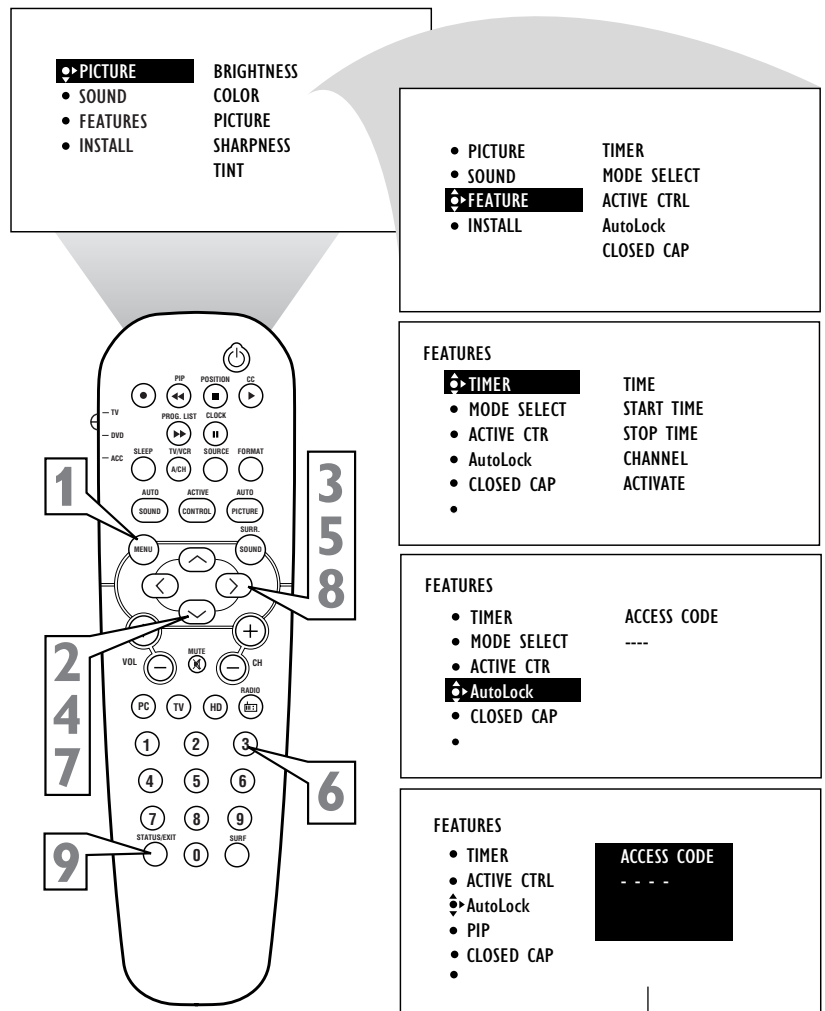

## HELPFUL HINT

If you tune to a specific channel that has been blocked by **BLOCK CHANNEL** or any of the **AutoLock™ RATING** options, simply enter your four-digit access code to view the channel.

**NOTE:** This will unblock ALL channels until the TV is shut OFF. When powered back ON, all previously blocked channels will be blocked again.



# BLOCKING PROGRAMS BASED ON MOVIE RATINGS

After your personal access code has been set, you can select specific movie ratings that you want to censor.

- 1** Press the **MENU** button on the remote control to show the onscreen menu.
- 2** Press the **CURSOR DOWN** button to highlight **FEATURES**.
- 3** Press the **CURSOR RIGHT** button and the menu will shift to the left. **TIMER** will be highlighted.
- 4** Press the **CURSOR DOWN** button repeatedly until **AutoLock** is highlighted.
- 5** Press the **CURSOR RIGHT** button to highlight **ACCESS CODE**.
- 6** Enter your four-digit **ACCESS CODE**. **CORRECT** will flash very briefly and the menu will move to the left with **BLOCK CHANNEL** highlighted.
- 7** Press the **CURSOR DOWN** repeatedly until **MOVIE RATING** is highlighted.
- 8** Press the **CURSOR RIGHT** and the Rating menu shifts to the left with **G** highlighted.
- 9** Press the **CURSOR UP** or **DOWN** to highlight each rating you want.
- 10** Press the **CURSOR RIGHT** to turn the rating **ON** or **OFF**. Turning the rating **ON** will block programs with that rating from being seen.
- 11** Press the **STATUS/EXIT** button to remove the menu from the screen.

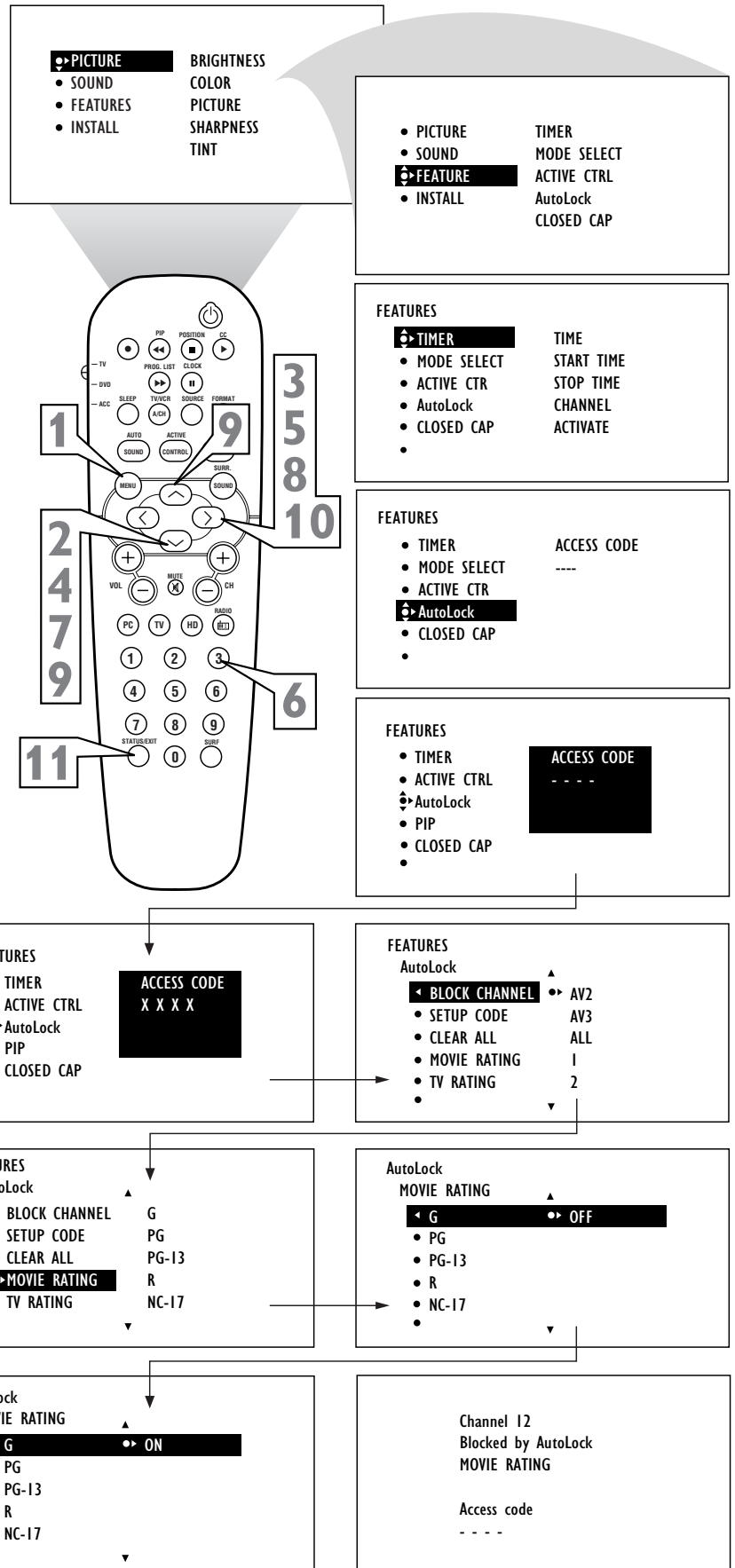

## HELPFUL HINT

When a rating is turned ON, all higher ratings also will be turned on automatically. For example, if the **R** rating is turned on, the **NC-17** and **X** ratings also will be turned on.

All Movie Ratings can be turned ON or OFF.

Refer to page 23 for Movie Rating definitions.

# BLOCKING PROGRAMS BASED ON TV RATINGS



You can select specific TV ratings that you want to censor by following these steps.

- 1** Press the **MENU** button on the remote control to show the onscreen menu.
- 2** Press the **CURSOR DOWN** button to highlight **FEATURES**.
- 3** Press the **CURSOR RIGHT** button and the menu will shift to the left. **TIMER** will be highlighted.
- 4** Press the **CURSOR DOWN** button repeatedly until **AutoLock** is highlighted.
- 5** Press the **CURSOR RIGHT** button to highlight **ACCESS CODE**.
- 6** Enter your four-digit **ACCESS CODE**. **CORRECT** will flash very briefly and the menu will move to the left with **BLOCK CHANNEL** highlighted.
- 7** Press the **CURSOR DOWN** repeatedly until **TV RATING** is highlighted.
- 8** Press the **CURSOR RIGHT** and the menu will shift to highlight the **TV RATING** options.
- 9** Press the **CURSOR UP** or **DOWN** to select a rating.
- 10** Press the **CURSOR RIGHT** to turn the block on the rating **ON** or **OFF**.

**NOTE:** More specific subratings (for violence, sexual content, dialogue, or fantasy violence) are available for TV-Y7, TV-PG, TV-14, and TV-MA. (Refer to page 31 for definitions.)

To access these subratings, with the main rating selected, **press the CURSOR RIGHT**. Then, repeat steps 9 and 10 to turn the sub-ratings **ON** or **OFF**.

- 11** Press the **STATUS/EXIT** button to remove the menu from the screen.

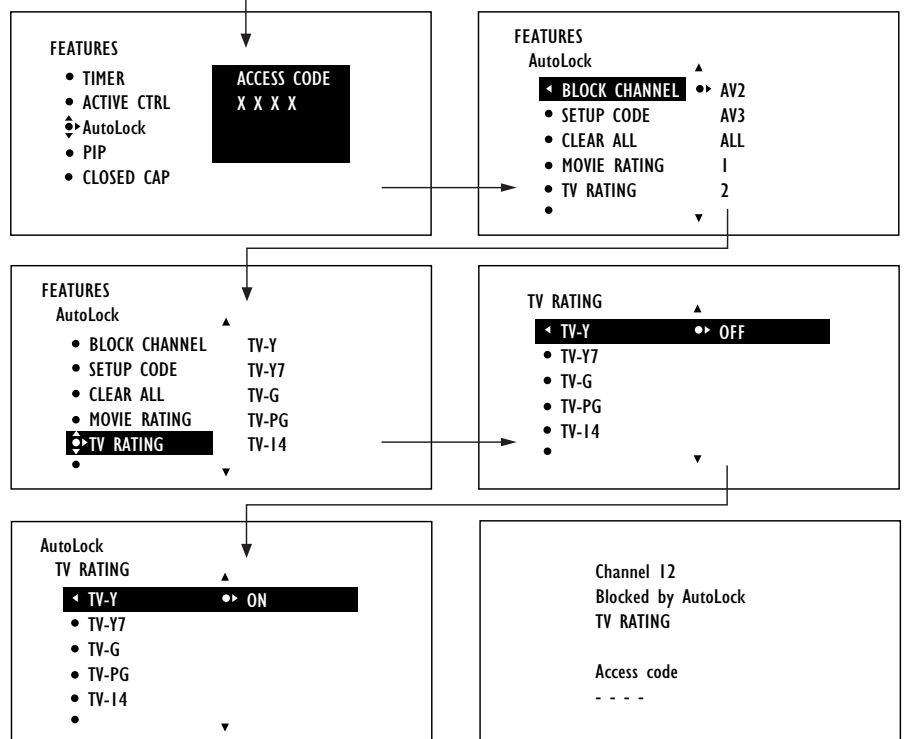
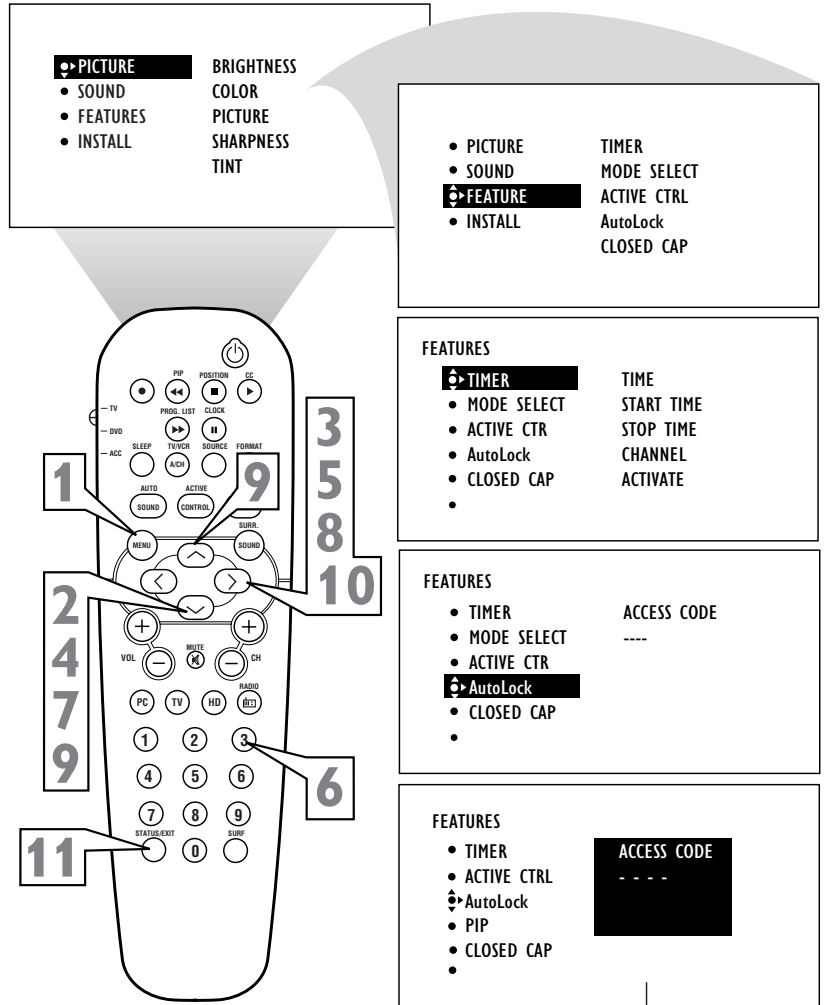

## HELPFUL HINT

When a rating is turned **ON**, all higher ratings also will be turned on automatically. For example, if the **R** rating is turned on, the **NC-17** and **X** ratings also will be turned on.



# OTHER AUTOLOCK™ BLOCKING OPTIONS

The **BLOCKING** control is what can be thought of as the “master switch” for AutoLock™. This control affects the settings you have chosen for blocking programs according to movie ratings or TV ratings, or for blocking programs that have no rating. When the **BLOCKING** control is **OFF**, the blocking or censoring of programs is disabled. When the **BLOCKING** control is **ON**, blocking will occur according to the settings you have chosen. Follow these steps to toggle **BLOCKING OFF** or **ON**.

- 1** Press the **MENU** button on the remote control to show the onscreen menu.
- 2** Press the **CURSOR DOWN** button to highlight **FEATURES**.
- 3** Press the **CURSOR RIGHT** button and the menu will shift to the left. **TIMER** will be highlighted.
- 4** Press the **CURSOR DOWN** button repeatedly until **AutoLock** is highlighted.
- 5** Press the **CURSOR RIGHT** button to highlight **ACCESS CODE**.
- 6** Enter your four-digit **ACCESS CODE**. **CORRECT** will flash very briefly and the menu will move to the left with **BLOCK CHANNEL** highlighted.
- 7** Press the **CURSOR DOWN** repeatedly until **BLOCK OPTIONS** is highlighted.
- 8** Press the **CURSOR RIGHT** to enter the **BLOCK OPTIONS** menu. **BLOCKING** will be highlighted. Or choose **NO RATING**.
- 9** Press the **CURSOR RIGHT** or **LEFT** to toggle **BLOCKING** (or **NO RATING**) **ON** or **OFF**.
- 10** Press the **STATUS/EXIT** button to remove the menu from the screen.

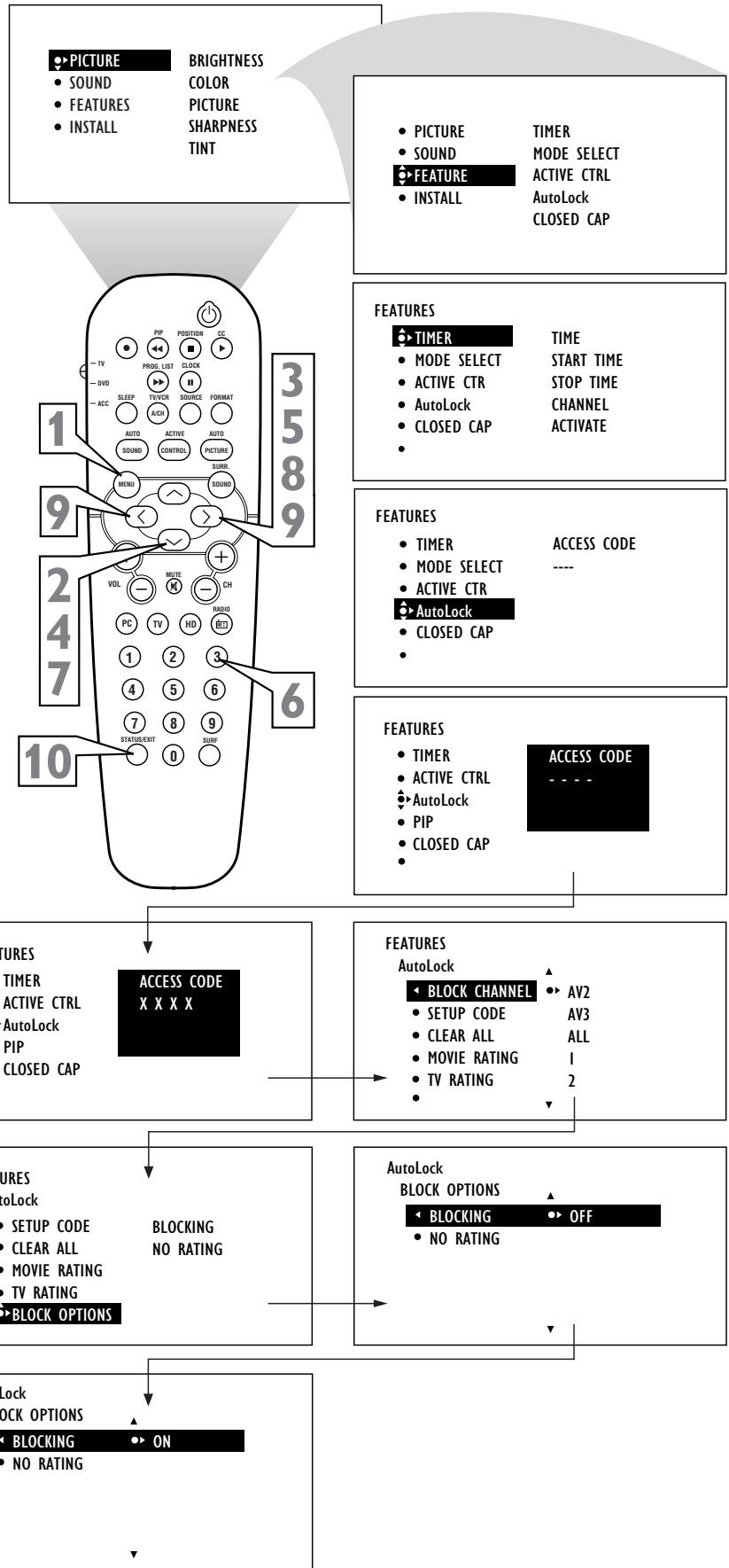

## HELPFUL HINT

Remember, when the **BLOCKING** control is **OFF**, the blocking or censoring of programs is disabled. When the **BLOCKING** control is **ON**, blocking will occur according to the settings you have chosen.



To remind you which ratings you have blocked and which Block Options you have selected, a review screen is available to review your AutoLock™ settings. To access this screen follow the steps below.

- 1 Press the STATUS/EXIT button on your remote control TWICE. Your AutoLock™ settings will appear on the screen.

**NOTE:** If you have blocked specific subratings, such as V for Violence in the TV-PG category, these blocked subratings will not appear in the review. The subratings however, are still blocked according to your selections.

- 2 After a few seconds, the settings will leave the screen automatically, or you can press the STATUS/EXIT button a third time to remove them from the screen.

### HELPFUL HINT

The AutoLock™ Status screen will only appear if the BLOCKING option is set to ON. For details, see previous page for details.

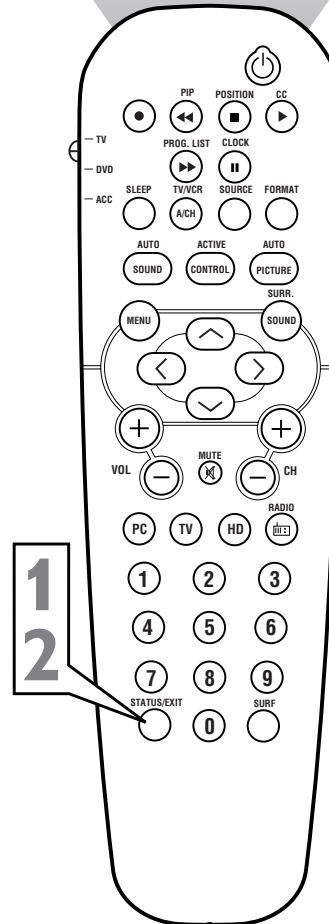
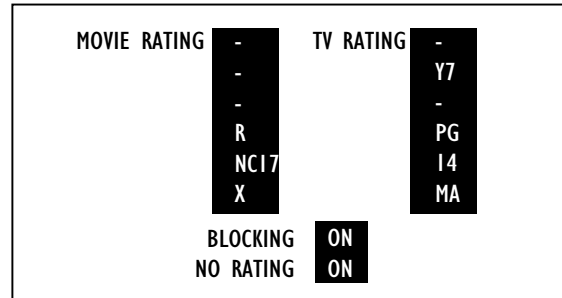

This display will appear after the step 1 above is completed if the AutoLock™ BLOCKING option is set to ON.

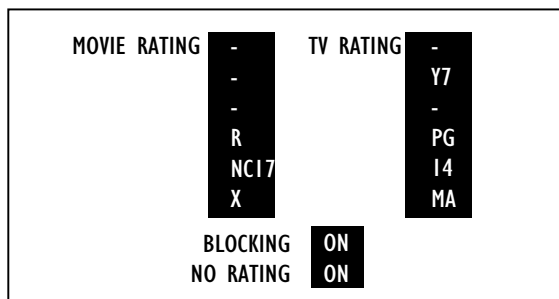

This display will appear after the step 1 above is completed if the AutoLock™ BLOCKING option is set to OFF.

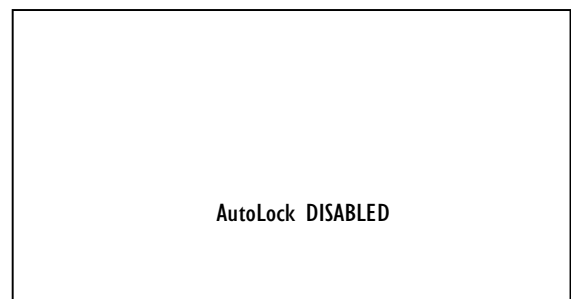



# How to Use the Closed Captioning Controls

**C**losed Captioning (CC) allows you to read the voice content of television programs on the TV screen. Designed to help the hearing impaired, this feature uses onscreen "text boxes" to show dialogue and conversations while the TV program is in progress.

- 1** Press the **MENU** button on the remote control to show the on-screen menu.
- 2** Press the **CURSOR DOWN** button twice to highlight FEATURES.
- 3** Press the **CURSOR RIGHT** button and the menu will shift to the left.
- 4** Press the **CURSOR DOWN** button repeatedly until the **CLOSED CAP** control is highlighted.
- 5** Press the **CURSOR RIGHT** button again. The menu will shift to the left and **CAPTION MODE** will be highlighted.
- 6** Press the **CURSOR RIGHT** button to highlight **CAPTION MODEs**.
- 7** Press the **CURSOR UP** or **DOWN** button to select a **CAPTION MODE**: CC1, CC2, CC3, CC4, CC MUTE, TXT1, TXT2, TXT3, or TXT4. **CC DISPLAY** turns text OFF or ON if the TV station broadcasting on the channel is making **CLOSED CAPTIONING** available. With **CC DISPLAY** highlighted, press the **CURSOR RIGHT** to toggle Closed Captioning ON or OFF.
- 8** **NOTE:** You also can press the **CC** button on the remote control to turn the **CC** option ON or OFF.
- 9** Press the **STATUS/EXIT** button to remove the menu from the screen.

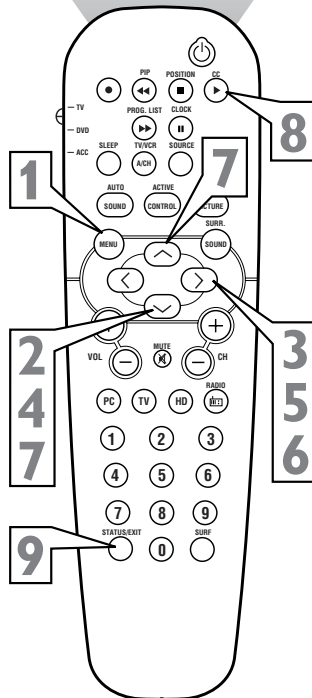
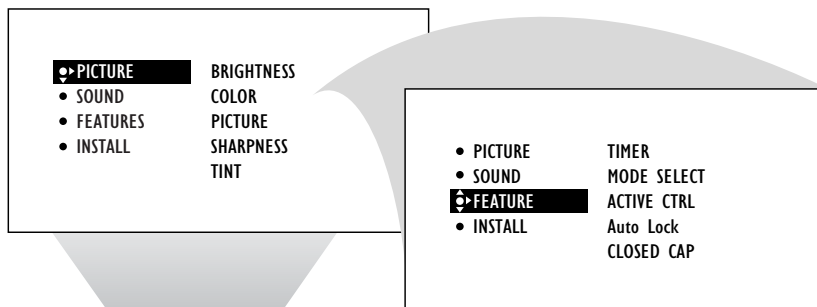

**CAPTION Mode Example Display**

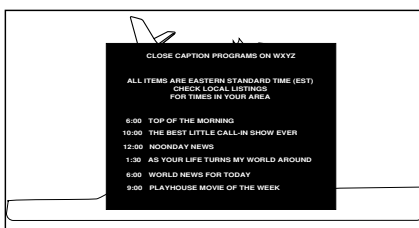

**TEXT Mode Example Display -**  
The TV screen will be blocked from viewing.

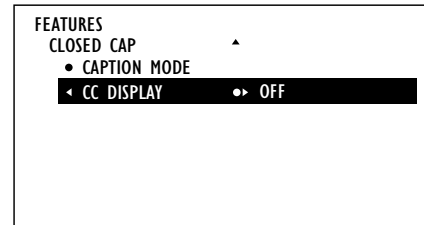
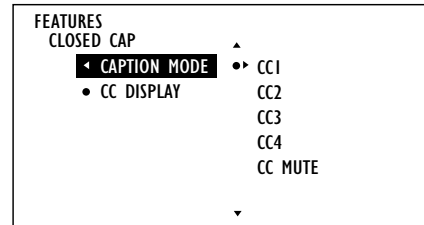
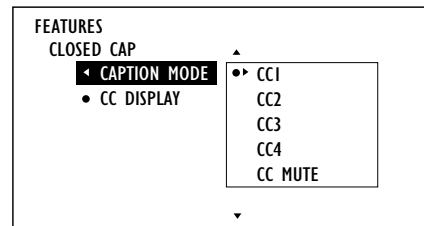
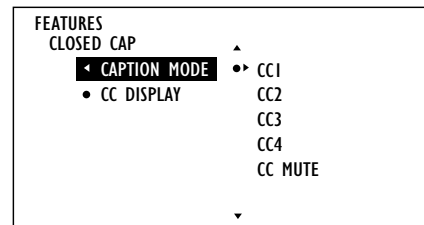
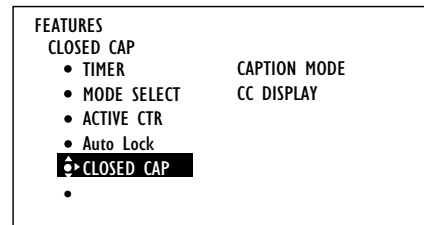
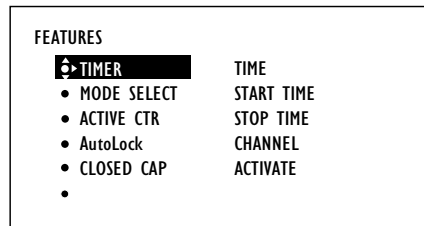
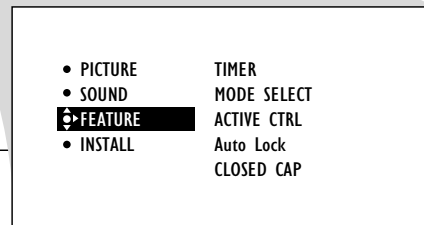

OR



## HELPFUL HINT

Not all TV programs and product commercials are broadcast with Closed Captioning (CC). Nor are all Closed Captioning MODEs (CAPTION 1-4 or TEXT 1-4) necessarily being used by broadcast stations during the transmission of a program offering Closed Captioning. Refer to your area's TV program listings for the stations and times of shows being broadcast with Closed Captioning.



# HOW TO USE THE WIDESCREEN (FORMAT) CONTROL



You can change the screen format size to match the type of program you're watching. Select the normal 4:3, or the Zoom 14:9, Zoom 16:9, Subtitle Zoom, Super Wide, Widescreen, or Full Screen aspect ratios.

- 1** Press the **MENU** button on the remote control to show the on-screen menu.
- 2** Press the **CURSOR DOWN** button twice to highlight FEATURES.
- 3** Press the **CURSOR RIGHT** button and the menu will shift to the left.
- 4** Press the **CURSOR DOWN** button repeatedly until the **WIDESCREEN** control is highlighted.
- 5** Press the **CURSOR RIGHT** button repeatedly to toggle among the three screen format sizes; 4:3, ZOOM 14:9, ZOOM 16:9, SUBTITLE ZOOM, SUPER WIDE, WIDESCREEN, or FULL SCREEN.
- 6** Press the **STATUS/EXIT** button to remove the menu from the screen.

▶ PICTURE

- SOUND
- FEATURES
- INSTALL

BRIGHTNESS

COLOR

PICTURE

SHARPNESS

TINT

- PICTURE
- SOUND
- ▶ FEATURE
- INSTALL

TIMER

MODE SELECT

ACTIVE CTRL

Auto Lock

CLOSED CAP

- MODE SELECT
- ACTIVE CTR
- Auto Lock
- CLOSED CAP
- ◀ WIDE SCREEN ▶ 4:3

OR

◀ WIDE SCREEN
▶ ZOOM 14:9

OR

◀ WIDE SCREEN
▶ ZOOM 16:9

OR

◀ WIDE SCREEN
▶ SUBTITLE ZOOM

OR

◀ WIDE SCREEN
▶ SUPER WIDE

OR

◀ WIDE SCREEN
▶ WIDESCREEN

OR

◀ WIDE SCREEN
▶ FULL SCREEN

## HELPFUL HINT

When in the TV Mode and no onscreen menu displayed, **pressing the CURSOR RIGHT and LEFT** buttons will toggle the **FORMAT** options.

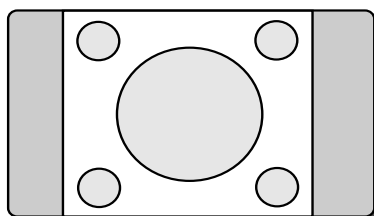

4:3

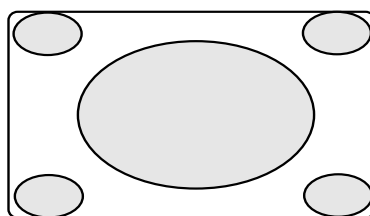

SUPER WIDE

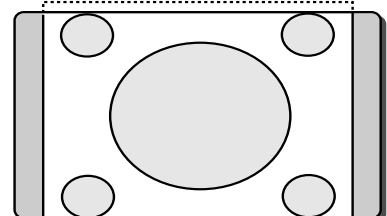

ZOOM 14:9

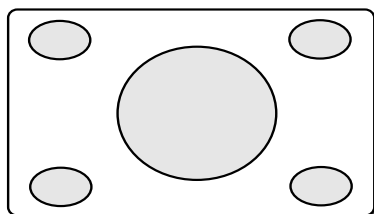

WIDESCREEN

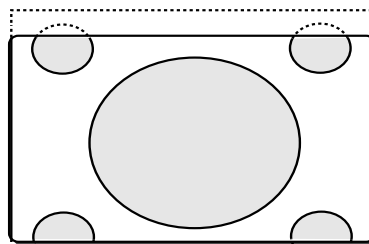

ZOOM 16:9

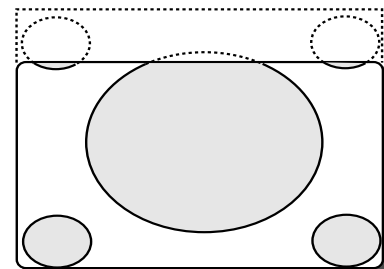

SUBTITLE ZOOM



## HOW TO USE THE PROGRAM LIST CONTROL

The Program List Control will allow you to quickly overview all the programmed channels that have been placed into the televisions memory (see the Auto Programming section of this manual for more details).

Program List will let you easily select the desired channels your looking for. Program List will display the channel number, the name of the channel if you have given it one, and whether it have AutoLock turn on or off.

- 1 Press the PROGRAM LIST button** on the remote control to show the current list of installed channels (the current channel will be highlighted).
- 2 Press the CURSOR UP or DOWN buttons** to scroll the list of channel, highlighting the one you want to activate.
- 3 Press the CURSOR RIGHT button** to activate the channel. The TV will tune to that channel.
- 4 Press the STATUS/EXIT button** to remove the menu from the screen.

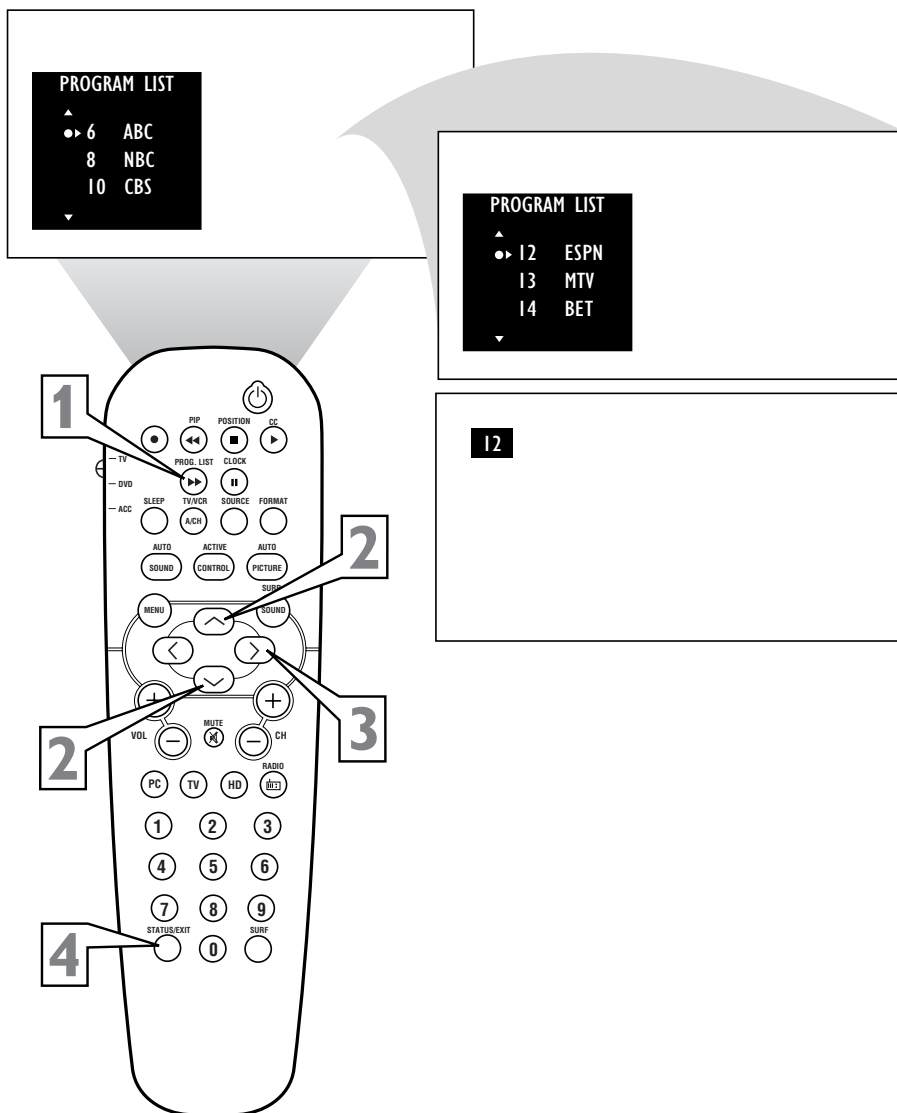

# HOW TO SET THE SLEEPTIMER CONTROL



**H**ave you ever fallen asleep in front of the TV, only to have it wake you up at two in the morning with a test pattern sound screeching in your ears? Well, your TV can enable you to avoid that discomfort by automatically turning itself off. With the Sleep Timer feature, you can set a timer to automatically switch the TV OFF after a period of time you choose (15-minute increments up to 60 minutes, then 30-minute increments up to 90 minutes, then 60-minute increments up to 240 minutes).

**1** Press the **SLEEP** button on the remote control. The SLEEP timer onscreen display will appear in the upper part of the screen.

**2** Within five seconds, press the **SLEEP** button repeatedly to pick the amount of time (15-minute increments up to 60 minutes, then 30-minute increments up to 90 minutes, then 60-minute increments up to 240 minutes) before the TV will turn itself off.

An onscreen countdown will appear during the last minute before the TV shuts itself off.

## HELPFUL HINT

To see how many minutes remain before the TV shuts itself off, press the STATUS/EXIT button.

A Sleep Timer setting can be cancelled by pressing any button during the last minute of the operation.

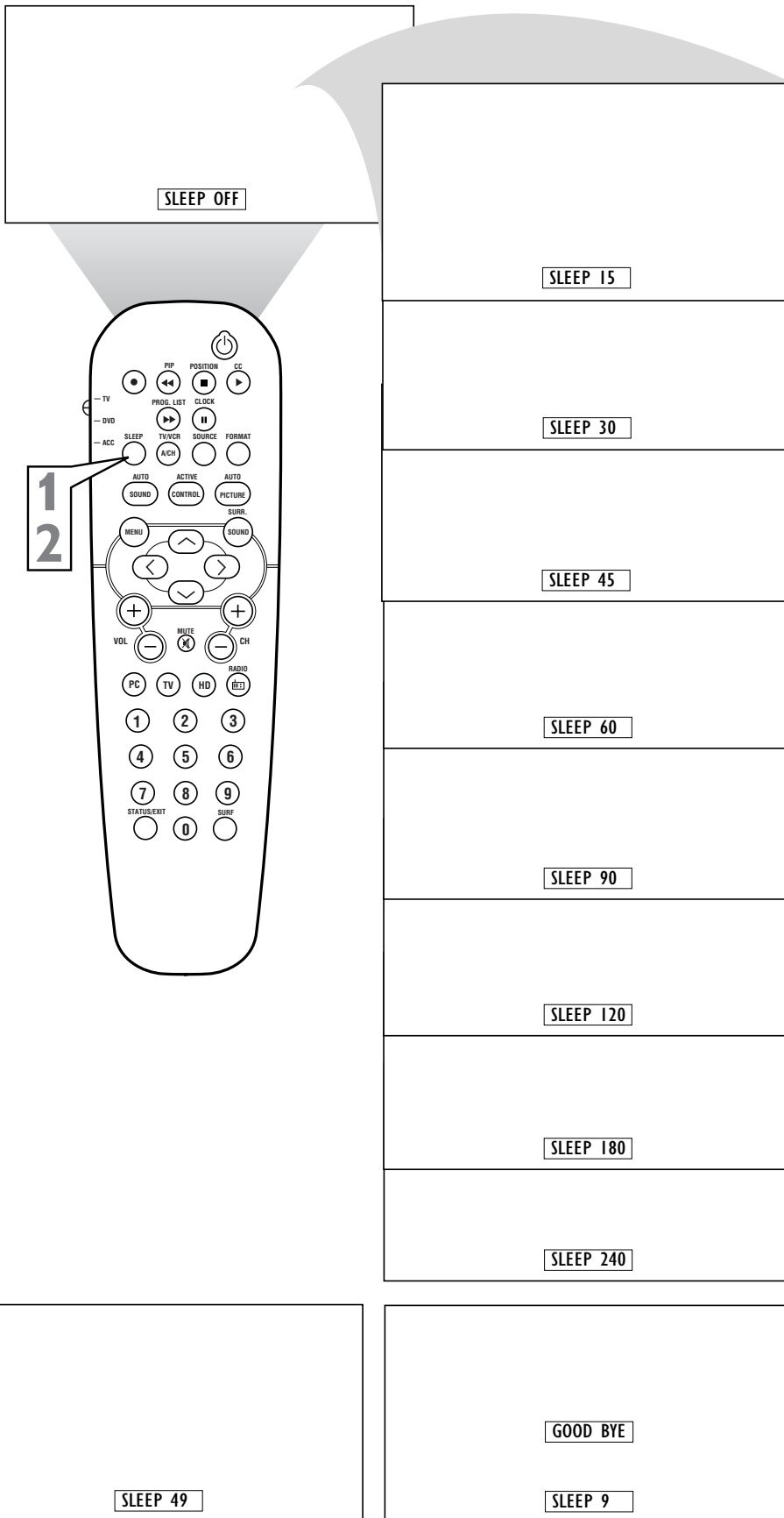

During the last minute of a SLEEP timer setting an onscreen countdown will be displayed.

During the last 10 seconds of a SLEEP timer setting, an onscreen display will read GOOD BYE.



# HOW TO USE THE AUTOPICTURE™ CONTROL

Whether you're watching a movie or a video game, your TV has automatic video control settings that will match with your current program source or content. AutoPicture™ quickly resets your TV's video controls for a number of different types of programs and viewing conditions that you may have in your home. The Movies, Sports, Weak Signal, and Multimedia AutoPicture™ controls have been preset at the factory to automatically adjust the TV's brightness, color, picture, sharpness, tint, and color temperature levels. The Personal AutoPicture™ settings are the ones that you made through the PICTURE options within the onscreen menu

**1** Press the **PICTURE** button on the remote control. The current AutoPicture™ setting will appear in the middle of the screen.

**2** Press the **PICTURE** button repeatedly to select either **PERSONAL**, **MOVIES**, **SPORTS**, **WEAK SIGNAL**, or **MULTIMEDIA** picture settings.

**NOTE:** The **PERSONAL** setting and the **PICTURE** options within the onscreen menu are the same. This is the only option in AutoPicture™ that can be changed. To adjust these settings, use the **PICTURE** options within the onscreen menu. All other settings are set up at the factory during production and cannot be adjusted.

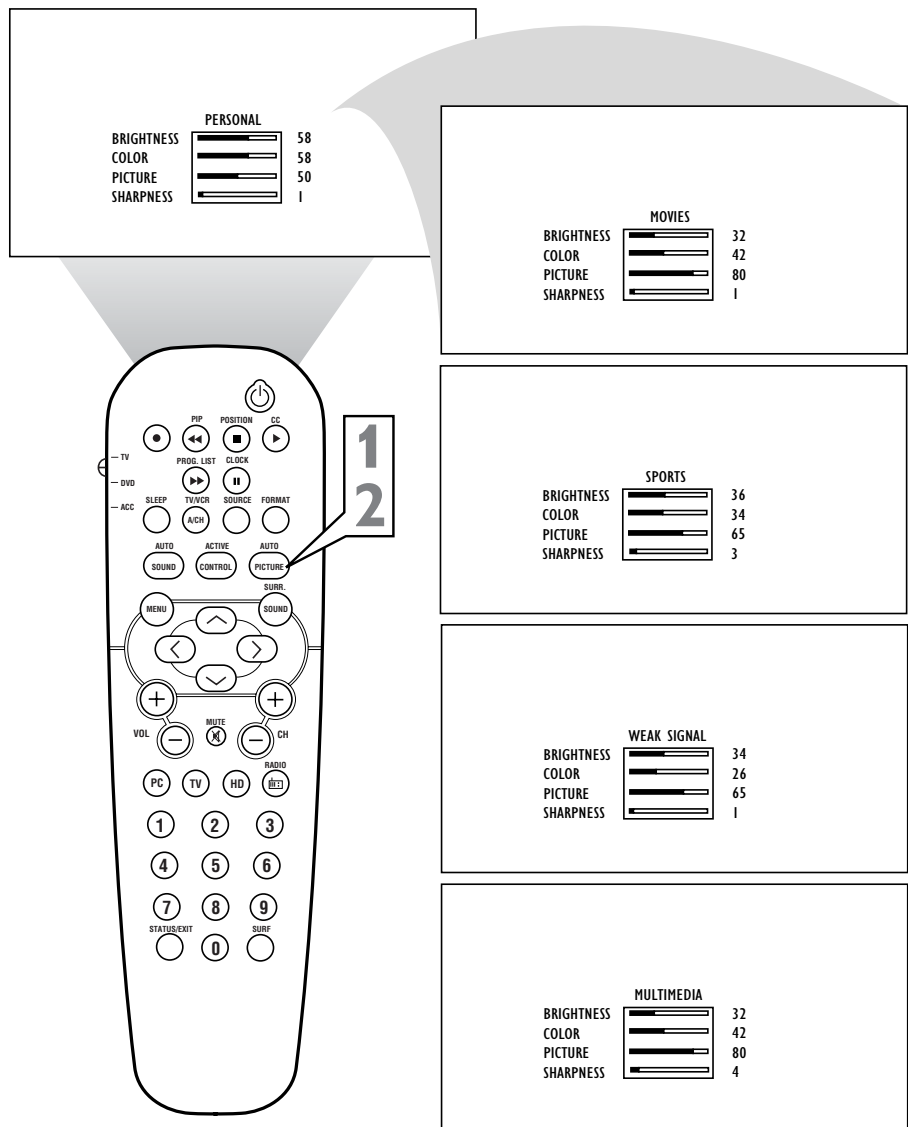

**NOTE:** The values shown in the diagram above are sample values only. Your television's values may vary and display different numbers.

# HOW TO USE THE AUTO SOUND™ CONTROL



**A**utoSound™ allows you to select from three factory-set controls and a personal control that you set according to your own preferences through the onscreen Sound menu. The three factory-set controls (Voice, Music, and Theatre) enable you to tailor the TV sound so as to enhance the particular program you are watching. Follow these steps to select any of the options.

- 1** Press the **SOUND** button on the remote control. The current AutoSound™ setting will appear in the middle of the screen.
- 2** Press the **SOUND** button repeatedly to toggle among the four settings: PERSONAL, VOICE, MUSIC, or THEATRE.

Remember, only the PERSONAL control can be changed by the viewer. This changes the settings in the main onscreen menu's SOUND controls

## HELPFUL HINT

AutoSound™ works only with the programs coming through the ANTENNA/CABLE (ANT) input on the rear of the TV (RF audio). It will not control the sound levels for the external connections.

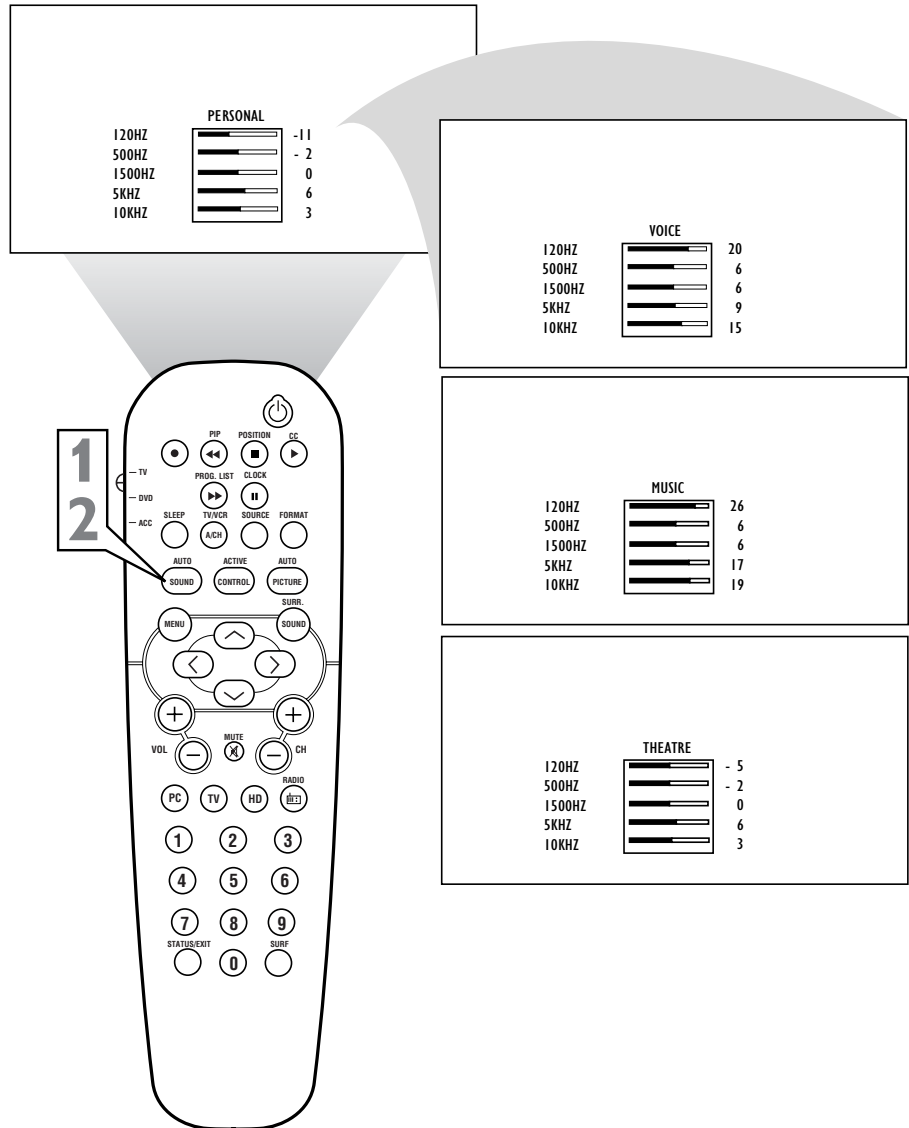

**NOTE:** The values shown in the diagram above are sample values only. Your television's values may vary and display different numbers.



# HOW TO USE THE SURF CONTROL

A list or series of previously viewed channels can be selected with the SURF button on your remote control. With this feature, you can easily switch between different TV channels that currently interest you. The SURF control allows you to set up to ten channels in its quick viewing list.

- 1** Press the CHANNEL(+) or (-) button (or the numbered buttons) to select a channel to add to the SURF list.
- 2** Press the SURF button on the remote control. The onscreen display may read, "SURF LIST EMPTY." The number of the current channel will be shown with "ADD?" to the right.
- 3** While the SURF list message or the SURF channel list appears on the screen, press the CURSOR RIGHT button to add the present channel to the SURF list.
- 4** If you want to delete the present channel from the SURF list, press the CURSOR RIGHT button again.

Repeat steps 1 through 3 to add more channels (up to 10) to the SURF list.

## HELPFUL HINT

Along with regularly programmed channels, the external video source connections can be added to the SURF list. This means that the external A/V Jacks and their channels can be added to your SURF list. Use the Source button to tune their channel and use the same procedure described on this page.

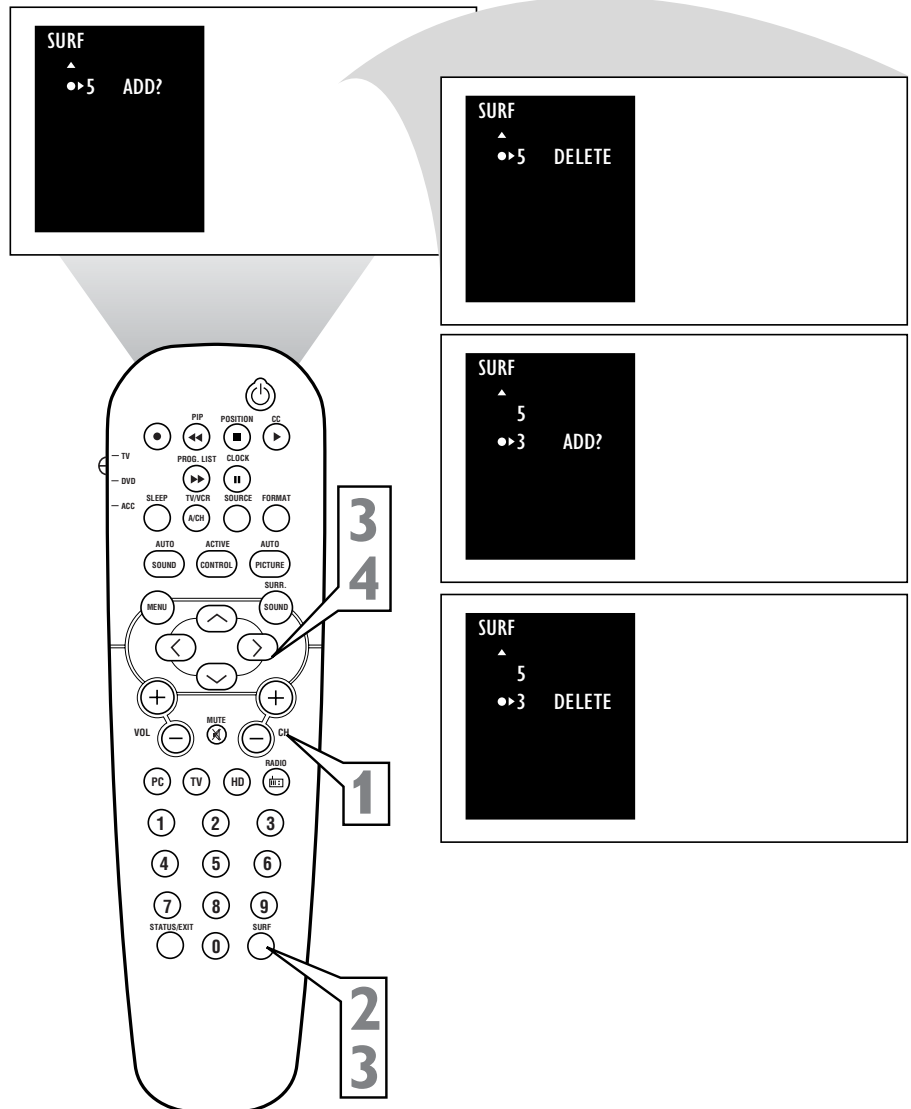



Your remote control is set to work your TV and many infrared remote (IR) control VCRs, Cable Boxes, Satellite Systems, DBS, DVD, etc. However, an easy onetime step may be necessary before the remote will work your VCR.

Try this initial Direct Access Method to see if going on to the following section is necessary.

- 1** Place the TV/DVD/ACC Mode Switch in the proper position.
- 2** Point the remote control at the device and press the POWER button.

Does the remote turn the device ON?

**If YES**, stop and try other function buttons on the remote. If they also work the device, then the remote is ready and no further steps are needed.

**If NO**, continue...

- 3** First look up a **FOUR-DIGIT remote control number** for your brand of Device before going through the simple steps on the following page.

**Find your Four-Digit Code on pages 42-44.**

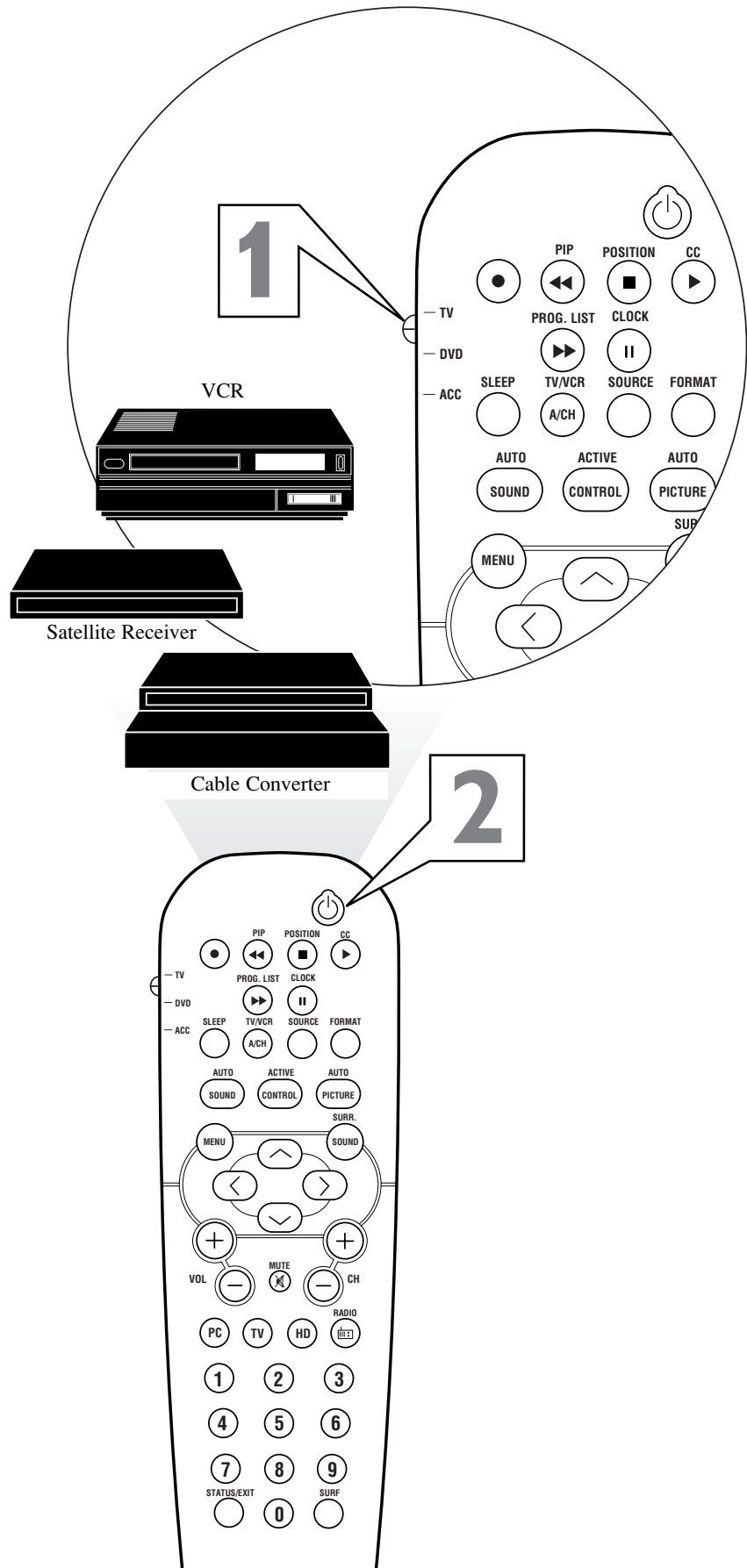

## HELPFUL HINT

If more than one number is listed, you may have to try more than the first Four-Digit code given in order to locate your Device's remote code.

**NOTE:** Setting up the remote is for use with external accessory devices only and not for use with other television brands.



# REMOTE CONTROL USE WITH ACCESSORY DEVICES - CODE ENTRY METHOD

Now that you have looked up the three-digit Remote Code Number for your brand of device, you are ready to follow the four simple steps below.

Please read through steps 1-4 before beginning.

- 1** Place the TV/DVD/ACC Mode Switch in the proper position.
- 2** Press the **• RECORD** button on the remote control and release.
- 3** Press the **AUTO SOUND** button on the remote within 30 seconds, then release.
- 4** Enter the **FOUR-DIGIT REMOTE CODE NUMBER** (page 42-44) for your desired device. The remote is now ready to send commands to the unit.
- 5** Point the remote at the Device. Press the **POWER** button on the remote to turn the unit ON. If this works you are finished. If it does not work the first time, repeat the steps using a different remote code number.

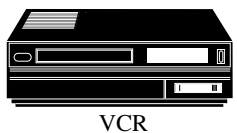

VCR



Satellite Receiver or DBS, DVD



Cable Converter

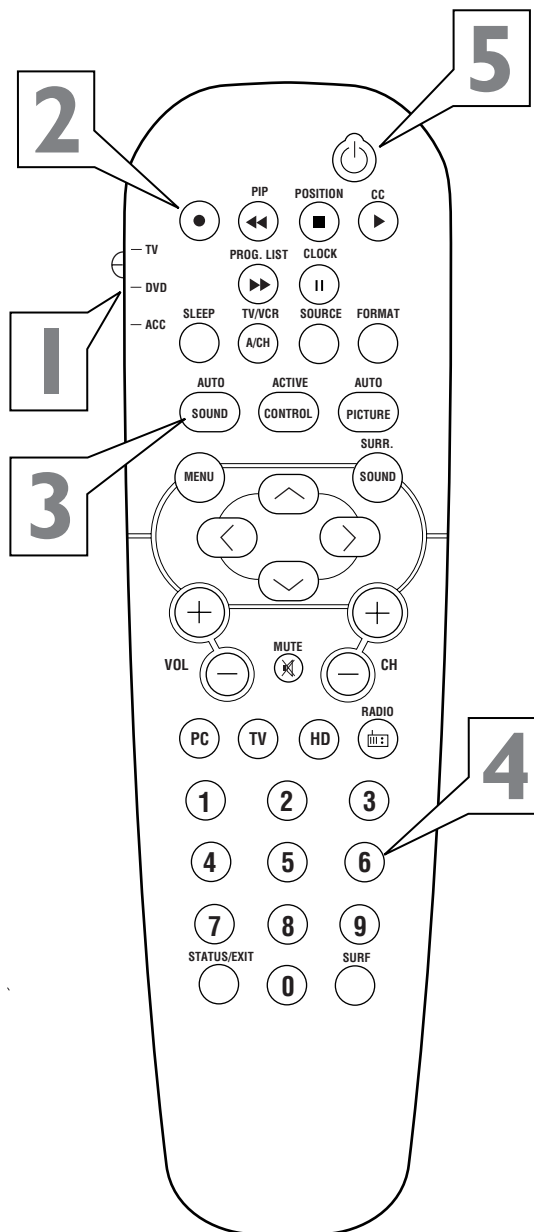

## HELPFUL HINT

After a second try and the remote does not operate your device, see if there is another four-digit code number (pages 42-44) listed for your device and repeat the steps above using the new number.

If after repeated attempts the code number method does not work you device, try the **SEARCH METHOD** on the next page.

**NOTE:** Setting up the remote is for use with external accessory devices only and not for use with other television brands.





Your TV remote can be set to work various external devices such as VCRs, Cable Boxes, Satellite Receivers, DBS, DVD, etc. by what is called the search method of remote control programming.

If the "Remote Code" number method shown on the previous page did not set your remote to work your external device, then follow the easy steps listed below.

Please read steps 1-4 before beginning.

- 1** Press the **POWER** button on the device you are attempting to program to turn it ON.
- 2** Place the **TV/DVD/ACC Mode Switch** in the proper position.
- 3** Press the **• RECORD** and the **AUTO SOUND** buttons **simultaneously** and hold them down. The remote will continue to send programming codes, one ever 1.5 seconds.
- 4** The device will begin to change channels after the remote identifies the correct code. When the channels start to change release the **• RECORD** and **AUTO SOUND** buttons. The remote should be ready to operate the device.

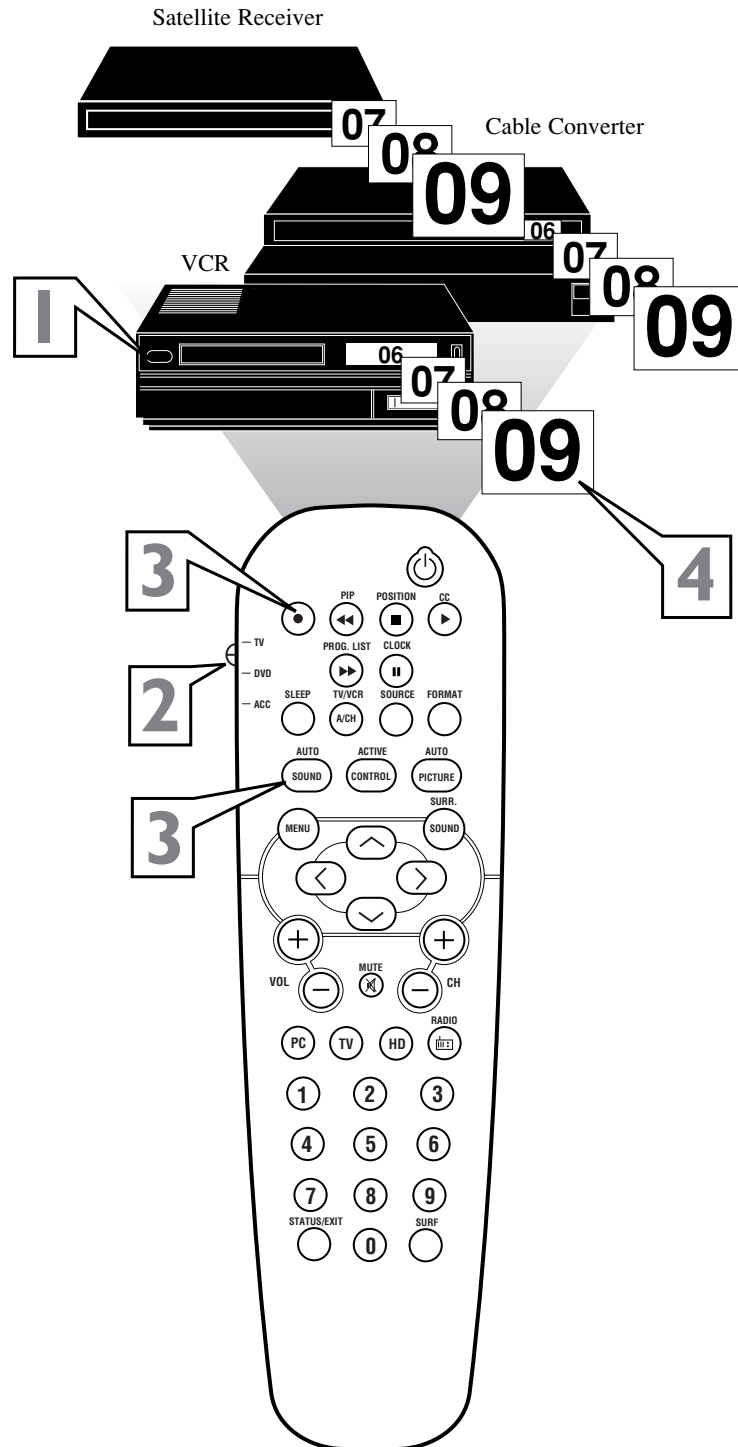

## HELPFUL HINT

This method can take several minutes to perform.

Don't let the device scan up more than five channels. If you do the remote may pass up the right code and another search cycle will have to be repeated.

If no channel change happens within two minutes, repeat steps 1-4. Should a channel change still not occur, the remote will not work the desired device.

**NOTE:** Setting up the remote is for use with external accessory devices only and not for use with other television brands.



# REMOTE CONTROL DIRECT ENTRY CODES

## VCR CODES

Admiral	.2027, 2052	Electroponic	.2017	Lloyd's	.2001, 2051
Adventura	.2001	Emerex	.2012	Loewe	.2004, 2005, 2017, 2035
Aiko	.2059	Emerson	.2001, 2002, 2017, 2023, .2040, 2046, 2051, 2052, .2059, 2078, 2083	Logik	.2004, 2034, 2057
Aiwa	.2001, 2017, 2062, 2070, 2072	ESC	.2057, 2059	Luxor	.2023, 2025, 2027, 2037, 2038
Akai	.2021, 2029, 2038, 2060, 2063	Ferguson	.2021, 2039, 2064, 2065	LXI	.2017
Akiba	.2034	Fidelity	.2001	M Electronic	.2001
Alba	.2011, 2034, 2052, .2059, 2063, 2072	Finlandia	.2035, 2037	Magnasonic	.2059
Ambassador	.2011	Finlux	.2001, 2022, 2035, 2037	Magnavox	.2001, 2015, 2019, 2035
American Action	.2059	Firsline	.2017, 2023, 2024, 2034, 2052	Magnin	.2057
American High	.2015	Fisher	.2025, 2026, 2030, 2037	Manesth	.2024, 2034
Amstrad	.2001, 2059, 2067, 2068	Frontech	.2011	Marantz	.2003, 2005, 2015, 2035
Anam	.2017, 2042, 2054, .2057, 2059, 2082, 2084	Fuji	.2015	Marta	.2017
Anam National	.2042, 2054, 2087	Funai	.2001	Matsui	.2004, 2016, 2036, .2052, 2070, 2072
Anitech	.2034	Garrard	.2001	Matsushita	.2015, 2042, 2055
Asa	.2017, 2035	GE	.2015, 2027, 2032, 2057	Mei	.2015
Asha	.2057	GEC	.2035	Melectronic	.2018
Asuka	.2017	General	.2011	Memorex	.2001, 2015, 2017, 2019, .2025, 2026, 2027, 2037, 2052, .2057, 2062, 2085, 2087, 2088
Audiovox	.2017	Go Video	.2077, 2081	Memphis	.2034
Baird	.2001, 2021, 2037, 2039	Goldhand	.2034	Metz	.2003, 2005, 2017, .2042, 2048, 2055, 2069
Basic Line	.2011, 2034, 2059	Goldstar	.2017, 2018, 2053, 2079	MGA	.2023, 2057
Beaumarck	.2057	Goodmans	2001, 2017, 2034, 2059, 2075	MGN Technology	.2057
Bell & Howell	.2037	Gradiente	.2001, 2008	Mincrva	.2048
Blaupunkt	.2003, 2005, 2010, 2014, .2041, 2042, 2048, 2054, 2055, 2075	Graetz	.2005, 2021, 2037, 2057	Minerva	.2005, 2010, 2048
Brandt	.2047, 2064, 2065	Granada	.2025, 2035, 2037	Minolta	.2022
Brandt Electronic	.2021	Grandin	.2001, 2017, 2034	Minolta	.2022
Broksonic	2002, 2040, 2046, 2052, 2078	Grundig	.2003, 2005, 2007, 2010, .2034, 2035, 2048, 2050, .2054, 2069, 2071, 2075	Mitsubishi	2023, 2027, 2033, 2035, 2045
Bush	.2034, 2052, 2059, 2072	Hanseatic	.2017	Motorola	.2015, 2027
Calix	.2017	Harley Davidson	.2001	MTC	.2001, 2057
Canon	.2015	Harman/Kardon	.2018, 2035	Multitech	.2001, 2034
Capehart	.2011	Harwood	.2034	Murphy	.2001
Carver	.2035	HCM	.2034	NAD	.2031
Catron	.2011	Headquarter	.2025	National	.2054
CCE	.2034, 2059	Hinari	.2004, 2034, 2057, 2072	NEC	.2018, 2020, 2021, 2033, 2037
CGE	.2001	Hi-Q	.2026	Neckermann	.2035
Cimline	.2034	Hitachi	.2001, 2004, 2021, .2022, 2043, 2057	Nesco	.2034
Cineral	.2059	Hughes Network Systems	.2022	Nikko	.2017
Citizen	.2017, 2059	Hypson	.2034	Nikon	.2014
Clatronic	.2011	Imperial	.2001	Noblex	.2057
Colt	.2034	Ingersol	.2004	Nokia	.2025, 2037, 2038, 2057
Combitech	.2072	Interfunk	.2035	Nokia	.2021, 2025, 2037, 2038, 2057
Condor	.2011	ITT	.2005, 2021, 2025, 2037, .2038, 2057, 2074	Nordmende	.2021, 2061, 2064, .2065, 2074
Craig	.2017, 2026, 2034, 2057, 2058	ITV	.2017, 2059	Oceanic	.2001, 2021
Crown	.2011, 2034, 2059	Jensen	.2021	Okano	.2063, 2070
Curtis Mathes	.2015, 2021, 2032, 2042	JVC	.2008, 2021, 2033, 2049, .2050, 2074, 2080	Olympus	.2015, 2054
Cybernex	.2057	Kaisui	.2034	Optimus	.2017, 2027, 2031, 2037, .2042, 2077, 2086, 2087, 2088
Cyrus	.2035	KEC	.2017, 2059	Orion	.2002, 2004, 2016, 2036, .2046, 2052, 2070, 2072, 2078
Daewoo	.2011, 2024, 2025, 2059, 2083	Kendo	.2038, 2052	Osaki	.2001, 2017, 2034
Dansai	.2034	Kenwood	.2018, 2021, 2033	Otto Versand	.2035
Daytron	.2011	KLH	.2034	Palladium	.2005, 2017, 2021, 2034
De Graaf	.2022, 2043	Kodak	.2015, 2017	Panasonic	.2015, 2042, 2053, .2054, 2055, 2087
Decca	.2001, 2035	Korpel	.2034	Pathe Cinema	.2016
Denon	.2022	Layco	.2034	Pathe Marconi	.2021
Dual	.2021	Lenco	.2059	Penny	.2015, 2017, 2018, .2020, 2022, 2057
Dumont	.2001, 2035, 2037	LG	.2079		
Dynatech	.2001				
Elbe	.2018				
Elcotech	.2034				
Electrohome	.2017				



## VCR CODES (continued)

Pentax	.2022	Sanky	.2019, 2027	TEC	.2011
Perdio	.2001	Sansui	.2001, 2021, 2033,	Technics	.2015, 2042, 2054
Philco	.2015, 2018, 2052, 2078		.2052, 2058, 2078	Teknika	.2001, 2015, 2007, 2017
Philips	.2015, 2035 (DEFAULT VCR),	Sanyo	.2025, 2026, 2037, 2057	Teleavia	.2021
	.2074, 2075	Saville	.2072	Telefunken	2021, 2047, 2058, 2064, 2074
Phonola	.2035	SBR 2035		Tenosal	.2034
Pilot	.2017	Schaub Lorenz	.2001, 2005, 2021, 2037	Tensai	.2001, 2066
Pioneer	.2031, 2033, 2035	Schneider	.2001, 2034, 2035	Thomas	.2001
Portland	.2011	Scott	.2023, 2024, 2040, 2046	Thomson	.2021, 2064, 2074
Profex	.2066	Sears	.2001, 2015, 2017,	Thorn	.2016, 2021, 2037
Profitronic	.2057		.2022, 2025, 2026, 2037	TMK	.2051, 2057
Proline	.2001	SEG	.2057, 2066	Toshiba	.2021, 2023, 2024, 2035, 2074
Proscan	.2032	SEI	.2004, 2035	Totelevision	.2017, 2057
Protec	.2034	Seleco	.2021	Towada	.2066
Pulsar	.2019	Semp	.2024	Uher	.2057
Pye	.2035	Sentra	.2011	Unitech	.2057
Quarter	.2025	Sharp	.2027, 2073	Universum	.2001, 2006, 2010, 2017,
Quartz	.2025	Shintom	.2034, 2037		.2035, 2038, 2048, 2057, 2067
Quasar	.2015, 2042, 2087	Shogun	.2057	Vector	.2024
Quelle	.2035	Shorai	.2004	Vector Research	.2018, 2020
Radio Shack	.2001, 2085	Silva	.2017	Victor	.2008, 2021, 2033
Radiola	.2035	Singer	.2024, 2034	Video Concepts	.2020, 2024
Radix	.2017	Sinudyne	.2004, 2035	Videosonic	.2057
RCA 2015, 2022, 2027, 2032, 2038, 2057		Solavox	.2011	Wards	.2001, 2015, 2022, 2026,
Realistic	.2001, 2015, 2017,	Sonorlor	.2025		.2027, 2032, 2034, 2035, 2057
	.2025, 2026, 2027, 2037	Sontec	.2017	White Westinghouse	.2052, 2059
REX	.2021, 2074	Sony	.2001, 2012, 2013, 2014, 2015	XR-1000	.2001
RFT	.2075	STS	.2022	XR-1001	.2015
Ricoh	.2014	Sunkai	.2070	XR-1002	.2034
Roadstar	.2017, 2034, 2057, 2059	Sunstar	.2001	Yamaha	.2018
Runco	.2019	Suntronic	.2001	Yamishi	.2034
Saba	.2021, 2049, 2050, 2061, 2	Sylvania	.2001, 2015, 2023, 2035	Yokan	.2034
	.064, 2065, 2074	Symphonic	.2001	Yoko	.2011, 2057
Saisho	.2004, 2016, 2036, 2052	Tashiko	.2001	Zenith	.2001, 2014, 2019, 2052, 2078
Salora	.2023, 2025, 2038	Tatung	.2001, 2021, 2035		
Samsung	.2024, 2057, 2076, 2077	Teac	.2001, 2021		

## DIGITAL VIDEO DISC CODES

Akai	.5316	Panasonic	.5301, 5322	Sony	.5306
Harman/Kardon	.5314	Philips	.5302, 5308 (DEFAULT DVD)	Technics	.5301
JVC	.5311, 5318	Pioneer	.5305, 5312, 5321	Theta Digital	.5312
Kenwood	.5307	Proscan	.5304	Thomson	.5310
Magnavox	.5302	RCA	.5304	Toshiba	.5302
Mitsubishi	.5303	Samsung	.5313	Yamaha	.5301, 5309
Onkyo	.5302, 5317, 5319	Sharp	.5320		

## CABLE CODES

ABC	.3002, 3003, 3004, 3006, 3008	Decsat	.3027	Jerrold	.3002, 3004, 3005, 3006,
Andover	.3037	Everquesst	.3007		.3007, 3020, 3031, 3046
Bell & Howell	.3006	Filmnet	.3028	LG Alps	.3044
Birmingham Cable Communication	.3020	France Telecom	.3030	Memorex	.3001
British Telecom	.3002, 3012	GEC	.3011	Mnet	.3009, 3028
Cabletime	.3016, 3019, 3025, 3029	Gemini	.3007	Now	.3041
Clyde	.3011	General Instrument	.3004, 3020,	Oak	.3009
Contec	.3009		.3031, 3046	Pacific	.3039
Cryptovision	.3038	Goldstar	.3014, 3047	Panasonic	.3001, 3013
Daehan	.3043	Grundig	.3035	Paragon	.3001
Daeryung	.3003	Hitachi	.3004	Pioneer	.3014, 3036
		Jasco	.3007	Pulsar	.3001



# REMOTE CONTROL DIRECT ENTRY CODES

## CABLE CODES (continued)

PVP Stereo Visual Matrix	.3002	Signal	.3007	Toshiba	.3001
Quasar	.3001	Signature	.3004	Tudi	.3023
Radio Shack	.3007	Starcom	.3002, 3007	Tusa	.3007
Rembrandt	.3004	Stargate	.3007	United Cable	.3002
Runco	.3001	Starquest	.3007	Videoway	.3017
Salora	.3026	STS	.3015	Visicable+	.3033
Samsung	.3014, 3040	Taihan	.3043	Westminster	.3012
Satbox	.3024	Tele+1	.3028	Wolsey Gene	.3037
Scientific	.3003, 3032, 3049	Teleservice	.3022	Zenith	.3001, 3034
Scientific Atlanta	.3003, 3008, 3021	Tocom	.3005		
Seawoo	.3045	Tongkook 3	.042, 3048		

## SATELLITE CODES

Absat	.4006	Grundig	.4008, 4010, 4048	Pioneer	.4021, 4059
Alba	.4029, 4034, 4037, 4052	G-sat	.4009	Planet	.4061
Aldes	.4019	Hinari	.4009	Promax	.4037
Amstrad	.4003, 4016, 4025, .4038, 4039, 4042	Hirschmann	.4008, 4032, 4039, .4040, 4049	Prosat	.4019
Ankard	.4013, 4019, 4030, 4044	Hitachi	.4037	Quadral	.4029, 4044
Anttron	.4009, 4034	Houston	.4053	Radiola	.4011
Armstrong	.4015	Huth	.4013, 4015, 4019, 4026	Radix	.4031, 4064
AST	.4027	Intervision	.4050	RFT	.4011, 4013, 4019
Astra	.4005	Invideo	.4061	Saba	.4023, 4045
Astro	.4008, 4039, 4045	ITT	.4005	Sabre	.4037
Avalon	.4031	Johansson	.4022	Sagem	.4056
Axis	.4030, 4046	JVC	.4048	Salora	.4005
Beko	.4010	Kathrein	.4004, 4006, 4008, .4011, 4035, 4041	SAT	.4027, 4038
Best	.4030	Kreiselmeier	.4008	Satcom	.4026, 4051
Blaupunkt	.4008	Kyostar	.4034	Satec	.4009
Boca	.4015, 4043	La Sat	.4043, 4045	Satmaster	.4026
Brain Wave	.4022	Lenco	.4034	Satpartner	.4022, 4034, 4040, 4045
British Sky Broadcasting	.4058	Lennox	.4050	Schwaiger	.4009, 4041
BT	.4053	Lupus	.4030	Seemann	.4031, 4046
Bush	.4002	Luxor	.4005, 4049	SEG	.4030, 4034
Cambridge	.4024	Manhattan	.4037, 4045, 4050	Siemens	.4008
Canal Satellite	.4059	Marantz	.4011	Skymaster	.4019, 4044, 4051
Canal+	.4059	Maspro	.4004, 4023	Sony	.4017, 4018
Channel Master	.4029	Matsui	.4024, 4048	Strong	.4062
CNT	.4045	Mediamarkt	.4015	Sunstar	.4043
Comlink	.4019	Mediasat	.4059	Tantec	.4023, 4037
Connexions	.4031	Minerva	.4048	Techniland	.4026
Crown	.4015	Morgan's	.4015, 4043	Technisat	.4001, 4039
Cyrus	.4011	Navex	.4022	Telefunken	.4034
D-Box	.4054	Neuhaus	.4039	Teleka	.4015, 4052
DDC	.4029	Neusat	.4057	Telesat	.4051
DNT	.4011, 4031	Newhaus	.4013	Thomson	.4037, 4059
Echostar	.4031, 4036, 4061	Nokia	.4005, 4032, 4037, .4049, 4054, 4063	Tonna	.4026, 4053
Emanon	.4034	Nordmende	.4029	TPS	.4056
Ferguson	.4002, 4009, 4010, 4023	Orbitech	.4039	Triad	.4027
Fidelity	.4016	Oxford	.4024	Triasat	.4040
Finlux	.4005, 4024, 4032, 4037	Pace	.4002, 4009, 4014, 4023, .4037, 4055, 4058	Unitor	.4022
Fracarro	.4061	Palladium	.4048	Universum	.4008, 4049
Freecom	.4034	Palsat	.4039	Ventana	.4011
FTE Humax	.4060	Panda	.4037	Vortec	.4034
Fube	.4030, 4031, 4034	Philips	.4007, 4011, 4020, .4037, 4048, 4059	Vtech	.4027
Galaxis	.4019, 4057, 4060	Phonotrend	.4019, 4050	Winersat	.4022
General Instrument	.4012			Wisi	.4008, 4027, 4031, 4037
Gold Box	.4059			Xcom Multimedia	.4065
Gooding	.4048			Xsat	.4006, 4065
Goodmans	.4010			Zehnder	.4033, 4045

# REMOTE CONTROL ACCESSORY DEVICE RELATED BUTTONS



When using the TV remote with an accessory device, first make certain it is set to control your accessory device (by the REMOTE CODE or SEARCH method).

**1** Set the TV/DVD/ACC mode switch to the proper position on the remote.

**2** Point the top of the remote toward the front of the accessory device (remote sensor window) when pressing the buttons.

**SYSTEM SWITCH**  
Set in the proper position to send remote commands to the accessory device.

**RECORD • BUTTON**  
Hold the VCR • RECORD button down to begin a VCR recording.

**REWIND BUTTON** ◀◀  
Press to rewind tapes. For some VCR's the STOP button may have to be pressed first, then REWIND. May be used to scan back through chapters or titles on DVD movies.

**FAST FORWARD BUTTON** ▶▶  
Press to rapidly advance a tape or DVD. For some accessory devices, you may need to press the STOP button first, then the FAST FORWARD button. In playback mode hold the button down to view the picture moving rapidly in the forward direction.

**TV/VCR BUTTON**  
Press while in the VCR mode (VCR indicator on the front of the unit will light) to view the playback of a tape. Press again to place in the TV position (VCR indicator light will go off) to view one program while recording another program. When used in the TV mode, the TV/VCR button will have no functionality.

**POWER BUTTON**  
Press to turn the accessory device ON and OFF.

**PLAY BUTTON** ▶  
Press to begin playback of a video tape, DVD, etc.

**STOP BUTTON** ■  
Press to stop the motion of a tape or to stop the playback of a DVD.

**PAUSE BUTTON** II  
Press to temporarily stop the tape during a playback or recording or pause the playback of a DVD. Press again to release Pause.

**CHANNEL + & - BUTTONS**  
Press to scan up or down through the channel numbers if your accessory device will change channels.

**NUMBER BUTTON**  
Press buttons for direct channel selections. May also be used for direct number entries in certain onscreen menu feature settings.

## HELPFUL HINT

The buttons on the remote will not operate your accessory device if those features are not found on your accessory's remote control.

Note: All functions (particularly Search, Rewind, Fast Forward, etc.) will operate the same as with the original remote control provided with your accessory device.



# SETTING UP THE FM MODE (FM RADIO)

## INSTALL CONTROLS

This TV also provides you with an FM Radio. An FM Radio signal must be connected to the FM Antenna 75Ω Jack located on the bottom of the TV.

- 1** To enter the FM Mode, press the **RADIO** button on the remote control. The FM Mode has its own onscreen menu options.
- 2** Press the **MENU** button on the remote control to display the FM Mode onscreen menu.
- 3** Press the **CURSOR UP** or **DOWN** buttons to scroll through the available FM Mode onscreen options. These options include: **Language, Auto Program, Manual Store, Sort, or Name.**
  - LANGUAGE** - Choose to view the onscreen menu in English, French or Spanish.
  - AUTO PROGRAM** - The Auto Program control will search the FM antenna signal and store any FM channel it finds in the TV's memory.
  - MANUAL STORE** - This control will allow you to manually tune any available FM signals.
  - SORT** - The Sort Control will allow you to rearrange your stored FM stations in the order you prefer.
  - NAME** - You can label or apply a name to your programmed FM radio stations. Add your own personal name or choose one from the predefined list.
- 4** Press the **CURSOR RIGHT** button to adjust or select items within the highlighted feature sub-menu.
- 5** Press the **STATUS/EXIT** button to remove the onscreen menu from the TV screen when finished. Or, let the display time out and the menu will disappear after a few second.

**SOUND**

- FEATURES
- INSTALL

**EQUALIZER**

- BALANCE
- AVL
- INCR. SURROUND
- STEREO

- SOUND
- FEATURES
- **INSTALL**

**LANGUAGE**

- AUTO PROGRAM
- MANUAL STORE
- SORT
- NAME

**INSTALL**

- **LANGUAGE**
- AUTO PROGRAM
- MANUAL STORE
- SORT
- NAME

▶ ENGLISH

FRANCAIS

ESPAÑOL

**INSTALL**

- LANGUAGE
- **AUTO PROGRAM**
- MANUAL STORE
- SORT
- NAME

▶ SEARCH

**INSTALL**

- LANGUAGE
- AUTO PROGRAM
- **MANUAL STORE**
- SORT
- NAME

SEARCH

CHANNEL

STORE

**INSTALL**

- LANGUAGE
- AUTO PROGRAM
- MANUAL STORE
- **SORT**
- NAME

FROM

TO

EXCHANGE

**INSTALL**

- LANGUAGE
- AUTO PROGRAM
- MANUAL STORE
- SORT
- **NAME**

▶ PERSONAL



## MANUAL STORE/SORT

To Manually search, store and sort FM channels follow the instructions below:

- 1** If in the FM Mode, press the **MENU** button on the remote control to display the FM Mode onscreen menu.
  - 2** Press the **CURSOR DOWN** buttons to highlight the **MANUAL STORE** option.
  - 3** Press the **CURSOR RIGHT** button to shift the menu to the left. **SEARCH** will be highlighted.
  - 4** Press the **CURSOR RIGHT** button to begin the Manual Search of available FM stations. When a station is found, the search will end until activated again.
  - 5** If the station found is one that you want to keep, press the **CURSOR DOWN** button to highlight **CHANNEL**.
  - 6** Press the **CURSOR RIGHT** button repeatedly to toggle a list of 40 channel references (FM1 to FM40).
  - 7** Press the **CURSOR DOWN** button to highlight **STORE**. Then, press the **CURSOR RIGHT** button to store the station to the selected channel reference. The onscreen menu will changed to **STORED**.
- Repeat the process for any other FM Stations.
- 8** To **SORT** the channels stored, press the **CURSOR DOWN** (while in the **INSTALL** menu options) to highlight the word **STORE**.
  - 9** Press the **CURSOR RIGHT** to shift the menu left. **FROM** will be highlighted.
  - 10** Press the **CURSOR RIGHT** button repeatedly to select one of the channel references (FM1 to FM40) you wish to move.
  - 11** Press the **CURSOR DOWN** button to highlight **TO**. Press the **CURSOR RIGHT** button repeatedly to select one of the channel references (FM1 to FM40) you want to swap the reference chosen in the previous step to.
  - 12** Press the **CURSOR DOWN** to highlight **EXCHANGE**. Press the **CURSOR RIGHT** to swap the channel reference.

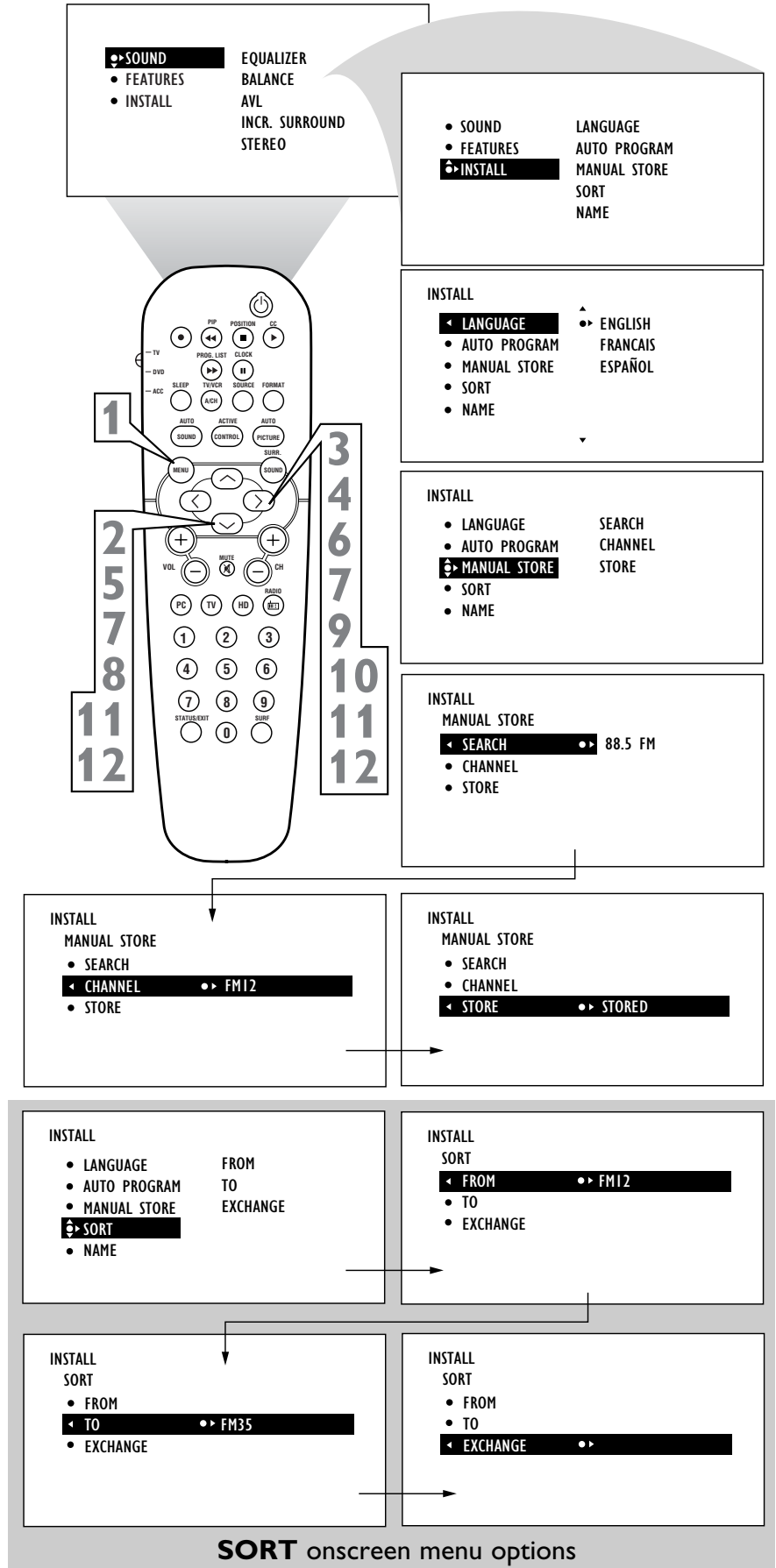



# SETTING UP THE FM MODE (FM RADIO)

## SOUND CONTROLS

To ensure the best sound quality from the FM Radio feature of this TV, several Sound Controls are available for adjustment.

- 1 To enter the FM Mode, press the **RADIO** button on the remote control. The FM Mode has its own onscreen menu options.
- 2 Press the **MENU** button on the remote control to display the FM Mode onscreen menu.
- 3 Press the **CURSOR DOWN** button until **SOUND** is highlighted.
- 4 Press the **CURSOR RIGHT** button to shift the menu to the left, accessing the **SOUND** onscreen menu options. these option include: **EQUALIZER**, **BALANCE**, **STORE**, **AVL**, **INCREDIBLE SURROUND**, **STEREO**, **AUDIO OUT**, or **SPEAKERS**.
  - EQUALIZER** - Allows the listener to change the sound frequencies to their liking.
  - BALANCE** - This controls the sound level balance between the right and left TV speakers.
  - STORE** - Once Sound controls are adjusted, activating the STORE control will save those settings in the TV's memory.
  - AVL** - Automatic Volume Leveler, when ON, will keep the volume level at a consistent level should there be sudden peaks and valleys in sound levels during commercial breaks or channel changes.
  - INCREDIBLE SURROUND** - Allows the user to select a predefined Incredible Surround setting or Stereo when the signal is stereo or Spatial and Mono when the signal is being received in mono.
  - STEREO** - Select Stereo or Mono. If the signal is being received in Mono the control cannot be placed in Stereo.
  - AUDIO OUT** - When using an external stereo for sound reproduction, the Audio Out control will allow **FIXED** or **VARIABLE** output options.
  - SPEAKERS** - When using an external speaker system, the Speaker control will allow you to turn the TV speakers **ON** or **OFF**.
- 5 Press the **STATUS/EXIT** button to remove the onscreen menu from the TV screen when finished. Or, let the display time out and the menu will disappear after a few second.

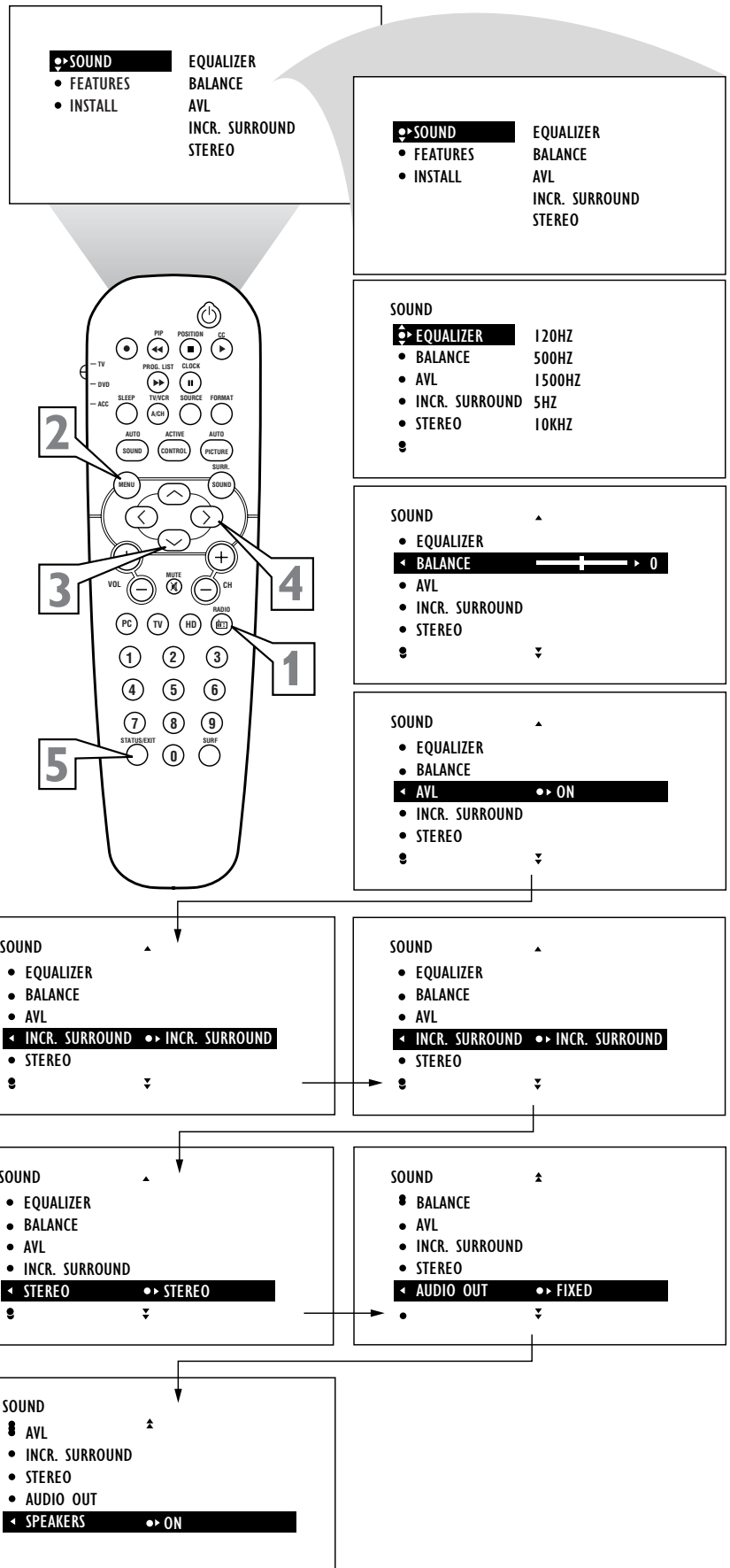



# SETTING UP THE FM MODE (FM RADIO)



## TIMER CONTROLS

The FM Radio within the TV can be set to turn on and off at a specific time, or tune to a specific channel when it powers on. The Timer controls also allows the FM Display to be turned on or off.

- 1** To enter the FM Mode, press the **RADIO** button on the remote control. The FM Mode has its own onscreen menu options.
- 2** Press the **MENU** button on the remote control to display the FM Mode onscreen menu.
- 3** Press the **CURSOR DOWN** button until **TIMER** is highlighted.
- 4** Press the **CURSOR RIGHT** button to shift the menu to the left, accessing the **TIMER** onscreen menu options. these option include: **TIME**, **START TIME**, **STOP TIME**, **CHANNEL**, **ACTIVATE**, or **DISPLAY**.

**TIME** - This is simply the Clock setting. Allows you to enter the current time.

**START TIME** - This control allows you to set a specific time you want the FM Radio to turn ON.

**STOP TIME** - This control allows you to set a specific time you want the FM Radio to turn OFF.

**CHANNEL** - This controls allows you to set a specific channel you want the FM Radio to tune to when it powers on.

**ACTIVATE** - Once the Time and channel controls have been adjusted, set Activate to ONCE or DAILY. ONCE will activate the process one time, while DAILY will activate the TIMER controls every week day.

**DISPLAY** - If set to ON, the Display control will display the current time on the TV screen when in the FM Mode.

- 5** Press the **STATUS/EXIT** button to remove the onscreen menu from the TV screen when finished. Or, let the display time out and the menu will disappear after a few second.

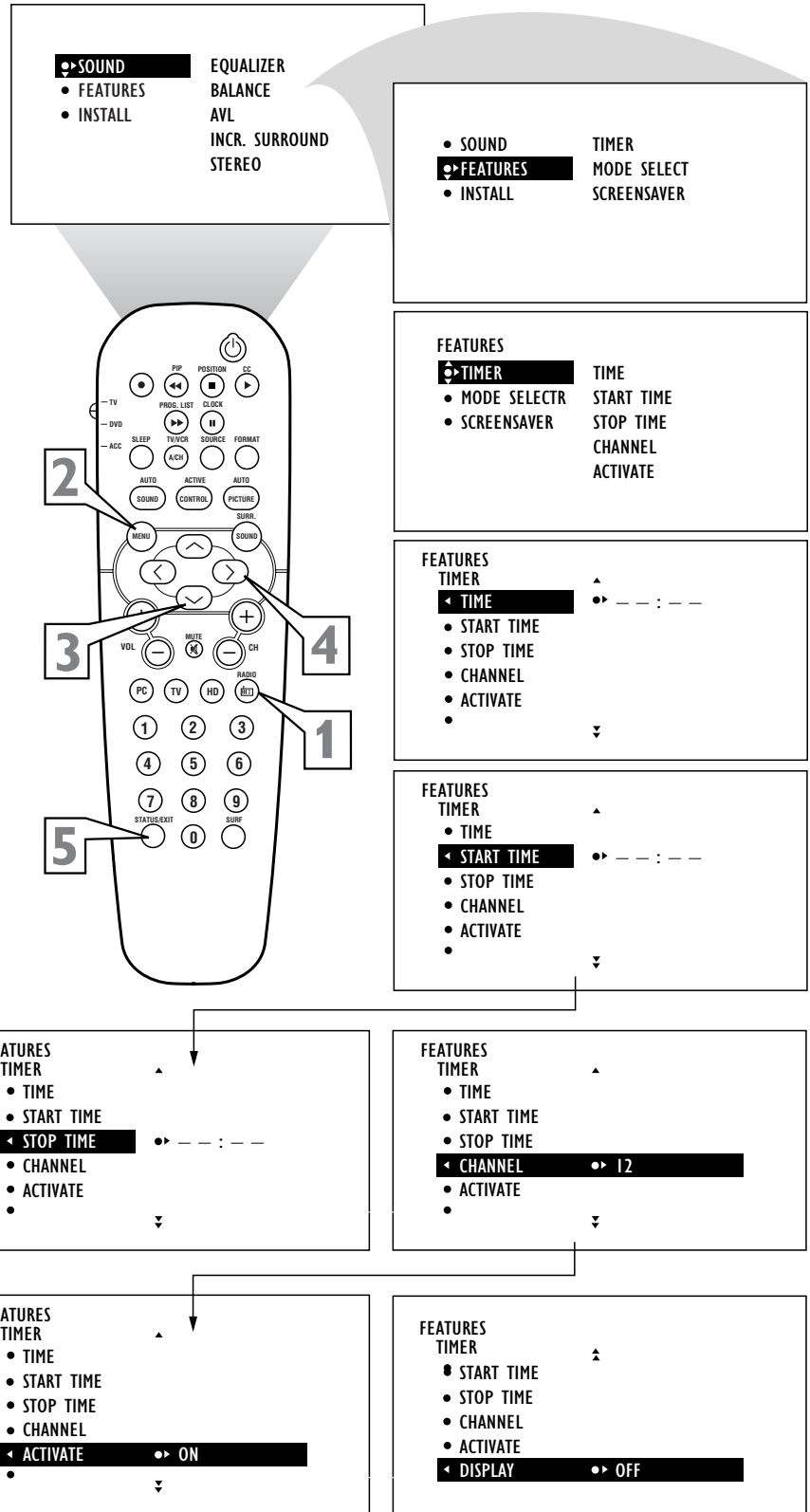



# SETTING UP THE FM MODE (FM RADIO)

## MODE SELECT CONTROLS

The Mode Select options allow you to move to other operating modes within the TV. When in the FM Mode, choose from TV, PC, or HD Modes.

- 1** If in the FM mode, press the **MENU** button on the remote control to display the FM Mode onscreen menu.
- 2** Press the **CURSOR DOWN** button until **MODE SELECT** is highlighted.
- 3** Press the **CURSOR RIGHT** button to shift the menu to the left, accessing the Mode Select onscreen menu options. Press the **CURSOR UP** or **DOWN** buttons to choose **TV**, **PC**, or **HD**.
  - TV** - This will switch the TV back to the TV Mode of operation.
  - PC** - This control will switch the TV to the PC Mode of operation. Note a PC signal must be present for this to work, or the TV will go into standby mode.
  - HD** - This control will set the TV to the High Definition Mode.
- 4** Press the **CURSOR RIGHT** button to activate the selected control and change to the highlighted mode.
- 5** Press the **STATUS/EXIT** button to remove the onscreen menu from the TV screen when finished. Or, let the display time out and the menu will disappear after a few second.

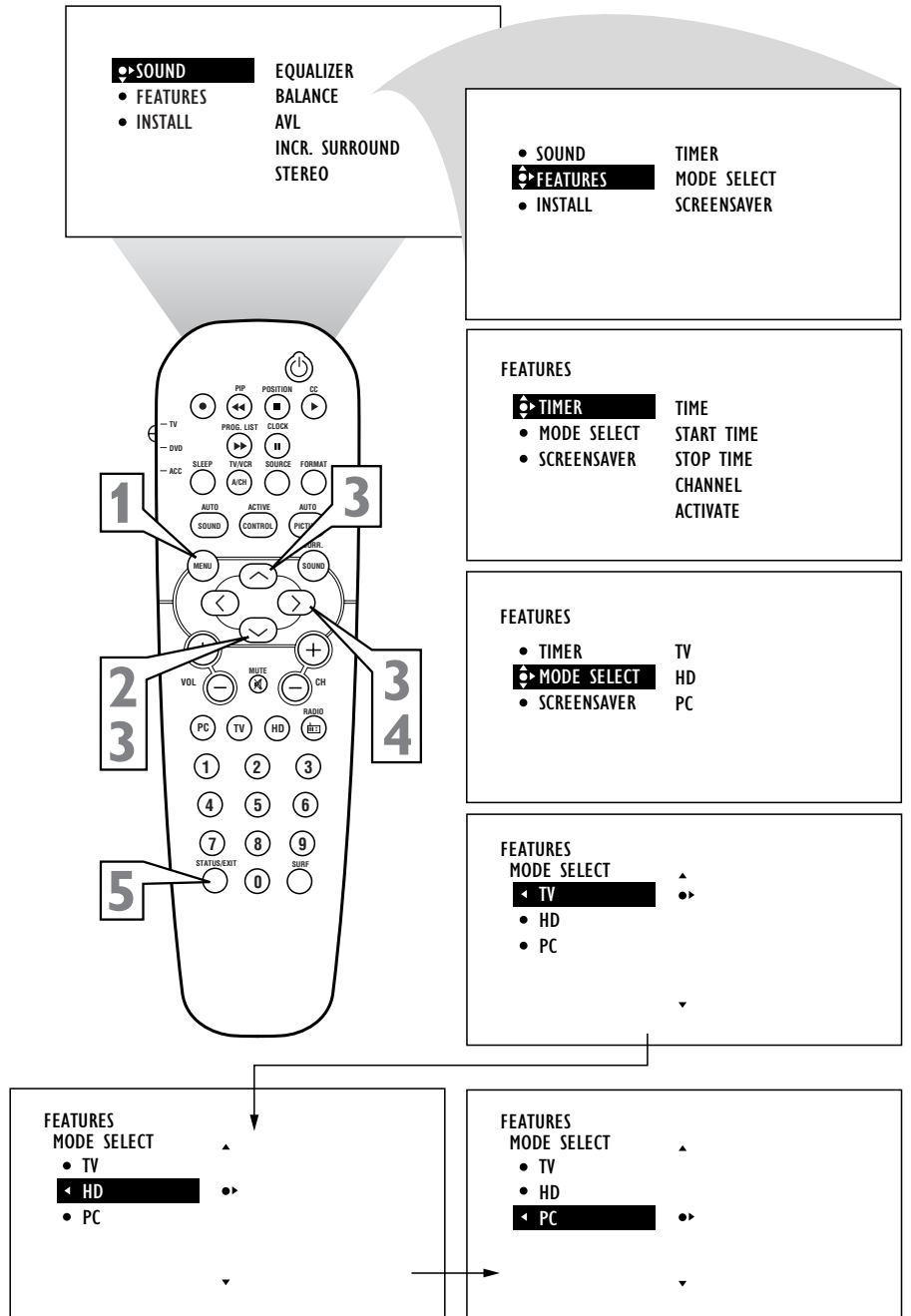



## SCREENSAVER CONTROL

**W**hile in the FM Mode, there is a Screensaver option that can be used. The Screensaver control, when on, will circulate the screen station indication around the display.

- 1** If in the FM mode, press the **MENU** button on the remote control to display the FM Mode onscreen menu.
- 2** Press the **CURSOR DOWN** button until **FEATURES** is highlighted.
- 3** Press the **CURSOR RIGHT** button to shift the menu to the left. **TIMER** will be highlighted.
- 4** Press the **CURSOR DOWN** button until **SCREENSAVER** is highlighted.
- 5** Press the **CURSOR RIGHT** or **LEFT** button to toggle the Screensaver control ON or OFF.  
With the Screensaver control set to ON, the display will shift around the screen pausing in one place for a brief moment.
- 6** Press the **STATUS/EXIT** button to remove the onscreen menu from the TV screen when finished. Or, let the display time out and the menu will disappear after a few second.

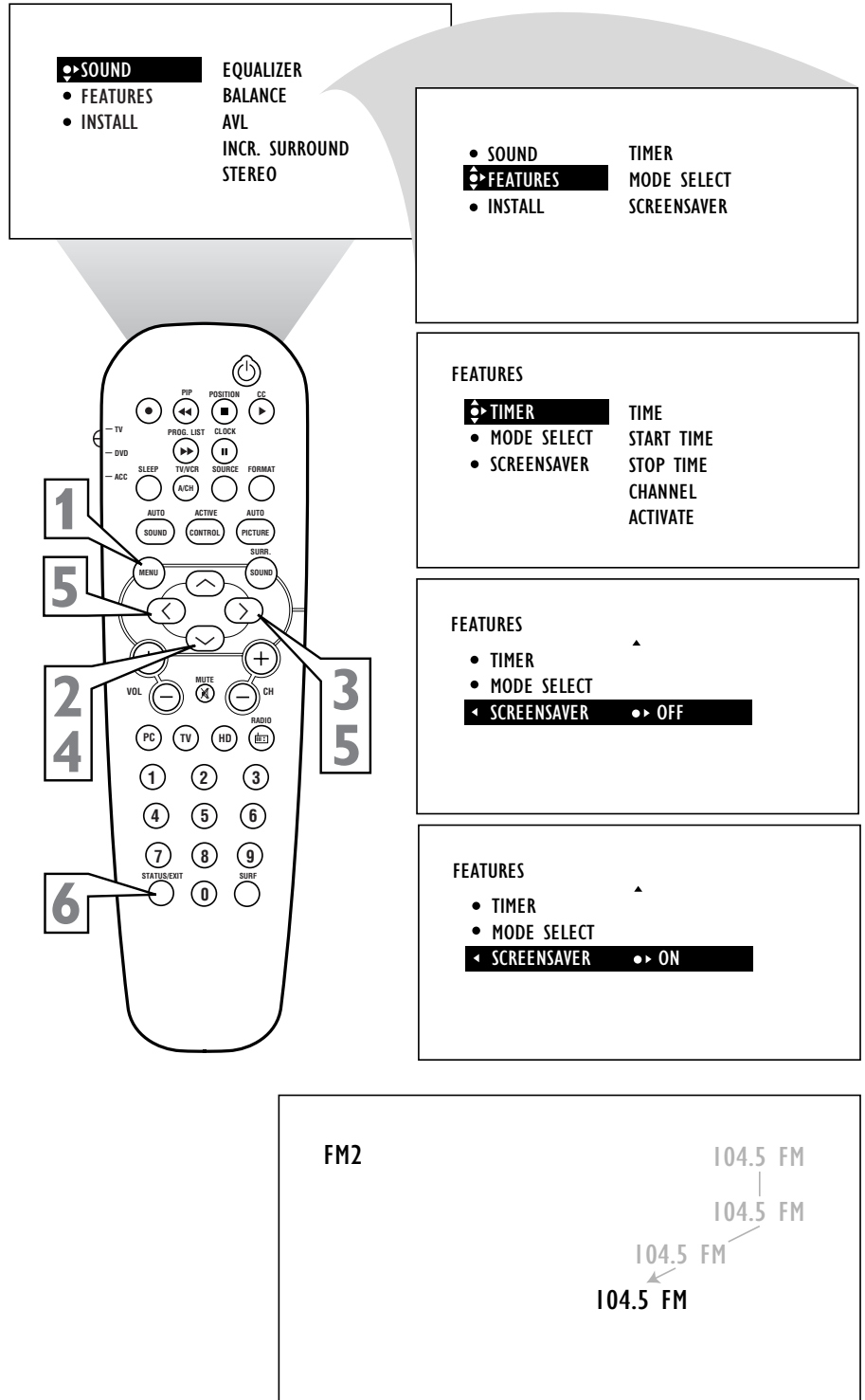



# SETTING UP THE FM MODE (FM RADIO)

## AUTO SOUND™ CONTROLS

AutoSound™ allows you to select from four factory-set controls and a personal control that you set according to your own preferences through the onscreen Sound menu within the FM Mode. The four factory-set controls (Classical, Jazz Pop, or Rock) enable you to tailor the sound so as to enhance the particular program you are listening to.

- 1** If in the FM mode, press the **AUTO SOUND** button on the remote control to display the first AutoSound™ option on the screen.
- 2** Press the **AUTO SOUND** button repeatedly to toggle through the factory pre-defined setting for the following musical styles: **CLASSICAL**, **JAZZ**, **POP**, **ROCK** or **PERSONAL** (the way you set the equalizer).

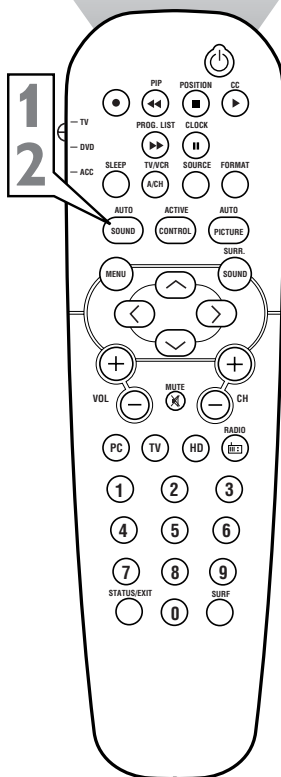
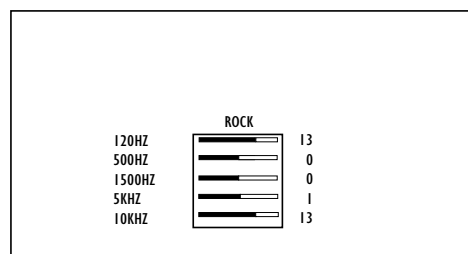
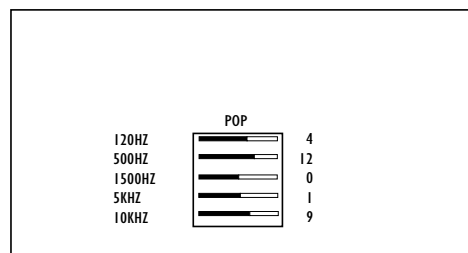
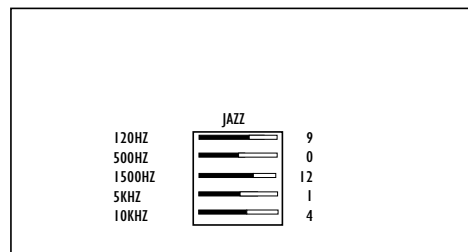
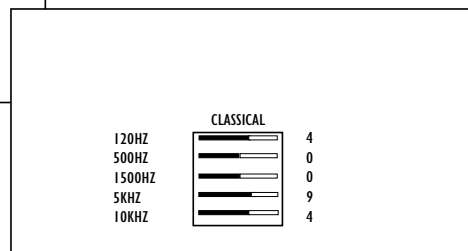
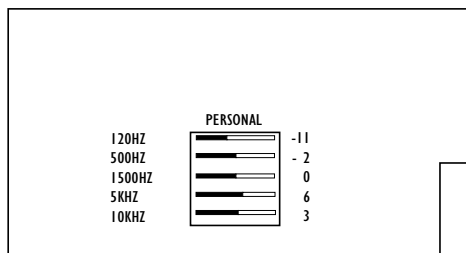

# SETTING UP THE HD MODE (HIGH DEFINITION)



## PICTURE CONTROLS

The HD Mode offers certain Picture, Sound and Blocking options within its onscreen menu. Below is a list of Picture Menu options.

- 1** Press the **HD** button on the remote control to place the TV in the HD Mode (HD1).
- 2** Press the **MENU** button on the remote control to display the HD Mode onscreen menu. The **PICTURE** option will be highlighted.
- 3** Press the **CURSOR UP** or **DOWN** buttons until **PICTURE** is highlighted.
- 4** Press the **CURSOR RIGHT** button to shift the menu to the left, accessing the Picture onscreen menu options.
- 5** Press the **CURSOR UP** or **DOWN** buttons to highlight any of the HD Mode Picture Controls. Choose from: **BRIGHTNESS**, **COLOR**, **PICTURE**, **SHARPNESS**, **TINT**, **COLOR TEMP**, or **VIEW FORMAT**.

**BRIGHTNESS** - This control will add or subtracts light from the darkest part of the picture.

**COLOR** - This control adds or eliminates color intensity from the picture.

**PICTURE** - This control improves the detail of the lightest parts of the picture.

**SHARPNESS** - This control improves the detail in the picture.

**TINT** - This control adjusts the picture to obtain natural skin tones.

**COLOR TEMP** - Choose from **NORMAL** (keeps whites, white), **COOL** (makes whites, bluish), or **WARM** (makes whites, reddish) picture preferences.

**VIEW FORMAT** - Choose between the **FULL SCREEN** or **WIDE SCREEN** formats.

**6** Press the **CURSOR RIGHT** or **LEFT** buttons to adjust the selected control.

**7** Press the **STATUS/EXIT** button to remove the onscreen menu from the TV screen when finished. Or, let the display time out and the menu will disappear after a few second.

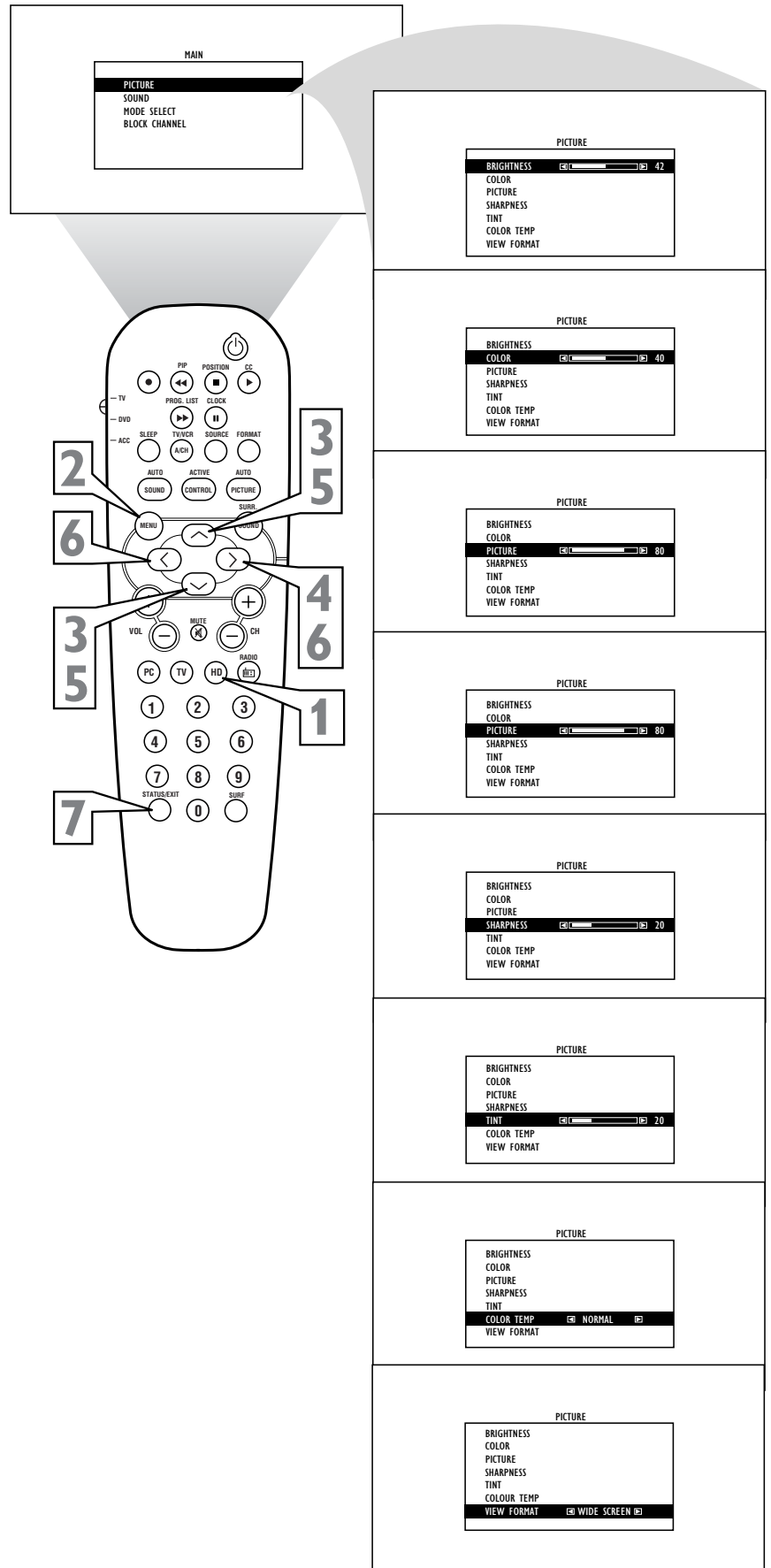



## SETTING UP THE HD MODE (HIGH DEFINITION)

### SOUND CONTROLS

The HD Mode also offers certain Sound control adjustments to fine tune the sound being heard when in the HD Mode.

- 1** Press the **HD** button on the remote control to place the TV in the HD Mode (HD1).
- 2** Press the **MENU** button on the remote control to display the HD Mode onscreen menu. The PICTURE option will be highlighted.
- 3** Press the **CURSOR UP** or **DOWN** buttons until **SOUND** is highlighted.
- 4** Press the **CURSOR RIGHT** button to shift the menu to the left, accessing the **SOUND** onscreen menu options.
- 5** Press the **CURSOR UP** or **DOWN** buttons to highlight any of the HD Mode Sound Controls. Choose from: **EQUALIZER**, **BALANCE**, or **AVL**.  
**EQUALIZER** - Allows the listener to change the sound frequencies to their liking.  
**BALANCE** - This controls the sound level balance between the right and left TV speakers.  
**AVL** - Automatic Volume Leveler, when ON, will keep the volume level at a consistent level should there be sudden peaks and valleys in sound levels during commercial breaks or channel changes.
- 6** Press the **CURSOR RIGHT** or **LEFT** buttons to adjust the selected control.
- 7** Press the **STATUS/EXIT** button to remove the onscreen menu from the TV screen when finished. Or, let the display time out and the menu will disappear after a few second.

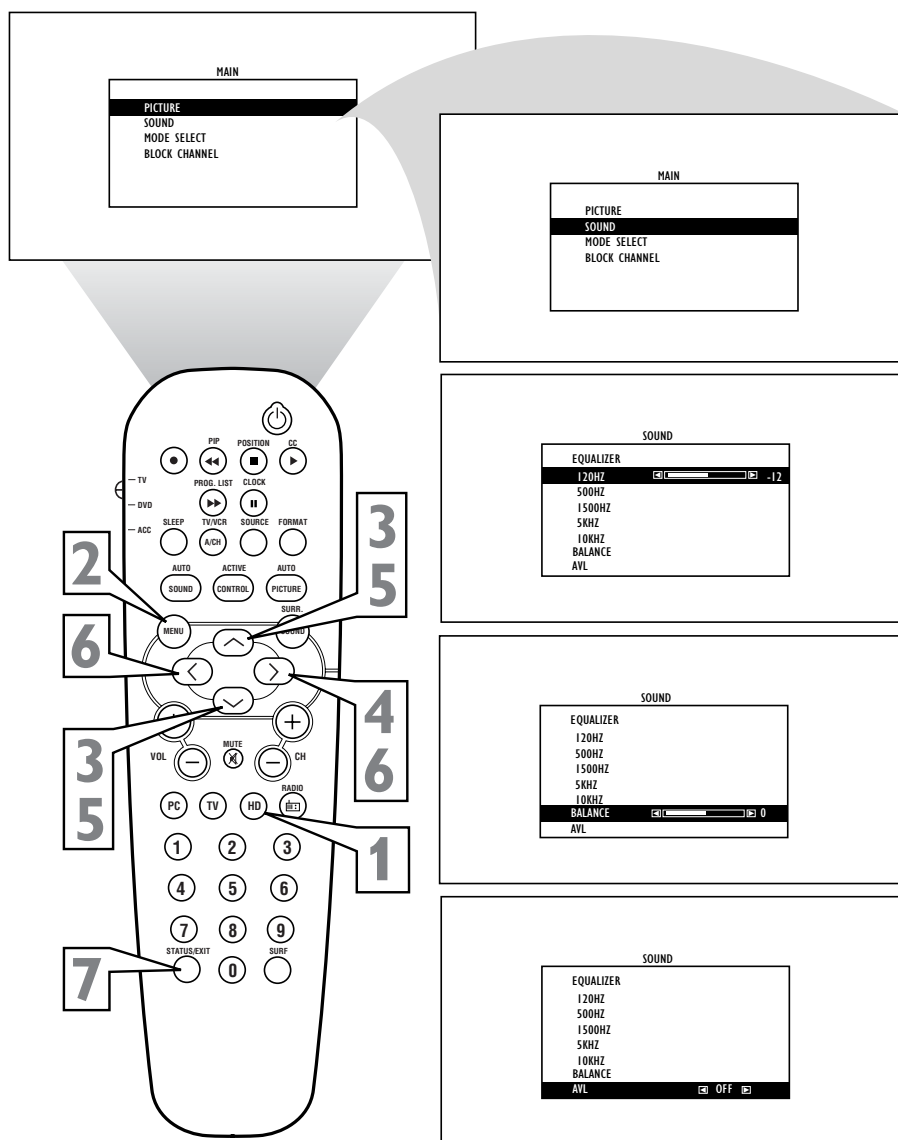



## HD SELECT CONTROL

The HD Select Control will allow you to quickly change from the HD Mode of operation to the TV, FM Radio, or PC Modes.

- 1** If in the HD Mode, press the **MENU** button on the remote control to display the HD Mode onscreen menu. The **PICTURE** option will be highlighted.
- 2** Press the **CURSOR UP** or **DOWN** buttons until **MODE SELECT** is highlighted.
- 3** Press the **CURSOR RIGHT** button to shift the menu to the left displaying the **MODE SELECT** options. Choose from **TV MODE**, **FM RADIO MODE**, or **PC MODE**.
- 4** Press the **CURSOR RIGHT** button to activate the highlighted mode control.

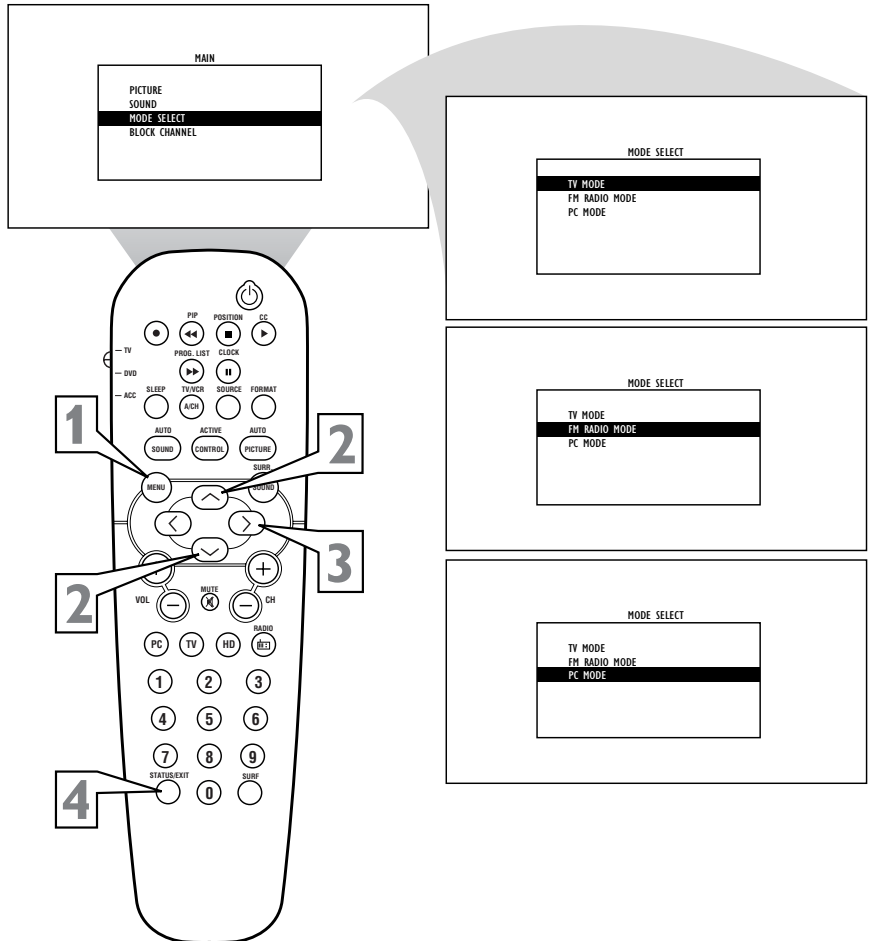



# SETTING UP THE HD MODE (HIGH DEFINITION)

## BLOCK CHANNEL CONTROL

The HD Mode channel can be blocked to censor the viewing of programming not suitable for children. To block the HD Mode channel, follow the steps below.

- 1** Press the **HD** button on the remote control to place the TV in the HD Mode (HD1).
- 2** Press the **MENU** button on the remote control to display the HD Mode onscreen menu. The PICTURE option will be highlighted.
- 3** Press the **CURSOR UP** or **DOWN** buttons until **BLOCK CHANNEL** is highlighted.
- 4** Press the **NUMBERED** buttons and enter your four digit Access Code that was setup for the TV AutoLock feature. The Block Channel Control will be available for adjustment.
- 5** Press the **CURSOR RIGHT** button to toggle the control ON or OFF. If set to ON, the HD1 channel (mode) will not allow viewing of programs. This control would have to be set to OFF to make the HD1 channel (mode) viewable.
- 6** Press the **STATUS/EXIT** button to remove the onscreen menu from the TV screen when finished.

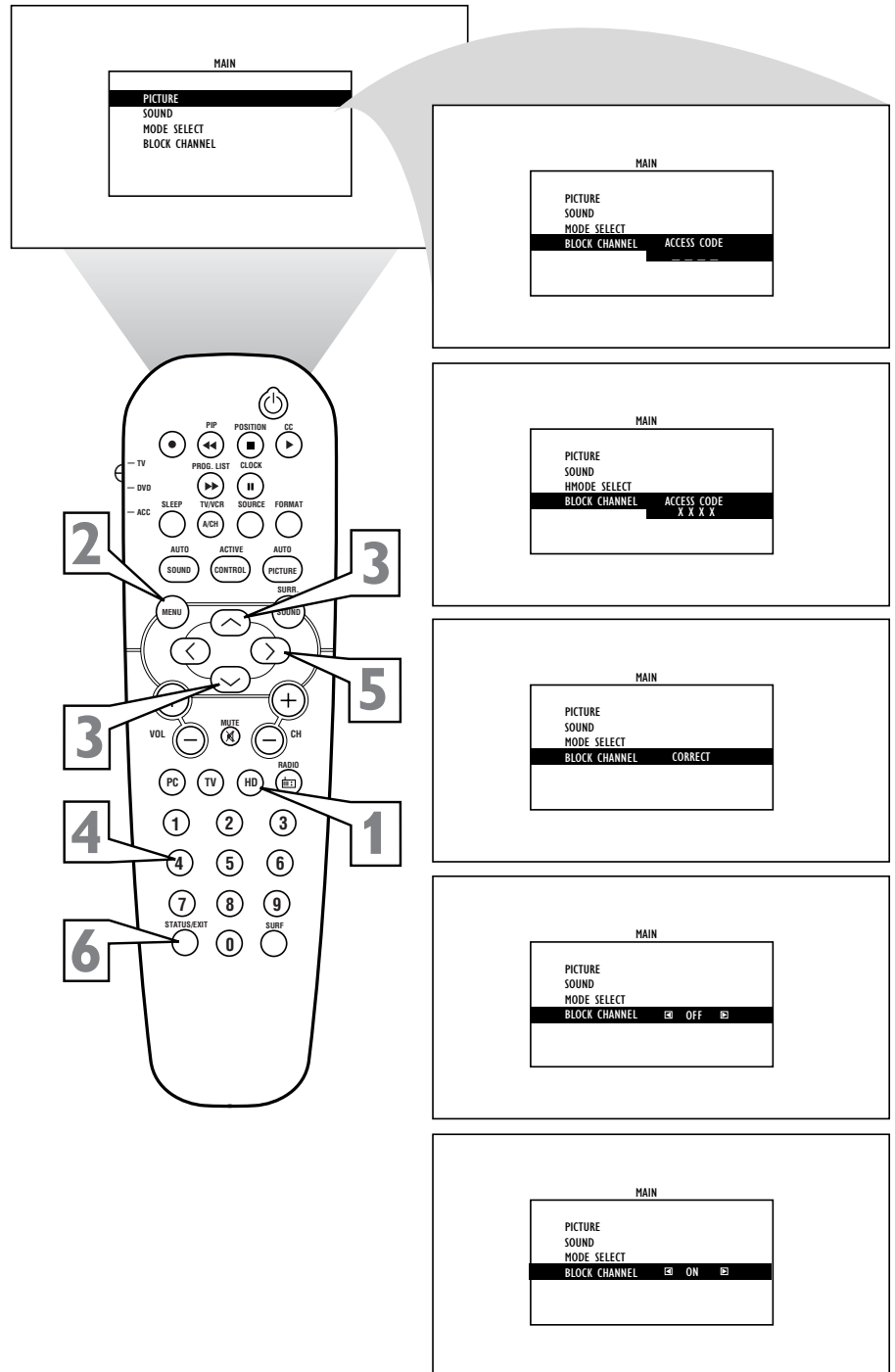



# SETTING UP THE PC MODE (PERSONAL COMPUTER MONITOR)



## PC MODE CONTROLS

The TV can be used as a PC Monitor. A PC video signal must be present or the TV will go into standby mode.

Follow the steps below to access and adjust the onscreen PC Menu controls.

- 1 Press the **PC** button on the remote control to place the TV in the PC Mode.
- 2 Press the **MENU** button on the remote control to display the PC Mode onscreen menu. The **AUDIO SELECTION** option will be highlighted.
- 3 Press the **CURSOR UP** or **DOWN** buttons to highlight any of the listed onscreen menu options.

Choose from:

**AUDIO SELECTION** - Will allow the Audio Source to come from the PC, the TV, or the FM Radio.

**BRIGHTNESS & CONTRAST** - Allows you to adjust the Brightness and Contrast picture levels.

**ADJUST COLOR** - This control allow you to set the Color Temperature of the picture. Choose between the Normal, Cool or Warm pre-defined settings.

**VIDEO NOISE** - Will allow you to remove any flickering Vertical or Horizontal bars that may appear on the screen.

**ADJUST POSITION** - This control will allow you to move the onscreen picture horizontally or vertically for better viewing pleasure.

**AUTO ADJUST** - The Auto Adjust will automatically adjust the control based on the signal being received to give the best possible picture.

**PIP CONTROLS** - change the Size and Position of the PIP window on the screen when the PIP button is used.

**MODE SELECT** - Enter the TV or FM Mode using this control.

**RESET TO FACTORY SETTINGS** - Will reset all setting to the factory default values.

**VIEW FORMATS** - Choose between the **NATIVE** (the format that is dictated by the type of accessory device being used) and **WIDE SCREEN** formats.

- 4 Press the **CURSOR RIGHT** button to enter the sub-menu of any of the highlighted onscreen menu controls.
- 5 Use the **CURSOR UP, DOWN, RIGHT** or **LEFT** buttons to navigate, adjust or activate the specific controls.
- 6 Press the **STATUS/EXIT** button to remove the onscreen menu from the TV screen when finished.

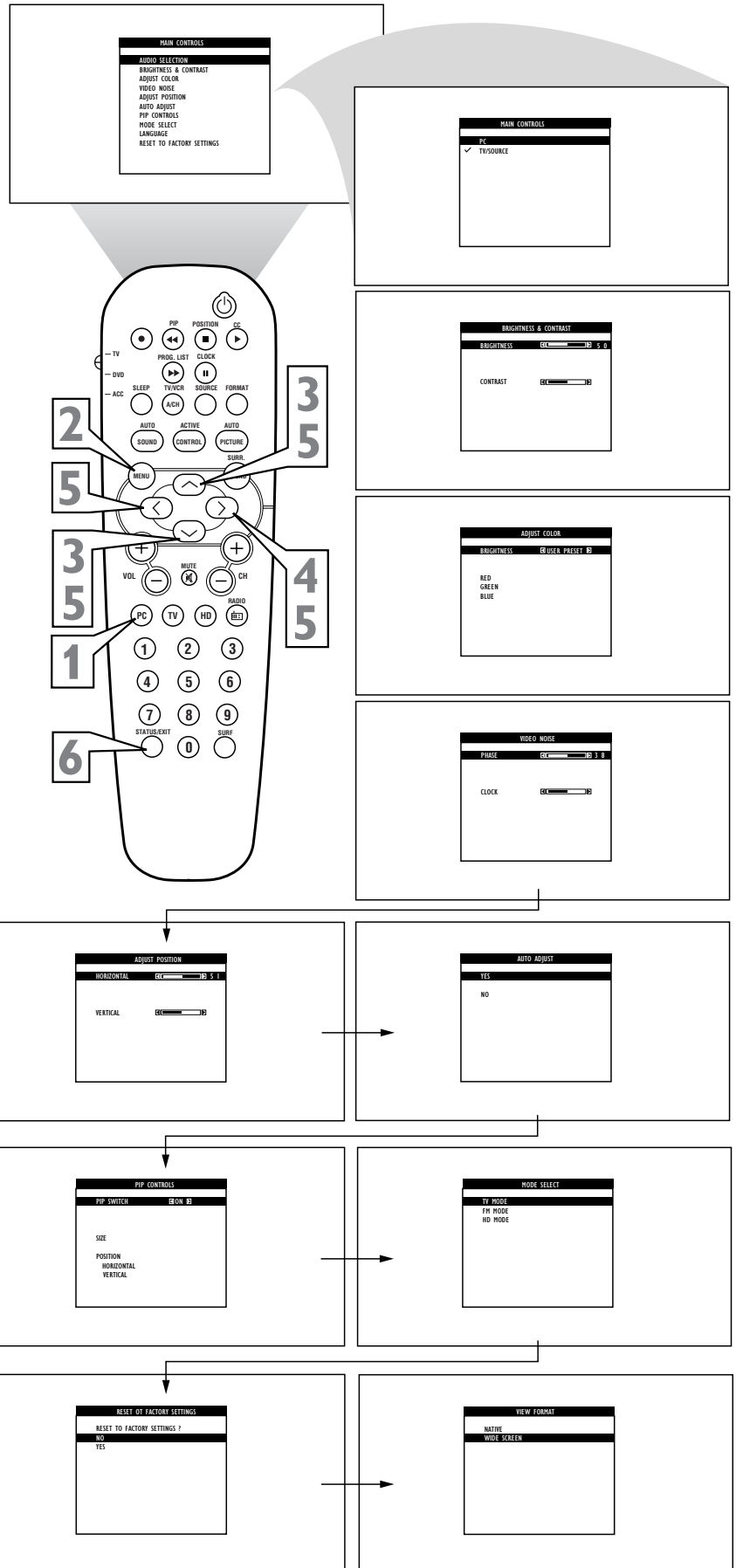



## SETTING UP THE PC MODE (PERSONAL COMPUTER MONITOR)

No.	Resolution	Refresh Rate	Vertical Sync	Horizontal Sync	Horizontal Polarity	Pixel Frequency
1	640 x 480	60 Hz	N	31,500 kHz	N	25,175 MHz
2		67 Hz	N	35,000 kHz	N	30,240 MHz
3		72 Hz	N	37,900 kHz	N	31,500 MHz
4		75 Hz	N	37,500 kHz	N	31,500 MHz
5		85 Hz	N	43,300 kHz	N	36,000 MHz
6	720 x 400	70 Hz	P	31,469 kHz	N	28,322 MHz
7	800 x 600	56 Hz	P	35,100 kHz	P	36,000 MHz
8		60 Hz	P	37,900 kHz	P	40,000 MHz
9		72 Hz	P	48,100 kHz	P	50,000 MHz
10		75 Hz	P	46,900 kHz	P	49,500 MHz
11		85 Hz	P	53,700 kHz	P	56,250 MHz
12	832 x 624	75 Hz	P	49,700 kHz	P	57,300 MHz
13	1024 x 768	60 Hz	N	48,400 kHz	N	65,000 MHz
14		70 Hz	N	56,500 kHz	N	75,000 MHz
15		75 Hz	P	60,000 kHz	P	78,750 MHz
16		85 Hz	P	68,700 kHz	P	94,500 MHz
17	1152 x 864	75 Hz	P	67,500 kHz	P	108,000 MHz
18	1280 x 960	60 Hz	P	60,000 kHz	P	108,000 MHz
19	1280 x 1024	60 Hz	P	64,000 kHz	P	108,000 MHz
20		75 Hz	P	80,000 kHz	P	135,000 MHz



### No Power

- Check the TV power cord. Unplug the TV, wait 10 seconds, then reinsert the plug into the outlet and push the POWER button again.
- Check that the outlet is not on a wall switch.
- Be sure the fuse is not blown on the AC power strip, if one is being used.

### No Picture

- Check antenna/cable connections. Are they properly secured to the TV's ANT 75Ω plug?
- Check the TUNER MODE control for the correct tuner setting.
- Try running the Auto Program feature to find all available channels.
- Press the SOURCE button on the remote to make sure the correct signal source is selected.
- If using an accessory device, be sure that it is functioning properly.
- If in PC Mode, a video signal MUST BE present or the TV will turn off.

### No Sound

- Check the VOLUME buttons.
- Check the MUTE button on the remote control.
- If you're attempting to hook up auxiliary equipment, check the audio jack connections.

### TV Only Produces MONO Sound

- If using a cable box with RF only type connections, the signal coming from the cable box will be produced in MONO only.
- Check Sound control setting. Change setting to Stereo.

### Remote Does Not Work

- Check the batteries. If necessary, replace them with AA Heavy Duty (Zinc Chloride) or Alkaline batteries.
- Clean the remote control and the remote control sensor window on the TV.
- Check the TV power cord. Unplug the TV, wait 10 seconds, then reinsert the plug into the outlet and push the POWER button again.
- Be sure the fuse is not blown on the AC power strip, if one is being used.
- Check to be sure the TV outlet is not on a wall switch.
- Be sure that the remote is in the correct operating mode.
- Be sure the remote is pointed at the Remote Sensor Window on the TV. See page 1 of the *Quick Use Guide* for details.

### TV Displays Wrong Channel or No Channels Above 13

- Repeat channel selection.
- Add the desired channel numbers (using the CHANNEL EDIT control) into the TV's memory.
- Check to be sure the TUNER MODES are set to the CABLE option and run the Auto Program feature to find all available channels.

## CLEANING AND CARE



### WARNING Concerning Stationary Images on the TV Screen:

**Do not leave stationary or letterbox images on screen for extended periods of time. This can cause uneven display aging.**

Normal use of the TV should involve the showing of pictures that contain constantly moving and changing images that fill the screen. Be careful not to leave nonmoving images on screen for extended periods of time, or to display the same images on screen too frequently, because subtle ghost images can be left on the picture tubes. Sources of stationary images may be DVD disks, laser disks, video games, CD-i disks, videotapes, digital television boxes, broadcast channels, cable channels, satellite channels, and others. **Here are some examples of stationary images (this is not an all-inclusive list; you may encounter others in your viewing):**

- **DVD menus**—listings of DVD disk content
- **Letterbox black bars**—shown at the top and bottom of the TV screen when a wide screen (16:9) movie is viewed on a TV with standard (4:3) aspect ratio.
- **Video-game images and scoreboards**
- **Television station logos**—present a problem if they are bright and stationary; moving or low-contrast graphics are less likely to cause uneven aging of the picture tube
- **Stock-market tickers**—presented at the bottom of the TV screen
- **Shopping channel logos and pricing displays**—bright and shown constantly or repeatedly in the same location on the TV screen.

### PLACEMENT OF THE TV

- To avoid cabinet warping, cabinet color changes, and increased chance of set failure, do not place the TV where temperatures can become excessively hot; for example, in direct sunlight or near a heating appliance.
- Be sure to allow a free flow of air to and from the perforated back cover of the set.

### CLEANING

- To avoid possible shock hazard, be sure the TV is unplugged from the electrical outlet before cleaning.
- Regularly dust the TV with a dry, nonscratching duster to keep the TV clean.
- When cleaning the TV, take care not to scratch or damage the screen surface. Avoid wearing jewelry or using anything abrasive. Do not use household cleaners. Wipe the front screen with a clean cloth dampened with water. Use even, easy, vertical strokes when cleaning.
- Gently wipe the cabinet surfaces with a clean cloth or sponge dampened in a solution of cool, clear water and a mild soap or detergent. Use a clean, dry cloth to dry the wiped surfaces. Do not use acetone, toluene, or alcohol to clean the screen.
- Occasionally vacuum the ventilation holes or slots in the back cover of the set.
- Never use thinners, insecticide sprays, or other chemicals on or near the cabinet, as they might cause permanent marring of the cabinet finish.



## GLOSSARY OF TERMS

**Active Control** • Active Control continuously measures and corrects the incoming signals to provide the best picture possible.

**Audio/Video Inputs** • Jacks (standard RCA), located on the back of the TV, used for external accessory devices. These jacks are designed to receive higher picture resolution and offer sound-connection options.

**Auto Programming** • When activated, this feature scans for all available channels from regular antenna or cable signals and stores only active broadcast stations in the TV's memory.

**Channel Edit** • The feature that allows you to add or delete channels from the list of channels stored in the TV's memory.

**Closed Captioning** • The broadcast standard feature that allows you to read the voice content of television programs on the TV screen. Designed to help the hearing impaired, Closed Captioning shows dialogue and conversations while a TV program is in progress.

**Coaxial Cable** • A single solid wire normally matched with a metal plug (F-type) end connector that screws (or pushes) directly onto a 75-ohm input found on the television or VCR.

**Component Video Inputs** • Inputs that allow the separate reception of blue, red, and luminance signals. These inputs provide the highest possible color and picture resolution in the playback of digital signal-source material, such as the kind available from DVD players.

**Composite Video Input** • An input in which all the components required for displaying the onscreen image are combined in one signal.

**High-definition Television (HDTV)** • High-resolution digital television.

**Incredible Surround** • False acoustic management of the audio signal that produces a dramatic expansion of the wall of sound that surrounds the listener and heightens overall viewing pleasure.

**Menu** • An onscreen list of feature controls available for you to adjust or set.

**Onscreen Displays (OSD)** • The wording or messages generated by the television (or VCR) to help you with specific feature controls (color adjustment or programming, for example).

**Remote Control Sensor Window** • The window or opening found on the television control panel through which infrared remote control command signals are received.

**Second Audio Program (SAP)** • An additional audio channel provided for in the Multichannel Television Sound (MTS) broadcast standard. A monaural soundtrack included within the recorded or video signal (usually containing a second language translation for the displayed programming).

**Status/Exit Button** • The remote control function that allows you to quickly confirm what channel number you are watching. Status/Exit can also be used to clear the television of onscreen displays or information. You can use Status/Exit rather than having to wait for the displays to "time out," or automatically disappear from the screen.

**S-Video Input** • Signal input that allows direct connection of high-resolution video sources, such as a satellite receiver, DVD player, S (Super)-VHS videocassette recorder, or video games. Provides improved picture resolution, sharpness, and clarity.

**Tint** • TV function that allows you to change the general color balance between cool and warm. Adjust tint according to your personal preference.



Cleaning and Care .....	59	<i>AutoLock Controls</i>	
Factory Service Locations .....	62-63	Access Code .....	25
<b>FM Radio Mode Controls</b>		Block Channels .....	26
<i>AutoSound™ Control</i> .....	52	Blocking Options .....	30
<b>Install Menu Controls</b>		Clear All Blocked Channels .....	27
Auto Program Control .....	46	Movie Ratings .....	28
Language Control .....	46	Review Screen .....	31
Manual Store Control .....	46-47	TV Ratings .....	29
Name (FM Channel Label) Control .....	46	Understanding the AutoLock™ Control .....	24
Sort Control .....	46-47	<i>AutoSound™ Control</i> .....	37
<b>Mode Select Control</b> .....	50	<i>Auto Program Control</i> .....	8
<b>Screensaver Control</b> .....	51	<i>AutoPicture™ Control</i> .....	36
<b>Sound Adjustment Controls</b>		<i>AVL (Auto Volume Leveler) Control</i> .....	15
Audio Out Control .....	48	<i>Balance Control</i> .....	14
AVL (Auto Volume Leveler) Control .....	48	<i>Channel Edit (Add or Delete Channels) Control</i> .....	9
Balance Control .....	48	<i>Closed Captioning Control</i> .....	32
Equalizer Controls .....	48	<i>Equalizer Control</i> .....	13
Incredible Surround Control .....	48	<i>Incredible Surround Control</i> .....	16
Speaker Control .....	48	<i>Language Control</i> .....	6
Stereo Control .....	48	<i>Mode Select Control</i> .....	22
<b>Timer Controls</b> .....	49	<i>Name (Channel Label) Control</i> .....	11
Glossary of Terms .....	60	<i>Picture Adjustment Controls</i> .....	12
<b>HD Mode Controls</b>		<i>Program List Control</i> .....	34
<i>Block Channel Control</i> .....	56	<i>Remote Control Programming for Accessory Devices</i>	
<i>HD Installation Control</i> .....	55	Accessory Device Remote Control Buttons .....	45
<i>Mode Select Control</i> .....	55	Code Entry Method .....	40
<i>Picture Adjustment Controls</i> .....	53	Code List .....	42-44
<i>Sound Adjustment Controls</i> .....	54	Direct Access Method .....	39
Index .....	61	Search Method .....	41
PC Mode Controls .....	57-58	<i>SAP (Secondary Audio Programming) Control</i> .....	18
Registration Information .....	2	<i>Sleeptimer Control</i> .....	35
Safety/Precautions .....	3-4	<i>Stereo/Mono Control</i> .....	17
Table of Contents .....	5	<i>Surf Control</i> .....	38
Troubleshooting Tips .....	55	<i>Timer Controls</i> .....	21
<b>TV Mode Controls</b>		<i>Tuner Mode Control</i> .....	7
<i>Active Control</i> .....	23	<i>TV Speaker Control</i> .....	20
<i>Audio Out Control</i> .....	19	<i>Widescreen (Screen Format) Control</i> .....	33
<i>AutoChron™ Control</i> .....	10	Warranty .....	64



# FACTORY SERVICE LOCATIONS

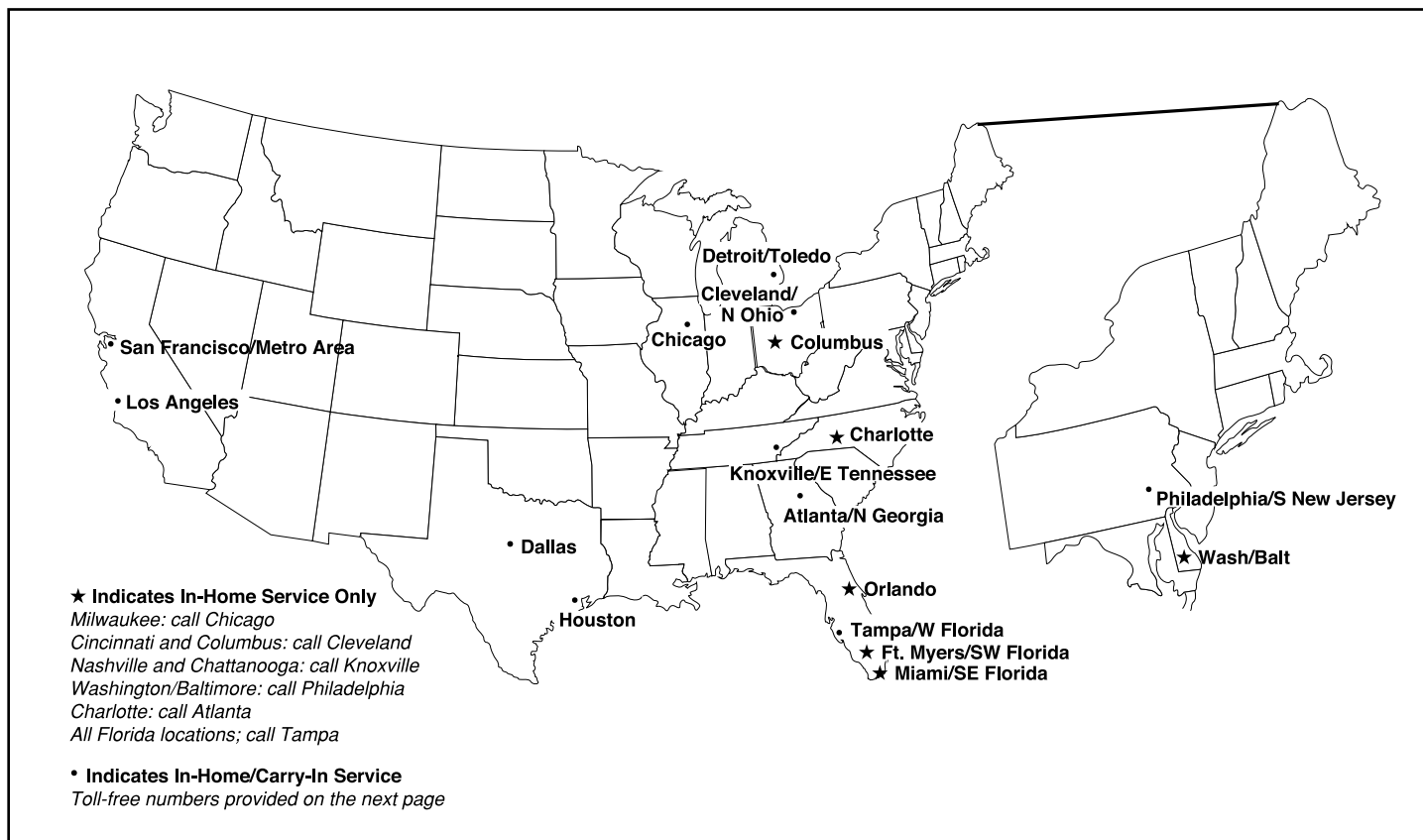

**NOTE:** If you reside in one of our Philips Factory Service Branch areas (see directory on back), you can contact the nearest Service Branch to obtain efficient and expedient repair for your product. If your product is In-Warranty, you should have proof-of-purchase to ensure No Charge Service. For Out-of-Warranty service, call the location nearest you.

**NOTE:** Si vous résidez dans une des régions desservies par une succursale de service après vente du fabricant Philips (voir liste ci-dessous), vous pourrez contacter la branche de service après vente la plus près de chez vous pour obtenir un service après vente rapide et efficace. Si le produit est sous garantie, il suffira de présenter une preuve d'achat pour bénéficier d'un service sans frais. Pour les produits non couverts par la garantie, contactez le centre le plus près de chez vous.

**NOTE:** Si Ud. reside en una de nuestras zonas para sucursales Philips de servicio al de fábrica (ver directorio más abajo), Ud. puede comunicarse con la sucursal de servicio más cercana para obtener una reparación oportuna y eficaz de su producto. Si su producto está todavía bajo garantía, Ud. debe presentar comprobante de compra para no ocasionar ningunos cargos por servicio. Para servicio después del vencimiento de la garantía, llame al lugar más cercano de los abajo indicados.

## In Canada

How you can obtain efficient and expedient carry-in, mail-in, or in-home service for your product

Please contact Philips at  
 1-800-661-6162 (French speaking)  
 1-800-531-0039 (English or Spanish speaking)

## Au Canada

Comment obtenir le service après-vente pour les produits apportés ou envoyés par la poste à notre centre de service ou le service à domicile

Veuillez contacter philips à:  
 1-800-661-6162 (Francophone)  
 1-800-531-0039 (Anglais ou Espagnol)

## En el Canadá

Cómo recibir servicio eficiente para su producto, en persona, por correo o a domicilio

Favor de comunicarse con Philips al:  
 1-800-661-6162 (francófono)  
 1-800-531-0039 (Inglés o Español))

# FACTORY SERVICE LOCATIONS



**QUALITY SERVICE IS AS CLOSE AS YOUR TELEPHONE! SIMPLY LOOK OVER THE LIST BELOW FOR THE NUMBER OF A FACTORY SERVICE CENTER NEAR YOU. YOUR PRODUCT WILL RECEIVE EFFICIENT AND EXPEDIENT CARRY-IN, MAIL-IN, OR IN-HOME SERVICE, AND YOU WILL RECEIVE PEACE OF MIND, KNOWING YOUR PRODUCT IS BEING GIVEN THE EXPERT ATTENTION OF PHILIPS' FACTORY SERVICE.**

COMMENT OBTENIR NOTRE SERVICE APRÈS VENTE RAPIDE ET EFFICACE SOIT PAR COURRIER, À DOMICILE, OU EN SE PRÉSENTANT À UN CENTRE DE SERVICE PHILIPS. PLUS DE 600 CENTRES DE RÉCEPTION DE PRODUITS À RÉPARER À TRAVERS LE PAYS: CONTACTER LE CENTRE DE SERVICE AUX CONSOMMATEURS LE PLUS PROCHE POUR SAVOIR L'EMPLACEMENT DE CES DÉPÔTS DANS UN RAYON DE 50 À 75 MILES (80 KM À 120 KM) DU CENTRE DE SERVICE LOCAL.

CÓMO OBTENER UN SERVICIO OPORTUNO Y EFICIENTE POR CORREO, EN CASA O EN PERSONA PARA SU PRODUCTO A TRAVÉS DE UN CENTRO PHILIPS DE SERVICIO. MAS DE 600 SITIOS POR TODO EL PAIS PARA LA RECEPCION DE PRODUCTOS NECESITADOS DE REPARACIONES: COMUNICARSE CON EL CENTRO DE SERVICIO DE FABRICA MAS CERCANO PARA ESTOS LUGARES DENTRO DE UN RADIO DE 80 A 120 KM (50 A 75 MILLAS) DEL CENTRO DE SERVICIO LOCAL.

## **ATLANTA**

Philips Factory Service  
550 Franklin Road., Suite F  
Marietta, GA 30067  
800-273-1501

## **TAMPA**

Philips Factory Service  
1911 US Highway 301 North, Suite 100  
Tampa, FL 33619  
800-442-2027

## **SAN FRANCISCO**

Philips Factory Service  
681 East Brokaw Rd.  
San Jose, CA 95112  
800-300-9013

## **HOUSTON**

Philips Factory Service  
1110 N. Post Oak Rd., Suite 100  
Houston, TX 77055  
800-952-3254

## **CLEVELAND**

Philips Factory Service  
950 Keynote Circle  
Brooklyn Heights, OH 44131  
800-331-7037

## **DETROIT**

Philips Factory Service  
25173 Dequindre  
Madison Heights, MI 48071  
800-438-1398

## **DALLAS**

Philips Factory Service  
415 N. Main Street, #107  
Euless, TX 76040  
800-952-3254

## **LOS ANGELES**

Philips Factory Service  
20930 Bonita, Ste. V  
Carson, CA 90746  
800-300-9013

## **CHICAGO**

Philips Factory Service  
1279 W. Hamilton Pkwy.  
Itasca, IL 60143  
800-531-2922

## **KNOXVILLE**

Philips Factory Service  
One Philips Drive  
Knoxville, TN 37914  
800-821-1767

## **PHILADELPHIA**

Philips Factory Service  
352 Dunks Ferry Rd.  
Bensalem, PA 19020  
800-847-9320



# LIMITED WARRANTY

## LCD COLOR TELEVISION

One Year Free Labor

One Year Free Replacement of Parts

This product must be carried in for service.

### WHO IS COVERED?

You must have proof of purchase to receive warranty service. A sales receipt or other document showing that you purchased the product is considered proof of purchase.

### WHAT IS COVERED?

Warranty coverage begins the day you buy your product. For one year thereafter, all parts will be repaired or replaced free, and labor is free. From one year from the day of purchase, all parts will be repaired or replaced free, and for all labor charges. After one year from the day of purchase, you pay for the replacement or repair of all parts, and for all labor charges.

All parts, including repaired and replaced parts, are covered only for the original warranty period. When the warranty on the product expires, the warranty on all replaced and repaired parts also expires.

### WHAT IS EXCLUDED?

Your warranty does not cover:

- labor charges for installation or setup of the product, adjustment of customer controls on the product, and installation or repair of antenna systems outside of the product.
- product repair and/or part replacement because of misuse, accident, unauthorized repair or other cause not within the control of Philips Consumer Electronics Company.
- reception problems caused by signal conditions or cable or antenna systems outside the unit.
- a product that requires modification or adaptation to enable it to operate in any country other than the country for which it was designed, manufactured, approved and/or authorized, or repair of products damaged by these modifications.
- incidental or consequential damages resulting from the product. (Some states do not allow the exclusion of incidental or consequential damages, so the above exclusion may not apply to you. This includes, but is not limited to, prerecorded material, whether copyrighted or not copyrighted.)
- a product used for commercial or institutional purposes.

### WHERE IS SERVICE AVAILABLE?

Warranty service is available in all countries where the product is officially distributed by Philips Consumer Electronics Company. In countries where Philips Consumer Electronics Company does not distribute the product, the local Philips service organization will attempt to provide service (although there may be a delay if the appropriate spare parts and technical manual(s) are not readily available).

### MAKE SURE YOU KEEP...

Please keep your sales receipt or other document showing proof of purchase. Attach it to this owner's manual and keep both nearby. Also keep the original box and packing material in case you need to return your product.

### BEFORE REQUESTING SERVICE...

Please check your owner's manual before requesting service. Adjustments of the controls discussed there may save you a service call.

### TO GET WARRANTY SERVICE IN U.S.A., PUERTO RICO OR U.S. VIRGIN ISLANDS...

Contact a Philips factory service center (see enclosed list) or authorized service center to arrange repair.

(In U.S.A., Puerto Rico and U.S. Virgin Islands, all implied warranties, including implied warranties of merchantability and fitness for a particular purpose, are limited in duration to the duration of this express warranty. But, because some states do not allow limitations on how long an implied warranty may last, this limitation may not apply to you.)

### TO GET WARRANTY SERVICE IN CANADA...

Please contact Philips at:

**1-800-661-6162** if calling from Canada (French speaking)  
**1-800-531-0039** (English or Spanish speaking)

(In Canada, this warranty is given in lieu of all other warranties. No other warranties are expressed or implied, including any implied warranties of merchantability or fitness for a particular purpose. Philips is not liable under any circumstances for any direct, indirect, special, incidental or consequential damages, howsoever incurred, even if notified of the possibility of such damages.)

### REMEMBER...

Please record the model and serial numbers found on the product below. Also, please fill out and mail your warranty registration card promptly. It will be easier for us to notify you if necessary.

MODEL # \_\_\_\_\_

SERIAL # \_\_\_\_\_

*This warranty gives you specific legal rights. You may have other rights which vary from state/province to state/province.*

**Philips Consumer Electronics, P.O. Box 520890, Miami, FL 33152, (402) 536-4171**



## Free Manuals Download Website

<http://myh66.com>

<http://usermanuals.us>

<http://www.somanuals.com>

<http://www.4manuals.cc>

<http://www.manual-lib.com>

<http://www.404manual.com>

<http://www.luxmanual.com>

<http://aubethermostatmanual.com>

Golf course search by state

<http://golfingnear.com>

Email search by domain

<http://emailbydomain.com>

Auto manuals search

<http://auto.somanuals.com>

TV manuals search

<http://tv.somanuals.com>