

191TE2L

221TE2L



(Ref model: 191TE2L)

www.philips.com/welcome

EN	Notice & important information	2
	User manual	6
	Troubleshooting	26

PHILIPS



Country	Code	Telephone number	Tariff
Austria	+43	0810 000206	€ 0.07
Belgium	+32	078 250851	€ 0.06
Denmark	+45	3525 8761	Local call tariff
Finland	+358	09 2290 1908	Local call tariff
France	+33	082161 1658	€ 0.09
Germany	+49	01803 386 853	€ 0.09
Greece	+30	00800 3122 1223	Free of charge
Ireland	+353	01 601 1161	Local call tariff
Italy	+39	840 320 041	€ 0.08
Luxembourg	+352	26 84 30 00	Local call tariff
The Netherlands	+31	0900 0400 063	€ 0.10
Norway	+47	2270 8250	Local call tariff
Poland	+48	0223491505	Local call tariff
Portugal	+351	2 1359 1440	Local call tariff
Spain	+34	902 888 785	€ 0.10
Sweden	+46	08 632 0016	Local call tariff
Switzerland	+41	02 2310 2116	Local call tariff
United Kingdom	+44	0207 949 0069	Local call tariff

Register your product and get support at
www.philips.com/welcome

This information is correct at the time of press. For updated information, see www.philips.com/support.

Download from Www.Somanuals.com. All Manuals Search And Download.

Contents

1 Notice	2	8 Setup	19
2 Important	4	Wide mode	19
The most updated user manual on line	5	HDMI scan info	19
3 Get started and connect your devices	6	Menu language	19
Back connector	6	Sleep timer	20
Side connector	8	Demo	20
4 Controls	9	Advanced	21
Front touch button controls	9	Reset setting	21
Remote control	10	9 Software update	22
5 Start to use	11	10 Pixel policy	23
Switch your monitor on/off or to standby	11	11 Troubleshooting	26
Switch channels	12	General monitor issues	26
Watch connected devices	12	Monitor channel issues	26
Adjust monitor volume	13	Picture issues	26
Use teletext	13	Sound issues	27
6 Product information	14	HDMI connection issues	27
Supported display resolutions	14	Computer connection issues	27
Tuner/Reception/Transmission	14	Others	27
Remote control	14	Contact us	27
Power	14		
Supported monitor mounts	14		
7 TV/Channel installation	15		
Using TV signal as the input source	15		
Auto program	15		
Manual program	15		
Program edit	16		
Parental rating	16		
Preferred MPX	17		
Preferred subtitle	17		
Common interface	18		

1 Notice

2010 © Koninklijke Philips Electronics N.V.
All rights reserved.

Philips and the Philips Shield Emblem are registered trademarks of Koninklijke Philips Electronics N.V. and are used under licence from Koninklijke Philips Electronics N.V.

Specifications are subject to change without notice.

Warranty

- Risk of injury, damage to monitor or void of warranty! Never attempt to repair the monitor yourself.
- Use the monitor and accessories only as intended by the manufacturer.
- Any operation expressly prohibited in this manual, or any adjustments and assembly procedures not recommended or authorised in this manual shall void the warranty.
- Warranty coverage begins from the day you purchase your monitor. For two years thereafter, your monitor will be replaced by at least an equivalent monitor in case of defects provided by the warranty coverage.

Pixel characteristics

This monitor product has a high number of color pixels. Although it has effective pixels of 99.999% or more, black dots or bright points of light (red, green or blue) may appear constantly on the screen. This is a structural property of the display (within common industry standards) and is not a malfunction. Please refer to the Pixel Policy section in this manual for details.

Mains fuse (UK only)

This monitor is fitted with an approved moulded plug. Should it become necessary to replace the mains fuse, this must be replaced with a fuse of the same value as indicated on the plug (example 10A).

- 1** Remove fuse cover and fuse.
- 2** The replacement fuse must comply with BS 1362 and have the ASTA approval mark. If the fuse is lost, contact your dealer in order to verify the correct type.
- 3** Refit the fuse cover.
In order to maintain conformity to the EMC directive, the mains plug on this product must not be detached from the mains cord cable.

Copyright



VESA, FDMI and the VESA Mounting Compliant logo are trademarks of the Video Electronics Standards Association.

® Kensington and Micro Saver are registered US trademarks of ACCO World Corporation with issued registrations and pending applications in other countries throughout the world.



Manufactured under license from Dolby Laboratories. Dolby and double-D symbol are trademarks of Dolby Laboratories.

2 Important

Read and understand all instructions before you use your monitor. If damage is caused by failure to follow instructions, the warranty does not apply.

Safety

- Risk of electric shock or fire!
 - Never expose the monitor to rain or water. Never place liquid containers, such as vases, near the monitor. If liquids are spilt on or into the monitor, disconnect the monitor from the power outlet immediately. Contact Philips Consumer Care to have the monitor checked before use.
 - Never place the monitor, remote control or batteries near naked flames or other heat sources, including direct sunlight. To prevent the spread of fire, keep candles or other flames away from the monitor, remote control and batteries at all times.
- 
- Never insert objects into the ventilation slots or other openings on the monitor.
 - When the monitor is swivelled, ensure that no strain is exerted on the power cord. Strain on the power cord can loosen connections and cause arcing.
 - Risk of short circuit or fire!
 - Never expose the remote control or batteries to rain, water or excessive heat.
 - Avoid force coming onto power plugs. Loose power plugs can cause arcing or fire.
 - Risk of injury or damage to the monitor!
 - Two people are required to lift and carry a monitor that weighs more than 25 kg.
 - When stand mounting the monitor, use only the supplied stand. Secure the stand to the monitor tightly. Place the monitor on a flat, level surface that can support the combined weight of the monitor and the stand.
 - When wall mounting the monitor, use only a wall mount that can support the weight of the monitor. Secure the wall mount to a wall that can support the combined weight of the monitor and wall mount. Koninklijke Philips Electronics N.V. bears no responsibility for improper wall mounting that results in accident, injury or damage.
 - Risk of injury to children! Follow these precautions to prevent the monitor from toppling over and causing injury to children:
 - Never place the monitor on a surface covered by a cloth or other material that can be pulled away.
 - Ensure that no part of the monitor hangs over the edge of the surface.
 - Never place the monitor on tall furniture (such as a bookcase) without anchoring both the furniture and monitor to the wall or a suitable support.
 - Educate children about the dangers of climbing on furniture to reach the monitor.
 - Risk of overheating! Never install the monitor in confined space. Always leave at least 4 inches of space around the monitor for ventilation. Ensure curtains or other objects never cover the ventilation slots on the monitor.
 - Risk of damage to the monitor! Before you connect the monitor to the power outlet, ensure that the power voltage matches the value printed on the back of the monitor. Never connect the monitor to the power outlet if the voltage is different.

- Risk of injury, fire or power cord damage! Never place the monitor or any objects on the power cord.
- To easily disconnect the monitor power cord from the power outlet, ensure that you have full access to the power cord at all times.
- When you disconnect the power cord, always pull the plug, never the cable.
- Disconnect the monitor from the power outlet and aerial before lightning storms. During lightning storms, never touch any part of the monitor, power cord or aerial cable.
- Risk of hearing damage! Avoid using earphones or headphones at high volumes or for prolonged periods of time.
- If the monitor is transported in temperatures below 5°C, unpack the monitor and wait until the monitor temperature matches the room temperature before connecting the monitor to the power outlet.

Screen care

- Avoid stationary images as much as possible. Stationary images are images that remain on-screen for extended periods of time. Examples include: on-screen menus, black bars and time displays. If you must use stationary images, reduce screen contrast and brightness to avoid screen damage.
- Unplug the monitor before cleaning.
- Clean the monitor and frame with a soft, damp cloth. Never use substances such as alcohol, chemicals or household cleaners on the monitor.
- Risk of damage to the monitor screen! Never touch, push, rub or strike the screen with any object.
- To avoid deformations and color fading, wipe off water drops as soon as possible.

Recycling



Your display is manufactured with high quality materials and components which can be recycled and reused.

To learn more about our recycling program, please visit www.philips.com/about/sustainability/recycling.

When you see the crossed-out wheeled bin symbol attached to a product, it means the product is covered by the European Directive 2002/96/EC:



Never dispose of your product with other household waste. Please inform yourself about the local rules on the separate collection of electrical and electronic products. The correct disposal of your old product helps prevent potentially negative consequences for the environment and human health.

Your product contains batteries covered by the European Directive 2006/66/EC, which cannot be disposed of with normal household waste.

Please inform yourself about the local rules on the separate collection of batteries. The correct disposal of batteries helps prevent potentially negative consequences for the environment and human health.

The most updated user manual on line

The contents of the user manual are subject to change. Please refer to www.philips.com/support for the most updated user manual info reference.

3 Get started and connect your devices

Congratulations on your purchase, and welcome to Philips! To fully benefit from the support that Philips offers, register your product at www.philips.com/welcome.

This section describes how to connect various devices with different connectors and supplements examples provided in the Quick Start Guide.

Note

- Different types of connectors may be used to connect a device to your monitor, depending on availability and your needs.

Back connector

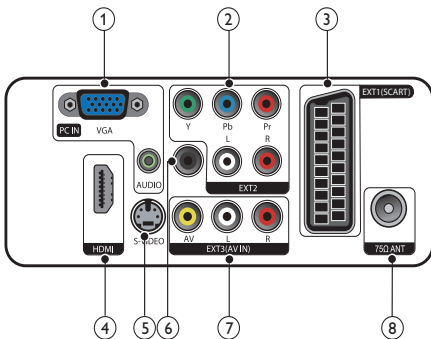

- ① PC IN (VGA and AUDIO IN)
Audio and video input from a computer.

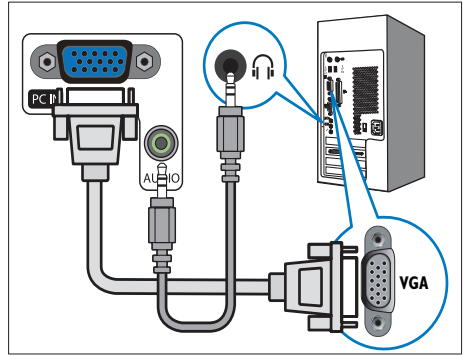

The connection via VGA requires an additional audio cable.

- ② EXT2 (Y Pb Pr and AUDIO L/R)
Analogue audio and video input from analogue or digital devices such as DVD players or game consoles.

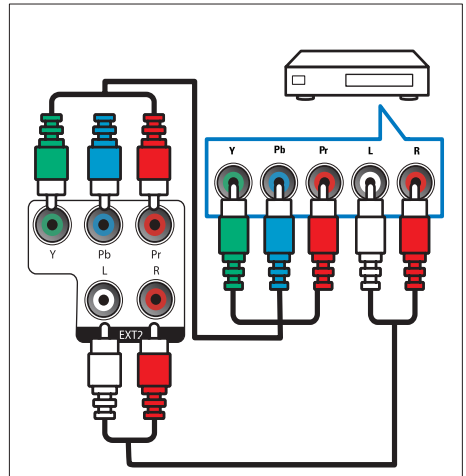

③ EXT1 (SCART)

Analogue audio and video input from analogue or digital devices such as DVD players or game consoles.

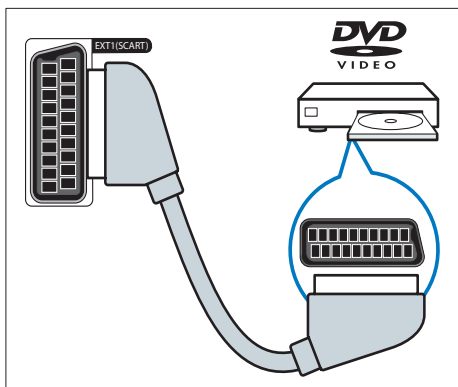

④ HDMI

Digital audio and video input from high-definition digital devices such as Blu-ray players.

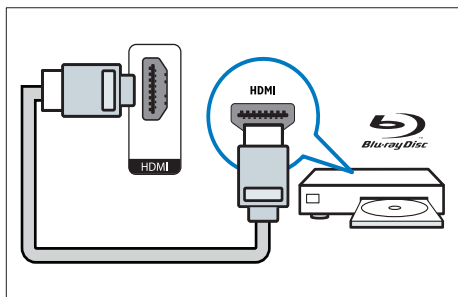

⑤ S-Video

Video input from an S-Video device.

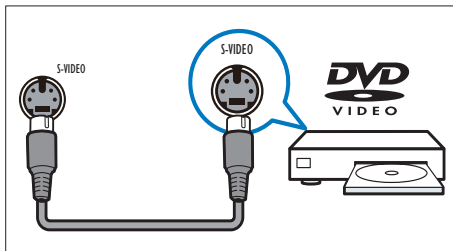

⑥ SPDIF OUT

Digital audio output to home theatres and other digital audio systems.

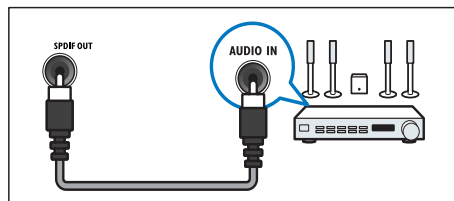

⑦ EXT3 (AV IN)

Audio and video input from an AV device.

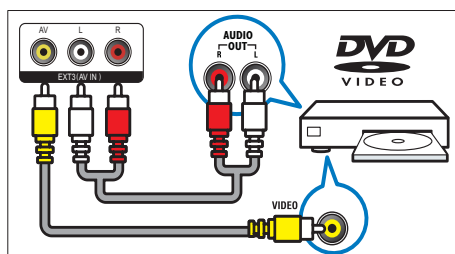

⑧ TV ANTENNA

Signal input from an antenna, cable or satellite.

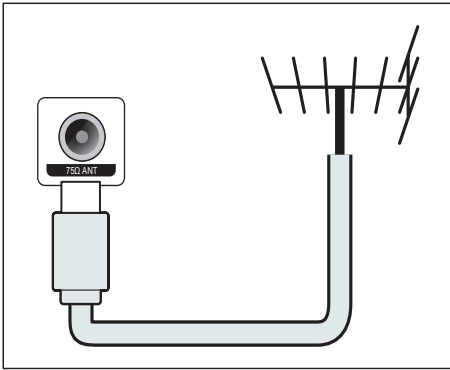

Side connector

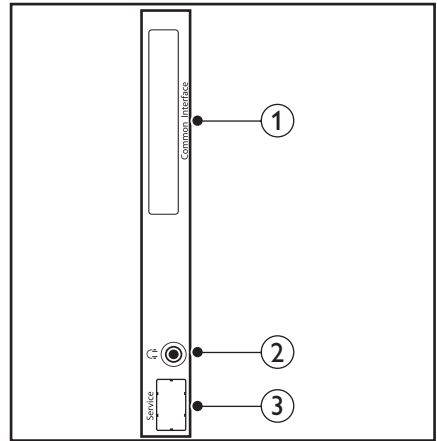

① COMMON INTERFACE

Slot for a Conditional Access Module (CAM).

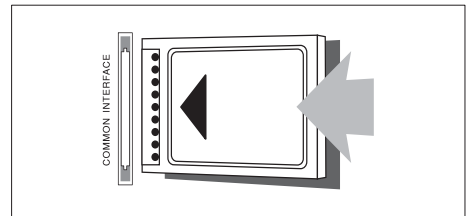

② HEADPHONE

Audio output to your headphones.

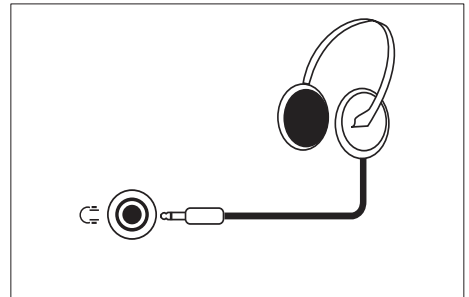

③ SERVICE PORT

For service use only.

4 Controls

Front touch button controls

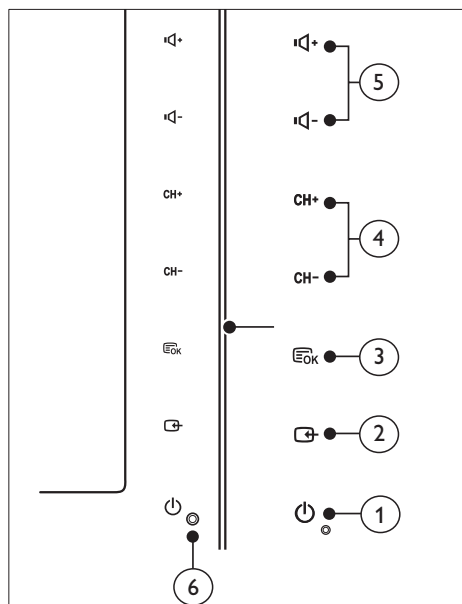

- ① **POWER:** Switch the monitor on or off. The monitor is not powered off completely unless it is physically unplugged.
- ② **SOURCE:**
Select an input source.
Return to the previous screen or exit from the on-screen menu.
- ③ **MENU/OK:**
Display the on-screen menu.
Confirm a selection.
- ④ **CH +/-:** Switch to the next or previous channel.
- ⑤ **VOL +/-:** Increase or decrease volume.
- ⑥ **Power indicator:**
Red LED: RC standby mode.
White LED: Power on.
White LED blinking: PC standby mode.

Remote control

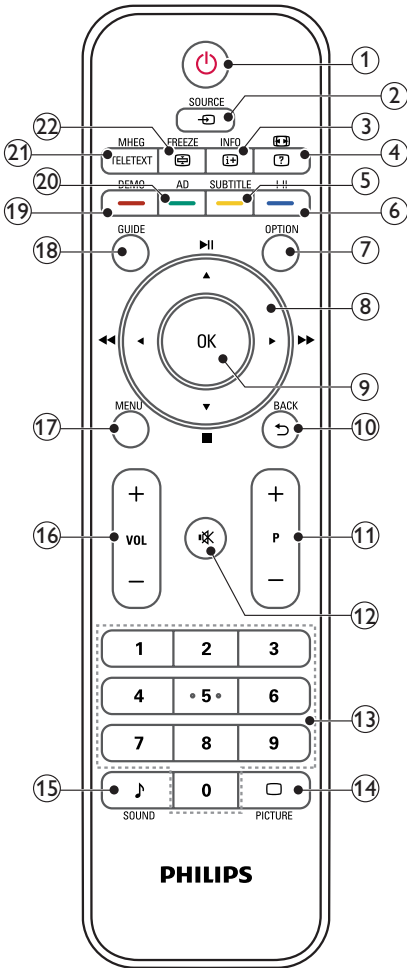

- ① **⏻ (Standby-On)**
- Switch the monitor to standby if the monitor is on.
 - Switch the monitor on if the monitor is in standby.
- ② **📡 Source**
Select connected devices.

- ③ **ℹ️ / ⓘ (Index)**
- Display or hide the information screen about the selected channel.
 - Press to display the index page of Teletext.
- ④ **📺 (Aspect ratios) / 📄 (Reveal)**
- Hot key for aspect ratios.
 - Reveal hidden information of Teletext.
- ⑤ **SUBTITLE / 🟡 (Yellow button)**
- In TV mode: Press to turn the subtitle on or off.
 - In Text mode: Press to open the subtitle page.
 - Select tasks or options in yellow.
- ⑥ **I-II / 🔵 (Blue button)**
- Toggle to select mono / stereo / dual I/dual II from TV RF input.
 - Select tasks or options in blue.
- ⑦ **OPTION**
Press to display a list of options: Channel list, Favorite list, Audio description (UK only), Subtitle language (UK only), Audio language (UK only) and VGA auto (PC mode auto adjustment).
- ⑧ **▲ ▼ ◀ ▶ (Navigation buttons)**
◀◀ ▶▶ ▶|| ■ (No functions)
Navigate through the menus.
- ⑨ **OK**
Confirm an entry or selection and display the channel grid when watching TV.
- ⑩ **BACK / ↶**
- Return to the previous screen.
 - Return to the last viewed channel.
- ⑪ **P +/-**
Switch to the next or previous channel.
- ⑫ **🔇 (Mute)**
Switch the sound On or Off.
- ⑬ **0-9 (Numeric buttons)**
Select a channel or setting.

- 14 **PICTURE**
Toggle to select the SmartPicture setting.
- 15 **SOUND**
Toggle to select the SmartSound Mode.
- 16 **VOL +/-**
Increase or decrease the volume.
- 17 **MENU**
Press to open or close the on-screen menu.
- 18 **GUIDE**
Switch the Electronic Program Guide On or Off.
- 19 **DEMO / — (Red button)**
- Hot key for E-Sticker.
 - Select tasks or options in red.
- 20 **AD (Audio Description) (For RF Digital TV only) / — (Green button)**
- UK only: Enable audio commentary for the visually handicapped.
 - Select tasks or options in green.
- 21 **MHEG / TELETEXT**
- Press to open the UK MHEG interactive program.
 - Press to overlay the Teletext page on the TV picture.
 - Press to open or close the Teletext.
- 22 **FREEZE / (Hold)**
- Press to freeze the TV picture.
 - Toggle to stop the scrolling of pages to stop the text decoder receiving data.

5 Start to use

This section helps you perform basic monitor operations.

Switch your monitor on/off or to standby

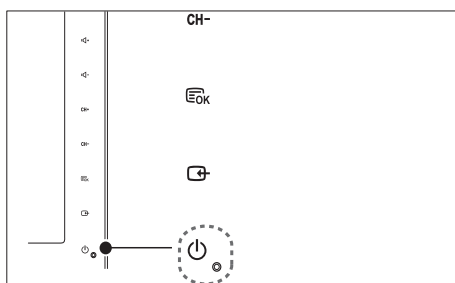
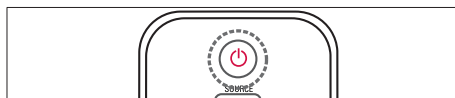

To switch on

- If the standby indicator is off, touch **POWER** at the front of the monitor.
- If the standby indicator is red, press **Standby-On** on the remote control.

To switch to standby

- Press **Standby-On** on the remote control.
 - ↳ The standby indicator switches to red.

To switch off

- Touch **POWER** at the front of the monitor.
 - ↳ The standby indicator switches off.

Tip

- Though your monitor consumes very little power when in standby, energy continues to be consumed. When not in use for an extended period of time, disconnect the monitor power cable from the power outlet.

Note

- If you cannot locate your remote control and want to switch on the monitor from standby, touch **CH +/-** at the side of the monitor.

Switch channels

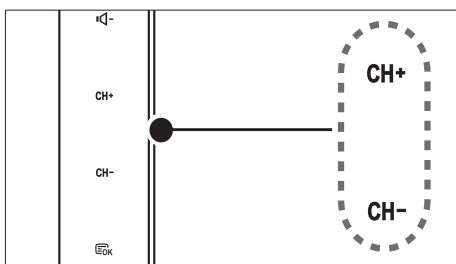
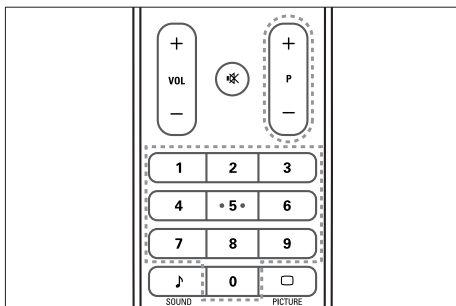

- Press **P +/-**, or enter a channel number using the numeric buttons on the remote control.
- Touch the **CH +/-** sensor at the front of the monitor.

Watch connected devices

Note

- Switch on the connected device before selecting it as a source on the monitor.

To select from the SOURCE button

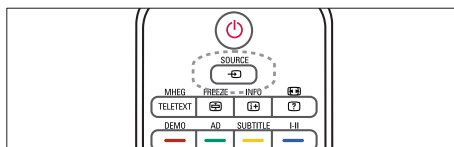

1. Press **SOURCE** to display the source list.
↳ The source list appears.
2. Press **SOURCE**, **▲** or **▼** to select a device.
3. Press **OK** to confirm your selection.

Adjust monitor volume

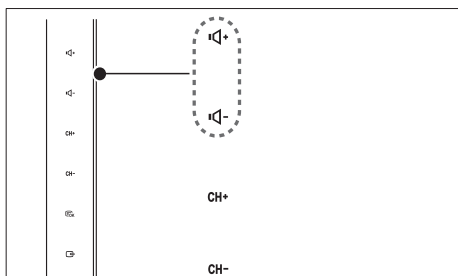
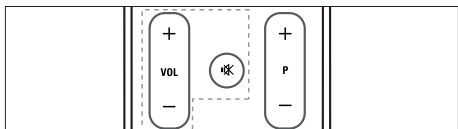

To turn up or down the volume

- Press **VOL +/-** on the remote control.
- Touch the **VOL +/-** sensor at the front of the monitor

To mute or restore the muted sound

- Press **MUTE** to mute the sound.
- Press **MUTE** again to restore the sound.

Use teletext

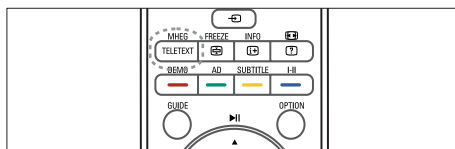

1. Press **TELETEXT**.
↳ The main index page appears.
2. Select a page as follows:
 - Press the numeric buttons to enter a page number
 - Press **P +/-** to view the next or previous page
 - Press the color buttons to select a color coded item
3. Press **TELETEXT** to exit teletext.

Note

- For UK users only: some digital TV channels offer dedicated digital text services (for example, BBC1).

6 Product information

Product information is subject to change without notice. For detailed product information, go to www.philips.com/support.

Supported display resolutions

Computer formats

- Resolution - refresh rate:
 - 640 × 480 - 60Hz
 - 640 × 480 - 72Hz
 - 640 × 480 - 75Hz
 - 800 × 600 - 56Hz
 - 800 × 600 - 60Hz
 - 800 × 600 - 75Hz
 - 1024 × 768 - 60Hz
 - 1024 × 768 - 70Hz
 - 1024 × 768 - 75Hz
 - 1152 × 864 - 75Hz
 - 1280 × 960 - 60Hz
 - 1280 × 1024 - 60Hz
 - 1280 × 1024 - 70Hz
 - 1280 × 1024 - 75Hz
 - 1366 × 768 - 60Hz (the best for model 191TE2L)
 - 1440 × 900 - 60Hz
 - 1680 × 1050 - 60Hz
 - 1920 × 1080 - 60Hz (the best for model 221TE2L)

Video formats

- Resolution - refresh rate:
 - 480i - 60Hz
 - 480p - 60Hz
 - 576i - 50Hz
 - 576p - 50Hz
 - 720p - 50Hz, 60Hz
 - 1080i - 50Hz, 60Hz
 - 1080p - 50Hz, 60Hz

Tuner/Reception/Transmission

- Antenna input: 75ohm coaxial (IEC75)
- DVB: DVB Terrestrial
- TV system: PAL I, B/G, D/K; SECAM B/G, D/K, L/L'
- Video playback: NTSC, SECAM, PAL
- Tuner Bands: Hyperband, S-channel, UHF, VHF

Remote control

- Type: 191TE2L, 221TE2L RC
- Batteries: 2 × AAA (LR03 type)

Power

- Mains power: 100-240V, 50Hz/60Hz
- DC switch off power: 0.15W (Typ.)
- Standby mode power: ≤ 0.5W (Typ.)
- Ambient temperature: 5 to 40 degrees Celsius

Supported monitor mounts

To mount the monitor, purchase a Philips monitor mount or a VESA-compatible monitor mount. To prevent damage to cables and connectors, be sure to leave a clearance of at least 5.5 cm from the back of the monitor:



Warning

- Follow all instructions provided with the monitor mount. Koninklijke Philips Electronics N.V. bears no responsibility for improper monitor mounting that results in accident, injury or damage.

Monitor screen size (inches)	Required pitch (mm)	Required mounting bolts
18.5	75 × 75	4 × M4
21.5	75 × 75	4 × M4

7 TV/Channel installation

This chapter describes the channel installation settings.

Using TV signal as the input source

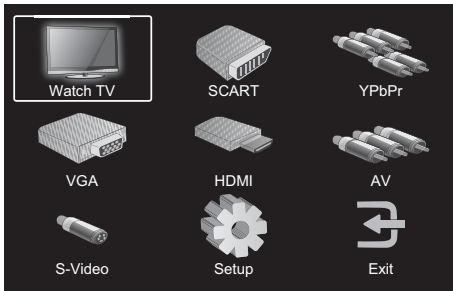

1. Press **MENU** to display the main setup menu.
2. Press **▲**, **▼**, **◀**, or **▶** to select **Watch TV**.
3. Press **OK** to confirm your selection.

Auto program

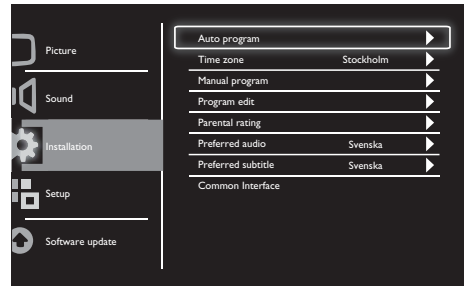

1. Press **MENU** to display the main setup menu.
2. Press **▲**, **▼**, **◀**, or **▶** to select **Setup** and press **OK** to enter the main setup menu.
3. Press **▲** or **▼** to select **Installation** and press **▶** or **OK** to enter.
4. Press **▲** or **▼** to select **Auto program** and press **▶** or **OK** to enter.
5. Press **▲** or **▼** to select the country name of your residence, then press **OK** to start automatic channel search.

Manual program

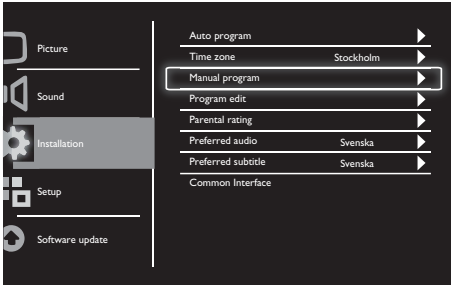

1. Press **MENU** to display the main setup menu.
2. Press **▲**, **▼**, **◀** or **▶** to select **Setup** and press **OK** to enter.
3. Press **▲** or **▼** to select **Installation**, then press **▶** or **OK** to enter.
4. Press **▲** or **▼** to select **Manual program**, then press **▶** or **OK** to enter.
5. Press **▲** or **▼** to select digital or analog TV, then press **▶** or **OK** to enter.
6. Press **▲**, **▼**, **◀** or **▶** to change selection, then press **▶** or **OK** to confirm your selection.
7. Press **MENU** to exit the setup menu.

Program edit

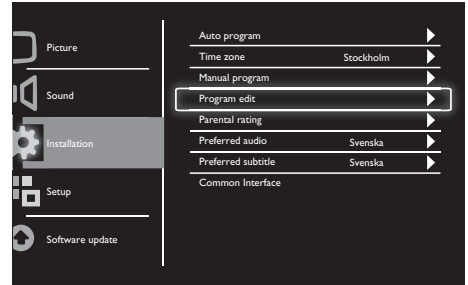

1. Press **MENU** to display the main setup menu.
2. Press **▲**, **▼**, **◀** or **▶** to select **Setup** and press **OK** to enter.
3. Press **▲** or **▼** to select **Installation** and press **▶** or **OK** to enter.
4. Press **▲** or **▼** to select **Program edit**, then press **▶** or **OK** to enter.
5. Press **▲** or **▼** to select a channel, then press the corresponding color button on the remote to **Delete**, **Rename**, **Move**, or **Skip** a channel.
The **Rename** and **Move** options are only available for analog TV channels.
6. Press **MENU** to exit the setup menu.

Parental rating

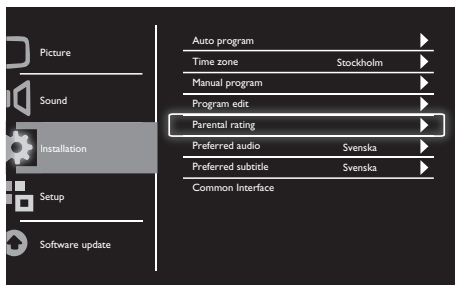

1. Press **MENU** to display the main setup menu.
2. Press **▲**, **▼**, **◀**, or **▶** to select **Setup** and press **OK** to enter.
3. Press **▲** or **▼** to select **Installation** and press **▶** or **OK** to enter.
4. Press **▲** or **▼** to select **Parental rating** and press **▶** or **OK** to enter.
5. Enter the four-digit PIN number. The default PIN number is 0711.
6. Press **▲** or **▼** to select a rating option, and press **▶** or **OK** to set your rating criteria.
7. Press **▶** or **OK** to confirm your selection.
8. Press **MENU** to exit the setup menu.

Preferred audio

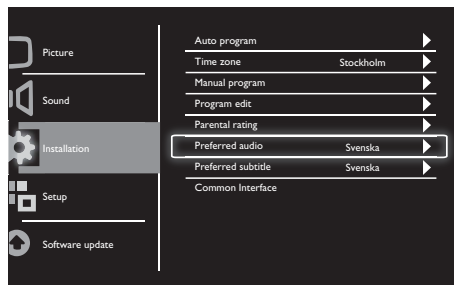

1. Press **MENU** to display the main setup menu.
2. Press **▲**, **▼**, **◀** or **▶** to select **Setup** and press **OK** to enter.
3. Press **▲** or **▼** to select **Installation**, then press **▶** or **OK** to enter.
4. Press **▲** or **▼** to select **Preferred audio**, then press **▶** or **OK** to enter.
5. Press **▲** or **▼** to select your preferred audio language, then press **▶** or **OK** to confirm your selection.
6. If a program comes with more than one type of audio language, it will play your preferred language selection.

Preferred subtitle

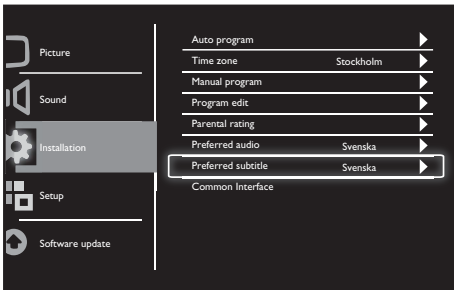

1. Press **MENU** to display the main setup menu.
2. Press **▲**, **▼**, **◀** or **▶** to select **Setup** and press **OK** to enter.
3. Press **▲** or **▼** to select **Installation**, then press **▶** or **OK** to enter.
4. Press **▲** or **▼** to select **Preferred subtitle**, then press **▶** or **OK** to enter.
5. Press **▲** or **▼** to select your preferred subtitle language, then press **▶** or **OK** to confirm your selection.
6. If a program comes with more than one type of subtitle language, it will play your preferred language selection.

Common Interface

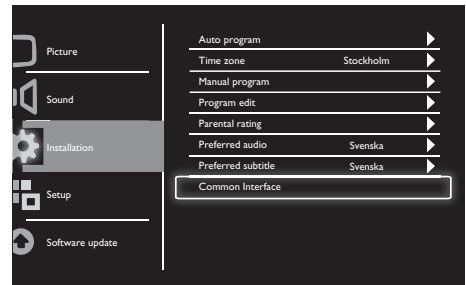

Make sure the module is inserted into the common interface slot.

1. Press **MENU** to display the main setup menu.
2. Press **▲**, **▼**, **◀** or **▶** to select **Setup** and press **OK** to enter.
3. Press **▲** or **▼** to select **Installation**, then press **▶** or **OK** to enter.
4. Press **▲** or **▼** to select **Common Interface**, then press **▶** or **OK** to enter.
5. Press **▲** or **▼** to make changes, then press **▶** or **OK** to confirm your selection.

8 Setup

This chapter describes how to change settings and customize functions.

Wide mode

This item sets the display option of the monitor.

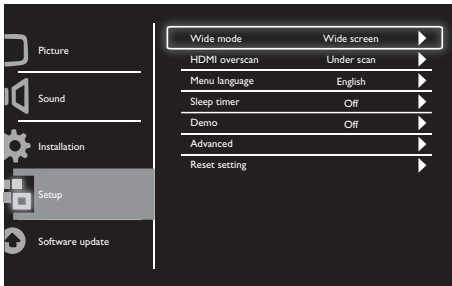

1. Press **MENU** to display the main setup menu.
2. Press **▲**, **▼**, **◀**, or **▶** to select **Setup** and press **OK** to enter.
3. Press **▲** or **▼** to select **Setup** and press **▶** or **OK** to enter.
4. Press **▲** or **▼** to select **Wide mode** and press **▶** or **OK** to enter.
5. Press **◀**, or **▶** to select a display option.
6. Press **▶** or **OK** to confirm your selection.
7. Press **MENU** to exit the setup menu.

HDMI overscan

This item sets the HDMI scanning method.

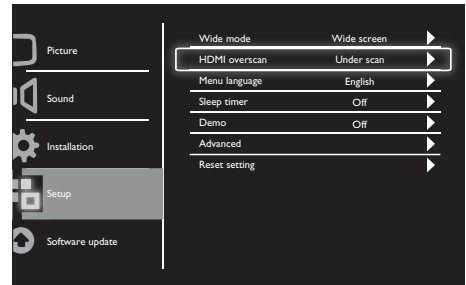

1. Press **MENU** to display the main setup menu.
2. Press **▲**, **▼**, **◀**, or **▶** to select **Setup** and press **OK** to enter.
3. Press **▲** or **▼** to select **Setup** and press **▶** or **OK** to enter.
4. Press **▲** or **▼** to select **HDMI overscan** and press **▶** or **OK** to enter.
5. Press **▲** or **▼** to select a scanning option.
6. Press **▶** or **OK** to confirm your selection.
7. Press **MENU** to exit the setup menu.

Menu language

This item selects the OSD language.

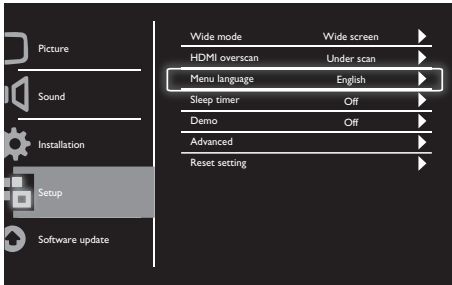

1. Press **MENU** to display the main setup menu.
2. Press **▲**, **▼**, **◀**, or **▶** to select **Setup** and press **OK** to enter.
3. Press **▲** or **▼** to select **Setup** and press **▶** or **OK** to enter.
4. Press **▲** or **▼** to select **Menu language** and press **▶** or **OK** to enter.
5. Press **◀** or **▶** to make your selection.
6. Press **OK** to confirm your selection.
7. Press **MENU** to exit the setup menu.

Sleep timer

This item switches the monitor to standby after a defined period of time with no control command.

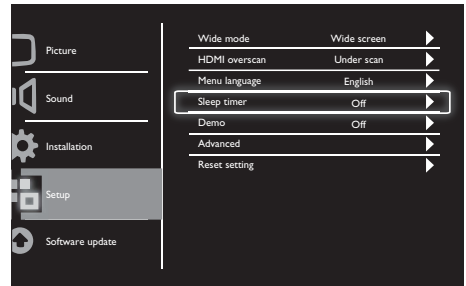

1. Press **MENU** to display the main setup menu.
2. Press **▲**, **▼**, **◀**, or **▶** to select **Setup** and press **OK** to enter.
3. Press **▲** or **▼** to select **Setup** and press **▶** or **OK** to enter.
4. Press **▲** or **▼** to select **Sleep timer** and press **▶** or **OK** to enter.
5. Press **◀**, or **▶** to select a defined period of time, or select **Off** to turn off this function.
6. Press **▶** or **OK** to confirm your selection.
7. Press **MENU** to exit the setup menu.

Demo

This item puts your monitor under demonstration mode to see how the picture quality of your monitor has improved.

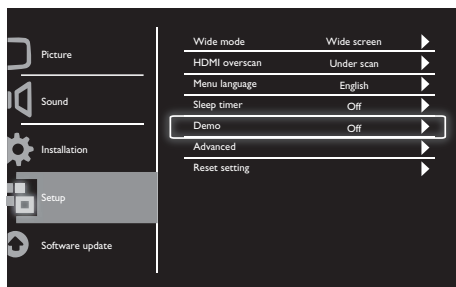

1. Press **MENU** to display the main setup menu.
2. Press **▲**, **▼**, **◀**, or **▶** to select **Setup** and press **OK** to enter.
3. Press **▲** or **▼** to select **Setup** and press **▶** or **OK** to enter.
4. Press **▲** or **▼** to select **Demo** and press **▶** or **OK** to enter.
5. Press **▲** or **▼** to select **On** or **Off**.
6. Press **▶** or **OK** to confirm your selection.
7. Press **MENU** to exit the setup menu.

Advanced

This item selects advanced setting options.

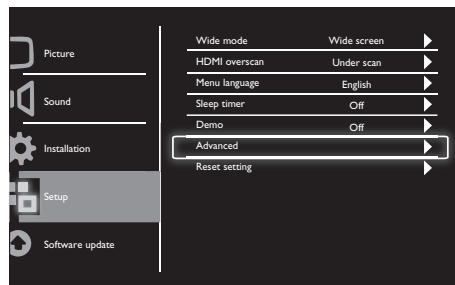

1. Press **MENU** to display the main setup menu.
2. Press **▲**, **▼**, **◀**, or **▶** to select **Setup** and press **OK** to enter.
3. Press **▲** or **▼** to select **Setup** and press **▶** or **OK** to enter.
4. Press **▲** or **▼** to select **Advanced** and press **▶** or **OK** to enter.
5. Press **▲** or **▼** to select an option, and press **▶** or **OK** to enter.
6. Press **◀**, or **▶** to make changes, and press **▶** or **OK** to confirm your selection.
7. Press **MENU** to exit the setup menu.

Reset setting

This item sets the monitor to factory default settings.

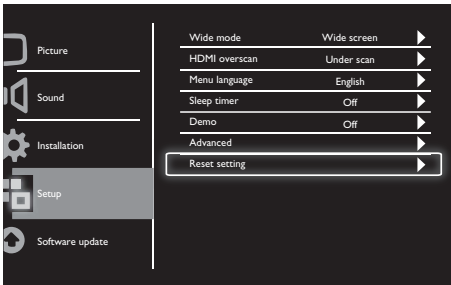

1. Press **MENU** to display the main setup menu.
2. Press **▲**, **▼**, **◀**, or **▶** to select **Setup** and press **OK** to enter.
3. Press **▲** or **▼** to select **Setup** and press **▶** or **OK** to enter.
4. Press **▲** or **▼** to select **Reset setting** and press **▶** or **OK** to enter.
5. Press **◀** or **▶** to select **Yes**, and press **OK** to reset your monitor.
6. The monitor will reset to factory default settings.

9 Software update

This chapter describes how to update the monitor software



1. Press **MENU** to display the main setup menu.
2. Press **▲**, **▼**, **◀**, or **▶** to select **Setup** and press **OK** button to enter.
3. Press **▲** or **▼** to select **Software update** and press **▶** or **OK** to enter.
4. Press **▶** or **OK** to start the upgrade process.

10 Pixel policy

Philips strives to deliver the highest quality products. We use some of the industry's most advanced manufacturing processes and practice stringent quality control. However, pixel or sub pixel defects on a flat monitor panel are sometimes unavoidable. No manufacturer can guarantee that all panels will be free from pixel defects, but Philips guarantees that any monitor with an unacceptable number of defects will be repaired or replaced under warranty. This notice explains the different types of pixel defects and defines acceptable defect levels for each type. In order to qualify for repair or replacement under warranty, the number of pixel defects on a monitor panel must exceed these acceptable levels. For example, no more than 0.0004% of the sub pixels on a monitor may be defective. Furthermore, Philips sets even higher quality standards for certain types or combinations of pixel defects that are more noticeable than others. This policy is valid worldwide.

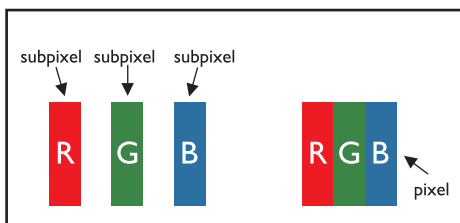

Pixels and Sub pixels

A pixel, or picture element, is composed of three sub pixels in the primary colors of red, green and blue. Many pixels together form an image. When all sub pixels of a pixel are lit, the three colored sub pixels together appear as a single white pixel. When all are dark, the three colored sub pixels together appear as a single black pixel. Other combinations of lit and dark sub pixels appear as single pixels of other colors.

Types of Pixel Defects

Pixel and sub pixel defects appear on the screen in different ways. There are two categories of pixel defects and several types of sub pixel defects within each category.

Bright Dot Defects: bright dot defects appear as pixels or sub pixels that are always lit or 'on'. That is, a bright dot is a sub-pixel that stands out on the screen when the monitor displays a dark pattern.

These are some types of bright dot defects:

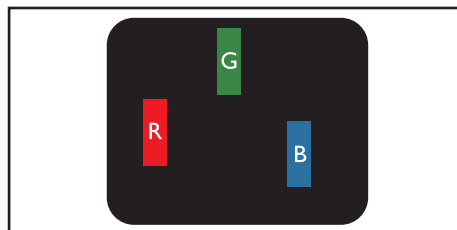

One lit red, green or blue sub pixel

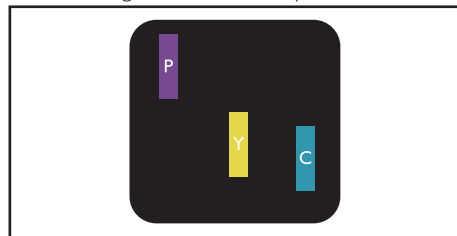

Two adjacent lit sub pixels:

- Red + Blue = Purple
- Red + Green = Yellow
- Green + Blue = Cyan (Light Blue)

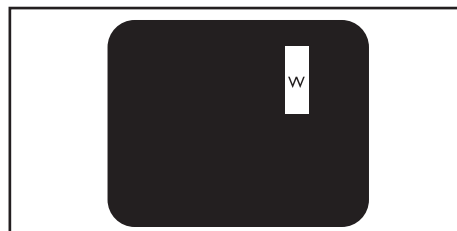

Three adjacent lit sub pixels (one white pixel)

Note

- A red or blue bright dot must be more than 50 percent brighter than neighboring dots while a green bright dot is 30 percent brighter than neighboring dots.

Black Dot Defects: black dot defects appear as pixels or sub pixels that are always dark or 'off'. That is, a dark dot is a sub-pixel that stands out on the screen when the monitor displays a light pattern.

These are some types of black dot defects:

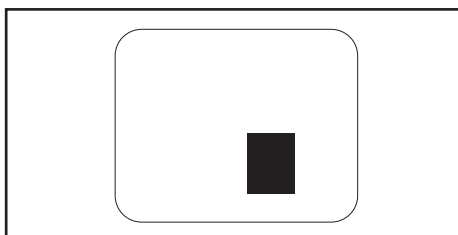
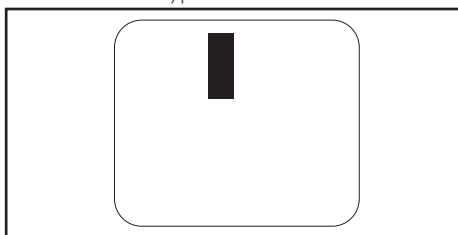

Proximity of Pixel Defects

Because pixel and sub pixels defects of the same type that are near to one another may be more noticeable, Philips also specifies tolerances for the proximity of pixel defects.

Pixel Defect Tolerances

In order to qualify for repair or replacement due to pixel defects during the warranty period, a Philips flat monitor panel must have pixel or sub pixel defects exceeding the tolerances listed in the following tables.

BRIGHT DOT DEFECTS	ACCEPTABLE LEVEL
MODEL	191TE2L / 221TE2L
1 lit subpixel	3
2 adjacent lit subpixels	1
3 adjacent lit subpixels (one white pixel)	0
Distance between two bright dot defects*	>15mm
Total bright dot defects of all types	3

BLACK DOT DEFECTS	ACCEPTABLE LEVEL
MODEL	191TE2L / 221TE2L
1 dark subpixel	5 or fewer
2 adjacent dark subpixels	2 or fewer
3 adjacent dark subpixels	0
Distance between two black dot defects*	>15mm
Total black dot defects of all types	5 or fewer

TOTAL DOT DEFECTS	ACCEPTABLE LEVEL
MODEL	191TE2L / 221TE2L
Total bright or black dot defects of all types	5 or fewer



Note

- 1 or 2 adjacent sub pixel defects = 1 dot defect

11 Troubleshooting

This section describes commonly encountered issues and suggested solutions.

General monitor issues

The monitor does not switch on:

- Disconnect the power cable from the power outlet. Wait for one minute then reconnect it.
- Check that the power cable is securely connected.

The remote control is not working properly:

- Check that the remote control batteries are correctly inserted according to the +/- orientation.
- Replace the remote control batteries if they are flat or weak.
- Clean the remote control and monitor sensor lens.

The standby light on the monitor blinks red:

- Disconnect the power cable from the power outlet. Wait until the monitor cools down before reconnecting the power cable. If the blinking reoccurs, contact Philips Consumer Care.

The monitor menu is in the wrong language

- Change the monitor menu to your preferred language.

When turning the monitor on/off/to standby, you hear a creaking sound from the monitor chassis:

- No action is required. The creaking sound is normal expansion and contraction of the monitor as it cools and warms up. This does not impact performance.

Monitor channel issues

Previously installed channels do not appear in the channel list:

- Check that the correct channel list is selected.

No digital channels were found during the installation:

- Check that the monitor supports DVB-T or DVB-C in your country. See the listed countries on the back of the monitor.

Picture issues

The monitor is on, but there is no picture:

- Check that the antenna is properly connected to the monitor.
- Check that the correct device is selected as the monitor source.

There is sound but no picture:

- Check that the picture settings are correctly set.

There is poor monitor reception from an antenna connection:

- Check that the antenna is properly connected to the monitor.
- Loud speakers, unearthed audio devices, neon lights, high buildings and other large objects can influence reception quality. If possible, try to improve the reception quality by changing the antenna direction or moving devices away from the monitor.
- If reception on only one channel is poor, fine tune this channel.

There is poor picture quality from connected devices:

- Check that the devices are connected properly.
- Check that the picture settings are correctly set.

The monitor did not save your picture settings:

- Check that the monitor location is set to the home setting. This mode offers you the flexibility to change and save settings.

The picture does not fit the screen; it is too big or too small:

- Try a different picture format.

The picture position is incorrect:

- Picture signals from some devices may not fit the screen correctly. Check the signal output of the device.

Sound issues

There is a picture but no sound from the monitor:

Note

- If no audio signal is detected, the monitor automatically switches the audio output off — this does not indicate malfunction.
- Check that all cables are properly connected.
- Check that the volume is not set to 0.
- Check that the sound is not muted.

There is a picture but the sound quality is poor:

- Check that the sound settings are correctly set.

There is a picture but sound comes from one speaker only:

- Verify that sound balance is set to the centre.

HDMI connection issues

There are problems with HDMI devices:

- Note that HDCP support can delay the time taken for a monitor to display content from an HDMI device.
- If the monitor does not recognise the HDMI device and no picture is displayed, try switching the source from one device to another and back again.
- If there are intermittent sound disruptions, check that output settings from the HDMI device are correct.
- If an HDMI-to-DVI adaptor or HDMI to DVI cable is used, check that an additional audio cable is connected to **AUDIO IN** (mini-jack only).

Computer connection issues

The computer display on the monitor is not stable:

- Check that a supported resolution and refresh rate is selected on the computer.
- Set the monitor picture format to unscaled.

Others

When should I use SmartContrast feature?

- SmartContrast feature is designed for enhancing movies as well as playing some games, as it enhances contrast ratio in dark moving scenes.
- Factory default is "Off".
- For office usage or internet applications it is recommended to turn SmartContrast "Off".

Power LED turn on for Auto program update

- In a case of auto s/w update, the unit will be turned on automatically for software updates. There will be no video or audio when doing the updates. The unit will also be returned to normal when software updates are completed.

Timing setting:

- It is recommended to adjust the time setting after scanning for TV channels to synchronize the time zone. This will facilitate any auto software updates being active in the right and designated time period provided by the monitor broadcasting system makers.

Contact us

If you cannot resolve your problem, refer to the FAQs for this monitor at www.philips.com/support.

If the problem remains unresolved, contact Philips Consumer Care in your country as listed in this User Manual.



Warning

- Do not attempt to repair the monitor yourself. This may cause severe injury, irreparable damage to your monitor or void your warranty.



Note

- Make a note of your monitor model and serial number before you contact Philips. These numbers are printed on the back of the monitor and on the packaging.



Version: M21TEEIQ

2010 © Koninklijke Philips Electronics N.V. All rights reserved.

Specifications are subject to change without notice.

Philips and the Philips Shield Emblem are registered trademarks of Koninklijke Philips Electronics N.V. and are used under license from Koninklijke Philips Electronics N.V."

www.philips.com

Free Manuals Download Website

<http://myh66.com>

<http://usermanuals.us>

<http://www.somanuals.com>

<http://www.4manuals.cc>

<http://www.manual-lib.com>

<http://www.404manual.com>

<http://www.luxmanual.com>

<http://aubethermostatmanual.com>

Golf course search by state

<http://golfingnear.com>

Email search by domain

<http://emailbydomain.com>

Auto manuals search

<http://auto.somanuals.com>

TV manuals search

<http://tv.somanuals.com>