

Philips Hospitality LCD TV: Pro range



EN 19HFL3330D/10
EN 22HFL3330D/10

Please ask your local sales support for additional information on correct installation/ positioning of the TV in the room and complementary accessories

DFU-AUG2008

PHILIPS

PB1

Table of contents

| | |
|---|----------|
| 1 INTRODUCTION FOR PBS MODE | 2 |
| 2 REMOTE CONTROL | 3 |
| 2.1 Remote control 2573 overview (optional) | 3 |
| 2.2 Guest Remote control overview | 3 |
| 3 INITIAL SETUP | 5 |
| 3.1 Virgin mode – Out of box Setting | 5 |
| 4 SETUP MENU AND PBS MODE BEHAVIOR | |
| 4.1 PBS MODE | 6 |
| 4.2 APPLICATION | 6 |
| 4.3 SWITCH ON SETTINGS | 7 |
| 4.4 CONTROL SETTINGS | 7 |
| 4.5 BLANK CHANNEL | 8 |
| 4.6 SMARTLOADER TO TV | 8 |
| 4.7 TV TO SMARTLOADER | 8 |
| 4.8 STORE | 9 |
| 4 PRACTICAL HINTS | 9 |

1 INTRODUCTION TO PBS MODE

The Professional Business Solutions (PBS) mode defines a specific TV or monitor mode (similar to hotel mode).

This mode limits the amount of TV controls (e.g. like volume limitation), that a normal user (i.e. hotel guest) can use. The amount of access can be configured in the setup menu by a super-user (e.g. hotel installer).

This manual describes how to setup a television channels using Virgin Mode, configure other TV settings and activate the PBS mode.

2 REMOTE CONTROL

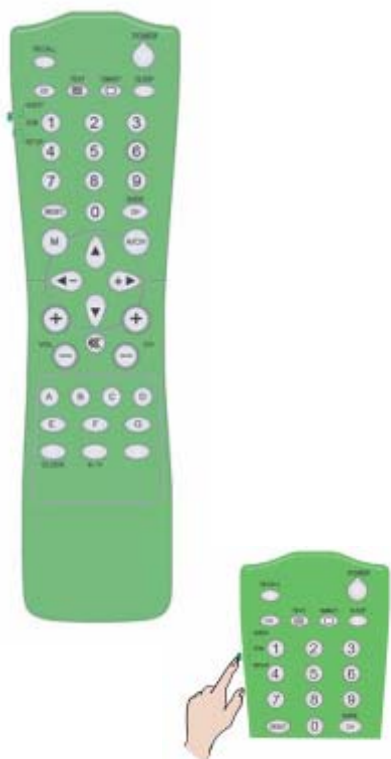

2.1 PBS Set-Up Remote control 2573 (optional)





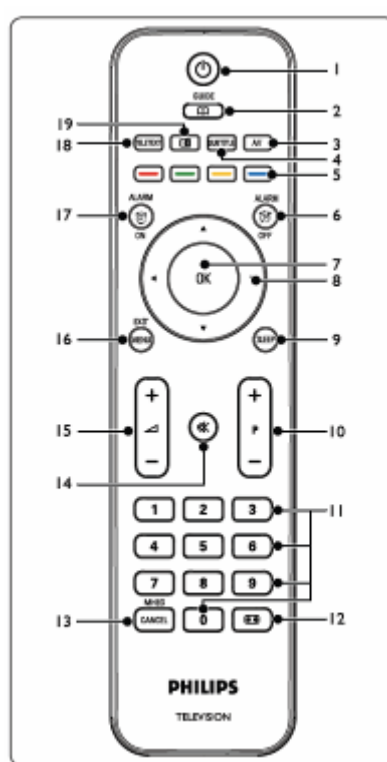

 **Note:** Setup mode should be selected for hotel installer.

2.2 Guest Remote control 22AV1104/10



- 1. On/Standby**  Switches the TV on from standby or back to standby.
- 2. GUIDE**  (DVB-T)
Toggles the Electronic Program Guide on or off. Only active with digital channels.
- 3. SOURCE**
Selects connected devices.
- 4. SUBTITLE** (DVB-T)
Activates or deactivates subtitles.
- 5. COLOUR KEYS**
Selects tasks or teletext pages.
- 6. ALARM OFF**
Disable Alarm status - Not applicable for this model.

7. **OK**
Accesses the **All channels** menu or activates a setting.
8. 
Navigate the menu.
9. **SLEEP**
Display the sleep timer menu and adjust the sleep timer.
10. **P +/-**
Switches to the next or previous channel.
11. **NUMBER KEYS**
Selects a channel, page or setting.
12. 
Selects a picture format.
13. **MHEG CANCEL**
Cancels digital text or interactive services (UK only).
14. 
Mutes or restores sound.
15.  +/-
Increases or decreases volume.
16. **MENU/EXIT**
Toggles the menu on or off.
17. **ALARM ON**
Display the Alarm menu - not applicable for this model.
18. **TELETEXT**
Toggles teletext on or off.
19. 
Splits the current channel or source on the left of the screen. Teletext appears on the right.

3 INITIAL SETUP

1.1 Virgin mode – Out Of Box Setting and Initial Setup

This TV set includes an installation feature that, at initial set-up of the TV, guides you through the installer menu to apply the proper installation settings. This feature, named Virgin Mode, active when the TV set is unpacked and first powered on, is normally used for installation/setting of first TV set. To save time during a complete setup for hospitality system with more televisions, the settings of this first TV set can be duplicated to other televisions using the cloning mechanism (described in chapters 4.6 and 4.7).



Press OK or the green color key on your remote control to confirm

- ⊞ Before setting PBS Mode to ON, and not using cloning as configuration mechanism, the television must be configured.
- ⊞ Note: In case of cloning the TV settings, Virgin mode can be skipped by pressing the “Menu” button on the television twice.

Follow the Virgin Mode guiding to set all channels/programs

Digital Channels start at Program Number 1, Analogue Channels start at Program Number 900.

- ⊞ Note: The channel list can be customized by hotel installer through Rearrange channel list feature as indicated below.

Also rearrange channels can be easily done through using Rename Channels feature by

PB5

entering direct channel numbers and channel name if needed.

| Channel installation | Rearrange |
|-----------------------------|-----------|
| Automatic installation | 0 |
| Installation update | 1 |
| Digital: Test reception | 2 |
| Analog: Manual installation | 3 |
| Rearrange | 4 |
| | 5 |
| | 6 |
| | 7 |

| Rearrange |
|-----------|
| 0 |
| 1 |
| 2 |
| 3 |
| 4 |
| 5 |
| 6 |
| 7 |

This allows you to rename to reshuffle and to uninstall or reinstall the stored TV channels. Press the corresponding colour keys.

After setup/installation is completed, subsequent switching on the TV will not let this Virgin Mode menu to pop up again.

For details refer to consumer TV User Guide.

Preferred customer picture, sound and feature settings - these settings will be used whenever the TV is switched on from mains or standby in PBS Mode

This can be achieved by popping up consumer TV setup menu as below and do Picture/sound setup and channel installation etc accordingly: Apart from manually adjusting picture settings, you can use Smart settings to set your TV to a predefined picture and sound setting.

| TV Menu | Smart settings |
|----------------|----------------|
| Smart settings | Personal |
| Picture | Vivid |
| Sound | Standard |
| Features | Movie |
| Instal | Power saver |
| | |
| | |

For details refer to consumer TV User Guide.

The installer should change the TV to Home mode by select Install > Preferences > Location

| Preferences | Location |
|-------------|----------|
| Location | Shop |
| Easylink | Home |
| | |
| | |
| | |
| | |

This allows you to select the location of your TV. Choose Home to have full flexibility to change any predefined settings.

4 DISPLAY SETUP MENUS

The TV can display PBS Setup menu by pressing RC2573 MENU key in SETUP mode or by following Guest RC key sequence "319753" key within 10 seconds if high security mode set to Off.

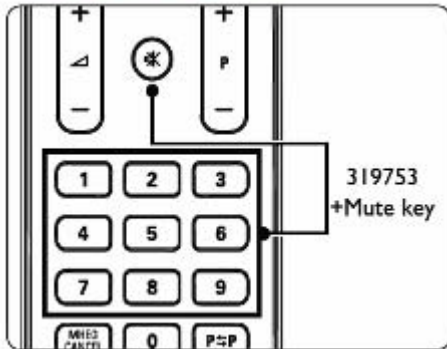
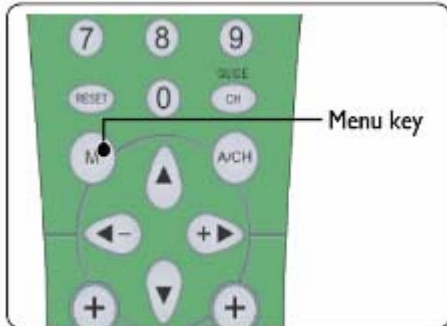

The following menu appears.

| Setup menu | PBS mode |
|--------------------|----------|
| PBS mode | off |
| Application | on |
| Switch on settings | |
| Control settings | |
| Blank channel | |
| Smartloader to TV | |
| TV to smartloader | |
| Store | |

4.1 PBS MODE

To activate PBS Mode, select ON.

| Setup menu | PBS mode |
|--------------------|----------|
| PBS mode | off |
| Application | on |
| Switch on settings | |
| Control settings | |
| Blank channel | |
| Smartloader to TV | |
| TV to smartloader | |
| Store | |

4.2 APPLICATION

The Application to select is Hotel/Hospital or Business Monitor; this is based on the installer requirement.

| Setup menu | Application |
|--------------------|------------------|
| PBS mode | Business/Monitor |
| Application | Hotel/Hospital |
| Switch on settings | |
| Control settings | |
| Blank channel | |
| Smartloader to TV | |
| TV to smartloader | |
| Store | |

When APPLICATION is Hotel/Hospital, the limited Guest TV menu can be accessed by guest as below: Refer to consumer TV User Guide for the description of each menu item.

| Guest menu | Picture format |
|-------------------|-------------------|
| Picture format | Super zoom |
| Subtitle | 4:3 |
| Subtitle language | Movie expand 14:9 |
| Audio language | Movie expand 16:9 |
| Sleep timer 0 | Wide screen |
| | Subtitle zoom |

When APPLICATION is BUSINESS MONITOR, the normal consumer TV setup menu can be accessed by using guest RC menu key with the additional control features listed in the PBS setup menu.

- **REMOTE CONTROL LOCKED** – Enable or disable the operation of the normal remotes. However, when the High Security Mode is OFF, to enter PBS Mode Menu, using the “319753 ” key sequence is not blocked, even when Remote Control Locked is ON.

- **OSD DISPLAY** – Enable or disable OSD display (e.g., channel number or name, sound mode, volume bar, clock, etc.).

- **HIGH SECURITY MODE** – choice between using normal consumer RC or PBS setup RC to display the setup menu. When enabled, only the setup RC menu key can display the setup menu. When disabled, both the setup RC menu key and normal guest remote control sequence “319753” can display the setup menu.

- **AUTO SCART** – Enable (ON) or disable (OFF) autoscart switching or break-in in PBS mode.

- **LOW POWER STANDBY** - define the power mode when TV set goes to standby by pressing RC power key or Local Keyboard power key - Green: TV will enter low standby power mode to achieve minimum power consumption; Fast: TV will enter semi-standby mode to achieve fast powering up,



4.5 BLANK CHANNEL

- **BLANK CHANNEL** - choice of either blank or not blanking the video for the current channel. In PBS application, the blanked channel is used for off-air radio transmission, e.g., re-modulated FM radio, music CDs etc. The current blank mode should follow the channel blanked status and changing the channel blanked should also blank or unblank the current channel.

| Setup menu | | Blank channel |
|--------------------|--|---------------|
| PBS mode | | off |
| Application | | on |
| Switch on settings | | |
| Control settings | | |
| Blank channel | | |
| Smartloader to TV | | |
| TV to smartloader | | |
| Store | | |

| Blank channel | |
|---------------|--|
| off | |
| on | |
| | |
| | |
| | |
| | |
| | |
| | |
| | |



Note: Channel Blank will apply for the current channel, to navigate and blank other channels, Blank channel submenu should be selected by clicking on right cursor key as below:

PB8

4.6 SMARTLOADER TO TV (using USB)

| Setup menu | | Smartloader to TV |
|--------------------|--|-----------------------|
| PBS mode | | |
| Application | | Load |
| Switch on settings | | Settings copied to TV |
| Control settings | | |
| Blank channel | | |
| Smartloader to TV | | |
| TV to smartloader | | |
| Store | | |

Copy TV configuration data (Video, Audio, Channel Table, PBS Mode settings) from USB Memory stick to TV. Upon copying progress completion, an indication message will feedback to PBS-user (“Settings copied to TV”).



Note: During copying process, the USB memory stick should not be removed to prevent any undersigned functionality of the TV.



Note: During this process, the cloning files NVM_MTK_2K8_EU.BIN and CH_MTK_2K8_EU.BIN are retrieved by TV and update the TV NVM and Channel setup accordingly.



Note: All RC command and local keyboard will be disabled during copying process



Note: It is recommended to do a television switch off/switch on after the cloning is done.

4.7 TV TO SMARTLOADER (using USB)

| Setup menu | | TV to smartloader |
|--------------------|--|------------------------|
| PBS mode | | |
| Application | | Load |
| Switch on settings | | Settings copied to USB |
| Control settings | | |
| Blank channel | | |
| Smartloader to TV | | |
| TV to smartloader | | |
| Store | | |

Copy TV configuration data (Video, Audio, Channel Table, PBS Mode settings[i.e. Welcome Message, ...]) from TV to USB drive.

- Upon copying progress completion, an indication will given as feedback to PBS-user (“Settings copied to USB”)

⊖ A 128MB USB Memory Stick with at least 10MB free memory space will be suitable.

⊖ **Note:** During copying process, USB drive should not be removed to prevent any undersigned functionality of the TV.

⊖ **Note:** After completed, there are 2 files generated in the USB root directory - NVM_MTK_2K8_EU.BIN containing the general setting for example, Video/Audio, etc. and CH_MTK_2K8_EU.BIN containing the channel installation setting for example channel list, etc.

⊖ **Note:** All RC command and local keyboard will be disabled during copying process

⊖ **Note:** Normally, the first TV is manually configured/setup by the hotel installer, then all the data are transferred/ cloned to USB drive through TV to Smart Loader, subsequently, others TVs can be updated by using same USB drive. This cloning feature prevent multi manually setup on all the TV sets, hence, speed up the hotel installation process.

4.8 STORE

Activation of this item will store PBS mode settings. The PBS mode setting will take effect after putting the set to standby.

⊖ **Important:** Cloning system and configuration settings, using USB or SerialXpress, is only supported in case of using equal televisions.

5 HOW TO POSITION YOUR TV

VIEWING ANGLE is the most convenient angle at which a display can be viewed with good visual performance

Horizontal Viewing Area

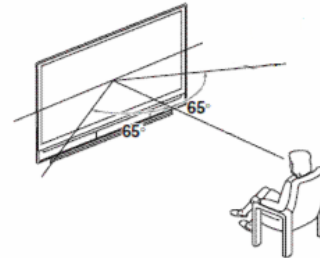

Vertical Viewing Area

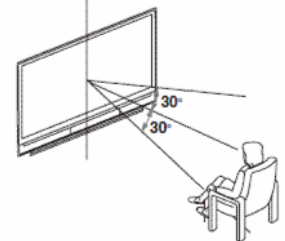

How a TV and panel are designed:

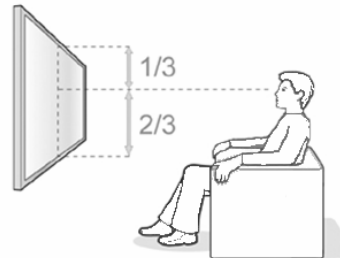

What to do if viewing angle is not good enough:

- Add tilt (vertical) or swivel (horizontal) to the TV, in order to position the TV in the most optimal situation.
- If the TV is placed above a certain height, it's advised to always tilt the TV.

Philips has wall mounts with tilt for hotel TVs as optional accessories.

Philips is recommending to position the TV as mentioned above. Positioning the TV differently might have impact on the viewing angle. Philips is not responsible for reduced viewing experience due to wrong viewing angle if the TV is positioned differently then recommended.

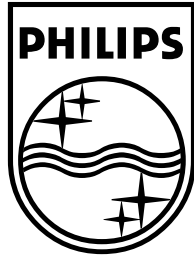

© 2008 Koninklijke Philips Electronics N.V.
All rights reserved.
72-E330MD-X411A

Register your product and get support at

www.philips.com/welcome



EN USER MANUAL

PHILIPS

Table of contents

| | | | |
|---|-----------|---|-----------|
| 1 Important | 3 | 5.8 Use subtitles | 23 |
| 1.1 Safety | 3 | 5.9 Listen to digital radio channels..... | 23 |
| 1.2 Screen care | 4 | 5.10 Update your TV software..... | 23 |
| 1.3 Environmental care..... | 4 | 6 Install channels | 24 |
| 2 Your TV | 5 | 6.1 Automatically install channels..... | 24 |
| 2.1 TV overview | 5 | 6.2 Manually install channels..... | 25 |
| 3 Get started | 7 | 6.3 Rearrange channels..... | 26 |
| 3.1 Position the TV | 7 | 6.4 Rename channels..... | 26 |
| 3.2 Wall mount the TV..... | 7 | 6.5 Uninstall or reinstall channels..... | 27 |
| 3.3 Connect the antenna cable..... | 9 | 6.6 Manually update the channel list..... | 27 |
| 3.4 Connect the mains cord..... | 9 | 6.7 Test digital reception..... | 27 |
| 3.5 Manage cables | 10 | 7 Connect devices | 28 |
| 3.6 Insert the remote control batteries.. | 10 | 7.1 Connection overview | 28 |
| 3.7 Switch on the TV..... | 10 | 7.2 Select connection quality | 29 |
| 3.8 First time setup..... | 10 | 7.3 Connect devices | 31 |
| 4 Use your TV | 11 | 7.4 Setup devices..... | 35 |
| 4.1 Switch your TV on/off or to standby | 11 | 7.5 Use Philips EasyLink | 35 |
| 4.2 Watch TV..... | 12 | 7.6 Prepare TV for digital services | 36 |
| 4.3 Watch connected devices..... | 12 | 8 Technical specifications | 37 |
| 4.4 Use teletext..... | 12 | 9 Troubleshooting | 38 |
| 5 Use more of your TV | 14 | 9.1 General TV issues | 38 |
| 5.1 Remote control overview..... | 14 | 9.2 TV channel issues | 38 |
| 5.2 Use TV menus..... | 15 | 9.3 Picture issues..... | 38 |
| 5.3 Adjust picture and sound settings .. | 17 | 9.4 Sound issues | 39 |
| 5.4 Change to Shop or Home mode | 19 | 9.5 HDMI connection issues..... | 39 |
| 5.5 Use advanced teletext features | 20 | 9.6 PC connection issues | 39 |
| 5.6 Use Electronic Programme Guide | 20 | 9.7 Contact us..... | 40 |
| 5.7 Adjust feature settings | 21 | 10 Index | 41 |

2008 © Koninklijke Philips Electronics N.V. All rights reserved. Specifications are subject to change without notice. Trademarks are the property of Koninklijke Philips Electronics N.V. or their respective owners.

Philips reserves the right to change products at any time without being obliged to adjust earlier supplies accordingly.

The material in this manual is believed adequate for the intended use of the system. If the product, or its individual modules or procedures, are used for purposes other than those specified herein, confirmation of their validity and suitability must be obtained. Philips warrants that the material itself does not infringe any United States patents. No further warranty is expressed or implied.

Warranty

No components are user-serviceable. Do not open or remove covers to the inside of the product. Repairs may only be done by Philips Service Centres and official repair shops. Failure to do so shall void any warranty, stated or implied. Any operation expressly prohibited in this manual, any adjustments, or assembly procedures not recommended or authorised in this manual shall void the warranty.

Pixel characteristics

This LCD product has a high number of colour pixels. Although it has effective pixels of 99,999% or more, black dots or bright points of light (red, green or blue) may appear constantly on the screen. This is a structural property of the display (within common industry standards) and is not a malfunction.

Open source software

This television contains open source software. Philips hereby offers to deliver or make available, upon request, for a charge no more than the cost of physically

performing source distribution, a complete machine-readable copy of the corresponding source code on a medium customarily used for software interchange.

This offer is valid for a period of 3 years after the date of purchase of this product. To obtain the source code, write to

Philips Innovative Applications N.V.
Ass. to the Development Manager
Pathoekeweg 11
B-8000 Brugge
Belgium

Compliance with EMF

Koninklijke Philips Electronics N.V. manufactures and sells many products targeted at consumers, which, like any electronic apparatus, in general have the ability to emit and receive electromagnetic signals.

One of Philips' leading Business Principles is to take all necessary health and safety measures for our products, to comply with all applicable legal requirements and to stay well within the EMF standards applicable at the time of producing the products.

Philips is committed to develop, produce and market products that cause no adverse health effects.

Philips confirms that if its products are handled properly for their intended use, they are safe to use according to scientific evidence available today.

Philips plays an active role in the development of international EMF and safety standards, enabling Philips to anticipate further developments in standardisation for early integration in its products.

Mains fuse (UK only)

This TV is fitted with an approved moulded plug. Should it become necessary to replace the mains fuse, this must be replaced with a fuse of the same value as indicated on the plug (example 10A).

1. Remove fuse cover and fuse.
2. The replacement fuse must comply with BS 1362 and have the ASTA approval mark. If the fuse is lost, contact your dealer in order to verify the correct type.
3. Refit the fuse cover.

In order to maintain conformity to the EMC directive, the mains plug on this product must not be detached from the mains cord.

Copyright



VESA, FDMI and the VESA Mounting Compliant logo are trademarks of the Video Electronics Standards Association.

® Kensington and Micro Saver are registered US trademarks of ACCO World Corporation with issued registrations and pending applications in other countries throughout the world. All other registered and unregistered trademarks are the property of their respective owners.

1 Important

Congratulations on your purchase and welcome to Philips!

Read this user manual before you start to use this product.

Pay close attention to this section and follow the safety and screen care instructions. The product warranty does not apply if damage is caused by failing to follow these instructions.

To fully benefit from the support that Philips offers, register your product at www.philips.com/welcome.

The model and serial number of your TV can be found on the back and side of the TV as well as on the packaging.

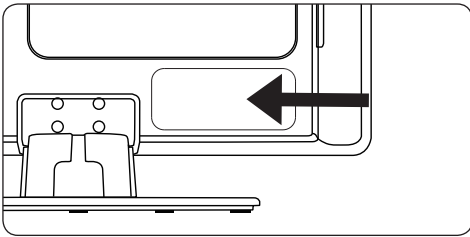

1.1 Safety

- The apparatus must be connected to a mains socket outlet with a protected earthed connection.
- If transporting the TV in low temperatures (less than 5°C), open the box and wait until the TV matches the ambient temperature of the room before unpacking.
- To avoid short circuit, do not expose the TV, remote control or remote control batteries to rain or water.
- Do not place vessels of water or other liquids on top of or near the TV. Spilling liquids on the TV can cause electric shock. If liquids are spilt on the TV, do not operate the TV. Immediately disconnect the TV from the mains and have the TV checked by a qualified technician.
- Do not insert any strange object into the ventilation slot. This might lead to damage of TV.
- To avoid risk of fire or electric shock, do not place the TV, remote control or remote control batteries near naked flame sources (e.g. lighted candles) and other heat sources including direct sunlight.
- Do not install the TV in a confined space such as a bookcase. Leave a space of at least 10cm (four inches) around the TV for ventilation. Be sure air flow is not obstructed.
- If placing the TV on a flat, solid surface be sure to use only the supplied stand. Do not move the TV if the stand is not properly screwed to the TV.
- Wall mounting of the TV should only be performed by qualified personnel. The TV must only be mounted on an appropriate wall bracket and on a wall that can safely hold the weight of the TV. Improper wall mounting can result in severe injury or damage. Do not attempt to wall mount the TV yourself.
- If the TV is mounted on a swivel base or swivel arm, ensure no strain is placed on the power cord when the TV is swivelled. Strain on the power cord can loosen connections and cause arcing or fire.
- Disconnect the TV from the mains and antenna before lightning storms. During lightning storms do not touch any part of the TV, mains cord or antenna cable.
- Be sure that you have full access to the mains cord for easy disconnection of the TV from the mains.
- Permanent hearing loss can occur if you use earphones or headphones at high volumes. Though high volume may sound normal over time, it can damage your hearing. To protect your hearing, limit the amount of time you use earphones or headphones at high volume.

- When disconnecting the TV from the mains, be sure to:
 - Turn off the TV, then the mains power (if available).
 - Unplug the mains cord from the mains socket outlet.

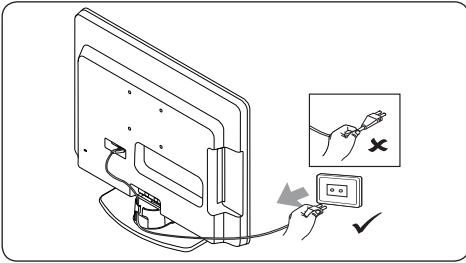

- Unplug the mains cord from the power connector at the back of the TV. Always pull the mains cord by the plug. Do not pull the mains cord

1.2 Screen care



- Turn off and unplug the mains cord before cleaning the screen. Clean the screen with a soft, dry cloth. Do not use substances such as household cleaning agents as these may damage the screen.
- To avoid deformations or colour fading, wipe off water droplets as soon as possible.
- Do not touch, push, rub or strike the screen with hard objects as this may damage the screen permanently.
- Where possible, avoid stationary images that remain on-screen for extended periods of time. Examples include screen menus,

teletext pages, black bars or stock market tickers. If you must use stationary images, reduce the screen contrast and brightness to avoid screen damage.

1.3 Environmental care

Recycling your packaging

The packaging of this product is intended to be recycled. Contact your local authorities for information on how to recycle the packaging.

Disposing your used product



Your product is manufactured with high-quality materials and components that can be recycled and reused. When you see the crossed-out wheel bin symbol attached to a product, it means the product is covered by the European Directive 2002/96/EC:

Do not dispose your used product with household waste. Ask your dealer for information on how to safely dispose of the product. Uncontrolled waste disposal harms both the environment and human health.

Disposing used batteries

The supplied batteries do not contain mercury or cadmium. Dispose supplied and all other used batteries according to your local regulations.

Power consumption

The TV consumes minimal energy in standby mode to minimise environmental impact. Active power consumption is displayed at the back of the TV.

For more product specifications, see the product leaflet at www.philips.com/support.

2 Your TV

This section gives you an overview of commonly-used TV controls and functions.

2.1 TV overview

Side controls and indicators

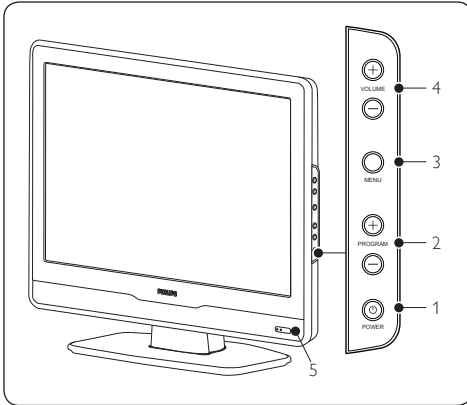

1. **POWER**
2. **PROGRAM +/-**
3. **MENU**
4. **VOLUME +/-**
5. Power indicator/remote control sensor

Side connectors

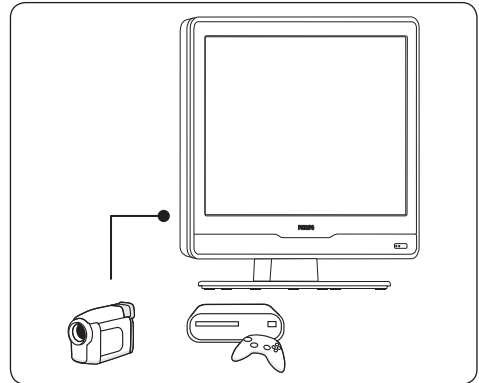

Use the TV side connectors to connect to mobile devices such as a high-definition camcorder or game console. You can also connect a pair of headphone.

Back connectors

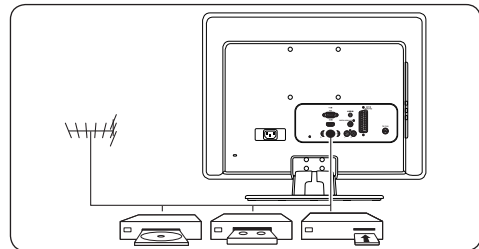

Use the TV back connectors to connect to the antenna and permanent devices such as a high-definition disc player, DVD player or VCR.

Note

For more information about connections, see *Section 7 Connect devices.*

Remote control

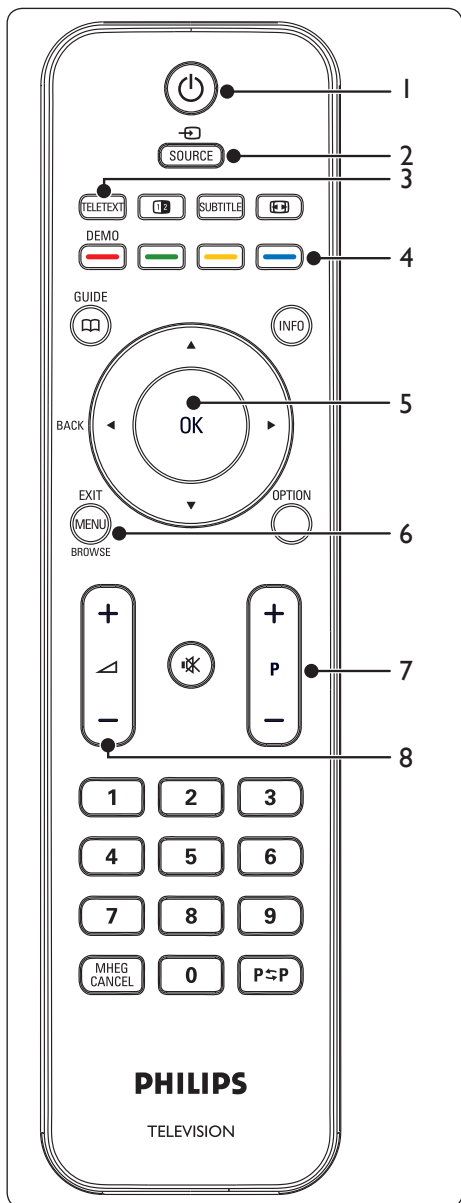

1. Power
2. **SOURCE**
3. **TELETEXT**
4. Colour keys
From left, red, green, yellow, blue
5. Navigation or cursor keys
6. **MENU**
7. **P +/-**
Program up or down
8. +/-
Volume up or down

For advanced information about the remote control, see *Section 5.1 Remote control overview*.

3 Get started

This section helps you position and install the TV and supplements the information provided in the *Quick Start Guide*.

Note

Refer to the *Quick Start Guide* for stand mounting instructions.

3.1 Position the TV

In addition to reading and understanding the safety instructions in *Section 1.1*, consider the following before positioning your TV:

- The ideal viewing distance for watching TV is three times its screen size.
- Position the TV where light does not fall on the screen.
- Connect your devices before you position your TV.
- Your TV is equipped with a Kensington Security Slot at the back of the TV. If connecting an anti-theft Kensington lock (not supplied), position the TV within reach of a permanent object (such as a table) that can be easily attached to the lock

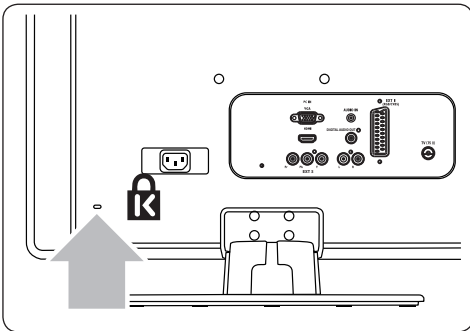

3.2 Wall mount the TV

WARNING

Wall mounting of the TV should only be performed by qualified installers. Koninklijke Philips Electronics N.V. bears no responsibility for improper mounting that results in accident or injury.

Step 1 Purchase a VESA-compatible wall bracket

Depending on the size of your TV screen, purchase one of the following wall brackets:

| TV screen size (inches/cm) | VESA-compatible wall bracket type (millimeters) | Special instructions |
|----------------------------|---|----------------------|
| 22"/55.9cm | Fixed 100 x 100 | None |
| 19"/48.4cm | Fixed 100 x 100 | None |

Step 2 Remove the TV stand

Note

These instructions are only applicable to TV models with mounted stands. If your TV stand is not mounted, skip to *Step 3 Connect cables*.

1. Carefully place the TV face down on a flat, stable surface that is covered by soft cloth. The cloth should be thick enough to protect your screen.

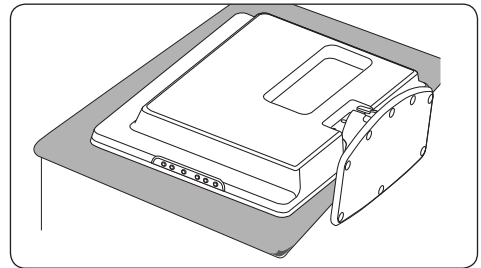

2. Using a cross-head screwdriver (not supplied), unscrew the four bolts that secure the stand to the TV. (19" has four bolts, 22" has three bolts)

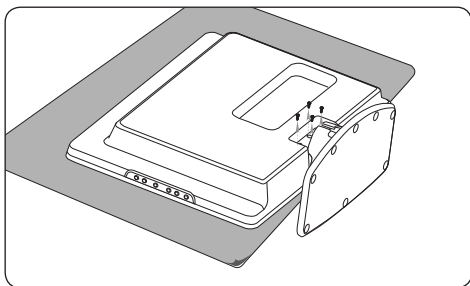

3. Firmly pull the stand from the bottom of the TV. Place both the stand and bolts in a secure location for future reinstallation.

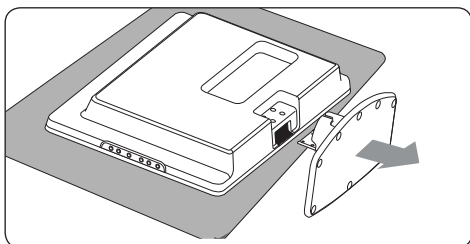

Step 3 Connect cables

Connect the antenna cable, mains cord and all other devices to the back of the TV as described in the following sections.

Step 4 Secure the VESA-compatible wall bracket to the TV



WARNING

Only use the bolts (M4 for all models) and spacers (4cm) to secure the VESA-compatible wall bracket to your TV.

The bolts (not supplied) are designed to match the weight of your TV; spacers (not supplied) are designed for easy cable management.



Note

Depending on your VESA-compatible wall bracket, you may need to separate the mounting plate from the wall bracket for easier installation. Refer to your VESA-

compatible wall bracket documentation for instructions.

1. Locate the four mounting nuts at the back of the TV.

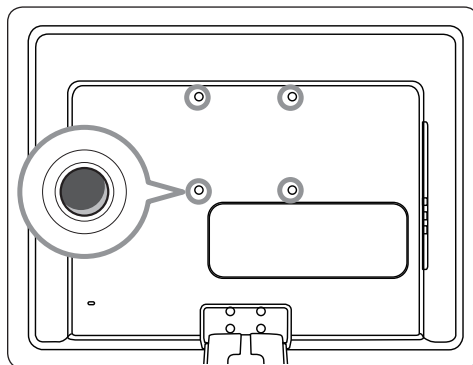

2. Align the plate/bracket to the four mounting nuts, placing the spacers between the plate/bracket and the mounting nuts.
3. Using a spanner, insert the bolts through the plate/bracket and spacers, tightly securing the bolts to the mounting nuts.

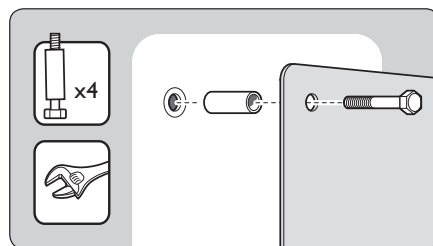

4. Continue with the instructions provided with your VESA-compatible wall bracket.

3.3 Connect the antenna cable

1. Locate the **TV ANTENNA** connector at the back of the TV.

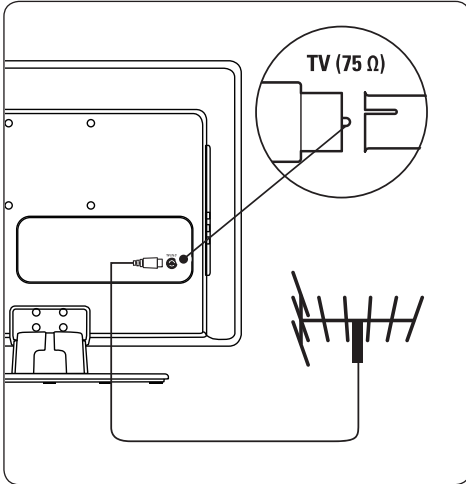

2. Connect one end of an antenna cable (not supplied) to the **TV ANTENNA** connector. Use an adaptor if the antenna cable does not fit.
3. Connect the other end of the antenna cable to your antenna outlet, ensuring that the cable is tightly secured at both ends.

3.4 Connect the mains cord



WARNING

Verify that your mains voltage corresponds with the voltage printed at the back of the TV. Do not insert the mains cord if the voltage is different.

To connect the mains cord



Note: The location of the mains connector according to TV model.

1. Locate the **AC IN** mains connector at the back or on the bottom of the TV.

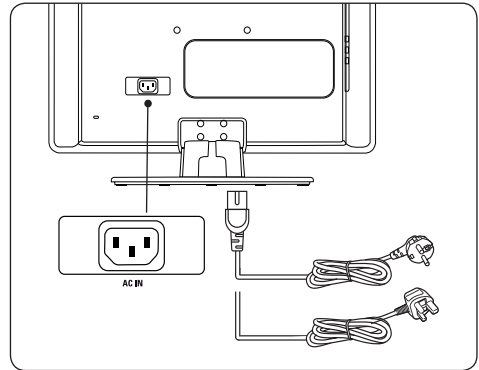

2. Connect the mains cord to the **AC IN** mains connector.
3. Connect the mains cord to the mains, ensuring that the cord is tightly secured at both ends.

3.5 Manage cables

Route your mains cord, antenna cable and all other device cables through the cable holder (1) at the back of the TV.

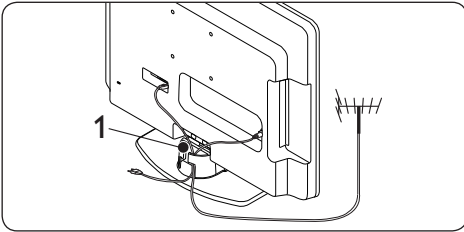

3.6 Insert the remote control batteries

1. Slide the battery cover off the back of the remote control.

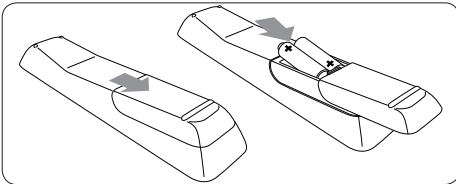

2. Insert the two supplied batteries (Size AAA, Type LR03). Be sure the + and - ends of the batteries line up with the markings inside the case.
3. Slide the cover back into position.

⊖ Note

Remove the batteries if not using the remote control for an extended period of time.

3.7 Switch on the TV

The first time you switch on the TV, check that the mains cord is properly connected. When ready, then press **POWER** on the side of the TV.

⊖ Note

Certain TV models require you to press and hold **POWER** for up to two seconds. Your TV may take up to 15 seconds to start.

3.8 First time setup

When you turn on the TV set for the first time, a menu is displayed on screen. This menu prompts you to select the Country and Language for the menus:

If the menu is not displayed, press the **MENU** key to display the menu.

1. Press **▲** or **▼** to select your language, and press **OK** to confirm your choice.
2. Press **▲** or **▼** to select your country, and press **OK** to confirm your choice.

The search starts automatically. All available TV programmes and radio stations are stored. This operation takes a few minutes. The display shows the progress of the search and the number of programs found. At the end of the search, the menu disappears.

⊖ Note

If no programme is found, consult the possible solutions see section 9 troubleshooting.

If the transmitter or cable network sends the automatic sort signal, the programs will be numbered correctly. In this case, the installation is complete.

3. If this is not the case, use the **Channel setting** menu to number the programs correctly.

4 Use your TV

This section helps you perform basic TV operations. Instructions on advanced TV operations are provided in *Section 5 Use more of your TV*.

4.1 Switch your TV on/off or to standby

Switch on your TV

- If the power indicator (1) is off, press **POWER** on the side of the TV.

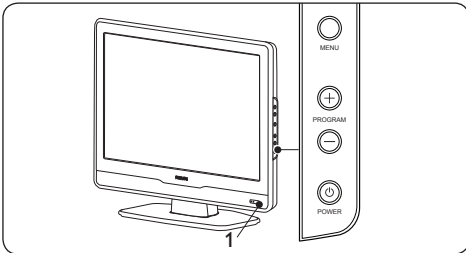

Switch off your TV

- Press **POWER** on the side of the TV. The power indicator (1) switches off.

Switch to standby

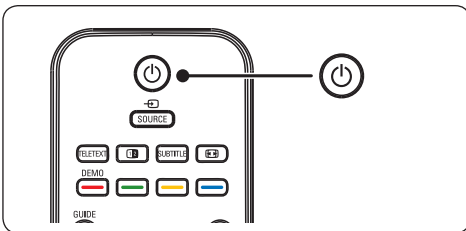

- Press  on the remote control. The power indicator switches to standby (red).

* Tip

Though your TV consumes very little power when in standby, energy continues to be consumed as long as the mains remain

connected and powered. When not in use for extended periods of time, switch off and disconnect the TV from the mains.

Switch on from standby

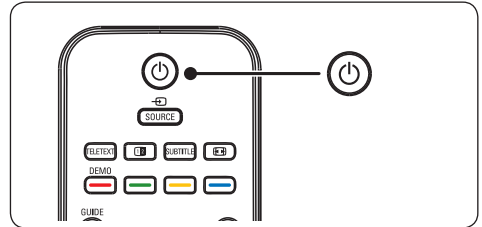

- If the power indicator is in standby (red), press  on the remote control.

Note

If you cannot locate your remote control and you want to switch on the TV from standby, press **PROGRAM +/-** on the side of the TV.

4.2 Watch TV

Switch channels

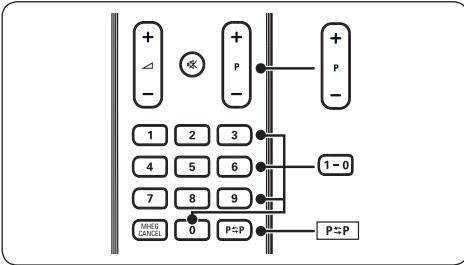

1. Press a number (1 to 99) or press **P +/-** on your remote control.
2. Press **PROGRAM +/-** on the side controls of the TV.
3. Press **P=P** on the remote control to return to the previously-viewed TV channel.

Adjust volume

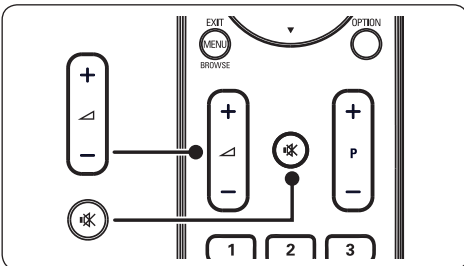

1. Press **▲ +** or **-** on the remote control, or Press **VOLUME +** or **-** on the side controls of your TV.
2. Press **MUTE** on the remote control to mute the sound. Press **MUTE** again to unmute on the sound.

ⓘ Note

If headphones are connected, adjust headphone volume as described in *Section 5.3 Adjust sound settings*. You must press the **MUTE** button on the remote control to

mute audio from the TV speakers. Pressing **VOLUME +/-** buttons turns on the TV speakers again.

4.3 Watch connected devices

1. Switch on the device.
2. Press **SOURCE** on the remote control.

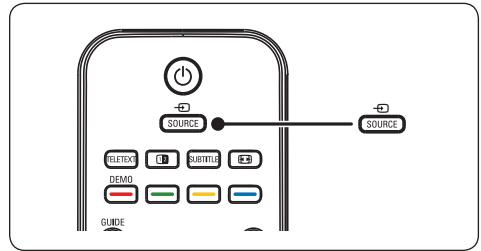

3. Press **▲** or **▼** to select the input your device is connected to.
4. Press **OK** to select the device.

4.4 Use teletext

1. Press **TELETEXT** on the remote control. The main index page appears.

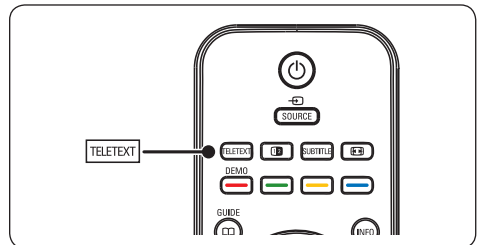

- To select a page with the remote control:
 - Enter the page number with the number keys.
 - Press **P +/-** or **▲ ▼** to view the next or previous page.
 - Press a colour key to select one of the colour coded items at the bottom of the screen.

*** Tip**

Press **P↔P** to return to the previously viewed page.

2. Press **TELETEXT** again to switch off teletext.

⊖ Note (for UK users only)

Some digital TV channels offer dedicated digital text services (for example, BBC1).

For advanced information on teletext, see *Section 5.5 Use advanced teletext features.*

5 Use more of your TV

5.1 Remote control overview

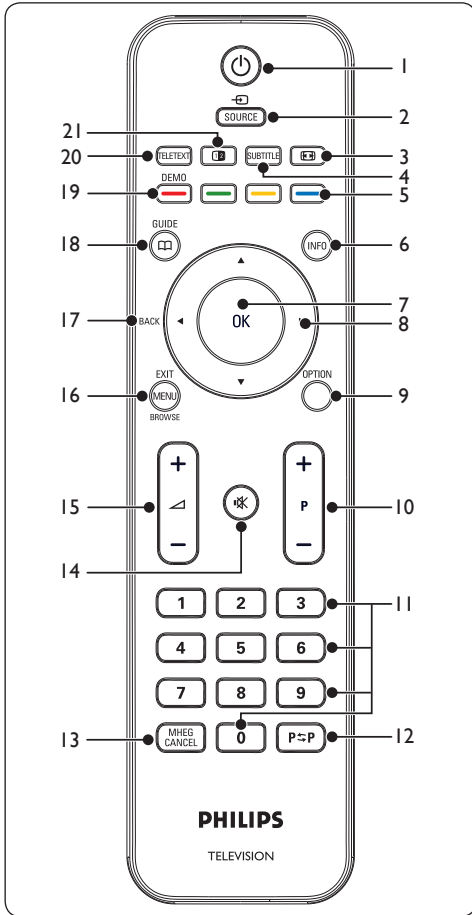

1. Switches the TV on from standby or back to standby.
2. **SOURCE**
Selects connected devices.
3. Selects a picture format.
4. **SUBTITLE**
Activates or deactivates subtitles.

5. Colour keys
Selects tasks or teletext pages.
6. **INFO**
Displays programme information, if available.
7. **OK**
Accesses the **All channels** menu or activates a setting.
8.
Navigate the menu.
9. **OPTION**
Activates the **Quick access** menu.
10. **P +/-**
Switches to the next or previous channel.
11. Number keys
Selects a channel, page or setting.
12. **P<=>P**
Returns to the previously-viewed channel.
13. **MHEG CANCEL**
Cancels digital text or interactive services (UK only).
14.
Mutes or restores sound.
15.
Increases or decreases volume.
16. **MENU/EXIT/BROWSE**
Toggles the menu on or off.
17. **BACK**
18. **GUIDE**
Toggles the Electronic Programme Guide on or off. Only active with digital channels.
19. **DEMO**
Not Supported.
20. **TELETEXT**
Toggles teletext on or off.
21.
Splits the current channel or source on the left of the screen. Teletext appears on the right.

5.2 Use TV menus

On-screen menus help you install your TV, adjust picture and sound settings and access other features. This section describes how to navigate the menus.

Access the main menu

1. Press **MENU** on the remote control to display the main menu.

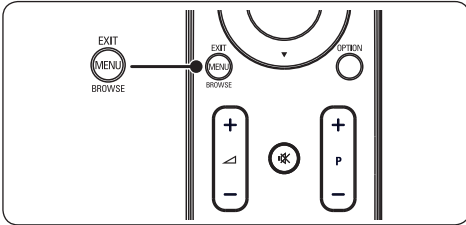

The following menu appears.

| PHILIPS | |
|----------------|----------------|
| TV Menu | Smart settings |
| Smart settings | Personal |
| Picture | Vivid |
| Sound | Standard |
| Features | Movie |
| Install | Power saver |
| | |
| | |

2. Press ▲ or ▼ to move the cursor to the following items:
 - **Smart settings**
 - **Picture**
 - **Sound**
 - **Feature**
 - **Install**
3. Press ► or **OK** to select an item.
4. Press **MENU** to exit.

Use the main menu

The following steps of adjusting brightness is one example to show how to use the main menu.

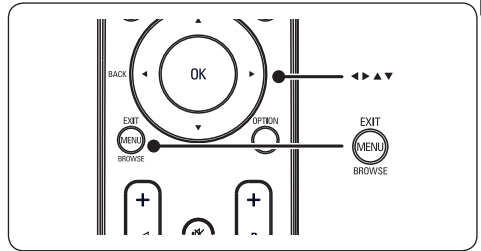

1. Press **MENU** on the remote control to display the TV menu.

| PHILIPS | |
|----------------|----------------|
| TV Menu | Smart settings |
| Smart settings | Personal |
| Picture | Vivid |
| Sound | Standard |
| Features | Movie |
| Install | Power saver |
| | |
| | |

2. Press ▼ to select **Picture**.

| PHILIPS | |
|----------------|-------------------|
| TV Menu | Smart settings |
| Smart settings | Contrast |
| Picture | Brightness |
| Sound | Color |
| Features | Sharpness |
| Install | Tint |
| | Color temperature |
| | Picture format |
| | Noise Reduction |

3. Press ► to enter the **Picture** settings.

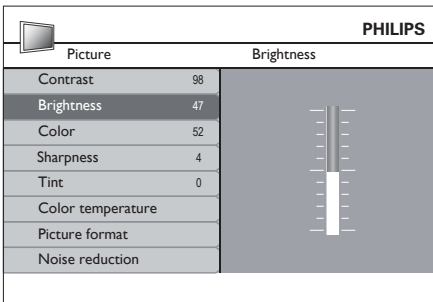

4. Press ▼ to select **Brightness**.

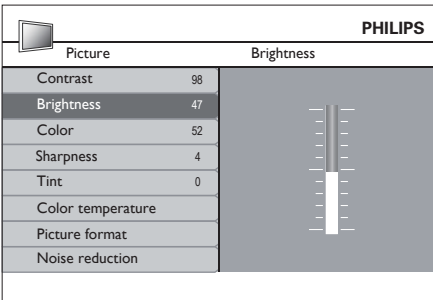

5. Press ► to enter the **Brightness** setting.

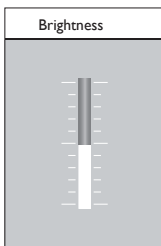

6. Press ▲ or ▼ to adjust the setting.

7. Press ◀ to return to the **Picture** settings or press **MENU** to exit.

Note

More choices are available when digital channels are installed and broadcast.

Use the Quick access menu

The **Quick access** menu gives direct access to some often-needed menu items.

Note

When digital channels are installed and broadcasted, the relevant digital options are displayed in the **Quick access** menu.

1. Press **OPTION** on the remote control.

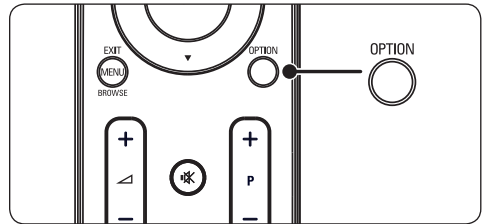

2. Press ▲ or ▼ to select an option.

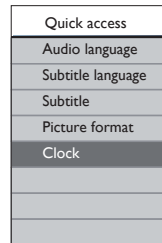

3. Press **OK** to display the selected option menu.

4. Press ▲, ▼, ►, ◀ to adjust the settings in the menu.

5. Press **OPTION** to exit **Quick access** menu, or press **MENU** to exit the **Main** menu.

5.3 Adjust picture and sound settings

Adjust picture settings

1. Press **MENU** on the remote control and select **Picture**.

| PHILIPS | |
|----------------|-------------------|
| TV Menu | Smart settings |
| Smart settings | Contrast |
| Picture | Brightness |
| Sound | Color |
| Features | Sharpness |
| Install | Tint |
| | Color temperature |
| | Picture format |
| | Noise Reduction |

2. Press **▶** to enter the list.
3. Press **▲** or **▼** to select a setting:
 - **Contrast:** Changes the level of bright parts in the picture keeping the dark parts unchanged.
 - **Brightness:** Changes the level of light in the picture.
 - **Colour:** Changes the level of saturation.
 - **Sharpness:** Changes the level of sharpness of fine details.
 - **Tint:** Changes the colours to reddish or bluish.
 - **Colour temperature:** There are 3 items can be selected. Press **▶** to enter the select menu. Press **▲** or **▼** to move to the item. Press **OK** to change to the selected colour temperature: **Normal** (balanced), **Warm** (redder), **Cool** (bluer).
 - **Picture format:** See *Section 5.3.3 Change picture format.*

- **Noise reduction:** Filters and reduces the noise in the picture. Select **ON** to enable or **OFF** to disable this function

Use smart settings

Apart from manually adjusting picture settings, you can use **Smart settings** to set your TV to a predefined picture and sound setting.

1. Press **MENU** on the remote control and select **Smart settings**.
2. Press **▶** to enter the list.
3. Press **▲** or **▼** to select one of the following settings:
 - **Personal:** Applies manually selected picture and sound settings.
 - **Vivid:** Applies brilliant picture and sound settings suitable for bright surroundings
 - **Standard:** Applies natural picture and sound settings suitable for most living room conditions.
 - **Movie:** Applies dynamic picture and sound settings suitable for a complete cinematic experience.
 - **Power saver:** Applies lower picture brightness and smaller sound for power economy.
4. Press **OK** to store your selection.

Change picture format

Change the picture format to suit your content.

1. Press **[PICTURE FORMAT]** on your remote control. Alternatively, press **MENU** and select **Picture > Picture format**.

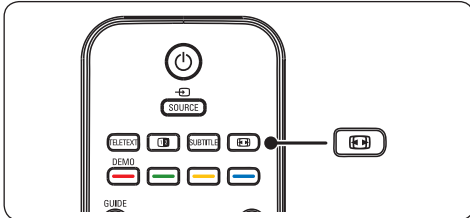

2. Press **▲** or **▼** to select one of the following picture formats:

- **Super zoom (Not for HD)**

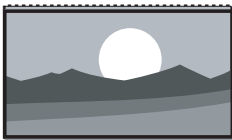

Removes the black bars on the side of 4:3 broadcasts with minimal distortion.

- **4:3 (Not for HD)**



Displays the classic 4:3 format.

- **Note**

Constant use of the **4:3** picture format can cause screen distortion.

- **Movie expand 14:9 (Not for HD)**

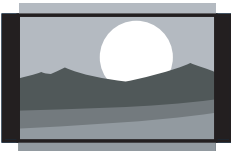

Scales the classic 4:3 format to 14:9.

- **Movie Expand 16:9 (Not for HD)**

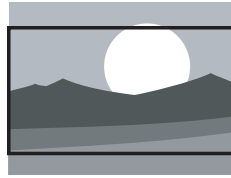

Scales the classic 4:3 format to 16:9.

- **Note**

Constant use of the **16:9** picture format can cause screen distortion.

- **Wide screen**

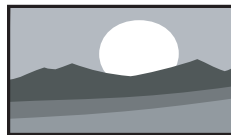

Stretches the classic 4:3 format to 16:9.

- **Subtitle Zoom**

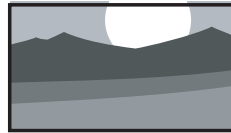

Scales the classic 4:3 format to 16:9 and capable to move up and down by press **▲** or **▼** keys to show subtitle.

Adjust sound settings

This section describes how to adjust sound settings.

1. Press **MENU** on the remote control and select **Sound**.
2. Press ► to enter the list.

| PHILIPS | |
|----------------|----------------------------|
| TV settings | Sound |
| Smart settings | Settings |
| Picture | Incredible surround |
| Sound | Volume - visually impaired |
| Features | Audio language |
| Install | Dual I-II |
| | Mono/Stereo |
| | Auto volume leveling |

3. Press ▲ or ▼ to select one of the following settings:

- **Settings:**
 - Treble:**To adjust the treble value to fit your best listening.
 - Bass:**To adjust the bass value to fit your best.
 - Balance:** Sets the balance of the left and right speakers to best fit your listening position.
- **Incredible surround:** Automatically switches the TV to the best surround sound mode available from a broadcast. Select **On** or **Off**.
- **Volume-visually impaired:** Adjusts the aids on volume settings.
- **Audio language:** Available for digital channels only, when multiple languages are broadcast. Lists available audio languages.
- **Dual I-II:** If available, choose between two different languages.

- **Mono/Stereo:** If stereo broadcasting is available, choose between mono or stereo.
- **Auto volume leveling:** Reduces sudden volume changes, for example, during commercials or when switching from one channel to another. Select **On** or **Off**.

5.4 Change to Shop or Home mode

1. Press **MENU** on the remote control and select **Install > Preferences > Location**.
2. Press ► to enter the **Location** menu.
3. Press ▲ or ▼ to select the TV mode:
 - **Shop:** Sets smart settings to **Vivid**, ideal for a shop environment. The flexibility to change settings is limited.
 - **Home:** Gives home users the full flexibility to change all TV settings.
4. Press **OK** to confirm.
5. Press **MENU** to exit.

5.5 Use advanced teletext features

Your TV has a 100 page memory that stores broadcasted teletext pages and subpages.

Select teletext subpages

A teletext page can hold several subpages. Subpages are displayed on a bar next to the main page number.

1. Press **TELETEXT** on the remote control.
2. Select a teletext page.
3. Press ▲ or ▼ to select a subpage.

Use dual screen teletext

Enabling dual screen teletext displays your channel or source on the left of the screen. Teletext is displayed on the right.

1. Press **12 (DUAL SCREEN)** on your remote control to enable dual screen teletext.
2. Press **12** again to display normal teletext.
3. Press **TELETEXT** to switch off teletext.

⚠ Caution

Digital text services are blocked when subtitles are broadcasted and **Subtitle On** is set in the **Features** menu as described in *Section 5.8 Subtitles*.

5.6 Use Electronic Programme Guide

EPG is an on-screen guide that displays scheduled digital TV programmes. This guide is not available with analogue channels. You can navigate, select and view programmes.

There are two types of EPG, **'Now and Next'** and **'7 or 8 day'** EPG. **'Now and Next'** is always available but the **'7 or 8 day'** EPG is only available in certain countries.

With the EPG menu you can:

- View a list of currently broadcast digital programmes.
- View upcoming programmes.
- Group programmes.

Switch on EPG

ⓘ Note

The first time you use EPG, you may be prompted to perform an update. If so, follow the on-screen instructions.

1. Press **GUIDE** on the remote control, the "Now and Next" EPG will appear and the detailed information about the current programme is displayed.

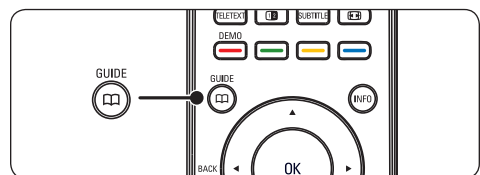

- Use the colour keys on the remote control to activate available actions.

| PHILIPS | | | |
|--------------------------|---------------|---------------------------------------|-------------------|
| Viewing Date: 01/03/2002 | | Current Time: 01/03/2002 Thu 16:49:22 | |
| 2 | BBC TWO | 16:30 | Ready Steady Cook |
| 7 | BBC CHOICE | 17:15 | The Weakest Link |
| 10 | BBCi | | |
| 11 | BBC NEWS 24 | | |
| 12 | BBC PARLMNT | | |
| 13 | BBC Knowledge | | |
| 800 | Eurosport | | |
| 801 | TERRA NOVA | | |
| 16:30 - 17:15 | | | |
| <input type="radio"/> | Prev Day | <input type="radio"/> | Next Day |
| <input type="radio"/> | Detail | <input type="radio"/> | Filter |

- Use the colour keys to view 7 or 8 day EPG.
 - Prev Day (Red):** List the previous day's EPG.
 - Next Day (Green):** List the next day's EPG.
 - Detail (Yellow):** Display the description about this program.
 - Filter (Blue):** Group programs.

| PHILIPS | |
|---|-----------|
| Viewing Date: 01/03/2002 | |
| Current Time: 01/03/2002 Thu 16:49:22 | |
| Take a couple of chefs, Paul Rankin and Phil Vickery, add two contestants, throw in some ingredients and garnish liberally with Ainsley Harriott. Simmer and enjoy. | |
| Test | |
| <input type="radio"/> | Prev Page |
| <input type="radio"/> | Next Page |
| <input type="radio"/> | Return |
| <input type="radio"/> | |

- Press  **GUIDE** to exit the EPG.

5.7 Adjust feature settings

- Press **MENU** on the remote control and select **Features**.
- Press **▶** to enter.

| PHILIPS | |
|-----------------|-------------------|
| TV settings | Features |
| Smart settings | Timer |
| Picture | Auto lock |
| Sound | Subtitle |
| Features | Subtitle language |
| Install | Common interface |
| | |
| | |

- Press **▲** or **▼** to select one of the following settings:
 - Timer**
 - Auto lock**
 - Subtitle**
 - Subtitle language**
 - Common interface**

Use timers

Press **MENU** on the remote control and select **Features > Timer > Clock**.

- Auto clock mode:** You can set current clock by manual or automatic:
 - Manual:** Allows you to enter the current time and day of the week by yourself
 - Automatic**
- Time zone:** Adjusted time is based on GMT.

Automatically switch the TV to standby (Sleeptimer)

Sleeptimer switches the TV to standby after a defined period of time.

1. Press **MENU** on the remote control and select **Features > Timer > Sleeptimer**.
2. Press **▶** to enter the **Sleeptimer** menu
3. Press **▲** or **▼** to set the sleep time up to 180 minutes in steps of five minutes. If set to zero minutes, the Sleeptimer is switched off.
4. Press **OK** to activate the Sleeptimer.

Note

You can always switch off your TV earlier or reset Sleeptimer during the countdown.

Automatically switch the TV on (Start time)

Start time switches the TV to a specified channel at a specified time, from standby.

1. Press **MENU** on the remote control and select **Features > Timer > Start time**.
2. Press **▶** to enter the **start time** menu.
3. Use **▲** or **▼**, **▶** or **◀** to select and enter the menu items to set a channel, day of the week, frequency and starting time.
4. Press **OK** to confirm your choice.
5. Press **MENU** to exit.

Tip

To switch off Start time, select **Off** in the **Start time** menu.

Automatically switch the TV off (Stop time)

Stop time switches the TV to standby at a specified time.

1. Press **MENU** on the remote control and select **Features > Timer > Stop time**.
2. Press **▶** to enter the **Stop time** menu.

3. Use **▲** or **▼**, **▶** or **◀** to select and enter the menu items to set the day of week.
4. Press **OK** to confirm.
5. Press **MENU** to exit.

Note

You can always switch off your TV earlier or reset Sleeptimer during the countdown.

Lock TV channels or connected devices (Auto Lock)

Lock TV channels or connected devices with a four digit code to prevent children from watching unauthorised content.

To set or change the Auto Lock code

1. Press **MENU** on the remote control and select **Features > Auto lock > Change code**.
2. Press **▶** to enter the code setup.
3. Enter your code with the number keys. The **Features** menu reappears with a message confirming that your code is created or changed.

Tip

If you forget your code, enter '0711' to override any existing codes.

To enter the Auto Lock menu

1. Press **MENU** on the remote control and select **Features > Auto Lock** and press **▶** to enter your code.
2. Enter your code with the number keys.

To unlock all channels and connected devices

1. In the **Auto Lock** menu, select **Clear all**.
2. Press **OK**.

To lock or unlock one or more channels and connected devices

1. In the **Auto Lock** menu, select **Lock program**.
2. Press **▶** to enter.
3. Press **▲** or **▼** to select **channel lock**.
4. Press **▶** to lock or unlock the channel.

To set parental ratings

Some digital broadcasters rate their programmes according to age. You can set your TV to display only programmes with age ratings higher than your child's.

1. In the **Auto Lock** menu, select **Parental rating**.
2. Press **▶** to enter.
3. Press **▲** or **▼** to select **age rating**.
4. Select the age and Press **OK**.
5. Press **Menu** to exit the menu.

5.8 Use subtitles

You can enable subtitles for each TV channel. Subtitles are broadcast via teletext or DVB-T digital broadcasts. With digital broadcasts, you have the additional option of selecting a preferred subtitle language.

1. Press **MENU** on the remote control and select **Features > Subtitle**.
2. Press **▶** to enter the list.

| PHILIPS | |
|----------------|-------------------|
| TV settings | Features |
| Smart settings | Timer |
| Picture | Auto lock |
| Sound | Subtitle |
| Features | Subtitle language |
| Install | Common interface |
| | |
| | |
| | |

3. Press **▲** or **▼** to select **On** to display subtitles always or **On during mute** to display subtitles only when the sound is muted with the **M/K** key on the remote control.
4. Press **OK** to return to the **Features** menu.

Select a subtitle language on digital TV channels

Note

When you select a subtitle language on a digital TV channel as described below, the preferred subtitle language set in the **Install** menu is temporarily overruled.

1. Press **MENU** on the remote control and select **Features > Subtitle Language**.
2. Press **▶** to enter the list of available languages.
3. Press **▲** or **▼** to select a subtitle language.
4. Press **OK**.

5.9 Listen to digital radio channels

If digital broadcasting is available, digital radio channels are installed automatically during installation. To reorder the digital radio channels, see *Section 6.3 Rearrange the channels*.

1. Press **OK** on the remote control. The **All channels** menu is displayed.
2. Use the number keys to select a radio channel.
3. Press **OK**.

5.10 Update your TV software

Philips continuously tries to improve its products and we strongly recommend that you update the TV software when updates are available. Check www.philips.com/support for availability.

Check your current software version

1. Press **MENU** on the remote control and select **Install** ► **Current software info**.

Update software (digital broadcasts)

If using (DVB-T) digital broadcasts, your TV automatically receives software updates. If you receive a message on-screen prompting you to update your software:

- Select **Now** (recommended) to update the software immediately.
- Select **Later** to be reminded to update the software later.
- Select **Cancel** to exit the update (not recommended).

6 Install channels

The first time you setup your TV, you are prompted to select an appropriate menu language and to perform automatic installation of TV and digital radio channels (if available).

This chapter provides instructions on how to reinstall channels as well as other useful channel installation features.

⊖ Note

Re-installing channels modifies the **All channels** list.

6.1 Automatically install channels

This section describes how to search and store channels automatically. Instructions are for both digital and analogue channels.

| PHILIPS | |
|-----------------------|-----------------------------|
| Installation | Languages |
| Languages | Menu language |
| Country | Preferred audio language |
| Channel install... | Preferred subtitle language |
| Preferences | Hearing impaired |
| Source labels | Audio description |
| Decoder | |
| Current software info | |
| Factory reset | |

Step 1 Select your menu language

1. Press **MENU** on the remote control and select **Install** > **Languages**.
2. Press ► to enter **Menu language**.
3. Press ▲ or ▼ to select your language.
4. Press **OK** to confirm.
5. Press ◀ to return to the **Installation** menu.

In addition to menu language, you can configure the following language settings via the **Languages** menu (digital channels only):

- **Preferred audio language:** Select one of the available audio languages as your preferred audio language. For more information, see *Section 5.3 Adjust sound settings*.
- **Preferred subtitles language:** Select one of the available subtitle languages as your preferred subtitle language. For more information, see *Section 5.8 Select a subtitle language on digital TV channels*.
- **Hearing impaired:** If available, select **On** to display the hearing impaired subtitle with your preferred language.
- **Audio description:** If available, select **On** to hear the audio description with your preferred language.

Step 2 Select your country

Select the country where you are located. The TV installs and arranges channels according to your country.

1. In the **Installation** menu, press ▼ to select **Country**.
2. Press ► to enter the list.
3. Press ▲ or to select your country.
4. Press ◀ to return to the **Installation** menu.

Step 3 Install channels

Your TV searches and stores all available digital and analogue TV channels as well as all available digital radio channels.

1. In the **Installation** menu, press ▲ or ▼ to select **Channel install.** > **Automatic installation.**
2. Press ► to select **Start now.**
3. Press **OK.**
4. Press the green key to start. The installation may take a few minutes.

5. When the channel search is completed, press the red key to return to the **Installation** menu.
6. Press **MENU** to exit.

* Tip

When digital TV channels are found, the list of installed channels may display empty channel numbers. If you want to rename, reorder or uninstall stored channels, see *Section 6.3 Rearrange channels*.

6.2 Manually install channels

This section describes how to search and store analogue TV channels manually. If you want to search and store digital channel, please kindly refer to *Section 6.7. Test digital reception*

Step 1 Select your system

ⓘ Note

Skip to *Step 2 Search and store new TV channels* if your system settings are correct.

1. Press **MENU** on the remote control and select **Install > Channel install.** > **Analogue: Manual installation.**
2. Press ► to enter the **Channel installation** menu, and **System** is highlighted.
3. Press ► to enter the **System** list.

| PHILIPS | |
|-------------------------------|-------------------------------|
| Channel installation | Analogue: Manual installation |
| Automatic installation | System |
| Installation update | Search |
| Digital: Test reception | Fine tune |
| Analogue: Manual installation | Store current channel |
| Rearrange | Store as new channel |
| | |
| | |

4. Press ▲ or ▼ to select your country or region.
5. Press ◀ to return to the **Channel**

installation menu.

Step 2 Search and store new TV channels

1. Press **MENU** on the remote control and select **Install > Channel installation > Analogue: Manual installation > Search**.
2. Press **▶** to enter the **Search** menu.
3. Press the red key and the number keys on the remote control to enter the three digit frequency. Alternatively, press the green key to automatically search for the next channel.
4. Press **◀** when the new channel is found.
5. Select **Store as new channel**, and press **▶** to enter.
6. Press **OK** to save this channel.
The channel number will be shown on the screen.
7. Press **MENU** to exit.

Fine tune analogue channels

You can manually fine tune analogue channels when reception is poor.

1. Press **MENU** on the remote control and select **Install > Channel installation > Analogue: manual installation > Fine tune**.
2. Press **▶** to enter the **Fine tune** menu.
3. Press **▲** or **▼** to adjust the frequency.
4. Press **▲** when done.
5. Select **Store current channel** to store the fine tuned channel under the current channel number.
6. Press **▶** to enter.
7. Press **OK**. **Done** appears.
8. Press **MENU** to exit.

6.3 Rearrange channels

1. Press **MENU** on the remote control and select **Install > Channel installation > Rearrange**.
2. Press **▶** to enter the **Rearrange** list.
3. Press **▲** or **▼** to select the channel you want to rearrange.
4. Press the yellow key to move the channel up the list, or press the blue key to move the channel down the list.
5. Press **MENU** to exit.

6.4 Rename channels

1. Press **MENU** on the remote control and select **Install > Channel installation > Rearrange**.
2. Press **▶** to enter the **Rearrange** list.
3. Press **▲** or **▼** in the **Rearrange** list to select the channel you want to rename.
4. Press the red key.
5. Press **◀** and **▶** to select characters or **▲** and **▼** to change the characters. Space, numbers (0-9) and other special characters are located between **z** and **A**.
6. Press the green key or **OK** to finish.

Tip

Delete all characters by pressing the yellow key. Delete only the highlighted character by pressing the blue key.

6.5 Uninstall or reinstall channels

You can uninstall a stored channel or reinstall an uninstalled channel.

1. Press **MENU** on the remote control and select **Install > Channel installation > Rearrange**.
2. Press **▶** to enter the **Rearrange** list.
3. Press **▲** or **▼** to select the channel you want to uninstall or reinstall.
4. Press the green key to uninstall or reinstall the channel.
5. Press **MENU** to exit.

6.6 Manually update the channel list

You can manually update the channel list.

1. Press **MENU** on the remote control and select **Install > Channel installation > Installation update**.
2. Press **▶** to enter the **Installation update** menu. **Start now** is highlighted.
3. Press **OK**.
4. Press the green key to start the update. This may take a few minutes.
5. When the update is complete, press the red key to return to the **Channel installation** menu.
6. Press **MENU** to exit.

6.7 Test digital reception

If using digital broadcasts, you can check the quality and signal strength of digital channels. This allows you to reposition and test your antenna or satellite dish.

1. Press **MENU** on the remote control and select **Install > Channel installation > Digital: Test reception**.
2. Press **OK**.
3. Press the green key to automatically start the test or manually enter the frequency of the channel you want to test. If the signal quality and strength is poor, reposition the antenna or satellite dish and retest.
4. When complete, press the yellow key to store the frequency.
5. Press the red key to return to the **Channel installation** menu.
6. Press **MENU** to exit.



Note

If you have further problems with the reception of your digital broadcast, contact a specialised installer.

7 Connect devices

7.1 Connection overview

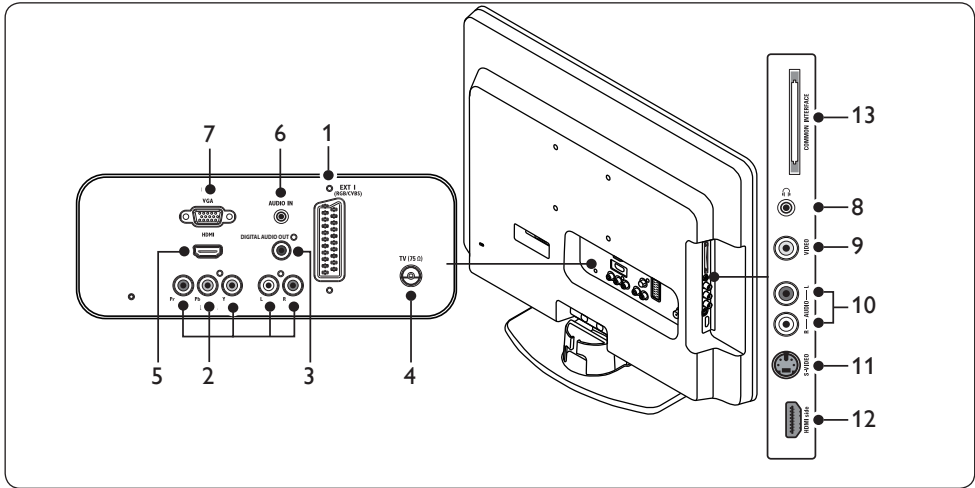

Back connectors

1. **EXT 1:** First SCART connector for DVD players, VCRs, digital receivers, game consoles and other SCART devices. Supports Audio L/R, CVBS in/out, RGB.
2. **EXT 3:** Component video (Y Pb Pr) and Audio L/R input connectors for DVD players, digital receivers, game consoles and other component video devices.
3. **DIGITAL AUDIO OUT**
SPDIF sound output connector for home theatres and other audio systems.
4. **TV ANTENNA**
5. **HDMI:** HDMI input connectors for Blu-ray Disc players, digital receivers, game consoles and other high-definition devices.
6. **AUDIO IN:** Mini-jack connector for PC audio in.
7. **PC IN:** VGA connector for PC in.

Side connectors

8. **Headphones:** Stereo mini-jack.
9. **VIDEO:** Video input cinch connector for composite devices.
10. **AUDIO L/R:** Audio L/R input connectors for composite and S-Video devices.
11. **S-VIDEO:** S-Video input connector for S-Video devices.

Note

Item 9, Item 10, Item 11 these 3 ports all are under **EXT 2**.

12. **HDMI Side:** Additional HDMI connector for mobile high-definition devices.
13. **COMMON INTERFACE:** Slot for Conditional Access Modules.

7.2 Select connection quality

This section describes how you can enhance your audio visual experience by connecting your devices with the best possible connectors.

After connecting your devices, be sure to enable them as described in *Section 7.4 Setup devices*.

HDMI - Highest quality ★★★★★

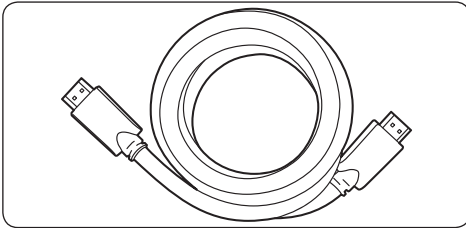

HDMI produces the best audio visual quality possible. Both audio and video signals are combined in one HDMI cable, providing an uncompressed, digital interface between your TV and HDMI devices. You must use HDMI to experience full high-definition video. You must also use HDMI cables to enable Philips EasyLink as described in *Section 7.5 Use Philips EasyLink*.

Note

Philips HDMI supports HDCP (High-bandwidth Digital Contents Protection). HDCP is a form of Digital Rights Management that protects high definition content in DVD or Blu-ray Discs.

Component (Y Pb Pr) - Higher quality ★★★★★

Component (Y Pb Pr) video provides better picture quality than S-Video or composite video connections. Though component video supports high-definition signals, picture quality is lower than HDMI and is analogue.

When connecting a component video cable, match the cable colours to the EXT 3

connectors on the back of the TV. Also, connect a Audio L/R cable to the red and white Audio L/R input connectors at EXT 3.

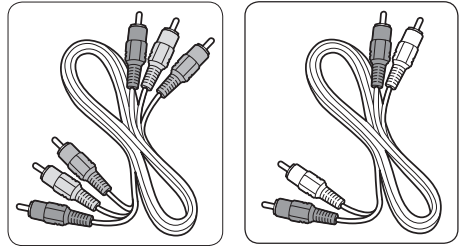

- Component video cable- Red, Green, Blue
- Audio L/R cable - Red, White

SCART - Good quality ★★★

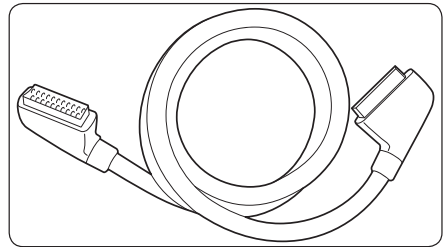

SCART combines audio and video signals in one cable. Audio signals are stereo, while video signals can be composite or S-Video quality. SCART does not support high-definition video and is analogue. One SCART connectors is provided on the TV, EXT 1.

S-Video - Good quality ★★

An analogue connection, S-Video provides better picture quality than composite video. When connecting your device with S-Video, plug the S-Video cable to the S-Video connector on the side of the TV. You must connect a separate Audio L/R cable from the device to the red and white Audio L/R connectors on the side of the TV

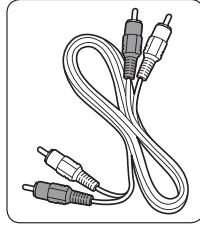
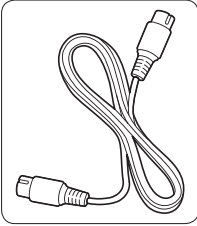

- S-Video cable
- Audio L/R cable - Red, White

Composite - Basic quality ★

Composite video provides basic analogue connectivity, usually combining a (yellow) video cinch cable with (red and white) Audio L/R cinch cable. Match the cable colours when connecting to the composite Video and Audio L/R input connectors on the side of the TV. Composite audio/video cable - Yellow, red and white

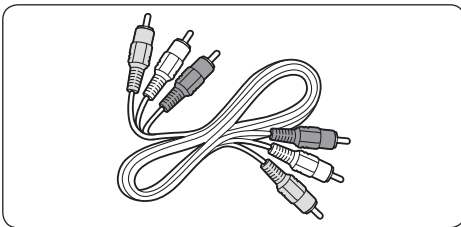

7.3 Connect devices

This section describes how to connect various devices with different connectors and supplements examples provided in the *Quick Start Guide*.

⚠ Caution

Disconnect the mains cord before connecting devices.

📌 Note

Different types of connectors may be used to connect a device to your TV, depending on availability and your needs.

Blu-ray Disc player

For full high-definition video, connect a HDMI cable as illustrated:

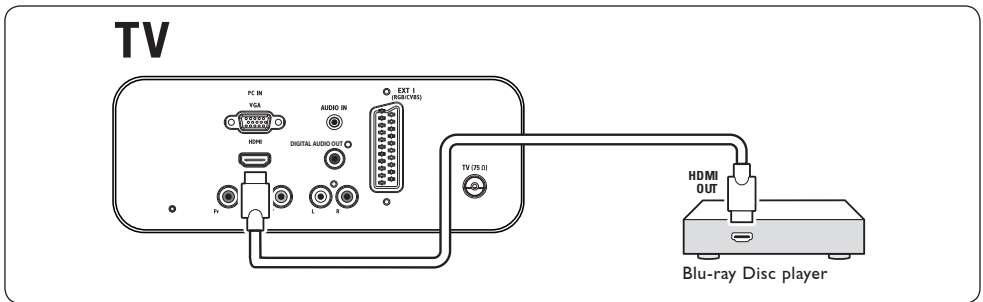

DVD player

For DVD video, connect a SCART cable as illustrated:

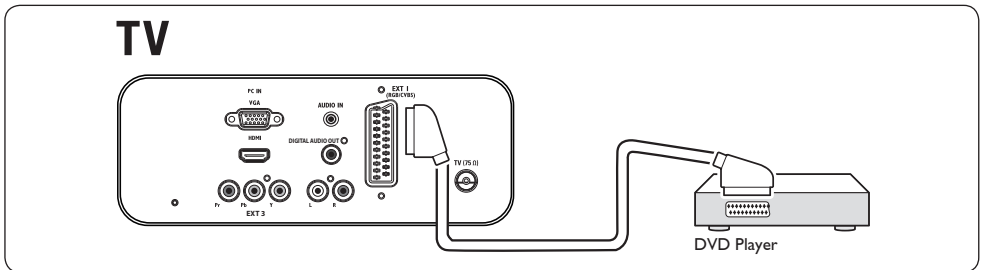

Satellite receiver

To receive analogue channels via antenna and digital channels via a satellite receiver, connect an antenna cable and SCART cable as illustrated:

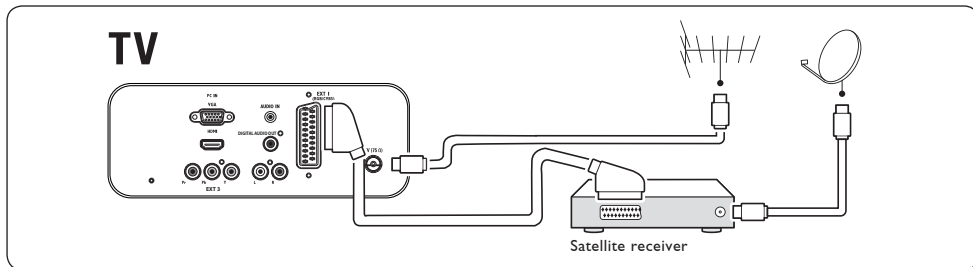

HD digital receiver

To receive analogue channels via antenna and digital channels via a HD digital receiver, connect two antenna cables and HDMI cable as illustrated:

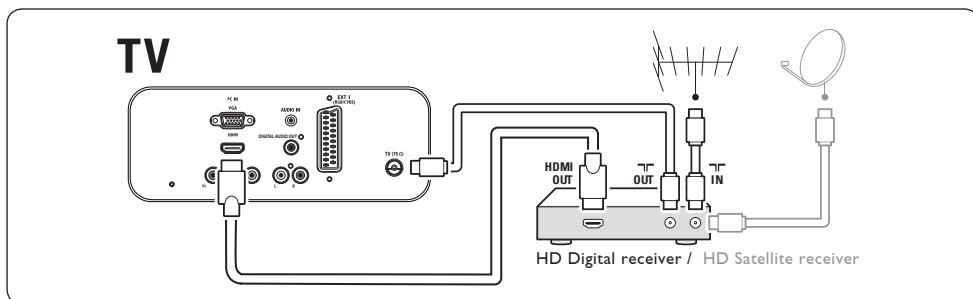

Combined DVD recorder and digital receiver

To receive analogue channels via antenna and record programs on a combined DVD recorder and digital receiver, connect two antenna cables and one SCART cable as illustrated:

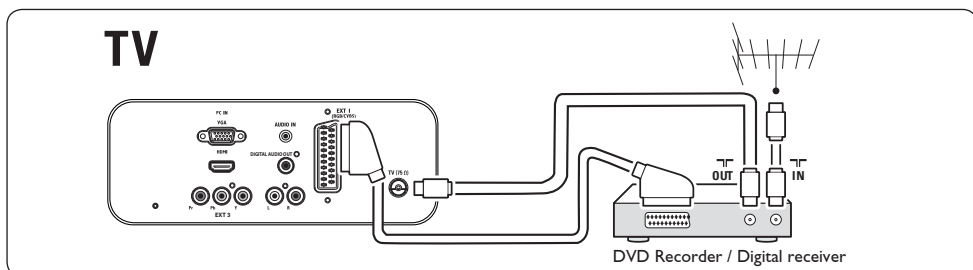

Separate DVD recorder and receiver

To receive analogue channels via antenna and record programmes on a separate DVD recorder and receiver, connect three antenna cables and one SCART cables as illustrated:

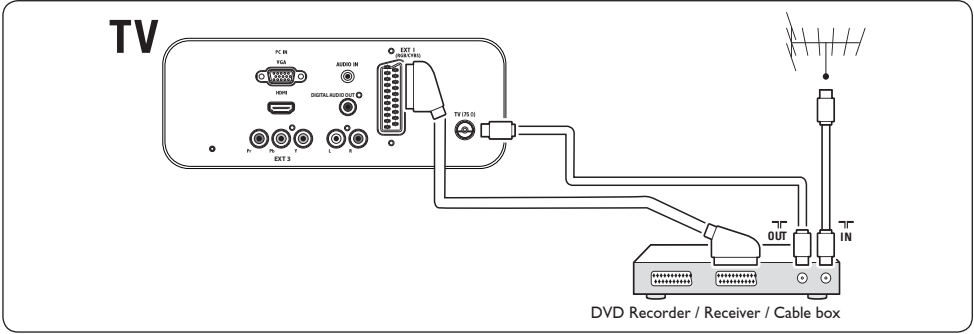

DVD recorder and home theatre system

To receive analogue channels via antenna, output sound to a home theatre system and record programmes on a DVD recorder, connect two antenna cables, one SCART cable and two digital audio cables as illustrated:

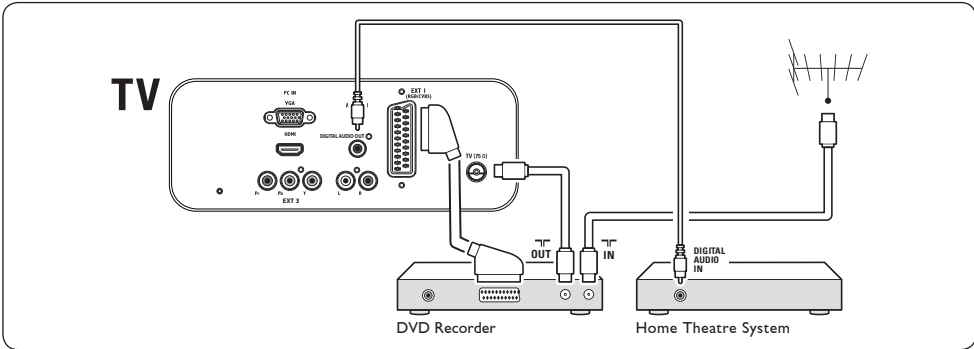

Note

If using a home theatre or other audio system, the best synchronisation between images and sound is achieved by connecting the audio signal from your playback device to the TV first. Subsequently, channel the audio signal to the home theatre system or audio device via the audio connectors on the back of the TV.

Game console or camcorder

The most practical connection for a mobile game console or camcorder may be at the side of the TV. You can, for example, connect the game console or camcorder to VIDEO/S-Video and AUDIO L/R connectors at the side of the TV. A HDMI connector is also available for high-definition devices.

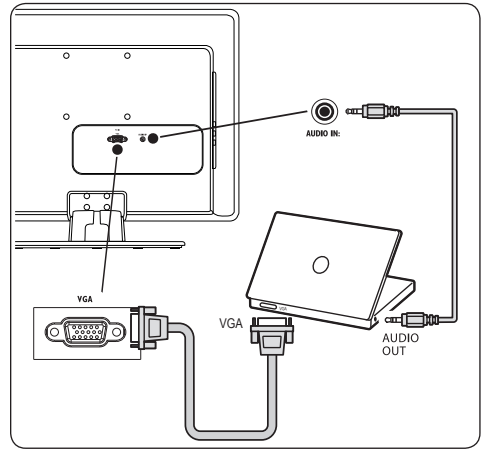
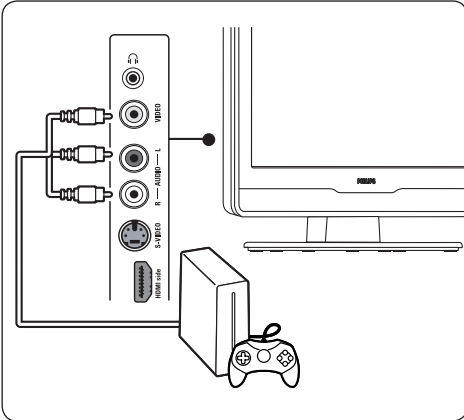

A permanent game console or camcorder can be connected to a HDMI connector or EXT 3 (component) connectors at the back of the TV.

Personal Computer

Before connecting the PC:

- Set the PC monitor refresh rate to 60Hz.
See *Section 8 Technical specifications* for a list of computer resolutions.
- Change the TV picture format to **Wide Screen** as described in *Section 5.3 Change picture format*.

To connect a PC to the back of the TV

1. Using a VGA cable connect to PC IN connect on the back of your TV.
2. Connect a Mini-jack audio cable from your PC to the AUDIO IN mini-jack connector at the back of the TV.

7.4 Setup devices

Assign a channel decoder

Decoders that decode digital channels can be connected to SCART. You have to assign the TV channel as a channel to be decoded. Then assign the connection where the decoder is connected.

1. Press **MENU** on the remote control and select **Install > Decoder**.

| PHILIPS | |
|----------------|----------------|
| TV Menu | Smart settings |
| Smart settings | Personal |
| Picture | Vivid |
| Sound | Standard |
| Features | Movie |
| Install | Power saver |
| | |
| | |

2. Press **▶** to enter the list.
3. Press **▲** or **▼** to select the channel to decode.
4. Press **OK** to select or unselect the channel.
5. Press **◀** to return to the previous menu.
6. Press **MENU** to exit.

7.5 Use Philips EasyLink

Your TV supports Philips EasyLink, which enables one-touch play and one-touch standby between EasyLink-compliant devices. Compliant devices must be connected to your TV via HDMI and assigned as described in *Section 7.4.1 Assign devices to connectors*.

Enable or disable EasyLink

1. Press **MENU** on the remote control then select **Install > Preferences > EasyLink**.
2. Select **On** or **Off**.

Use one-touch play

One-touch play enables you to press the play button on, for example, your DVD remote control. This starts playback on your DVD device and automatically switches your TV to the correct source, displaying DVD content.

Use System standby

System standby enables you to press and hold the **POWER** button on, for example, your TV remote control. This switches your TV and all connected HDMI devices on or to standby mode. You can perform system standby using remote controls from any of the connected HDMI devices.

7.6 Prepare TV for digital services

Scrambled digital TV channels can be decoded with a Conditional Access Module (CAM) and a Smart card provided by a digital TV service operator.

The CAM may enable several digital services, depending on the operator and services you choose (for example, pay TV). Contact your digital TV service operator for more information about services and terms.

Using the Conditional Access Module

⚠ WARNING

Switch off your TV before inserting a CAM. Be sure to follow the instructions described below. Wrong insertion of a CAM may damage both the CAM and your TV.

1. Following the directions printed on the CAM, gently insert the CAM into the Common Interface on the side of the TV.
2. Push the CAM in as far as it will go.

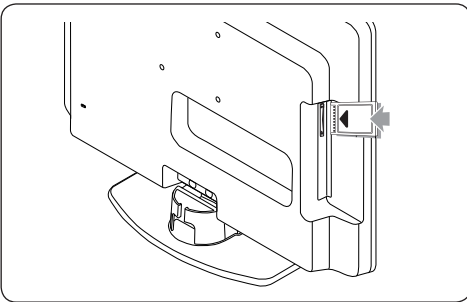

3. Turn on the TV and wait for the CAM to be activated. This may take several minutes.

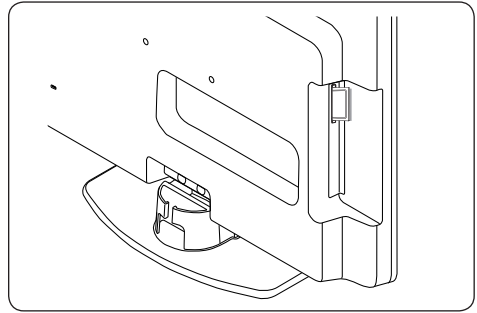

ⓘ Note

Do not remove the CAM from the slot. Removing the CAM will deactivate the digital services.

Access CAM services

- After inserting and activating the CAM, press **MENU** on the remote control and select **TV menu > Features > Common interface**.

This menu option is only available if the CAM is correctly inserted and activated. On-screen applications and content are provided by your digital TV service operator.

8 Technical specifications

Supported display resolutions

- **Computer formats (PC)**

| Resolution | Refresh rate |
|---------------------------|--------------|
| 720 x 400 | 70Hz |
| 640 x 480 | 60Hz |
| 640 x 460 | 67Hz |
| 800 x 600 | 60Hz |
| 1024 x 768 | 60Hz |
| 1440 x 900 | 60Hz |
| 1680 x 1050 (22" only) | 60Hz |
- **Video formats**

| Resolution | Refresh rate |
|------------------|--------------|
| 480i | 60Hz |
| 480p | 60Hz |
| 576i | 50Hz |
| 576p | 50Hz |
| 720p | 50Hz, 60Hz |
| 1080i | 50Hz, 60Hz |
| 1080p(HDMI only) | 50Hz, 60Hz |

Tuner / Reception / Transmission

- Antenna input: 75ohm coaxial (IEC75)
- TV system: DVD COFDM 2K/8K
- Video playback: NTSC, SECAM, PAL
- DVB Terrestrial (see listed countries on the back of the TV)

Remote control

- Type: RC-6
- Batteries: 2 x AAA size (LR03 type)

Connections (Rear)

- EXT 1: (SCART) Audio L/R, CVBS in/out, RGB
- EXT 3: Component (Y Pb Pr), Audio L/R in
- HDMI
- TV ANTENNA
- AUDIO IN: Mini-jack audio in for PC.

- PC IN: PC D-sub 15pins connector
- SPDIF OUT: Digital audio out (coaxial-cinch-S/PDIF). Display synchronised.

Connections (Side)

- Headphone out (stereo mini-jack)
- EXT 2: AUDIO L/R, CVBS in, S-Video in
- HDMI side
- Common Interface (CAM slot)

Power

- Mains power: AC 100-240V ($\pm 10\%$)
- Power and standby power consumption: See technical specifications at www.philips.com
- Ambient temperature: 5°C - 35°C

Specifications are subject to change without notice. For detailed specifications of this product go to www.philips.com/support.

9 Troubleshooting

This section describes commonly-encountered issues and accompanying solutions.

9.1 General TV issues

The TV does not switch on:

- Unplug the mains cord, wait for one minute and plug in the mains again.
- Verify that the mains cord is properly connected and that the mains are powered.

The remote control is not working properly:

- Verify that the remote control batteries are correctly inserted according to the +/- orientation.
- Replace the remote control batteries if they are flat or weak.
- Clean the remote control and TV sensor lens.

You forgot your code to unlock Auto Lock

- Enter '0711' as described in *Section 5.7 Lock TV channels or connected devices (Auto Lock)*.

The TV menu is in the wrong language

- See *Section 6.1 Automatically install channels* for instructions on how to change the TV menu to your preferred language.

When turning the TV on/off/to standby, you hear a creaking sound from the TV chassis:

- No action is required. The creaking sound is normal expansion and contraction of the TV as it cools and warms up. This does not impact performance.

You forgot your code to unlock Auto Lock

- Enter '0711' as described in *Section 5.5 Use advanced teletext features (Auto Lock)*.

9.2 TV channel issues

Previously installed channels do not appear in the channel list:

- Verify that the correct list is selected.
- The channel may have been uninstalled to the **Rearrange** menu. To access the menu, press **MENU** on the remote control and select **Install > Channel installation > Rearrange**.

No digital channels were found during the installation:

- Verify if the TV supports DVB-T in your country. See the listed countries on the back of the TV.

9.3 Picture issues

The power indicator is on, but there is no picture:

- Verify if the antenna is connected properly.
- Verify if the correct device is selected.

There is sound but no picture:

- Verify that picture settings are correctly set. See *Section 5.3 Adjust picture settings*.

You receive poor TV reception from an antenna connection:

- Check that the antenna is properly connected to the TV.
- Loud speakers, unearthed audio devices, neon lights, high buildings or mountains can influence the picture quality. Try to improve the reception quality by changing the antenna direction or moving devices away from the TV.
- Verify if the correct TV system is selected for your region. See *Section 6.2 Manually install channels*.
- If reception on only one channel is poor, try to fine tune this channel. See *Section 6.2 Fine tune analogue channels*.

You receive poor picture quality from connected devices:

- Check that the devices are connected properly.
- Verify that picture settings are correctly set. See *Section 5.3 Adjust picture settings*.

The TV did not save my settings:

- Verify that the TV is set to **Home** mode, which offers you complete flexibility to change settings. See *Section 5.4 Change to Shop or Home mode*.

The picture does not fit the screen, it is too big or too small:

- Try using a different picture format as described in *Section 5.3 Change picture format*.

The picture position on screen is not correct:

- Picture signals from some devices do not fit the screen correctly. Check the signal output of the device.

9.4 Sound issues

There is picture but no sound from the TV:

Note

If no audio signal is detected, the TV automatically switches off audio output and does not indicate malfunction.

- Check that all cables are properly connected.
- Check that the volume is not set to 0.
- Check that the sound is not muted.

There is picture but sound quality is poor:

- Check **Sound** settings as described in *Section 5.3 Adjust sound settings*.

There is picture but sound comes from one speaker only:

- Verify that **Balance** correctly set as described in *Section 5.3 Adjust sound settings*.

9.5 HDMI connection issues

You encounter problems with HDMI devices

- HDCP support can delay the time taken for a TV to display content from a device.
- If the TV does not recognise the device and the screen displays no picture, try switching from one device to another and back again to restart.
- If you experience intermittent sound disruptions, check the user manual of the HDMI device to verify that output settings are correct. Alternatively, try connecting the audio signal from the HDMI device to the TV via AUDIO IN at the back of the TV.

9.6 PC connection issues

The PC display on my TV is not stable or is not synchronised:

- Check that a supported resolution and refresh rate is selected on your PC. See *Section 8 Technical specifications* for supported resolutions and refresh rates.

9.7 Contact us

If you cannot resolve your problem, refer to the FAQ for this TV at www.philips.com/support.

If the problem remains unresolved, contact the Customer Support Centre in your country as listed in this user manual.



WARNING

Do not attempt to repair the TV yourself. This may cause severe injury, irreparable damage to your TV or void your warranty.



Note

Please have available your TV model and serial number before contacting us. These numbers are available on the back and side of your TV, as well as on the packaging.

10 Index

A

Analogue

Channel installation 25

Antenna

Connect 9

Audio language 19

Automatic

Channel installation 24

B

Back connectors 5

Brightness 17

C

Care

Environment 4

Channels

Rename 26

Test digital reception 27

Uninstall 26

Contrast 17

Country

Selection 25

D

Devices

Watch 12

Digital

Radio 24

Services 35

Dual I/II 19

E

Environmental care 4

H

HDCP 28,29

Hearing impaired 25

Home mode 19

I

Install channels 24

K

Kensington lock 7

L

Language

Audio 19

Menus 24

Subtitles 23

M

Mains

Connect 9

Manual channel installation 25

Menus

Auto lock 22

Language 24

Mono sound 19

N

Noise reduction 17

P

Parental rating 23

Picture

Adjust settings

Brightness 17

Colour 17

Contrast 17

Noise reduction 17

Sharpness 17

Position TV 7

Power

Connect 9

R

Radio channels 24

Remote control

Basic use 6

Batteries 10

Rename channels 26

S

Screen care 4

Settings

Picture

Adjust settings 16

Use smart settings 17

Sound

Adjust settings 19

TV location

Change location 19

Setup devices 34

Sharpness 17

Shop mode 19

Side

Connectors 5

Smart settings

Current 17

Movie 17

Standard 17

Vivid 17

Software update

Check version 24

Sound

Adjust settings

Audio language 19

Dual I/II 19

Mono/Stereo 19

Surround mode 19

Stereo sound 19

Subtitles

Language 23

Surround sound

Mode 19

Switch TV

On 10

System selection 25

T

Technical specifications 37

Teletext

Advanced use

Teletext 2.5 20

Timers

Sleeptimer 22

Troubleshooting 37

TV

Auto lock 22

Cable management 10

Channels

Favorite lists 20

Connect

Antenna 9

Mains 9

Connections

Devices 31

Quality 29

Get started 7

Main menus

Use 15

Overview 5

Position 7

Remote control

Basic use 6

Batteries 10

Software update 24

Stand 7

Subtitles 23

Switch

On 10

Timers

Sleeptimer 22

Wall mount 7

Watch

Devices 12

U

Uninstall channels 26

V

VESA-compatible wall bracket 7

Video formats 37

W

Wall mount TV 7

Information about how to re-tune your TV during the digital TV switchover.

Keep this user manual safe – you'll need it.

.....

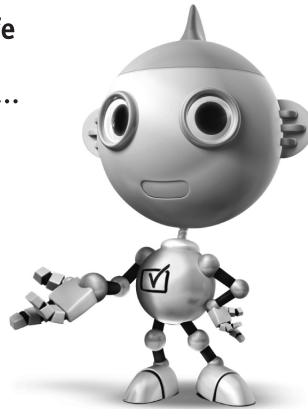

Television in the UK is going digital, bringing us all more choice and new services. Starting in late 2007 and ending in 2012, television services in the UK will go completely digital, TV region by TV region.

Please see the next page to find out when your area switches to digital.

Digital UK is the independent, non-profit organisation leading the process of digital TV switchover in the UK. Digital UK provides impartial information on what people need to do to prepare for the move to digital, and when they need to do it.

How the switchover affects your TV equipment:

Your new TV has a digital tuner built in, which means it is ready to receive the Freeview signal by simply plugging it into your aerial socket (check if you can get digital TV through your aerial now, or whether you'll have to wait until switchover, at www.digitaluk.co.uk).

When the TV switchover happens in your area, there are at least two occasions when you will need to re-tune your TV in order to continue receiving your existing TV channels, and also to pick up new ones.

get set for digital 

Digital UK, the body leading the digital TV switchover, will advise you when you need to re-tune during the switchover. If you choose to connect your TV to satellite or cable with a digital box then it will not be affected by switchover, and you won't need to re-tune.

If you have any questions, please contact your equipment supplier or call Digital UK on ... 0845 6 50 50 50 or visit www.digitaluk.co.uk

How to re-tune:

To find out how to re-tune your TV, check this user manual for details. Go to section **6 Install channels**.

If you do not re-tune your channels when advised to do so by Digital UK, you may lose some or all of your channels until you do re-tune. You should re-tune your TV every few months to check for any new channels.

If you are missing any channels, it may be that they are not available in your area, or that your aerial needs upgrading.

When does switchover happen?

*Copeland switches on October 17, 2007

The exact date you switch depends on the transmitter you are served by. To check when you switch, go to Digital UK's postcode checker on www.digitaluk.co.uk

Check your ITV news service or look at Teletext page 106 to see what TV region you're in.

Visit us at digitaluk.co.uk
Call us on 0845 6 50 50 50†

† Calls charged at BT rate of 3p per minute daytime and 1p per minute evenings and weekends. Rates may vary for calls from non-BT lines.





© 2008 Koninklijke Philips Electronics N.V.
All rights reserved.

Free Manuals Download Website

<http://myh66.com>

<http://usermanuals.us>

<http://www.somanuals.com>

<http://www.4manuals.cc>

<http://www.manual-lib.com>

<http://www.404manual.com>

<http://www.luxmanual.com>

<http://aubethermostatmanual.com>

Golf course search by state

<http://golfingnear.com>

Email search by domain

<http://emailbydomain.com>

Auto manuals search

<http://auto.somanuals.com>

TV manuals search

<http://tv.somanuals.com>