

Register your product and get support at

www.philips.com/welcome



EN USER MANUAL

PHILIPS



Country	Number	Tariff
Austria	0810 000205	€0.07/min
Belgium	078250145	€0.06/min
Bulgaria	+3592 489 99 96	local
Croatia	01 3033 754	local
Czech Rep	800142840	free
Denmark	3525 8759	local
Finland	09 2311 3415	local
France	0821 611655	€0.09/min
Germany	01803 386 852	€0.09/min
Greece	0 0800 3122 1280	free
Hungary	0680018189	free
Ireland	01 601 1777	local
Italy	840320086	€0.08/min
Luxembourg	40 6661 5644	local
Netherlands	0900 8407	€0.10/min
Norway	2270 8111	local
Poland	0223491504	local
Portugal	2 1359 1442	local
Romania	1-203-2060	local
Russia	(495) 961-1111	local
Serbia	+381 114 440 841	local
Slovakia	0800 004537	free
Slovenia	01 280 95 22	local
Spain	902 888 784	€0.10/min
Sweden	08 5792 9100	local
Switzerland	0844 800 544	local
Turkey	0800 261 3302	local
UK	0870 900 9070	local
Ukraine	044 254 2392	local

This information is correct at the time of press. For updated contact information, refer to www.philips.com/support.

Table of contents

1.	Important	3
1.1.	Safety	3
1.2.	Screen care	4
1.3.	Environmental care	4

2.	Your TV	5
2.1.	TV overview	5

3.	Get started	7
3.1.	Position the TV	7
3.2.	Wall mount the TV	7
3.3.	Connect the antenna cable	9
3.4.	Connect the mains cord	9
3.5.	Manage cables	10
3.6.	Insert the remote control batteries	10
3.7.	Switch on the TV	10
3.8.	First time setup	10

4.	Use your TV	11
4.1.	Switch on/off or to standby	11
4.2.	Watch TV	11
4.3.	Watch connected devices	12
4.4.	Use teletext	12

5.	Use more of your TV	13
5.1.	Remote control overview	13
5.2.	Use TV menus	14
5.3.	Adjust picture settings	14
5.4.	Adjust sound settings	15
5.5.	Adjust feature settings	15

6.	Install channels	16
6.1.	Automatically install channels	16
6.2.	Manually store channels	17

7.	Connect devices	18
7.1.	Connection overview	18
7.2.	Select connection quality	19
7.3.	Connect devices	21

8.	Technical specifications	24
----	--------------------------	----

9.	Troubleshooting	25
9.1.	General issues	25
9.2.	Picture issues	25
9.3.	Sound issues	25
9.4.	HDMI connection issues	26
9.5.	PC connection issues	26
9.6.	Contact us	26

10.	Index	27
-----	-------	----

2008 © Koninklijke Philips Electronics N.V. All rights reserved. Specifications are subject to change without notice. Trademarks are the property of Koninklijke Philips Electronics N.V. or their respective owners.

Philips reserves the right to change products at any time without being obliged to adjust earlier supplies accordingly.

The material in this manual is believed adequate for the intended use of the system. If the product, or its individual modules or procedures, are used for purposes other than those specified herein, confirmation of their validity and suitability must be obtained. Philips warrants that the material itself does not infringe any United States patents. No further warranty is expressed or implied.

Warranty

No components are user-serviceable. Do not open or remove covers to the inside of the product. Repairs may only be done by Philips Service Centres and official repair shops. Failure to do so shall void any warranty, stated or implied. Any operation expressly prohibited in this manual, any adjustments, or assembly procedures not recommended or authorised in this manual shall void the warranty.

Pixel characteristics

This LCD product has a high number of colour pixels. Although it has effective pixels of 99,999% or more, black dots or bright points of light (red, green or blue) may appear constantly on the screen. This is a structural property of the display (within common industry standards) and is not a malfunction.

Open source software

This television contains open source software. Philips hereby offers to deliver or make available, upon request, for a charge no more than the cost of physically

performing source distribution, a complete machine-readable copy of the corresponding source code on a medium customarily used for software interchange.

This offer is valid for a period of 3 years after the date of purchase of this product. To obtain the source code, write to

Philips Innovative Applications N.V.
Ass. to the Development Manager
Pathoekeweg 11
B-8000 Brugge
Belgium

Compliance with EMF

Koninklijke Philips Electronics N.V. manufactures and sells many products targeted at consumers, which, like any electronic apparatus, in general have the ability to emit and receive electromagnetic signals.

One of Philips' leading Business Principles is to take all necessary health and safety measures for our products, to comply with all applicable legal requirements and to stay well within the EMF standards applicable at the time of producing the products.

Philips is committed to develop, produce and market products that cause no adverse health effects.

Philips confirms that if its products are handled properly for their intended use, they are safe to use according to scientific evidence available today.

Philips plays an active role in the development of international EMF and safety standards, enabling Philips to anticipate further developments in standardisation for early integration in its products.

Mains fuse (UK only)

This TV is fitted with an approved moulded plug. Should it become necessary to replace the mains fuse, this must be replaced with a fuse of the **same value as indicated** on the plug (example 10A).

1. Remove fuse cover and fuse.
2. The replacement fuse must comply with BS 1362 and have the ASTA approval mark. If the fuse is lost, contact your dealer in order to verify the correct type.
3. Refit the fuse cover.

In order to maintain conformity to the EMC directive, the mains plug on this product must not be detached from the mains cord.

Copyright



VESA, FDMI and the VESA Mounting Compliant logo are trademarks of the Video Electronics Standards Association.

® Kensington and Micro Saver are registered US trademarks of ACCO World Corporation with issued registrations and pending applications in other countries throughout the world. All other registered and unregistered trademarks are the property of their respective owners.

1. Important

Congratulations on your purchase and welcome to Philips!

Read this user manual before you start to use this product.

Pay close attention to this section and follow the safety and screen care instructions. The product warranty does not apply if damage is caused by failing to follow these instructions.

To fully benefit from the support that Philips offers, register your product at www.philips.com/welcome.

The model and serial number of your TV can be found on the back of the TV as well as on the packaging.

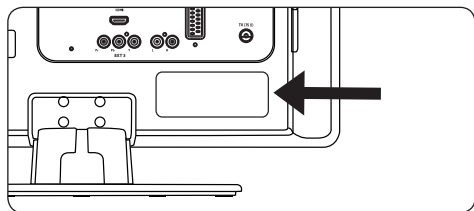

1.1 Safety

- To avoid risk of fire or electric shock, do not place the TV, remote control or remote control batteries near naked flame sources (e.g. lighted candles) and other heat sources including direct sunlight.
- Do not install the TV in a confined space such as a bookcase. Leave a space of at least 10cm (four inches) around the TV for ventilation. Be sure air flow is not obstructed.
- If placing the TV on a flat, solid surface be sure to use only the supplied stand. Do not move the TV if the stand is not properly screwed to the TV.
- Wall mounting of the TV should only be performed by qualified personnel. The TV must only be mounted on an appropriate wall bracket and on a wall that can safely hold the weight of the TV. Improper wall mounting can result in severe injury or damage. Do not attempt to wall mount the TV yourself.
- If the TV is mounted on a swivel base or swivel arm, ensure no strain is placed on the power cord when the TV is swivelled. Strain on the power cord can loosen connections and cause arcing or fire.
- Disconnect the TV from the mains and antenna before lightning storms. During lightning storms do not touch any part of the TV, mains cord or antenna cable.
- Be sure that you have full access to the mains cord for easy disconnection of the TV from the mains.
- Permanent hearing loss can occur if you use earphones or headphones at high volumes. Though high volume may sound normal over time, it can damage your hearing. To protect your hearing, limit the amount of time you use earphones or headphones at high volume.
- When disconnecting the TV from the mains, be sure to:
 - If transporting the TV in low temperatures (less than 5°C), open the box and wait until the TV matches the ambient temperature of the room before unpacking.
 - To avoid short circuit, do not expose the TV, remote control or remote control batteries to rain or water.
 - Do not place vessels of water or other liquids on top of or near the TV. Spilling liquids on the TV can cause electric shock. If liquids are spilt on the TV, do not operate the TV. Immediately disconnect the TV from the mains and have the TV checked by a qualified technician.
 - Do not insert any strange object into the ventilation slot. This might lead to damage of TV.

- Turn off the TV, then the mains power (if available).
- Unplug the mains cord from the mains socket outlet.

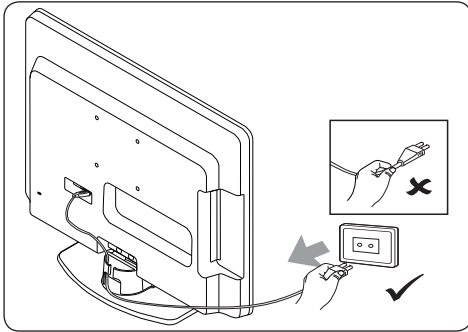

- Unplug the mains cord from the power connector at the back of the TV. Always pull the mains cord by the plug. Do not pull the mains cord

1.2 Screen care

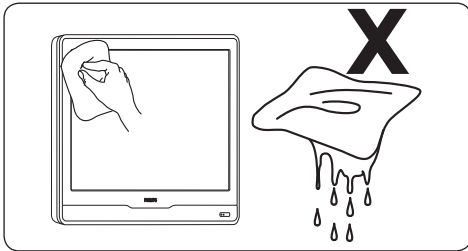

- Turn off and unplug the mains cord before cleaning the screen. Clean the screen with a soft, dry cloth. Do not use substances such as household cleaning agents as these may damage the screen.
- To avoid deformations or colour fading, wipe off water droplets as soon as possible.
- Do not touch, push, rub or strike the screen with hard objects as this may damage the screen permanently.
- Where possible, avoid stationary images that remain on-screen for extended periods

of time. Examples include screen menus, teletext pages, black bars or stock market tickers. If you must use stationary images, reduce the screen contrast and brightness to avoid screen damage.

1.3 Environmental care

Recycling your packaging

The packaging of this product is intended to be recycled. Contact your local authorities for information on how to recycle the packaging.

Disposing your used product



Your product is manufactured with high-quality materials and components that can be recycled and reused. When you see the crossed-out wheel bin symbol attached to a product, it means the product is covered by the European Directive 2002/96/EC:

Do not dispose your used product with household waste. Ask your dealer for information on how to safely dispose of the product. Uncontrolled waste disposal harms both the environment and human health.

Disposing used batteries

The supplied batteries do not contain mercury or cadmium. Dispose supplied and all other used batteries according to your local regulations.

Power consumption

The TV consumes minimal energy in standby mode to minimise environmental impact. Active power consumption is displayed at the back of the TV.

For more product specifications, see the product leaflet at www.philips.com/support.

2. Your TV

This section gives you an overview of commonly-used TV controls and functions.

2.1 TV overview

Side controls

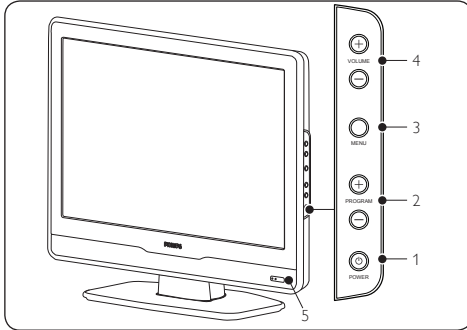

1. **POWER**
2. **PROGRAM +/-**
3. **MENU**
4. **VOLUME +/-**
5. Power indicator/remote control sensor

Side connectors

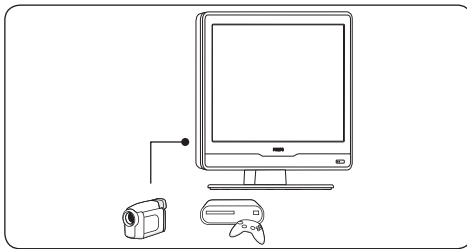

Use the TV side connectors to connect to mobile devices such as a high-definition camcorder or game console. You can also connect a pair of headphones.

Back connectors.

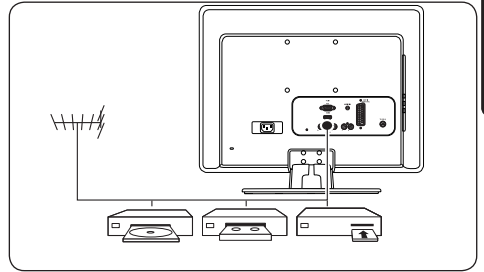

Use the TV back connectors to connect to the antenna and permanent devices such as a high-definition disc player, DVD player or VCR.

 **Note:** For more information about connections, see *Section 7 Connect devices*.

Remote control

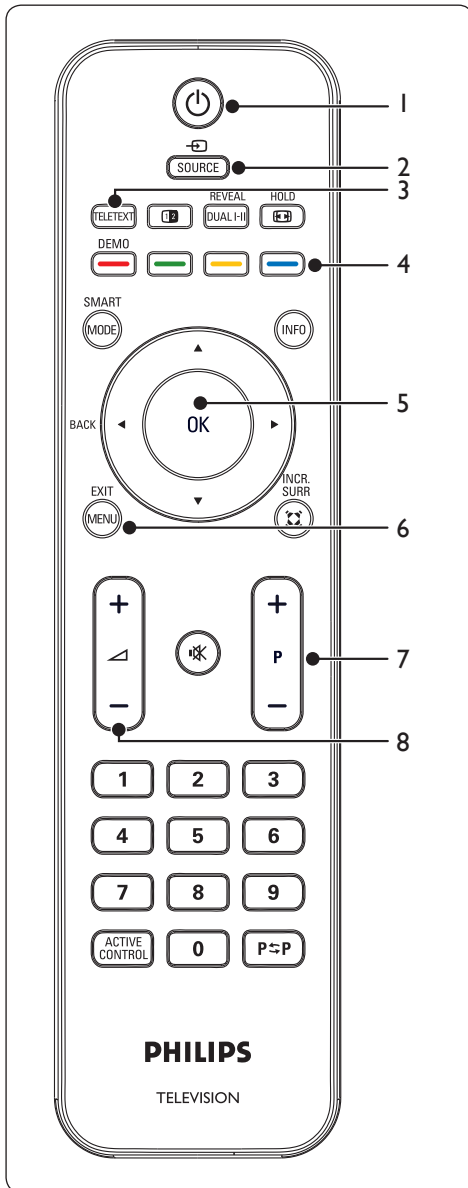

1. Power
2. **SOURCE**
3. **TELETEXT**
4. Colour keys
From left, red, green, yellow, blue
5. Navigation or cursor keys
6. **MENU**
7. **P +/-**
Program up or down
8. +/-
Volume up or down

For more information about the remote control, see *Section 5.1 Remote control overview*.

3. Get started

This section helps you position and install the TV and supplements the information provided in the *Quick Start Guide*.

Note: Refer to the *Quick Start Guide* for stand mounting instructions.

3.1 Position the TV

In addition to reading and understanding the safety instructions in *Section 1.1*, consider the following before positioning your TV:

- The ideal viewing distance for watching TV is three times its screen size.
- Position the TV where light does not fall on the screen.
- Connect your devices before you position your TV.
- Your TV is equipped with a Kensington Security Slot at the back of the TV. If connecting an anti-theft Kensington lock (not supplied), position the TV within reach of a permanent object (such as a table) that can be easily attached to the lock

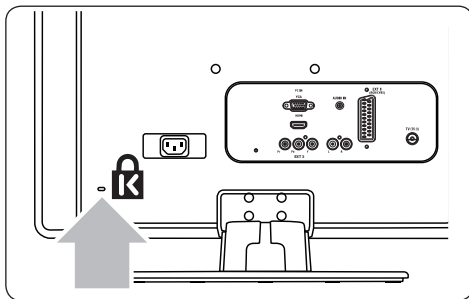

3.2 Wall mount the TV

WARNING: Wall mounting of the TV should only be performed by qualified installers. Koninklijke Philips Electronics N.V. bears no responsibility for improper mounting that results in accident or injury.

Step 1 Purchase a VESA-compatible wall bracket

Depending on the size of your TV screen, purchase one of the following wall brackets:

TV screen size (inches/cm)	VESA-compatible wall bracket type (millimetres)	Special instructions
22"/55.9cm	Fixed 100 x 100	None
19"/48.4cm	Fixed 100 x 100	None

Step 2 Remove the TV stand

Note: If your TV stand is not mounted, skip to *Step 3 Connect cables*.

1. Carefully place the TV face down on a flat, stable surface that is covered by soft cloth. The cloth should be thick enough to protect your screen.

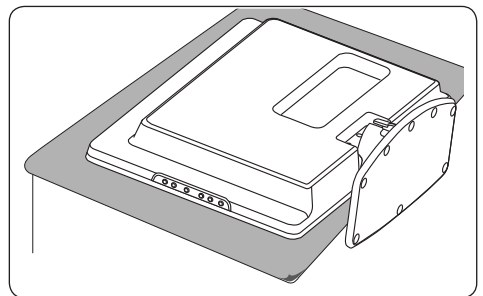

2. Using a cross-head screwdriver (not supplied), unscrew the bolts that secure the stand to the TV. (19" has four bolts, 22" has three bolts).

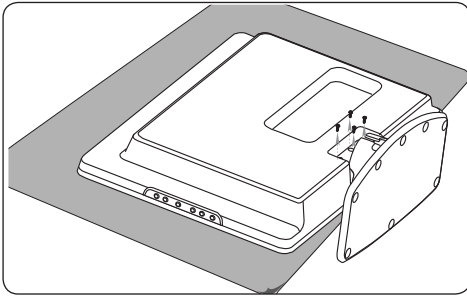

3. Firmly pull the stand from the bottom of the TV. Place both the stand and bolts in a secure location for future reinstallation.

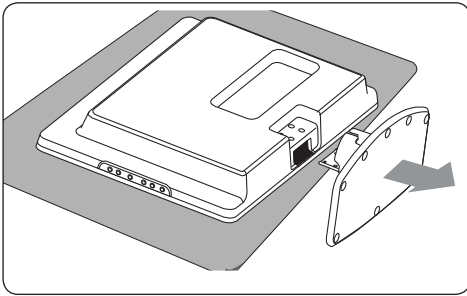

Step 3 Connect cables

Connect the antenna cable, mains cord and all other devices to the back of the TV as described in the following sections.

Step 4

Secure the VESA-compatible wall bracket to the TV

⚠ WARNING: Only use the bolts (M4 for all models) and spacers (4cm) to secure the VESA-compatible wall bracket to your TV. The bolts (not supplied) are designed to match the weight of your TV; spacers (not supplied) are designed for easy cable management.

⊖ Note: Depending on your VESA-compatible wall bracket, you may need to separate the mounting plate from the wall bracket for

easier installation. Refer to your VESA-compatible wall bracket documentation for instructions.

1. Locate the four mounting nuts at the back of the TV.

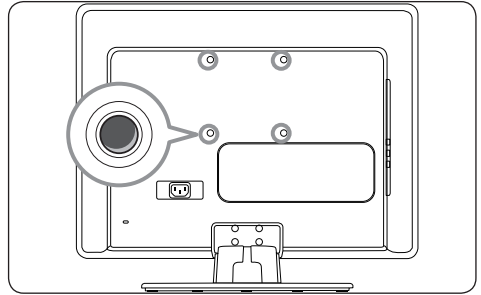

2. Align the plate/bracket to the four mounting nuts, placing the spacers between the plate/bracket and the mounting nuts.
3. Using a spanner, insert the bolts through the plate/bracket and spacers, tightly securing the bolts to the mounting nuts.

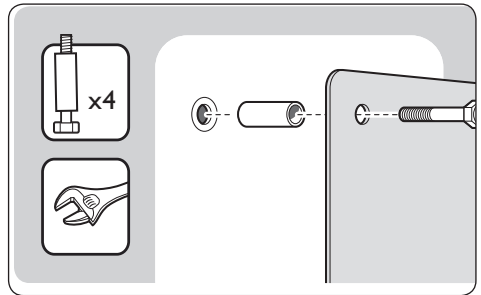

4. Continue with the instructions provided with your VESA-compatible wall bracket.

3.3 Connect the antenna cable

1. Locate the **TV ANTENNA** connector at the back of the TV.
2. Connect one end of an antenna cable (not supplied) to the **TV ANTENNA** connector. Use an adaptor if the antenna cable does not fit.

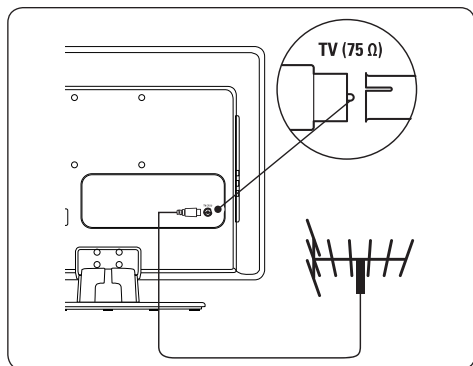

3. Connect the other end of the antenna cable to your antenna outlet, ensuring that the cable is tightly secured at both ends.

3.4 Connect the mains cord

⚠ WARNING: Verify that your mains voltage corresponds with the voltage printed at the back of the TV. Do not insert the mains cord if the voltage is different.

To connect the mains cord

📌 Note

The location of the mains connector varies according to TV model.

1. Locate the **AC IN** mains connector at the back or on the bottom of the TV.

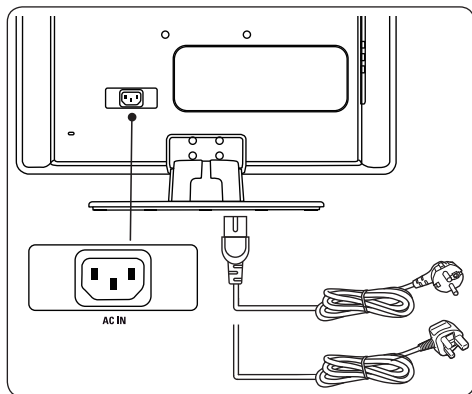

2. Connect the mains cord to the **AC IN** mains connector.
3. Connect the mains cord to the mains, ensuring that the cord is tightly secured at both ends.

3.5 Manage cables

Route your mains cord, antenna cable and all other device cables through the cable holder (1) at the back of the TV.

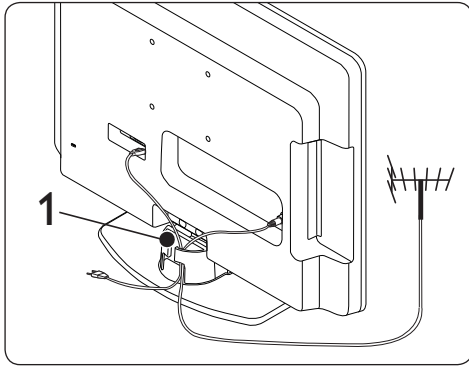

3.6 Insert the remote control batteries

1. Slide the battery cover off the back of the remote control.

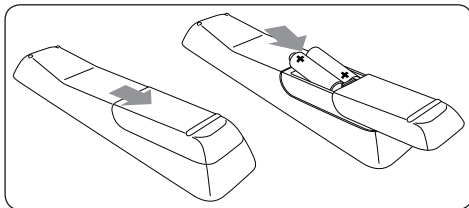

2. Insert the two supplied batteries (Size AAA, Type LR03). Be sure the + and - ends of the batteries line up with the markings inside the case.
3. Slide the cover back into position.

ⓘ **Note:** Remove the batteries if not using the remote control for an extended period of time.

3.7 Switch on the TV

The first time you switch on the TV, check that the mains cord is properly connected. When ready, then press **POWER** on the side of the TV.

ⓘ **Note:** Certain TV models require you to press and hold **POWER** for up to two seconds. Your TV may take up to 15 seconds to start.

3.8 First time setup

When you turn on the TV for the first time, you are prompted to select the **Country** and the menu **Language**.

If the menu is not displayed, press **MENU** to display the menu.

1. Press **▲** and **▼** on the remote control to select your country, and press **OK** to confirm your choice.
2. Press **▲** and **▼** to select a language, and press **OK** to confirm your choice.

The search starts automatically. All available TV programmes and radio stations are stored. This operation takes a few minutes.

If the transmitter or cable network sends an automatic sort signal, the programs are numbered correctly. In this case, the installation is complete. Otherwise, use the **Channel setting** menu to number the programs.

ⓘ **Note:** To exit or interrupt the search, press **MENU**. If no programme is found, consult *Section 9 Troubleshooting*.

4. Use your TV

This section helps you perform basic TV operations. Instructions on advanced TV operations are provided in *Section 5 Use more of your TV*.

4.1 Switch on/off or to standby

Switch on your TV

- If the power indicator (1) is off, press **POWER** on the side of the TV.

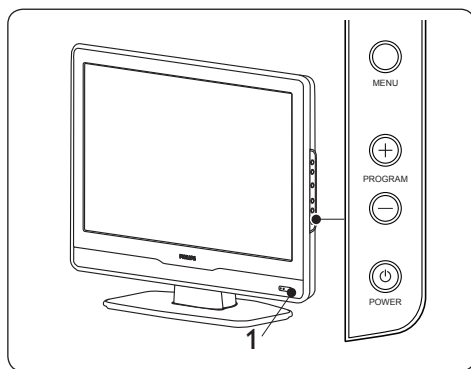

Switch off your TV

- Press **POWER** on the side of the TV. The power indicator (1) switches off.

Switch to standby

- Press  on the remote control. The power indicator switches to standby (red).

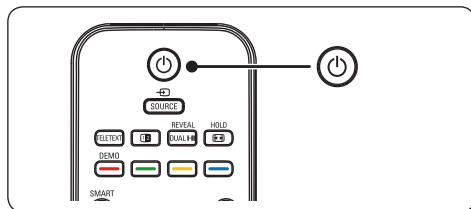



-  **Tip:** Though your TV consumes very little power when in standby, energy continues to

be consumed as long as the mains remain connected and powered. When not in use for extended periods of time, switch off and disconnect the TV from the mains.

Switch on from standby

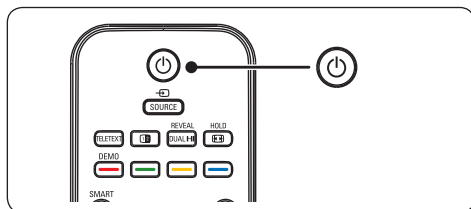
- If the power indicator is in standby (red), press  on the remote control.



-  **Note:** If you cannot locate your remote control and you want to switch on the TV from standby, press **MENU** on the side of the TV.

4.2 Watch TV

Switch channels

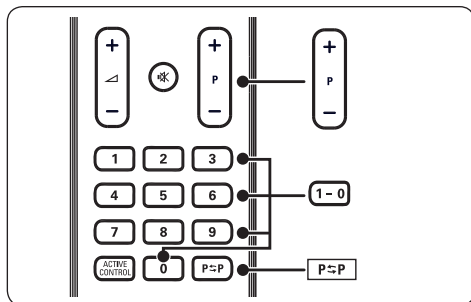

- Press a number (1 to 99) or press **P +/-** on your remote control.
- Press **PROGRAM +/-** on the side controls of the TV.
- Press **P ⇄ P** on the remote control to return to the previously-viewed channel.

Adjust volume

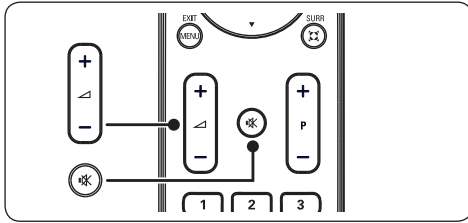

- Press \blacktriangle + or - on the remote control, or press **VOLUME +** or - on the side controls of the TV.
- Press MUTE on the remote control to mute the sound. Press MUTE again to unmute on the sound.

Note: For headphones:

- Press \blacktriangle + or - on the remote control to adjust headphone volume.
- Press MUTE to mute audio from the TV speakers.
- Press \blacktriangle + or - to turn the TV speakers on again.

4.3 Watch connected devices

1. Switch on the device.
2. Press **SOURCE** on the remote control.

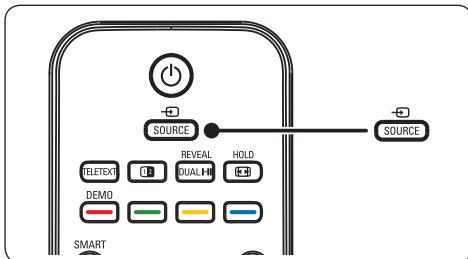

3. Press \blacktriangle or \blacktriangledown to select the connected device.
4. Press **OK** to select the device.

4.4 Use teletext

1. Press **TELETEXT** on the remote control. The main index page appears.

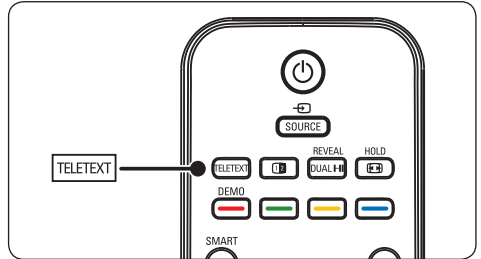

2. Press the number keys to enter a page number.
 3. Press **P +/-** or \blacktriangle / \blacktriangledown to view the next or previous page.
 4. Press a colour key to select one of the colour coded items at the bottom of the screen.
- Tip:** Press **P↔P** to return to the previously viewed page.
5. Press **TELETEXT** again to switch teletext off.

5. Use more of your TV

5.1 Remote control overview

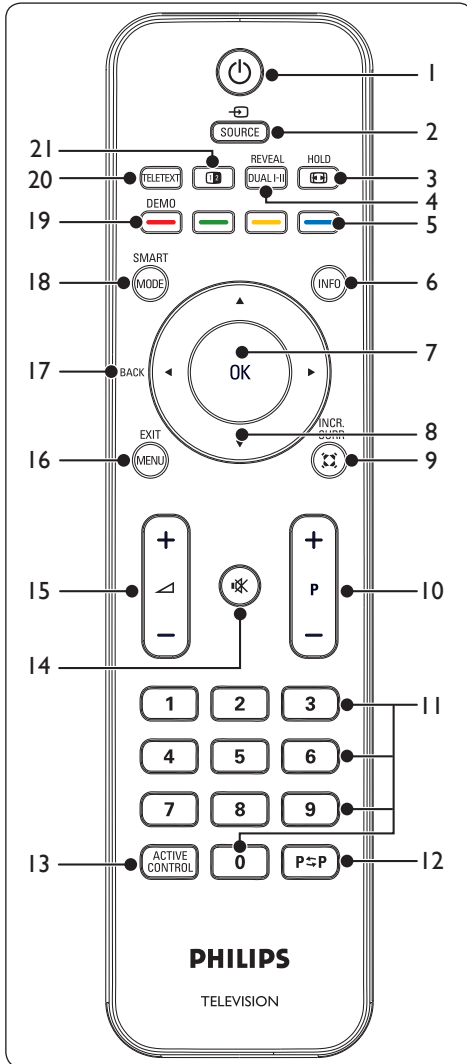

1. Switches on from standby or back to standby.
2. **SOURCE**
Selects connected devices.
3. /HOLD

Selects a picture format or freezes a teletext page.

4. **DUAL I-II/REVEAL**

Press repeatedly to select a sound mode or to toggle between reveal and conceal mode.

5. Colour keys

Select tasks or teletext pages.

6. **INFO**

Displays programme information, if available.

7. **OK**

Accesses the **All channels** menu or activates a setting.

8.

Navigate the menus.

9.

Adds greater depth and dimension to TV sound. Select from **On** or **Off**.

10. **P +/-**

Switches to the next or previous channel.

11. Number keys

Selects a channel, page or setting.

12. **P=P**

Returns to the previously-viewed channel.

13. **ACTIVE CONTROL:** Not supported.

14.

Mutes or restores sound.

15. +/-

Increases or decreases volume.

16. **MENU/EXIT**

Toggles the menu on or off.

17. **BACK**

18. **SMART MODE**

Press repeatedly to select Personal, Vivid, Standard, Movie, or Power saver.

19. **DEMO:** Not supported.

20. **TELETEXT**

Toggles teletext on or off.

21. Dual screen -Not Supported.

5.2 Use TV menus

On-screen menus help you install your TV, adjust picture and sound settings and access other features. This section describes how to navigate the menus.

Access the main menu

1. Press **MENU** on the remote control to display the main menu.

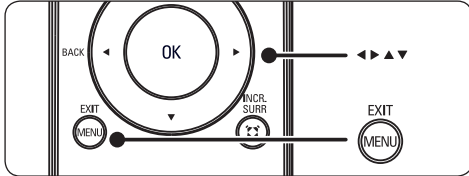

The following menu appears:

Main Control	4	Picture	8
Picture		Smart picture	
Sound		Contrast	
Features		Brightness	
Install		Colour	
		Sharpness	
		Tint	
		Color temp	
		Picture format	

The picture menu contains the settings that affect the quality of the picture.

2. Press **MENU** to exit.

5.3 Adjust picture settings

1. Press **MENU** on the remote control and select **Picture**.

The **Picture** menu is displayed.

2. Press **▶** to select a setting and press **▲** or **▼** to adjust the setting.
3. Press **MENU** to exit.

Main Control	4	Picture	8
Picture		Smart picture	
Sound		Contrast	
Features		Brightness	
Install		Colour	
		Sharpness	
		Tint	
		Color temp	
		Picture format	

The picture menu contains the settings that affect the quality of the picture.

Description of picture settings:

- **Smart picture:** choose from **Personal, Vivid, Standard, Movie, or Power saver.**
- **Brightness:** change picture brilliance.
- **Contrast:** change the difference between the light and dark tones.
- **Colour:** change colour intensity.
- **Sharpness:** change picture sharpness.
- **Tint:** change picture colour to mix or hue.
- **Colour temp:** change colour rendering.
- **Picture format:** change to match the type of program you are watching.

Change picture format

Change the picture format to suit your content.

1. Press **PICTURE** (Picture format) on the remote control.

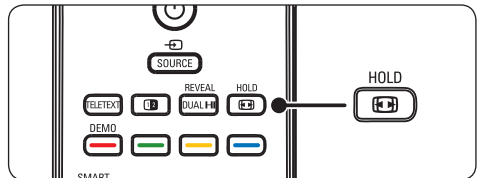

Alternatively, press **MENU** on the remote control and select **Picture ▶ Picture format**.

2. Press **▲** or **▼** to select one of the following picture formats:

- **Super zoom (Not for HD)**

Removes the black bars on the side of 4:3 broadcasts with minimal distortion.



- **4:3 (Not for HD)**

Displays the classic 4:3 format.



- **Movie expand 14:9 (Not for HD)**

Scales the classic 4:3 format to 14:9.



- **Movie expand 16:9 (Not for HD)**

Scales the classic 4:3 format to 16:9.

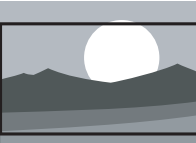

- **Wide screen**

Stretches the classic 4:3 format to 16:9.

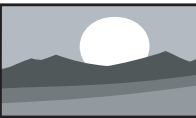

5.4 Adjust sound settings

1. Press **MENU** on the remote control and select **Sound**.

Main Control	4	Sound	4
Picture		Smart sound	
Sound		Settings	
Features		Incredible surround	
Install		AVL	
The sound menu contains the settings that affect the reproduction of the sound.			

2. Press **▲** or **▼** to highlight a setting and press **▶** to select the setting.
3. Press **▲** or **▼** to adjust the setting, and press **OK** to confirm the change.
4. Press **MENU** to exit.

Description of sound settings:

- **Smart sound:** select from **Personal**, **Speech**, **Music**, **Movie** and **Multimedia**. **Personal**.
- **Setting:** change the **Treble**, **Bass**, **Balance**.
- **Incredible surround:** add depth and dimension to sound. Select **On** or **Off**.
- **AVL:** limit increase in sound, especially on program change or advertising slots.

5.5 Adjust feature settings

1. Press **MENU** on the remote control and select **Features**.

Main Control	4	Features	4
Picture		Timer	
Sound		NR	
Features		Auto lock	
Install		Source list	
The features menu gives you control over special, additional functions.			

Timer

- **Clock:** set the time.
- **Start time:** set the time to turn the TV on automatically.
- **Stop time:** set the time to turn the TV off automatically.
- **Sleep timer:** select an automatic standby period, from **0** to **180** minutes.

NR

Attenuates picture noise (snow) in difficult reception conditions.

Auto lock

You can lock channels to prevent your children from watching unsuitable content. **Auto lock** provides the following controls:

- **Lock program:** lock TV channels.
 - **Change code:** change your access code.
 - **Clear all:** unlock all locked channels and programming.
- ✳ **Tip:** If you forget your code, enter '0711' to override any existing codes.

Source list

The following input sources: **TV, EXT 1, EXT 2 S-Video, EXT 2 CVBS, EXT 3, PC IN, HDMI** and **HDMI side**.

1. Press **▲** or **▼** to highlight an option, and press **▶** to select the option.
2. Press **OK** to confirm.
3. Press **MENU** to exit.

6. Install channels

This chapter provides instructions on how to perform a first-time setup and reinstall channels.

ⓘ **Note:** Reinstalling channels modifies the **All channels** list.

6.1 Automatically install channels

Step 1 Select your menu language

1. Press **MENU** on the remote control and select **Install > Languages**.

Main Control	
Install	6 Language 22
Language	
Country	English
Auto store	
Manual store	
Channel setting	
Factory reset	

Press the cursor right to select your menu language.

2. Press **▲** or **▼** to select a language.
3. Press **OK** to confirm.

Step 2 Select your country

The TV installs and arranges channels according to your country.

1. Press **MENU** on the remote control and select **Install > Country**.
2. Press **▲** or **▼** to select the country where you are located.
3. Press **OK** to confirm.

Step 3 Install channels

Your TV searches and stores all available analogue TV channels.

1. Press **MENU** on the remote control and select **Install > Auto store**.
2. Press **▶** to select **Start**.
3. Press **OK** to confirm.
4. When the channel search is complete, press **MENU** to exit.

6.2 Manually store channels

This section describes how to search and store analogue TV channels manually.

Step 1 Manual store

1. Press the **MENU** on the remote control and select **Install > Manual store**.

Main Control	
Install	6 Manual store 5
Language	System
Country	Manual store
Auto store	Prog. no
Manual store	Finetune
Channel setting	Store
Factory reset	

2. Select **System**, and press **▶** to select one of the following systems:
 - **Europe** (automatic detection*)
 - **France** (L/L' standard)
 - **Eastern Europe** (DK standard)
 - **UK** (I standard)
 - **Western Europe** (BG standard)
3. Select **Manual store** and press **▶** to start the store.

When a programme is found, the scanning stops and the program name is displayed (when available). Go to the next step. If you know the frequency of the required programme, you can enter it by pressing the 0 to 9 keys. If no picture is found, consult the possible solutions. See *Section 9. Troubleshooting*.

4. Select **Prog. No.**, and press the number **0** to **9** or **▲** / **▼** to enter the program number.
5. Select **Finetune**, and press **▲** or **▼** to adjust the tuning.
6. Select **Store** and press **▶** to store the program.
7. Repeat the above steps for each program you want to store.
8. Press **MENU** to exit.

Step 2 Channel setting

You can set the name and number for a channel and order the channels.

1. Press the **MENU** the remote control and select **Install > Channel setting**.
2. Press **▲** or **▼** to highlight an option, and press **▶** to select the option.

Main Control	
Install	6 Channel setting 4
Language	Channel edit
Country	Channel swap
Auto store	Name edit
Manual store	Channel sort
Channel setting	
Factory reset	

- **Channel edit:** select a channel for edit.
- **Channel swap:** switch the selected channel to the destination channel.
- **Name edit:** name a channel.
 - Press **◀**, **▶** to move around the name display area.
 - Press **▲**, **▼** to select the characters.
 - Press **▶** to exit. The name is stored.
- **Channel sort:** arrange channels in numeric and alphabetical order.

7. Connect devices

7.1 Connection overview

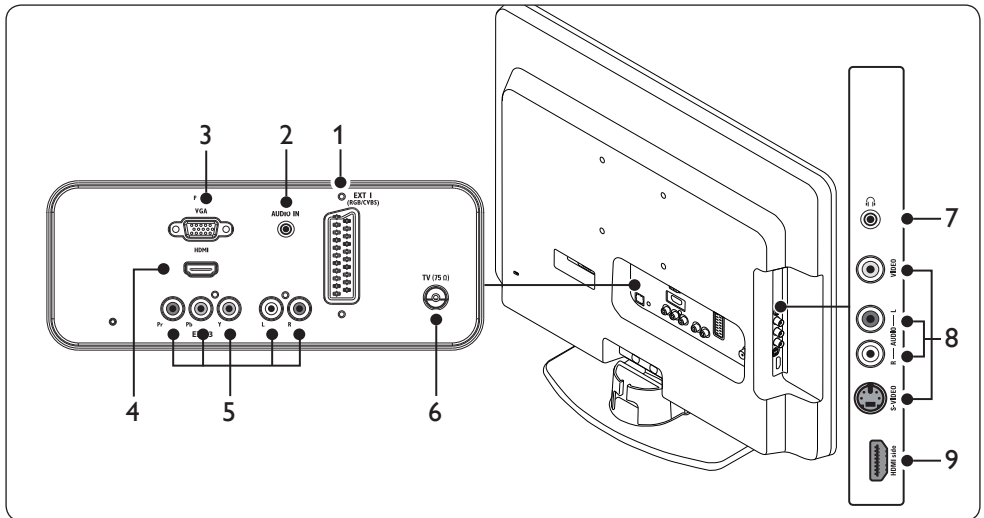

Back connectors

- EXT 1**
SCART connector for DVD players, VCRs, digital receivers, game consoles and other SCART devices. Supports Audio L/R.
- AUDIO IN**
Mini-jack connector for PC audio in.
- PC IN**
VGA connector for PC.
- HDMI**
HDMI input connectors for Blu-ray Disc players, digital receivers, game consoles and other high-definition devices.
- EXT 3**
Component video (Y Pb Pr) and Audio L/R input connectors for DVD players,
- TV ANTENNA**

Side connectors

- Headphones**
Stereo mini-jack.
- EXT 2**
Side CVBS, S-Video and Audio L/R input connectors. Supports composite and S-Video devices.
- HDMI side**
Additional HDMI connector for mobile high-definition devices.

7.2 Select connection quality

This section describes how you can enhance your audio visual experience by connecting your devices with the best possible connectors.

HDMI - Highest quality ★★★★★

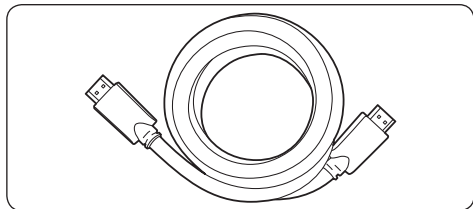

HDMI produces the best audio visual quality possible. Both audio and video signals are combined in one HDMI cable, providing an uncompressed, digital interface between your TV and HDMI devices. You must use HDMI to experience full high-definition video.

Note: Philips HDMI supports HDCP (High-bandwidth Digital Contents Protection). HDCP is a form of Digital Rights Management that protects high definition content in DVD or Blu-ray Discs.

Component (Y Pb Pr) - Higher quality ★★★★★

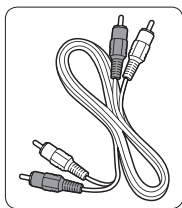
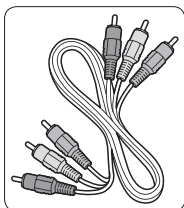

- Component video cable - Red, Green, Blue
- Audio L/R cable - Red, White

Component (Y Pb Pr) video provides better picture quality than S-Video or composite video connections. Though component video supports high-definition signals, picture quality is lower than HDMI and is analogue.

When connecting a component video cable, match the cable colours to the EXT 3 connectors on the back of the TV. Also, connect a Audio L/R cable to the red and white Audio L/R input connectors at EXT 3.

SCART - Good quality ★★★

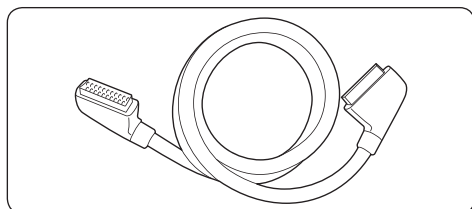

SCART combines audio and video signals in one cable. Audio signals are stereo, while video signals can be composite quality. SCART does not support high-definition video and is analogue. One SCART connector is provided on the TV, EXT 1.

S-Video - Good quality ★★

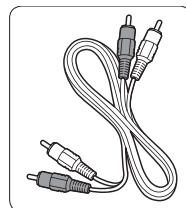
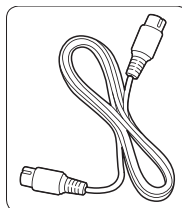

- S-Video cable
- Audio L/R cable - Red, White

An analogue connection, S-Video provides better picture quality than composite video. When connecting your device with S-Video, plug the S-Video cable to the S-Video connector at EXT 2 of the TV. You must connect a separate Audio L/R cable from the device to the red and white Audio L/R connectors at EXT 2 of the TV.

Composite - Basic quality ★

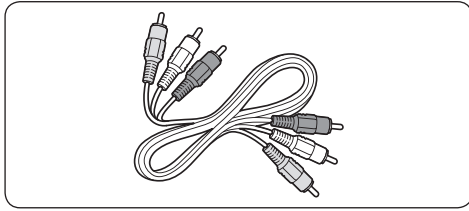

Composite video provides basic analogue connectivity, usually combining a (yellow) video cinch cable with (red and white) Audio L/R cinch cable. Match the cable colours when connecting to the composite Video and Audio L/R input connectors at EXT 2 of the TV. Composite audio/video cable - Yellow, Red and White.

7.3 Connect devices

This section describes how to connect various devices with different connectors. It and supplements examples provided in the *Quick Start Guide*.

⚠ Caution: Disconnect the mains cord before connecting devices.

ⓘ Note: Different types of connectors may be used to connect a device to your TV, depending on availability and your needs.

Blu-ray Disc player

For full high-definition video, connect a HDMI cable as illustrated:

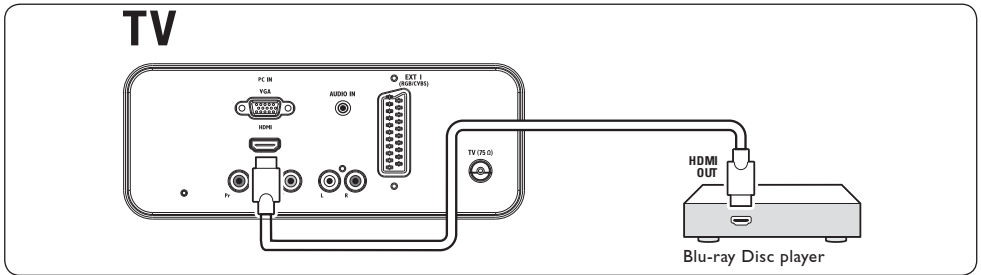

DVD player

For DVD video, connect a SCART cable as illustrated:

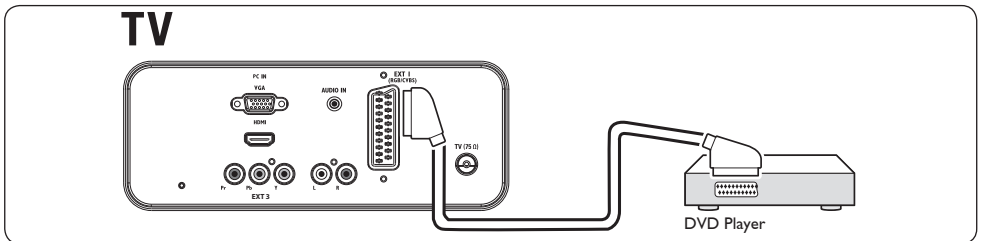

Satellite receiver

To receive analogue channels via antenna and digital channels via a satellite receiver, connect an antenna cable and SCART cable as illustrated:

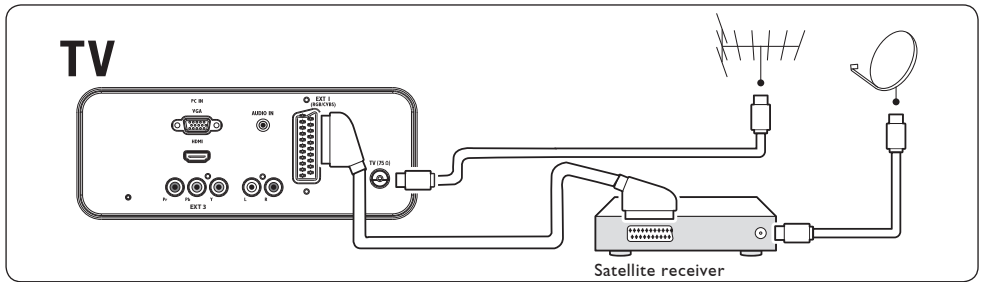

Combined DVD recorder and digital receiver

To receive analogue channels via antenna and record programs on a combined DVD recorder and digital receiver, connect two antenna cables and one SCART cable as illustrated:

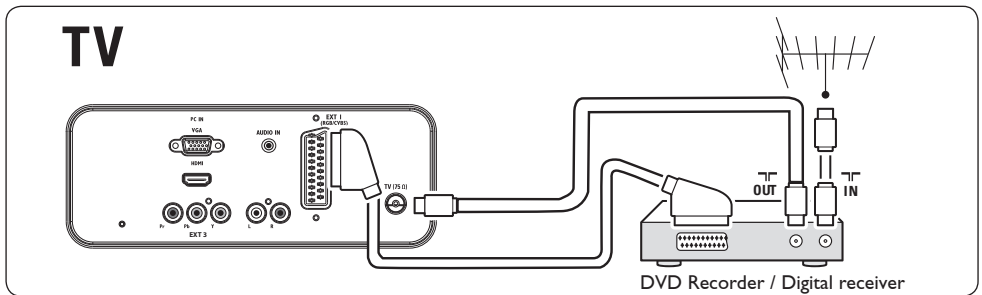

DVD recorder

To receive analogue channels via antenna and record programmes on a DVD recorder, connect two antenna cables and one SCART cable as illustrated:

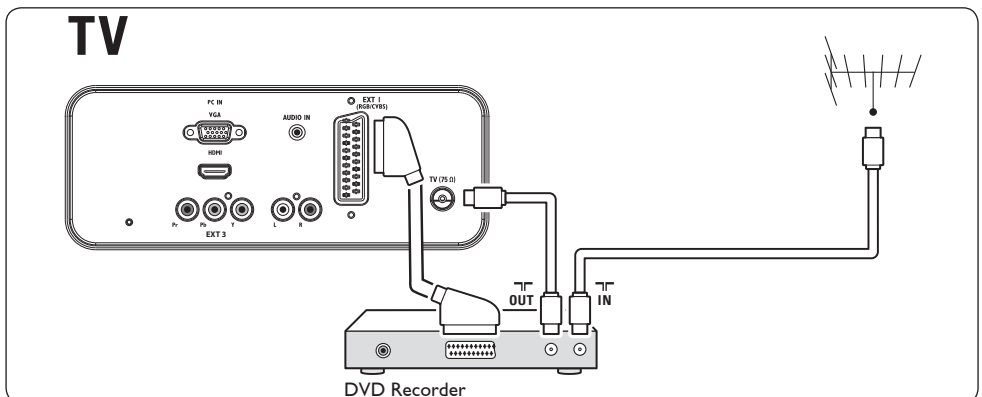

Game console or camcorder

The most practical connection for a mobile game console or camcorder may be at the side of the TV. You can, for example, connect the game console or camcorder to VIDEO/S-Video and AUDIO L/R connectors at the side of the TV. A HDMI connector is also available for high-definition devices.

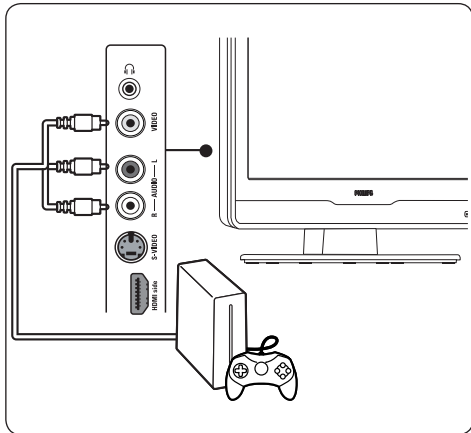

A permanent game console or camcorder can be connected to a HDMI connector or EXT 3 (component) connectors at the back of the TV.

Personal Computer

Before connecting the PC:

- Set the PC monitor refresh rate to 60Hz.
See *Section 8 Technical specifications* for a list of computer resolutions.
- Change the TV picture format to wide screen as described in *Section 5.3. Adjust picture settings.*

To connect a PC to the back of the TV

1. Use a VGA cable connect to PC IN connect on the back of your TV.
2. Connect a mini-jack audio cable from your PC to the **AUDIO IN** mini-jack connector at the back of the TV.

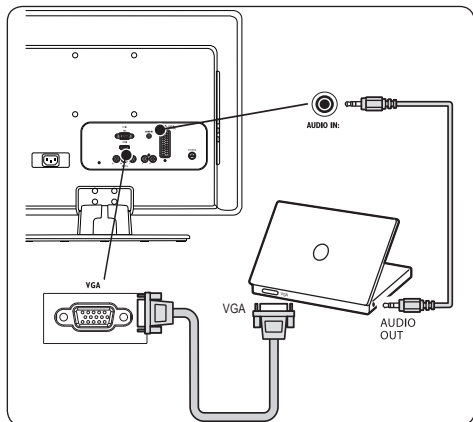

8. Technical specifications

Specifications are subject to change without notice. For detailed specifications of this product go to www.philips.com/support.

Supported display resolutions

• Computer formats

Resolution	Refresh rate
720 x 400	70Hz
640 x 480	60Hz
640 x 480	67Hz
800 x 600	60Hz
1024 x 768	60Hz
1280 x 1024	60Hz
1440 x 900	60Hz
1680 x 1050(22" only)	60Hz

• Video formats

Resolution	Refresh rate
480i	60Hz
480p	60Hz
576i	50Hz
576p	50Hz
720p	50Hz, 60Hz
1080i	50Hz, 60Hz
1080p(HDMI only)	50Hz, 60Hz

Tuner / Reception / Transmission

- Antenna input: 75ohm coaxial (IEC75)
- Video playback: NTSC, SECAM, PAL

Sound

- Sound system:Virtual Surround

Remote control

- Type: RC-5
- Batteries: 2 x AAA size (LR03 type)

Connections (Rear)

- EXT 1 (SCART): Audio L/R, CVBS in/out, RGB
- EXT 3: Component (Y Pb Pr),Audio L/R in

- HDMI
- TV ANTENNA
- AUDIO IN: Mini-jack audio in for PC
- PC IN: PC D-sub 15pins connector

Connections (Side)

- Headphone out (stereo mini-jack)
- EXT 2:AUDIO L/R, CVBS in, S-Video in.
- HDMI side

Power

- Mains power:AC 100-240V ($\pm 10\%$)
- Power and standby power consumption:
See technical specifications at www.philips.com
- Ambient temperature: 5°C - 35°C

9. Troubleshooting

This section describes commonly-encountered issues and accompanying solutions.

9.1 General issues

The TV does not switch on:

- Unplug the mains cord, wait for one minute and plug in the mains again.
- Verify that the mains cord is properly connected and that the mains are powered.

The remote control is not working properly:

- Verify that the remote control batteries are correctly inserted according to the +/- orientation.
- Replace the remote control batteries if they are flat or weak.
- Clean the remote control and TV sensor lens.

The TV menu is in the wrong language:

- See *Section 6.1 Automatically install channels* for instructions on how to change the TV menu to your preferred language.

When turning the TV on/off/to standby, you hear a creaking sound from the TV chassis:

- No action is required. The creaking sound is normal expansion and contraction of the TV as it cools and warms up. This does not impact performance.

You forgot your code to unlock Auto Lock

- Enter '0711' as described in *Section 5.5 Adjust feature settings (Auto Lock)*.

9.2 Picture issues

The power indicator is on, but there is no picture:

- Verify if the antenna is connected properly.
- Verify if the correct device is selected.

There is sound but no picture:

- Verify that picture settings are correctly set. See *Section 5.3 Adjust picture settings*.

You receive poor TV reception from an antenna connection:

- Check that the antenna is properly connected to the TV.
- Loud speakers, unearthed audio devices, neon lights, high buildings or mountains can influence the picture quality. Try to improve the reception quality by changing the antenna direction or moving devices away from the TV.
- Verify if the correct TV system is selected for your region. See *Section 6.2 Manually store channels*.
- If reception on only one channel is poor, try to fine tune this channel. See *Section 6.2 Manually store channels*.

You receive poor picture quality from connected devices:

- Check that the devices are connected properly.
- Verify that picture settings are correctly set. See *Section 5.3 Adjust picture settings*.

The picture does not fit the screen, it is too big or too small:

- Try using a different picture format as described in *Section 5.3. Adjust picture settings*.

The picture position on screen is not correct:

- Picture signals from some devices do not fit the screen correctly. Check the signal output of the device.

9.3 Sound issues

There is picture but no sound from the TV:

- ⊖ **Note:** If no audio signal is detected, the TV automatically switches off audio output and does not indicate malfunction.
- Check that all cables are properly connected.
- Check that the volume is not set to 0.
- Check that the sound is not muted.

There is picture but sound quality is poor:

- Check **Sound** settings as described in *Section 5.4 Adjust sound settings*.

There is picture but sound comes from one speaker only:

- Verify that **Balance** correctly set as described in *Section 5.4 Adjust sound settings*.

9.4 HDMI connection issues

You encounter problems with HDMI devices

- HDCP support can delay the time taken for a TV to display content from a device.
- If the TV does not recognise the device and the screen displays no picture, try switching from one device to another and back again to restart.
- If you experience intermittent sound disruptions, check the user manual of the HDMI device to verify that output settings are correct. Alternatively, try connecting the audio signal from the HDMI device to the TV via AUDIO IN at the back of the TV.
- If a HDMI-to-DVI adaptor or HDMI to DVI cable is used, check that an additional audio cable is connected to AUDIO IN.

9.5 PC connection issues

The PC display on my TV is not stable or is not synchronised:

- Check that a supported resolution and refresh rate is selected on your PC.
See *Section 8 Technical specifications* for supported resolutions and refresh rates.

9.6 Contact us

If you cannot resolve your problem, refer to the FAQ for this TV at www.philips.com/support.

If the problem remains unresolved, contact the Customer Support Centre in your country as listed in this user manual.

⚠ WARNING

Do not attempt to repair the TV yourself. This may cause severe injury, irreparable damage to your TV or void your warranty.

- ⊖ **Note:** Please have available your TV model and serial number before contacting us. These numbers are available on the back and side of your TV, as well as on the packaging.

10. Index

A

Access

the main menu 14

Adjust

features settings 15

Analogue

Channel installation 17

Antenna

Connect 9

Automatic

Channel installation 16

B

Back connectors 5

C

Care

Environment 4

Screen 4

Channels

Change 11

Installation

Automatic 16

Manual 17

Composite 20

Connect

devices 18, 21

Connections

Cable quality

Composite 20

HDMI 19

SCART 19

S-Video 19

Devices

Blu-ray Disc player 21

DVD player 21

PC 23

Connect the antenna cable 9

Country

Selection 16

D

Devices

Watch 12

E

Environmental care 4

G

Get started 7

H

HDCP 19

HDMI cable 19

Home mode 16, 18

I

Install channels 16

K

Kensington lock 7

M

Manage cables 10

Manual channel installation 17

Menus

Main

Access 14

Quick access

Use 15

P

Position TV 7

Power

Connect 9

Q

Quick access menu 15

- R**
 - Recycling product 4
 - Remote control
 - Basic use 6
 - Batteries 10
- S**
 - Safety 3
 - SCART 19
 - Screen care 4
 - Shop mode 16, 18
 - Side
 - Connectors 5
 - Controls 5
 - Sound
 - Settings
 - Adjust settings 15
 - S-Video 19
 - Switch channels
 - channels 11
 - Switch TV
 - On 10
 - On from standby 11
- T**
 - Troubleshooting 24
 - TV
 - Overview 5
 - Position 7
 - Remote control
 - Basic use 6
 - Batteries 10
 - Side controls 5
 - Stand 7
 - Switch
 - On 10
 - On from standby 11
 - Teletext
 - Basic use 12
 - Wall mount 7
 - Watch TV 11
- V**
 - VESA-compatible wall bracket 7
 - Video formats 24
- W**
 - Wall mount the TV 7
- Y**
 - Y Pb Pr 19



© 2008 Koninklijke Philips Electronics N.V.
All rights reserved.

Free Manuals Download Website

<http://myh66.com>

<http://usermanuals.us>

<http://www.somanuals.com>

<http://www.4manuals.cc>

<http://www.manual-lib.com>

<http://www.404manual.com>

<http://www.luxmanual.com>

<http://aubethermostatmanual.com>

Golf course search by state

<http://golfingnear.com>

Email search by domain

<http://emailbydomain.com>

Auto manuals search

<http://auto.somanuals.com>

TV manuals search

<http://tv.somanuals.com>