

Register your product and get support at

[www.philips.com/welcome](http://www.philips.com/welcome)



---

EN USER MANUAL

**PHILIPS**

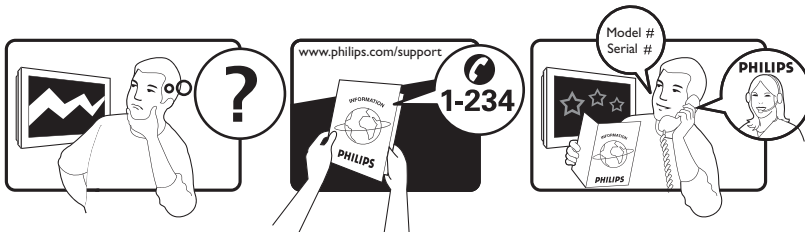

Country	Number	Tariff
Austria	0810 000205	€0.07/min
Belgium	078250145	€0.06/min
Bulgaria	+3592 489 99 96	local
Croatia	01 3033 754	local
Czech Rep	800142840	free
Denmark	3525 8759	local
Finland	09 2311 3415	local
France	0821 611655	€0.09/min
Germany	01803 386 852	€0.09/min
Greece	0 0800 3122 1280	free
Hungary	0680018189	local
Ireland	0800 055 6882	free
Italy	840320086	€0.08/min
Luxembourg	40 6661 5644	local
Netherlands	0900 8407	€0.10/min
Norway	2270 8111	local
Poland	0223491504	local
Portugal	2 1359 1442	local
Romania	1-203-2060	local
Russia	(495) 961-1111	local
Serbia	+381 114 440 841	local
Slovakia	0800 004537	free
Slovenia	01 280 95 22	local
Spain	902 888 784	€0.10/min
Sweden	08 5792 9100	local
Switzerland	0844 800 544	local
Turkey	0800 261 3302	local
UK	0870 900 9070	local
Ukraine	044 254 2392	local

This information is correct at the time of press. For updated contact information, refer to [www.philips.com/support](http://www.philips.com/support).

# Contents

---

<b>1 Notice</b>	2
-----------------	---

---

<b>2 Important</b>	4
Safety	4
Screen care	5
Environmental care	5

---

<b>3 Your TV</b>	6
TV overview	6

---

<b>4 Get started</b>	8
Position the TV	8
Wall mount the TV	8
Connect the antenna cable	9
Connect the mains cord	10
Insert the remote control batteries	10
Switch on the TV	10
First time setup	10

---

<b>5 Use your TV</b>	12
Switch your TV on/off or to standby	12
Watch TV	13
Watch connected devices	14
Use teletext	14
Use Ambilight	14

---

<b>6 Use more of your TV</b>	16
Remote control overview	16
Use TV menus	17
Adjust picture and sound settings	20
Adjust Ambilight settings	24
Adjust LightGuide brightness	25
Change to Shop or Home mode	26
Use advanced teletext features	26
Create favourite lists	28
Use the Electronic Programme Guide	29
Use timers and Child lock	30
Use subtitles	32
View photos and listen to music	33
Listen to digital radio channels	35
Update your TV software	35

---

<b>7 Install channels</b>	37
Automatically install channels	37
Manually install channels	38
Rename channels	39
Uninstall or reinstall channels	39
Rearrange channels	39
Manually update the channel list	39
Test digital reception	40
Start a demo	40
Reset TV to factory settings	40

---

<b>8 Connect devices</b>	41
Connection overview	41
Select connection quality	42
Connect devices	43
Setup devices	46
Use Philips EasyLink	47
Prepare TV for digital services	47

---

<b>9 Technical specifications</b>	49
Product specifications-Supported display resolutions	49
Tuner/Reception/Transmission	49
Multimedia	49
Remote control	49
Connections (Rear)	49
Connections (Side)	49
Power	49

---

<b>10 Troubleshooting</b>	50
General TV issues	50
TV channel issues	50
Sound issues	50
Picture issues	50
HDMI connection issues	51
USB connection issues	51
PC connection issues	51
Contact us	52

# 1 Notice

2008 © Koninklijke Philips Electronics N.V. All rights reserved.

Specifications are subject to change without notice. Trademarks are the property of Koninklijke Philips Electronics N.V. or their respective owners.

Philips reserves the right to change products at any time without being obliged to adjust earlier supplies accordingly.

The material in this manual is believed adequate for the intended use of the system. If the product, or its individual modules or procedures, are used for purposes other than those specified herein, confirmation of their validity and suitability must be obtained. Philips warrants that the material itself does not infringe any United States patents. No further warranty is expressed or implied.

## Warranty

No components are user serviceable. Do not open or remove covers to the inside of the product. Repairs may only be done by Philips Service Centres and official repair shops. Failure to do so shall void any warranty, stated or implied.

Any operation expressly prohibited in this manual, any adjustments, or assembly procedures not recommended or authorised in this manual shall void the warranty.

## Pixel characteristics

This LCD product has a high number of colour pixels. Although it has effective pixels of 99.999% or more, black dots or bright points of light (red, green or blue) may appear constantly on the screen. This is a structural property of the display (within common industry standards) and is not a malfunction.

## Open source software

This television contains open source software. Philips hereby offers to deliver or make available, upon request, for a charge no more than the cost of physically performing source distribution, a complete machine-readable copy

of the corresponding source code on a medium customarily used for software interchange.

This offer is valid for a period of 3 years after the date of purchase of this product. To obtain the source code, write to Philips Consumer Lifestyle Development Manager LoB Mainstream Displays 620A Lorong 1, Toa Payoh Singapore 319762

## Compliance with EMF

Koninklijke Philips Electronics N.V. manufactures and sells many products targeted at consumers which, like any electronic apparatus, in general have the ability to emit and receive electromagnetic signals.

One of Philips' leading Business Principles is to take all necessary health and safety measures for our products, to comply with all applicable legal requirements and to stay well within the EMF standards applicable at the time of producing the products.

Philips is committed to develop, produce and market products that cause no adverse health effects. Philips confirms that if its products are handled properly for their intended use, they are safe to use according to scientific evidence available today.

Philips plays an active role in the development of international EMF and safety standards, enabling Philips to anticipate further developments in standardisation for early integration in its products.

## Mains fuse (UK only)

This TV is fitted with an approved moulded plug. Should it become necessary to replace the mains fuse, this must be replaced with a fuse of the same value as indicated on the plug (example 10A).

- 1 Remove fuse cover and fuse.
- 2 The replacement fuse must comply with BS 1362 and have the ASTA approval mark. If the fuse is lost, contact your dealer in order to verify the correct type.
- 3 Refit the fuse cover.

In order to maintain conformity to the EMC directive, the mains plug on this product must not be detached from the mains cord.

### Copyright



VESA, FDMI and the VESA Mounting Compliant logo are trademarks of the Video Electronics Standards Association.



Manufactured under licence from Dolby Laboratories. 'Dolby', 'Pro Logic' and the double D symbol , are trademarks of Dolby Laboratories.



Manufactured under licence from BBE Sound, Inc. Licensed by BBE, Inc under one or more of the following US patents: 5510752,5736897. BBE and BBE symbol are registered trademarks of BBE Sound Inc.

® Kensington and Micro Saver are registered US trademarks of ACCO World corporation with issued registrations and pending applications in other countries throughout the world.

All other registered and unregistered trademarks are the property of their respective owners.

## 2 Important

Read this user manual before you start to use this product.

Pay close attention to this section and follow the safety and screen care instructions. The product warranty does not apply if damage is caused by failing to follow these instructions. The model and serial number of your TV can be found on the back and side of the TV as well as on the packaging.

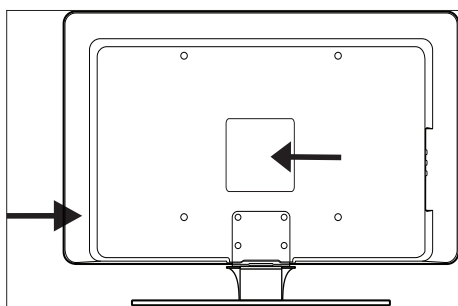

### Safety

- Two people are required to lift and carry an TV that weighs more than 25 kilos (55lb). Improper handling of the TV can result in serious injury.
- If transporting the TV in low temperatures (less than 5°C), open the box and wait until the TV matches the ambient temperature of the room before unpacking.
- To avoid short-circuit, do not expose the TV, remote control or remote control batteries to rain or water.
- To avoid risk of fire or electric shock, do not place the TV, remote control or remote control batteries near naked flame sources (e.g. lighted candles) and other heat sources including direct sunlight.
- Do not install the TV in a confined space such as a bookcase. Leave a space of at least 10cm (four inches) around the TV for ventilation. Be sure the air flow is not obstructed.
- If placing the TV on a flat, solid surface, be sure to use only the supplied stand. Do not move the TV if the stand is not properly screwed to the TV.
- Wall mounting of the TV should only be performed by qualified personnel. The TV must only be mounted on an appropriate wall bracket and on a wall that can safely hold the weight of the TV. Improper wall mounting can result in severe injury or damage. Do not attempt to wall mount the TV yourself.
- If the TV is mounted on a swivel base or swivel arm, ensure no strain is placed on the power cord cable when the TV is swivelled. Strain on the power cord cable can loosen connections and cause arcing or fire.
- Disconnect the TV from the mains and antenna before lightning storms. During lightning storms do not touch any part of the TV, mains cord cable or antenna cable.
- Be sure that you have full access to the mains cord cable for easy disconnection of the TV from the mains.
- When disconnecting the TV from the mains, be sure to:
  - 1 Turn off the TV, then the mains power (if available).
  - 2 Unplug the mains cord cable from the mains socket outlet.
  - 3 Unplug the mains cord cable from the power connector at the back of the TV. Always pull the mains cord cable by the plug. Do not pull the mains cord.

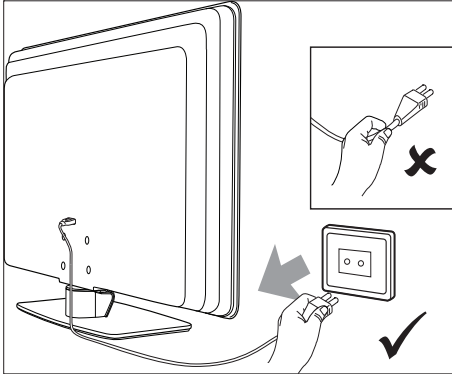

- Permanent hearing loss can occur if you use earphones or headphones at high volumes. Though high volume may sound normal over time, it can damage your hearing. To protect your hearing, limit the amount of time you use earphones or headphones at high volume.

## Screen care

- Turn off and unplug the mains cord cable before cleaning the screen. Clean the screen with a soft, dry cloth. Do not use substances such as household cleaning agents as these may damage the screen.

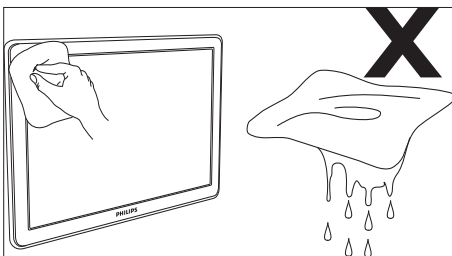

- To avoid deformations or colour fading, wipe off water droplets as soon as possible.
- Do not touch, push, rub or strike the screen with hard objects as this may damage the screen permanently.
- Where possible, avoid stationary images that remain on-screen for extended

periods of time. Examples include screen menus, teletext pages, black bars or stock market tickers. If you must use stationary images, reduce the screen contrast and brightness to avoid screen damage.

## Environmental care

### Recycling your packaging

The packaging of this product is intended to be recycled. Contact your local authorities for information on how to recycle the packaging.

### Disposing of your used product

Your product is manufactured with high-quality materials and components that can be recycled and reused. When you see the crossed-out wheel bin symbol attached to a product, it means the product is covered by the European Directive 2002/96/EC:



Do not dispose your used product with household waste. Ask your dealer for information on how to safely dispose of the product. Uncontrolled waste disposal harms both the environment and human health.

### Disposing of used batteries

The supplied batteries do not contain mercury or cadmium. Dispose supplied and all other used batteries according to your local regulations.

### Power consumption

The TV consumes minimal energy in standby mode to minimize environmental impact. Active power consumption is displayed at the back of the TV. For more product specifications, see the product leaflet at [www.philips.com/support](http://www.philips.com/support).

# 3 Your TV

Congratulations on your purchase, and welcome to Philips! To fully benefit from the support that Philips offers, register your product at [www.Philips.com/welcome](http://www.Philips.com/welcome).

## TV overview

This section gives you an overview of commonly-used TV controls and functions.

### Side controls and indicators

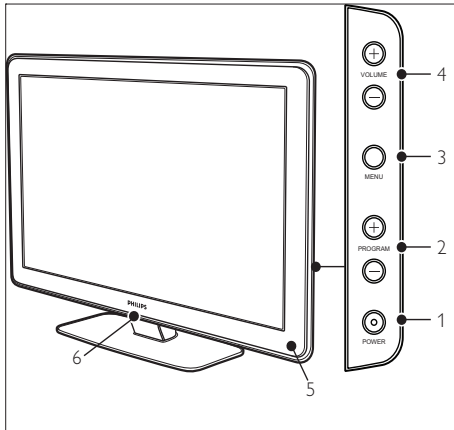

- ① POWER
- ② Program +/-
- ③ MENU
- ④  $\nabla$ Volume +/-
- ⑤ Standby indicator / Remote control sensor
- ⑥ LightGuide

### Side connectors

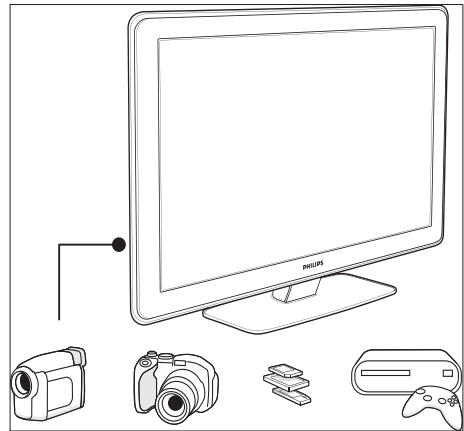

Use the TV side connectors to connect to mobile devices such as a camera or high-definition game console. You can also connect a pair of headphones or a USB memory device.

### Back connectors

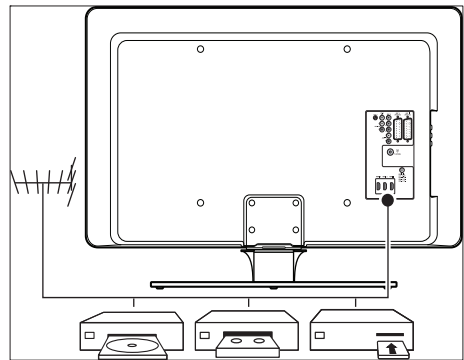

Use the TV back connectors to connect to the antenna and permanent devices such as a high-definition disc player; DVD player or VCR. (see 'Connect devices' on page 41).



## Remote control

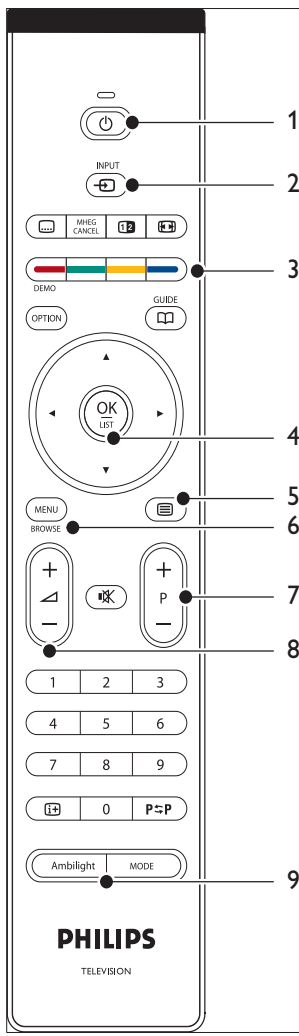

- ① ⏻ Standby
- ② INPUT
- ③ Colour keys  
From left: Red, green, yellow, blue
- ④ Navigation keys  
Up , Down , Left , Right , OK
- ⑤ 📄 Teletext
- ⑥ MENU
- ⑦ Program +/-
- ⑧ 🔊 Volume +/-
- ⑨ AMBILIGHT

# 4 Get started

This section helps you position and install the TV and supplements the information provided in the Quick Start Guide.

### Note

- Refer to the Quick Start Guide for stand mounting instructions.

## Position the TV

In addition to reading and understanding the safety instructions, consider the following before positioning your TV:

- The ideal viewing distance for watching TV is three times its screen size.
- Position the TV where light does not fall on the screen.
- Connect your devices before you position your TV.
- Your TV is equipped with a Kensington Security Slot at on the back of the TV. If connecting an anti-theft Kensington lock (not supplied), position the TV within reach of a permanent object (such as a table) that can be easily attached to the lock.

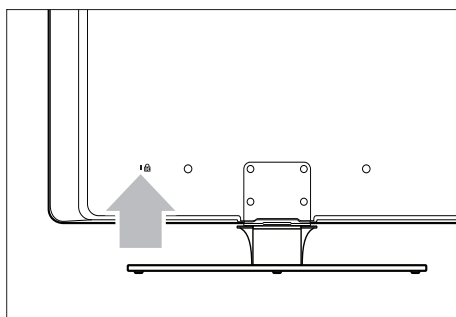

- For the best Ambilight effect, position the TV 10cm (four inches) to 20cm (eight

inches) away from the wall. Ambilight works best in a room with dim lighting.

## Wall mount the TV

### Warning

- Wall mounting of the TV should only be performed by qualified installers. Koninklijke Philips Electronics N.V. bears no responsibility for improper mounting that results in accident or injury.

### Step 1: Purchase a VESA-compatible wall bracket

Depending on the size of your TV screen, purchase one of the following wall brackets:

TV screen size (inches/cm)	VESA compatible wall bracket type (millimeters/millimetres)	Special instructions
32"/81cm	Adjustable 300 x 300	The VESA-compatible bracket must be adjusted to 200 x 300 before securing to the TV
37"/94cm	Fixed 300 x 300	None
42"/107cm or larger	Fixed 400 x 400	None

### Step 2: Remove the TV stand

These instructions are only applicable to TV models with mounted stands. If your TV stand is not mounted, skip to Step 3. TV stands may differ in shape on some TV models.

- Carefully place the TV face down on a flat, stable surface that is covered by soft cloth. The cloth should be thick enough to protect your screen.

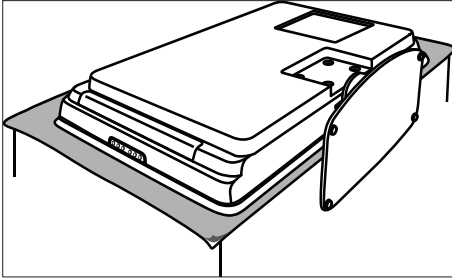

- Using a cross-head screwdriver (not supplied), unscrew the four bolts that secure the stand to the TV.

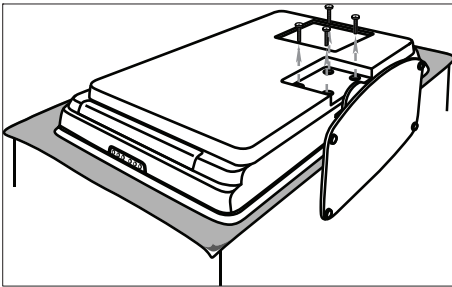

- Firmly pull the stand from the bottom of the TV. Place both the stand and bolts in a secure location for future reinstallation.

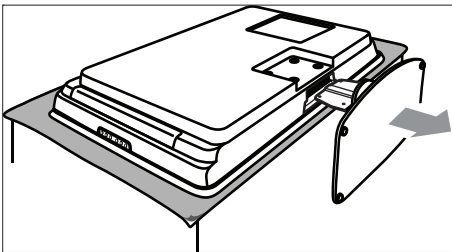

### Step 3: Secure the VESA-compatible wall bracket to the TV

- Locate the four mounting nuts at the back of the TV.

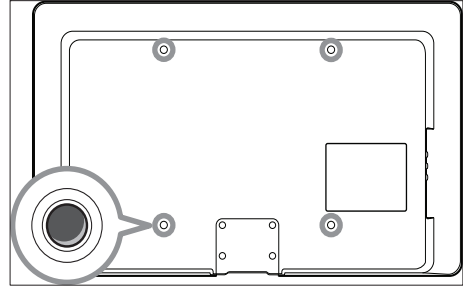

- Continue with the instructions provided with your VESA-compatible wall bracket.

#### Note

- When securing the VESA-compatible wall bracket to your TV, use M6 bolts for 32 inch models or M8 bolts for larger models (bolts not supplied).

### Connect the antenna cable

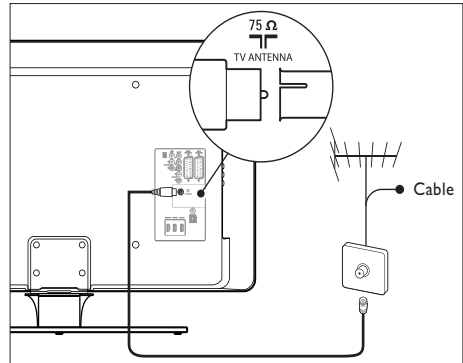

- Locate the **TV ANTENNA** connector at the back of the TV.
- Connect one end of an antenna cable (not supplied) to the **TV ANTENNA** connector. Use an adaptor if the antenna cable does not fit.
- Connect the other end of the antenna cable to your antenna outlet, ensuring that the cable is tightly secured at both ends.

## Connect the mains cord



### Warning

- Verify that your mains voltage corresponds with the voltage printed at on the back of the TV. Do not insert the mains cord cable if the voltage is different.

## To connect the mains cord



### Note

- The location of the mains connector varies according to TV model.

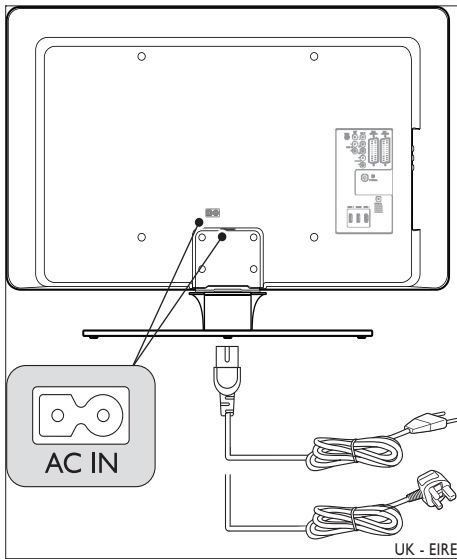

- 1 Locate the **AC IN** mains connector at the back or on the bottom of the TV.
- 2 Connect the mains cord cable to the **AC IN** mains connector:
- 3 Connect the mains cord cable to the mains, ensuring that the cord cable is tightly secured at both ends.

## Insert the remote control batteries

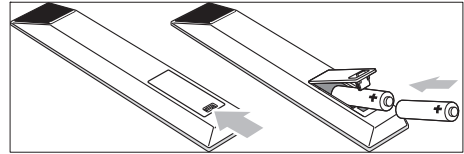

- 1 Open the battery cover on the back of the remote control.
- 2 Insert the two supplied batteries (Size AA). Be sure the + and - ends of the batteries line up with the markings inside the case.
- 3 Close the cover back into position.



### Note

- Remove the batteries if not using the remote control for an extended period of time.

## Switch on the TV

The first time you switch on the TV, check that the mains cord cable is properly connected. When ready, turn on the mains (if mains switch is available), then press **POWER** on the side of the TV.



### Note

- Certain TV models require you to press and hold **POWER** for up to two seconds. A beep sound indicates that your TV is switched on. Your TV may take up to 15 seconds to start.

## First time setup

- 1 The first time the TV is switched on, a language selection menu appears. Select your language and follow the on-screen instructions to set up the TV.

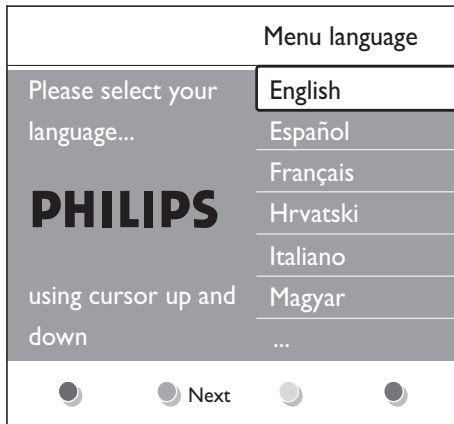

# 5 Use your TV

This section helps you perform basic TV operations. Instructions on advanced TV operations are also available (see 'Use more of your TV' on page 16).

## Switch your TV on/off or to standby

### Switch on your TV

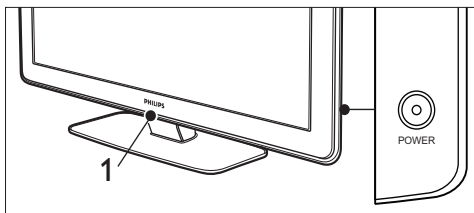

- If LightGuide (1) is off, press **POWER** on the side of the TV.
  - ↳ LightGuide flashes during start up, turning on completely when your TV is ready for use.

### Switch off your TV

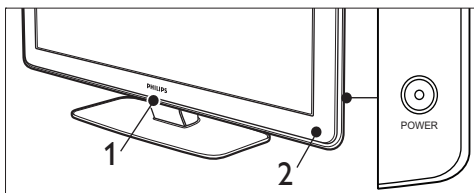

- Press **POWER** on the side of the TV.
  - ↳ Both LightGuide (1) and the standby indicator (2) switch off.

### Switch your TV to standby

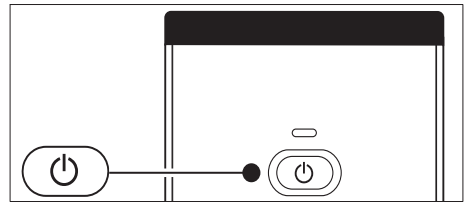

- Press **Standby** on the remote control.
  - ↳ LightGuide switches off and the standby indicator switches on (red).

#### Tip

- Though your TV consumes very little power when in standby, energy continues to be consumed as long as the mains remain connected and powered. When not in use for extended periods of time, switch off and disconnect the TV from the mains.

### Switch on the TV from standby

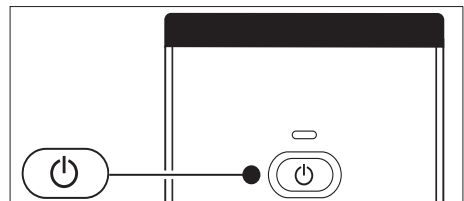

- If the power indicator is in **Standby** (red), press Standby on the remote control.

## Note

- If you cannot locate your remote control and you want to switch on the TV from standby, press **POWER** on the side of the TV. This switches off your TV. Press **POWER** again to switch the TV back on.

## Watch TV

### Switch channels

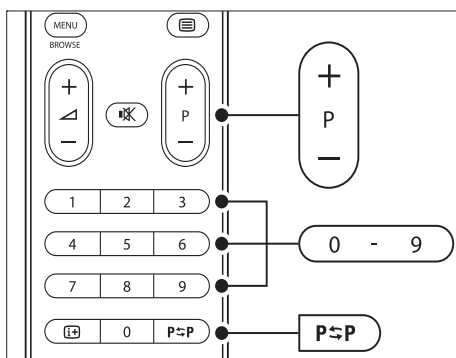

- Press a number (1 to 999) or press - P + on your remote control.
- Press **Program +/-** on the side controls of the TV.
- Press **P<=>P Previous channel** on the remote control to return to the previously-viewed TV channel.

### Switch channels (digital receiver)

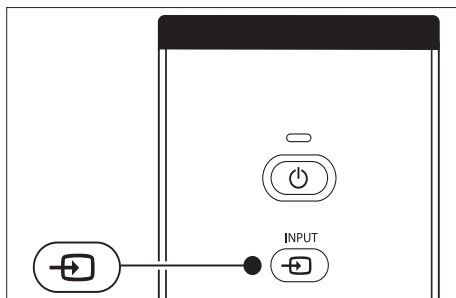

- Switch on the digital receiver.

- Press **INPUT** on the remote control.
- Select the input your digital receiver is connected to.
- Press **OK** to select the digital receiver.
- Use the remote control of the digital receiver to select TV channels.

### Adjust volume

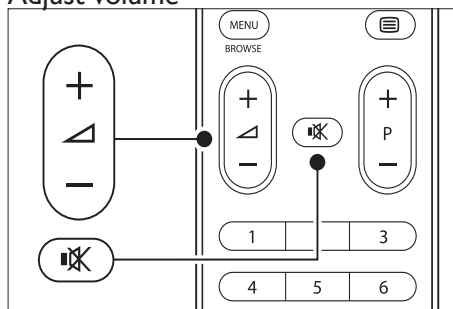

- Press **+/-** on the remote control.
- Press **Volume +/-** on the side controls of your TV.
- Press **Mute** on the remote control to mute the sound. Press **Mute** again to un-mute the sound.

### Note

- If headphones are connected, adjust volume by changing headphone volume. You must press the **MUTE** button on the remote control to mute audio from the TV speakers. Pressing **Volume +/-** turns on the TV speakers again.

## Watch connected devices

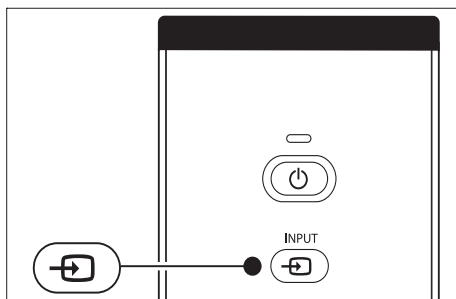

- 1 Switch on the device.
- 2 Press **INPUT** on the remote control.
- 3 Select the input your device is connected to.
- 4 Press **OK** to select the device.

## Use teletext

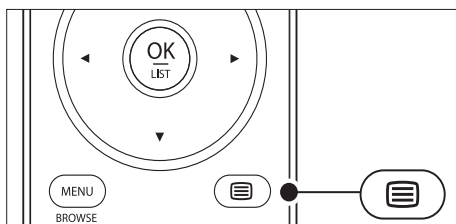

- 1 Press **Teletext** on the remote control.  
↳ The main index page appears.
- 2 To select a page:
  - Enter the page number with the number keys.

- Press **- P +** or **▲▼** to view the next or the previous page.
- Press a colour key to select one of the colour-coded items at the bottom of the screen.

- 3 Press **Teletext** again to switch off teletext.

### Tip

- Press **P=>P Previous channel** to return to the previously viewed page.

### Note

- For UK users only:
- Some digital TV channels offer dedicated digital text services (for example, BBC1).

Advanced information on teletext is available (see 'Use advanced teletext features' on page 26).

## Use Ambilight

Ambilight is an innovative Philips feature that adds reactive ambient lighting to your viewing experience.

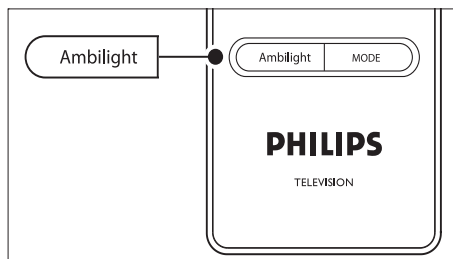

- 1 Press **AMBILIGHT** on the remote control.  
↳ Ambilight turns on.
- 2 Press **AMBILIGHT** again to turn off Ambilight.



## Change Ambilight mode

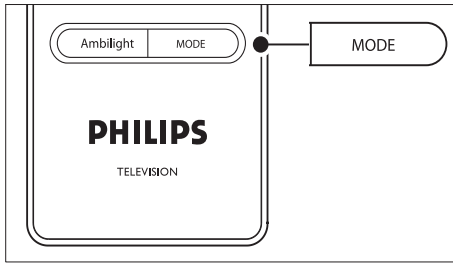

- 1** With Ambilight turned on, press **MODE** on the remote control.  
↳ An Ambilight **[Mode]** screen appears.
- 2** Press **MODE** or **▲▼** to select one of the following Ambilight modes:
  - **[Colour]**  
Sets Ambilight to a constant colour.
  - **[Relaxed]**  
Sets Ambilight to change soft and smoothly in sync with the images on-screen.
  - **[Moderate]**  
Sets Ambilight between **[Relaxed]** and **[Dynamic]** modes.
  - **[Dynamic]**  
Sets Ambilight to change quickly and responsively with the images on-screen.
- 3** Press **OK** to activate the Ambilight mode.

## 6 Use more of your TV

This section helps you perform advanced TV operations.

### Remote control overview

This section provides a detailed overview of remote control features.

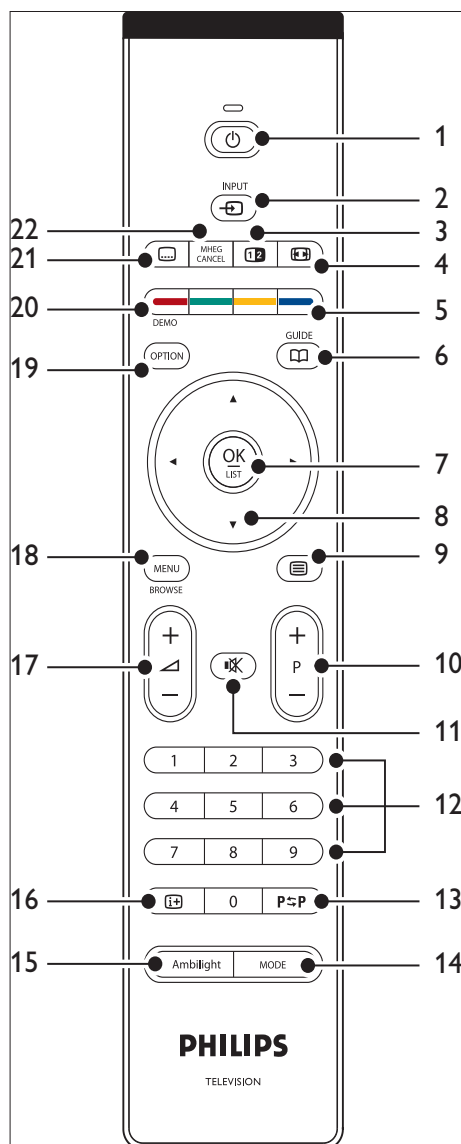

- ① **Standby**  
Switches the TV on from standby or back to standby.
- ② **INPUT**  
Selects connected devices.

- ③ **DS Dual Screen**  
Splits the current channel or source on the left of the screen. Teletext appears on the right.
- ④ **Picture format**  
Selects a picture format.
- ⑤ **Colour keys**  
Selects tasks or teletext pages.
- ⑥ **GUIDE**  
Toggles the Electronic Programme Guide on or off. Only active with digital channels.
- ⑦ **OK**  
Accesses the **[All channels]** menu or activates a setting.
- ⑧ **Navigation keys**  
Up, Down, Left and Right keys navigate the menu.
- ⑨ **Teletext**  
Toggles teletext on or off.
- ⑩ **Program +/-**  
Switches to the next or previous channel.
- ⑪ **Mute**  
Mutes or restores sound.
- ⑫ **Number keys**  
Selects a channel, page or setting.
- ⑬ **PSP Previous channel**  
Returns to the previously-viewed channel.
- ⑭ **MODE**  
Toggles Ambilight modes.
- ⑮ **AMBILIGHT**  
Switches Ambilight on or off.
- ⑯ **INFO**  
Displays programme information, if available.
- ⑰ **Volume +/-**  
Increases or decreases volume.
- ⑱ **MENU**  
Toggles the menu on or off.
- ⑲ **OPTION**

Activates the **[Quick access]** menu.

- ⑳ **DEMO**  
Toggles the **[Demo]** menu on or off.
- ㉑ **Subtitle**  
Activates or deactivates subtitles.
- ㉒ **MHEG CANCEL**  
Cancels digital text or interactive services (UK only).

## Use TV menus

On-screen menus help you install your TV, adjust picture, sound and Ambilight settings and access other features. This section describes how to navigate the menus.

### Access the main menu

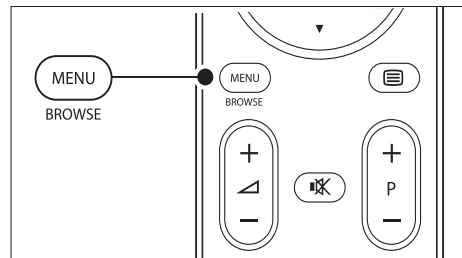

- 1 Press **MENU** on the remote control to display the main menu.

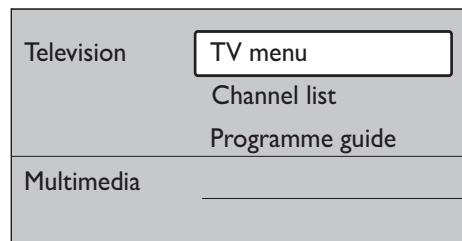

- 2 Press **MENU** to exit.  
The main menu offers the following items:
- **[TV menu]**

Select this menu for installation, picture and sound settings, Ambilight and other feature settings.

- **[Channel list]**  
Select this item to display the Channel list. Create your Favourite channel lists here.
- **[Programme guide]**  
Available when digital channels are installed, this item displays information about the digital programs (see 'Use the Electronic Programme Guide' on page 29).
- **[Multimedia]**  
Select this item to view photos or play music stored on a USB device (see 'View photos and listen to music' on page 33).

## Use the main menu

The following example describes how to use the main menu.

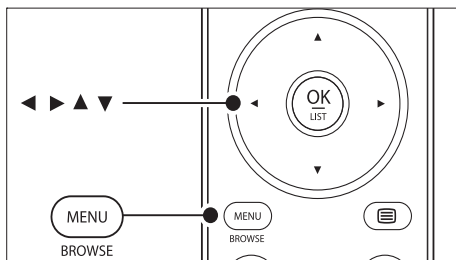

- 1 Press **MENU** on the remote control to display the main menu.

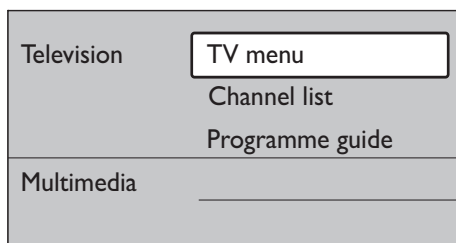

- 2 Press **▶** to enter the **[TV menu]**.

TV menu	TV settings
<b>TV settings</b>	Settings assistant
Features	Reset smart settings
Installation	Picture
Software update	Sound

- 3 Press **▶** to enter the **[TV Settings]** menu.

TV settings	Settings assistant
<b>Settings assistant</b>	Start now
Reset smart settings	
Picture	
Sound	
Ambilight	

- 4 Press **▼** to select **[Picture]**.

TV settings	Picture
Settings assistant	Contrast
Reset smart settings	Brightness
<b>Picture</b>	Colour
Sound	Hue
Ambilight	Sharpness
	Tint
	Pixel Plus
	<b>HD Natural Motion</b>
	Dynamic contrast
	Noise reduction
	MPEG artefact reduction
	Colour enhancement
	Active Control
	Light sensor
	Picture format

5 Press ► to enter the **[Picture]** settings.

Picture	Contrast
Contrast	90
Brightness	47
Colour	52
Hue	0
Sharpness	4
Tint	
Pixel Plus	
HD Natural Motion	

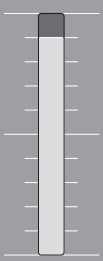

6 Press ▼ to select **[Brightness]**.

Picture	Brightness
Contrast	98
Brightness	47
Colour	52
Hue	0
Sharpness	4
Tint	
Pixel Plus	
HD Natural Motion	

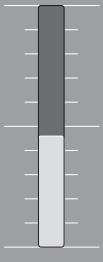

7 Press ► to enter the **[Brightness]** setting.

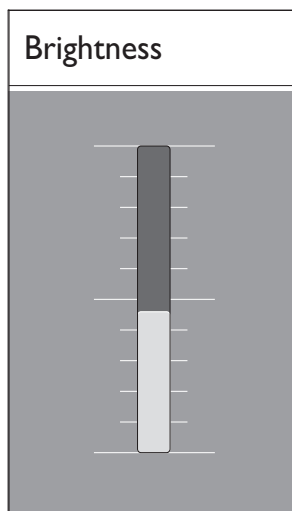

8 Press ▲▼ or to adjust the setting.

9 Press ◀ to return to the **[Picture]** settings or press **MENU** to exit.

#### Note

- More choices are available when digital channels are installed and broadcast.

## Use the Quick access menu

The **[Quick access]** menu gives direct access to some often-needed menu items.

#### Note

- When digital channels are installed and broadcasted, the relevant digital options are displayed in the **[Quick access]** menu.

1 Press **OPTION** on the remote control.

2 Press, or to select an option:

- **[Audio language]** (digital)
- **[Subtitle language]** (digital)
- **[Subtitle]**
- **[Picture format]**
- **[Equalizer]**
- **[Clock]**

- 3 Press **OK** to display the selected option menu.
- 4 Press **▲▼◀▶** **Navigation keys** to adjust the settings in the menu.
- 5 Press **OPTION** to exit the menu.

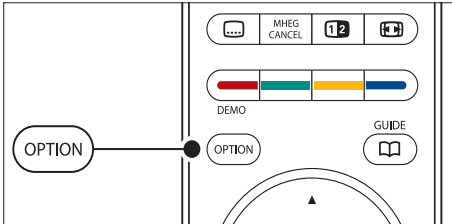

### To display or hide the clock

- 1 In the **[Quick access]** menu, select **[Clock]** and press **OK** to display the clock permanently.

Quick access
Audio language
Subtitle language
Subtitle
Picture format
Equalizer
<b>Clock</b>

- 2 Press **OPTION** and press **▲▼** to select **[Clock]** again.
- 3 Press **OK** to hide the clock.

## Adjust picture and sound settings

This section describes how to adjust picture and sound settings.

### Use settings assistant

Use **[Settings assistant]** to guide you through picture, sound and Ambilight settings.

- 1 Press **MENU** on the remote control and select **[TV menu] > [TV Settings] > [Settings assistant]**.
- 2 Press **▶** to enter.
- 3 Press **OK** to **[Start now]**.
- 4 Press **the green key** on the remote control to start the assistant.
- 5 Press **◀** or **▶** to select the left or right side to make your choice.
- 6 Press **the green key** to go to the next setting.
  - ↳ You will go through several settings. When finished, you will be prompted to store these settings.
- 7 Press **the green key** to store all your settings.

### Adjust picture settings

This section describes how to adjust picture settings.

- 1 Press **MENU** on the remote control and select **[TV menu] > [TV Settings] > [Picture]**.

TV settings	Picture
Settings assistant	Contrast
Reset smart settings	Brightness
Picture	Colour
Sound	Hue
Ambilight	Sharpness
	Tint
	Pixel Plus
	HD Natural Motion
	Dynamic contrast
	Noise reduction
	MPEG artefact reduction
	Colour enhancement
	Active Control
	Light sensor
	Picture format

2 Press ► to enter the list.

3 Press ▲▼ to select a setting:

- **[Contrast]** Changes the level of bright parts in the picture keeping the dark parts unchanged.
- **[Brightness]** Changes the level of light in the picture.
- **[Colour]** Changes the level of saturation.
- **[Hue]** If NTSC is broadcast, this level compensates the colour variations.
- **[Sharpness]** Changes the level of sharpness of fine details.
- **[Tint]** Sets the colours to **[Normal]**, **[Warm]** (reddish) or **[Cool]** (bluish). Select **[Custom]** to make a setting of your own.
- **[Custom] tint.** If **[Custom]** is selected in the Tint menu, follow the on-screen instructions to change the value of:
  - **[R-WP]** (Red White Point)
  - **[G-WP]** (Green White Point)

- **[B-WP]** (Blue White Point)
- **[R-BL]** (Red Black Level)
- **[G-BL]** (Green Black Level)
- **[Pixel Plus]** Enables or disables Pixel Plus HD, which fine tunes each pixel to match surrounding pixels. This produces a brilliant high definition image.
- **[HD Natural Motion]** Reduces the field and line flicker and reproduces smooth movement especially in movies. Set the level to Maximum, Minimum or Off.
- **[Dynamic contrast]** Enhances the contrast in the picture as the image on the screen changes. Set the level to Minimum, Medium, Maximum or Off. Medium is recommended.
- **[Noise reduction]** Filters and reduces the noise in the picture. Set the level to Minimum, Medium, Maximum or Off.
- **[MPEG artefact reduction]** Smoothens the transitions on digital pictures. Switches MPEG artefact reduction On or Off.
- **[Colour enhancement]** Makes colours more vivid and improves the resolution of details in bright colours. Set the level to Minimum, Medium, Maximum or Off.
- **[Active Control]** Corrects all incoming signals to provide the best picture possible. Switches Active control On or Off.
- **[Light sensor]** Adjusts picture and Ambilight settings to match lighting conditions in the room. Switches Light sensor On or Off.
- **[Picture format]** Change the picture format to suit your content.

## Use smart settings

Apart from manually adjusting picture settings, you can use smart settings to set your TV to a predefined picture, sound and Ambilight setting.

- 1 Press **MENU** on the remote control and select **[TV menu] > [TV Settings] > [Reset smart settings]**.
- 2 Press **▶** to enter the list.
- 3 Press **▲** or **▼** to select one of the following settings:
  - **[Current]**  
Applies manually selected picture, sound and Ambilight settings.
  - **[Standard]**  
Applies natural picture, sound and Ambilight settings suitable for most living room conditions.
  - **[Vivid]**  
Applies brilliant picture, sound and Ambilight settings suitable for bright surroundings.
  - **[Movie]**  
Applies dynamic picture, sound and Ambilight settings suitable for a complete cinematic experience.
- 4 Press the **green key** to store your selection.

## Change picture format

Change the picture format to suit your content.

- 1 Press **[Picture format]** on your remote control. Alternatively, press **MENU** and select **[TV menu] > [TV Settings] > [Picture] > [Picture format]**.

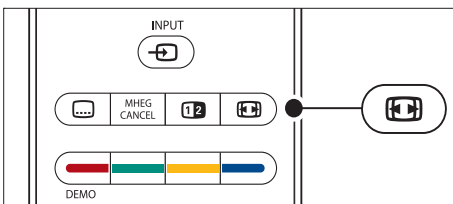

- 2 Press **▲** or **▼** to select one of the following picture formats:
  - **[Auto format]** (Not for PC)

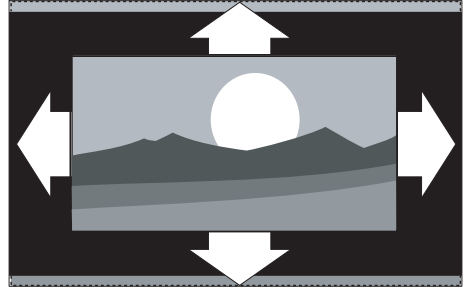

Enlarges the picture automatically to fill the screen. Subtitles remain visible.

**Note**

- We recommend you use **[Auto format]** for minimal screen distortion.

- **[Super zoom]** (Not for HD)

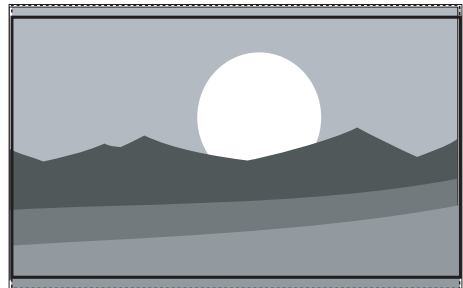

Removes the black bars on the side of 4:3 broadcasts with minimal distortion.

- **[4:3]** (Not for HD)

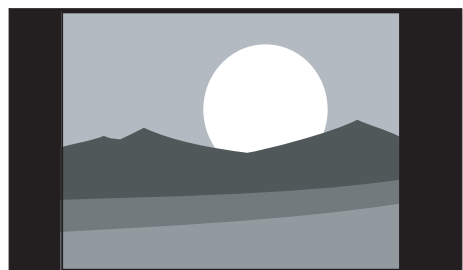

Displays the classic 4:3 format.





## Note

- Constant use of the **[4:3]** picture format can cause screen distortion. We recommend you use **[Auto format]**.

- **[Movie expand 14:9]** (Not for HD)

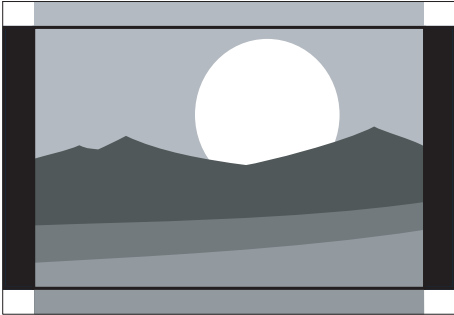

Scales the classic 4:3 format to 14:9.



## Note

- Constant use of the 14:9 picture format can cause screen distortion. We recommend you use **[Auto format]**.

- **[Movie expand 16:9]** (Not for HD)

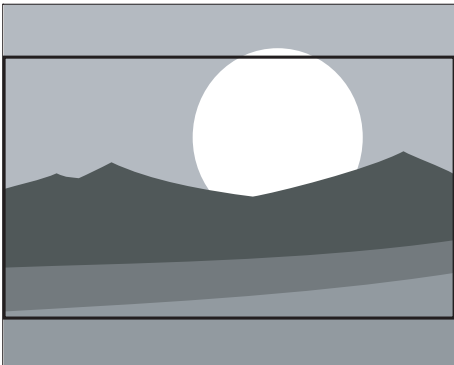

Scales the classic 4:3 format to 16:9.

- **[Wide screen]**

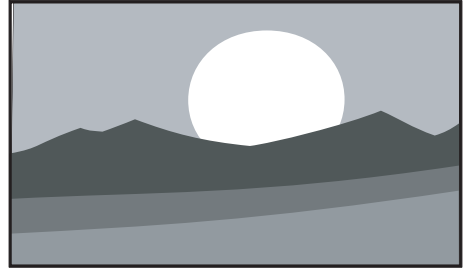

Stretches the classic 4:3 format to 16:9

- **[Unscaled]** (Only for HD and PC)

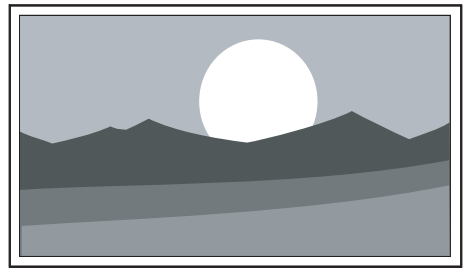

Maximum sharpness though distortion may appear on borders. Also, black bars may appear with pictures from your PC.

## Adjust sound settings

This section describes how to adjust sound settings.

- 1 Press **MENU** on the remote control and select **[TV menu] > [TV Settings] > [Sound]**.
- 2 Press **▶** to enter the list.

TV settings	Sound
Settings assistant	Equalizer
Reset smart settings	Volume
Picture	Balance
Sound	Audio language
Ambilight	Dual I/II
	Mono/Stereo
	Surround mode
	Headphone volume
	Auto volume leveling
	Delta volume
	Auto surround

3 Press ▲ or ▼ to select one of the following settings:

- **[Equalizer]**  
Changes the bass and treble of the sound. Select each bar to change a setting. Alternatively, press the colour keys to select a pre-defined equalizer setting:
  - **[Standard]**  
Equalizer set to neutral.
  - **[Speech]**  
Equalizer settings maximized for speech-based audio.
  - **[Multimedia]**  
Settings maximized for different audio types.
  - **[Music]**  
Settings maximized for music.
- **[Volume]**  
Changes the volume.



#### Tip

- To enable or disable the volume bar that appears when you change the volume, press **MENU** on the remote control and select **[TV menu] > [Installation] > [Preferences]**. Press ► to enter the list and select volume bar **[On]** or **[Off]**.

- **[Balance]**

Sets the balance of the left and right speakers to best fit your listening position.

- **[Audio language]**  
Lists audio languages available for a digital channel (unavailable on analogue channels).
- **[Dual I-II]**  
If available, choose between two different languages.
- **[Mono/Stereo]**  
If stereo broadcasting is available, choose between mono or stereo.
- **[Surround mode]**  
If surround sound (Virtual Dolby Surround) is available, enable it for more spatial sound.
- **[Headphone volume]**  
Changes the volume of your headphones.



#### Note

- When headphones are connected, press the **Mute** button on the remote control to mute audio from the TV speakers. Pressing **Volume +/-** buttons un-mutes the TV speakers.
- **[Automatic volume leveling]**  
Reduces sudden volume changes, for example, during commercials or when switching from one channel to another. Select **[On]** or **[Off]**.
- **[Delta volume]**  
Levels out volume differences between channels or connected devices. You must switch to the connected device before changing the Delta volume.
- **[Auto surround]**  
Automatically switches the TV to the best surround sound mode available from a broadcast. Select **[On]** or **[Off]**.

## Adjust Ambilight settings

- 1 Press **MENU** on the remote control and select **[TV menu] > [TV Settings] > [Ambilight]**.
- 2 Press ► to enter the list.

TV settings	Ambilight
Settings assistant	Ambilight
Reset smart settings	Brightness
Picture	Mode
Sound	Colour
<b>Ambilight</b>	Separation
	Balance

- 3** Press **▲** or **▼** to select one of the following settings:
- **[Ambilight]**  
Switches Ambilight **[On]** or **[Off]**.
  - **[Brightness]**  
Changes the light output of Ambilight.
  - **[Mode]**  
Choose from four Ambilight modes: **[Colour]**, **[Relaxed]**, **[Moderate]**, **[Dynamic]**.
  - **[Colour]**  
Select a pre-defined colour setting (**[Warm white]**, **[Cool white]**, **[Blue]**) or make a custom colour of your own.  
When making a custom colour, select **[Saturation]** first, setting the value high. Then select **[Palette]** and choose a value between 0 to 100.
  - **[Separation]**  
Sets the level of Ambilight colour on the left and right side of the TV. **[Maximum]**, **[Medium]**, **[Minimum]** and **[Off]** levels are available. When **[Off]** is selected, only mono colour Ambilight is displayed.
  - **[Balance]**  
Sets the level of Ambilight on the left and right side of the TV.

### ! Caution

- To avoid poor remote control reception, do not place remote control sensors on your devices in range of Ambilight.

## Enable Ambilight when TV is in standby mode

When the TV is in standby mode, you can switch on Ambilight to enhance the ambience of your room. Ambilight is only available as constant colour in this mode.

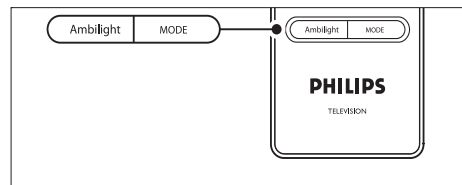

- 1** Press **AMBILIGHT** on the remote control when the TV is in standby.
- 2** Press **MODE** repeatedly to select an available colour.

## Adjust LightGuide brightness

- 1** Press **MENU** on the remote control and select **[TV menu] > [Installation] > [Preferences] > [LightGuide brightness]**.
- 2** Press **▶** to enter the **[LightGuide brightness]** menu.
- 3** Use **▲** or **▼** to select the LightGuide brightness:
  - **[0]**: Off
  - **[1]**: 25%
  - **[2]**: 50%
  - **[3]**: 75%
  - **[4]**: Full
- 4** Press **OK** to confirm.
- 5** Press **MENU** to exit.

---

## Change to Shop or Home mode

- 1 Press **MENU** on the remote control and select **[TV menu] > [Installation] > [Preferences] > [Location]**.
- 2 Press **▶** to enter the Location menu.
- 3 Use **▲** or **▼** to select the TV mode:
  - **[Shop]**  
Sets smart settings to **[Vivid]**, ideal for a shop environment. The flexibility to change settings is limited.
  - **[Home]**  
Gives home users the full flexibility to change all TV settings.
- 4 Press **OK** to confirm.
- 5 Press **MENU** to exit.

---

## Use advanced teletext features

Your TV has a 1,200- page memory that stores broadcasted teletext pages and subpages. The teletext memory reduces page loading time.

---

### Select teletext subpages

A teletext page can hold several subpages. Subpages are displayed on a bar next to the main page number:

- 1 Press **☰ Teletext** on the remote control.
- 2 Select a teletext page.
- 3 Press **◀** or **▶** to select a subpage.

---

### Select T.O.P. teletext broadcasts

Table Of Pages (T.O.P.) teletext broadcasts allow you to jump from one subject to another without using page numbers. T.O.P. teletext is not broadcast on all TV channels.

- 1 Press **☰ Teletext** on the remote control.
- 2 Press **INFO**.

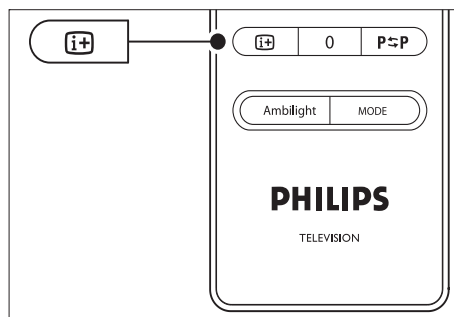

↳ The T.O.P. overview appears.

- 3 Use **◀▶** or **▲▼** to select a subject.
- 4 Press **OK** to view the page.

---

## Use dual screen teletext

Enabling dual screen teletext displays your channel or source on the left of the screen. Teletext is displayed on the right.

- 1 Press **☰ Dual Screen** on your remote control to enable dual screen teletext.
- 2 Press **☰ Dual Screen** again to display normal teletext.
- 3 Press **Teletext** to switch off teletext.

---

## Search teletext

Quickly jump to a subject linked to a series of page numbers or search for specific words in teletext pages.

- 1 Press **☰ Teletext** on the remote control.
- 2 Press **OK** to highlight the first word or number.
- 3 Press **▲▼** or **◀▶** to jump to the next word or number on the page.
- 4 Press **OK** to search a page which holds the highlighted word or number.
- 5 Press **▲** until no word or number is highlighted to exit **[Search]**.

## Enlarge teletext pages

For more comfortable reading, you can enlarge the teletext page.

- 1 Press **Teletext** on the remote control and select a teletext page.
- 2 Press **OPTION** on the remote control to enlarge the top part of the page.

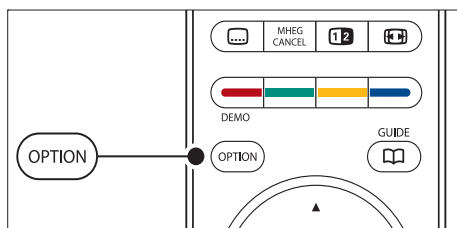

- 3 Press **OPTION** again to view the enlarged lower part of the page.
- 4 Press **▲** or **▼** to scroll through the enlarged page.
- 5 Press **OPTION** again to return to the normal page size.

## Use the teletext menu

With the options in the teletext menu you can reveal hidden information, cycle subpages automatically and change the character setting.

- 1 Press **Teletext** on the remote control.
- 2 Press **MENU**. The **[TELETEXT MENU]** menu appears.

Teletext menu	
Reveal	Off
Cycle subpages	Off
Language	Gr. II

- 3 Press **▲** or **▼** to select an option.
  - **[Reveal]**

Hide or reveal hidden information on a page, such as solutions to riddles or puzzles.

- **[Cycle subpages]**  
If subpages are available for the selected page, you can cycle subpages automatically.
- **[Language]**  
Some languages use a different set of characters. If using a different language, switch to the appropriate language group to display the text correctly.

- 4 Press **OK** to change an option:
- 5 Press **MENU** to exit **[TELETEXT MENU]** menu.
- 6 Press **Teletext** to switch off teletext.

## Use digital text services (UK only)

Some digital TV broadcasters in UK offer dedicated digital text or interactive services (for example, BBC1). These services work like normal teletext with the addition of number, colour and navigation keys.

- 1 Press **Teletext** on the remote control.
- 2 Press **▲▼** or **◀▶** to select or highlight items.
- 3 Press one of the colour keys to select an option.
- 4 Press **OK** to confirm or activate.
- 5 Press **MHEG CANCEL** to cancel digital text or interactive services.

Digital text services are blocked when subtitles are broadcasted and **[Subtitle On]** is set in the **[Features]** menu (see 'Use subtitles' on page 32).

## Use Teletext 2.5

If broadcasted by the TV channel, Teletext 2.5 offers more colours and better graphics than normal teletext. Teletext 2.5 is switched on by default.

- 1 Press **MENU** on the remote control and select **[TV menu] > [Installation] > [Preferences] > [Teletext 2.5]**.

- 2 Press **▶** to enter the list.
- 3 Select **[On]** or **[Off]**.
- 4 Press **OK** to change the option.

---

## Create favourite lists

Use the **[All channels]** list or setup a favourite list of your own with preferred TV channels and radio stations. Each member of your family can create his or her own favourite list.

---

### Select a favourite list

- 1 Press **OK** on the remote control. Alternatively, press **MENU** and select **[Channel list]**.
  - ↳ If this is new installation, the **[All channels]** list is displayed.

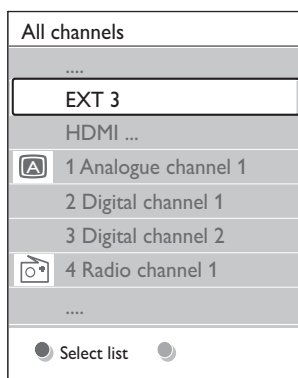

↳ If this is not a new installation, the last selected favourite list appears.

- 2 Press the red key to display all favourite lists.
- 3 Press **▲** or **▼** to select a list.
- 4 Press **OK**.
  - ↳ The selected favourite list appears.
- 5 Press **OK** again to exit.

---

### Setup a favourite list

- 1 Press **OK** on the remote control.
  - ↳ The last selected list appears.
- 2 Press the red key to show all favourite lists.
- 3 Press **▲** or **▼** to select a list.
- 4 Press **OK**.
- 5 Press the green key to enter **[Edit list]** mode.
  - ↳ The selected list displays a full channel list.
- 6 Press **▲** or **▼** to highlight a channel.
- 7 Press **OK** to mark (or unmark) the highlighted channel.
  - ↳ The channel is added to (or removed from) the selected list.
- 8 Press the green key again to exit **[Edit list]** mode.
  - ↳ The modified channel list appears again.

---

### Select a channel from a favourite list

- 1 Press **OK** on the remote control. The last selected channel list appears.
- 2 Use **▲** or **▼** to highlight a channel.
- 3 Press **OK**. The TV tunes to that channel.

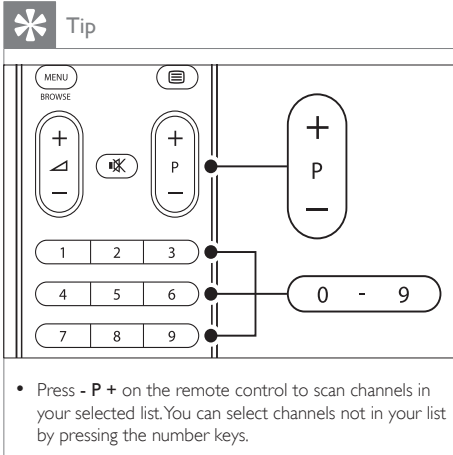

## Use the Electronic Programme Guide

EPG is an on-screen guide that displays scheduled digital TV programs. This guide is not available with analogue channels. You can navigate, select and view programs by time, title or genre.

There are two types of EPG, **[Now and Next]** and **[7 or 8 day]** EPG. **[Now and Next]** is always available but the **[7 or 8 day]** EPG is only available in certain countries.

With the EPG menu you can:

- View a list of currently broadcast digital programs
- View upcoming programs
- Group programs by genre
- Set reminders when programs start
- Setup preferred EPG channels

## Switch on EPG

### Note

- The first time you use EPG, you may be prompted to perform an update. If so, follow the on-screen instructions.

- 1 Press **GUIDE** on the remote control.

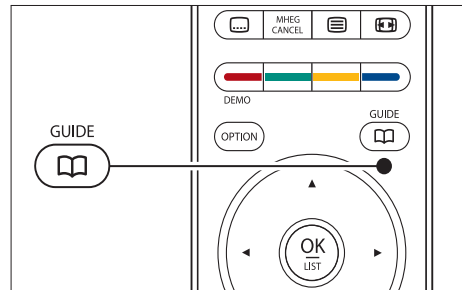

Alternatively, press **MENU** and select **[Programme guide]**.

The following EPG types appear:

- **[Now and Next]**  
Detailed information about the current programme is displayed.

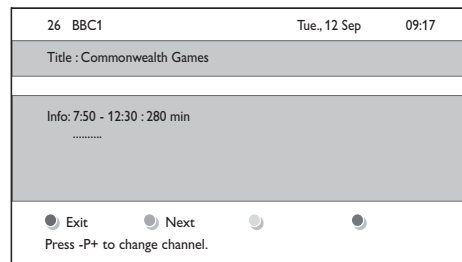

- **[7 or 8 day]**  
It may take some time to receive **[7 or 8 day]** EPG data. When loaded, a list of TV programs is displayed.

Programme guide		Tue., 12 Sep	
Around	09:55	Next	
BBC ONE	07:50 Commonwealth	12:30	Commonwealth
BBC TWO	09:50 Tweenies	10:15	Something Special
five	09:00 The Wright Stuff	10:30	Trisha Goddard
BBC THREE	05:32 This is BBC THREE	12:00	This is BBC THREE
BBC FOUR	05:32 This is BBC FOUR	12:00	This is BBC FOUR
abc1	09:20 Moonlighting	10:15	Daddio

Remind 13:50 Anastasia  
 Watch  
 Jump to ...  
 Info 0010 - EEN

2 Use the colour keys on the remote control to activate available actions:

- **[Next]**  
Displays information about the next programme.
- **[Remind]**  
Marks a programme as a reminder.
- **[Watch]**  
Watch or listen to a current programme.
- **[Jump to...]**  
Jumps to the next or previous day.
- **[Info]**  
If available, displays information about a selected programme.

3 Press **GUIDE** to exit the EPG.

## More on '7 or 8 day' EPG

Searching by genre, scheduling reminders and more features are available through the **[Programme guide]** menu.

- 1 Press **GUIDE** on the remote control.
- 2 Press **MENU** on the remote control. The **[Programme guide]** menu appears.

Programme guide	What's on
What's on	12:30 South Today
Search by genre	11:50 Working Lunch
Scheduled remind...	11:55 Melrose Place
Preferred EPG ch...	13:00 In aller Freund
Acquire EPG data	

3 Press **▲** or **▼** to select a menu option.

4 Press **▶** to enter.

5 Press **▲** or **▼** to make a selection.

6 Press **OK** or the green key to activate the selection.

7 Press **GUIDE** to exit the EPG.

### Note

- Only channels marked as preferred EPG channels appear in the **[Programme guide]** menu.

## Use timers and Child lock

This section describes how to switch the TV on or off at a specified time and to use Child lock.

### Automatically switch the TV to standby (Sleeptimer)

Sleeptimer switches the TV to standby after a defined period of time.

- 1 Press **MENU** on the remote control and select **[TV menu] > [Features] > [Sleeptimer]**.
- 2 Press **▶** to enter the **[Sleeptimer]** bar.
- 3 Press **▲** or **▼** to set the sleep time.  
↳ This can be up to 180 minutes in steps of five minutes. If set to zero minutes, the Sleeptimer is switched off.
- 4 Press **OK** to activate the Sleeptimer.

### Note

- You can always switch off your TV earlier or reset Sleeptimer during the countdown.

### Automatically switch the TV on (On timer)

On timer switches the TV to a specified channel at a specified time, from standby.



- 1 Press **MENU** on the remote control and select **[TV menu] > [Features] > [On timer]**.
- 2 Press **▶** to enter the **[On timer]** menu.
- 3 Use **▲▼** or **◀▶** to select and enter the menu items to set a channel, day of the week, frequency and starting time.
- 4 Press **OK** to confirm.
- 5 Press **MENU** to exit.



#### Tip

- To switch off **[On timer]**, select **[Off]** in the **[On timer]** menu.

## Lock TV channels or connected devices (Child lock)

Lock TV channels or connected devices with a four-digit code to prevent children from watching unauthorized content.

### To set or change the Child lock code

- 1 Press **MENU** on the remote control and select **[TV menu] > [Features] > [Set code]/[Change code]**.
- 2 Press **▶** to enter the code setup.
- 3 Enter your code with the number keys. The **[Features]** menu reappears with a message confirming that your code is created or changed.



#### Tip

- If you forget your code, enter '8888' to override any existing codes.

### To enter the Child lock menu

- 1 Press **MENU** on the remote control and select **[TV menu] > [Features] > [Child lock]** and press **▶** to enter your code.
- 2 Enter your code with the number keys.

## To lock or unlock all channels and connected devices

- 1 In the **[Child lock]** menu, select **[Lock]** or **[Unlock]**.
- 2 Press **OK**.

## To lock a programme or all channels from a certain time

- 1 In the **[Child lock]** menu, select **[Custom lock]**.

Child lock	Custom lock
Lock	Lock after
Custom lock	Channel lock
Unlock	Parental rating

- 2 Press **▶** to enter the **[Custom lock]** menu.
- 3 Press **▶** again to enter the **[Lock after]** menu.
- 4 Select **[On]** to enable the **[Timer lock]**.
- 5 Press **◀**.
- 6 Select **[Time]**.
- 7 Press **▶**.
- 8 Enter the time with **▲** or **▼** and **▶**.
- 9 Press **OK**.

## To lock one or more channels and connected devices

- 1 In the **[Child lock]** menu, select **[Custom lock]**.
- 2 Press **▶** to enter.
- 3 Press **▲** or **▼** to select **[Channel lock]**.
- 4 Press **▶**.
- 5 Press **▲** or **▼** to select the channel or device you want to lock or unlock.
- 6 At each selection, press **OK** to lock or unlock the channel or device.

---

## To set parental ratings

Some digital broadcasters rate their programmes according to age. You can set your TV to display only programmes with age ratings higher than your child's.

- 1 In the **[Child lock]** menu, select **[Custom lock]**.
- 2 Press **▶** to enter.
- 3 Press **▲** or **▼** to select **[Parental rating]**.
- 4 Press **▶**.
- 5 Press **▲** or **▼** to select an age rating.
- 6 Press **MENU** to exit the **[Child lock]** menu.

---

## Use subtitles

You can enable subtitles for each TV channel. Subtitles are broadcast via teletext or DVB-T digital broadcasts. With digital broadcasts, you have the additional option of selecting a preferred subtitle language.

---

### Enable subtitles on analogue TV channels

- 1 Select an analogue TV channel.
- 2 Press **≡ Teletext** on the remote control.
- 3 Enter the three- digit page number of the subtitle page.
- 4 Press **≡ Teletext** to switch off teletext.
- 5 Press **MENU** on the remote control and select **[TV menu] > [Features] > [Subtitle]**.
- 6 Press **▶** to enter the list.

TV menu	Features
TV settings	Subtitle
<b>Features</b>	Subtitle language
Installation	Sleeptimer
Software update	Child lock
	Set/Change code
	On timer
	Common interface
	Demo

- 7 Press **▲** or **▼** to select **[On]** to display subtitles always or **[On during mute]** to display subtitles only when the sound is muted with the **⊘** key on the remote control.
- 8 Press **OK** to return to the **[Features]** menu.



#### Note

- You must repeat this procedure to enable subtitles on each analogue channel.

---

### Enable subtitles on digital TV channels

- 1 Press **MENU** on the remote control and select **[TV menu] > [Features] > [Subtitle]**.
- 2 Press **▶** to enter the list.

TV menu	Features
TV settings	Subtitle
<b>Features</b>	Subtitle language
Installation	Sleep timer
Software update	Child lock
	Set/Change code
	On timer
	Common interface
	Demo

- Press **▲** or **▼** to select **[On]** to display subtitles always or **[On during mute]** to display subtitles only when the sound is muted with the **✖** key on the remote control.
- Press **OK** to return to the **[Features]** menu.

### Select a subtitle language on digital TV channels

#### Note

- When you select a subtitle language on a digital TV channel as described below, the preferred subtitle language set in the **[Installation]** menu is temporarily overruled.

- Press **MENU** on the remote control and select **[TV menu] > [Features] > [Subtitle language]**.
- Press **▶** to enter the list of available languages.
- Press **▲** or **▼** to select a subtitle language.
- Press **OK**.

## View photos and listen to music

Connect an external USB storage device and view pictures (JPEG format only) or listen to music (MP3 or Linear PCM formats only).

#### Note

- Philips will not be held responsible if your USB storage device is not supported nor shall Philips accept any liability for damage or loss of stored data.

### Connect a USB storage device

While your TV is on, connect your USB storage device to the USB port on the side of your TV (see 'Connect devices' on page 41). The main menu appears automatically and the name of the USB device is highlighted next to **[Multimedia]**.

Television	TV menu
	Channel list
	Programme guide
<b>Multimedia</b>	

### Disconnect a USB storage device

#### Caution

- To avoid damaging your USB device, always follow the procedure described below when disconnecting.

- Press **MENU** on the remote control to exit the **[Multimedia]** menu.
- Wait five seconds before disconnecting the USB device.

## View your photos

- 1 After connecting your USB storage device to the TV, press ► to enter the **[Multimedia]** menu. **[Picture]** is highlighted.

USB	Picture
Picture	Afrika_2001
Music	Paris_2006
	My_car.jpg
	Jean.jpg
	Mary.jpg

- 2 Press ► to enter the **[Picture]** folder.

Picture	Afrika_2001
Afrika_2001	Kenya.jpg
Paris_2005	Congo.jpg
My_car.jpg	Victoria.jpg
Jean.jpg	Dakar.jpg
Mary.jpg	Cairo.jpg

- 3 Press ▲ or ▼ to select a picture or a picture album on the USB device.

Afrika_2001	Afrika_2001
Kenya.jpg	
Congo.jpg	
Victoria.jpg	
Dakar.jpg	
Cairo.jpg	
	 Kenya.jpg

- 4 Press **OK** to view the picture or to start a slide show of the pictures in the album.
- 5 Press **OK** to pause the slide show. Press **OK** again to restart.
- 6 Press one of the colour keys on the remote control to perform the

corresponding function shown at the bottom of the screen.

- 7 Press the blue key to stop the show and to see more functions. If the function bar at the bottom disappears, press any colour key to make it reappear.
- 8 Press ◀ and select another picture or another album.

## Slide show settings

- **[No details]/[More details]**  
Displays the picture name, date, size and next picture in the slide show.
- **[Transitions]**  
Displays the list of available transition styles of the pictures. Press or to select and press **OK** to activate.
- **[Slide time]**  
Sets the time lag for picture transitions: **[Short]**, **[Medium]** or **[Long]**.
- **[Rotate]**  
Rotates a picture.
- **[Zoom]**  
Displays a list of available zoom magnifications.
- **[Start show]/[Stop show]**  
Starts or stops a slide show.

## View pictures as thumbnails

Thumbnails allow you to view picture albums in an overview format.

- 1 Select a picture album.
- 2 Press ► to enter the picture list.
- 3 Press the green key.
- 4 Press ▲ or ▼, ◀ or ▶ to highlight a picture.
- 5 Press **OK** to view the picture.
- 6 Press ◀ to return to the thumbnail overview.
- 7 Press the green key again to go back to the picture list.

---

## Listen to music

- 1 After connecting your USB storage device to the TV, press ► to enter the **[Multimedia]** menu.
- 2 Select **[Music]** then press ► to enter the **[Music]** folder:
- 3 Press ▲ or ▼ to select a song or a music album.
- 4 Press **OK** to play the selected song or album.

---

## Music settings

- **[No details]/[More details]**  
Displays the file name.
- **[Repeat: one]/[Repeat: all]**  
Repeat a song or an album.
- **[Shuffle]**  
Play songs in a random sequence.

---

## View a slide show with music

You can view a slide show of your stored pictures with background music.

- 1 Select an album of songs first then press **OK**.
- 2 Select an album to display then press **OK**.

---

## Listen to digital radio channels

If digital broadcasting is available, digital radio channels are installed automatically during installation. You can reorder digital radio channels after installation (see 'Rearrange channels' on page 39).

- 1 Press **OK** on the remote control. The **[All channels]** menu is displayed.
- 2 Use the number keys to select a radio channel.
- 3 Press **OK**.

---

## Update your TV software

Philips continuously tries to improve its products and we strongly recommend that you update the TV software when updates are available. Check [www.philips.com/support](http://www.philips.com/support) for availability.

---

### Check your current software version

- 1 Press **MENU** on the remote control and select **[TV menu] > [Software update] > [Current software info]**.

---

### Check if software updates are available

Philips periodically transmits messages via digital broadcast, announcing when software updates are available:

- 1 Press **MENU** on the remote control and select **[TV menu] > [Software update] > [Announcement]**.

---

### Update software (digital broadcasts)

If using (DVB-T) digital broadcasts, your TV automatically receives software updates. If you receive a message on-screen prompting you to update your software:

- Select **[Now]** (recommended) to update the software immediately.
- Select **[Later]** to be reminded to update the software later.
- Select **[Cancel]** to exit the update (not recommended). If you cancel the update, manually update the software by pressing **MENU** and selecting **[TV menu] > [Software update] > [Local updates]**. Follow the on-screen instructions.

---

### Update software (analogue broadcasts)

Before performing this procedure be sure to:

- Set aside some time to complete the entire update.
- Have available a USB storage device with at least 64MB of storage space.
- Have access to a computer with a USB port and internet access.

**1** Press **MENU** on the remote control and select **[TV menu] > [Software update] > [Update assistant]**.

**2** Select **[Start now]**.

**3** Insert the USB storage device and press the green key. An ID file is copied to the USB device.

**4** Press the green key to finish.

**5** Connect the USB storage device to your computer.

**6** In your computer, browse to the USB storage device and double-click the 'Update' HTML file.

**7** Follow the on-screen instructions to complete the update.

# 7 Install channels

The first time you setup your TV, you will be prompted to select an appropriate menu language and to perform automatic installation of all TV and digital radio channels (if available). This chapter provides instructions on how to reinstall channels as well as other useful channel installation features.



## Note

- Re-installing channels modifies the **[All channels]** list.

## Automatically install channels

This section describes how to search and store channels automatically. Instructions are for both digital and analogue channels.

### Step 1 Select your menu language



## Note

- Skip to Step 3 if your language settings are correct.

- 1 Press **MENU** on the remote control and select **[TV menu] > [Installation] > [Languages]**.

Installation	Languages
Languages	Menu language
Country	Preferred audio
Time zone	Preferred subtitles
Channel install...	Hearing impaired
Preferences	
Connections	
...	

- 2 Press **▶** to enter the **[Languages]** menu.
- 3 Press **▲** or **▼** to select your language.
- 4 Press **OK** to confirm.

- 5 Press **◀** to return to the **[Installation]** menu.

In addition to menu language, you can configure the following language settings via the **[Languages]** menu (digital channels only):

- **[Preferred audio]**  
Select one of the available audio languages as your preferred audio language (see 'Adjust sound settings' on page 23).
- **[Preferred subtitles]**  
Select one of the available subtitle languages (see 'Select a subtitle language on digital TV channels' on page 33).
- **[Hearing impaired]**  
If available, select **[On]** to display the hearing impaired version of your preferred audio or subtitle language.

### Step 2 Select your country

Select the country where you are located. The TV installs and arranges channels according to your country.



## Note

- Skip to Step 3 if your country settings are correct.

- 1 In the **[Installation]** menu, press **▼** to select **[Country]**.
- 2 Press **▶** to enter the list.
- 3 Press **▲** or **▼** to select your country.
- 4 Press **◀** to return to the **[Installation]** menu.

### Step 3 Select your time zone

This option is only available for countries with different time zones. Skip this step if it is not applicable.

- 1 In the [Installation] menu, press ▼ to select [Time zone].
- 2 Press ► to enter the list.
- 3 Press ▲ or ▼ to select your time zone.
- 4 Press ◀ to return to the [Installation] menu.

## Step 4 Install channels

Your TV searches and stores all available digital and analogue TV channels as well as all available digital radio channels.

- 1 In the [Installation] menu, press ▼ to select [Channel installation].
- 2 Press ► to enter the [Channel installation] menu. [Automatic installation] is highlighted.
- 3 Press ► to select [Start now].
- 4 Press OK.
- 5 Press the green key to start. The installation may take a few minutes.
- 6 When the channel search is completed, press the red key to return to the [Installation].
- 7 Press MENU to exit.



### Tip

- When digital TV channels are found, the list of installed channels may display empty channel numbers. You can rename, reorder or uninstall stored channels (see 'Rearrange channels' on page 999).

## Manually install channels

This section describes how to search and store analogue TV channels manually.

## Step 1 Select your system



### Note

- Skip to Step 2 if your system settings are correct.

- 1 Press MENU on the remote control and select [TV menu] > [Installation] > [Channel installation] > [Analogue: Manual installation].

Channel install...	Analogue: Manual...
Automatic install...	System
Installation update	Search
Digital: Test recept...	Fine tune
Analogue: Manual...	Store current ch...
Rearrange	Store as new ch...

- 2 Press ► to enter the [Channel installation] menu. [System] is highlighted.
- 3 Press ► to enter the [System] list.
- 4 Press ▲ or ▼ to select your country or region.
- 5 Press ◀ to return to the [Channel installation] menu.

## Step 2: Search and store new TV channels

- 1 Press MENU on the remote control and select [TV menu] > [Installation] > [Channel installation] > [Analogue: Manual installation] > [Search].
- 2 Press ► to enter the [Search] menu.
- 3 Press the red key and use the number keys on the remote control to manually enter the three digit frequency. Alternatively, press the green key to automatically search for the next channel.
- 4 Press ◀ when the new channel is found.
- 5 Select [Store as new channel] to store the new channel under a new channel number.



- 6 Press **▶** to enter.
- 7 Press **OK**. **[Done]** appears.
- 8 Press **MENU** to exit.

---

## Fine tune analogue channels

You can manually fine tune analogue channels when reception is poor.

- 1 Press **MENU** on the remote control and select **[TV menu] > [Installation] > [Channel installation] > [Analogue: Manual installation] > [Fine tune]**.
- 2 Press **▶** to enter the **[Fine tune]** menu.
- 3 Press **▲** or **▼** to adjust the frequency
- 4 Press **◀** when done.
- 5 Select **[Store current channel]** to store the fine tuned channel under the current channel number.
- 6 Press **▶** to enter.
- 7 Press **OK**. **[Done]** appears.
- 8 Press **MENU** to exit.

---

## Rename channels

- 1 Press **MENU** on the remote control and select **[TV menu] > [Installation] > [Channel installation] > [Rearrange]**.
- 2 Press **▶** to enter the **[Rearrange]** list.
- 3 Press **▲** or **▼** in the **[Rearrange]** list to select the channel you want to rename.
- 4 Press the red key.
- 5 Press **◀** and **▶** to select characters or **▲** and **▼** to change the characters. Space, numbers (0-9) and other special characters are located between z and A.
- 6 Press the green key or **OK** to finish.



### Tip

- Delete all characters by pressing the yellow key. Delete only the highlighted character by pressing the blue key.

---

## Uninstall or reinstall channels

You can uninstall a stored channel or reinstall an uninstalled channel.

- 1 Press **MENU** on the remote control and select **[TV menu] > [Installation] > [Channel installation] > [Rearrange]**.
- 2 Press **▶** to enter the **[Rearrange]** list.
- 3 Press **▲** or **▼** to select the channel you want to uninstall or reinstall.
- 4 Press the green key to uninstall or reinstall the channel.
- 5 Press **MENU** to exit.

---

## Rearrange channels

- 1 Press **MENU** on the remote control and select **[TV menu] > [Installation] > [Channel installation] > [Rearrange]**.
- 2 Press **▶** to enter the **[Rearrange]** list.
- 3 Press **▲** or **▼** to select the channel you want to rearrange.
- 4 Press the yellow key to move the channel up the list or press the blue key to move the channel down the list.
- 5 Press **MENU** to exit.

---

## Manually update the channel list

If your TV is in standby mode, an update is performed every morning. This update matches channels stored in your channel list with those available from your broadcaster. If a channel is

unavailable, it is automatically removed from the channel list.

In addition to the automatic update, you can manually update the channel list.

- 1 Press **MENU** on the remote control and select **[TV menu] > [Installation] > [Channel installation] > [Installation update]**.
- 2 Press **▶** to enter the **[Installation update]** menu.  
↳ **[Start now]** is highlighted.
- 3 Press **OK**.
- 4 Press the green key to start the update.  
↳ This may take a few minutes.
- 5 When the update is complete, press the red key to return to the **[Channel installation]** menu.
- 6 Press **MENU** to exit.

---

## Test digital reception

If using digital broadcasts, you can check the quality and signal strength of digital channels. This allows you to reposition and test your antenna or satellite dish.

- 1 Press **MENU** on the remote control and select **[TV menu] > [Installation] > [Channel installation] > [Digital:Test reception]**.
- 2 Press **▶** to enter the **[Digital:Test reception]** menu.
- 3 Press **OK**.
- 4 Press the green key to automatically start the test or manually enter the frequency of the channel you want to test.  
↳ If the signal quality and strength are poor, reposition the antenna or satellite dish and retest.
- 5 When complete, press the yellow key to store the frequency.
- 6 Press the red key to return to the **[Channel installation]** menu.

- 7 Press **MENU** to exit.



### Note

- If you have further problems with the reception of your digital broadcast, contact a specialized installer.

---

## Start a demo

- 1 Press the red key on the remote control. Alternatively, press **MENU** on the remote control and select **[TV menu] > [Features] > [Demo]**.
- 2 Press **▶** to enter the **[Demo]** menu.
- 3 Select a demo and press **OK**.
- 4 Press the red key to exit.

---

## Reset TV to factory settings

Resetting your TV to factory settings restores default picture and sound settings. Channel installation settings remain the same.

- 1 Press **MENU** on the remote control and select **[TV menu] > [Installation] > [Factory settings]**.
- 2 Press **▶** to enter the **[Factory settings]** menu. **[Reset]** is highlighted.
- 3 Press **OK** to reset to factory settings.
- 4 Press **MENU** to exit.

# 8 Connect devices

digital receivers, game consoles and other component video devices.

## Connection overview

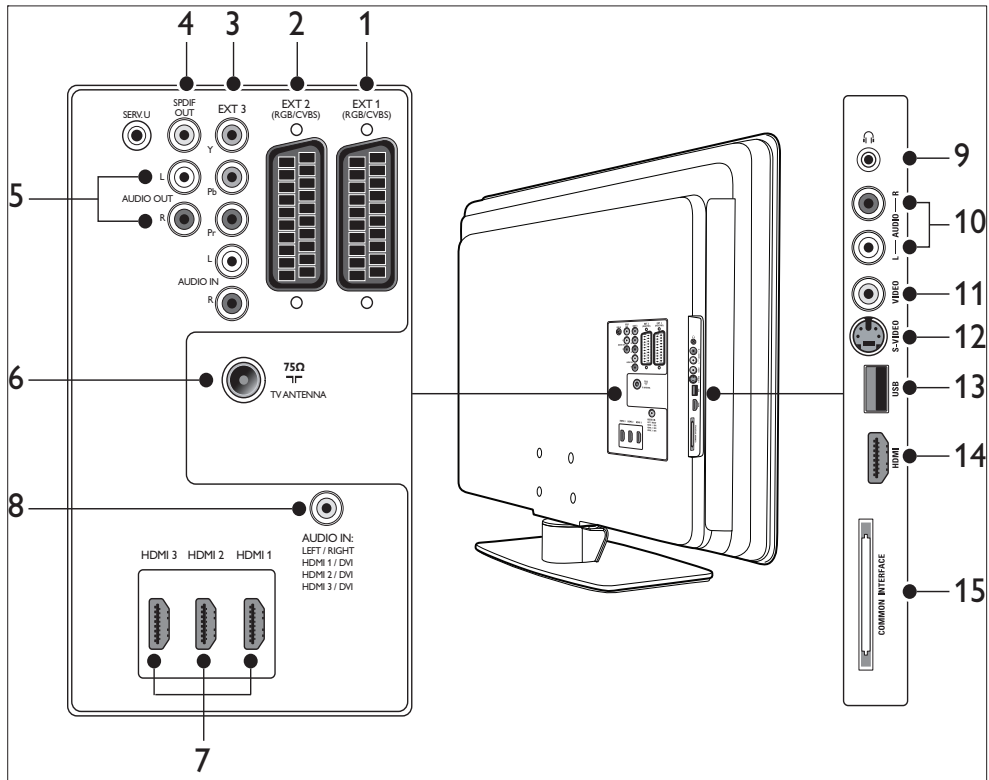

### ④ SPDIF OUT

SPDIF sound output connector for home theatres and other audio systems.

### ① EXT 1

First SCART connector for DVD players, VCRs, digital receivers, game consoles and other SCART devices. Supports Audio L/R, CVBS in/out, RGB.

### ② EXT 2

Second SCART connector. Supports Audio L/R, CVBS in/out, RGB.

### ③ EXT 3

Component video (Y Pb Pr) and Audio L/R input connectors for DVD players,

### ⑤ AUDIO OUT L/R

Sound output cinch connectors for home theatres or other audio systems.

### ⑥ TV ANTENNA

### ⑦ HDMI 1/2/3

HDMI input connectors for Blu-ray Disc players, digital receivers, game consoles and other high-definition devices.

### ≡ Note

- The number of HDMI connectors available may vary according to your TV model.

## ⑧ AUDIO IN

Mini-jack connector for PC audio in (when connecting a PC via a DVI-HDMI adaptor).

### Side connectors

## ⑨ Headphones

Stereo mini-jack.

## ⑩ AUDIO L/R

Audio L/R input connectors for composite and S-Video devices.

## ⑪ VIDEO

Video input cinch connector for composite devices.

## ⑫ S-VIDEO

S-Video input connector for S-Video devices.

## ⑬ USB

USB connector for storage devices.

## ⑭ HDMI

Additional HDMI connector for mobile high-definition devices.

## ⑮ COMMON INTERFACE

Slot for Conditional Access Modules.

---

## Select connection quality

This section describes how you can enhance your audio visual experience by connecting your devices with the best possible connectors. After connecting your devices, be sure to enable them (see 'Setup devices' on page 46).

---

## HDMI - Highest quality

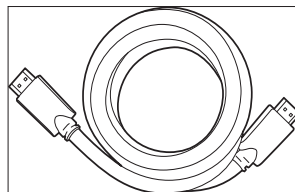

HDMI produces the best audio visual quality possible. Both audio and video signals are combined in one HDMI cable, providing an uncompressed, digital interface between your TV and HDMI devices. You must use HDMI to experience full high-definition video. You must also use HDMI cables to enable Philips EasyLink (see 'Use Philips EasyLink' on page 47).

### ✦ Tip

- If your PC only has a DVI connector, use a DVI-HDMI adaptor to connect your device to a HDMI connector at the back of the TV. You must connect a separate audio cable from the device to the AUDIO IN mini-jack connector.

### ≡ Note

- Philips HDMI supports HDCP (Highbandwidth Digital Contents Protection). HDCP is a form of Digital Rights Management that protects high definition content in DVD or Blu-ray Discs.

---

## Component (Y Pb Pr) - Higher quality

Component (Y Pb Pr) video provides better picture quality than S-Video or composite video connections. Though component video supports high-definition signals, picture quality is lower than HDMI and is analogue. When connecting a component video cable, match the cable colours to the EXT 3 connectors on the back of the TV. Also, connect a Audio L/R cable to the red and white Audio L/R input connectors at EXT 3.

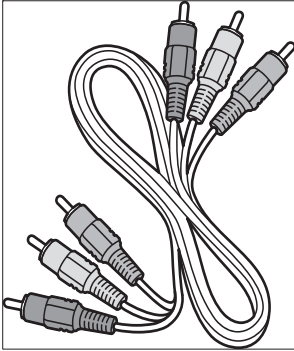

Component video cable - Red, Green, Blue

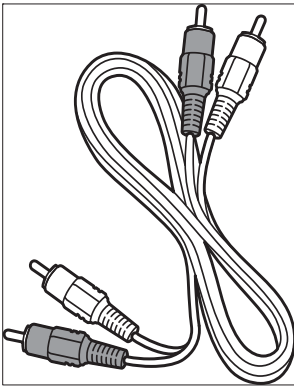

Audio L/R cable - Red, White

### SCART - Good quality

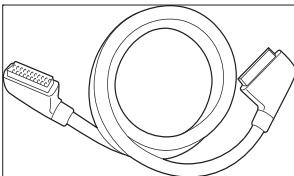

SCART combines audio and video signals in one cable. Audio signals are stereo, while video signals can be composite or S-Video quality. SCART does not support high-definition video and is analogue. Two SCART connectors are provided on the TV, EXT 1 and EXT 2.

### S-Video - Good quality

An analogue connection, S-Video provides better picture quality than composite video. When connecting your device with S-Video, plug the S-Video cable to the S-Video connector on the side of the TV. You must connect a separate Audio L/R cable from the device to the red and white Audio L/R connectors on the side of the TV.

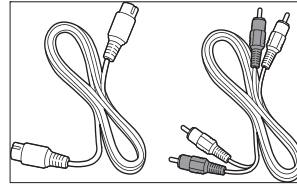

S-Video cable and Audio L/R cable (Red, White)

### Composite - Basic quality

Composite video provides basic analogue connectivity, usually combining a (yellow) video cinch cable with (red and white) Audio L/R cinch cable. Match the cable colours when connecting to the composite Video and Audio L/R input connectors on the side of the TV.

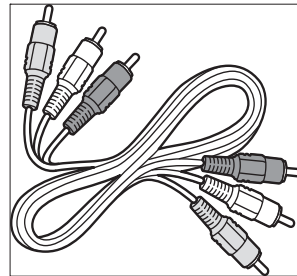

Composite audio/video cable - Yellow, red and white

## Connect devices

This section describes how to connect various devices with different connectors and

supplements examples provided in the Quick Start Guide.

**Caution**

- Disconnect the mains cord cable before connecting devices.

**Note**

- Different types of connectors may be used to connect a device to your TV, depending on availability and your needs.

### Blu-ray disc player

For full high-definition video, connect a HDMI cable as illustrated:

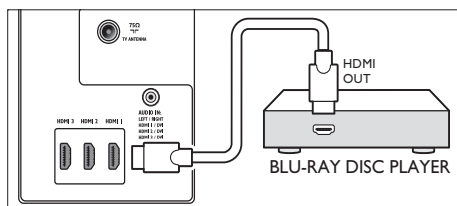

### DVD player

For DVD video, connect a SCART cable as illustrated:

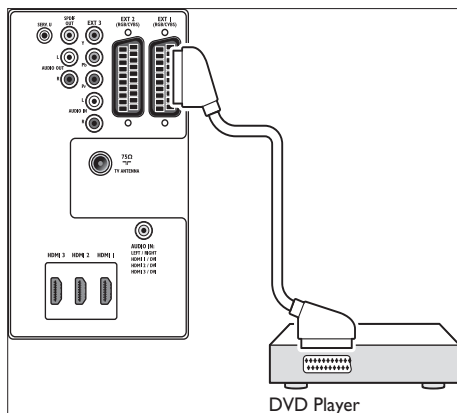

### Satellite receiver

To receive analogue channels via antenna and digital channels via a satellite receiver; connect an antenna cable and SCART cable as illustrated:

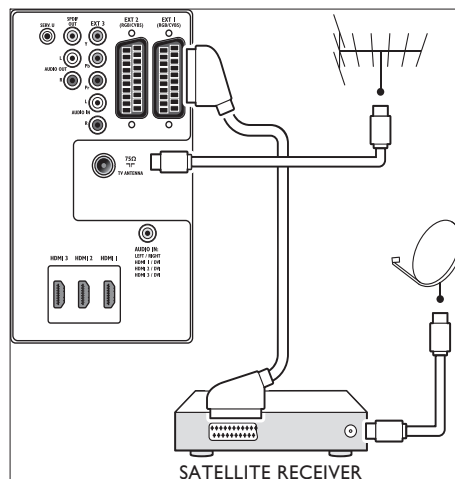

### HD digital receiver

To receive analogue channels via antenna and digital channels via a HD digital receiver; connect two antenna cables and HDMI cable as illustrated:

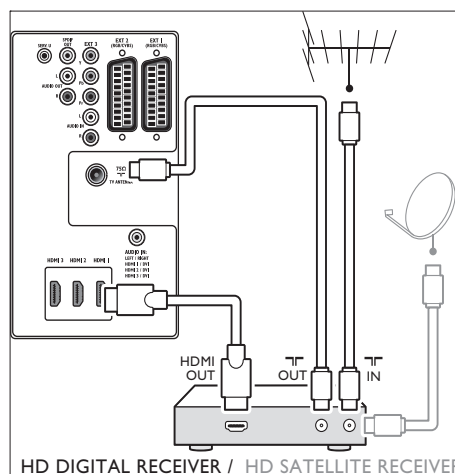

## Combined DVD recorder and digital receiver

To receive analogue channels via antenna and record programs on a combined DVD recorder and digital receiver, connect two antenna cables and one SCART cable as illustrated:

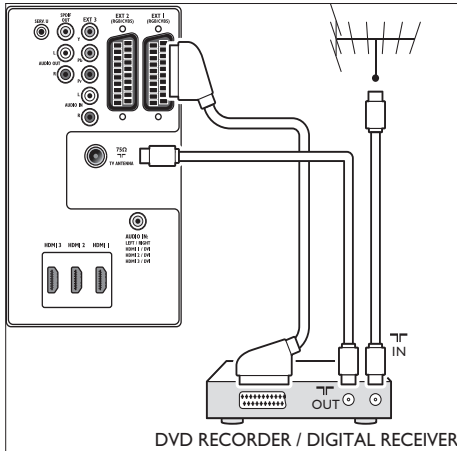

## DVD recorder and home theatre system

To receive analogue channels via antenna, output sound to a home theatre system and record programmes on a DVD recorder, connect two antenna cables, one SCART cable and two digital audio cables as illustrated:

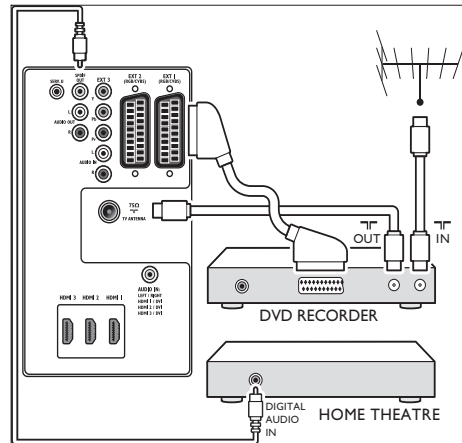

## Separate DVD recorder and receiver

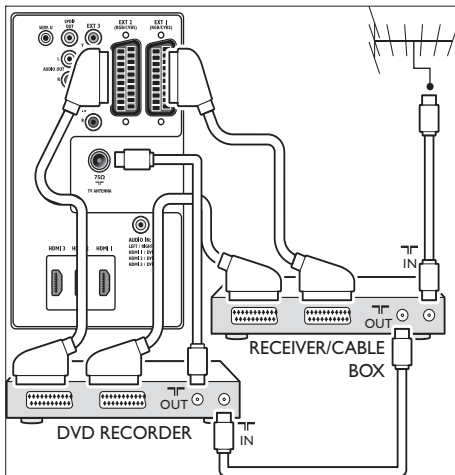

To receive analogue channels via antenna and record programmes on a separate DVD recorder and receiver, connect three antenna cables and three SCART cables as illustrated:

### Note

- If using a home theatre or other audio system, the best synchronization between images and sound is achieved by connecting the audio signal from your playback device to the TV first. Subsequently, channel the audio signal to the home theatre system or audio device via the audio connectors on the back of the TV.

## Game console or camcorder

The most practical connection for a mobile game console or camcorder may be at the side of the TV. You can, for example, connect the game console or camcorder to VIDEO/S-Video and AUDIO L/R connectors at the side of the TV. A HDMI connector is also available for high-definition devices.

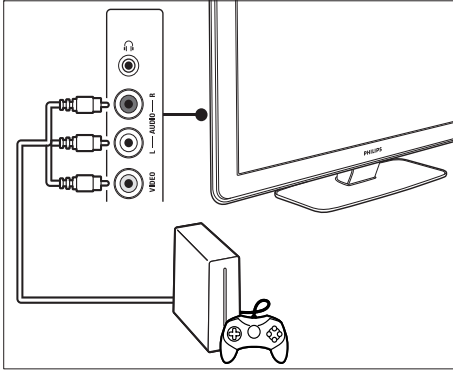

A permanent game console or camcorder can be connected to a HDMI connector or EXT 3 (component) connectors at the back of the TV.

## Personal computer

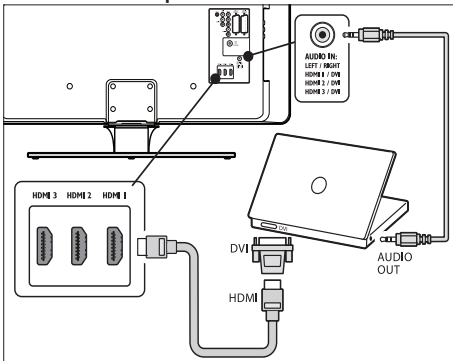

### Before connecting the PC:

- Set the PC monitor refresh rate to 60Hz.
- Change the TV picture format to [Unscaled].

### To connect a PC to the back of the TV

- 1 Using a HDMI to DVI cable or a HDMI-to-DVI adaptor (attached to a HDMI cable), connect a HDMI connector on the back of your TV to the DVI connector on your PC.
- 2 Connect an audio cable from your PC to the AUDIO IN mini-jack connector at the back of the TV.
- 3 Assign the AUDIO IN mini-jack connector to the HDMI connector (see 'Adding the

AUDIO-IN mini-jack connector' on page 47).

## Setup devices

When all devices are connected, you must select the type of device attached to each connector.

### Assign devices to connectors

For easy selection and best signal handling, assign the device connected to the connectors on your TV.

- 1 Press **MENU** on the remote control and select [TV menu]TV menu > [Installation]nstallation > [Connections].

Connections	EXT 1
EXT 1	None
EXT 2	DVD
EXT 3	Blu-ray
HDMI 1	HDD/DVDR
HDMI 2	HD rec.
HDMI 3	Game
Side	VCR

- 2 Press **▶** to enter the list.
- 3 Press **▼** or **▲** to select a connector.
- 4 Press **▶** to enter the list.
- 5 Press **▼** or **▲** to select the device attached to the connector.
- 6 Press **OK** to select the device.
- 7 Repeat the procedure until all devices are correctly assigned to connectors.
- 8 Press **MENU** to exit.



## Adding the AUDIO-IN mini-jack connector

If you connect audio from a PC to the AUDIO IN mini-jack connector at the back of the TV, you must associate it to the HDMI connector.

- 1 Press **MENU** on the remote control and select **[TV menu] > [Installation] > [Connections] > [Audio In L/R]**.

Connections	AUDIO IN L/R
...	None
EXT 3	HDMI 1
HDMI 1	HDMI 2
HDMI 2	HDMI 3
HDMI 3	
Side	
<b>AUDIO IN L/R</b>	

- 2 Press **▶** to enter the list.
- 3 Press **▲** or **▼** to select the HDMI connector used by the PC.
- 4 Press **MENU** to exit.

## Assign a channel decoder

Decoders that decode digital channels can be connected to EXT 1 or EXT 2 (SCART). You have to assign the TV channel as a channel to be decoded. Then assign the connection where the decoder is connected.

- 1 Press **MENU** on the remote control and select **[TV menu] > [Installation] > [Decoder] > [Channel]**.
- 2 Press **▶** to enter the list.
- 3 Press **▲** or **▼** to select the channel to decode.
- 4 Press **◀** and go back to select **[Status]**.
- 5 Press **▲** or **▼** to select the connector used by the decoder.
- 6 Press **MENU** to exit.

## Use Philips EasyLink

Your TV supports Philips EasyLink, which enables one-touch play and one-touch standby between EasyLink-compliant devices. Compliant devices must be connected to your TV via HDMI and assigned.

### Enable or disable Easylink

- 1 Press **MENU** on the remote control then select **[TV menu] > [Installation] > [Preferences] > [EasyLink]**.
- 2 Select **[On]** or **[Off]**.

### Use one-touch play

- 1 After enabling EasyLink, press play on your device.
  - ↳ The TV automatically switches to the correct source.

### Use one-touch standby

- 1 Press and hold **⏻ Standby** on the TV or device remote control for at least three seconds.
  - ↳ The TV and all connected HDMI devices switch to standby.

## Prepare TV for digital services

Scrambled digital TV channels can be decoded with a Conditional Access Module (CAM) and a Smart card provided by a digital TV service operator.

The CAM may enable several digital services, depending on the operator and services you choose (for example, pay TV). Contact your digital TV service operator for more information about services and terms.

## Use the Conditional Access Module

### ! Caution

- Switch off your TV before inserting a CAM. Be sure to follow the instructions described below. Wrong insertion of a CAM may damage both the CAM and your TV.

- 1 Following the directions printed on the CAM, gently insert the CAM into the Common Interface on the side of the TV.

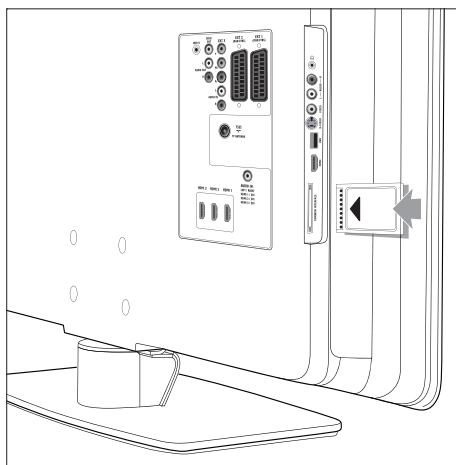

- 2 Push the CAM in as far as it will go.

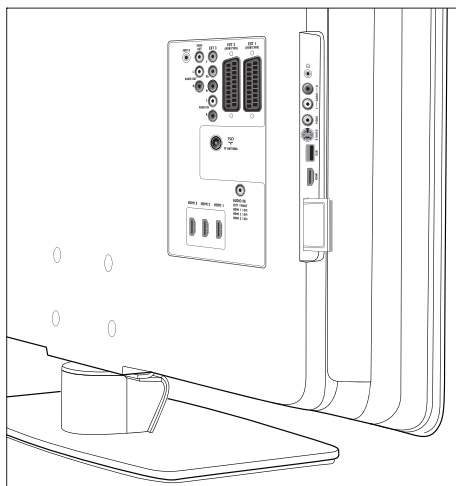

- 3 Turn on the TV and wait for the CAM to be activated. This may take several minutes.

### ≡ Note

- Do not remove the CAM from the slot. Removing the CAM will deactivate the digital services.

## Access CAM devices

- 1 After inserting and activating the CAM, press **MENU** on the remote control and select **[TV menu] > [Features] > [Common interface]**.

This menu option is only available if the CAM is correctly inserted and activated. On-screen applications and content are provided by your digital TV service operator.

# 9 Technical specifications

## Product specifications- Supported display resolutions

### Computer formats

- Resolution - refresh rate:
  - 640 x 480 - 60Hz
  - 800 x 600 - 60Hz
  - 1024 x 768 - 60Hz
  - 1920 x 1080i - 60Hz
  - 1920 x 1080p - 60Hz

### Video formats

- Resolution - refresh rate:
  - 480i - 60Hz
  - 480p - 60Hz
  - 576i - 50Hz
  - 576p - 50Hz
  - 720p - 50Hz, 60Hz
  - 1080i - 50Hz, 60Hz
  - 1080p - 24Hz, 25Hz, 30Hz
  - 1080p - 50Hz, 60Hz

## Tuner/Reception/ Transmission

- Antenna input: 75ohm coaxial (IEC75)
- TV system: DVB COFDM 2K/8K
- Video playback: NTSC, SECAM, PAL
- DVB Terrestrial (see listed countries on the back of the TV)

## Multimedia

- Connection: USB
- Playback formats: MP3, Linear PCM, slide show (.alb), JPEG

## Remote control

- Type: RC4450
- Batteries: 2 x AA size

## Connections (Rear)

- EXT 1 (SCART): Audio L/R, CVBS in/out, RGB
- EXT 2 (SCART): Audio L/R, CVBS in/out, RGB
- EXT 3: Component (Y Pb Pr), Audio L/R in
- HDMI 1/2/3



### Note

- The number of HDMI connectors available may vary according to your TV model.

- SPDIF OUT: Digital audio out (coaxial cinch-S/PDIF). Display synchronized.
- AUDIO OUT L/R: Analogue audio out.
- TV ANTENNA
- AUDIO IN: Mini-jack audio in for PC DVI/ HDMI connections.

## Connections (Side)

- Headphone out (stereo mini-jack)
- AUDIO L/R in
- Video (CVBS) in
- S-Video
- USB
- HDMI
- Common Interface (CAM slot)

## Power

- Mains power: AC 220-240V ( $\pm 10\%$ )
- Power and standby power consumption: See technical specifications at [www.philips.com](http://www.philips.com)
- Ambient temperature: 5°C - 35°C
- Specifications are subject to change without notice. For detailed specifications of this product go to [www.philips.com/support](http://www.philips.com/support).

# 10 Troubleshooting

This section describes commonly-encountered issues and accompanying solutions.

## General TV issues

### The TV does not switch on:

- Unplug the mains cable, wait for one minute and plug into the mains again.
- Verify that the mains cable is properly connected and that the mains are powered.

### The remote control is not working properly:

- Verify that the remote control batteries are correctly inserted according to the +/- orientation.
- Replace the remote control batteries if they are flat or weak.
- Clean the remote control and TV sensor lens.

### The standby light on the TV blinks red:

- Turn off the TV and unplug the mains cable. Wait until the TV cools down before reinserting the mains cord and turning on the TV. If the blinking occurs again, contact your Customer Support Centre.

### You forgot your code to unlock Child lock

- Enter '8888' (see 'Lock TV channels or connected devices (Child lock)' on page 31).

### The TV menu is in the wrong language

- Change the TV menu to your preferred language (see 'Step 1 Select your menu language' on page 37).

### When turning the TV on/off/to standby, you hear a creaking sound from the TV chassis:

- No action is required. The creaking sound is normal expansion and contraction of the TV as it cools down and warms up. This does not impact performance.

## TV channel issues

### Previously installed channels do not appear in the channel list:

- Verify that the correct list is selected.
- The channel may have been uninstalled to the [Rearrange] menu. To access the menu, press **MENU** on the remote control and select [TV menu] > [Installation] > [Channel installation] > [Rearrange].

### No digital channels were found during the installation:

Verify if the TV supports DVB-T in your country. See the listed countries on the back of the TV.

## Sound issues

### There is a picture but sound quality is poor:



#### Note

- If no audio signal is detected, the TV automatically switches off audio output and does not indicate malfunction.

- Check that all cables are properly connected.
- Check that the volume is not set to 0.
- Check that the sound is not muted.

### There is picture but sound quality is poor:

Check [Sound] settings, verifying that [Stereo] is selected and [Equalizer] settings are correct. If needed, try resetting audio settings to [Standard].

### There is a picture but sound comes from one speaker only:

Verify that [Balance] is correctly set.

## Picture issues

### LightGuide is on, but there is no picture:

- Verify if the antenna is connected properly.
- Verify if the correct device is selected.

### There is sound but no picture:

- Verify that picture settings are correctly set (see 'Adjust picture settings' on page 20).

#### **You receive poor TV reception from an antenna connection:**

- Check that the antenna is properly connected to the TV.
- Loudspeakers, unearthened audio devices, neon lights, high buildings or mountains can influence the picture quality. Try to improve the reception quality by changing the antenna direction or moving devices away from the TV.
- Verify if the correct TV system is selected for your region (see 'Step 1 Select your system' on page 38).
- If reception on only one channel is poor; try to fine tune this channel. (see 'Fine tune analogue channels' on page 39)

#### **You receive poor picture quality from connected devices:**

- Check that the devices are connected properly. Also, be sure to assign devices to connectors (see 'Assign devices to connectors' on page 46), as described in Section 7.4.1 Assign devices to connectors.
- Verify that picture settings are correctly set (see 'Adjust picture settings' on page 20).

#### **The TV did not save my settings:**

- Verify that the TV is set to Home mode, which offers you complete flexibility to change settings (see 'Change to Shop or Home mode' on page 26).

#### **The picture does not fit the screen, it is too big or too small:**

- Try using a different picture format.
- Assign your device to connectors (see 'Assign devices to connectors' on page 46).

#### **The picture position on screen is not correct:**

Picture signals from some devices do not fit the screen correctly. Check the signal output of the device.

---

## HDMI connection issues

You encounter problems with HDMI devices

- HDCP support can delay the time taken for a TV to display content from a device.
- If the TV does not recognise the device and the screen does not display a picture, try switching from one device to another and back again to restart.
- If you experience intermittent sound disruptions, check the user manual of the HDMI device to verify that output settings are correct. Alternatively, try connecting the audio signal from the HDMI device to the TV via AUDIO IN at the back of the TV.
- If a HDMI-to-DVI adaptor or HDMI to DVI cable is used, check that an additional audio cable is connected to AUDIO IN. You must also assign the audio connector.

---

## USB connection issues

#### **The TV does not display the USB device content:**

- Set your device to 'Mass Storage Class' compliant, as described in your device documentation.
- Your USB device may not be compatible with the TV.
- Not all audio and picture files are supported (see 'Technical specifications' on page 49).

#### **Audio and picture files do not play or display smoothly**

- The transfer performance of the USB device may limit the transfer rate.

---

## PC connection issues

#### **The PC display on my TV is not stable or is not synchronised:**

Check that a supported resolution and refresh rate is selected on your PC. (see 'Technical specifications' on page 49)

---

## Contact us

If you cannot resolve your problem, refer to the FAQ for this TV at [www.philips.com/support](http://www.philips.com/support). If the problem remains unresolved, contact the Customer Support Centre in your country as listed in this user manual.



### Warning

- Do not attempt to repair the TV yourself. This may cause severe injury, irreparable damage to your TV or void your warranty.



### Note

- Please have your TV model and serial number available before contacting us. These numbers are available on the back and side of your TV, as well as on the packaging.

# Information about how to re-tune your TV during the digital TV switchover.

**Keep this user manual safe – you'll need it.**

.....

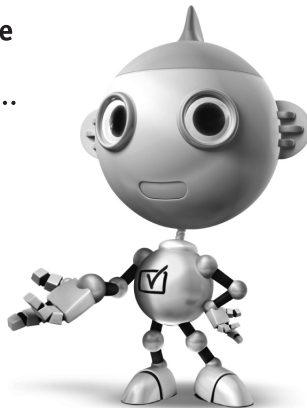

Television in the UK is going digital, bringing us all more choice and new services. Starting in late 2007 and ending in 2012, television services in the UK will go completely digital, TV region by TV region.

Please see the next page to find out when your area switches to digital.

Digital UK is the independent, non-profit organisation leading the process of digital TV switchover in the UK. Digital UK provides impartial information on what people need to do to prepare for the move to digital, and when they need to do it.

## How the switchover affects your TV equipment:

Your new TV has a digital tuner built in, which means it is ready to receive the Freeview signal by simply plugging it into your aerial socket (check if you can get digital TV through your aerial now, or whether you'll have to wait until switchover, at [www.digitaluk.co.uk](http://www.digitaluk.co.uk)).

When the TV switchover happens in your area, there are at least two occasions when you will need to re-tune your TV in order to continue receiving your existing TV channels, and also to pick up new ones.

**get set for digital** 

Digital UK, the body leading the digital TV switchover, will advise you when you need to re-tune during the switchover.

If you choose to connect your TV to satellite or cable with a digital box then it will not be affected by switchover, and you won't need to re-tune.

If you have any questions, please contact your equipment supplier or call Digital UK on ... 0845 6 50 50 50 or visit [www.digitaluk.co.uk](http://www.digitaluk.co.uk)

## How to re-tune:

To find out how to re-tune your TV, check this user manual for details.

Go to section **6 Install channels**.

If you do not re-tune your channels when advised to do so by Digital UK, you may lose some or all of your channels until you do re-tune. You should re-tune your TV every few months to check for any new channels.

If you are missing any channels, it may be that they are not available in your area, or that your aerial needs upgrading.

## When does switchover happen?

\*Copeland switches on October 17, 2007

The exact date you switch depends on the transmitter you are served by. To check when you switch, go to Digital UK's postcode checker on [www.digitaluk.co.uk](http://www.digitaluk.co.uk)

Check your ITV news service or look at Teletext page 106 to see what TV region you're in.

Visit us at [digitaluk.co.uk](http://digitaluk.co.uk)  
Call us on 0845 6 50 50 50†

† Calls charged at BT rate of 3p per minute daytime and 1p per minute evenings and weekends. Rates may vary for calls from non-BT lines.







© 2008 Koninklijke Philips Electronics N.V.  
All rights reserved.  
Document order number: 3139 125 40432



## Free Manuals Download Website

<http://myh66.com>

<http://usermanuals.us>

<http://www.somanuals.com>

<http://www.4manuals.cc>

<http://www.manual-lib.com>

<http://www.404manual.com>

<http://www.luxmanual.com>

<http://aubethermostatmanual.com>

Golf course search by state

<http://golfingnear.com>

Email search by domain

<http://emailbydomain.com>

Auto manuals search

<http://auto.somanuals.com>

TV manuals search

<http://tv.somanuals.com>