

PHILIPS

FB 206W Wireless Surround Loudspeaker System

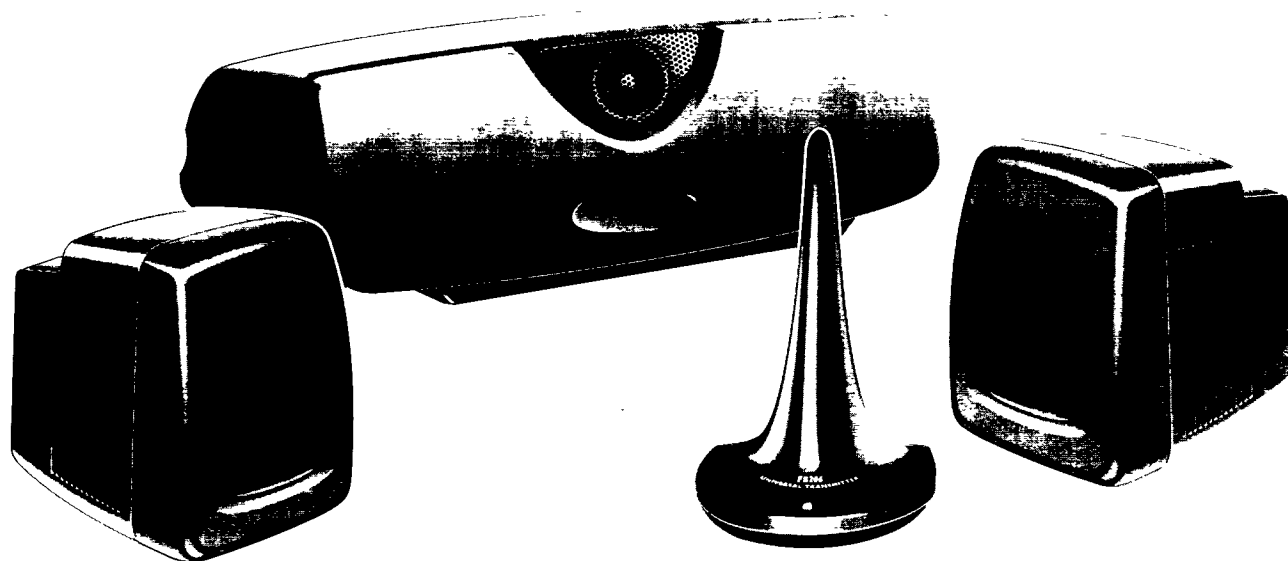

Instructions for use
Mode d'emploi
Instrucciones de manejo
使用説明書



PHILIPS

Guarantee and Service valid for Australia

The benefits given to the purchaser by this warranty are in addition to all other rights and remedies, which, under the Trade Practices Act or other Commonwealth or State law, the purchaser or owner has in respect of the product.

The Philips product carries the following warranties:

- C-series HiFi-systems 12 months.
- Compact Disc Players: 12 months.
- Home Audio Systems: 6 months.
- Clock radios, portable radios, cassette recorders, cassette players and radio recorders: 90 days.

Any defect in materials or workmanship occurring within the specified period from the date of delivery, will be rectified free of charge by the retailer from whom this product was purchased.

Note: Please retain your purchase docket to assist prompt service.

Conditions of this warranty

1. All claims for warranty service must be made to the retailer from whom this product was purchased. All transport charges incurred in connection with warranty service or replacement will be paid by the purchaser.
2. These warranties do not cover batteries and extend only to defects in materials or workmanship occurring under normal use of the product where operated in accordance with our instructions.

**Philips Consumer Products Division
Technology Park
Figtree Drive, Australia Centre
Homebush 2140
New South Wales**

Guarantee and Service for New Zealand

Thank-you for purchasing this quality Philips product. Philips New Zealand Ltd guarantees this product against defective components and faulty workmanship for a period of 12 months. Any defect in materials or workmanship occurring within 12 months from the date of purchase subject to the following conditions will be rectified free of charge by the retailer from whom this product was purchased.

Conditions

1. The product must have been purchased in New Zealand. As proof of purchase, retain the original sales docket indicating the date of purchase.
2. The guarantee applies only to faults caused by defective components, or faulty workmanship on the part of the manufacturer.
3. The guarantee does not cover failures caused by misuse, neglect, normal wear and tear, accidental breakage, use on the incorrect voltage, use contrary to operating instructions, or unauthorised modification to the product or repair by an unauthorised technician.
4. Reasonable evidence (in the form of a sales docket) must be supplied to indicate that the product was purchased no more than 12 months prior to the date of your claim.
5. In the event of a failure, Philips shall be under no liability for any injury, or any loss or damage caused to property or products other than the product under guarantee.

This guarantee does not prejudice your rights under common law and statute, and is in addition to the normal responsibilities of the retailer and Philips.

How to claim

Should your Philips product fail within the guarantee period, please return it to the retailer from whom it was purchased. In most cases the retailer will be able to satisfactorily repair or replace the product.

However, should the retailer not be able to conclude the matter satisfactorily, or if you have other difficulties claiming under this guarantee, please contact

**The Guarantee Controller
Philips New Zealand Ltd.**

✉ P.O. Box 41.021

Auckland

☎ (09) 84 94 160

Fax (09) 84 97 858

Garantía para México

Este aparato está fabricado con materiales de alta calidad y ha sido cuidadosamente verificado. Philips, por lo tanto, da a usted una garantía de 12 meses a partir de su fecha de compra.

La garantía ampara la reposición de las piezas defectuosas debidas a fallas en su montaje o en los materiales, incluyendo la mano de obra necesaria para su reemplazo en nuestras Sucursales o talleres autorizados.

En caso de fallas en su aparato le rogamos se sirva poner en contacto con su distribuidor.

Esta garantía no cubrirá las averías que resulten como consecuencia de una instalación incorrecta del aparato, manifiesto maltrato o uso inadecuado del mismo.

Philips se obliga a reparar y devolver a usted su aparato en un plazo no mayor de 30 días hábiles contados a partir de la fecha de haber ingresado su aparato a uno de nuestros talleres.

Para que esta garantía sea válida, es necesario que el certificado que figura en la parte posterior de este instructivo haya sido debidamente llenado en el momento de la compra del aparato.

En caso de extravío del certificado con la presentación de la factura o remisión de su aparato podrá hacer efectiva la garantía correspondiente.

Si usted tiene alguna duda o pregunta que no le pueda solucionar su distribuidor, por favor ponerse en contacto con:

**Oficinas Centrales de Servicio,
Av. Coyoacán No. 1051,
Col. del Valle,
03100 México, D.F.**



☎ 5-75-20-22 o 5-75-01-00

English	4	English
Français.....	10	Français
Español	16	Español
中文.....	22	中文

México

NOM

Es necesario que lea cuidadosamente su instructivo de manejo.

	PRECAUCIÓN - ADVERTENCIA	
	No abrir, riesgo de choque eléctrico	
ATENCIÓN		
Verifique que el voltaje de alimentación sea el requerido para su aparato		
Para evitar el riesgo de choque eléctrico, no quite la tapa. En caso de requerir servicio, dirijase al personal calificado.		

EQUIPMENT SUPPLIED

English

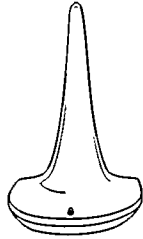

Transmitter unit

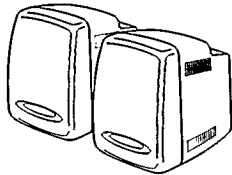

2 Surround speakers

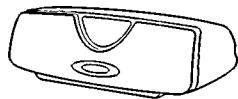

Centre speaker

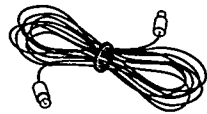

Cinch cable

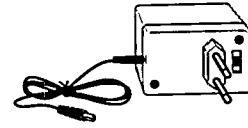

AC/DC adapter



Mains cable for active speaker



Loudspeaker cable

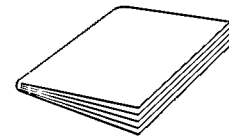

Instructions for use

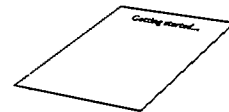

"Getting Wireless" card

Environmental information

All redundant packing material has been omitted. We have done our utmost to make the packaging easy separable into three mono materials: cardboard (box), polystyrene foam (buffer) and polyethylene (bags, protective foam sheet).

Your set consists of material which can be recycled if disassembled by a specialized company. Please observe the local regulations regarding the disposal of packing materials, exhausted batteries and old equipment.

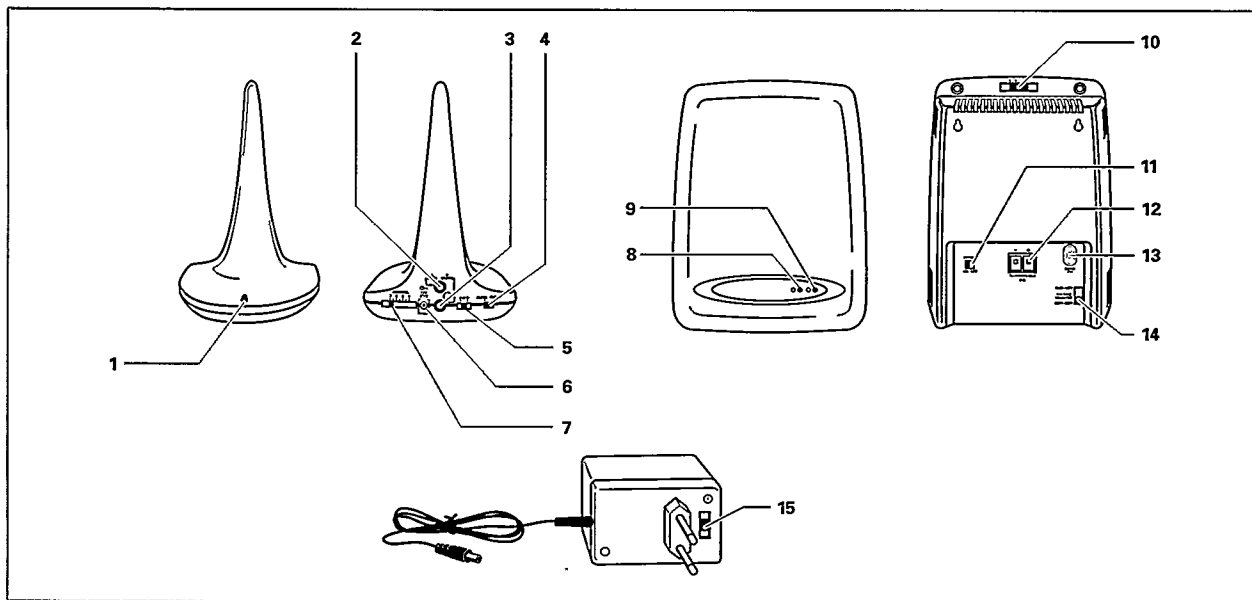

Transmitter unit

- 1 Status light.....**RED:** Transmitter is on.
BLINKING: Transmitter is on and input level is too high (see 5).
OFF: Transmitter is in standby mode or not connected to the AC/DC adapter.
- 2 L (SUB)Not used with the delivered configuration.
- 3 R (SURR)To connect the transmitter unit to the SURROUND OUT (SURR PRE OUT) of your set.
- 4 SURR / MULTISet this selector to SURR, the position MULTI is not used with the delivered configuration.
- 5 A·B·C.....To set the input sensitivity of the transmitter unit.
A: maximum sensitivity
B: medium sensitivity
C: minimum sensitivity
- 6 14 VTo connect the transmitter unit to the AC/DC adapter provided.
- 7 CHANNEL7 step channel selector for setting the transmitting channel in case of interferences.

Note: – Always be sure that the transmitter unit and the active surround speaker are switched to the same transmitting channel, otherwise no sound or only a distorted sound will be heard on the surround speakers.

– You have to switch off the active surround speaker before setting the transmitting channel.

Active surround speaker

- 8**GREEN LIGHT:** If this is on, the active speaker is on.
- 9**RED LIGHT:** If this is on, the active speaker is in standby mode.

Note: – If both lights are off the active speaker is switched off or not connected to the mains.

- 10 CHANNEL7 step channel selector for setting the transmitting channel in case of interferences.
- 11 POWER.....To switch the active surround speaker on and off.
- 12 TO PASSIVE BOXTo connect the active surround speaker to the passive surround speaker.

Important!

Do not connect any amplifier or set to the "TO PASSIVE BOX" output!

- 13 MAINSTo connect the active surround speaker to the mains.
- 14 VOLTAGE SELECTOR.....(Not on all versions) Set this selector to your local mains voltage. If the selector must be reset, disconnect the mains lead first.

AC/DC adapter

- 15 VOLTAGE SELECTOR.....(Not on all versions) Set this selector to your local mains voltage. If the selector must be reset, disconnect the mains lead first.

CONNECTIONS

English

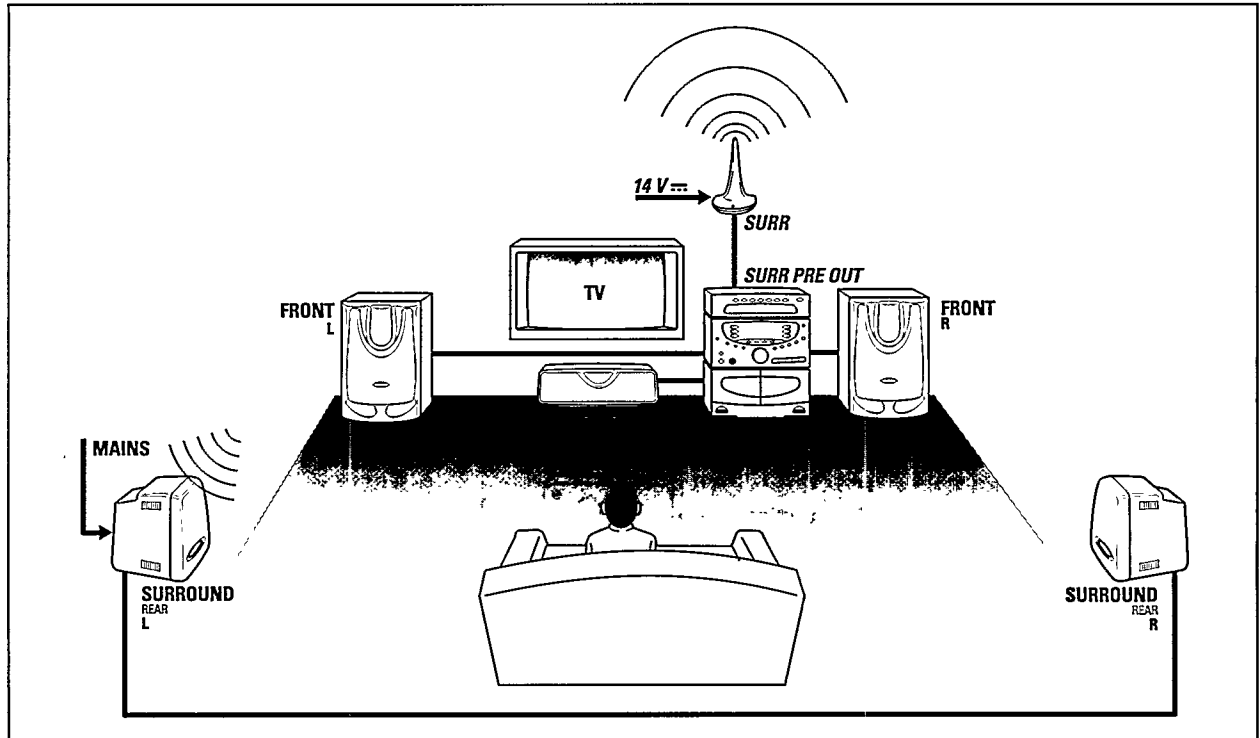

Important!
Always switch off all your equipment before making any connections!

For connecting your wireless speaker system refer to the picture above.

The loudspeaker connections on the appliance may be screw connectors or click-fit connectors.

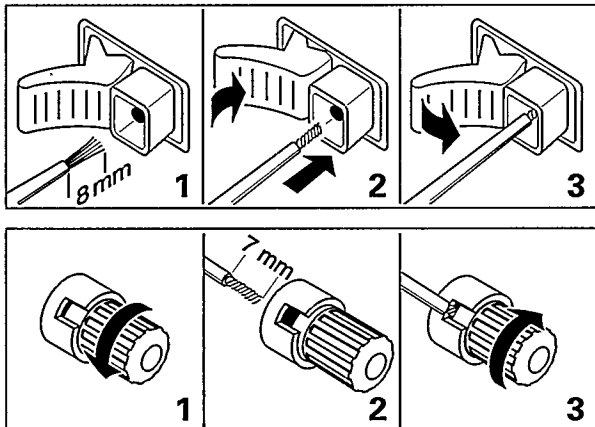

At the rear of the appliance you will find a coloured or ⊕ terminal and a black or ⊖ terminal for each speaker.

Note: – After connecting all the speakers, do not forget to adjust the relative sound level between them.

Front speakers (not included) and centre speaker
Connect the coloured speaker wire to the coloured or ⊕ terminal, and the black wire to the black or ⊖ terminal of the appliance.

Surround speakers
Your wireless speaker system includes two different surround speakers. One is the active surround speaker; the other one is the passive surround speaker. You can identify the active speaker by the controls on the rear.

Connect the active to the passive speaker with the speaker cable provided. Connect the coloured wire to the coloured terminal, and the black wire to the black terminal on both speakers. Connect the active speaker to the mains with the mains cable provided. Switch on the active speaker with the POWER switch.

Transmitter unit
Connect the SURRE terminal of the transmitter unit with the PRE OUT (SURROUND) terminal of the appliance using the supplied cinch cable. Connect the AC/DC adapter supplied to the 14 V socket of the transmitter unit. Then connect the AC/DC adapter to the mains.

Note: – The SUB terminal of the transmitter unit is not used with this set.

Positioning of the transmitter unit

Position the unit in a way that you are able to "see" the active surround speaker from the position of the unit.

To avoid sound distortions caused by magnetic fields do not place the transmitter unit on your TV set.

Positioning of the speakers

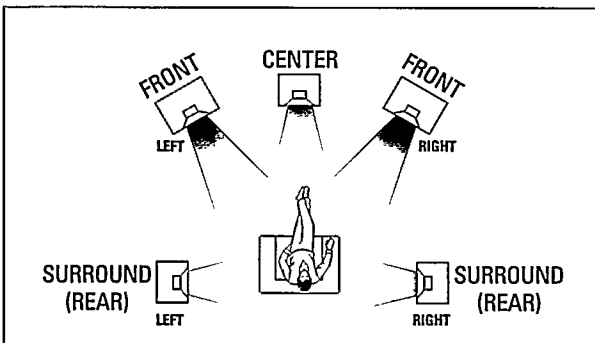

Important!

To avoid overheating do not cover any vents and leave a minimum distance of 5 centimeters (2 inches) for ventilation.

General hints for positioning

Avoid positioning the speakers in a corner or on the floor, as this will boost the bass tones too much. Placing the speakers behind curtains, furniture etc. will reduce the treble response, thus reducing the stereo effect considerably. The listener should always be able to "see" the speakers.

Each room has different acoustic characteristics and the positioning possibilities are often limited. You can find the best position for your speakers by following the picture above. The speakers should always be arranged as symmetrically as possible in the room.

Positioning the centre speaker

The centre speaker should be placed in the centre between both front speakers, e. g. underneath or on top of the TV. The best height for the centre speaker is at the height of the listener's ears (while seated).

Positioning the surround speakers

The surround speakers should face each other and be in line with, or at most 1.5m (4ft 6ins) behind the listener.

Adjusting the relative sound level

After installing your speakers, you will have to find a good sound balance between the surround, the centre and the front speakers.

In the instruction booklet of your appliance you will find a section describing how to adjust the sound of the different speakers. Follow those instructions to get the most out of your new PHILIPS speakers.

Setting the input sensitivity A-B-C

Depending on which sound source you use, the signals delivered have different strengths.

If the red light on the front of the transmitter unit **starts to blink**, the incoming signal is too strong. This will cause distortions! Set the A-B-C switch to adjust the input sensitivity to a lower level. If the red light on the front of the transmitter unit **goes off** during play, the incoming signal is not strong enough. Set the A-B-C switch to adjust the input sensitivity to a higher level.

Setting the transmitting channel

In case of interferences of the signal from the transmitter unit it is possible to shift to another transmitting channel.

- 1 Switch off the active surround speaker.
- 2 Set the CHANNEL slide at the back of the transmitter unit to another number.
- 3 Set the CHANNEL slide at the back of the active surround speaker to the same number as on the transmitter.
- 4 Switch on the active surround speaker.

Note: – Always be sure that the transmitter unit and the active surround speaker are switched to the same transmitting channel, otherwise no sound or only a distorted sound will be heard on the surround speakers.

Switching On-Standby-Off

The transmitter unit is equipped with a sensitive input. If there is no signal on the SUB and SURR input the transmitter and the surround speakers will switch to standby after approximately 100 seconds.

The green light on the front of the active surround speaker shows that the speaker is on. If the red light is on, the speaker has switched to standby. To switch the active speaker off, use the POWER switch.

If the red light on the front of the transmitter is off, it has switched to standby. To switch the transmitter off, unplug the AC/DC adapter from the mains.

Power handling

Any amplifier or receiver used at high power can produce distortions which may seriously damage your speakers. If distortion occurs, reduce the volume and the tone control to a level where the sound is acceptable again.

When using microphones, avoid feedback which occurs when a microphone picks up sound from the speakers, resulting in a howling noise. Keep the microphone away from the speakers or reduce the volume.

Maintenance

A chamois leather slightly moistened with water is sufficient for cleaning the speaker cabinet. Do not use cleaning agents containing alcohol, spirits, ammonia or abrasives.

Do not leave the speakers for a long time in direct sunlight or other places where high temperatures can occur.

Do not expose the speakers to humidity or rain.

More wireless products...

The transmitter is also equipped to drive an optional wireless subwoofer, wireless stereo loudspeakers or wireless headphones.

Please ask your dealer for this products, and refer to the bypacked instructions enclosed for setting up your transmitter for use with them.

Technical data

subject to change without notice

Surround speakers

Impedance	3Ω
Frequency range	100–15,000Hz
Output power	2 × 22 W RMS ¹ /3Ω/1kHz/THD 10%
Output power	360 W PMPO
Sensitivity	87dB
Drivers	1 × 4" full range
Dimensions (h × w × d)	219 × 174 × 209mm
Weight active	approx. 3kg
Weight passive	approx. 1.5kg

¹ ±1 dB

Magnetically shielded centre speaker

Impedance	6Ω
Frequency range	75–20,000Hz
Power handling capacity	50W
Sensitivity	89dB
Drivers	2 × 4" woofers, 1 × 1 1/4" tweeter
Crossover frequencies	8,000Hz
Dimensions (h × w × d)	152 × 400 × 160mm
Weight	approx. 3.4kg

Transmitter unit

System	Radio frequency (RF)
Modulation	Frequency modulation (FM)
S/N in signal	95dB
Step channel frequency	433.375–434.500MHz or 925.500–927.000MHz
Transmission power	< 10mW
Working range	up to 100m
Dimensions (h × w × d)	206 × 130 × 134mm
Weight	approx. 0.26kg

WARNING

Under no circumstances should you try to repair the speakers yourself, as this will invalidate the guarantee.

If a fault occurs, first check the points listed below before taking the speakers for repair.

If you are unable to solve a problem by following these hints, consult your dealer or service centre.

PROBLEM	POSSIBLE CAUSE	SOLUTION
No sound	VOLUME is not correctly adjusted.	Adjust the VOLUME.
	Headphones are connected to the appliance.	Disconnect headphones.
	Speakers are not (or wrongly) connected.	Connect the speakers securely.
No sound on the left or right side	One speaker is wrongly connected.	Connect the speaker properly.
	A speaker cable is damaged.	Replace the cable.
Poor sound or no sound at the centre or surround speakers	SURROUND mode is not switched on.	Switch to the surround mode on the appliance.
	Surround and/or centre speakers are not (properly) connected.	Connect the speakers properly.
	A speaker cable is damaged.	Replace the cable.
	Transmitter unit or active surround speakers are switched off.	Switch on transmitter and active surround speaker.
	Transmitter unit and/or active surround speaker are not securely connected to the mains.	Connect the mains cables properly.
	CHANNEL switch of the transmitter unit and the active speaker are not switched to the same number.	Set the CHANNEL slides on the transmitter unit and on the active speaker to the same number.
	Transmitter unit is connected to the wrong output on the appliance.	Connect the transmitter unit to the correct terminal on the appliance.
	SURR/MULTI switch of the transmitter unit is in the wrong position.	Set the SURR/MULTI switch to the SURR position.
	The signal from the transmitter unit is interfered through electric appliances.	Set the transmitter unit and the active surround speaker to another transmitting channel.
The signal from your appliance is too strong.	Set the input sensitivity of the transmitter unit to the next level.	
Poor bass sound	Speakers are not in phase.	Connect speakers properly; coloured cable to ⊕-pole, black cable to ⊖-pole.
Bad sound	Badly matching setting for the given type of music or sound.	Correct the sound settings on the appliance.
Surround sound level is too low or too high	The level of the surround sound is not properly adjusted.	Adjust the level and delay time of the surround sound on the appliance.
Centre sound level is too low or too high	The sound level of the centre channel is not properly adjusted.	Adjust the level of the centre channel on the appliance.

English

Français

Español

中文

Meet PHILIPS at the Internet
<http://www.philips.com>

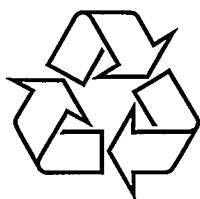

Free Manuals Download Website

<http://myh66.com>

<http://usermanuals.us>

<http://www.somanuals.com>

<http://www.4manuals.cc>

<http://www.manual-lib.com>

<http://www.404manual.com>

<http://www.luxmanual.com>

<http://aubethermostatmanual.com>

Golf course search by state

<http://golfingnear.com>

Email search by domain

<http://emailbydomain.com>

Auto manuals search

<http://auto.somanuals.com>

TV manuals search

<http://tv.somanuals.com>