

DVD HOMETHEATRE SYSTEM

HTS3000
HTS3010

User Manual

Thank you for choosing Philips.

Need help fast?

*Read your Quick Start Guide and/or User Manual first for quick tips
that make using your Philips product more enjoyable.*

***Register your product and get support
at www.philips.com/welcome***



PHILIPS

WARRANTY

This APPARATUS IS covered under warranty against any defect arising out of faulty or defective material or workmanship for a period of 12 months from date of purchase.

Should a defect develop during the period of warranty, Philips India Limited undertakes to repair the apparatus free of charge through an Authorised Philips service Center. If the purchaser shifts his residence to other town, the warranty will be valid at the nearest Authorised Philips service Center.

This warranty is not valid in case:

1. The apparatus is not used according to this manual;
2. Defects are caused by improper or reckless use;
3. Any repair work are done by person other than Authorised Philips Service Center;
4. Any modification or alteration of any nature are made in the apparatus;
5. The serial number is tampered
6. This warranty form is not completed immediately after purchase.

Serial No.: _____
Bill No & Date of Purchase: _____
Purchaser's Name: _____
Location & Tel No: _____
Dealer's Name: _____
Location & Tel No: _____
Dealer's Stamp & Sign: _____

Philips Electronics India Limited

Registered Office : 7, Justice Chandra Madhab Road, Kolkata 700 020

Head Office : 2nd Floor, Technopolis Knowledge Park, Nelco Complex,
Mahakali Caves Road, Chakala, Andheri (East), Mumbai – 400093.

Maintenance Tips for your Home Theater System:

- Always keep a Disc loaded in your Home Theater System tray.
- Keep the home theater away from the dusty areas. Keep it covered with a dust cover.
- Clean your Home Theater System Lens after every 20 discs played.
 - Use the 2 brush Philips DVD Lens Cleaner SVC2520 for best results.
- Clean the CDs / VCD / DVD / MP3 CD before inserting in your Home Theater System.

"For unlimited listening pleasure use
Philips earphones / headphones". Over 20 models to choose from

For any sales or service related queries:
Visit us on web at www.philips.com or
Call us on Toll Free Number : 1 600 22 44 22

LASER

Type	Semiconductor laser GaAlAs
Wave length	650 - 660 nm (DVD) 784 - 796 nm (CD)
Output Power	7 mW (DVD) 10 mW (VCD/CD)
Beam divergence	60 degrees



Manufactured under license from Dolby Laboratories, Dolby, Pro Logic and the double-D symbol are trademarks of Dolby Laboratories.

Due to the inconsistency of disc formats provided by various disc manufacturers, your DVD system/ player/recorder may require a playability enhancement or upgrade. As DVD technology advances, these enhancement will become common and will be easy to complete. Go to www.philips.com/support for software upgrade.

Из-за несовместимости форматов дисков различных производителей для вашей системы DVD может быть необходимо произвести обновления или улучшить воспроизводимость. С развитием технологии DVD эти улучшения станут широкоиспользуемыми и просто выполняемыми. Обновления программного обеспечения находятся на веб-сайт "www.philips.com/support".



DivX®, DivX UCertified, and associated logos are trademarks of DivX, Inc. and are used under license.



Windows Media and the Windows logo are trademarks, or registered trademarks of Microsoft Corporation in the United States and/or other countries.

CAUTION

Use of controls or adjustments or performance of procedures other than herein may result in hazardous radiation exposure or other unsafe operation.

ATTENTION!

For Customer Use:

Read carefully the information located at the bottom or rear of your DVD Home Theater System and enter below the Serial No. Retain this information for future reference.

Model No. HTS3000, HTS3010

Serial No. _____

This product incorporates copyright protection technology that is protected by method claims of certain U.S. patents and other intellectual property rights owned by Macrovision Corporation and other rights owners. Use of this copyright protection technology must be authorized by Macrovision Corporation, and is intended for home and other limited viewing uses only unless otherwise authorized by Macrovision Corporation. Reserve engineering or disassembly is prohibited.

Language Code

Abkhazian	6566	Inupiaq	7375	Pushto	8083
Afar	6565	Irish	7165	Russian	8285
Afrikaans	6570	Íslenska	7383	Quechua	8185
Amharic	6577	Italiano	7384	Raeto-Romance	8277
Arabic	6582	Ivrit	7269	Romanian	8279
Armenian	7289	Japanese	7465	Rundi	8278
Assamese	6583	Javanese	7486	Samoan	8377
Avestan	6569	Kalaallisut	7576	Sango	8371
Aymara	6589	Kannada	7578	Sanskrit	8365
Azerbaijani	6590	Kashmiri	7583	Sardinian	8367
Bahasa Melayu	7783	Kazakh	7575	Serbian	8382
Bashkir	6665	Kernewek	7587	Shona	8378
Belarusian	6669	Khmer	7577	Shqip	8381
Bengali	6678	Kinyarwanda	8287	Sindhi	8368
Bihari	6672	Kirghiz	7589	Sinhalese	8373
Bislama	6673	Komi	7586	Slovensky	8373
Bokmål, Norwegian	7866	Korean	7579	Slovenian	8376
Bosanski	6683	Kuanyama; Kwanyama	7574	Somali	8379
Brezhoneg	6682	Kurdish	7585	Sotho; Southern	8384
Bulgarian	6671	Lao	7679	South Ndebele	7882
Burmese	7789	Latina	7665	Sundanese	8385
Castellano, Español	6983	Latvian	7686	Suomi	7073
Catalán	6765	Letzeburgesch;	7666	Swahili	8387
Chamorro	6772	Limburgan; Limburger	7673	Swati	8383
Chechen	6769	Lingala	7678	Svenska	8386
Chewa; Chichewa; Nyanja	7889	Lithuanian	7684	Tagalog	8476
中文	9072	Luxembourgish;	7666	Tahitian	8489
Chuang; Zhuang	9065	Macedonian	7775	Tajik	8471
Church Slav; Slavonic	6785	Malagasy	7771	Tamil	8465
Chuvash	6786	Magyar	7285	Tatar	8484
Corsican	6779	Malayalam	7776	Telugu	8469
esky	6783	Maltese	7784	Thai	8472
Dansk	6865	Manx	7186	Tibetan	6679
Deutsch	6869	Maori	7773	Tigrinya	8473
Dzongkha	6890	Marathi	7782	Tonga (Tonga Islands)	8479
English	6978	Marshallese	7772	Tsonga	8483
Esperanto	6979	Moldavian	7779	Tswana	8478
Estonian	6984	Mongolian	7778	Türkçe	8482
Euskara	6985	Nauru	7865	Turkmen	8475
Ελληνικά	6976	Navaho; Navajo	7886	Twi	8487
Faroese	7079	Ndebele, North	7868	Uighur	8571
Français	7082	Ndebele, South	7882	Ukrainian	8575
Frysk	7089	Ndonga	7871	Urdu	8582
Fijian	7074	Nederlands	7876	Uzbek	8590
Gaelic; Scottish Gaelic	7168	Nepali	7869	Vietnamese	8673
Gallegan	7176	Norsk	7879	Volapuk	8679
Georgian	7565	Northern Sami	8369	Walloon	8765
Gikuyu; Kikuyu	7573	North Ndebele	7868	Welsh	6789
Guarani	7178	Norwegian Nynorsk;	7878	Wolof	8779
Gujarati	7185	Occitan; Provençal	7967	Xhosa	8872
Hausa	7265	Old Bulgarian; Old Slavonic	6785	Yiddish	8973
Herero	7290	Oriya	7982	Yoruba	8979
Hindi	7273	Oromo	7977	Zulu	9085
Hiri Motu	7279	Ossetian; Ossetic	7983		
Hrvatski	6779	Pali	8073		
Ido	7379	Panjabi	8065		
Interlingua (International)	7365	Persian	7065		
Interlingue	7365	Polski	8076		
Inuktitut	7385	Português	8084		

Index

English 6

Hindi 47

English

Hindi

Table of contents

General

General Information	8
Setup precautions.....	8
Accessories supplied	8
Cleaning discs	8
About recycling.....	8

Product Overview

Main Unit	9
Remote Control.....	10-12
Using the remote control	12

Connections

Basic Connections	13-16
Step 1: Placing the speakers.....	13
Step 2: Connecting to TV	14
Option 1: Using the Video socket	14
Option 2: Connecting to a Progressive Scan TV or component video input.....	14
Step 3: Connecting speakers and subwoofer	15
Step 4: Connecting the FM and AM/MW antennas	16
Step 5: Connecting the power cord.....	16
Optional Connections.....	17
Connecting audio from TV	17
Connecting to cable box/satellite receiver and recorder/VCR.....	17

Basic Setup

Getting Started.....	18-21
Finding the correct viewing channel	18
Switching to different play source	18
Setting language preferences.....	19
On-screen display (OSD) language	19
Audio, Subtitle and Menu language for DVD playback.....	19-20
Setting the TV Display	20
Setting up Progressive Scan feature	21
Setting the speakers' channels.....	22

Disc Playback

Disc Operations	23-31
Playable discs	23
Playing a disc	23
Basic playback controls.....	24
Selecting various repeat/shuffle functions.....	24
Programming disc tracks.....	25
Other playback features for video discs (DVD/VCD/SVCD).....	25-28
Using the Disc Menu	25
Viewing playback information.....	26
Zooming in/out.....	26
Changing subtitle language	26
Switching camera angles.....	26
Changing sound track language.....	27
Setting the delay times for audio playback.....	27
Playback Control (VCD only).....	27
Preview function (VCD/SVCD only)	28

Table of contents

Playing a MP3/ WMA disc	29
Playing a JPEG image file (slide show)	30
Preview function	30
Zoom picture	30
Rotating/flipping the picture	30
Playing MP3/WMA music and JPEG pictures simultaneously	31
Playing a DivX disc	31

Setup Options

Setup Menu Options.....	32-37
Accessing the setup menu.....	32
General Setup Page.....	33
Audio Setup Page.....	34
Video Setup Page.....	35
Preference Page	36-37

Radio Tuning

Radio Operations.....	38-39
Tuning to radio stations.....	38
Presetting radio stations	38
Using auto install	38-39
Using automatic preset.....	39
Using manual preset.....	39
Selecting a preset radio station.....	39
Deleting a preset radio station.....	39

Others

Sound and Volume Controls	40
Volume control	40
Selecting surround sound.....	40
Selecting digital sound effects.....	40
Other Features.....	41
Installing the latest software	41
Setting the Sleep timer	41
Troubleshooting.....	42-43
Glossary.....	44-45
Specifications	46

General Information

WARNING!

This unit does not contain any user-serviceable parts. Please leave all maintenance work to qualified personnel.

Setup precautions

Finding a suitable location

- Place this unit on a flat, hard and stable surface. Never place the unit on a carpet.
- Never place this unit on top of other equipment that might heat it up (e.g., receiver or amplifier).
- Never put anything under this unit (e.g., CDs, magazines).
- Install this unit near the AC outlet where the AC power plug can be easily reached.

Space for ventilation

- Place this unit in a location with adequate ventilation to prevent internal heat build up. Allow at least 10 cm (4") clearance from the rear and the top of this unit and 5cm (2") from the left and right to prevent overheating.

Avoid high temperature, moisture, water and dust

- This unit must not be exposed to dripping or splashing.
- Never place any object or items that can damage this unit (e.g., liquid filled objects, lighted candles).

Accessories supplied

- 1 subwoofer
- 2 front speakers
- 2 rear speakers
- 1 centre speaker
- 1 remote control with batteries
- 1 composite video cable (yellow)
- 1 FM wire antenna
- 1 AM/MW loop antenna
- 1 power cable
- Quick Start Guide

Cleaning discs

To clean a disc, use a micro fibre cleaning cloth and wipe the disc from the centre to the edge in a straight line.

CAUTION!

Never use solvents e.g. benzene, thinner, commercially available cleaners, or anti-static sprays intended for discs.

About recycling

These operating instructions have been printed on non-polluting paper. The electronic equipment contains a large number of materials that can be recycled. If you are disposing of an old machine, please take it to a recycling centre. Please observe the local regulations regarding disposal of packaging materials, exhausted batteries and old equipment.

Main Unit

English

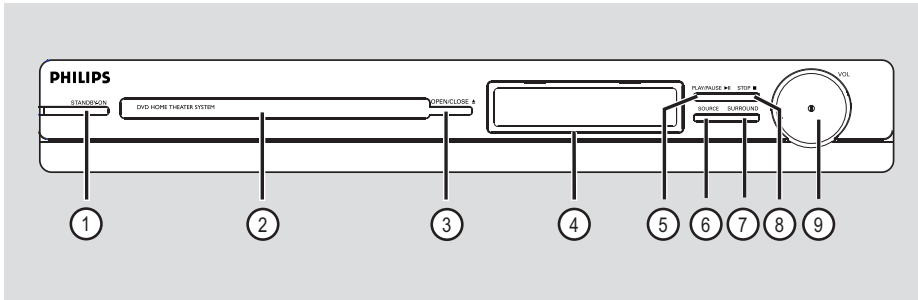

① STANDBY-ON

- Turns on this unit or turns off to normal standby mode.

② Disc Tray

③ OPEN/CLOSE ▲

- Opens/closes the disc tray.

④ Display panel

⑤ PLAY/ PAUSE ►||

- DISC: starts/pauses playback.
- RADIO: starts auto radio installation for first time setup.

⑥ SOURCE

- Selects the relevant active source mode: DISC, FM, AM/MW, TV or AUX.

⑦ SURROUND

- Selects multi-channel surround or stereo mode.

⑧ STOP ■

- Exits an operation.
- DISC: stops playback.
- RADIO: press and hold this button to erase the current preset radio station.

⑨ VOL

- Adjusts the volume level.

Remote Control

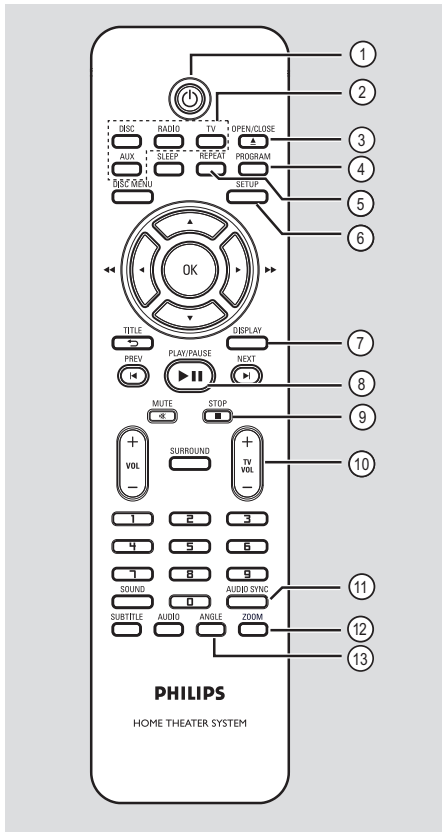

- ① — Turns on this unit or turns off to normal standby mode.
- ② **Source buttons**
- **DISC:** switches to DISC mode.
 - **RADIO:** toggles between FM and AM/MW band.
 - **TV:** switches to TV mode. The sound from the TV will output through the connected speaker system.
 - **AUX:** switches to the external device that is connected to the AUDIO IN-AUX socket.

- ③ **OPEN/CLOSE ▲**
- Opens/closes the disc tray.
- ④ **PROGRAM**
- **DISC:** starts programming.
 - **RADIO:** press and hold this button to start automatic/ manual preset programming.
- ⑤ **REPEAT**
- Selects various repeat or shuffle modes; turns off repeat or shuffle mode.
- ⑥ **SETUP**
- Enters or exits the system setup menu.
- ⑦ **DISPLAY**
- Displays the current status or disc information.
 - Selects a different viewing angle of a DVD movie (if available).
- ⑧ **PLAY/PAUSE ►||**
- **DISC:** starts/pauses playback.
 - **RADIO:** starts auto radio installation for first time setup.
- ⑨ **STOP ■**
- Exits an operation.
 - **DISC:** stops playback.
 - **RADIO:** press and hold this button to erase the current preset radio station.
- ⑩ **TV VOL + / -**
- Adjusts the volume of the TV (for Philips TVs or compatible brands only).
- ⑪ **AUDIO SYNC**
- Sets the audio output delay times if the video playback is slower than the audio output.
- ⑫ **ZOOM**
- Zoom in or out the picture on the TV.
- ⑬ **ANGLE**
- Selects a different viewing angle of a DVD movie (if available).

Remote Control (continued)

- ⑭ **SLEEP**
 - Sets the sleep timer function.
- ⑮ **DISC MENU**
 - For DVD, enters or exits disc contents menu.
 - For VCD/SVCD, enters digest menu.
- ⑯ **OK**
 - Confirms an entry or selection.
- ⑰ **▲▼◀▶**
 - DISC: selects movement direction in the menu.
 - DISC: press left or right for fast forward and backward search.
 - RADIO: press up or down to tune the radio frequency.
 - RADIO: press left or right to start auto search.
- ⑱ **TITLE ↶**
 - For DVD, go back to the previous menu.
 - For VCD version 2.0 only; During playback, display the disc title menu or return to the main menu.
- ⑲ **PREV ◀ / NEXT ▶**
 - DISC: skips to the previous or next title/ chapter/track.
 - RADIO: selects a preset radio station.
- ⑳ **MUTE 0x**
 - Mutes or restores the volume.
- ㉑ **VOL + / -**
 - Adjusts the volume level.
- ㉒ **SURROUND**
 - Selects multi-channel surround or stereo mode.
- ㉓ **Numeric keypad 0-9**
 - Enters a track/title number of the disc.
 - Enters a number of a preset radio station.
- ㉔ **SOUND**
 - Selects a predefined sound effect.

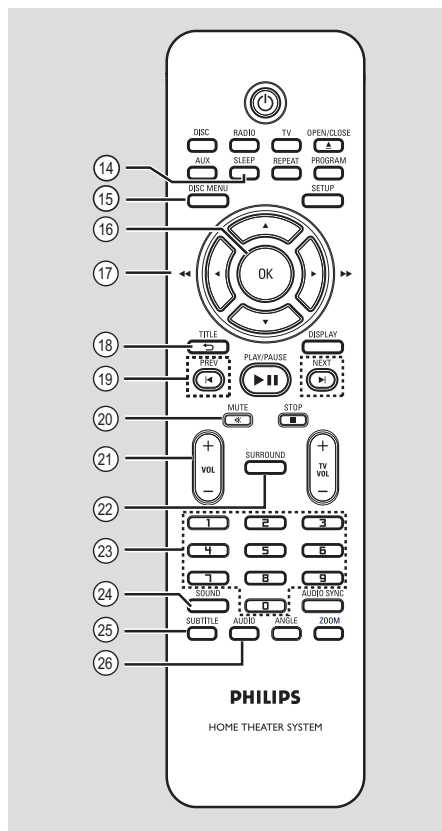

- ㉕ **SUBTITLE**
 - Selects a DVD subtitle language.
- ㉖ **AUDIO**
 - DISC: selects an audio language/channel.

Remote Control (continued)

Using the remote control

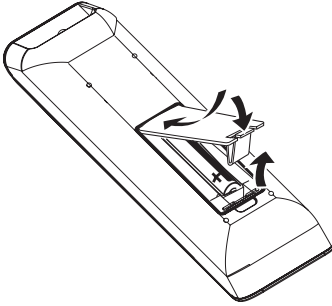

- 1 Open the battery compartment.
- 2 Insert two batteries type R03 or AAA, following the indications (+ -) inside the compartment.
- 3 Close the cover.
- 4 Point the remote control directly at the remote sensor (iR) on the front panel.
- 5 Select the source you wish to control by pressing the DISC, RADIO, TV or AUX button on the remote control.
- 6 Then select the desired function (for example ◀, ▶).

CAUTION!

- Remove batteries if they are exhausted or if the remote control is not to be used for a long time.
- Never mix batteries (old and new or carbon and alkaline, etc).
- Batteries contain chemical substances, they should be disposed of properly.

Basic Connections

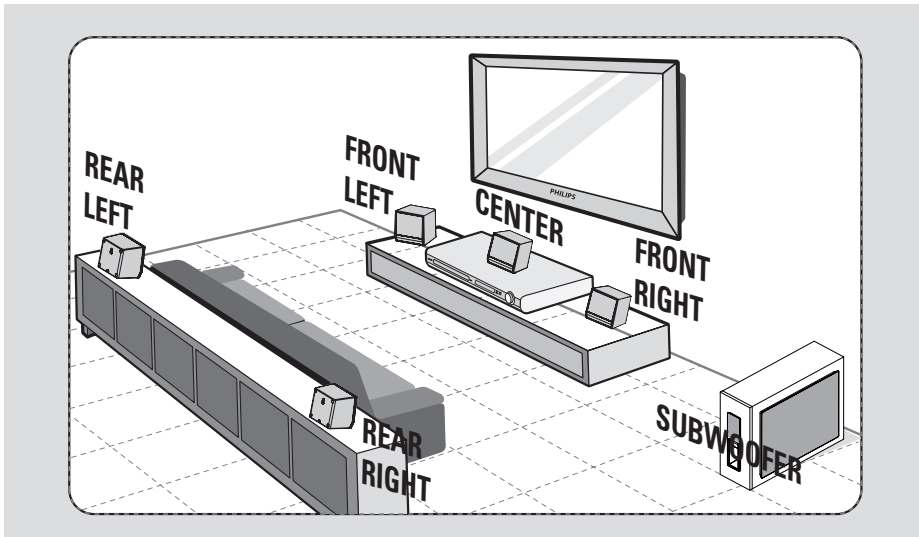

Step 1: Placing the speakers

The Philips Home Theatre System is simple to install. However, proper system placement is critical to ensure an optimum sound experience.

- 1 Place the front left and right speakers at equal distances from the TV and at an angle of approximately 45 degrees from the listening position.
- 2 Place the centre speaker above the TV or the main unit such that the centre channel's sound is localised.
- 3 Place the rear speakers at normal listening ear level facing each other or hang on the wall.
- 4 Place the subwoofer at the corner of the room. Otherwise, keep it at least one metre away from the TV.

Helpful Hints:

- The placement diagram shown here is only a guideline that provides great system performance. You may find other placement choices that are more suitable for your room layout that provide the sound experience you enjoy.
- To avoid magnetic interference, never position the front speakers too close to your TV.
- The rear speakers are labelled as REAR LEFT or REAR RIGHT.
- The front speakers are labelled as FRONT LEFT or FRONT RIGHT.
- For speaker setting, see 'Getting Started - Setting the speakers' channel'.

Basic Connections (continued)

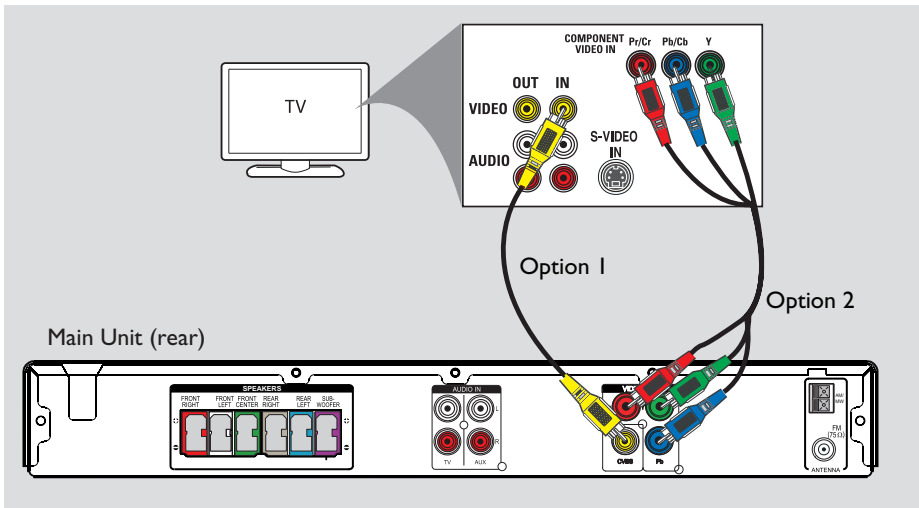

Step 2: Connecting to TV

This connection enables you to view the video playback from this unit. You only need to choose **one** of the options below to make the video connection.

- For a standard TV, follow option 1.
- For a progressive scan TV, follow option 2.

Helpful Hint:

– It is important to connect this unit directly to the TV in order to enjoy optimum video quality.

Option 1: Using the Video socket

- Connect a composite video cable (supplied) from the **CVBS** socket on the main unit to the video input socket (or labelled as A/V In, Video In, Composite or Baseband) on the TV.

Option 2: Connecting to a Progressive Scan TV or component video input

The progressive scan video quality is only available when using Y Pb Pr connection and a progressive scan TV is required. It provides superior picture quality when watching DVD movies.

- 1 Connect the component video cables (red/ blue/green - not supplied) from the **Y Pb Pr** sockets on the main unit to the corresponding component video input sockets (or labelled as Y Pb/Cb Pr/Cr or YUV) on the TV.
- 2 If your TV accepts progressive signals, proceed to chapter 'Getting Started - Setting up Progressive Scan feature' for detailed progressive feature setup.

Basic Connections (continued)

English

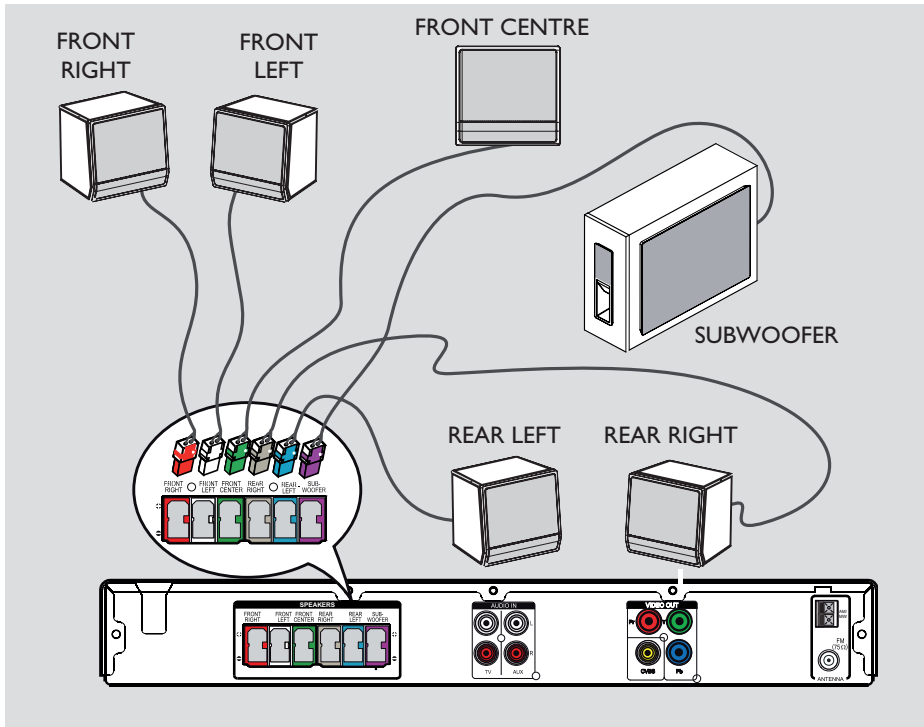

Step 3: Connecting speakers and subwoofer

- Connect all the speakers and subwoofer to the matching sockets at the rear of the main unit. Make sure that the colours of the plugs and sockets are matched.

Helpful Hint:

– To prevent unwanted noise, never place the speakers too close to the main unit, subwoofer, AC power adapter, TV or any other radiation sources.

Basic Connections (continued)

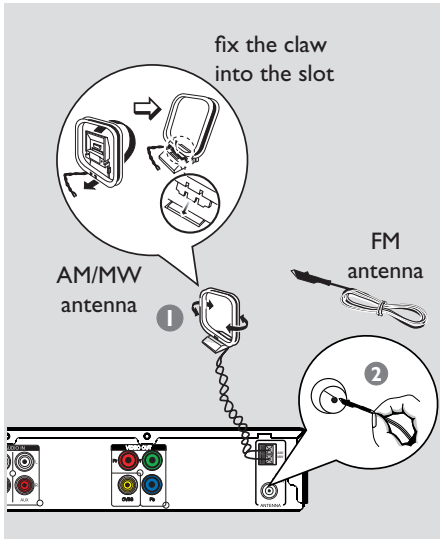

Step 4: Connecting the FM and AM/MW antennas

- 1 Connect the supplied AM/MW loop antenna to the **AM/MW** socket. Place the AM/MW loop antenna on a shelf, or attach it to a stand or wall.
- 2 Connect the supplied FM antenna to the **FM 75 Ω** socket. Extend the FM antenna and fix its ends to the wall.

For better FM stereo reception, connect an external FM antenna (not supplied).

Helpful Hints:

- Adjust the position of the antennas for optimal reception.
- Position the antennas as far away as possible from your TV, VCR or other radiation source to prevent any unwanted interference.

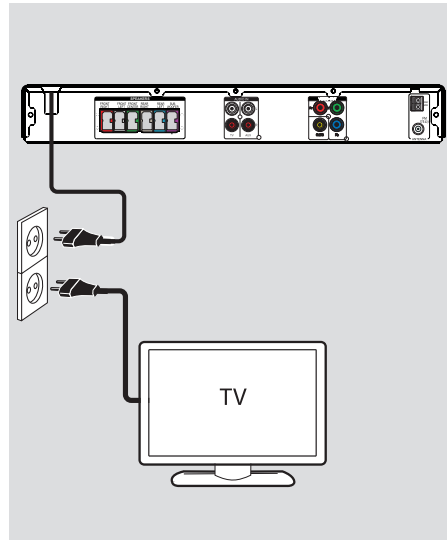

Step 5: Connecting the power cord

Notes:

- For power supply rating, refer to the rear or bottom of the main unit.
- Turning off to standby mode does not disconnect the unit from mains.
- When all the connections are complete, connect the AC power cord to the power outlet.
 - The standby LED on the main unit lights up.

Helpful Hint:

- Before making or changing any connections, make sure that all the devices are disconnected from the power outlet.

Optional Connections

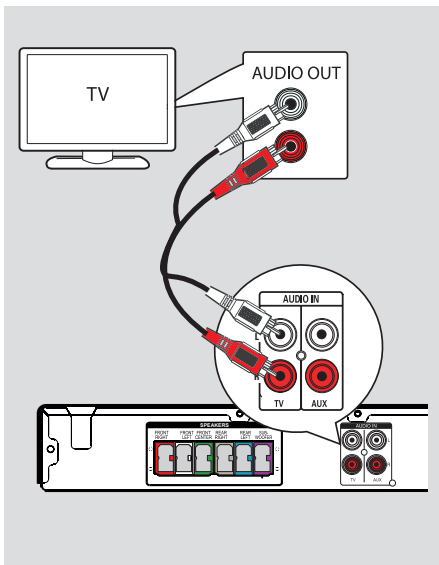

Connecting audio from TV

When connecting the audio output from your TV to this Home Theatre System, you can have the sound of the TV output on all the speakers. It enables you to enjoy the multi-channel surround sound capabilities.

- Connect an audio cable (red/white - not supplied) from the **AUDIO IN-TV** sockets on the main unit to the **AUDIO OUT** sockets on the TV.

To listen to the sound, press **TV** on the remote control as the sound source that you want to listen to.

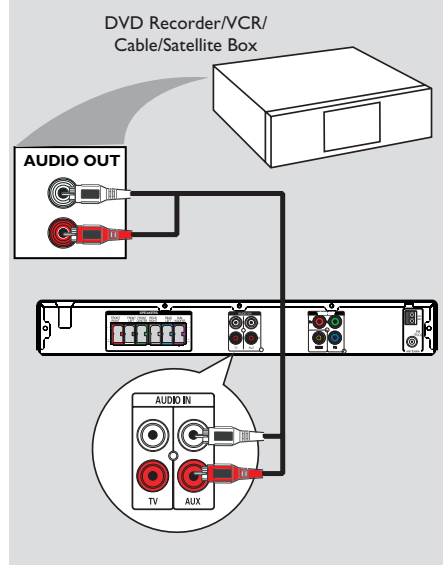

Connecting to cable box/satellite receiver and recorder/VCR

You can connect the audio output from an audio/video device (e.g. DVD Recorder, VCR, Cable/Satellite Box) to this Home Theatre System in order to enjoy the multi-channel surround sound capabilities.

- Connect an audio cable (red/white - not supplied) from the **AUDIO IN-AUX** sockets on the main unit to the **AUDIO OUT** sockets on the connected device.

To listen to the sound, press **AUX** as the sound source that you want to listen to.

Getting Started

Finding the correct viewing channel

- 1 Press **SOURCE** button on the main unit until 'DISC' appears on the display panel (or **DISC** on the remote control).
- 2 Turn on the TV and switch it to the correct video-in channel.
 - You may go to the lowest channel on your TV, then press the Channel Down button on your TV's remote control until you see the Video In channel.
 - You may press  button repeatedly on your TV's remote control.
 - Usually this channel is between the lowest and highest channels and may be called FRONT, A/V IN, VIDEO, etc..
 - Refer to your TV's user manual on how to select the correct input on your TV.

Switching to different play source

- Press the **SOURCE** button on the front panel repeatedly to select:

DISC → FM → AM/MW → TV
→ AUX → DISC

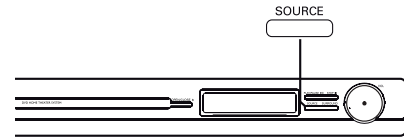

Or

- Press **DISC**, **RADIO**, **TV** or **AUX** on the remote control.
 - Press **DISC** to switch to DISC mode.
 - Press **RADIO** to toggle between FM and AM/MW band.
 - If the audio input on this unit is connected to your TV, press **TV** to hear the TV's sound output through this unit.
 - Press **AUX** for switching to the external device that is connected to the AUDIO IN-AUX socket on this unit.

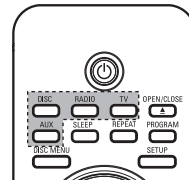

Getting Started (continued)

Setting language preferences

The language options are different depending on your country or region. It may not correspond to the illustrations shown on the user manual.

On-screen display (OSD) language

The OSD (On-Screen Display) language for this unit remains as you have set it, regardless of the changes made to the DVD disc language.

- 1 In disc mode, press **SETUP** on the remote control.
→ { **General Setup Page** } appears.
- 2 Press **▼** to highlight { **OSD Language** } in the menu and press **▶**.

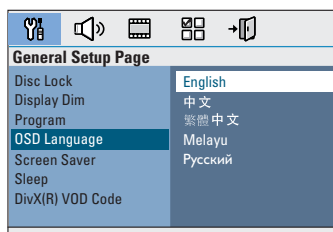

- 3 Use **▲▼** keys to select a language and press **OK** to confirm.

Audio, Subtitle and Menu language for DVD playback

You can select your preferred language settings for DVD playback. If the selected language is recorded on the DVD disc, this unit automatically plays the disc in that language. Otherwise, the disc's default language will be used instead.

- 1 Press **■** twice to stop playback (if any), then press **SETUP**.
- 2 Press **▶** repeatedly to select { **Preference Page** }.
- 3 Use **▲▼** keys to select one of the options below and press **▶**.

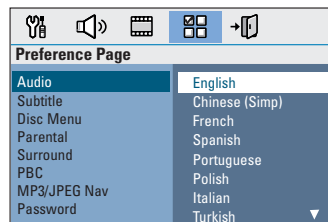

{ **Audio** }

Selects the preferred audio language for DVD playback.

{ **Subtitle** }

Selects the preferred subtitle language for DVD playback.

{ **Disc Menu** }

Selects the preferred disc menu language for DVD playback.

- 4 Use **▲▼** keys to select a language and press **OK** to confirm.

Getting Started (continued)

If the language you want is not available in the list, select { **Others** }. Use the **numeric keypad (0-9)** on the remote control to enter the 4-digit language code 'XXXX' (see page 4) and press **OK** to confirm.

- 5 Repeat steps 3 ~ 4 for other settings.

Helpful Hints:

– During DVD playback, you can switch the audio and subtitle languages by pressing the **AUDIO** and **SUBTITLE** buttons on the remote control. However, this does not change the default settings you have made here.

– For some DVDs, the subtitle/audio/menu language can only be changed via the DVD disc menu.

Setting the TV Display

Set the aspect ratio of this unit according to the TV type you have connected. The format you select must be available on the disc. If it is not, the setting for TV display will not affect the picture during playback.

- 1 In disc mode, press **SETUP** on the remote control.
- 2 Press **▶** repeatedly to select { **Video Setup Page** }.
- 3 Press **▼** to highlight { **TV Display** } in the menu and press **▶**.

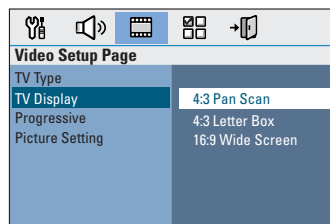

{ **4:3 Pan Scan** }

Select this if you have a conventional TV and want both sides of the picture to be trimmed or formatted to fit your TV.



{ **4:3 Letter Box** }

Select this if you have a conventional TV. In this case, a wide picture with black bands on the upper and lower portions of the TV will be displayed.



{ **16:9 Wide Screen** }

Select this if you have a wide-screen TV.



- 4 Select one of the options and press **OK** to confirm.

Getting Started (continued)

Setting up Progressive Scan feature

(for Progressive Scan TV only)

The progressive scan displays twice the number of frames per second than interlaced scanning (ordinary normal TV system). With nearly double the number of lines, progressive scan offers higher picture resolution and quality.

Before you start...

Ensure that you have connected this unit to a progressive scan TV using the Y Pb Pr connection (see 'Option 2: Connecting to a Progressive Scan TV or component video input').

- 1 Turn on the TV to the correct viewing channel for this unit.
→ Make sure that the TV's progressive scan mode is turned off (or set to interlaced mode). Refer to your TV's user manual.
- 2 Turn on this unit and press **DISC** on the remote control.
- 3 Press **SETUP** on the remote control.
- 4 Press **▶** repeatedly to select { **Video Setup Page** }.
- 5 Move to { **Progressive** } > { **On** } in the menu and press **OK** to confirm.

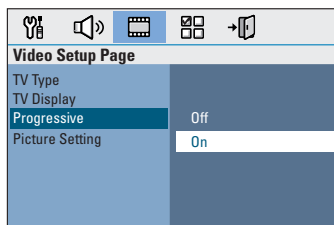

- 6 Read the notification message on the TV and confirm your action by selecting the in the menu and press **OK**.

There will be no picture on your TV at this state until you have turned on the progressive scan mode on your TV.

- 7 Turn on your TV progressive scan mode, refer to your TV's user manual.
→ A message appears on the TV.
- 8 Confirm your action by selecting the in the menu and press **OK**.
→ The setup is now completed and you can start to enjoy the high quality picture.

If no picture is displayed

- 1 Press **OPEN/CLOSE** **▲**.
- 2 Press **◀** on the remote control.
- 3 Press **AUDIO** on the remote control.

Helpful Hints:

- If a blank/distorted screen appears, wait for 15 seconds for the auto recovery.
- There are some progressive scan TVs that are not fully compatible with this unit, resulting in an unnatural picture when playing back a DVD VIDEO disc in the progressive scan mode. In such a case, turn off the progressive scan feature on this unit and your TV

Getting Started (continued)

Setting the speakers' channels

You can adjust the delay times (centre and surround only) and volume level for individual speakers. These adjustments let you optimise the sound according to your surroundings and setup.

Before you start...

Stop the disc playback by pressing STOP button twice or remove the disc from the disc tray. Otherwise, the settings are not accessible.

- 1 In disc mode, press **SETUP** on the remote control.
- 2 Press **▶** repeatedly to select { **Audio Setup Page** }.
- 3 Press **▼** to highlight { **Speakers Volume** } and press **▶**.

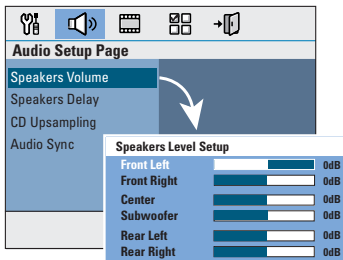

- 4 Use **◀▶** keys to set the volume level for each speaker (-6dB ~ +6dB) and press **OK** to confirm.

- 5 Use **▲▼** keys to highlight { **Speakers Delay** } and press **▶**.

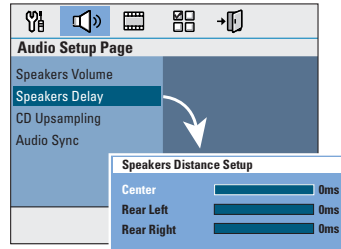

- 6 Use **◀▶** keys to set the delay times (0 ms ~ 15 ms) for centre and rear speakers that best suit your surround sound needs.
- 7 Press **OK** to confirm.

Helpful Hints:

- A 1ms increase/decrease of delay time is equivalent to 30 cm change in distance.
- Use the longer delay time settings when the rear speakers are closer to the listener than the front speakers.
- The test tone will be automatically generated to help you judge the sound level of each speaker.

Disc Operations

Playable discs



Your DVD home theatre system plays:

- Digital Versatile Discs (DVDs)
- Video CDs (VCDs)
- Super Video CDs (SVCDs)
- Finalised DVD Recordable (DVD±R), DVD Rewritable (DVD±RW)
- Audio Compact Discs (CDs)
- MP3/ Windows Media™ Audio discs, picture (Kodak, JPEG) files on CD-R(W)
 - ISO 9660/UDF format
 - JPEG resolution support up to 3072 x 2048
 - Supported sampling frequencies: 32 kHz, 44.1 kHz, 48 kHz
 - Supported Bit-rates: 32~256 (kbps), variable bit rates (average 128 kbps)
- DivX files on CD-R(W)/DVD+R(W):
 - DivX 3/4/5/6

Region Codes for DVD discs

DVD discs and players are designed with regional restrictions. Before playing a disc, make sure the disc is for the same region as your player. The regional code for this unit is indicated at the rear or bottom panel.

Notes:

- If the inhibit icon (Ø or X) appears on the TV when a button is pressed, it means the function is not available on the current disc or at the current time.
- Never put any objects other than discs on the disc tray. Doing so may cause the disc player to malfunction.

Playing a disc

- 1 Press **SOURCE** repeatedly until 'DISC' appears on the display panel (or press **DISC** on the remote control).
- 2 Turn on the TV to the correct viewing channel for this unit.
→ The blue DVD background screen appears on the TV.
- 3 Press **OPEN/CLOSE** ▲ to open the disc tray.
- 4 Load a disc and press **OPEN/CLOSE** ▲ to close the disc tray.
→ Make sure the disc label is facing up. For double-sided discs, load the side which you want to play facing up.
- 5 Playback starts automatically.
→ See the following pages for more playback options and features.

Helpful Hints:

- If you are having trouble playing a certain disc, remove the disc and try a different one. Improperly formatted discs cannot be played on this unit.
- Some discs cannot be played on this player due to the configuration and characteristics of the disc, or due to the condition of recording and authoring software that was used.

Disc Operations (continued)

Basic playback controls

Pausing playback

- During playback, press **▶||**.
→ While in pause mode, you can press **▶** to step forward one frame at each press.
→ To resume playback, press **▶||** again.

Selecting another track/chapter

- Press **◀ / ▶** or use the **numeric keypad 0-9** to key in a track/chapter number.
→ If the repeat track mode is active, press **◀** again to replay the same track/chapter.

Searching backward/forward

- Press **◀◀ / ▶▶** on the remote control.
→ While searching, press **◀◀ / ▶▶** repeatedly to decrease/increase the search speed.
→ To resume normal playback, press **▶||**.

Stopping playback

- Press **■**.

Helpful Hints:

- If the message 'To playback from the beginning, press PREV key' appears on the TV while you load in a disc, you can press **◀** to start playback from the beginning.
- This is a power-saving feature, this unit automatically switches to standby mode if you do not press any buttons within 15 minutes after a disc has stopped playing.

Selecting various repeat/shuffle functions

The available of the repeat play options and shuffle play mode are vary depending on the disc type.

- While playing a disc, press **REPEAT** on the remote control repeatedly to choose a repeat or shuffle play mode.

DVD

- RPT ONE (repeat chapter)
- RPT TT (repeat title)
- SHUFFLE (random play)
- RPT SHF (repeat random play)
- RPT OFF (exit repeat mode)

VCD/SVCD/CD

- RPT ONE (repeat track)
- RPT ALL (repeat disc)
- SHUFFLE (random play)
- RPT SHF (repeat random play)
- RPT OFF (exit repeat mode)

MP3/DivX/Windows Media™ Audio

- RPT ONE (repeat track)
- RPT ALL/FLD (repeat folder)
- SHUFFLE (random play)
- RPT OFF (exit repeat mode)

Helpful Hint:

- Repeat playback is not possible on VCDs when the PBC mode is turned on.

Disc Operations (continued)

Programming disc tracks

(not for Picture CD/MP3 discs)

You can play the contents of the disc in the order you want by programming the playing order of the tracks.

- 1 Press **PROGRAM** on the remote control.
→ The programming menu appears.

Program:Track (01-16)			
1	04	6	--
2	10	7	--
3	12	8	--
4	--	9	--
5	--	10	--
Exit Start Next ▸			

- 2 Use the **numeric keypad (0-9)** to enter a valid track/chapter number.
- 3 Use **◀▶▲▼** keys to move the cursor to the next position.
 - If there are more than ten total programme tracks, select { **Next** } on the screen and press **OK** (or press **▶** on the remote control) to access the next programming page.
 - To remove the track/chapter from the programming menu, select the track/chapter and press **OK**.
- 4 Once complete, select { **Start** } on the screen and press **OK** to start playback.
→ Playback starts from the selected track under the programmed sequence.
- 5 To exit the programme menu, select { **Exit** } in the menu and press **OK**.

Other playback features for video discs (DVD/VCD/SVCD)

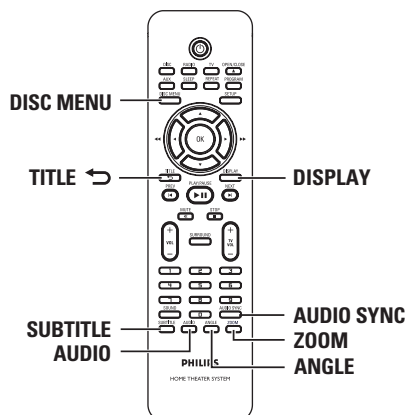

Note:

The operating features described here might not be possible for certain discs. Always refer to the instructions supplied with the discs.

Using the Disc Menu

Depending on the disc format, a menu may appear on the TV screen once you load the disc.

To select a playback feature or item

- Use **◀▶▲▼** keys or **numeric keypad 0-9** on the remote control, then press **OK** to start playback.

To access or remove the menu

- Press **DISC MENU** on the remote control.

Disc Operations (continued)

Viewing playback information

This unit can display the disc playback information (for example, title or chapter number, elapsed playing time, audio/subtitle language) and a number of operations can be done without interrupting disc playback.

- 1 During playback, press **DISPLAY**.
→ A list of available disc information appears on the TV.

DVD

Menu		▶
Title	01/01	
Chapter	02/99	
Audio	2ch	Chi
Subtitle	Off	▼
Bitrate 7 		Title Elapsed 0:29:17

VCD/SVCD

Menu		▶
Track	09/16	
Disc Time	1:16:05	
Track Time	0:04:32	
Repeat	Off	▼
Bitrate 8 		Total Elapsed 0:29:17

- 2 Use **▲▼** keys to view the information and press **OK** to access.
- 3 Use the **numeric keypad 0-9** to input the number/time or use **▲▼** keys to make the selection.
- 4 Press **OK** to confirm.
→ Playback changes according to the chosen time or to the selected title/chapter/track.

Zooming in/out

This option allows you to zoom in or out the picture on the TV and to pan through the picture.

- 1 During playback, press **ZOOM** repeatedly to select a different zoom factor.
→ Playback continues.
- 2 Use **◀▶▲▼** keys to pan through the zoomed image.
- 3 Press **ZOOM** repeatedly to return to the original size.

Changing subtitle language

This operation works only on DVDs with multiple subtitle languages. You can change the language you want while playing a DVD.

- Press **SUBTITLE** repeatedly to select different subtitle languages.

Switching camera angles

This option is only available on DVDs that contain sequences recorded from different camera angles. This allows you to view the picture from different angles.

- If the camera icon appears on the TV, press **ANGLE** repeatedly to select the available camera angles.

Disc Operations (continued)

Changing sound track language

This operation works only on DVDs with multiple sound track languages, or VCDs with multiple audio channels.

- Press **AUDIO** repeatedly to select the available audio languages.

For VCD – changing the audio channel

- Press **AUDIO** repeatedly to select the available audio channels provided by the disc (STEREO, MONO LEFT, MONO RIGHT or MIX MONO).

Setting the delay times for audio playback

This feature allows you to adjust the audio delay times if the video playback is slower than the audio output streams, hence resulting in 'Lip-sync'. The only way to correct 'Lip-sync' error caused by delayed video is to delay audio by an equal amount.

- 1 Press **AUDIO SYNC**.
- 2 Within five seconds, use the **VOL** + – to set the audio output delay times (0 ~ 200 ms).
→ If the volume control is not used within five seconds, it resumes its normal volume control function.

Helpful Hint:

– Set your preferred default **AUDIO SYNC** setting in the setup menu, see 'Setup Menu Options - { Audio Setup Page }'.

Playback Control (VCD only)

Playback Control (PBC) playback allows you to play Video CDs interactively, following the menu on the display. The PBC feature on this unit is turned on by default.

For VCDs with Playback Control (PBC) feature (version 2.0 only)

- During playback, press **TITLE** ↵ to return to the disc title menu or main menu.

Helpful Hint:

– Set your preferred default PBC setting in the setup menu, see 'Setup Menu Options - { Preference Page }'.

Disc Operations (continued)

Preview function (VCD/SVCD only)

This function allows you to preview the contents of a VCD/SVCD.

- 1 Press **DISC MENU**.

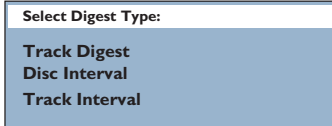

- 2 Use **▲▼** keys to select one of the following options and press **OK**.

{ Track Digest }

View six different tracks on one screen each time. It allows you to have a quick glance at all the tracks on the disc.

{ Disc Interval }

View the whole disc in six thumbnail pictures. It divides a disc into six portions at regular intervals and displays them on one screen.

{ Track Interval }

View the content of a single track in six thumbnail pictures. It divides a single track into six portions at regular intervals and displays them on one screen. This option is only available during playback mode.

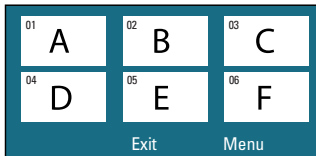

- To go to the previous or next page, press **◀ / ▶**.
- To return to the main menu, select { **Menu** } on the screen and press **OK**.
- Press **OK** on the selected thumbnail picture to start playback from there.
- 3 To exit the preview menu, select { **Exit** } on the screen and press **OK**.

Disc Operations (continued)

Playing a MP3/WMA disc

This unit can playback most of the MP3 and Windows Media™ Audio files recorded on a recordable disc or commercial CD.

Before you start ...

Turn on your TV to the correct Video In channel. See 'Finding the correct viewing channel' for details.

- 1 Insert a MP3/WMA disc.
→ The disc reading time may exceed 30 seconds due to the complexity of the directory/file configuration.
→ The disc menu appears on the TV.

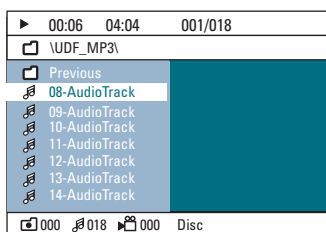

- 2 If the disc main menu contains various folders, use ▲▼ keys to select a desired folder and press **OK** to open the folder.
- 3 Use ▲▼ keys to select a track/file and press **OK** to start playback.
→ Playback starts from the selected file and continue through to the end of the folder.

During playback;

- Press ◀ / ▶ to playback another track/file in the current folder.
- Press ◀◀ / ▶▶ to fast reverse/forward search for a music track.
- To select another folder from the current disc, press ▲ repeatedly to highlight 'Previous' folder and press **OK** to return to the root menu.
- Press **REPEAT** repeatedly to access various play modes.
- 4 To stop playback, press ■.

Helpful Hints:

- To skip the folders menu when you load a MP3/JPEG disc, set the MP3/JPEG NAV setting in the Preference Setup Page to { Without Menu }.
- Only the first session of a multi-session CD will be played back.
- It is normal to experience an occasional 'skip' while listening to your MP3/WMA disc due to poor clarity of digital contents during internet downloading.
- If any special characters are present in the MP3/WMA track name (ID3) or album name, it might not be displayed correctly on the screen because this unit does not support the characters.

Disc Operations (continued)

Playing a JPEG image file (slide show)

Before you start ...

Turn on your TV to the correct Video In channel. See 'Finding the correct viewing channel' for details.

- Insert a JPEG photo CD (Kodak Picture CD, JPEG).
 - For a Kodak disc, the slide show begins automatically.
 - For a JPEG disc, the picture menu appears on the TV. Press **▶||** to start the slide-show playback.

Helpful Hint:

– It may require longer time for this unit to display the disc content on the TV due to the large number of songs/pictures compiled into one disc.

Supported file format:

- The file extension has to be '*.JPG' and not '*.JPEG'.
- This unit can only display digital camera pictures according to the JPEG-EXIF format, typically used by almost all digital cameras. It cannot display Motion JPEG, progressive JPEG and other JPEG formats, or pictures in formats other than JPEG, or sound clips associated with pictures.

Preview function

- ① During playback, press **■**.
 - 12 thumbnail pictures will be displayed on the TV.

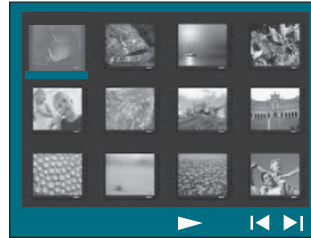

- ② Press **◀ / ▶** to display the other pictures on the previous/next page.
- ③ Use **◀▶▲▼** keys to select one of the pictures and press **OK** to start playback.
- ④ Press **DISC MENU** to return to Picture CD menu.

Zoom picture

- ① During playback, press **ZOOM** repeatedly to select a different zoom factor.
- ② Use **◀▶▲▼** keys to pan through the zoomed image.

Rotating/flipping the picture

- During playback, use **◀▶▲▼** keys to rotate/flip the picture on the TV.
 - ▲ : flip the picture vertically
 - ▼ : flip the picture horizontally
 - ◀ : rotate the picture anti-clockwise
 - ▶ : rotate the picture clockwise

Disc Operations (continued)

Playing MP3/WMA music and JPEG pictures simultaneously

You can create a musical slide show if the disc contains both the MP3/WMA music and JPEG picture files.

- 1 Insert a MP3/WMA disc that contains music and pictures.
- 2 Select a track in the menu and press ►|| to start playback.
- 3 During music playback, use ▲▼ keys to select a picture file from the disc menu and press **OK**.
 - The picture files will be played back through to the end of the folder.
 - The music keeps playing back and will be repeated if reaches the end of the selected album, playlist or track.
- 4 To stop simultaneous playback, press **DISC MENU** followed by ■.

Playing a DivX disc

This unit supports the playback of DivX movies which you can copy from your computer onto a recordable disc. See 'Setup Menu Options - { General Setup Page - DivX(R) VOD code }' for details.

- 1 Insert a DivX disc.
- 2 Use ◀▶▲▼ keys to navigate to the title you want to play.
- 3 Press **OK** to start playback.

During playback;

- If the DivX disc has multilingual subtitles, you can press **SUBTITLE** on the remote control to change the subtitle language.
- If the DivX title has different audio tracks, you can press **AUDIO** on the remote control to change the audio stream.
- Use ◀◀ / ▶▶ keys on the remote control to perform fast reverse/forward search.
- Press **DISPLAY** repeatedly until the Time Search menu appears, key in the time where playback should start.
 - Playback skips to the time entered.

Helpful Hints:

- Subtitle files with the following file name extensions (.srt, .smi, .sub, .ssa, .ass) are supported but do not appear on the file navigation menu.
- The subtitle file name has to be the same as the file name of the movie.
- The subtitle can only be displayed up to an average of 45 characters.

Setup Menu Options

Accessing the setup menu

This system setup is carried out via the TV, enabling you to customise this unit to suit your particular requirements.

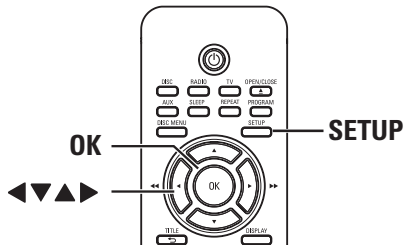

- 1 In disc mode, press **SETUP** on the remote control.
→ The setup menu appears.
- 2 Use ◀▶ keys to select one of the setup menu options and press **OK**.



- If you are not able to access the { Preference Page }, press **SETUP** to exit the menu. Then, press **STOP** ■ twice before you press the **SETUP** again.
- 3 Use ▲▼ keys to select a setup option and press ▶ to access.
 - 4 Select the setting you wish to change and press **OK** to confirm and go back to the previously selected item.
→ Instructions and explanations of the options are provided in the following pages.
→ If the option in the menu is grayed out, that means the setting is not available or cannot be changed in the current state.
 - 5 To exit, press **SETUP**.

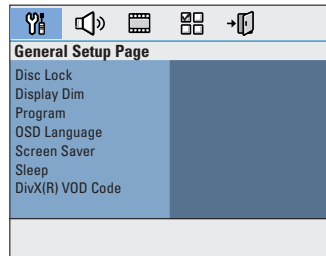

see page 33

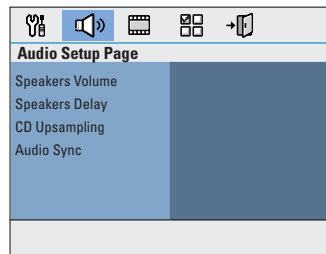

see page 34

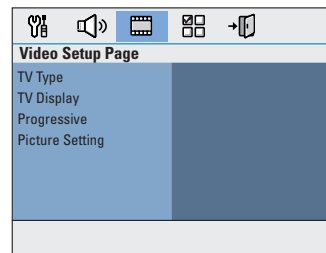

see page 35

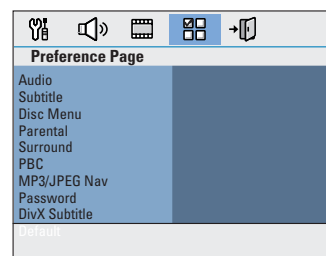

see pages 36~37

Setup Menu Options (continued)

General Setup Page (underlined options are the factory default settings)

Disc Lock

Not all discs are rated or coded by the disc maker. You can prevent play of specific discs with the disc lock function. Up to 40 discs can be locked.

- { **Lock** } – To block the playback of the current disc. Subsequent access to a locked disc requires a six-digit password. The default password is '136900' (see 'Preference Setup Page - { Password }').
- { **Unlock** } – All discs can be played.

Display Dim

Select the brightness of this unit's display panel.

- { **100%** } – Full brightness.
- { **70%** } – Medium brightness.
- { **40%** } – Dimmest display. This switches off all LEDs and icons on the front display panel of this unit

Program

Access the track programming menu. See 'Programming disc tracks' for details.

OSD Language

Select the menu language for this unit's on-screen display.

Screen Saver

The screen saver prevents damage to the TV screen by avoiding exposure to a static image for too long.

- { **On** } – Switch to TV screen saver mode when playback has been stopped or paused for more than 5 minutes.
- { **Off** } – Turn off the screen saver function.

Sleep

The sleep timer enables the unit to switch to standby mode automatically after the selected preset time.

- { **15/30/45/60 mins** } – Select the preset minutes for switching the unit to standby mode automatically.
- { **Off** } – Turn off the sleep mode function.

DivX(R) VOD Code

Philips provides you with the DivX® VOD (Video On Demand) registration code that allows you to rent or purchase videos from DivX® VOD service at www.divx.com/vod. All the downloaded videos from DivX® VOD can only be played back on this unit.

Press ► to see the registration code and press **OK** to exit.

Setup Menu Options (continued)

Audio Setup Page (underlined options are the factory default settings)

Speakers Volume Access the speaker's level setup menu. Use ◀ ▶ keys to adjust the volume level for each connected speaker between -6dB to +6dB. See 'Getting Started - Setting the speakers' channels'.

Speakers Delay Access the speaker's distance setup menu. Use ◀ ▶ keys to set the delay times for the centre and rear speakers based on the listening position and distance. See 'Getting Started - Setting the speakers' channels'.

Note: 1 ms increase/decrease of delay time is equivalent to one (1) foot change in distance. Use the longer delay time settings when the rear speakers are closer to the listener than the front speakers.

CD Upsampling This feature enables you to convert the music CD to a higher sampling rate using sophisticated digital signal processing for better sound quality.

{ **Off** } – Turn off CD-upsampling.
 { **88.2 kHz (X2)** } – To convert the sampling rate of the CDs twice as high as the original rate.

Notes:

- If you have activated the CD upsampling feature, the audio output automatically switches to stereo mode.
- If you press the SURROUND button on the remote control to select multi-channel mode, it turns off the CD upsampling feature.

Audio Sync This feature allows you to adjust the audio delay times if the video playback is slower than the audio output streams.

Use ◀ ▶ keys to set the delay times for the audio output between 0~200ms.

Setup Menu Options (continued)

Video Setup Page (underlined options are the factory default settings)

TV Type

Select the colour system that matches the connected TV. It enables playback of a different type of disc (PAL or NTSC disc) on this unit.

- { PAL } – For PAL-system TV.
- { NTSC } – For NTSC-system TV.
- { Multi } – For TV that is compatible with both PAL and NTSC.

TV Display

The picture shape can be adjusted to fit your TV.

{ 4:3 Pan Scan } – For a full-height picture with the sides trimmed.



{ 4:3 Letter Box } – For a 'wide-screen' display with black bars on the top and bottom.



{ 16:9 Wide Screen } – For wide-screen TV (frame ratio 16:9).



Progressive

Before enabling the progressive scan feature, you must ensure that your TV can accept progressive signals (a progressive scan TV is required) and that you have connected this unit to your TV using the Y Pb Pr. See 'Getting Started - Setting up progressive scan feature' for details.

- { On } – Turn on progressive scan mode. Read the instructions on the TV and confirm your action by pressing **OK** on the remote control.
- { Off } – Turn off the progressive scan mode.

Picture Setting

This unit provides three predefined sets of picture colour settings and one personal setting which you can define yourself.

- { Standard } – Original colour setting.
- { Bright } – Vibrant colour setting.
- { Soft } – Warm colour setting.
- { Personal } – Select this to personalise the picture colour setting. Use ◀▶ keys to adjust to the setting that best suits your personal preference and press **OK** to confirm. For an average setting, select { 0 }.

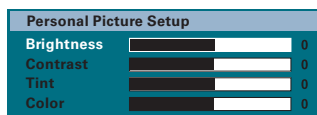

Setup Menu Options (continued)

Preference Page (underlined options are the factory default settings)

Audio

Select the preferred audio language for DVDs with multiple sound tracks or VCDs with multiple audio channels.

Subtitle

Select the preferred subtitle language for DVD playback.

Disc Menu

Select the preferred disc menu language for DVD playback.

Note: If the selected audio/subtitle/disc menu language is not available on the DVD, the disc's default language will be used instead.

Parental

This is to prohibit viewing of discs that had exceeded the limits you set. It works only on the DVDs with parental level assigned to the complete disc or to certain scenes on the disc.

- 1) Use **▲▼** keys to select a rating level from 1 to 8 and press **OK**.
- 2) Use the **numeric keypad 0-9** on the remote control to enter your six-digit password.

Notes:

- The ratings are country-dependent ('I' is considered material that is least offensive and '8' is most offensive). To disable parental controls and allow all discs to play, select '8'.
- Some DVDs are not encoded with a rating though the movie rating may be printed on the disc cover. The rating level feature does not prohibit playback of such discs. VCD, SVCD and CD have no level indication, so parental control has no effect on these type of discs.
- DVDs that are rated higher than the level you selected will not be played unless you enter the same six-digit password.

Surround

Set the preferred surround setting when the unit is powered up.
 { **On** } – Turn on to multi-channel surround mode.
 { **Last Setting** } – Turn on to the last surround setting.

PBC

Play Back Control feature is applicable for VCD/SVCD only. It allows you to play Video CDs (2.0) interactively, following the menu on the display.

- { **On** } – The index menu (if available) appears on the TV when you load a VCD/SVCD.
- { **Off** } – The VCD/SVCD skips the index menu and playback directly from the beginning.

Setup Menu Options (continued)

Preference Page (underlined options are the factory default settings)

MP3/JPEG Nav

MP3/JPEG Navigator can only be set if the disc is recorded with a menu. It allows you to select different display menus for easy navigation.

{ **Without Menu** } – Display all the files contained in the MP3/Picture disc.

{ With Menu } – Display the folder menu of the MP3/Picture disc.

Note: This unit can only display 650 files/folder in the directory.

Password

The password is used for the Disc Lock and Parental. The default password is '136900'. To change the password:

1) Press **OK** to access the change password menu.

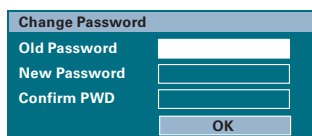

Change Password	
Old Password	<input type="text"/>
New Password	<input type="text"/>
Confirm PWD	<input type="text"/>
<input type="button" value="OK"/>	

2) Use the **numeric keypad 0-9** on the remote control to enter your existing six-digit password at { Old Password }.

Note: When doing this for the first time or if you forget your existing password, key in '136900'.

3) Enter the new six-digit password at { New Password }.

4) Enter the new six-digit password again at { Confirm PWD }.

5) Press **OK** to confirm and exit the menu.

DivX Subtitle

Select the font type that supports the recorded DivX subtitle.

{ **Central Europe** } – Display Central Europe fonts.

{ **Cyrillic** } – Display Cyrillic fonts.

{ **Greek** } – Display Greek subtitle fonts.

{ Standard } – Display a standard list of Roman subtitle fonts provided by this unit.

{ **Hebrew** } – Display Hebrew subtitle fonts.

{ **Chinese (Simp)** } – Display Simplified Chinese fonts.

{ **Korean** } – Display Korean fonts.

Default

This feature enables you to reset all the setup menu options and your personal settings to the factory defaults, except your password for the Disc Lock and Parental.

Press **OK** to confirm the default reset.

Radio Operations

Before you start ...

Make sure the FM and AM/MW antennas are connected.

Tuning to radio stations

- 1 Press **SOURCE** repeatedly until 'FM' appears on the display panel (or press **RADIO** on the remote control).
- 2 Press ◀ / ▶ on the remote control to start tuning.
→ The frequency indication starts to change until a radio station with sufficient signal strength is found.
- 3 Repeat step 2 if necessary until you find the desired radio station
- 4 To fine-tune the reception of a weak station, press ▲ / ▼ briefly and repeatedly until an optimal reception is found.

Presetting radio stations

You can store up to 40 FM and 20 AM/MW preset radio stations in the memory. There are three different ways to program the radio stations:

- Using auto install (for first time setup only)
- Using automatic preset
- Using manual preset

Helpful Hints:

- This unit exits presetting mode if no button is pressed within 20 seconds.
- If no stereo signal is detected or less than 5 (five) stations are detected during radio installation, 'CHECK ANTENNA' appears.

Using auto install

When you access the 'RADIO' mode for the very first time, you will be prompted to install the radio stations. With this feature, you can install all the available radio station automatically with one touch of button.

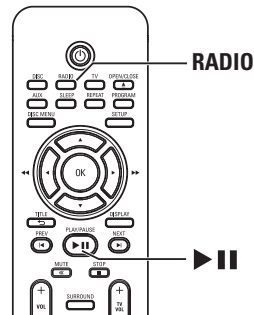

- 1 Press **RADIO**.
→ 'AUTO INSTALL ... PRESS PLAY' appears.

Radio Operations (continued)

- 2 Press **▶II**.
 - This unit starts searching from the FM band followed by the AM/MW band.
 - All the available radio stations with strong signal will be stored automatically.
 - Once complete, the first tuned radio station will be played back.

Using automatic preset

Use automatic presetting to store or reinstall all the preset radio stations.

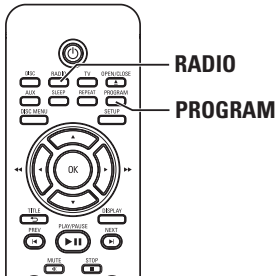

- 1 Press **RADIO** to select 'FM' or 'AM/MW' band.
- 2 Press and hold **PROGRAM** until 'START ...' appears on the display panel.
 - All previously stored radio stations will be replaced.

Using manual preset

Use manual presetting to store your favourite radio stations.

- 1 Tune to your desired radio station (see 'Tuning to radio stations').
- 2 Press **PROGRAM**.
- 3 Use **◀ / ▶** keys to select a preset number that you want to store the current radio station.
- 4 Press **PROGRAM** to store.

Selecting a preset radio station

- 1 Press **RADIO** to select 'FM' or 'AM/MW' band.
- 2 Use **◀ / ▶** keys to select a preset radio station (or use the numeric keypad on the remote control).
 - The preset number and radio frequency appear on the display panel.

Deleting a preset radio station

- 1 In radio mode, use **◀ / ▶** keys to select a preset radio station.
- 2 Press and hold **■** until 'FM/AM/MW X DELETED' appears.
 - 'X' is the preset number.
 - The radio station continues to play but has been deleted from the preset list.
 - The rest of the preset radio stations remain unchanged.

Sound and Volume Controls

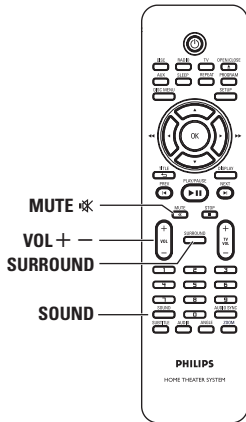

Volume control

- Press **VOL + / -** to increase or decrease the volume level.
→ 'VOL MIN' is the minimum volume level and 'VOL MAX' is the maximum volume level.

To turn off the volume temporarily

- Press **MUTE** .
→ Playback continues without sound and 'MUTE' appears.
→ To restore the volume, press **MUTE** again, or increase the volume level.

Selecting surround sound

- Press **SURROUND** to select between Multi-Channel or Stereo sound.
→ The availability of the various surround sound modes depends on the sound available on the disc.
→ The available output modes for Multi-channel include: Dolby Digital Surround and Dolby Pro Logic II.
→ Stereo broadcasts or recordings will produce some surround channel effects when played in a surround mode.

Selecting digital sound effects

Select a preset digital sound effect that matches your disc's content or that optimises the sound of the musical style you are playing.

- Press **SOUND** to select the available sound effect.

Movies	Music	Description
CONCERT	CLASSIC	Flat and pure sound mode. Ideal for listening to classical music and watching live concert DVDs.
DRAMA	JAZZ	Clear mid and high range. Recreates the atmosphere of a live club with the artist just in front of you. Good for jazz music and watching dramas.
ACTION	ROCK	Enhanced low and high range for great sounding movie effects and atmosphere. Great for action movies and rock/pop music.
MTV	RnB	Enhanced low and mid range for groovy and punchy sounds. Suitable for R&B, Hip Hop and MTV videos.
GAMING	PARTY	Slightly enhanced low range and strong mid range ideal for party music and video gaming.
CARTOONS	LOUNGE	Moderate sound mode suitable for lounge music and watching cartoons.
SPORTS	SPORTS	Moderate mid range and surround effects for clear vocals and the atmosphere of a live sports venue.
NEWS	NEWS	Enhanced mid range for clear vocals/speech.
NIGHT	NIGHT	Dynamically controlled sound mode suitable for watching movies at night or for non-intrusive background music.

Installing the latest software

Periodically Philips will issue software upgrades to enhance the user experience.

- 1 Get the software version of this unit by pressing **OPEN/CLOSE**  to open the disc compartment
- 2 Press **DISPLAY** on the remote control.
→ Write down the information for your current software version.
- 3 Visit the Philips website 'www.philips.com/support' to check the availability of the latest software upgrade and download the software to a CD-R.
- 4 Insert the CD-R to the disc tray.
→ The software starts to install on this unit automatically.

Note:

Never unplug or turn off this unit during the upgrade.

- 5 When the disc compartment opens, remove the CD-R.
→ The software upgrading is in process.
- 6 Once complete, it turns off to standby mode automatically.

Setting the Sleep timer

The sleep timer enables this unit to switch to standby mode automatically at a preset time.

- Press **SLEEP** on the remote control repeatedly to select a preset switch-off time. (15, 30, 45, 60 minutes or OFF).
→ Before this unit switches to the standby mode, a countdown of 60 seconds is displayed.
'SLEEP60' → 'SLEEP 59'.... → 'SLEEP1' → 'SLEEP'

To cancel the sleep timer

- Press **SLEEP** repeatedly to select 'OFF' or press the  (STANDBY-ON) button.

Troubleshooting

WARNING

Under no circumstances should you try to repair the system yourself, as this will invalidate the warranty. Never open the system as there is a risk of electric shock.

If a fault occurs, first check the points listed below before taking the system for repair. If you are unable to solve a problem by following these instructions, consult your dealer or Philips for help.

Problem (General)	Solution
No power.	<ul style="list-style-type: none"> – Press STANDBY-ON on the unit to turn on the power. – Make sure the mains cord is properly connected and the AC outlet has power.
No picture.	<ul style="list-style-type: none"> – Refer to your TV's manual for correct Video In channel selection. Change the TV channel until you see the DVD screen. – Press DISC to select disc mode.
Completely distorted picture or black/white picture.	<ul style="list-style-type: none"> – Check the video connection. – Sometimes a small amount of picture distortion may appear. This is not a malfunction. – The disc is dirty. Clean the disc.
No sound or distorted sound.	<ul style="list-style-type: none"> – Adjust the volume. – Check the speaker connections and settings. – Make sure that the audio cables are connected and press SOURCE to select the correct input source (for example, TV or AUX) to choose the device that you want to hear through this unit. – When playback of DTS audio track, sound will be muted even though video is playback. In this case, press AUDIO to select other audio track.
No surround sound effect from the speakers.	<ul style="list-style-type: none"> – Press SURROUND to select a correct surround sound setting. – Make sure that the source you are playing is recorded or broadcast in surround sound (Dolby Digital, etc).
The remote control does not function properly.	<ul style="list-style-type: none"> – Select the source you want to play (for example, DISC or RADIO) before pressing the function button (▶, ◀ / ▶). – Reduce the distance between the remote control and this unit. – Batteries are weak, replace the batteries. – Point the remote control directly toward the IR sensor.

Troubleshooting (continued)

Problem (Playback)	Solution
The unit does not start playback.	<ul style="list-style-type: none">– Insert a readable disc with the playback side facing down. The DVD+R/CD-R must be Finalised.– Make sure the disc is not scratched or warped.– Press SETUP to turn off the system setup menu screen.– You may need to enter the password in order to unlock the disc for playback.– Moisture may have condensed inside this unit. Remove the disc and leave this unit turned on for about an hour.
The aspect ratio of the screen cannot be changed even though you have set the TV display.	<ul style="list-style-type: none">– The aspect ratio is fixed on the DVD disc.– Depending on the TV, it may not be possible to change the aspect ratio.
Cannot activate some features e.g. Angles, Subtitles, or multi-language Audio.	<ul style="list-style-type: none">– The features may not be available on the DVD.– Changing the language for the sound or subtitle is prohibited on this DVD.
Not able to select some items in the setup/system menu.	<ul style="list-style-type: none">– Press STOP button twice before selecting the system setup menu.– Depending on the disc availability, some menu items cannot be selected.
Unable to play DivX movies.	<ul style="list-style-type: none">– Ensure that the DivX file is encoded according to the 'Home Theatre Profile' with the DivX encoder.– Check that the DivX movie downloaded is a complete file.
Radio reception is poor.	<ul style="list-style-type: none">– If the signal is too weak, adjust the antenna or connect an external antenna for better reception.– Increase the distance between this unit and your TV or VCR.– Tune in to the correct frequency.– Place the antenna further away from any equipment that may be causing the interference.
The unit does not work.	<ul style="list-style-type: none">– Disconnect the power cord from the power outlet for a few minutes. Reconnect the power cord and try to operate again as usual.

Glossary

Analogue audio: Sound that has not been turned into numbers. Analogue sound is available with you use the AUDIO LEFT/ RIGHT. These red and white sockets send audio through two channels, the left and right.

Aspect ratio: Aspect ratio refers to the length to height ratio of TV screens. The ratio of a standard TV is 4:3, while the ratio of a high-definition or wide TV is 16:9. The letter box allows you to enjoy a picture with a wider perspective on a standard 4:3 screen.

AUDIO OUT sockets: Red and white sockets on the back of the unit that send audio to another system (TV, Stereo, etc)..

Bit Rate: The amount of data used to hold a given length of music; measured in kilobits per second, or kbps. Or, the speed at which you record. Generally, the higher the bit rate, or the higher the recording speed, the better the sound quality. However, higher bit rates use more space on a disc.

Chapter: Sections of a picture or a music piece on a DVD that are smaller than titles. A title is composed of several chapters. Each chapter is assigned a chapter number enabling you to locate the chapter you want.

Composite video (CVBS): A single video signal commonly used in most consumer video products.

Disc menu: A screen display prepared for allowing a selection of images, sounds, subtitles, multi-angles, etc., recorded on a DVD.

DivX: The DivX code is a patent-pending, MPEG-4 based video compression technology, developed by DivX Networks, Inc., that can shrink digital video to sizes small enough to be transported over the internet, while maintaining high visual quality.

Dolby Digital: A surround sound system developed by Dolby Laboratories containing up to six channels of digital audio (front left and right, surround left and right, centre and subwoofer).

Dolby Surround Pro Logic II: It is an improved matrix decoding technology that provides better spatiality and directionality on Dolby Surround programme material, provides a convincing three dimensional sound field on conventional stereo music recordings and is ideally suited to bring the surround experience to automotive sound. While conventional surround programming is fully compatible with Dolby Surround Pro Logic II decoders, soundtracks will be able to be encoded specifically to take full advantage of Pro Logic II playback, including separate left and right surround channels. (Such material is also compatible with conventional Pro Logic decoders).

JPEG: A very common digital still picture format. A still-picture data compression system proposed by the Joint Photographic Expert Group, which features small decrease in image quality in spite of its high compression ratio. Files are recognised by their file extension 'JPG or JPEG'.

MP3: A file format with a sound data compression system. 'MP3' is the abbreviation of Motion Picture Experts Group 1 (or MPEG-1) Audio Layer3. By using the MP3 format, one CD-R or CD-RW can contain about 10 times more data than a regular CD.

MPEG: Motion Picture Experts Group. A collection of compression systems for digital audio and video.

Multi-channel: DVDs are formatted to have each sound track constitute one sound field. Multi-channel refers to a structure of sound tracks having three or more channels.

PBC: Playback Control. A system of navigating a Video CD/Super VCD through on-screen menus recorded onto the disc. You can enjoy interactive playback and searching.

Progressive Scan: The progressive scan displays twice the number of frames per second than in an ordinary TV system. It offers higher picture resolution and quality.

Region code: A system allowing discs to be played only in the region designated. This unit will only play discs that have compatible region codes. You can find the region code of your unit by looking at the product label. Some discs are compatible with more than one region (or ALL regions).

Surround: A system for creating realistic three dimensional sound fields full of realism by arranging multiple speakers around the listener.

Title: The longest section of a movie or music feature on DVD. Each title is assigned a title number, enabling you to locate the title you want.

WMA: Windows Media™ Audio. Refers to an audio compression technology developed by Microsoft Corporation. WMA data can be encoded by using Windows Media Player version 9 or Windows Media Player for Windows XP. Files are recognised by their file extension 'WMA'.

Specifications

AMPLIFIER

Total output power
Home Theatre mode: 200 W
Frequency Response: 180 Hz – 18 kHz / ± 3 dB
Signal-to-Noise Ratio: > 60 dB (A-weighted)
Input Sensitivity
- AUX In: 500 mV
- TV In: 250 mV

RADIO

Tuning Range: FM 87.5–108 MHz (50kHz)
MW 531–1602 kHz (9kHz)
26 dB Quieting
Sensitivity: FM 22 dBf, MW 5000 μ V/m
IF Rejection Ratio: FM 60 dB, MW 24 dB
Signal-to-Noise Ratio: FM 50 dB, MW 30 dB
MW Suppression Ratio: FM 30 dB
Harmonic Distortion: FM Mono 3%
FM Stereo 3%
MW 5%
Frequency Response FM 180 Hz–9 kHz / ± 6 dB
Stereo Separation FM 26 dB (1 kHz)
Stereo Threshold FM 23.5 dB

DISC

Laser Type Semiconductor
Disc Diameter 12cm / 8cm
Video Decoding MPEG-1 / MPEG-2 /
/ DivX 3/4/5/6
Video DAC 12 Bits
Signal System PAL / NTSC
Video Format 4:3 / 16:9
Video S/N 56 dB
Composite Video
Output 1.0 Vp-p, 75 Ω
Audio DAC 24 Bits / 96 kHz
Frequency Response 4 Hz–20 kHz (44.1 kHz)
4 Hz–22 kHz (48 kHz)
4 Hz–44 kHz (96 kHz)
PCM IEC 60958
Dolby Digital IEC 60958, IEC 61937

MAIN UNIT

Power Supply Rating: 110~240 V; 50~60 Hz
Power Consumption: 40 W
Dimensions: 360 x 48.5 x 324.1 (mm)
(w x h x d)
Weight: 2.58 kg

FRONT AND REAR SPEAKERS

System: Full range satellite
Impedance: 4 Ω
Speaker drivers: 3" full range speaker
Frequency response: 150 Hz – 20 kHz
Dimensions: 100 x 95.5 x 83.5 (mm)
(w x h x d)
Weight: 0.47 kg/each

CENTRE SPEAKER

System: Full range satellite
Impedance: 8 Ω
Speaker drivers: 3" full range speaker
Frequency response: 150 Hz – 20 kHz
Dimensions: 100 x 95.5 x 83.5 (mm)
(w x h x d)
Weight: 0.52 kg

SUBWOOFER

Impedance: 8 Ω
Speaker drivers: 165 mm (6.5") woofer
Frequency response: 40 Hz – 150 Hz
Dimensions: 131 x 386 x 315.5 (mm)
(w x h x d)
Weight: 3.60 kg

Specifications subject to change without prior notice.

Meet Philips at the Internet
<http://www.philips.com/welcome>

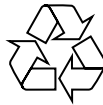

HTS3000
HTS3010



Sgpjp-0731/94-1

Free Manuals Download Website

<http://myh66.com>

<http://usermanuals.us>

<http://www.somanuals.com>

<http://www.4manuals.cc>

<http://www.manual-lib.com>

<http://www.404manual.com>

<http://www.luxmanual.com>

<http://aubethermostatmanual.com>

Golf course search by state

<http://golfingnear.com>

Email search by domain

<http://emailbydomain.com>

Auto manuals search

<http://auto.somanuals.com>

TV manuals search

<http://tv.somanuals.com>