



# CONNECTING THE LX3500D DVD HOME CINEMA SYSTEM TO YOUR PROJECTION TV (MODELS 46PP9302, 55PP9352, 60PP9352, 55PP9502, AND 60PP9502)



# PHILIPS



Cables and Wires (Supplied) Needed to Make the Connections

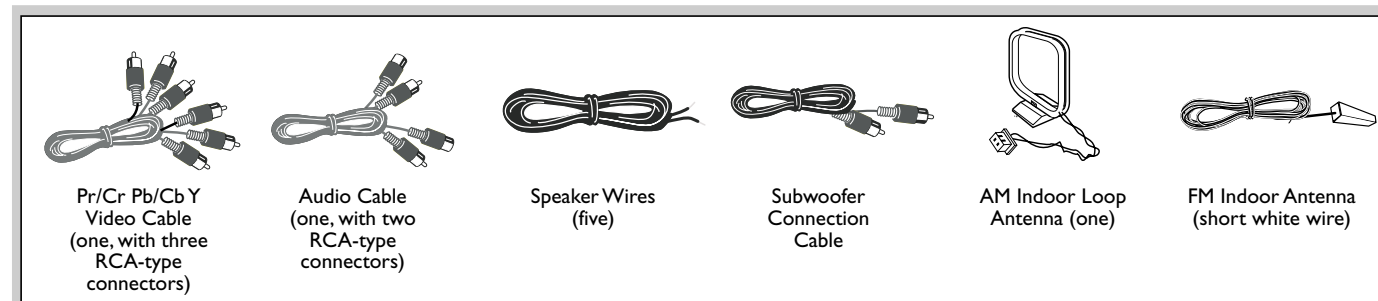

- 1** Using the supplied Pr/Cr Pb/Cb Y cable, connect from the player/receiver Pr/Cr Pb/Cb Y jacks to the TV HD INPUT-AV 4 R/Pr B/Pb G/Y jacks.
- 2** Using the supplied audio cable, connect from the TV AUDIO OUTPUT TV jacks (Left and Right) to the player/receiver AUDIO IN jacks (Left and Right).
- 3 a** Using the supplied speaker wires, connect the speakers: Connect the speaker wire with red and black tips to the player/receiver's red (+) and black (-) terminals labeled "FR." Then connect the other end of the wire to the terminals on the speaker labeled "FRONT R."  
Again matching the colors and using the labels as your guide, connect wires from the player/receiver terminals to the terminals on the left front speaker and the center speaker.
- b** As in step 3a, connect from the player/receiver to the rear speakers (surround left and right).
- c** Using the supplied subwoofer connection cable, connect from the player/receiver WOOFER LINE OUT jack to the subwoofer Audio Input jack.
- 4** Slide the P-SCAN switch (located on the back panel) to the "ON" position. This puts the DVD player in progressive-scan mode.  
**IMPORTANT:** Turn the player/receiver off before switching to progressive-scan mode. Progressive-scan mode cannot be activated when the player/receiver is on.
- 5** Connect the AM loop antenna to the AM jack by aligning the plug with the AM jack and pushing in. When the system is on, position the antenna to receive the clearest sound. Connect the FM antenna to the FM jack by pushing the black end of the wire into the center of the connector pin. When the system is on, move the antenna in various directions until the clearest signal is received.
- 6** Plug the player/receiver power cord into the AC outlet on the wall. Plug the subwoofer power cord into the AC outlet on the wall.

Back of TV (appearance of jack panel varies based on model)

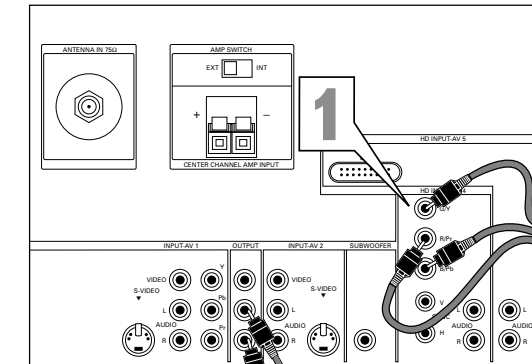

### HELPFUL HINTS

- For models 55PP9502 and 60PP9502, do not use the center channel amp input, amp switch, and subwoofer output jack on the TV with the LX3500D Home Cinema System. They will interfere with the sound quality.
- The connection shown in this example is for progressive-scan DVD, which requires that you connect to HD INPUT-AV 4 on your TV, not to the standard component video inputs (CVI), labeled Y Pb Pr, under INPUT-AV 1. Those are standard CVI jacks and are not designed to accept progressive scan (480P). See pages 6 and 7 in the TV's Directions for Use manual for more information.

AM Indoor Loop Antenna

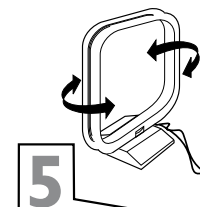

FM Indoor Antenna

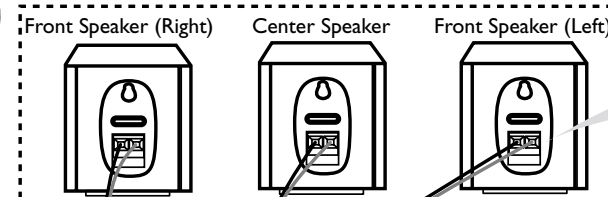
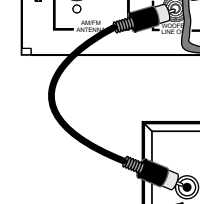

Connecting the Speaker Wires

Speaker Terminals

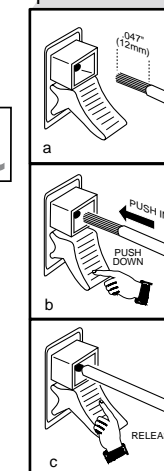

Back of Subwoofer

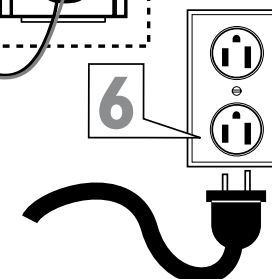
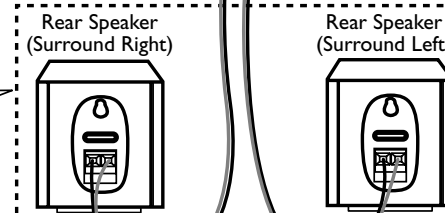

### PLACEMENT OF THE PLAYER/RECEIVER

- Place the player/receiver on a flat, hard, and stable surface.
- Leave sufficient room in front of the player/receiver for the drawer to open.
- In a cabinet, allow about 4 inches (10 cm) of free space around the player/receiver. The player/receiver needs adequate ventilation (air flow) to remain cool.
- Do not keep the player/receiver in a cabinet in an enclosed environment when the unit is ON. High-power electronics generate heat that may shorten the life of the equipment.

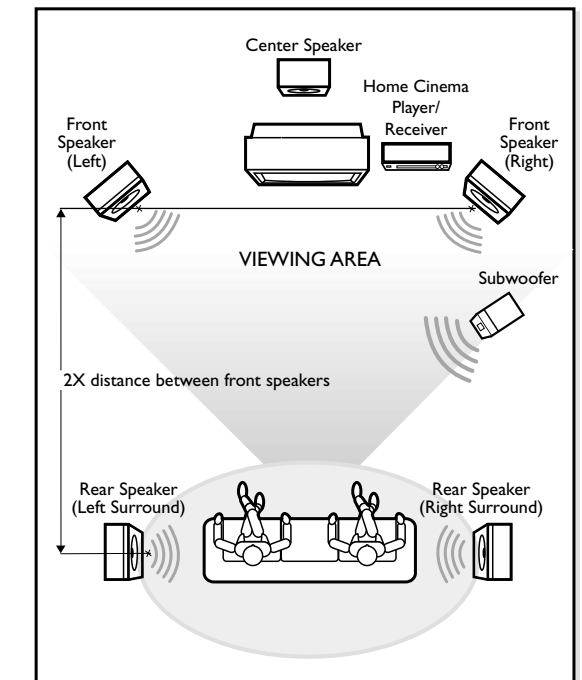

### ARRANGING THE SPEAKERS FOR BEST SOUND

For best sound, the rear speakers should be located twice the distance between the front speakers, measuring left and right from the center of the front speakers.

- 1** Mount or place the Front Left and Right speakers at equal distances from the TV. Turn the speakers to an approximate 45-degree angle from the listening position.
- 2** Mount the Center speaker or place it above (on a stand) or below the TV to localize the center channel sound.
- 3** The rear speakers should be located at listening distance or just behind the listening position. Mount or place the speakers at normal listening height, facing each other either above or aiming toward the listening position.  
**NOTE:** Do not point the front and rear speakers toward each other. This will create a sound conflict.
- 4** Place the Subwoofer anywhere away from the TV to avoid discoloring of the TV screen (magnetic interference). Since bass frequency is nondirectional, the subwoofer can be located anywhere except next to the TV.

# Quick Use Guide

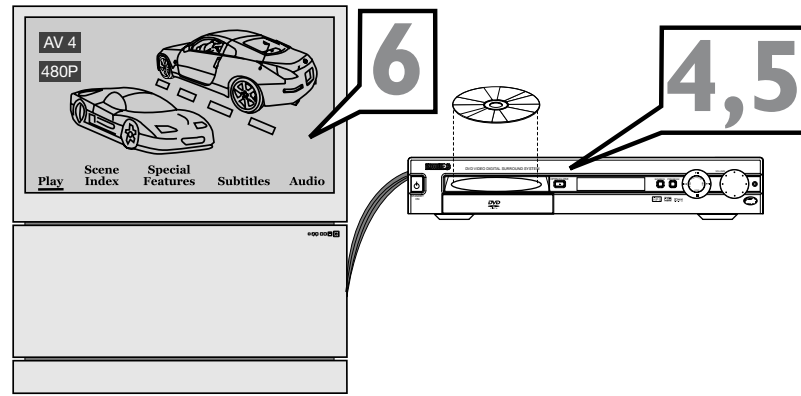
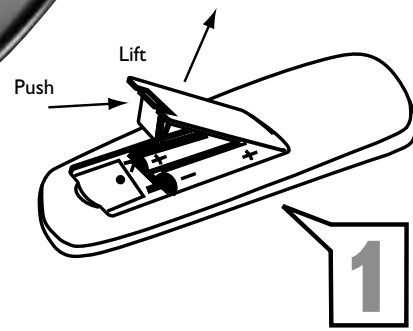

## PLAYING A DVD DISC

To play a DVD disc using the home cinema player/receiver, follow these steps:

**NOTE:** Your Philips player/receiver remote can operate your Philips TV.

- 1** Load the batteries (supplied) in the player/receiver remote. Open the battery bay door. Place the batteries in the battery bay as marked (aligned +, -). Then close the battery bay door.
- 2** Point the player/receiver remote toward the TV and press the TV/AV button repeatedly until "AV4 480P" appears on the screen. "TV/AV" will show on the player/receiver display.
- 3** Point the player/receiver remote toward the player/receiver and press DISC to put the player/receiver in DISC mode. (If a disc is already in the player/receiver, "DISC" will appear briefly on the player/receiver display.)
- 4** To place your favorite movie on the tray, press the OPEN/CLOSE button on the player/receiver. The DVD tray will eject and "OPEN" will show on the player/receiver display. With the printed side up, place your disc on the tray.
- 5** Press the OPEN/CLOSE button on the player/receiver again to retract the DVD tray. "CLOSE" and then "LOADING" will show briefly on the player/receiver display.
- 6** Watch for the selection screen (the Title or Disc menu) to appear on the TV. The illustration shown on this page is for example purposes only; screen layout and content will vary according to the DVD disc.
- 7** To move around in the selection screen, point the player/receiver remote at the player/receiver and use the "▶", "◀", "▲", "▼" buttons to highlight the desired selection.
- 8** With the item you desire selected, press the PLAY/PAUSE "▶||" button on the remote to begin playing.
- 9** To stop playing the disc, press the STOP "■" button on the player/receiver remote.

**NOTE:** If the player/receiver won't react to the remote, press the DISC button again, then press the "▶||", "◀", "▶", "▲", "▼" buttons as mentioned in the steps above to perform the desired action.

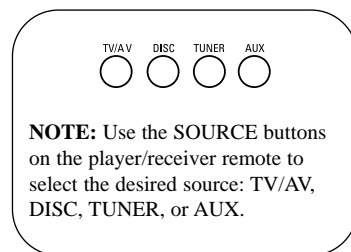
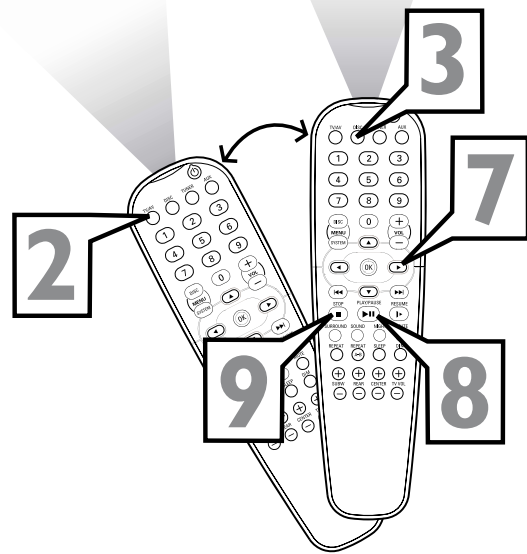

**Playable Discs**  
This home-cinema player/receiver will play the following types of Discs: pre-recorded audio CDs, finalized audio CDR and audio CDRW discs, VCDs, Super VCDs and DVDs, and MP3-CDs (CD-ROMs with MP3 tracks).

**Region Codes**  
DVDs must be labeled for ALL regions or for Region 1 in order to play on this Home Cinema system. You cannot play Discs that are labeled for other regions. If one of these logos appears on your DVD or its case, it should play on this DVD Player.

## LISTENING TO TV BROADCASTS THROUGH YOUR HOME CINEMA SYSTEM

You can also enjoy surround sound with TV broadcasts. Follow the steps below for connections and setup.

- 1** Point the player/receiver remote toward the player receiver and press the TV/AV button to put the receiver in Philips TV mode.
- 2** Point the player receiver remote toward the TV and press the "◀◀" or "▶▶" buttons to select the desired channel.

Set your TV volume to a "FIXED" output mode. This will allow you to control the volume output using the player/receiver remote.

- 3** Point the TV remote toward the TV and press the MENU/SELECT button to show the onscreen menu.
- 4** Press the CURSOR RING DOWN once to highlight SOUND.
- 5** Press the CURSOR RING RIGHT to enter the SOUND submenu.
- 6** Press the CURSOR RING DOWN repeatedly until AUDIO OUT is highlighted.
- 7** If AUDIO OUT is set to VARIABLE, press the CURSOR RING LEFT or RIGHT to select FIXED.
- 8** Press the STATUS/EXIT button to exit the menu.
- 9** **NOTE:** Although the receiver will still provide sound for the TV broadcast if you do not perform steps 3-8 above, following the steps is suggested. Otherwise, you must adjust the TV volume to balance the sound input to the receiver so as to avoid distortion.
- 10** After following steps 3-8 above, adjust your TV volume to "0." This is suggested because sound coming from the TV's speakers would interfere the surround-sound effect provided by the home cinema system.

**NOTE:** When you don't want to use the receiver for sound, all you need to do is turn up the TV volume.

- 10** Point the player/receiver remote toward the player/receiver and press the VOL + or - buttons to adjust the home cinema surround sound to the desired level.

## HELPFUL HINTS

- If the TV broadcast is in mono mode, the rear speakers will not have sound, regardless of the receiver setting (MATRIX or STEREO). This is normal.
- See the user manual for the LX3500D DVD Video Digital Surround System for instructions for tuning and listening to radio stations.

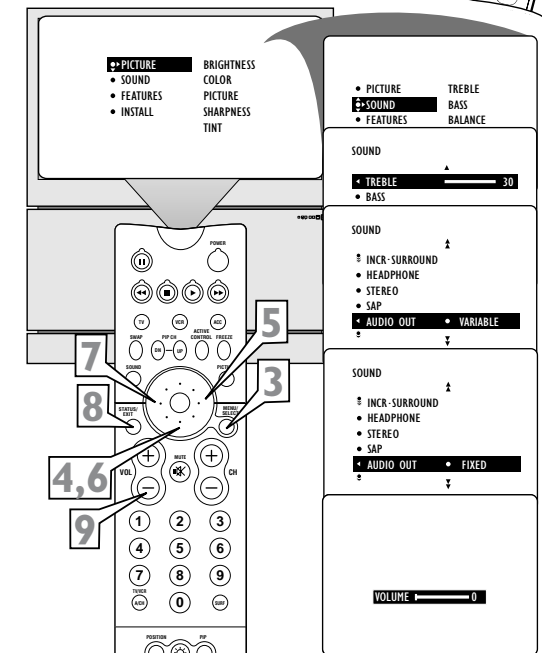
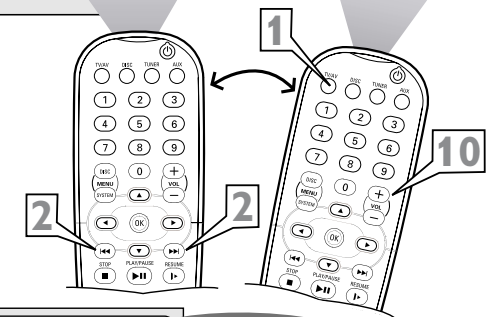

## Buttons on Your Player/Receiver Remote that You Can Use to Operate Your TV

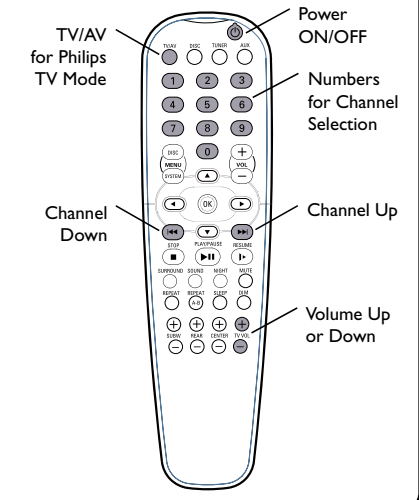

### NOTES:

- To change the player/receiver remote to Philips TV mode, you must first press the TV/AV button. Pressing any of the other source buttons (DISC, TUNER, or AUX) will take the remote out of Philips TV mode.
- You can select TV input sources by pointing the player/receiver remote toward the TV and pressing the TV/AV button. Each press of the button selects a different input source—AV1, CV1, AV2, AV3, AV4, AV5, and TV channel.

## Free Manuals Download Website

<http://myh66.com>

<http://usermanuals.us>

<http://www.somanuals.com>

<http://www.4manuals.cc>

<http://www.manual-lib.com>

<http://www.404manual.com>

<http://www.luxmanual.com>

<http://aubethermostatmanual.com>

Golf course search by state

<http://golfingnear.com>

Email search by domain

<http://emailbydomain.com>

Auto manuals search

<http://auto.somanuals.com>

TV manuals search

<http://tv.somanuals.com>