

Register your product and get support at  
[www.philips.com/welcome](http://www.philips.com/welcome)

DS8500



Thank you for choosing Philips.

### Need help fast?

Read your Quick Start Guide and/or User Manual first for quick tips that make using your Philips product more enjoyable.

If you have read your instructions and still need assistance, you may access our online help at

[www.philips.com/welcome](http://www.philips.com/welcome)  
or call

1-888-PHILIPS (744-5477)

while with your product.

(and Model / Serial number)



Philips vous remercie de votre confiance.

### Besoin d'une aide rapide?

Le Guide rapide de début et Manuel de l'utilisateur regorgent d'astuces destinées à simplifier l'utilisation de votre produit Philips.

Toutefois, si vous ne parvenez pas à résoudre votre problème, vous pouvez accéder à notre aide en ligne à l'adresse

[www.philips.com/welcome](http://www.philips.com/welcome)  
ou formez le

1-800-661-6162 (Francophone)

1-888-PHILIPS (744-5477) (English speaking)

Veillez à avoir votre produit à portée de main.

(et model / serial nombre)



Gracias por escoger Philips

### Necesita ayuda inmediata?

Lea primero la Guía rápida del comienzo o el Manual del usuario, en donde encontrará consejos que le ayudarán a disfrutar plenamente de su producto Philips.

Si después de leerlo aún necesita ayuda, consulte nuestro servicio de asistencia en línea en

[www.philips.com/welcome](http://www.philips.com/welcome)  
o llame al teléfono

1-888-PHILIPS (744-5477)

y tenga a mano el producto.

(y número de model / serial)



---

EN User manual

---

ES Manual del usuario

---

FR Mode d'emploi

---

# PHILIPS

Download from [Www.Somanuals.com](http://Www.Somanuals.com). All Manuals Search And Download.

# Canada

## English:

This digital apparatus does not exceed the Class B limits for radio noise emissions from digital apparatus as set out in the Radio Interference Regulations of the Canadian Department of Communications. This Class B digital apparatus complies with Canadian ICES-003.

## Français:

Cet appareil numérique n'émet pas de bruits radioélectriques dépassant les limites applicables aux appareils numériques de Classe B prescrites dans le Règlement sur le Brouillage Radioélectrique édicté par le Ministère des Communications du Canada. Cet appareil numérique de la classe B est conforme à la norme NMB-003 du Canada.

**The set complies with the FCC-Rules, Part 15 and with 21 CFR 1040.10. Operation is subject to the following two conditions:**

1. This device may not cause harmful interference, and
2. This device must accept any interference received, including interference that may cause undesired operation.

**L'appareil est conforme à la réglementation FCC, section 15, et à la norme 21 CFR 1040.10. Son utilisation est soumise à deux conditions :**

1. L'appareil ne doit pas provoquer d'interférences nuisibles, et
2. L'appareil doit supporter les interférences reçues, y compris les interférences empêchant son fonctionnement correct.

# Contents

---

<b>1</b>	<b>Important</b>	6
	Safety	6
	Notice	9

---

<b>2</b>	<b>Your Docking Speaker</b>	12
	Introduction	12
	What's in the box	12
	Overview of the main unit	12
	Overview of the remote control	14

---

<b>3</b>	<b>Get started</b>	16
	Prepare the remote control	16
	Connect power	17
	Turn on	18

---

<b>4</b>	<b>Play</b>	19
	Play from iPod/iPhone	19
	Play from an external device	20
	Adjust volume level	20
	Mute sound	20

---

<b>5</b>	<b>Product information</b>	21
	Specifications	21

---

<b>6</b>	<b>Troubleshooting</b>	22
----------	------------------------	----

Return your Product Registration Card or register online at  
[www.philips.com/welcome](http://www.philips.com/welcome) today to get the very most from your purchase.

Registering your model with PHILIPS makes you eligible for all of the valuable benefits listed below, so don't miss out. Complete and return your Product Registration Card at once, or register online at [www.philips.com/welcome](http://www.philips.com/welcome) to ensure:

#### \*Proof of Purchase

Returning the enclosed card guarantees that your date of purchase will be on file, so no additional paperwork will be required from you to obtain warranty service.

#### \*Product Safety Notification

By registering your product, you'll receive notification - directly from the manufacturer - in the rare case of a product recall or safety defect.

#### \*Additional Benefits

Registering your product guarantees that you'll receive all of the privileges to which you're entitled, including special money-saving offers.

## PHILIPS

**Congratulations on your purchase, and welcome to the "family!"**

**Dear PHILIPS product owner:**

Thank you for your confidence in PHILIPS. You've selected one of the best-built, best-backed products available today. We'll do everything in our power to keep you happy with your purchase for many years to come.

As a member of the PHILIPS "family," you're entitled to protection by one of the most comprehensive warranties and outstanding service networks in the industry. What's more, your purchase guarantees you'll receive all the information and special offers for which you qualify, plus easy access to accessories from our convenient home shopping network.

Most importantly, you can count on our uncompromising commitment to your total satisfaction.

All of this is our way of saying welcome - and thanks for investing in a PHILIPS product.

**P.S. To get the most from your PHILIPS purchase, be sure to complete and return your Product Registration Card at once, or register online at:**

[www.philips.com/welcome](http://www.philips.com/welcome)

Know these  
**safety symbols**



 This "bolt of lightning" indicates uninsulated material within your unit may cause an electrical shock. For the safety of everyone in your household, please do not remove product covering.

 The "exclamation point" calls attention to features for which you should read the enclosed literature closely to prevent operating and maintenance problems.

**WARNING:** To reduce the risk of fire or electric shock, this apparatus should not be exposed to rain or moisture and objects filled with liquids, such as vases, should not be placed on this apparatus.

**CAUTION:** To prevent electric shock, match wide blade of plug to wide slot, fully insert.

**ATTENTION:** Pour éviter les choc électriques, introduire la lame la plus large de la fiche dans la borne correspondante de la prise et pousser jusqu'au fond.

#### For Customer Use

Enter below the Serial No. which is located on the rear of the cabinet. Retain this information for future reference.

Model No. \_\_\_\_\_  
Serial No. \_\_\_\_\_

## PHILIPS

Visit our World Wide Web Site at <http://www.philips.com/welcome>

## PHILIPS LIMITED WARRANTY ONE (1) YEAR

### WARRANTY COVERAGE:

PHILIPS warranty obligation is limited to the terms set forth below.

### WHO IS COVERED:

Philips warrants the product to the original purchaser or the person receiving the product as a gift against defects in materials and workmanship as based on the date of original purchase ("Warranty Period") from an Authorized Dealer. The original sales receipt showing the product name and the purchase date from an authorized retailer is considered such proof.

### WHAT IS COVERED:

The Philips warranty covers new products if a defect in material or workmanship occurs and a valid claim is received by Philips within the Warranty Period. At its option, Philips will either (1) repair the product at no charge, using new or refurbished replacement parts, or (2) exchange the product with a product that is new or which has been manufactured from new, or serviceable used parts and is at least functionally equivalent or most comparable to the original product in Philips current inventory, or (3) refund the original purchase price of the product. Philips warrants replacement products or parts provided under this warranty against defects in materials and workmanship from the date of the replacement or repair for ninety (90) days or for the remaining portion of the original product's warranty, whichever provides longer coverage for you. When a product or part is exchanged, any replacement item becomes your property and the replaced item becomes Philips' property. When a refund is given, your product becomes Philips' property.

**Note: Any product sold and identified as refurbished or renewed carries a ninety (90) day limited warranty.**

**Replacement product can only be sent if all warranty requirements are met. Failure to follow all requirements can result in delay.**

### WHAT IS NOT COVERED - EXCLUSIONS AND LIMITATIONS:

This Limited Warranty applies only to the new products manufactured by or for Philips that can be identified by the trademark, trade name, or logo affixed to it. This Limited Warranty does not apply to any non-Philips hardware product or any software, even if packaged or sold with the product. Non-Philips manufacturers, suppliers, or publishers may provide a separate warranty for their own products packaged with the bundled product.

Philips is not liable for any damage to or loss of any programs, data, or other information stored on any media contained within the product, or any non-Philips product or part not covered by this warranty. Recovery or reinstallation of programs, data or other information is not covered under this Limited Warranty.

This warranty does not apply (a) to damage caused by accident, abuse, misuse, neglect, misapplication, or non-Philips product, (b) to damage caused by service performed by anyone other than Philips or Philips Authorized Service Location, (c) to a product or a part that has been modified without the written permission of

Philips, or (d) if any Philips serial number has been removed or defaced, or (e) product, accessories or consumables sold "AS IS" without warranty of any kind by including refurbished Philips product sold "AS IS" by some retailers.

### This Limited Warranty does not cover:

- Shipping charges to return defective product to Philips.
- Labor charges for installation or setup of the product, adjustment of customer controls on the product, and installation or repair of antenna/signal source systems outside of the product.
- Product repair and/or part replacement because of improper installation or maintenance, connections to improper voltage supply, power line surge, lightning damage, retained images or screen markings resulting from viewing fixed stationary content for extended periods, product cosmetic appearance items due to normal wear and tear, unauthorized repair or other cause not within the control of Philips.
- Damage or claims for products not being available for use, or for lost data or lost software.
- Damage from mishandled shipments or transit accidents when returning product to Philips.
- A product that requires modification or adaptation to enable it to operate in any country other than the country for which it was designed, manufactured, approved and/or authorized, or repair of products damaged by these modifications.
- A product used for commercial or institutional purposes (including but not limited to rental purposes).
- Product lost in shipment and no signature verification receipt can be provided.
- Failure to operate per Owner's Manual.

### TO OBTAIN ASSISTANCE IN THE U.S.A., PUERTO RICO, OR U.S. VIRGIN ISLANDS...

Contact Philips Customer Care Center at:  
1-888-PHILIPS (1-888-744-5477)

### TO OBTAIN ASSISTANCE IN CANADA...

1-800-661-6162 (French Speaking)  
1-888-PHILIPS (1-888-744-5477) - (English or Spanish Speaking)

REPAIR OR REPLACEMENT AS PROVIDED UNDER THIS WARRANTY IS THE EXCLUSIVE REMEDY FOR THE CONSUMER. PHILIPS SHALL NOT BE LIABLE FOR ANY INCIDENTAL OR CONSEQUENTIAL DAMAGES FOR BREACH OF ANY EXPRESS OR IMPLIED WARRANTY ON THIS PRODUCT. EXCEPT TO THE EXTENT PROHIBITED BY APPLICABLE LAW, ANY IMPLIED WARRANTY OF MERCHANTABILITY OR FITNESS FOR A PARTICULAR PURPOSE ON THIS PRODUCT IS LIMITED IN DURATION TO THE DURATION OF THIS WARRANTY.

Some states do not allow the exclusions or limitation of incidental or consequential damages, or allow limitations on how long an implied warranty lasts, so the above limitations or exclusions may not apply to you.

*This warranty gives you specific legal rights. You may have other rights which vary from state/province to state/province.*

Philips, P.O. Box 10313 Stamford, CT 06904

3140 035 50201

# 1 Important

---

## Safety

---

### Important Safety Instructions

- ① Read these instructions.
  - ② Keep these instructions.
  - ③ Heed all warnings.
  - ④ Follow all instructions.
  - ⑤ Do not use this apparatus near water.
  - ⑥ Clean only with dry cloth.
  - ⑦ Do not block any ventilation openings. Install in accordance with the manufacturer's instructions.
  - ⑧ Do not install near any heat sources such as radiators, heat registers, stoves, or other apparatus (including amplifiers) that produce heat.
  - ⑨ In countries with a polarized mains, do not defeat the safety purpose of the polarized or grounding-type plug. A polarized plug has two blades with one wider than the other. A grounding type plug has two blades and a third grounding prong. The wide blade or the third prong are provided for your safety. If the provided plug does not fit into your outlet, consult an electrician for replacement of the obsolete outlet. Caution: To prevent electric shock, match the wide blade of the plug to the wide slot, fully insert.
- 
- ⑩ Protect the power cord from being walked on or pinched, particularly at plugs, convenience receptacles, and the point where they exit from the apparatus.

- ⑪ Only use attachments/accessories specified by the manufacturer.
- ⑫ Use only with the cart, stand, tripod, bracket, or table specified by the manufacturer or sold with the apparatus. When a cart is used, use caution when moving the cart/apparatus combination to avoid injury from tip-over.



- ⑬ Unplug this apparatus during lightning storms or when unused for long periods of time.
- ⑭ Refer all servicing to qualified service personnel. Servicing is required when the apparatus has been damaged in any way, such as power-supply cord or plug is damaged, liquid has been spilled or objects have fallen into the apparatus, the apparatus has been exposed to rain or moisture, does not operate normally, or has been dropped.
- ⑮ **Battery usage CAUTION – To prevent battery leakage which may result in bodily injury, property damage, or damage to the unit:**
  - Install all batteries correctly, + and - as marked on the unit.
  - Do not mix batteries (old and new or carbon and alkaline, etc.).
  - Remove batteries when the unit is not used for a long time.
  - The batteries shall not be exposed to excessive heat such as sunshine, fire or the like.
- ⑯ Apparatus shall not be exposed to dripping or splashing.
- ⑰ Do not place any sources of danger on the apparatus (e.g. liquid filled objects, lighted candles).
- ⑱ This product may contain lead and mercury. Disposal of these materials may be regulated due to environmental considerations. For disposal or recycling information, please contact your local authorities or the Electronic Industries Alliance: [www.eiae.org](http://www.eiae.org).

- 19 Where the MAINS plug or an appliance coupler is used as the disconnect device, the disconnect device shall remain readily operable.



#### Warning

- Never remove the casing of this apparatus.
- Never lubricate any part of this apparatus.
- Never place this apparatus on other electrical equipment.
- Keep this apparatus away from direct sunlight, naked flames or heat.
- Ensure that you always have easy access to the power cord, plug or adaptor to disconnect the apparatus from the power.

---

## Hearing safety

### Listen at a moderate volume.

- Using headphones at a high volume can impair your hearing. This product can produce sounds in decibel ranges that may cause hearing loss for a normal person, even for exposure less than a minute. The higher decibel ranges are offered for those that may have already experienced some hearing loss.
- Sound can be deceiving. Over time your hearing 'comfort level' adapts to higher volumes of sound. So after prolonged listening, what sounds 'normal' can actually be loud and harmful to your hearing. To guard against this, set your volume to a safe level before your hearing adapts and leave it there.
- Set your volume control at a low setting.
- Slowly increase the sound until you can hear it comfortably and clearly, without distortion.
- Prolonged exposure to sound, even at normally 'safe' levels, can also cause hearing loss.
- Be sure to use your equipment reasonably and take appropriate breaks.
- Listen at reasonable volumes for reasonable periods of time.
- Be careful not to adjust the volume as your hearing adapts.
- Do not turn up the volume so high that you can't hear what's around you.



- You should use caution or temporarily discontinue use in potentially hazardous situations. Do not use headphones while operating a motorized vehicle, cycling, skateboarding, etc.; it may create a traffic hazard and is illegal in many areas.

---

## Notice

Any changes or modifications made to this device that are not expressly approved by Philips Consumer Lifestyle may void the user's authority to operate the equipment.

### Notice for the USA

**This equipment has been tested and found to comply with the limits for a Class B digital device, pursuant to part 15 of the FCC Rules.** These limits are designed to provide reasonable protection against harmful interference in a residential installation. This equipment generates, uses, and can radiate radio frequency energy and, if not installed and used in accordance with the instruction manual, may cause harmful interference to radio communications.

However, there is no guarantee that interference will not occur in a particular installation. If this equipment does cause harmful interference to radio or television reception, which can be determined by turning the equipment off and on, the user is encouraged to try to correct the interference by one or more of the following measures:

- Relocate the receiving antenna.
- Increase the separation between equipment and receiver.
- Connect the equipment into an outlet on a circuit different from that to which the receiver is connected.
- Consult the dealer or an experienced radio/TV technician for help.

---

## Disposal of your old product and batteries

Your product is designed and manufactured with high quality materials and components, which can be recycled and reused.

Never dispose of your product with other household waste. Please inform yourself about the local rules on the separate collection of electrical and electronic products and batteries. The correct disposal of these products helps prevent potentially negative consequences on the environment and human health.

Your product contains batteries, which cannot be disposed of with normal household waste.

Please inform yourself about the local rules on separate collection of batteries. The correct disposal of batteries helps prevent potentially negative consequences on the environment and human health.

Please visit [www.recycle.philips.com](http://www.recycle.philips.com) for additional information on a recycling center in your area.



#### Caution

- Removal of the built-in battery invalidates the warranty and may destroy the product.

#### Environmental information

All unnecessary packaging has been omitted. We have tried to make the packaging easy to separate into three materials: cardboard (box), polystyrene foam (buffer) and polyethylene (bags, protective foam sheet.) Your system consists of materials which can be recycled and reused if disassembled by a specialized company. Please observe the local regulations regarding the disposal of packaging materials, exhausted batteries and old equipment.



Be responsible  
Respect copyrights

The making of unauthorized copies of copy-protected material, including computer programs, files, broadcasts and sound recordings, may be an infringement of copyrights and constitute a criminal offence. This equipment should not be used for such purposes.

## Class II equipment symbol



This symbol indicates that the apparatus has a double insulation system.



### Note

- The type plate is located on the bottom of the apparatus.

# 2 Your Docking Speaker

Congratulations on your purchase, and welcome to Philips! To fully benefit from the support that Philips offers, register your product at [www.philips.com/welcome](http://www.philips.com/welcome).

---

## Introduction

With this unit, you can enjoy audio from the iPod/iPhone and other audio devices.

---

## What's in the box

Check and identify the contents of your package:

- Main unit
  - Remote control
  - 1 x AC adaptor
  - 1 x AC power cord
  - 1 x Aux-in cable
  - User manual
- 

## Overview of the main unit

## Front View

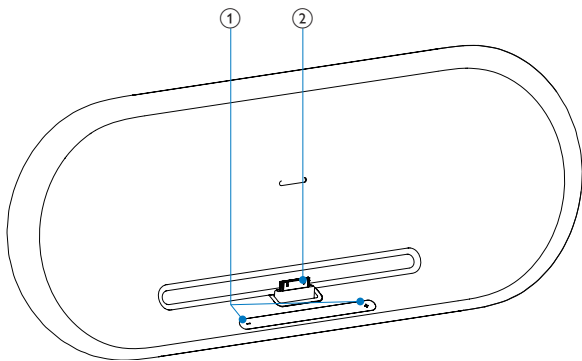

- ① - VOLUME +  
• Adjust volume.
- ② iPod/iPhone dock

## Back View

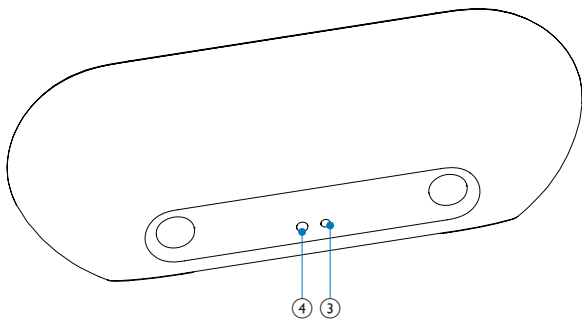

- ③ Power supply socket
- ④ AUX IN
  - Jack for an external audio device.

---

## Overview of the remote control

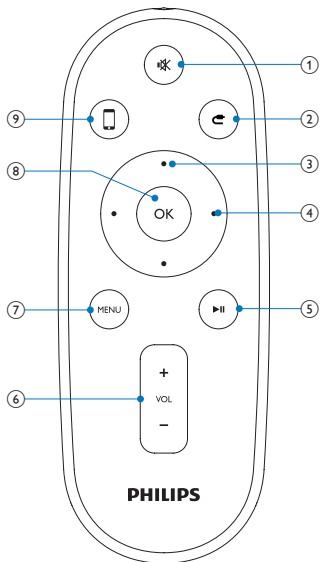

- 1 
  - Mute volume.
- 2 
  - Select Aux-in mode

- 3 Up/down keys**
- Navigate through the iPod/iPhone menu.
- 4 Fast forward/backward keys**
- Fast reverse or fast forward within a track or iPhone/iPod.
  - Skip to the previous/next track.
- 5 ►||**
- Start or pause play.
- 6 VOL +/-**
- Adjust volume.
- 7 MENU**
- Access the iPod menu.
- 8 OK**
- Confirm a selection.
- 9 □**
- Select iPod/iPhone dock mode

# 3 Get started



## Caution

- Use of controls or adjustments or performance of procedures other than herein may result in hazardous radiation exposure or other unsafe operation.

Always follow the instructions in this chapter in sequence.

If you contact Philips, you will be asked for the model and serial number of this apparatus. The model number and serial number are on the bottom of the apparatus. Write the numbers here:

Model No. \_\_\_\_\_

Serial No. \_\_\_\_\_

---

## Prepare the remote control



## Caution

- Risk of explosion! Keep batteries away from heat, sunshine or fire. Never discard batteries in fire.

**For first-time use:**

- 1** Remove the protective tab to activate the remote control battery.

**To replace the remote control battery:**

- 1** Open the battery compartment.
- 2** Insert one CR2032 battery with correct polarity (+/-) as indicated.
- 3** Close the battery compartment.



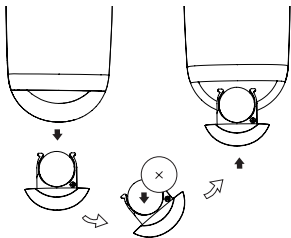

### Note

- Before pressing any function button on the remote control, first select the correct source with the remote control instead of the main unit.
- If you are not going to use the remote control for a long time, remove the battery.
- Perchlorate Material - special handling may apply. See [www.dtsc.ca.gov/hazardouswaste/perchlorate](http://www.dtsc.ca.gov/hazardouswaste/perchlorate).

## Connect power



### Caution

- Risk of product damage! Ensure that the power supply voltage corresponds to the voltage printed on the bottom of the unit.
- Risk of electric shock! When you unplug the AC adaptor, always pull the plug from the socket. Never pull the cord.
- Before connecting the AC adaptor, ensure you have completed all other connections.

- 1 Insert the plug from the AC adaptor to the **DC IN** socket on the back of the main unit.

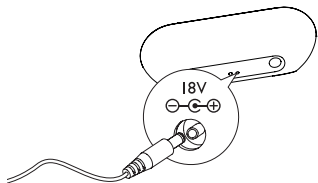

- 2** Connect one end of the AC power cord to the AC adaptor.



- 3** Connect the other end of the AC power cord to the wall outlet.



---

## Turn on

The unit turns on automatically when connected to power.

- ↳ When user approaches the unit, light LED under volume button on the main unit turns on automatically.

---

## Switch to standby

- In DOCK mode: disconnect the iPod/iPhone from the unit over 15 minutes.
  - ↳ The unit switches to Standby mode automatically.
- In Aux-in mode: the device no longer play music over 15 minutes.
  - ↳ The unit switches to Standby mode automatically.

# 4 Play

---

## Play from iPod/iPhone

You can enjoy audio from iPod/iPhone through this unit.

---

### Compatible iPod/iPhone

Apple iPod and iPhone models with a 30-pin dock connector. Made for :

- iPod nano (2nd generation)
- iPod nano (3rd generation)
- iPod nano (4th generation)
- iPod nano (5th generation)
- iPod classic
- iPod touch (1st generation)
- iPod touch (2nd generation)
- iPod touch (3rd generation)
- iPhone
- iPhone 3G
- iPhone 3GS.

---

### Load the iPod/iPhone

- 1** Place the iPod/iPhone in the dock.

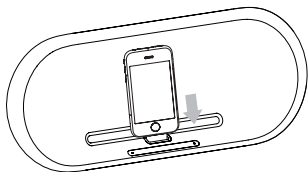



### Remove the iPod/iPhone

- 1** Pull the iPod out of the dock.

---

## Listen to the iPod/iPhone

- 1 Ensure that the iPod/iPhone is loaded correctly.
- 2 Press  to select DOCK mode.
- 3 Press .
  - ↳ The connected iPod/iPhone starts play.
    - To pause/resume play, press .
    - To skip to a track, press fast forward/backward keys.
    - To search during play, press and hold fast forward/backward keys, then release to resume normal play.
    - To navigate the menu, press **MENU**, then press up/down keys to select, and press **OK** to confirm.

---

## Charge the iPod/iPhone

When the unit is connected to power, the docked iPod/iPhone begins to charge.

---

## Play from an external device

You can also listen to an external audio device through this unit.

- 1 Press  to select Aux-in mode.
  - 2 Connect the supplied Aux-in cable to:
    - the **AUX IN** jack (3.5mm) on the back of the unit.
    - the headphone jack on an external device.
  - 3 Start to play the device (see the device user manual).
- 

## Adjust volume level

- 1 During play, press **VOL +/-** to increase/decrease the volume level.
- 

## Mute sound

- 1 During play, press **MUTE** to mute/unmute sound.

# 5 Product information



## Note

- Product information is subject to change without prior notice.

---

## Specifications

### Amplifier

Rated Output Power	2X15 W RMS
Signal to Noise Ratio	85 dB
AUX IN	0.6 V RMS 10 kohm

---

### General information

AC power (power adaptor)	OH-1048A1802500U-U Input: 100-240V~, 50/60Hz, 1.5A MAX; Output: 18V $\equiv$ 2.5A;
Operation Power Consumption	40W
Standby Power Consumption	<1W
Dimensions	
- Main Unit (W x H x D)	158 x 420 x 139 mm
Weight	
- Main Unit	3.32 kg

# 6 Troubleshooting



## Warning

- Never remove the casing of this apparatus.

To keep the warranty valid, never try to repair the system yourself.

If you encounter problems when using this apparatus, check the following points before requesting service. If the problem remains unsolved, go to the Philips web site ([www.philips.com/welcome](http://www.philips.com/welcome)). When you contact Philips, ensure that the apparatus is nearby and the model number and serial number are available.

### No power

- Ensure that the AC power plug of the unit is connected properly.
- Ensure that there is power at the AC outlet.

### No sound

- Adjust the volume.

### No response from the unit

- Disconnect and reconnect the AC power plug, then turn on the unit again.

Philips Consumer Lifestyle  
A division of Philips Electronics North America Corporation  
P.O. Box 10313  
Stamford, CT 06904  
Phone: 1-888-PHILIPS (744-5477)

Meet Philips at the Internet  
<http://www.philips.com/welcome>



© 2010 Koninklijke Philips Electronics N.V.

All rights reserved.

Document order number: DS8500\_37\_UM\_V1.2



100% recycled paper  
100% papier recyclé

## Free Manuals Download Website

<http://myh66.com>

<http://usermanuals.us>

<http://www.somanuals.com>

<http://www.4manuals.cc>

<http://www.manual-lib.com>

<http://www.404manual.com>

<http://www.luxmanual.com>

<http://aubethermostatmanual.com>

Golf course search by state

<http://golfingnear.com>

Email search by domain

<http://emailbydomain.com>

Auto manuals search

<http://auto.somanuals.com>

TV manuals search

<http://tv.somanuals.com>