



Thank you for choosing Philips.

Need help fast?

Read your *Quick Start Guide* and/or *User Manual* first for quick tips that make using your Philips product more enjoyable.

If you have read your instructions and still need assistance, you may access our online help at

www.philips.com/support or call

1-888-PHILIPS (744-5477) while with your product. (and Model / Serial number)



Philips vous remercie de votre confiance.

Besoin d'une aide rapide?

Les *Guide d'utilisation rapide* et *Manuel de l'utilisateur* regorgent d'astuces destinées à simplifier l'utilisation de votre produit Philips.

Toutefois, si vous ne parvenez pas à résoudre votre problème, vous pouvez accéder à notre aide en ligne à l'adresse

www.philips.com/support ou formez le

1-800-661-6162 (Francophone)
1-888-PHILIPS (744-5477) (English speaking)

Veillez à avoir votre produit à portée de main. (et model / serial nombre)



Gracias por escoger Philips

Necesita ayuda inmediata?

Lea primero la *Guía de uso rápido* o el *Manual del usuario*, en donde encontrará consejos que le ayudarán a disfrutar plenamente de su producto Philips.

Si después de leerlo aún necesita ayuda, consulte nuestro servicio de asistencia en línea en

www.philips.com/support o llame al teléfono

1-888-PHILIPS (744-5477) y tenga a mano el producto. (y número de model / serial)



PHILIPS

Note : This equipment has been tested and found to comply with the limits for a Class B digital device, pursuant to part 15 of the FCC Rules. These limits are designed to provide reasonable protection against harmful interference in a residential installation. This equipment generates, uses, and can radiate radio frequency energy and, if not installed and used in accordance with the instruction manual, may cause harmful interference to radio communications. However, there is no guarantee that interference will not occur in a particular installation. If this equipment does cause harmful interference to radio or television reception, which can be determined by turning the equipment off and on, the user is encouraged to try to correct the interference by one or more of the following measures :

- Relocate the receiving antenna.
- Increase the separation between the equipment and receiver
- Connect the equipment into an outlet on a circuit different from that to which the receiver is connected.
- Consult the dealer or an experienced radio/TV technician for help.

IMPORTANT !

modifications not authorized by the manufacturer may void users authority to operate this device.

Remarque : Cet équipement a été testé et a été certifié conforme aux limites imposées pour un appareil numérique de Classe B, conformément à la partie 15 des règlements FCC. Ces limites sont définies aux fins d'assurer une protection raisonnable contre les interférences nuisibles dans une installation résidentielle. Cet équipement génère, utilise et émet des fréquences radio qui, en cas d'une mauvaise installation ou d'une utilisation non-conforme aux instructions de ce manuel d'utilisation peuvent causer des interférences nuisibles aux communications radio. Il n'y a toutefois aucune garantie que des interférences nuisibles ne se produiront pas dans une installation donnée. Si cet équipement cause des interférences nuisibles avec votre poste radio ou de télévision, ce que vous pouvez déterminer en éteignant et en rallumant votre équipement, il est conseillé à l'utilisateur d'essayer de pallier à ces interférences nuisibles en prenant l'une ou l'autre des mesures suivantes:

- Changez la position de l'antenne de réception.
- Augmentez la séparation entre l'équipement et le récepteur.
- Branchez l'équipement sur une source d'alimentation différente de celle sur laquelle le récepteur est branché.
- Consultez votre distributeur ou un technicien qualifié en la matière pour assistance.

IMPORTANTE !

las modificaciones no autorizadas por el fabricante pueden anular la autoridad de los usuarios para utilizar este aparato.

Nota : Este aparato ha sido probado y cumple con los límites correspondientes a un aparato digital de Clase B, según la parte 15 de las Normas FCC. Estos límites han sido diseñados para facilitar suficiente protección frente a interferencias perjudiciales en una instalación residencial. Este aparato genera, utiliza y puede emitir energía de frecuencias de radio y, si no se instala y utiliza según el manual de instrucciones, puede provocar interferencias perjudiciales en las comunicaciones de radio. Sin embargo, no existe garantía de que las interferencias no ocurrirán en una instalación particular. Si este aparato provoca interferencias perjudiciales en la recepción de radio o televisión, que se puede identificar encendiendo y apagando el aparato, recomendamos al usuario que intente solucionar las interferencias siguiendo una o más de las siguientes medidas:

- Cambie la posición de la antena receptora.
- Aumente la separación entre el aparato y el receptor.
- Conecte el aparato a una toma de un circuito diferente al que está conectado el receptor.
- Consulte con el distribuidor o un técnico de radio/TV con experiencia para que le ayuden.

¡IMPORTANTE!

modificações não autorizadas pelo fabricante, podem causar danos na operação deste aparelho.

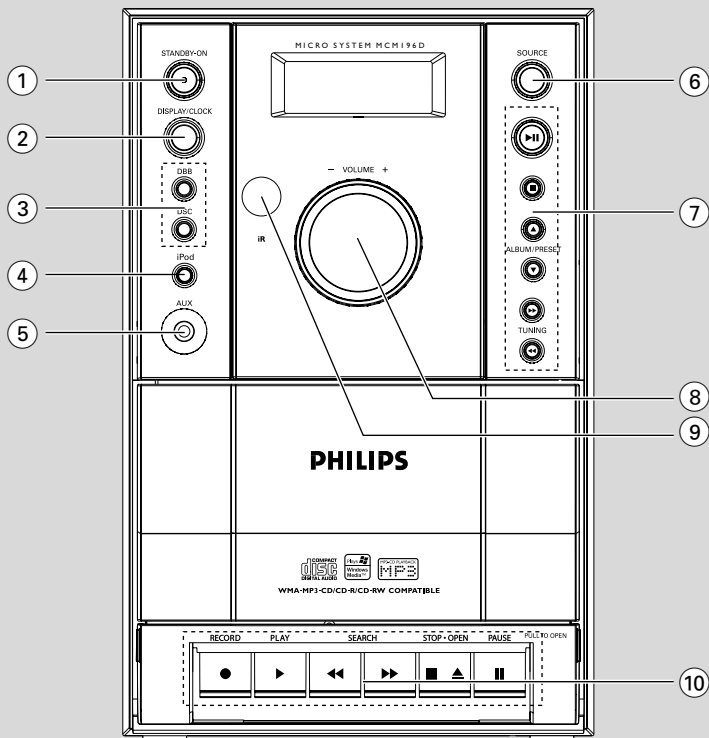
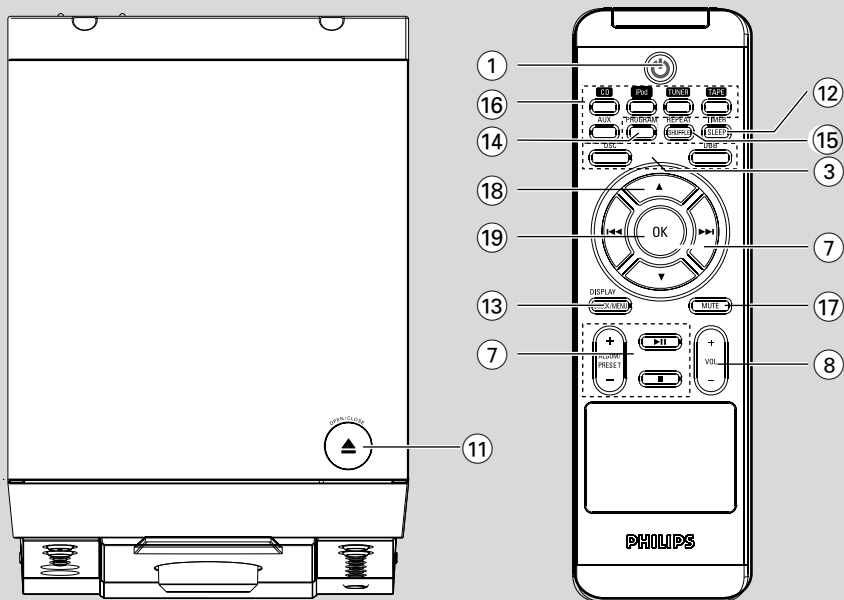

**Return your Product Registration Card or register online at
www.philips.com/usasupport today to get the very most from your purchase.**

Registering your model with PHILIPS makes you eligible for all of the valuable benefits listed below, so don't miss out. Complete and return your Product Registration Card at once, **or register online at www.philips.com/usasupport** to ensure:

***Proof of Purchase**

Returning the enclosed card guarantees that your date of purchase will be on file, so no additional paperwork will be required from you to obtain warranty service.

***Product Safety Notification**

By registering your product, you'll receive notification - directly from the manufacturer - in the rare case of a product recall or safety defect.

***Additional Benefits**

Registering your product guarantees that you'll receive all of the privileges to which you're entitled, including special money-saving offers.

PHILIPS

Congratulations on your purchase, and welcome to the "family!"

Dear PHILIPS product owner:

Thank you for your confidence in PHILIPS. You've selected one of the best-built, best-backed products available today. We'll do everything in our power to keep you happy with your purchase for many years to come. As a member of the PHILIPS "family," you're entitled to protection by one of the most comprehensive warranties and outstanding service networks in the industry. What's more, your purchase guarantees you'll receive all the information and special offers for which you qualify, plus easy access to accessories from our convenient home shopping network.

Most importantly, you can count on our uncompromising commitment to your total satisfaction.

All of this is our way of saying welcome - and thanks for investing in a PHILIPS product.

P.S. To get the most from your PHILIPS purchase, be sure to complete and return your Product Registration Card at once, or register online at:

www.philips.com/usasupport

Know these **safety** symbols



This "bolt of lightning" indicates un-insulated material within your unit may cause an electrical shock. For the safety of everyone in your household, please do not remove product covering.

The "exclamation point" calls attention to features for which you should read the enclosed literature closely to prevent operating and maintenance problems.

WARNING: To reduce the risk of fire or electric shock, this apparatus should not be exposed to rain or moisture and objects filled with liquids, such as vases, should not be placed on this apparatus.

CAUTION: To prevent electric shock, match wide blade of plug to wide slot, fully insert.

ATTENTION: Pour éviter les choc électriques, introduire la lame la plus large de la fiche dans la borne correspondante de la prise et pousser jusqu'au fond.

For Customer Use

Enter below the Serial No. which is located on the rear of the cabinet. Retain this information for future reference.

Model No. _____
 Serial No. _____

PHILIPS

Visit our World Wide Web Site at <http://www.philips.com/usasupport>

IMPORTANT SAFETY INSTRUCTIONS

1. **Read these instructions.**
2. **Keep these instructions.**
3. **Heed all warnings.**
4. **Follow all instructions.**
5. **Do not use this apparatus near water.**
6. **Clean only with dry cloth.**
7. **Do not block any ventilation openings. Install in accordance with the manufacturer's instructions.**
8. **Do not install near any heat sources** such as radiators, heat registers, stoves, or other apparatus (including amplifiers) that produce heat.

9. **Do not defeat the safety**

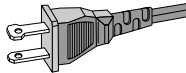

AC Polarized Plug

- purpose** of the polarized or grounding-type plug. A polarized plug has two blades with one wider than the other. A grounding type plug has two blades and a third grounding prong. The wide blade or the third prong are provided for your safety. If the provided plug does not fit into your outlet, consult an electrician for replacement of the obsolete outlet.
10. **Where the MAINS plug or an appliance coupler is used as the disconnect device, the disconnect device shall remain readily operable.**
 11. **Protect the power cord** from being walked on or pinched, particularly at plugs, convenience receptacles, and the point where they exit from the apparatus.
 12. **Only use attachments/accessories** specified by the manufacturer.

13. **Use only with the cart,** stand tripod, bracket, or table specified by the manufacturer or sold with the apparatus. When a cart is

used, use caution when moving the cart /apparatus combination to avoid injury from tip-over.

14. **Unplug this apparatus** during lightning storms or when unused for long periods of time.
15. **Refer all servicing** to qualified service personnel. Servicing is required when the apparatus has been damaged in any way, such as power-supply cord or plug is damaged, liquid has been spilled or objects have fallen into the apparatus, the apparatus has been exposed to rain or moisture, does not operate normally, or has been dropped.

16. **Battery usage CAUTION** – To prevent battery leakage which may result in bodily injury, property damage, or damage to the unit:

Install **all** batteries correctly, **+** and **-** as marked on the unit.

Do not mix batteries (**old** and **new** or **carbon** and **alkaline**, etc.).

Remove batteries when the unit is not used for a long time.

17. **Apparatus shall not be exposed to dripping or splashing.**
18. **Do not place any sources of danger on the apparatus** (e.g. liquid filled objects, lighted candles).
19. This product may contain lead and mercury. Disposal of these materials may be regulated due to environment considerations.
For disposal or recycling information, please contact your local authorities or the Electronic Industries Alliance: www.eiae.org.

EL 6475-S004: 03/12

Class II equipment symbol



This symbol indicates that the unit has a double insulation system

Canada

English:

This digital apparatus does not exceed the Class B limits for radio noise emissions from digital apparatus as set out in the Radio Interference Regulations of the Canadian Department of Communications.

Français:

Cet appareil numérique n'émet pas de bruits radioélectriques dépassant les limites applicables aux appareils numériques de Class B prescrites dans le Règlement sur le Brouillage Radioélectrique édicté par le Ministère des Communications du Canada.

CAUTION

Use of controls or adjustments or performance of procedures other than herein may result in hazardous radiation exposure or other unsafe operation.

ATTENTION

L'utilisation des commandes ou réglages ou le non respect des procédures ci-incluses peuvent se traduire par une exposition dangereuse à l'irradiation.

ATENCIÓN

El uso de mando o ajustes o la ejecución de métodos que no sean los aquí descritos puede ocasionar peligro de exposición a radiación.

English 6

Français 28

Español 50

English

Français

Español

Contents

General Information

Supplied accessories	9
Environmental information	9
Safety information	9-10

Preparations

Rear connections	11-12
Inserting batteries into the remote control	12

Controls

Controls on the system and remote control	13
Controls buttons available on the remote control only	13

Basic Functions

Plug and play (for tuner installation)	14
Switching the system on	15
Adjusting volume and sound	15

CD/MP3 Operation

Loading a disc	16
Basic playback controls	16
Playing an MP3/WMA disc	16-17
Different play modes: Shuffle and Repeat	17
Programming track numbers	17
Reviewing the programme	17
Erasing the programme	17

Radio Reception

Tuning to radio stations	18
Programming radio stations	18
Automatic programming	
Manual programming	
Tuning to preset radio stations	18

Tape Operation / Recording

Tape playback	19
General information on recording	19
Synchro start CD recording	19-20
Recording from the radio	20

Maintenance

Other Connection

Listening to an external source	20
---------------------------------------	----

Clock/Timer

Setting the clock	21
Setting the timer	21
Activating and deactivating TIMER	21
Activating and deactivating SLEEP	21

Dock for iPod

Playing iPod using the dock.....	22
Compatible portable player	
Dock	
Dock adaptor	
Selecting the correct dock adaptor	
Installing the dock adaptor	
Removing the dock adaptor.....	22
Playing iPod.....	23
Charging iPod battery using the dock	23

Specifications

Troubleshooting

This set complies with the FCC rules, Part 15 and with 21 CFR 1040.10.

Operation is subject to the following two conditions:

- **This device may not cause harmful interference, and**
- **This device must accept any interference received, including interference that may cause undesired operation.**

Supplied accessories

- 2 speaker boxes
- remote control
- AM loop antenna
- Docking kit
 - 1 dock used for Apple iPod
 - Dock adaptors (8 adaptors for different iPod types)

Environmental Information

All unnecessary packaging has been omitted. We have tried to make the packaging easy to separate into three materials: cardboard (box), polystyrene foam (buffer) and polyethylene (bags, protective foam sheet).

Your system consists of materials which can be recycled and reused if disassembled by a specialized company. Please observe the local regulations regarding the disposal of packaging materials, exhausted batteries and old equipment.

Safety Information

- Before operating the system, check that the operating voltage indicated on the typeplate (or the voltage indication beside the voltage selector) of your system is identical with the voltage of your local power supply. If not, please consult your dealer.
- Place the system on a flat, hard and stable surface.
- The apparatus shall not be exposed to dripping or splashing.
- Install the unit near the AC outlet and where the AC power plug can be easily reached.

- Place the system in a location with adequate ventilation to prevent internal heat build-up in your system. Allow at least 10 cm (4 inches) clearance from the rear and the top of the unit and 5 cm (2 inches) from each side.
- The ventilation should not be impeded by covering the ventilation openings with items, such as newspapers, table-cloths, curtains, etc.
- Do not expose the system, batteries or discs to excessive moisture, rain, sand or heat sources caused by heating equipment or direct sunlight.
- No naked flame sources, such as lighted candles, should be placed on the apparatus.
- No objects filled with liquids, such as vases, shall be placed on the apparatus.
- If the system is brought directly from a cold to a warm location, or is placed in a very damp room, moisture may condense on the lens of the disc unit inside the system. Should this occur, the CD player would not operate normally. Leave the power on for about one hour with no disc in the system until normal playback is possible.
- The mechanical parts of the set contain self-lubricating bearings and must not be oiled or lubricated.
- **When the system is switched to Standby mode, it is still consuming some power. To disconnect the system from the power supply completely, remove the AC power plug from the wall socket.**

Hearing Safety

Listen at a moderate volume.

- Using headphones at a high volume can impair your hearing. This product can produce sounds in decibel ranges that may cause hearing loss for a normal person, even for exposure less than a minute. The higher decibel ranges are offered for those that may have already experienced some hearing loss.
- Sound can be deceiving. Over time your hearing "comfort level" adapts to higher volumes of sound. So after prolonged listening, what sounds "normal" can actually be loud and harmful to your hearing. To guard against this, set your volume to a safe level before your hearing adapts and leave it there.

To establish a safe volume level:

- Set your volume control at a low setting.
- Slowly increase the sound until you can hear it comfortably and clearly, without distortion.

Listen for reasonable periods of time:

- Prolonged exposure to sound, even at normally "safe" levels, can also cause hearing loss.
- Be sure to use your equipment reasonably and take appropriate breaks.

Be sure to observe the following guidelines when using your headphones.

- Listen at reasonable volumes for reasonable periods of time.
- Be careful not to adjust the volume as your hearing adapts.
- Do not turn up the volume so high that you can't hear what's around you.
- You should use caution or temporarily discontinue use in potentially hazardous situations.
- Do not use headphones while operating a motorized vehicle, cycling, skateboarding, etc.; it may create a traffic hazard and is illegal in many areas.

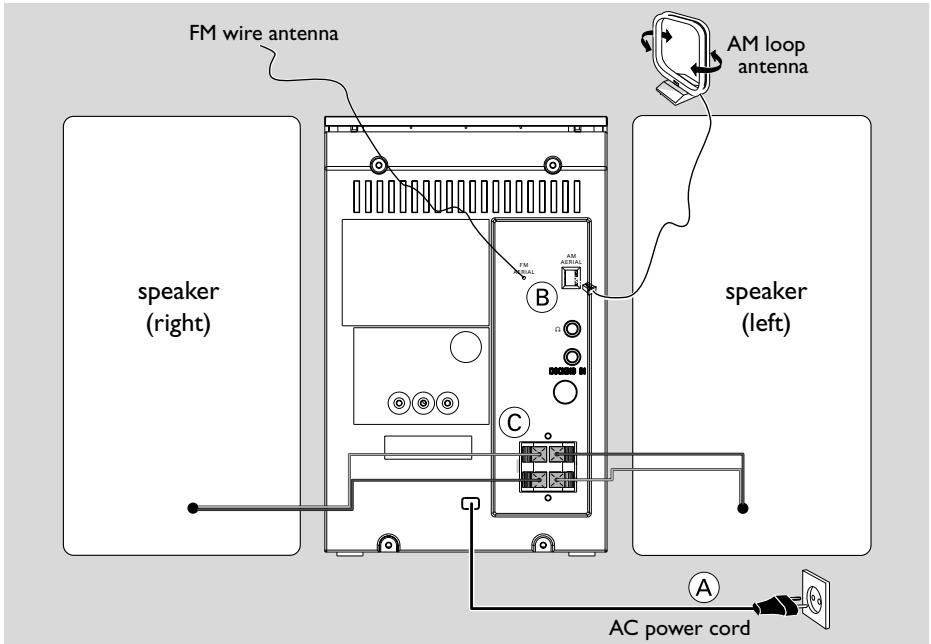

Rear connections

The type plate is located at the rear of the system.

A Power

Before connecting the AC power cord to the wall outlet, ensure that all other connections have been made.

WARNING!

- For optimal performance, use only the original power cable.
- Never make or change any connections with the power switched on.

To avoid overheating of the system, a safety circuit has been built in. Therefore, your system may switch to Standby mode automatically under extreme conditions. If this happens, let the system cool down before reusing it (not available for all versions).

B Antenna Connection

AM Antenna

Connect the supplied AM loop antenna to the "AM aerial" terminal. Adjust the position of the antenna for optimal reception.

- Position the antenna as far as possible from a TV, VCR or other radiation source.

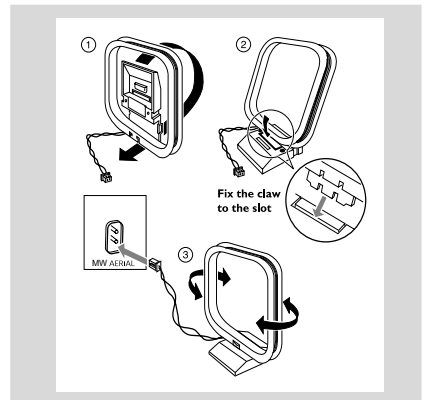

Preparations

FM Antenna

It is unnecessary to connect the FM pigtail antenna since it is fixed to the main unit.

- Adjust the FM antenna for optimal FM stereo reception.

C Speakers Connection

Front Speakers

Connect the speaker wires to the SPEAKERS terminals, right speaker to "RIGHT", and left speaker to "LEFT", coloured (marked) wire to "+" and black (unmarked) wire to "-".

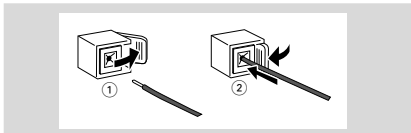

- Fully insert the stripped portion of the speaker wire into the terminal as shown.

Notes:

- For optimal sound performance, use the supplied speakers.
- Do not connect more than one speaker to any one pair of + / - speaker terminals.
- Do not connect speakers with an impedance lower than the speakers supplied. Please refer to the SPECIFICATIONS section of this manual.

Before using the remote control

- 1 Pull out the plastic protective sheet.
- 2 Select the source you wish to control by pressing one of the source select keys on the remote control (for example CD, TUNER).
- 3 Then select the desired function (for example ►, ◀, ▶).

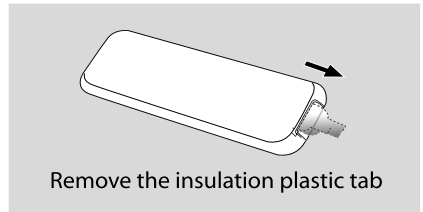

Replacing battery (lithium CR2025) into the remote control

- 1 Push to open the battery tray.
- 2 Replace a new battery according to the indicated polarity.
- 3 Push the battery tray back to close it.

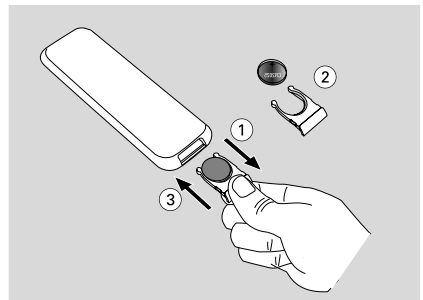

CAUTION!

- Remove battery if it is exhausted or will not be used for a long time.
- Batteries contain chemical substances, so they should be disposed of properly.
- Perchlorate Material-special handling may apply. See www.dtsc.ca.gov/hazardouswaste/perchlorate.

Controls on the system and remote control

- ① **STANDBY ON (⏻)**
 – switches the system to standby/Eco-power stanadby/on.
- ② **DISPLAY/CLOCK**
 for CD displays the current track number or total remaining time (or ID3 information for MP3 disc) during playback.
 * for clock..... sets the clock function
- ③ **INTERACTIVE SOUND controls:**
DBB (Dynamic Bass Boost) enhances the bass.
DSC (Digital Sound Control) selects sound characteristics: JAZZ/POP/CLASSIC/ROCK.
- ④ **iPod**
 – selects iPod source
- ⑤ **AUX jack**
 – connects an external source (3.5 mm socket)
- ⑥ **SOURCE**
 – selects the respective sound source for CD/iPod/TUNER/TAPE/AUX.
 – switches on the system.
- ⑦ **Mode Selection**
▶| starts or interrupts CD playback.
■ stops CD playback or erases a CD programme.
 deactivates timer function.
ALBUM/PRESET ▼ ▲
 for radio selects a preset radio station.
 for MP3 disc selects an album.
TUNING ◀◀ ▶▶
 for Tuner tunes to radio stations.
 for CD skips to the beginning of the current/previous/subsequent track.
 fast searches back and forward within a track/CD.
 for clock/timer adjusts the hours and minutes for the clock/timer function
- ⑧ **VOLUME (VOL -/+)**
 – adjusts the volume level.
- ⑨ **iR**
 – infrared sensor for remote control.

- ⑩ **Tape Deck Operation**
RECORD ● ... starts recording.
PLAY ▶ starts playback.
SEARCH ◀◀ / ▶▶ fast rewinds/winds the tape.
STOP•OPEN ■ ▲
 stops the tape; opens the tape compartment.
PAUSE II interrupts recording or playback.
- ⑪ **OPEN•CLOSE ▲**
 – opens/closes the CD door.

Controls available on the remote control only

- ⑫ **TIMER/SLEEP**
 – * activates or sets the timer function.
 – activates/deactivates or selects the sleeper time.
- ⑬ **DISPLAY/CLOCK/MENU**
 * for clock sets the clock function.
 for CD displays the current track number or total remaining time (or ID3 information for MP3 disc) during playback.
 for iPod..... equivalent to the MENU button on your iPod player.
- ⑭ **PROGRAM**
 for CD programmes tracks and reviews the programme.
 for Tuner programmes tuner stations manually or automatically.
- ⑮ **REPEAT/SHUFFLE**
 – repeats a track/disc/all programmed tracks.
 – plays CD/MP3 tracks in random order.
- ⑯ **CD/iPod/TUNER/TAPE/AUX**
 – selects the respective sound source.
- ⑰ **MUTE**
 – interrupts and resumes sound reproduction
- ⑱ **▲ / ▼**
 for iPod..... selects an item in a menu.
- ⑲ **OK**
 – confirms a selection (for iPod menu operation only).

* = Press and hold the button for more than two seconds.

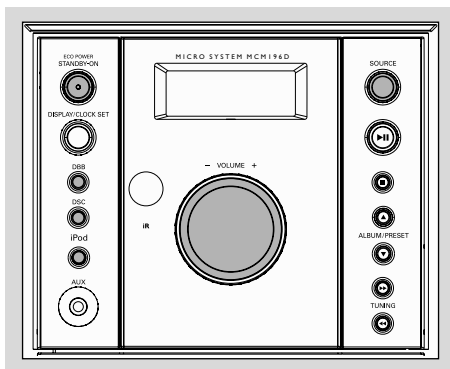

IMPORTANT:

Before you operate the system, complete the preparation procedures.

Plug and Play (for tuner installation)

Plug and Play allows you to store all available radio stations automatically.

First time setup/power up

- 1 When you turn on the main supply, "AUTO INSTALL - PRESS PLAY" is displayed.
- 2 Press ►|| on the system to start installation.
→ "PLUG AND PLAY" "INSTALL" is displayed, followed by "TUNER" and "AUTO".
→ PROG starts flashing.
→ The system will automatically store the radio stations with sufficient signal strength, starting from FM, then followed by AM band.
→ When all the available radio stations are stored or the memory for 40 presets are used, the last preset radio station will be played.

To reinstall Plug and Play

- 1 In standby mode, press and hold ►|| on the system until "AUTO INSTALL - PRESS PLAY" is displayed.
- 2 Press ►|| again to start installation.
→ All previously stored radio stations will be replaced.

To exit without storing the Plug and Play

- Press ■ on the system.
→ If you do not complete the Plug and Play installation, the function will be restarted when you next turn on the main supply again.

Notes:

- If no stereo frequency is detected during Plug and Play, "CHECK ANTENNA" will be displayed.
- During Plug and Play, if no button is pressed within 15 seconds, the system will exit Plug and Play mode.

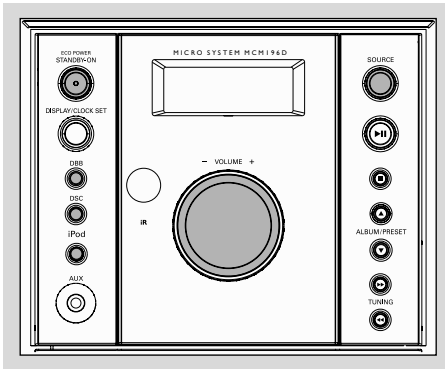



IMPORTANT:

Before you operate the system, complete the preparation procedures.

Switching the system on

- Press **STANDBY ON** or **SOURCE** (or  on the remote control).
→ The system will switch to the last selected source.
- Press **CD**, **iPod**, **TUNER**, **TAPE** or **AUX** on the remote control.
→ The system will switch to the selected source.

To switch the system to standby mode

- Press **STANDBY ON** on the system (or  on the remote control).
- If in tape mode or recording mode, press **STOP•OPEN**   first.
→ The volume level (up to a maximum volume level of 12), interactive sound settings, last selected source and tuner presets will be retained in the player's memory.

To switch the system to Eco-power standby mode

- Press and hold **STANDBY ON** ( on the remote control) for more than 2 seconds.
→ The display will go blank.

Power-saving automatic standby

The power-saving feature automatically switches to Eco power standby 15 minutes after a CD playback has ended and no control is operated.

Adjusting volume and sound

- 1 Turn the **VOLUME** control anti-clockwise to decrease or clockwise to increase volume on the system (or press **VOL -/+** on the remote control).
→ Display shows the volume level  and a number from 0-32.
 - 2 Press **DSC** repeatedly to select the desired sound effect: **JAZZ / POP / CLASSIC / ROCK**.
 - 3 Press **DBB** to switch bass enhancement on or off.
→ Display shows: **DBB** if the DBB is activated.
 - 4 Press **MUTE** on the remote control to interrupt sound reproduction instantly.
→ Playback will continue without sound.
- To activate sound reproduction you can:
 - press **MUTE** again;
 - adjust the volume controls;
 - change source.

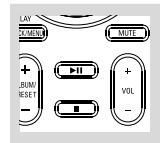

CD/MP3 Operation

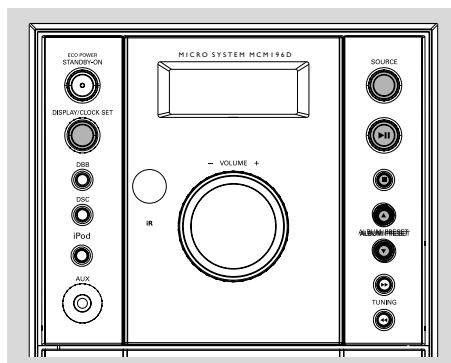

IMPORTANT:

The lens of the CD player should never be touched.

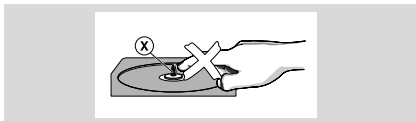

Loading a disc

This CD player plays Audio Discs including CD-Recordables, CD-Rewritables and MP3/WMA CD.

- CD-ROM, CD-I, CDV, VCD, DVD or computer CDs, however, are not possible.
- DRM-protected WMA is not supported.

- 1 Select **CD** source.

- 2 Press **OPEN/CLOSE▲** on the top of the system to open the CD compartment.
→ **OPEN** is displayed when you open the CD compartment.

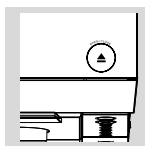

- 3 Insert a disc with the printed side facing up and press down on **OPEN/CLOSE▲** to close the CD door.
→ **READING** is displayed as the CD player scans the contents of a disc, and then the total number of tracks and playing time (or the total number of albums and tracks for MP3 disc) are shown.

Basic playback controls

To play a disc

- Press **▶II** to start playback.
→ The current track number and elapsed playing time of the track are displayed during disc playback.

To select a different track

- Press **TUNING I◀◀ ▶▶I** (on the remote control **I◀◀ ▶▶I**) once or repeatedly until the desired track number appears in the display.

To find a passage within a track

- 1 Press and hold down on **TUNING I◀◀ ▶▶I** (on the remote control **I◀◀ ▶▶I**).
→ The disc is played at high speed and low volume.
- 2 When you recognise the passage you want, release **TUNING I◀◀ ▶▶I** (on the remote control **I◀◀ ▶▶I**).
→ Normal playback continues.

To interrupt playback

- Press **▶II** during playback.
→ The display freezes and the elapsed playing time flashes when playback is interrupted.
→ To resume, press **▶II** again.

To stop playback

- Press **■**.

Notes: CD play will also stop when;

- the CD door is opened.
- the disc has reached the end.
- you select another source: **TAPE**, **iPod**, **TUNER** or **AUX**.
- you select standby.
- you press the tape deck **PLAY ▶** key.

Playing an MP3/WMA disc

- 1 Load an MP3/WMA disc.
→ The disc reading time may exceed 10 seconds due to the large number of songs compiled into one disc.
→ "ㄱㄱ x x x" is displayed. ㄱㄱ is the total album number and x x x is the total track number.
- 2 Press **ALBUM/PRESET ▼ ▲** to select a desired album.

- 3 Press **TUNING** ◀◀ ▶▶ (on the remote control ◀◀ ▶▶) to select a desired track.
→ The album number will change accordingly as you reach the first track of an album by pressing ◀◀ or the last track of an album by pressing ▶▶.
- 4 Press **▶||** to start playback.
- During playback, press **DISPLAY/CLOCK** to display the ID3 information if available.

Supported MP3 disc formats:

- ISO9660, Joliet, UDF 1.5
- Maximum title number: 256 (depending on filename length)
- Maximum album number: 32
- Supported sampling frequencies: 32 kHz, 44.1 kHz, 48 kHz
- Supported Bit-rates: 32~256 (kbps), variable bitrates

Different play modes: SHUFFLE and REPEAT

You can select and change the various play modes before or during playback. The play modes can also be combined with PROGRAMME.

- SHUF tracks of the entire disc are played in random order
- REP ALL repeats the entire disc/programme
- REP plays the current track continuously
- REP ALB repeats all tracks in the current (for MP3 only) album

- 1 To select your play mode, press the **REPEAT/SHUFFLE** button before or during playback until the display shows the desired function.
- 2 Press **▶||** to start playback if in the STOP position.
→ If you have selected SHUFFLE, playback starts automatically.
- 3 To return to normal playback, press the **REPEAT/SHUFFLE** button until the various SHUFFLE/ REPEAT modes are no longer displayed.
- You can also press ■ to cancel your play mode.

Note:

– The **SHUFFLE** and **REPEAT** functions cannot be used simultaneously.

Programming track numbers

Programme in the STOP position to select and store your disc tracks in the desired sequence. If you like, store any track more than once. Up to 40 tracks can be stored in the memory.

- 1 In the stop position, use the **TUNING** ◀◀ ▶▶ (on the remote control ◀◀ ▶▶) to select your desired track number.
- For MP3/WMA, you may press **ALBUM/PRESET** ▼ ▲ to select a desired album, then press ◀◀ ▶▶ to select your desired track.
- 2 Press **PROGRAM** to store.
→ Display: **PROG** flashes, and *PR* □ 1 is displayed briefly, then the selected track number (and the selected album number for MP3/WMA).
- 3 Repeat **steps 1-2** to select and store all desired tracks.
→ *FULL* is displayed if you attempt to programme more than 40 tracks.
- 4 To start playback of your disc programme, press **▶||**.

Reviewing the programme

- Stop playback and press **PROGRAM** repeatedly.
- To exit review mode, press ■.

Erasing the programme

You can erase the programme by:

- pressing ■ once in the STOP mode;
- pressing ■ twice during playback;
- opening the CD compartment;
→ **PROG** disappears from the display.

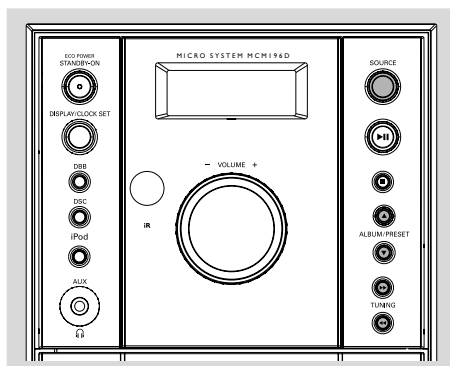

Tuning to radio stations

- 1 Select **TUNER** source.
- 2 Press **SOURCE** on the set repeatedly or press **TUNER** on the remote repeatedly until the desired waveband (FM or MW) is displayed.
- 3 Press down on **TUNING** **◀◀ ▶▶** (or **◀◀ ▶▶** on the remote control) and release button.
→ The radio automatically tunes to a station with sufficient reception. Display indication during automatic tuning: *S E R C H*.
- 4 Repeat step 3 if necessary until you find the desired station.
- To tune to a weak station, press **TUNING** **◀◀ ▶▶** (or **◀◀ ▶▶** on the remote control) briefly and repeatedly until you have found optimal reception.

Programming radio stations

You can store up to a total of 40 radio stations in the memory.

Automatic programming

Automatic programming will start with a chosen preset number. From this preset number upwards, former programmed radio stations will be overridden. The system will only programme stations which are not in the memory already.

- 1 Press **ALBUM/PRESET** **▼ ▲** to select the preset number where programming should start.

Note:

– If no preset number is selected, default is preset (1) and all your presets will be overridden.

- 2 Press **PROGRAM** for more than 2 seconds to activate programming.
→ **AUTO** is displayed and available stations are programmed in order of waveband reception strength. The first preset automatically stored will then be played.

Manual programming

- 1 Tune to your desired station (see Tuning to radio stations).
- 2 Press **PROGRAM** to activate programming.
→ **PROG** flashes in the display.
- 3 Press **ALBUM/PRESET** **▼ ▲** to allocate a number from 1 to 20 to this station.
- 4 Press **PROGRAM** again to confirm the setting.
→ **PROG** disappears, the preset number and the frequency of the preset station are shown.
- 5 Repeat the above four steps to store other stations.
- You can override a preset station by storing another frequency in its place.

Tuning to preset radio stations

- Press **ALBUM/PRESET** **▼ ▲** until the desired preset station is displayed.

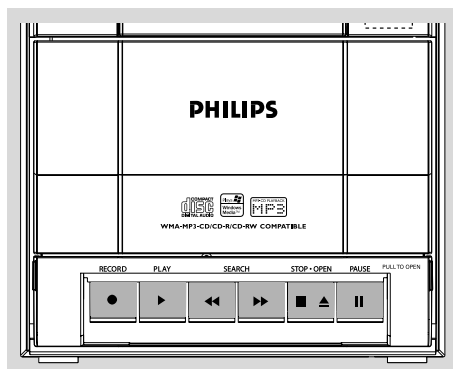

- The best recording level is set automatically. Altering the VOLUME, DBB or DSC controls will not affect the recording in progress.
- The recording sound quality might differ depending on the quality of your recording source and the recording tape.
- At the very beginning and end of the tape, no recording will take place during the 7 seconds when the leader tape passes the recorder heads.
- To protect a tape from accidental erasure, have the tape in front of you and break out the left tab. Recording on this side is no longer possible. If, however, you wish to record over this side again, cover the tabs with a piece of adhesive tape.

Tape playback

- 1 Select **TAPE** source.
→ Display: shows throughout tape operation.
- 2 Open the tape key flap marked "**PULL TO OPEN**" on the front panel.
- 3 Press **STOP•OPEN** to open the tape door.
- 4 Insert a recorded tape and close the tape door.
- Load the tape with the open side downward and the full spool to the left.
- 5 Press **PLAY** to start playback.
- The key is automatically released at the end of a tape, except if **PAUSE** has been activated.
- 6 To pause, press **PAUSE** . Press again to resume.
- 7 By pressing or on the system fast winding of tape is possible in both directions.
- 8 To stop the tape, press **STOP•OPEN** .

Note:

– The source cannot be changed while playing or recording a tape.

General information on recording

- Recording is permissible insofar as copyright or other rights of third parties are not infringed.
- For recording, use only NORMAL (IEC type I) tapes on which the tabs have not yet been broken. This deck is not suited for recording on METAL (IEC IV) type tapes.

Synchro start CD recording

- 1 Select **CD** source.
- 2 Insert a disc and if desired, programme track numbers.
- 3 Press **STOP•OPEN** to open the tape door.
- 4 Insert a suitable tape into the deck and close the tape door.
- 5 Press **RECORD** to start recording.
→ Playing of the CD programme starts automatically from the beginning of the CD after 7 seconds. It is not necessary to start the CD player separately.

To select and record a particular passage within a CD track:

- Press and hold down on . Release the control when you recognize the passage you want.
- To pause CD playback, press .
- Recording starts from this exact point in the track when you press **RECORD** .
- 6 To pause, press **PAUSE** . Press again to resume.
- 7 To stop recording, press **STOP•OPEN** .

Recording from the radio

- 1 Tune to the desired radio station (see Tuning to radio stations).
- 2 Press **STOP•OPEN** ■ ▲ to open the tape door.
- 3 Insert a suitable tape into the deck and close the tape door.
- 4 Press **RECORD** ● to start recording.
- 5 To interrupt playback press **PAUSE** II. To resume, press this key again.
- 6 To stop recording, press **STOP•OPEN** ■ ▲.

Listening to an external source

You can listen to the sound of the connected external device through your system's speakers.

- 1 Select **AUX** source.
- 2 Use a line-in cable (not supplied) to connect MCM196D's AUX jack (3.5 mm) to an AUDIO OUT or headphone jack on an external equipment (such as CD player, VCR or iPod).

Maintenance

Cleaning the Cabinet

- Use a soft cloth slightly moistened with a mild detergent solution. Do not use a solution containing alcohol, spirits, ammonia or abrasives.

Cleaning Discs

- When a disc becomes dirty, clean it with a cleaning cloth. Wipe the disc from the centre out.
- Do not use solvents such as benzene, thinner, commercially available cleaners, or antistatic spray intended for analogue records.

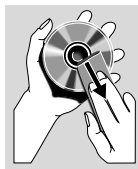

Cleaning the disc lens

- After prolonged use, dirt or dust may accumulate at the disc lens. To ensure good playback quality, clean the disc lens with Philips CD Lens Cleaner or any commercially available cleaner. Follow the instructions supplied with cleaner.

Cleaning the Heads and the Tape Paths

- To ensure good recording and playback quality, clean the heads (A), the capstan(s) (B), and pressure roller(s) (C) after every 50 hours of tape operation.
- Use a cotton swab slightly moistened with cleaning fluid or alcohol.
- You can also clean the heads by playing a cleaning tape once.

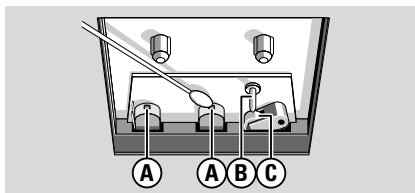

Demagnetising the heads

- Use a demagnetising tape available at your dealer.

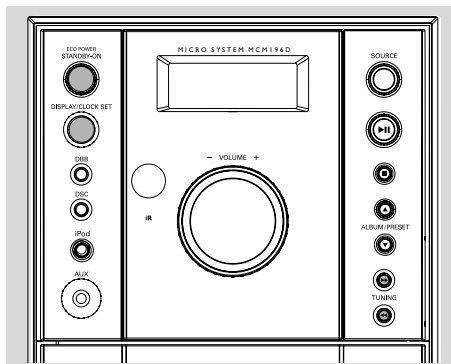

Setting the clock

- 1 In standby mode, press and hold **DISPLAY/CLOCK** (**DISPLAY/CLOCK/MENU** on the remote control) for 2 seconds.
→ The clock digits for the hours flash.
- 2 Press **TUNING** **I◀◀ ▶▶I** to set the hours.
- 3 Press **DISPLAY/CLOCK** again.
→ The clock digits for the minutes flash.
- 4 Press **TUNING** **I◀◀ ▶▶I** to set the minutes.
- 5 Press **DISPLAY/CLOCK** to confirm the time.

Note:

– The backlight for clock display is off in standby.

Setting the timer

- The system can be used as an alarm clock, whereby the CD, TUNER or iPod is switched on at a set time. The clock time needs to be set first before the timer can be used.
- 1 In standby or active mode, press and hold **SLEEP/TIMER** on the remote control.
 - 2 Press **SOURCE** (**CD**, **iPod** or **TUNER** on the remote control) to select sound source.
 - 3 Press **SLEEP/TIMER** to confirm your desired mode.
→ The clock digits for the hours flash.
 - 4 Press **TUNING** **I◀◀ ▶▶I** to set the hours.
 - 5 Press **SLEEP/TIMER** again.
→ The clock digits for the minutes flash.

- 6 Press **TUNING** **I◀◀ ▶▶I** to set the minutes.
 - 7 Press **SLEEP/TIMER** to confirm the time.
→ The timer is now set and activated.
- To deactivate timer; in timer setting mode, press **■**.
→ disappears from the display.

Activating and deactivating SLEEP

The sleep timer enables the system to switch off by itself after a set period of time.

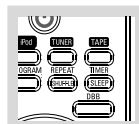

- Press **SLEEP/TIMER** on the remote control once or more.
→ Display shows **zzz** and one of the sleep time options in sequence: 60, 45, 30, 15, 0, 60... if you have selected a time.
- To deactivate, press **SLEEP/TIMER** on the remote control once or more until " " is shown, or press **STANDBY ON ECO POWER** on the system (or on the remote control).
→ **zzz** disappears from the display.

Dock for iPod

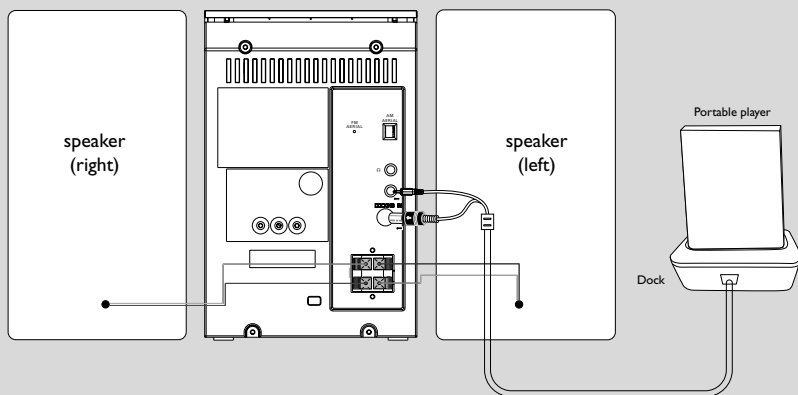

Playing iPod using the dock

By connecting the supplied dock to your Hi-Fi system, you can listen to the sound of the docked player through the powerful speakers of the Hi-Fi system.

Compatible portable player

- Most Apple iPod models with 30-pin dock connector as follows:
20GB, 40GB, 20/30GB photo, 40/60GB photo, 30GB video, 60GB video, mini and nano.

Dock

- This system comes with a dock used for iPod. Connect the cable of the dock to the system to let the system and your iPod work together.

Dock adaptor

Before plugging your player in the dock, snap the suitable adaptor into the dock to provide a snug fit for the player to be docked.

Selecting the correct dock adaptor

- For the iPod dock, 8 dock adaptors of different type, as indicated at the back of the adaptor, are included to fit the following iPod:
20GB, 40GB, 20/30GB photo, 40/60GB photo, 30GB video, 60GB video, mini and nano.

Installing the dock adaptor

- Align two latches and two holes on the dock and the adaptor; then gently push in the adaptor until it clicks.

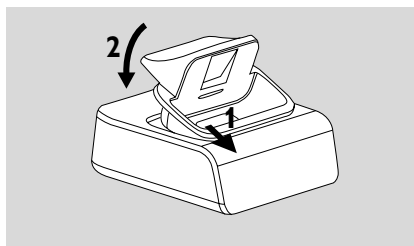

Removing the dock adaptor

- Slightly push down the dock adaptor; as indicated in the figure below, to un-latch the adaptor; then take it out.

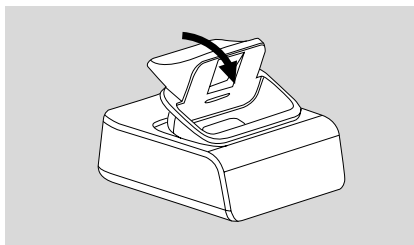

Playing iPod

- 1 Select the dock adaptor of the correct type and size, and snap it into the dock (See " **Dock adaptor** ").
- 2 Correctly place your iPod in the dock.
- 3 Connect the cables of the dock to DOCKING IN jacks on the main set correspondingly.
- 4 Press **SOURCE** repeatedly or **iPod** to select iPod source.
- The connected player will play automatically.
- Use **MENU**, **▼/▲**, and **OK** to navigate the iPod menu.

Notes:

- By using the buttons (**▶||**, **◀◀**, **▶▶** and **VOLUME**) on the MCM196D and its remote control, the following iPod playback features are available: Play/Pause, selecting next/previous track, fast forwarding/rewinding and changing volume.
- The buttons (**▶||**, **◀◀**, **▶▶** and **VOLUME**) on the MCM196D and its remote control can work only with playback of the audio contents stored on the docked player.
- Stop (**■**) function of disc playback is not available to the docked player.

Charging iPod battery using the dock

Docking your iPod and connecting the dock to MCM196D you can charge the iPod in the standby mode and power-on mode of MCM196D.

Notes:

- In Eco power standby mode, iPod cannot be charged.
- When the set is switched to the dock mode, if no player is plugged in for 15 minutes, the set will switch to the Eco power mode.

Specifications

AMPLIFIER

Output power 2 x 4W RMS
FTC output power 3 W
Signal-to-noise ratio \geq 60 dBA (IEC)
Frequency response 125 – 16000 Hz
Impedance loudspeakers 4 Ω

CD PLAYER

Frequency range 125 – 16000 Hz
Signal-to-noise ratio 65 dBA

TUNER

FM wave range 87.5 – 108 MHz
AM wave range 530 – 1700 kHz
Sensitivity at 75 Ω
– FM 26 dB sensitivity 20 μ V
– AM 26 dB sensitivity 5 mV/m
Total harmonic distortion \leq 5%

TAPE DECK

Frequency response
Normal tape (type I) 125 – 8000 Hz (8 dB)
Signal-to-noise ratio
Normal tape (type I) 40 dBA
Wow and flutter \leq 0.4% JIS

SPEAKERS

Bass reflex system
Dimensions (w x h x d) . 146 x 228 x 160 (mm)

GENERAL INFORMATION

AC Power 120 V / 60 Hz
Dimensions (w x h x d) ... 146 x 228 x 216(mm)
Weight (with/without speakers)
..... approx. 4.4 / 2.0 kg
Power consumption
Active 30 W
Standby < 4 W
Eco Power Standby < 1 W

Specifications and external appearance are subject to change without notice.

Troubleshooting

WARNING

Under no circumstances should you try to repair the system yourself, as this will invalidate the warranty. Do not open the system as there is a risk of electric shock.

If a fault occurs, first check the points listed below before taking the system for repair. If you are unable to remedy a problem by following these hints, consult your dealer or Philips for help.

Problem	Solution
"NO DISC" is displayed.	<ul style="list-style-type: none">✓ Insert a disc.✓ Check if the disc is inserted upside down.✓ Wait until the moisture condensation at the lens has cleared.✓ Replace or clean the disc, see "Maintenance".✓ Use a finalized CD-RW or a correct MP3-CD format disc.

Radio reception is poor.

- ✓ If the signal is too weak, adjust the antenna or connect an external antenna for better reception.
- ✓ Increase the distance between the Mini HiFi System and your TV or VCR.

Recording or playback cannot be made.

- ✓ Clean deck parts, see "Maintenance".
- ✓ Use only NORMAL (IEC I) tape.
- ✓ Apply a piece of adhesive tape over the missing tab space.

The tape deck door cannot open.

- ✓ Remove and reconnect the AC power plug and switch on the system again.

The system does not react when buttons are pressed.

- ✓ Remove and reconnect the AC power plug and switch on the system again.

Sound cannot be heard or is of poor quality.

- ✓ Adjust the volume.
- ✓ Disconnect the headphones.
- ✓ Check that the speakers are connected correctly.
- ✓ Check if the stripped speaker wire is clamped.
- ✓ Make sure the MP3-CD was recorded within 32-256 kbps bit rate with sampling frequencies at 48 kHz, 44.1 kHz or 32 kHz.

The left and right sound outputs are reversed.

- ✓ Check the speaker connections and location.

The remote control does not function properly.

- ✓ Select the source (CD or TUNER, for example) before pressing the function button (▶, ◀, ▶).
- ✓ Reduce the distance between the remote control and the system.
- ✓ Insert the batteries with their polarities (+/- signs) aligned as indicated.
- ✓ Replace the batteries.
- ✓ Point the remote control directly towards the IR sensor:

The time is not working.

- ✓ Set the clock correctly.
- ✓ Press and hold Timer on/off to switch on the timer.
- ✓ If recording or tape dubbing is in progress, stop recording.
- ✓ Power has been interrupted or the power cord has been disconnected. Reset the clock/timer.

Troubleshooting

The menu navigation or photo playback of the docked player cannot be carried out through the buttons on MCM196D or its remote control.

The STOP ■ and some buttons on MCM196D and its remote control have no function.

- ✓ The buttons on MCM196D and its remote control can only control playback of audio contents. To navigate the menu, use the controls on the docked player.
- ✓ The playback of the docked player cannot be stopped using the **STOP ■** button on MCM196D and its remote control.
- ✓ The buttons (▶||, ◀◀, ▶▶ and **VOLUME**) can function only.

PHILIPS LIMITED WARRANTY ONE (1) YEAR

WARRANTY COVERAGE:

PHILIPS warranty obligation is limited to the terms set forth below.

WHO IS COVERED:

Philips warrants the product to the original purchaser or the person receiving the product as a gift against defects in materials and workmanship as based on the date of original purchase ("Warranty Period") from an Authorized Dealer. The original sales receipt showing the product name and the purchase date from an authorized retailer is considered such proof.

WHAT IS COVERED:

The Philips warranty covers new products if a defect arises and a valid claim is received by Philips within the Warranty Period. At its option, Philips will either (1) repair the product at no charge, using new or refurbished replacement parts, or (2) exchange the product with a product that is new or which has been manufactured from new, or serviceable used parts and is at least functionally equivalent or most comparable to the original product in Philips current inventory, or (3) refund the original purchase price of the product.

Philips warrants replacement products or parts provided under this warranty against defects in materials and workmanship from the date of the replacement or repair for ninety (90) days or for the remaining portion of the original product's warranty, whichever provides longer coverage for you. When a product or part is exchanged, any replacement item becomes your property and the replaced item becomes Philips' property. When a refund is given, your product becomes Philips' property.

Note: Any product sold and identified as refurbished or renewed carries a ninety (90) day limited warranty.

Replacement product can only be sent if all warranty requirements are met. Failure to follow all requirements can result in delay.

WHAT IS NOT COVERED - EXCLUSIONS AND LIMITATIONS:

This Limited Warranty applies only to the new products manufactured by or for Philips that can be identified by the trademark, trade name, or logo affixed to it. This Limited Warranty does not apply to any non-Philips hardware product or any software, even if packaged or sold with the product. Non-Philips manufacturers, suppliers, or publishers may provide a separate warranty for their own products packaged with the bundled product.

Philips is not liable for any damage to or loss of any programs, data, or other information stored on any media contained within the product, or any non-Philips product or part not covered by this warranty. Recovery or reinstallation of programs, data or other information is not covered under this Limited Warranty.

This warranty does not apply (a) to damage caused by accident, abuse, misuse, misapplication, or non-Philips product, (b) to damage caused by service performed by anyone other than Philips or Philips Authorized Service Location, (c) to a product or a part that has been modified without the written permission of Philips, or (d) if any Philips serial number has been removed or defaced, or (e) product, accessories or consumables sold "AS IS" without warranty of any kind by including refurbished Philips product sold "AS IS" by some retailers.

This Limited Warranty does not cover:

- Shipping charges to return defective product to Philips.
- Labor charges for installation or setup of the product, adjustment of customer controls on the product, and installation or repair of antenna systems outside of the product.
- Product repair and/or part replacement because of improper installation, connections to improper voltage supply, abuse, neglect, misuse, accident, unauthorized repair or other cause not within the control of Philips.
- Damage or claims for products not being available for use, or for lost data or lost software.
- Damage occurring to product during shipping.
- A product that requires modification or adaptation to enable it to operate in any country other than the country for which it was designed, manufactured, approved and/or authorized, or repair of products damaged by these modifications.
- A product used for commercial or institutional purposes (including but not limited to rental purposes).
- Product lost in shipment and no signature verification receipt can be provided.
- Failure to operate per Owner's Manual.

TO OBTAIN ASSISTANCE IN THE U.S.A., PUERTO RICO, OR U.S. VIRGIN ISLANDS...

Contact Philips Customer Care Center at:
1-888-PHILIPS (1-888-744-5477)

TO OBTAIN ASSISTANCE IN CANADA...

1-800-661-6162 (French Speaking)
1-888-PHILIPS (1-888-744-5477) - (English or Spanish Speaking)

REPAIR OR REPLACEMENT AS PROVIDED UNDER THIS WARRANTY IS THE EXCLUSIVE REMEDY FOR THE CONSUMER. PHILIPS SHALL NOT BE LIABLE FOR ANY INCIDENTAL OR CONSEQUENTIAL DAMAGES FOR BREACH OF ANY EXPRESS OR IMPLIED WARRANTY ON THIS PRODUCT. EXCEPT TO THE EXTENT PROHIBITED BY APPLICABLE LAW, ANY IMPLIED WARRANTY OF MERCHANTABILITY OR FITNESS FOR A PARTICULAR PURPOSE ON THIS PRODUCT IS LIMITED IN DURATION TO THE DURATION OF THIS WARRANTY.

Some states do not allow the exclusions or limitation of incidental or consequential damages, or allow limitations on how long an implied warranty lasts, so the above limitations or exclusions may not apply to you.

This warranty gives you specific legal rights. You may have other rights which vary from state/province to state/province.

Philips, P.O. Box 671539, Marietta, GA. 30006-0026

3121 233 48801

PHILIPS CONSUMER ELECTRONICS NORTH AMERICA
P.O. BOX 671539, Marietta, GA. 30006-0026

Meet Philips at the Internet
<http://www.philips.com/usasupport>

English

Français

Español

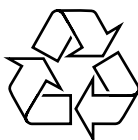

MCM196D

**CLASS 1
LASER PRODUCT**



Printed In China

PDCC-JH-0720

Free Manuals Download Website

<http://myh66.com>

<http://usermanuals.us>

<http://www.somanuals.com>

<http://www.4manuals.cc>

<http://www.manual-lib.com>

<http://www.404manual.com>

<http://www.luxmanual.com>

<http://aubethermostatmanual.com>

Golf course search by state

<http://golfingnear.com>

Email search by domain

<http://emailbydomain.com>

Auto manuals search

<http://auto.somanuals.com>

TV manuals search

<http://tv.somanuals.com>