



Help?

If this instruction manual does not give an answer or if 'Tips' do not solve your TV problem, you can call your Local Philips Customer or Service Centre. See the supplied World-wide guarantee booklet.

Please, have the Model and Product number which you can find at the back of your television set or on the packaging, ready, before calling the Philips helpline.

Model: 37PF7320I79
37PF7320I98
42PF7320I79
42PF7320I98
42PF7420I79
42PF7420I98
50PF7320I79
50PF7320I98
42PF7520ZI79

Product No:

Introduction

Thank you for purchasing this television set. This handbook has been designed to help you install and operate your TV set. We would strongly recommend that you read it thoroughly. We hope our technology meets entirely with your satisfaction.

Table of Contents

Preparation	2
To use the menus	3
Remote control	4-5
The keys on the right side of the TV set	6
Rear connections	6
Recorder (VCR-DVD+RW)	7
Devices with Component Video Output connectors ..	8
Devices with Progressive Scan output	9
Devices with HDMI connector	10
Devices with DVI connector to the HDMI connector of the TV	10
Computer with VGA connector to the PC-VGA connector of the TV	11
Side connections	12
Record with your recorder	13
How to search for and store TV channels	14
Give name	16
Editing of channels	16
Features menu	17
PIP (Picture in Picture)	17
Child lock	18
Teletext	19
Using in PC monitor mode	20
Using in HD (High Definition) mode	21
Tips	22



Recycling

The materials used in your set are either reusable or can be recycled. To minimise environmental waste, specialist companies collect used appliances and dismantle them after retrieving any materials that can be used again (ask your dealer for further details).

Care of the screen

Do not touch, push or rub or strike the screen with anything hard as this may scratch, mar or damage the screen permanently. Do not rub with dust clothes with chemical treatment. Do not touch the surface with bare hands or greasy cloth (some cosmetics are detrimental to the screen). Unplug the TV before cleaning the screen. When the surface becomes dusty, please wipe gently with absorbent cotton or other soft materials like chamois soaks. Do not use acetone, toluene and alcohol because they cause chemical damage.

Do not use liquid cleaners or aerosol cleaners. Wipe off saliva or water drops as soon as possible. Their long time contact with the screen causes deformations and colour fading.

Warning concerning stationary images on the TV screen

A characteristic of Plasma Display Panels is that displaying the same image for a long time can cause a permanent after-image to remain on the screen. This is called phosphor burn in.

Normal use of the TV should involve the showing of pictures that contain constantly moving and changing images that fill the screen.

Black Bars

When black bars appear at the left and right side of the screen, it is recommended to change to a picture format so that the picture fills the entire screen.

Preparation

- 1 Wall mounting instructions/Table stand**
According to the type of TV you've purchased a wall mount bracket and/or stand may be supplied. How to mount the supplied stand and/or wall mount bracket, see the supplied Quick Start Guide. Make sure that the wall mount is being fixed securely enough so that it meets safety standards.

The weight of the TV (excl. packaging) is about 23,2 kg (37PF7320); 37,3 kg (42PF7320/7520Z); 27kg (42PF7420); 50 kg (50PF7320).

Note: Other (not supplied) stands are optional accessories. Consult your dealer.

- 2** For ventilation, leave at least 5 cm free all around the TV.

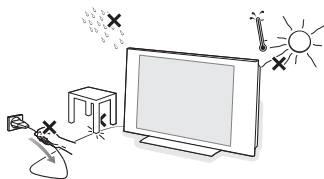

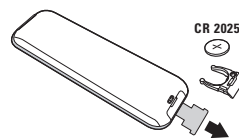

To prevent any unsafe situations, no naked flame sources, such as lighted candles, should be placed in the vicinity. Avoid heat, direct sunlight and exposure to rain or water. The equipment shall not be exposed to dripping or splashing.

- 3** Insert the aerial plug firmly into the aerial socket  at the bottom of the TV. For best picture quality use the suppressor-aerial cable supplied.
- 4** To connect peripheral equipment, see p. 6.
- 5** Insert the mains cord supplied into the mains at the bottom of the TV and in the wall socket having a mains voltage of 110 - 220V / 220 - 240V (see p.22).
To prevent damaging the power (AC) cord which could cause a fire or electric shock, do not place the TV on the cord.
- 6 Remote control:** Pull out the plastic insulation sheet from the battery, this will activate the remote control.



The battery supplied with the appliance does not contain mercury or nickel cadmium so as to protect the environment. Please do not discard your used batteries, but use the recycling methods available (consult your distributor).

- 7 Switch the TV on :** Press the power switch  at the right side of the TV.
An indicator on the front of the TV lights up. Press the **-P+** keys or the  key on the remote control.

To use the menus

- 1 Press the **MENU** key on the remote control to summon the main menu.
- 2 Use the cursor up/down to select **Picture**, **Sound**, **Features** or **Install**.
- 3 Use the cursor in the right direction to select the menu item.
- 4 Use the cursor up/down again to select a setting.
- 5 Use the cursor left/right to adjust.
- 6 To exit the menus, press the **MENU** key repeatedly.

Note: Items temporary not available or not relevant are displayed in a light grey colour and cannot be selected.

TV menu

TV Menu	Picture
Picture ▶ Sound Features Install	Brightness ▶  Colour Contrast Sharpness Hue Colour Temp.

Picture menu:

- **Brightness:** this changes picture brilliance.
- **Colour:** this changes the intensity of the colour.
- **Contrast:** this changes the difference between the light and dark tones.
- **Sharpness:** this changes the picture definition.
- **Hue:** this adjusts the picture to obtain natural skintones.
- **Colour Temp.:** this changes the colour rendering: **Cool** (bluer); **Normal** (balanced) or **Warm** (redder).

TV Menu	Sound
Picture Sound ▶ Features Install	Equalizer ▶ 120 Hz Balance 500 Hz (AVL) 1500 Hz Dolby Virtual 5 kHz 10 kHz

Sound menu:

- **Equalizer:** to adjust the sound tone (from bass 120 Hz to treble 10 kHz).
- **Balance:** this balances the sound on the left and right speakers.
- **(AVL (Automatic Volume Leveller):** this is used to limit increases in sound, especially on programme change or advertising slots.)
- **Dolby Virtual:** simulates the surround sound experience from two speakers using Dolby Pro Logic* providing the listener with the sensation of being surrounded by additional speakers.

** Manufactured under license from Dolby Laboratories. Dolby 'Pro Logic' and the double-D symbol are trademarks of Dolby Laboratories.*

TV Menu	Features
Picture Sound Features ▶ Install	Timer ▶ (Sleep) Child Lock Time Contrast+ Start Time NR Stop Time PIP Channel

Features menu:



- **Timer, Child lock and PIP:** see p. 17-18.
- **Contrast+:** automatic adjustment of the picture contrast which permanently sets the darkest part of the picture to black.
- **NR:** attenuates picture noise (snow) in difficult reception conditions.

Install menu: see p. 14

Use of the remote control

Pixel Plus demo on/off

(Only available on certain versions.)

- Press the  key.
The screen is divided into 2 parts:
 - in the left part Pixel Plus is switched off;
 - In the right part Pixel Plus is switched on.
- Press the  key again to switch the Pixel Plus demo off.



Video recorder or DVD keys

Surround mode

Virtual Dolby* Surround

Optimal with Dolby surround signals.

Enables you to experience the effect of Dolby surround Pro Logic, reproducing a rear sound effect. See Sound menu, Dolby Virtual, p. 3.

Note: You can make the same selection in the Sound menu, p. 3.

AV To display the **Source** list to select TV or peripheral equipment connected to **CVI-1, AV, PC-VGA/CVI-2, HDMI/PC-D** or **Side**. See also p. 6.

Active control

Optimizes the picture quality according to the quality of the reception.

Press this key to switch between **On, On with sensor** and **Off**.

MENU Main menu on/off

Cursor keys

Press the keys  to navigate through the menus.

VOL To adjust the volume.

0/9 Digit keys

To select a TV channel.
For a two digit programme number, enter the second digit before the dash disappears.

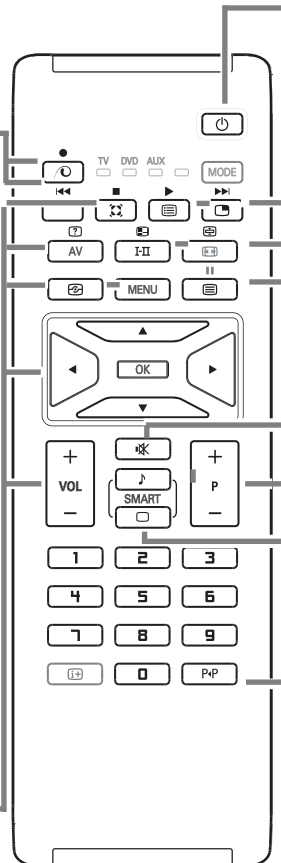



Standby

Press to switch the TV on or off from or to standby mode.
When switched off, a red indicator on the TV lights up.

PIP (Picture in Picture) on/off (p. 17)

List of programmes

To display/clear the list of programmes. Use the keys  to select a programme and the key  to display it.

I-II Sound mode

To switch from **Stereo** or **Nicam Stereo** to **Mono** or to choose between **Dual I** or **Dual II** in case of bilingual transmission.

When the sound mode is **Mono**, the indication is displayed in red.

Teletext

Teletext keys. See p. 19.

 Interrupt the sound or restore it.

Smart picture and sound

To select predefined picture and sound settings.

This Philips TV has been set at the factory to look best in bright store environments which use fluorescent lighting. As your home will likely not be as well lit as a store, we recommend you that you cycle through the various smart picture modes to find the one that best suits your own viewing conditions. Most consumers will find that **Natural** is the correct choice.

P Programme selection

To move up or down a programme. The number, (the name) and the sound modes are displayed for a few seconds.

For some TV programmes the title of the programme appears at the bottom of the screen.

P·P Previous TV channel

Press to display the previously selected TV channel.

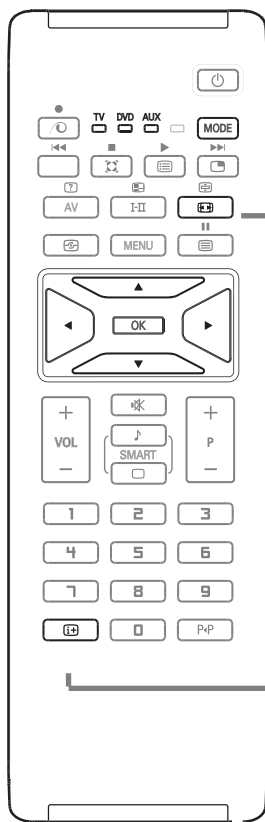

MODE* Press this key to switch between **TV**, **DVD** and **AUX** functions.

16:9 formats

The pictures you receive may be transmitted in 16:9 format (wide screen) or 4:3 format (conventional screen).

4:3 picture sometimes have a black band at the top and the bottom of the screen (letterbox format).

This function allows you to optimise the picture display on screen.

Using the different formats

Press the  key or use the keys ◀ ▶ to select the different modes: 4:3, Movie Expand 14:9, Movie Expand 16:9, Subtitle Zoom, Superzoom and Widescreen.

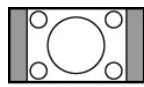

4:3

The picture is reproduced in 4:3 format and a black band is displayed on either side of the picture.

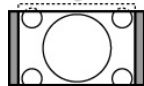

Movie Expand 14:9

The picture is enlarged to 14:9 format, a thin black band remains on both sides of the picture.

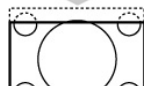

Movie Expand 16:9

The picture is enlarged to 16:9 format. This mode is recommended when displaying pictures which have black bands at the top and bottom (letterbox format).



Subtitle Zoom

This mode is used to display 4:3 pictures using the full surface of the screen leaving the subtitles visible.



Superzoom

This mode is used to display 4:3 pictures using the full surface of the screen by enlarging the sides of the picture.



Widescreen

This mode restores the correct proportions of pictures transmitted in 16:9 using the full screen display.

Note: If you display a 4:3 picture in this mode, it will be enlarged horizontally.

Screen information

To display/remove the programme number, the name (if it exists), the time, the sound mode and the time remaining on the timer.

Hold down for 5 seconds to permanently display the programme number on the screen.

*** Mode selector**

The remote control lets you control the main functions of the VCR or DVD.

Press the **MODE** key to select the required mode: **DVD** or **AUX** (VCR).

The remote control indicator lights up to display the selected mode. It switches off automatically after 20 seconds if left idle. The remote control automatically returns to TV mode.

The following keys are operational, depending on the equipment:

⏻, I-II, ●◀◻▶▶▶, **OK**, **MENU**, cursor keys, **-P+**, digit keys, , **P+P**.

Keys on the right side of the TV

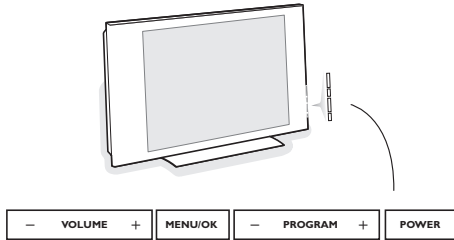

Should your remote be lost or broken you can still change some of the basic settings with the keys on the right side of your TV.

Press:

- **POWER** : to switch the TV on or off.
- **+ VOLUME -** : to adjust sound level.
- **+ PROGRAM -** : to select programmes.
- **MENU** : to access or close menus.

The **+ PROGRAM** - keys can be used to select an adjustment and the **+ VOLUME** - keys to make that adjustment.

Rear connections

There is a wide range of audio and video devices that can be connected to your TV. The following connection diagrams show you how to connect them to the TV.

CVI-1 can handle YPbPr and Audio L/R; **AV** CVBS, Y/C and Audio L/R; **PC-VGA/ CVI-2** VGA or YPbPr and Audio L/R; **HDMI/PC-D** HDMI or DVI.

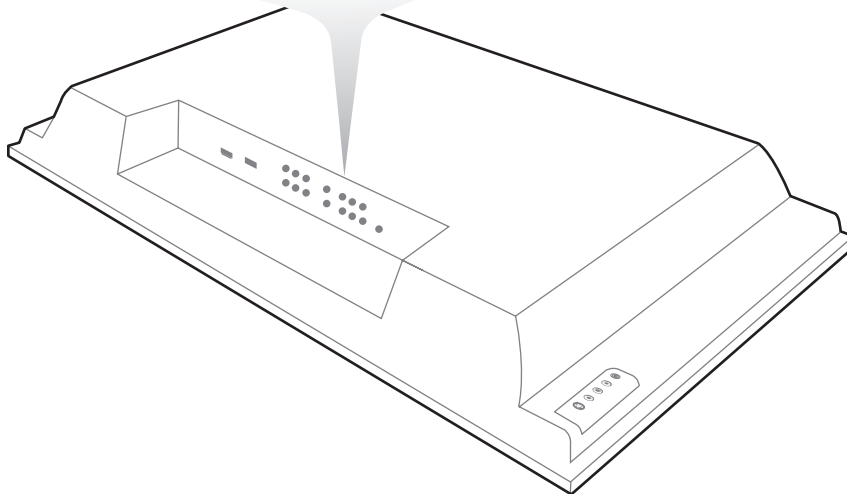
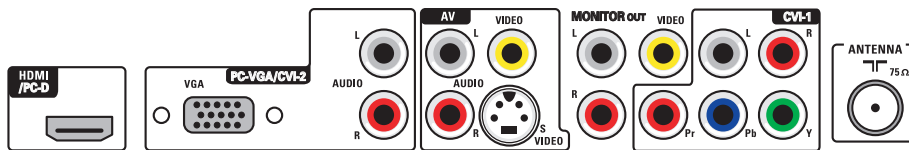

Recorder (VCR-DVD+RW)

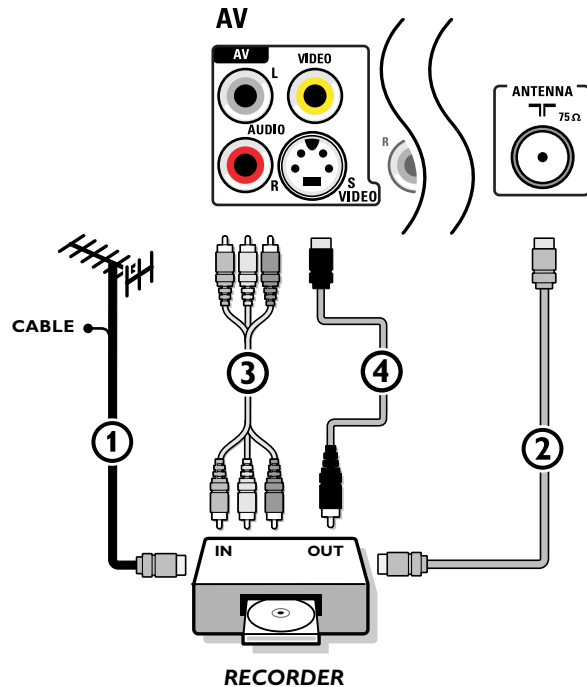

Note: Do not place your recorder too close to the screen as some recorders may be susceptible for signals from the display. Keep a minimum distance of 0,5m from the screen.

- ❶ Connect the RF Antenna cable ❶ to the **RF IN** socket of your recorder.
- ❷ Connect another RF cable ❷ from the output **OUT** of your recorder to the TV's input **ANTENNA 75 Ω** jack.
- ❸ Better playback quality can be obtained if you also connect the Video, Audio Left and Right (only for stereo equipment) AV cables ❸ to the **VIDEO, AUDIO L** and **R** input jacks of **AV**.
- ❹ Press the **AV** key on the remote control repeatedly until **AV** is selected.

If your recorder has an S-VHS video jack:

For improved picture quality, connect an S-video cable ❹ with the **S-VIDEO** input. S-Video does not provide audio, so audio cables must still be connected to provide sound.

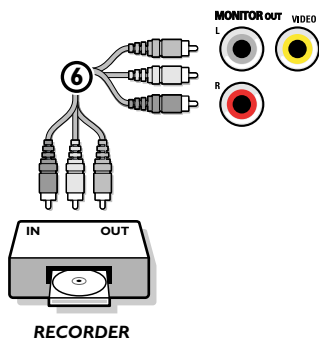

The **MONITOR OUT** connector can be used for daisy chaining or to record programs from your TV ❹. Only when a recorder is connected to **MONITOR OUT** it is possible to record an analog program from your TV. See Record with your recorder, p. 13.

Devices with Component Video Output Connectors (YPbPr)

CVI-1 can handle 480i, 480p, 576i, 576p, 720p and 1080i signals.

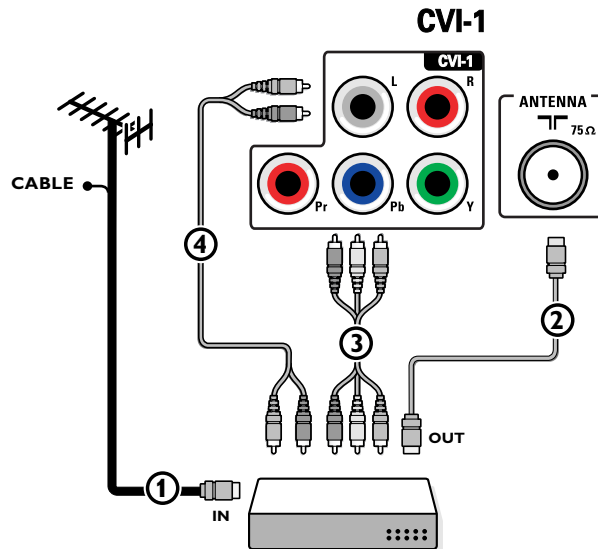

- ❶ Connect the RF Antenna cable ❶ to the **RF IN** socket of your recorder.
- ❷ Connect another RF cable ❷ from the output **OUT** of your recorder to the TV's input **ANTENNA** 75 Ω jack.
- ❸ Connect the three separate component video cables ❸ to the device having component video outputs (YPbPr), such as DVD-players, laser-disc players, videogame players, satellite receivers, or other equipment and to the **Y**, **Pb** and **Pr** jacks of **CVI-1** on the TV.
- ❹ Connect the audio cable ❹ to the device's **AUDIO L** and **R** jacks and to the **L** and **R** audio jacks of **CVI-1**.

Note: the labels for the component video sockets may differ depending on the DVD player or the device connected. Although the abbreviations may vary the letters B and R stand for blue and red component signals, respectively, and Y indicates the luminance signal. Refer to the DVD player's or device's instructions for use for definitions and connection details.

- ❺ Press the **AV** key on the remote control repeatedly until **CVI-1** is selected.

Devices with Progressive scan output

(e.g. a digital Set Top box, a video game console or Progressive scan DVD player (480p, 576p, 720p or 1080i))

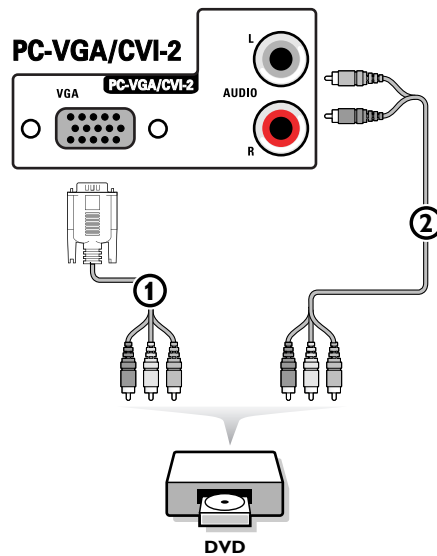

- ❶ Connect the device with **2Fh YPbPr** output to the **VGA** connector ❶ (with the supplied adapter cable VGA to cinch) and to the **L** and **R AUDIO** jacks ❷ of **PC-VGA/CVI-2**. See also the manual of your High Definition device.
- ❷ Press the **AV** key on the remote control repeatedly until **PC-VGA/CVI-2** is selected.

Note: This television is designed to accept high definition signal standards 480p, 576p, 720p and 1080i as specified by the Electronic Industries Association standard EIA770.3. Digital devices from different manufacturers have the possibility of differing output standards which may cause difficulties for the television to properly display.

Warning: In case you notice scrolling images, wrong colors or no colour, no picture, or even combinations of these on your screen, check if the connections are done in the correct way or move your digital device further away from your TV.

Devices with HDMI (High Definition Multimedia Interface) connector

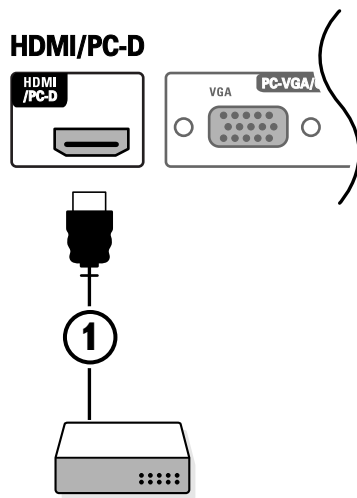

HDMI is the leading new standard for Digital High Definition video and audio interconnection. Eg. with a Digital Set top box, with HDMI-equipped devices like a DVD-R, AV receiver...

The **HDMI** connector allows the following TV and monitor display modes via the AV key on the remote control, for High Definition (HD) and computer (PC) equipment:

ENHANCED DEFINITION TV (EDTV)	720 x 576p	
HIGH DEFINITION (HDTV)	1280 x 720p	
	1920 x 1080i	
VGA (PC)	640 x 480	60 Hz
SVGA	800 x 600	60 Hz
XGA	1024 x 768	60 Hz
	1280 x 1024	60 Hz

- 1 Connect the digital HDMI output of your HD device (e.g. DVD player, Set Top Box..) to the **HDMI/PC-D** connector of your TV ①.

Notes:

- Proper working is only guaranteed with HDMI compliant consumer products.
- Digital devices from different manufacturers have the possibility of differing output standards which may cause for the television to properly display;
- If the set is cold, there may be a small "flicker" when the set is turned on. This is normal, there is nothing wrong with the set.

- 2 Press the **AV** key on the remote control repeatedly until **HDMI/PC-D** is selected.
- 3 Press the **I-II** key on the remote control repeatedly to select **HDMI** Audio.

Computer or device with DVI connector to the HDMI connector of the TV

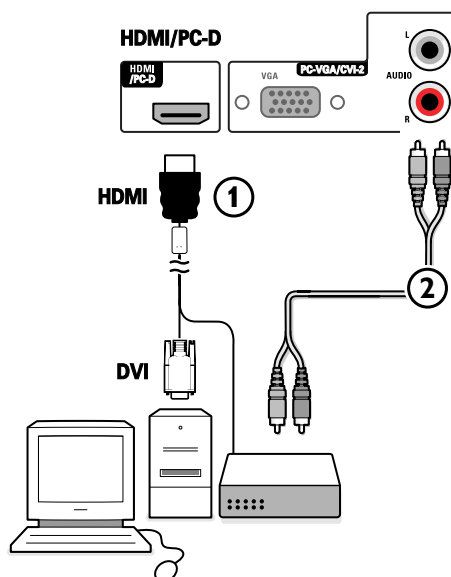

- 1 In case a HD-DVI device (connected with a DVI to HDMI cable) ① is connected, also connect the audio cable ② (if audio is present) to the **AUDIO** outputs of your HD device and the **R** (right) and **L** (left) **CVI-2** inputs of the panel of the TV.
- 2 Press the **AV** key on the remote control repeatedly until **HDMI/PC-D** is selected.
- 3 Press the **I-II** key on the remote control repeatedly to select **PC-HD** Audio.

Computer with VGA connector to the PC-VGA connector of the TV

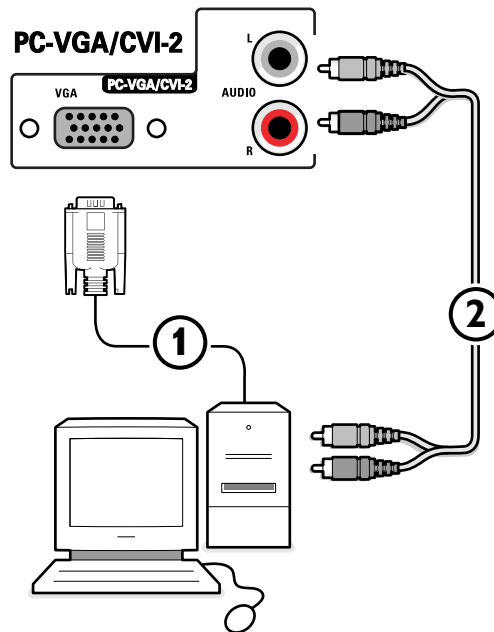

- ❶ Connect one end of a VGA cable ❶ to the video card of the computer and the other end to the **VGA** connector at the bottom of the TV.
Fix the connectors firmly with the screws on the plug.
- ❷ In case of a Multimedia computer, connect the audio cable ❷ to the audio outputs of your Multimedia computer and to the **AUDIO R** (right) and **L** (left) inputs.
- ❸ Press the **AV** key on the remote control repeatedly until **PC-VGA/CVI-2** is selected.

The **VGA** connector allows the following TV and monitor display modes:

VGA	640 x 480	60 Hz
SVGA	800 x 600	60 Hz
	1024 x 768	60 Hz
XGA	1024 x 768	60 Hz
	1280 x 1024	60 Hz

Note:

If possible, use the XGA1024x768@60Hz video mode to obtain the best image quality.

Side connections (camcorder, video games, headphone,...)

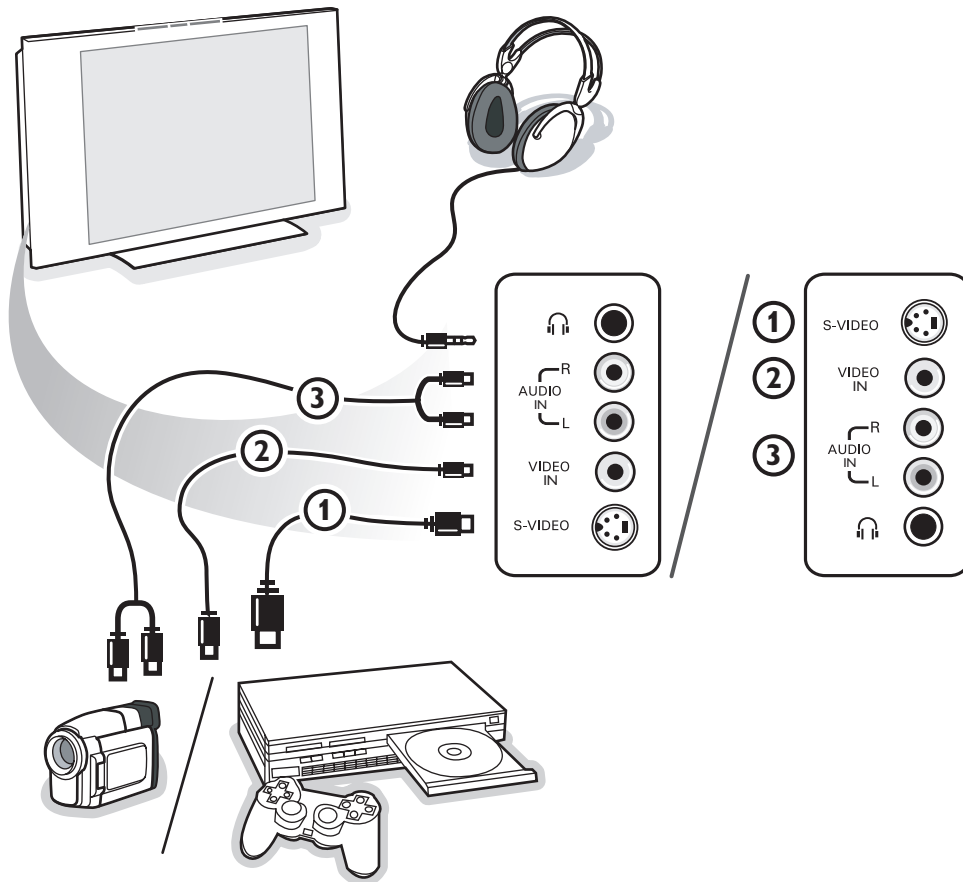

Camera, Game or Camcorder

- ① Connect your camera, game or camcorder as shown.
- ② Connect to **VIDEO** ② and **AUDIO L** ③ for mono equipment. For stereo equipment also connect **AUDIO R** ③.
S-VHS quality with an S-VHS camcorder is obtained by connecting the S-VHS cables with the **S-VIDEO** input ① and **AUDIO** inputs ③.
Do not connect cable ① and ② at the same time; This may cause picture distorton.
- ③ Press the **AV** key on the remote control.
- ④ Press the cursor up/down to select **REAR/SVHS**.
- ⑤ Press the cursor right.

Headphone

Insert the plug into the headphone socket  as shown.

The headphone impedance must be between 8 and 4000 Ohm. The headphone socket has a 3.5 mm jack.

Record with your recorder

Record a TV program

You can record a TV program using your recorder's tuner without affecting your TV.

- 1 Select the channel number on your recorder.
- 2 Set your recorder to record.
See the handbook for your recorder.

Switching channel numbers on your TV does not disturb recording!

Record a programme from MONITOR OUT

You can record a program on your recorder from the TV tuner, and from a device connected to AV or the side connectors.

Note: you cannot record from a CVI or HDMI connected device.

- 1 Select the programme you want to record and the correct input on your recorder.
- 2 Set your recorder to record.

Do not switch to another TV channel, AV programme or programme from a device connected to the side while recording. Switching to a programme from a device connected to CVI or HDMI does not disturb recording.

How to search for and store TV channels

TV Menu	
Picture	Language
Sound	Auto Store
Features	Manual Store
Install ▶	Sort
	Name
	Channel Edit

To install your TV proceed as follows:

- ❶ Press the **MENU** key on the remote control.
- ❷ Use the cursor up/down to select **Install**.
- ❸ Press the cursor right to enter the Install menu.
- ❹ Use the cursor left/right to select your language.

Auto store

Auto Store	
Channel ▶
TV ▶	freq
	

- ❶ Select **Auto Store** in the Install menu.
The autostore option label **Start ?** appears.
- ❷ Press the cursor right.
- ❸ The progress of autoprogramming is displayed.
You can use the Sort menu to renumber the stored TV channels.

Note: Channel numbers will always be written in Latin characters, even when a language has been selected which uses other characters.

Sorting TV channels

Install	
Language
Auto Store	10 ◀
Manual Store	11
Sort ▶	12 ▶
Name	13
Channel Edit	

- ❶ Select **Sort** in the Install menu and press the cursor right
- ❷ Select the TV channel you want to move using the cursor up/down and press cursor right.
- ❸ Select the new number and validate with the cursor left.
- ❹ Repeat steps ❷ and ❸ for each TV channel you wish to renumber.
- ❺ To exit the menus, press the **MENU** key repeatedly.

Manual store

Install	
Language	Colour System
Auto Store	Sound System
Manual Store ▶	Search
Sort	Channel
Name	Fine tune
Channel edit	

Searching for and storing TV channels is done channel by channel. You must go through every step of the Manual Installation menu.

- ❶ Select **Manual Store** in the Install menu and press the cursor right to enter.
- ❷ Select **Colour system** and press the cursor right.

If **Auto** is selected, the respective colour system will be automatically selected according to the transmission system.
If the reception is poor, select another colour system with the cursor left/right.

- ❸ Press the cursor down.
- ❹ Select **Sound system** and press the cursor right. If **Auto** is selected, the respective sound system will be automatically selected according to the transmission system.
Note: if the reception is poor, select another sound system with the cursor left/right.

- ❺ Press the cursor down.
- ❻ **Search for a TV channel:**
Press the cursor down to select **Search** and press the cursor right to start searching.

Direct selection of a TV channel:

If you know the frequency, enter it directly with the digit keys 0 to 9. Ask for a list from your cable company or dealer, alternatively consult the Table of frequencies on the inside backcover of this handbook.

- ❼ Press the cursor down and enter the programme number with the digit keys.
- ❽ **Fine tune:**
In case of poor reception, you can improve the reception by adjusting the frequency with the cursor left/right.
- ❾ To store your TV channel, select **Store** and press the cursor right. Repeat steps ❷ to ❽ to store another TV channel.
- ❿ To exit from the menu press the **MENU** key on the remote control repeatedly.

Give name

Install	
Language	10
Auto Store	11
Manual Store
Sort	
Name ▶	
Channel Edit	

It is possible to change the name stored in the memory or to assign a name to a TV channel or external for which a name has not yet been entered. A name with up to 5 letters or numbers can be given to the programme numbers 0 to 99.

Note: It is not possible to rename the VGA source.

- ❶ Select **Name** in the Install menu and press the cursor right.
- ❷ Select the programme number.
- ❸ Press the cursor right.
- ❹ Select the following character with the cursor up/down.
- ❺ Select the following position with the cursor right.
- ❻ Select the following character.
- ❼ Press the cursor left repeatedly when finished.
- ❽ Select another programme number and repeat steps ❷ to ❹.
- ❾ Press the **MENU** key to return to the TV menu. Press again to exit the TV menu.

Note: space, numbers and other characters are located between Z and A.

Editing of channels

Install	
Language	Channel
Auto Store	Skipped
Manual Store	
Sort	
Name	
Channel Edit ▶	

This feature allows you to edit or skip channels from the channel list which have bad or weak signals or channels which you do not watch often.

*Note: Once a channel is skipped, you cannot select it with the **-P+** key; you can only access the channel with the digit keys.*

- ❶ Select **Channel edit** in the Install menu;
- ❷ Press the cursor right to enter the channel list.
- ❸ Select the channel you want to skip with the cursor left/right.
- ❹ Press the cursor down to select **Skipped On** or **Off**.
- ❺ Press the cursor up/down to select another channel and repeat step ❹.
- ❻ Press the **MENU** key to return to the Install menu.

Features menu

Timer

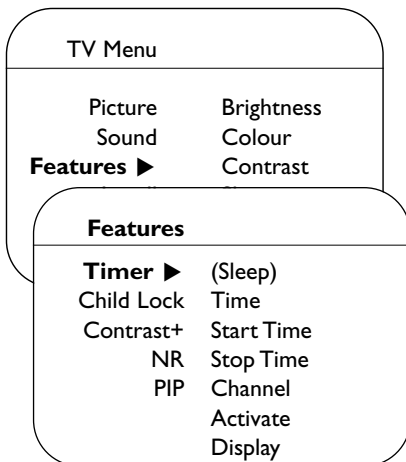

This menu lets you use the TV set as an alarm.

- ❶ Press the **MENU** key.
- ❷ With the cursor, select **Features**, then **Timer**.
- ❸ **Sleep** (only available on certain versions): to select an automatic standby period.
- ❹ **Time**: enter the current time.
- ❺ **Start Time**: enter the start time.
- ❻ **Stop Time**: enter the standby time.
- ❼ **Channel**: enter the number of the channel for the wake-up alarm.
- ❽ **Activate**: the settings include:
 - **Once** for a single alarm;
 - **Daily** for each day,
 - **Off** to cancel.
- ❾ **Display**: press the cursor right to select **On** or **Off**, according to if you want to display the current time on the TV screen or not.
- ❿ Press the  key on the remote control to put the TV set in standby. It will automatically come on at the time programmed. If you leave the TV set on, it will just change programmes at the time entered (and will go to standby mode at the Stop Time).

Note: By combining the Child lock and Timer functions, you can restrict the period during which the TV set is used, for example by your children.



PIP (Picture in Picture)

PIP Combinations	
MAIN	PIP
TV/AV/VGA/SIDE	HD DVI / HDMI
TV/AV/VGA/SIDE	PC-D
HD DVI / HDMI	TV/AV/VGA/SIDE
PC-D	TV/AV/VGA/SIDE

The Picture In Picture feature allows you to call up a subscreen within your main screen enabling you to watch a TV channel, a picture from a device connected to the **VGA**, **AV** or **SIDE** connectors and a picture from a device connected to **HDMI/PC-D** (e.g. Digital High Definition device), at the same time.

- ❶ Press the **MENU** key.
- ❷ With the cursor, select **Features**, then **PIP**.
- ❸ Press the cursor right to select the available PIP sizes: **Off**, **Small**, **Medium**, **Large** or **Side-by-side**.
When having selected a size, and a device is connected to **HDMI/PC-D** and switched on, the PIP window automatically appears. Press the **P-** or **P+** key or the digit keys to select the **TV/AV/VGA** or **SIDE** pictures or to display the **HDMI/PC-D** device window in the main screen.
- ❹ Select **Horizontal** or **Vertical** to move the PIP window to another corner of the main screen.

Note : you can also access the PIP window directly via the  key on the remote control.

- Press the  key to display the PIP window;
- Press the  key repeatedly to toggle through the various PIP window sizes and select your desired size;
- Use the cursor left/right to move your PIP window horizontally or vertically;
- Use the P-/+ key to change the programme on the PIP screen.

Child lock

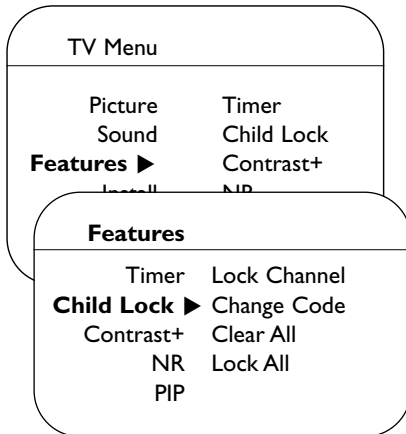

Important: you have forgotten your Access code

Remember that 0,7,1,1 is the default Child lock code. If your access code has been changed by someone other than you (a child, for example) or you have forgotten the code, you can always get in by inputting the default code.

The Child lock feature receives and processes data sent by broadcasters or other programme providers that contain programme content advisories. When programmed by the viewer, the TV can respond to the content advisories and block program content that may be found objectionable. Child lock allows parents to block out or "censor" any channels they think children should not watch. A channel blocked cannot be viewed until a correct access code is used to unlock the channel for viewing.

- ❶ Press the **MENU** key.
- ❷ With the cursor, select **Features**, then **Child lock**.
- ❸ Press the cursor right to enter the Child lock menu.
- ❹ You are asked to enter your Access Code.
 - Press 0, 7, 1, 1 on the remote control. **Incorrect** will appear on the screen.
 - Press 0, 7, 1, 1 on the remote control again. **New Code** will appear on the screen.
 - Enter a new 4-digit code using the number keys. **Confirm Code** will appear on the screen.
 - Enter your new 4-digit code again. **Confirmed** will flash on the screen briefly and the highlight bar goes back to Block Channel.

Child lock features

Lock Channel

Select the TV channel you want to block. Press the cursor right to lock the channel. Repeat for any channels you want to lock from viewing.

Change Code

To change your lock Access Code. Enter your current access code or the overriding code 0,7,1,1 and enter a new personal access code. The previous code is erased and the new code is stored.

Clear All

To unlock all locked programmes.

Lock All





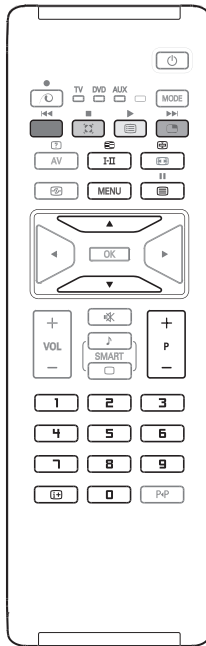

To lock all channels and programming at once. In the **OFF** mode, you go back to the individual locked channels.

Teletext

Only English teletext supported

Teletext is an information system broadcast by certain channels which can be consulted like a newspaper. It also offers access to subtitles for viewers with hearing problems or who are not familiar with the transmission language (cable networks, satellite channels, etc.).



Press:	You will obtain:
 Teletext on/off	This is used to call teletext, and then exit. The summary appears with a list of items that can be accessed. Each item has a corresponding 3 digit page number. <i>If the channel selected does not broadcast teletext, the indication 100 will be displayed and the screen will remain blank (in this case, exit teletext and select another channel).</i>
0/9 -P+	Selecting a page Enter the number of the page required using the 0 to 9 or -P+ keys. Example: page 120, enter 1 2 0. The number is displayed top left, the counter turns and then the page is displayed. Repeat this operation to view another page. <i>If the counter continues to search, this means that the page is not transmitted. Select another number.</i>
0000	Direct access to the items Coloured areas are displayed at the bottom of the screen. The 4 coloured keys are used to access the items or corresponding pages. <i>The coloured areas flash when the item or the page is not yet available.</i>
 Contents	This returns you to the contents page (usually page 100).
cursor ▲ ▼	Enlarge a page This allows you to display the top or bottom part of the page and then return to normal size.
 Stop subpage acquisition	Certain pages contain subpages which are automatically displayed successively. This key is used to stop or resume subpage acquisition. The indication  appears top left.
 Double page teletext I-II	To activate or deactivate the double page teletext display mode. The active page is displayed on the left and the following page is displayed on the right. Press  if you want to hold a page (i.e. the contents page). The active page is then displayed on the right. To return to normal mode, press I-II .

Using in PC monitor mode

Your TV can be used as a computer monitor.

You must first of all connect the computer, adjust the resolution and refresh rate (see p. 10).

Notes:

- When using the TV as a PC monitor, slight diagonal interference lines may be observed when it is operated under electromagnetic interference environment but will not affect the performance of this product.
- For better performance, a good quality **HDMI/DVI/VGA** cable with good noise isolation filter is recommended.

Choosing PC-VGA mode

- 1 Press the **AV** key on the remote control to display the **Source list**.
- 2 Use the keys **▲▼** to select **PC-VGA** and then press **▶** to switch the TV to PC-VGA mode.
- 3 To return to TV mode, repeat steps 1 and 2, but select **TV** instead.

Choosing PC-D mode

- 1 Press the **AV** key on the remote control to display the **Source list**.
- 2 Use the keys **▲▼** to select **PC-D** and then press **▶** to switch the TV to PC-D mode.
- 3 To return to TV mode, repeat steps 1 and 2, but select **TV** instead.

Using the PC menus

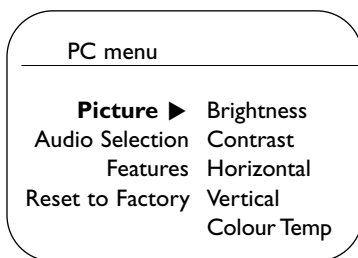

Press the **MENU** key to access the specific settings of the PC monitor mode. Use the cursor keys to adjust them (the settings are automatically saved).

Picture

- **Brightness/Contrast**: to adjust the brightness and contrast.
- **Horizontal/Vertical***: to adjust the horizontal and vertical placing of the image.
- **Colour Temp**: to adjust the colours (cool, normal or warm).

Audio selection

To choose the sound reproduced on the TV (**PC/HD** or **TV**).

Note:

- You must choose TV mode before going to PC/HD mode.
- To listen to the sound from a HD device in PC mode, take care you also connected the audio cables to the HD device.

Features

- **Phase/Clock***: eliminates the horizontal (**Phase**) and vertical (**Clock**) interfering lines.
- **Format**: to choose between large screen (**Fullscreen**) or the original (**Native**) format of the PC screens.
- **PIP**: change the Size and Position of the PIP window on the screen when the  key is used.
- **Auto adjust***: position is set automatically.

Reset to Factory

To return to the factory settings.

* These adjustments are not available in PC-D mode.

Using in HD (High Definition) mode

The HD (High Definition) mode allows you to enjoy clearer and sharper pictures through the **CVI-1**, **CVI-2** or **HDMI** input if you are using a HD receiver/equipment that can transmit high definition programming.

You must first of all connect your HD equipment (see p. 7).

Choosing HD mode

- 1 Press the **AV** key on the remote control to display the **Source list**.
- 2 Depending on your connections, use the keys **▲▼** to select **CVI-1 (SD/HD)**, **CVI-2 (SD/HD)** or **HDMI** and then press **▶** to switch the TV to the selected HD mode.
- 3 To return to TV mode, repeat steps **1** and **2**, but select **TV** instead.

Using the HD menus

Press the **MENU** key to access the specific settings of the HD menu. Use the cursor keys to adjust them (the settings are automatically saved).

Picture/Sound menu

The HD picture/sound settings are the same as the TV picture/sound settings and function exactly the same way as in the TV menu.

Features

- **PIP**: to adjust the size and position of the PIP screen.
- **Horizontal shift** : to adjust the horizontal placing of the image.
- **Vertical shift** : to adjust the vertical placing of the image.



Kensington Security Slot (if present)

Your TV is equipped with a Kensington Security Slot, to prevent it from getting stolen. An anti-theft Kensington lock has to be purchased separately.

The Kensington lock is a plastic-coated steel cable with a lock. One end has to be fixed to the opening of the TV and locked with a special key. The other end is attached to a fixed point.

® Kensington and MicroSaver are registered US trademarks of ACCO World Corporation with issued registrations and pending applications in other countries throughout the world. All other registered and unregistered trademarks are the property of their respective owners.

Tips

Poor Picture	<ul style="list-style-type: none"> • Have you selected the correct TV system in the manual installation menu? • Is your TV or house aerial located too close to loudspeakers, non-earthed audio equipment or neon lights, etc.? • Mountains or high buildings can cause double pictures or ghost images. Sometimes you can improve the picture quality by changing the direction of the aerial. • Is the picture or teletext unrecognisable? Check if you have entered the correct frequency. See Store TV channels, Manual store, p. 15. • Check the HDMI connection.
No Picture	<ul style="list-style-type: none"> • Are the supplied cables connected properly ? (The aerial cable to the TV, the other aerial to your recorder, the VGA cables to the display, the power cables.) • Has the child lock been switched off ? • Is your PC switched on ? • Do you see a black screen and the indicator in front of the TV lights up green, this means that the display mode is not supported. Switch your VGA- or HDMI-source to a correct mode. • In case of weak or bad signal, consult your dealer.
No picture and power switched on	<ul style="list-style-type: none"> • Your TV has a protective mode in case there is too much heat build-up. Check the clearance around the vents of the device to be certain there are no blocking walls or cabinets which would limit the air flow.
Digital distortion	The low quality of some digital picture material may be the cause of digital image distortion. In this case select the Soft setting using the Smart picture key <input type="checkbox"/> on the remote control.
No sound	<ul style="list-style-type: none"> • No sound on any channel? Check the volume isn't at minimum. • Is the sound interrupted with the mute key ? • When no TV signal is detected, the TV automatically switches off the sound. This is proper operation and does not indicate a malfunction.
No solution found for your picture or sound problem ?	Switch your TV off and then on again once. Never attempt to repair a defective TV yourself. Check with your dealer or call a TV technician.
Menu	Have you selected the wrong menu? Press the MENU key again to exit from the menu.
Remote control	<ul style="list-style-type: none"> • Check if the remote control is in the correct mode. • If your TV no longer responds to the remote control, the batteries may be dead. • You can still use the MENU key and the -/+ keys on the right side of your TV.
Standby	Your TV consumes energy in the standby mode. Energy consumption contributes to air and water pollution. Power consumption: 2 W.
Control of accessory devices	<ul style="list-style-type: none"> • The infrared signals of the screen may influence the reception sensibility of other peripherals. Solution: replace the batteries of the remote control of other devices. E.g. keep away a wireless headphone from within a radius of 1 m.
Miscellaneous	<ul style="list-style-type: none"> . Ambient temperature: + 5~ + 40°C . Mains: 50/60 Hz . Auto Voltage ranging from: 110 - 240V : 42PF7320; 42PF7520Z; 50PF7320; 220 - 240V : 37PF7320; 42PF7420; . Power consumption: 37PF7320: around 167W; 42PF7320: around 230W; 42PF7420: around 246W; 42PF7520Z: around 305W; 50PF7320: around 420W; . Standby consumption: < 2 W . Weight (excl. packaging): 37PF7320: 23,2 kg; 42PF7320/7520Z: 37,3 kg; 42PF7420: 27 kg; 50PF7320: 50 kg . Dimensions (wxhxd): 37": 1105x610x97; 42": 1240x680x104; 50": 1415x780x104

Free Manuals Download Website

<http://myh66.com>

<http://usermanuals.us>

<http://www.somanuals.com>

<http://www.4manuals.cc>

<http://www.manual-lib.com>

<http://www.404manual.com>

<http://www.luxmanual.com>

<http://aubethermostatmanual.com>

Golf course search by state

<http://golfingnear.com>

Email search by domain

<http://emailbydomain.com>

Auto manuals search

<http://auto.somanuals.com>

TV manuals search

<http://tv.somanuals.com>