

Chapter 7

MICROWAVE

7. MICROWAVE SYSTEMS

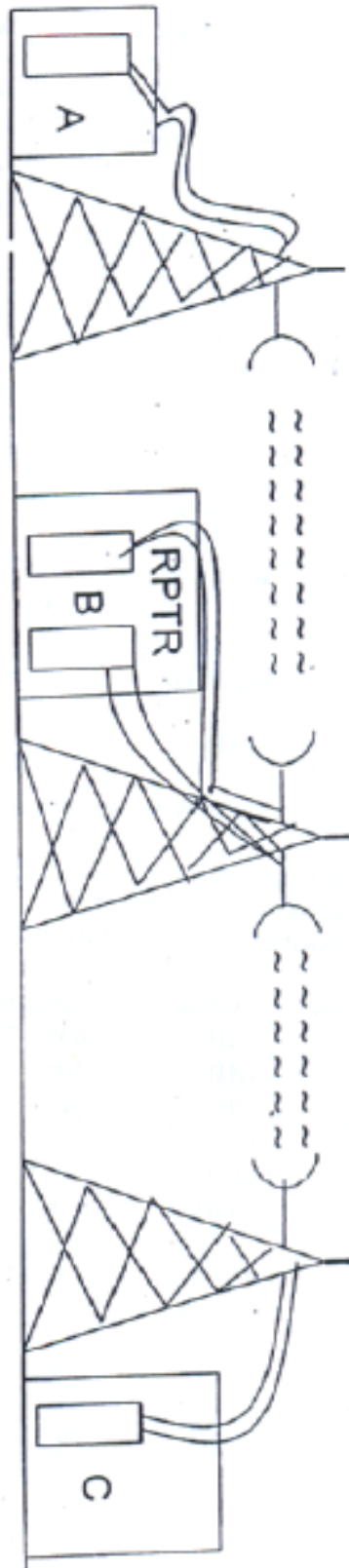

7-1 General

As on today most of the Microwave systems are not in use due to maximum availability of reliable with larger bandwidth. Still for the sake of knowledge, briefing Microwave systems and its contents. AT procedure is described here as sample case.

There are several types of M/W systems which are as follows:-

7-1.1 System and no of channels:-

2 GHz.	Short haul	N/B	5+1	Channels 2/8 Mbps only.
4 GHz	Long haul	W/B	4+2	Channels
6 GHz	Long haul	W/B	6+2	Channels
7 GHz	Long haul	N/B	10+4	Channels
11 GHz	Short haul	W/B	6+2	Channels
13 GHz	Short haul	N/B	6+2	Channels
15 GHz	Short haul	N/B	2 Mb/ 4 Trbs	

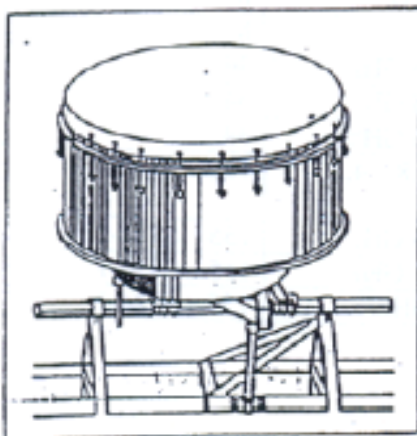

Fig 7-1

7-1.2 Designation and frequency ranges

Sl no	Frequency	Wavelength	Designation
1	< 30 KHz	> 10 Km	VLF
2	30 – 300 KHz	10-1 Km	LF
3	0.3 – 3 MHz	1- 0.1 Km	MF
4	3 – 30 MHz	100- 10 Km	HF
5	30 - 300 MHz	10- 1 M	VHF
6	300 – 3000 MHz	1- 0.1 M	UHF
7	3 – 30 GHz	100- 10 mm	SHF
8	30 - 300 GHz	10- 1 mm	EHF

7-1.3 Microwave systems and frequency bands

Sl no	System	No of channels	Frequency band
1	UHF 2 GHz	60	12-250 KHz
2	NB M/W 7,13 GHz – 34 Mb	300	60- 1300 KHz
3	WB M/W 4,6, 11 GHz – 140 Mb	1800	300- 8204 KHz
4	Analog UHF	120	335.4- 470 MHz
5	Dig. UHF	30/120	367-399 & 420 – 461/ 622- 712 MHz
6	MARR	30	1.4-1.5&2.3- 2.5 MHz

7-1.4 M/W Frequency Bands , System and its output.

Low capacity system: - 704 Kbps, 2, 8 MB

Medium capacity :- 34 MB

High capacity :- 140 MB/ STM-1

SL.Nos	System	Frequency band	Output in MB
1	UHF	658 - 712 MHz	0.704
2	UHF	400 MHz	2
3	UHF	520 – 565 MHz	8
4	UHF	622 – 712 MHz	8
5	D / UHF	2 – 2.3 GHz	8
6	7 GHz	7.426 – 7.725 GHz	34
7	13 GHz	12.75 – 13.25 GHz	34
8	15 GHz	14.75 – 15.75 GHz	34
9	4 GHz	3.3 – 3.8 & 3.8 – 4.2 GHz	155 STM-1
10	6 GHz	5.925 – 6.425 GHz	155 STM-1
		6.430 – 7.111 GHz	155 STM-1
11	11 GHz	10.7 – 11.7 GHz	155 STM-1

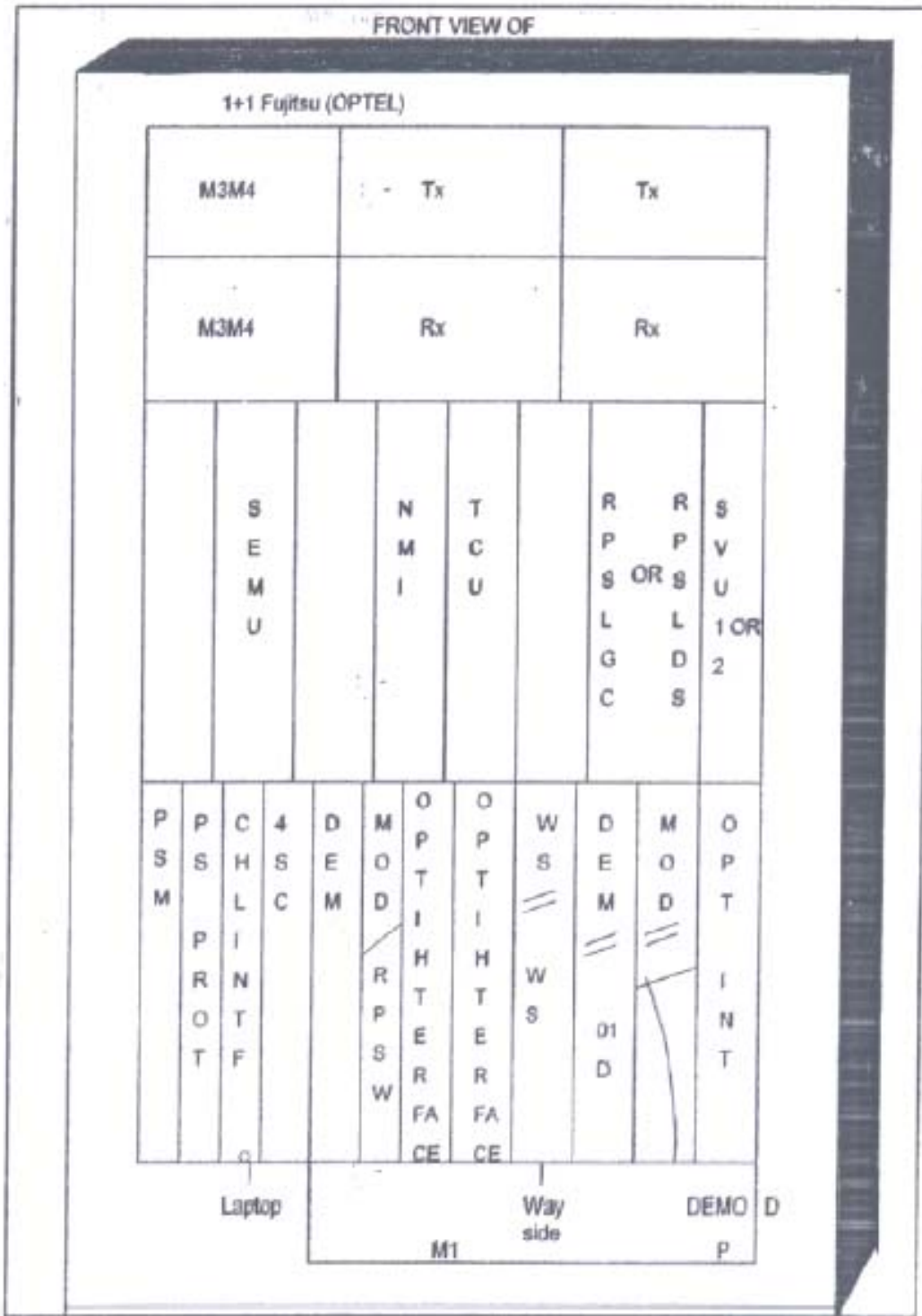

Fig. 7-2

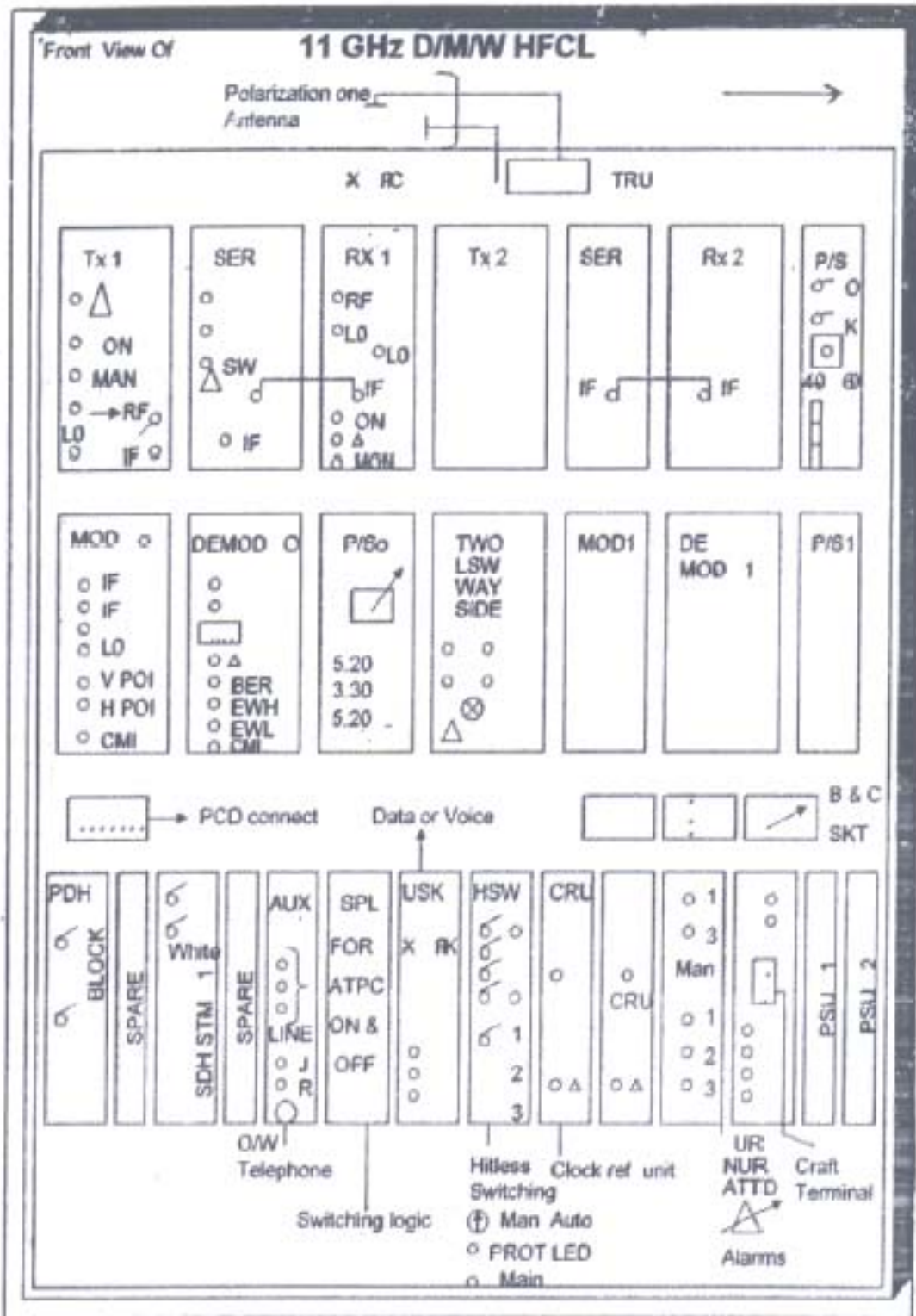

Fig 7-3

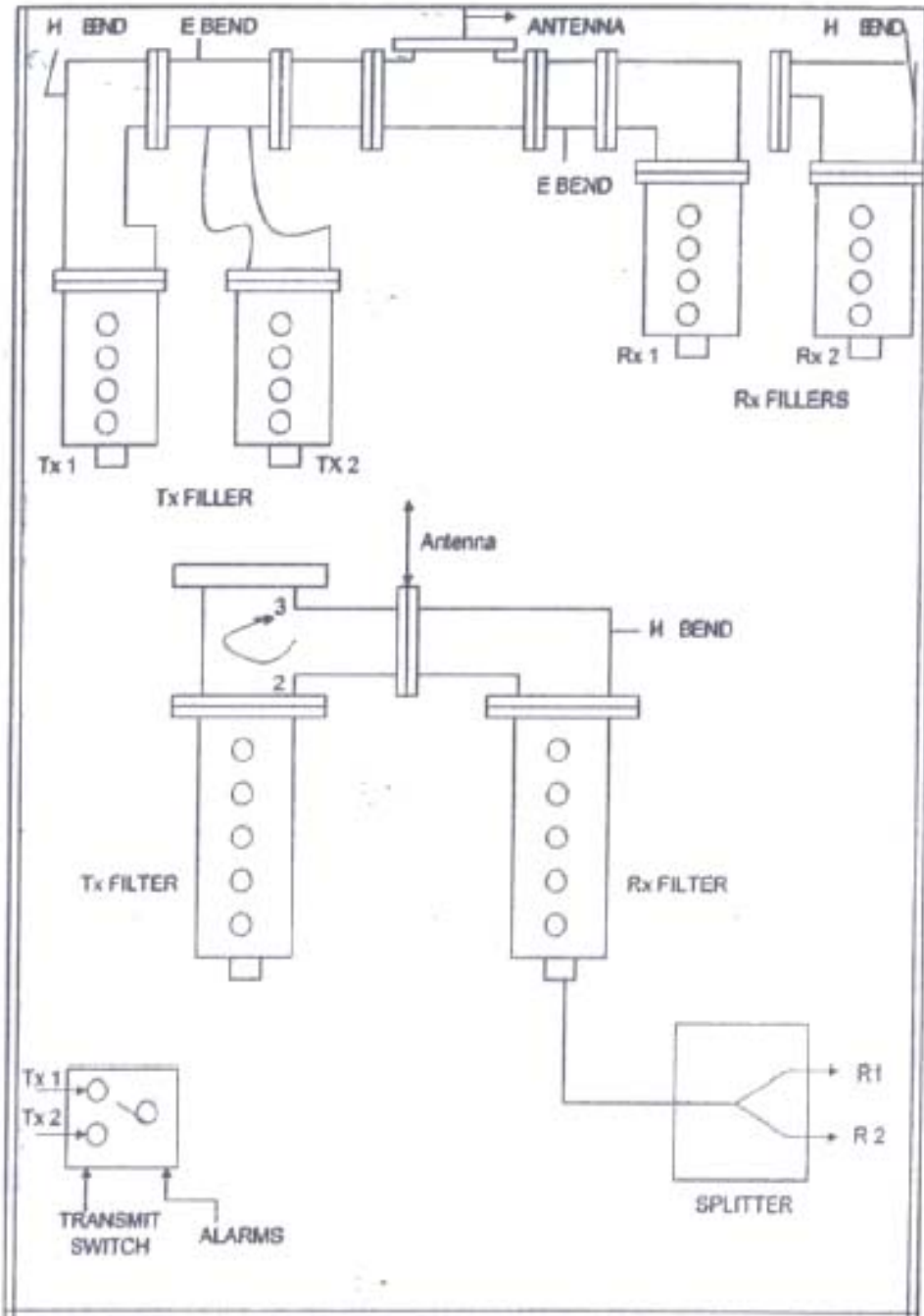

Fig. 7-4

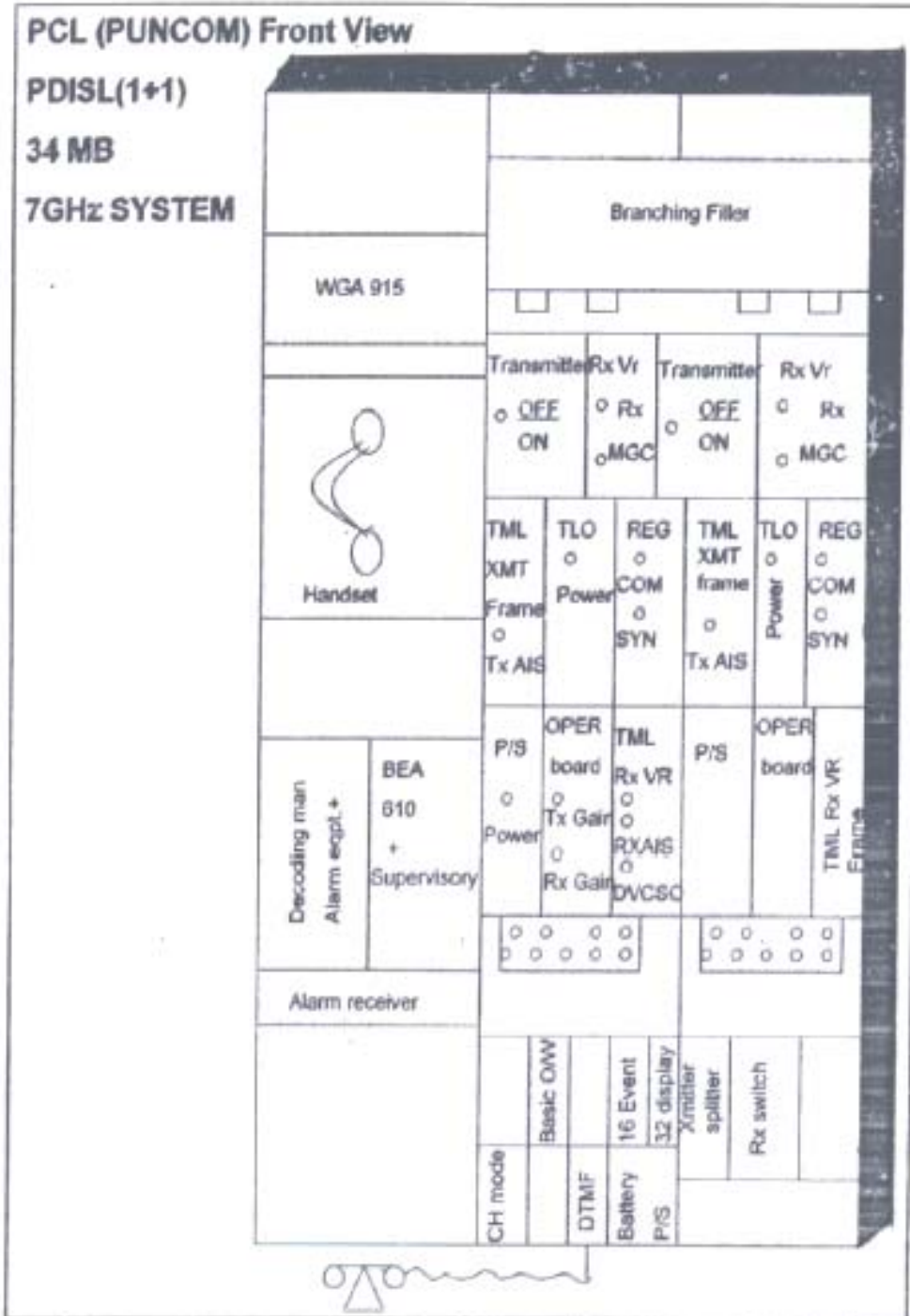

Fig. 7-5

7-1.5 Meters for M/W System

1. Power Meter Anritsu - ML 4803 A
2. Power Meter HP - 437 B, 4368, Philips 3350
3. Spectrum Analyzer- Anritsu MS 7101 B, 10 KHz- 23 GHz, 22 GHz- 140 GHz.
4. M/W System Analyzer (MSA) Transmitter & Receiver ME 538 M
Anritsu 4510 B Transmitter and Receiver.
5. M/W frequency counter Anritsu MF 76 A
6. Sweep Generator programmable Marconi instrument 10Mhz-20 GHz
7. VSWR Meters: -- HP Scalar network analyzer 8757 A
 - HP Sweep Generator 8350 B
 - Wiltron scalar network analyzer 56100 A
 - Wiltron Synthesized sweep generator 68147 B
 - Radart 2424 Synthesized signal generator 10 KHz – 10.4 GHz
 - Adaptor S/N 9610-63090 MFR 63661
 - Anritsu open/short model 22 N 50
8. Power sensors - Low power -70 to -20 dBm,
- High power -20 to + 20 dBm
9. Attenuators :- 10,20 dB HP or Anritsu
10. Jitter modulator oscillator Anritsu MH 370 A
11. Anritsu DTA Set (Transmitter and Receiver)
12. Directional Bridge HP 85020127
13. PCM Mux Tester.
14. ANT-20
15. M/W Variable Attenuator
16. VF Oscillator

7-1.6 **Before proceeding** any M/W system A/T -----

- 1] Get TT-O, TT-1 duly filled in all respect,
- 2] Collect Survey report which includes,
 - Check list
 - Route details
 - Site survey report
 - Particulars at a glance
 - Clearance calculation
 - Path data calculation
 - Rain attenuation calculation
 - Availability calculation
 - Interference calculation
 - Tower diagram
 - Line diagram
 - Path profile
 - Site map

Here you have to check the deviation in survey and nominal level which should not be more than ± 3 dBm.

N.B. Nominal system level and sample survey report 14 pages attached h/w and just for reference Optel, HFCL, PCL system's front views are shown in Fig. nos. 7-2, 7-3, 7-5.

3] Check whether Tower is new or existing, carry out Earth measurement in both the cases. Limit of Ring Earth is 0.5 ohms.

4] Before starting local A/T carry out a physical inspection of installation, Tower, W/G Earthing and its entrance in equipment room.

5] Confirm that all required meters, RF cords, available or not? This is important because so many types of meters and cords are required in M/W A/T.

6] Check whether W/G entry is through hatch plate or not?

7] Obtain equipment room layout of all stations along with repeaters, duly approved by DET Maintenance.

8] Take the information regarding antenna diameter, gain etc. also confirm whether orientation of antenna is over or not, receive level is within limit or not.

9] Whether -50V is taken from MCB with proper gauge wire or not.

10] Check QA stamp or QA approval of the system

11] Obtain SACFA clearance, if not available or if applied then note down the registration number along with the date.

12] Note down earth resistance measured by maintenance within 6 months or otherwise carry out earth audit.

7-1.7 Sample Survey Report

INDEX

	<u>Page Nos.</u>
1. CHECK LIST.	-1-
2. ROUTE DETAILS.	-2-
3. SITE SURVEY REPORT.	-3-
4. PARTICULARS AT A GLANCE.	-4-
5. CLEARANCE CALCULATION.	-5-
6. PATH DATA CALCULATION.	-6-
7. RAIN ATTENUATION AND INTERRUPTION TIME CALCULATIONS.	-7-
8. AVAILABILITY CALCULATIONS	-8-
9. INTERFERENCE CALCULATIONS.	-9-
10. TOWER DETAILS	-10-
11. LINE DIAGRAM	-11-
12. PATH PROFILE.	-12-
13. SITE MAP	-13-

CHECK LIST		
S/R Communication between : Satara (M/W)-Satara Coaxial, 11GHz 140 Mbps Digital Microwave.		
1	Authority for Survey	Divisional Engineer Telecom., Project Survey Division, Telephone Complex, Dadar (W)., MBI-28.
2	Hops	SATARA (M/W) SATARA (COAXIAL)
3	Hop-Distance (Kms.)	2.30 KMS.
4	Frezental Zone Clearance	B1 + F1
5	Link is initial or alternate	ALTERNATE
6	Antenna Dia (MTR.)	2.4 2.4
7	Antenna Gain (dB)	46.2 46.2
8	TV Interference if any	Higher Frequency, Hence No Interference.
9	Frequency Plan	11GHz, 140 Mbps Digital M/W (As per DOT Plan)
10	Deptl. or R&G purpose	Departmental
11	Receive Level in dbm	-27.06

Station	Tower		Land Position	Bldg	Power Supply	Power Plant	By.	E/A	App Road	Existing Exch.	Place of Important
	Exist/ New	Height in Mtr.									
Satara (M/W)	Exist	100 M (HW)	DOT	A	A	A	A	A	A	YES	This system is to provide end link between the two stations.
Satara (Coaxial)	Exist	60 M. (HW)	DOT	A	A	A	A	A	A	YES	

SITE SURVEY REPORT

SATARA (M/W) - SATARA (CO-AXIAL)

11 GHz, 140 MBPS, DIGITAL M/W SCHEME

This report is prepared as per the instructions received from Director Telecom Projects (WMA) Mumbai - 400 013. The Satara (M/W) station is also known as Ajinkyatara. The proposed 11 GHz Micro Wave link between Satara (M/W) and Satara (Co -axial) will work as an end link between the two stations. It will also provide connectivity to the Mahabaleshwar hill station to the Satara Town via Satara (M/W), after Mahabaleshwar is connected to the Satara (M/W) through a M/W system. This scheme has been planned for (1+1) configuration. This scheme is planned on 1:50,000 scale of Survey of India Map.

STATION DETAILS

1. SATARA MICROWAVE :

This is an existing Microwave Station at Ajinkya Tara Fort. This station is a repeater station on 6GHz, 140 MBPS Digital Microwave link connecting Pune and Belgaum. Existing infrastructure eg Building, Power Plant, Battery and Tower can be used for this scheme also. A 100M HW tower is existing at this place.

2. SATARA CO-AXIAL :

Satara Co-axial and Telephone exchange are in the same compound in Satara city. From the 60M HW Tower, available here, Satara - Aundh 2 GHz system is working. Same tower is suggested for this scheme also. Equipment can be installed by the side of the existing 2GHz equipment in the equipment room. Existing Battery and Power Plant are adequate for this scheme.

ROUTE DETAILS				
NAME OF THE ROUTE	SATARA (M/W)-SATARA (COAXIAL)			
NUMBER OF HOPS	ONE			
SYSTEM CONFIGURATION	1+1			
NUMBER OF Tx/Rx	Tx	Rx	HOP LENGTH (KMS.)	
NAME OF THE STATION				
1) SATARA (M/W)	2	2	2.3	
2) SATARA (COAXIAL)	2	2		
SPACE DIVERSITY	NO			
NAME OF THE STATION	Tx (MHz)		Rx (MHz)	
1. SATARA (M/W)	11225		10,735	
2. SATARA (COAXIAL)	10735		11,225	
ANTENNA (MTRS.)	TYPE	SIZE	HEIGHT MTRS.	WAVEGUIDE LENGTH
1. SATARA (M/W)	Parabolic Reflector	2.4 M.	90 M.	100 M.
2. SATARA (COAXIAL)	Parabolic Reflector	2.4 M.	50 M.	70 M.
S/R APPROVAL REFERENCE				
PE SANCTION PARTICULARS				
DFG No./				
PAYING AUTHORITY				
CONSIGNEE PARTICULARS				

PARTICULARS AT A GLANCE						
SCHEME	SATARA (M/W)-SATARA (COAXIAL), 11GHz, 140 MBPS DIGITAL M/W					
HOP	SATARA (M/W)-SATARA (COAXIAL)					
HOP DISTANCE	2.30 KMs.					
NAME OF STN.	SATARA (M/W)			SATARA (COAXIAL)		
HASL IN M.	1000.00			680.00		
LATITUDE	17	40	16	17	41	12
LONGITUDE	73	59	46	74	0	34
AZIMUTH	39	24	19	219	24	34
ANT. HT. (MTR.)	90 M.			50 M.		
TOWER HT. (MTR.)	100 M. (HW) EXIST			60 M. (HW) EXIST		
FREQUENCY (In MHz)	11225			10735		
POLARISATION	HORIZONTAL					
LEADING-IN CABLE	NR			NR		
APPROACH ROAD	NR			NR		

CLEARANCE CALCULATION SHEET

11GHz, 140 MBPS DIGITAL M/W SYSTEM

SCHEME	SATARA (M/W)-SATARA (COAXIAL), 11GHz, 140 MBPS DIG.			
HOP	SATARA (M/W)-SATARA (COAXIAL)			
HOP DISTANCE	2.30 KMS.			
MID FREQUENCY	11.000 GHz			
d1 MEASURED FROM	SATARA (M/W).			
d1	KM.	0.40	0.60	0.9
d2	KM.	1.90	1.70	1.4
B 2/3	(MTRS.)	0.09	0.12	0.15
0.3 F	(MTRS.)	0.90	1.04	1.16
B 2/3+0.3F	(MTRS.)	0.99	1.16	1.31
B1	(MTRS.)	0.06	0.08	0.1
F	(MTRS.)	3.00	3.47	3.86
B1+F	(MTRS.)	3.06	3.55	3.96
C	(MTRS.)	3.06	3.55	3.96
OH	(MTRS.)	10.00	10	10
E	(MTRS.)	1000.00	920	900
E+C+OH	(MTRS.)	1013.06	933.55	913.96
Hm	(MTRS.)	1019.13	938.7	919.04
Hm-(E+C+OH)	(MTRS.)	6.07	55.14	29.08
Name of the Station	Satara (M/W)		Satara (COAXIAL)	
Site elevation in Mtrs. above MSL	1000.00		680.00	
Tower height in Mtrs.	100 M. (HW) EXIST		60 M. (HW) EXIST	
Antenna height in Mtrs.	90.0 M.		50.0 M.	

REFLECTION POINT	} K=INF:	-0.9684
(in KM.) FROM	} K=4/3:	2.7626
SATARA (M/W)	} K=2/3:	2.7636

PATH DATA CALCULATIONS

SYSTEM : 140 MBPS DIGITAL M/W	FREQUENCY : 11 GHz
CAPACITY : 1920 Chs	FEEDER LOSS : 10 dB/100 M

HOP :	SATARA (M/W)	SATARA (CO-AXIAL)
DISTANCE (KMs) :	2.30	
ANT. HEIGHT (MTRS) NML:	90 M	50 M
FREE SPACE LOSS (20 LOG FD + 92.4) :	120.46	
BRANCHING FILTER LOSS :	6.0	
FEEDER LOSS :	20.00	
TOTAL LOSSES :	149.46	
ANT. DIA (MTRS) :	2.4	2.4
ANT. SYSTEM GAIN :	46.20	46.20
TRANS. POWER (dBm) :	+30.00	
TOTAL GAIN :	122.40	
RECEIVED LEVEL IN dBm (pr):	-27.06	
REC THRESHHOLD FOR 10 ⁻³ BER IN Dbm EQPT FADE MARGIN:	72.00	
EQPT FADE MARGIN :	44.94	

RAIN ATTENUATION CALCULATIONS

SATARA (M/W) - SATARA (CO-AXIAL) 11 GHz 140 MBPS DIGITAL M/W

01. FREQUENCY	:	11 GHz
02. HOP LENGTH (d) KM	:	2.3
03. THRESHOLD LEVEL FOR BER IN dbm	:	-72.0
04. RECEIVE LEVEL (dbm)	:	-27.06
05. FADE MARGIN (db)	:	44.94
06. DESIGN VALUE OF 0.01% RAIN RATE (R)	:	77
07. RAIN ATTENUATION MARGIN A_b (db)	:	40.94
08. RAIN ATTENUATION $= (a.R^b) \times d \times 90/90+d$:	

HORIZONTAL POLARIZATION	VERTICAL POLARIZATION
$a = 0.0144$	$a = 0.0127$
$b = 1.24$	$b = 1.22$
$d = 2.3$	$d = 2.3$
$R = 77$	$R = 77$
A_h = Rain Attenuation in case of Horizontal Polarization.	A_v = Rain Attenuation in case of Vertical Polarization.
$A_h = 6.56$ db	$A_v = 5.30$ db

AVAILABILITY CALCULATIONS

SATARA (M/W) - SATARA (CO-AXIAL) 11 GHz 140 MBPS DIGITAL MW

01.	Name of Hop	:	SATARA (M/W) - SATARA (CO-AXIAL)
02.	Hop distance	:	2.3 KMs
03.	System receive level	:	- 27.06 dBm
04.	System threshold for BER 10E-3	:	72.0
05.	Flat fade margin FFM:		44.94
06.	Margin for multipath : fade MM		4dB
07.	Effective fade Margin : EFM (FFM-MM)		40.94dB
08.	Terrain roughness : factor S		6
09.	Climatic, Geographic & roughness factor (PMKQ) ($4.1 \times 10^{-5} / S^{1.3}$)	:	0.399×10^{-3}
10.	Probability of effective fade margin ($PMKQ \cdot 10^{E(-EFM/10)} \cdot DE^3 \cdot F$)	:	4.3×10^{-8}
11.	CCIR limit ($20 \times 10^{-7} / KM$)	:	4.6×10^{-7}

NOTE : SYSTEM OUTAGE IS LESS THAN CCIR OUTAGE.

INTERFERENCE CALCULATIONS

Since this being the first 11 GHz scheme in this vicinity .Hence
Inter system Interference is not likely.

LINE DIAGRAM OF
SATARA (M/W) SATARA (CO-AXIAL)
11 GHz 140 MBPS DIGITAL M/W SCHEME

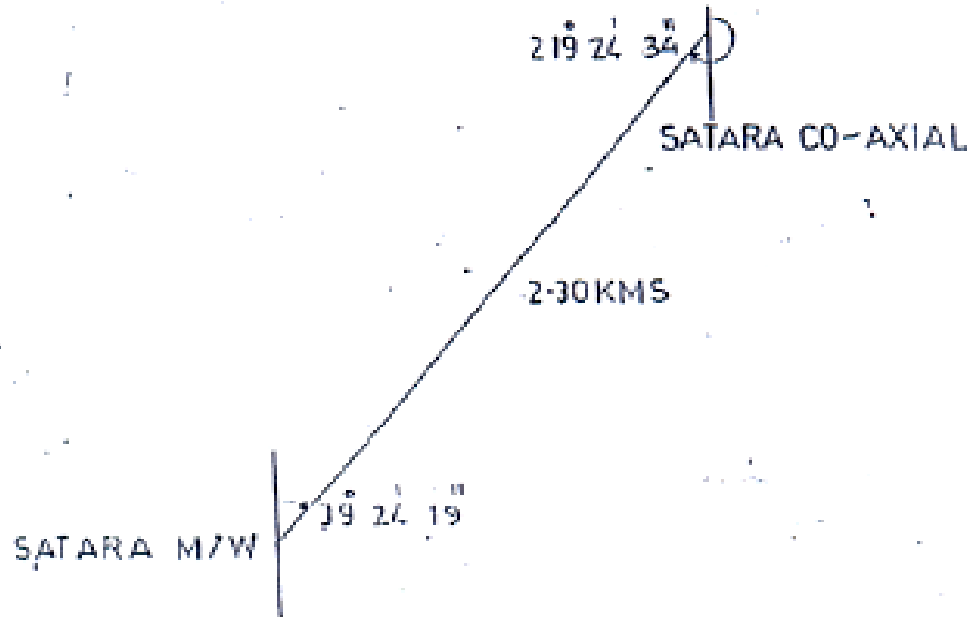

SCALE = 5 CM TO 1.00 KM

SNO	STATION	LATITUDE	LONGITUDE	HASL Mtrs	TWT Mtrs	AN/HT Mtrs	
						F	B
1	SATARA M/W (Ajinklara)	17° 40' 16"	73° 59' 46"	1000	100 (Ex1)	90	-
2	SATARA CXL.	17° 41' 12"	74° 00' 34"	680	60 (Ex1)	-	50
DRAWN <i>K. S. Patil</i> 22/11/88 S.D.M.		CHECKED <i>S. D. Chavale</i> S.D.E.		APPROVED <i>S. D. Chavale</i> 23/11/88 D.E.T.		DIVISIONAL ENGINEER TELECOM PROJECT SURVEY DIVISION MUMBAI - 400028	

TOWER DETAILS									
STATION	TOWER HEIGHT		ANTENNA HEIGHT	ANTENNA SIZE	AZIMUTH			REMARKS	
	EXISTING	PROPOSED							
SATARA (M/W)	100 M. (HW)		50 M.	3.0	308	45	10	Power-Digitize (M/W) Digital (Towards Post)	
			40 M.	3.0					
				30 M.	3.0	156	9	41	Power-Digitize (M/W) Digital (Towards Belgawan)
				20 M.	3.0				
				60 M.	3.7	308	45	10	Mobile/Cellular-Station Coaxial, 2224 Digital (Towards Belgawan)
		60 M.	1.8	39	24	19	Mobile/Cellular-Station Coaxial, 2224 Digital (Towards Jaram Coaxial)		
		90 M.	2.4 M.	39	24	19	Seam M/W-Station Coaxial, 11024 Digital		
SATARA (COAXIAL)	60 M. (HW)		40 M.	3M (UHF ANT)				Enter-Audio, 2012 Digital	
			40 M.	1.8	219	24	37	Mobile/Cellular-Station Coaxial, 2224 Digital UHF	
			50 M.	2.4	219	24	37	Seam M/W-Station Coaxial, 11024 Digital	

Survey ends.

HP Power Meter



Fig. 7-6

Anritsu Frequency Counter

7-2 MICROWAVE SYSTEM A/T

Microwave A/T comprises of - Local A/T of all stations, and Repeaters.

- Hop Test.
- Through Test.

7-2.1 Local A/T:-

There are several makes of Narrow / Wide band microwave systems, near about all test are same except power supply points, access points. Here for example Satara M/W station to T.E. end link of 11 GHz (1+ 1) digital M/W system Make-HFCL, is described.

1. Check of power supply:-

Measure voltage at Battery point and Bay input, note down the voltage drop. Limit :- 1.0 V. If not within limit then measure voltages step by step that is from battery- OCB distribution- Equipment room distribution-Suit distribution and find out in which section it is more.

Check the gauges of wires and loose connections.

Output voltages:- some systems are not having access points to measure the output voltages.

a. Modem shelf PSU

	+5.2 V,	+3.3 V and	-5.2V
Limit: -	±0.25V	±0.15V and	±0.25V

b. RSA shelf PSU

	+5.3V	+12.0V	-5.5V
Limit: -	±0.25V	±0.5V	±0.25V

2. Test on Transmitter:-

- TLO: - Write down the assigned frequency of TLO and measure by Microwave frequency counter at TLO Mon,
- Press impedance 50ohms, resolution, KHz
- Press offset and get deviation which should be within the limit of ±20 PPM

E.g. Assigned TLO frequencies 11295 MHz

Measured -----“-----11294.935.207MHz

Deviation ----- -5.7PPM

Here 647993 Hz frequency is less than the assigned frequency and deviation is -5.73, so in PPM it is how much?

$$\text{PPM} = \frac{\text{Out Hz}}{\text{Assigned frequency in MHz}} = \frac{64793}{11295} = 5.73 \text{ PPM}$$

-TLO O/P level (Mon):- Measure output power by spectrum analyzer by tuning TLO frequency or by Power meter. Limit: - ≥-12 dBm

Transpower at Power Amplifier out: - limit $+30 \pm 1$ dBm

Now the power meter may be Anritsu or HP See HP power meter in Fig. 7-6.

- HP will show please zero.
- Connect High power sensor to the Power meter.
- Press zero and wait for zeroing function.
- Press CAL key and display will show REF CF 100%.
- Using $\leftarrow \blacktriangle \rightarrow$ modify PM's display until the power sensors REF CAL FACTOR display.
- Press ENTER key, PM display CAL when CAL disappears CAL is finished.
- Press CAL FAC key, display CAL FAC 100%.
- Press ENTER, Press PWR REF.
- PM will display $0.00 \text{ dBm} \pm 0.02 \text{ dBm}$.
- Press dBm/W key, display $1.000 \text{ mw} \pm 0.05 \text{ mw}$.
- Press dBm/W key to display dBm.
- Press offset key, display OFS $+0.00 \text{ dBm}$.
- Use $\leftarrow \blacktriangle \rightarrow$ to modify display OFS $+0.3 \text{ dBm}$.
- Press ENTER, PM display $3.00 \text{ dBm} +0.2 \text{ dBm}$
- Connect 30 dB attenuator to PM and measure RF power at amplifier out

Trans IF level limits vary system to system like -10 ± 1 or -3 ± 1 dBm

- Connect IF cord to power meter and measure level on Power meter or same power can be measured on spectrum analyzer by tuning IF 70 MHz frequency.

Trans power at antenna port: - which may be less than 3 to 4 dBm than at PA out
- Remove wave guide from antenna port of rack and connect power meter by RF cord.
- Note down the power which is 3 to 4 dBm less. Check power in both conditions of ATPC on and off by suitable strapping in MOD unit .

Frequency measurement at PA out in MOD off condition with 30 dB attenuator and IF through. Connect frequency counter at PA Mon. Press Impedance, KHz, offset and read RF frequency with deviation in PPM.

Branching filter loss:-

The difference between the trans power at PA out and antenna port gives the branching filter loss limit 3 to 4 dBm as per make of the systems and it's specifications.

Check of spurious and harmonics 2nd and 3rd at antenna port:-

- Feed 70 MHz at -10 dBm from mod unit. To IF in of Trans unit.
- Connect spectrum analyzer to antenna port through 30 dB attenuator
- Set SA in center trans frequency with RBW 300 KHz, span 50 MHz, VBW off, and sweep 100ms
- Check level for 2nd and 3rd harmonics
- Limit better than -50 dBc .

3. Test on receiver:-

- Check of RLO frequency :- Check of RLO frequency with unritsu or HP frequency counter, measure frequency and offset
- Write assigned measured and deviation in PPM limit ± 20 PPM
- Measure RLO output level at RLO mon limit ≥ -12 dBm
- Feed Receive RF frequency at a level of -30 dBm at RX, RF and record
- 1. RF frequency limit ± 250 KHz
 2. If level at AGC out (IF out) limit -5 ± 1 dBm
 3. IF level at AGC Mon Socket limit -10 ± 1 dBm

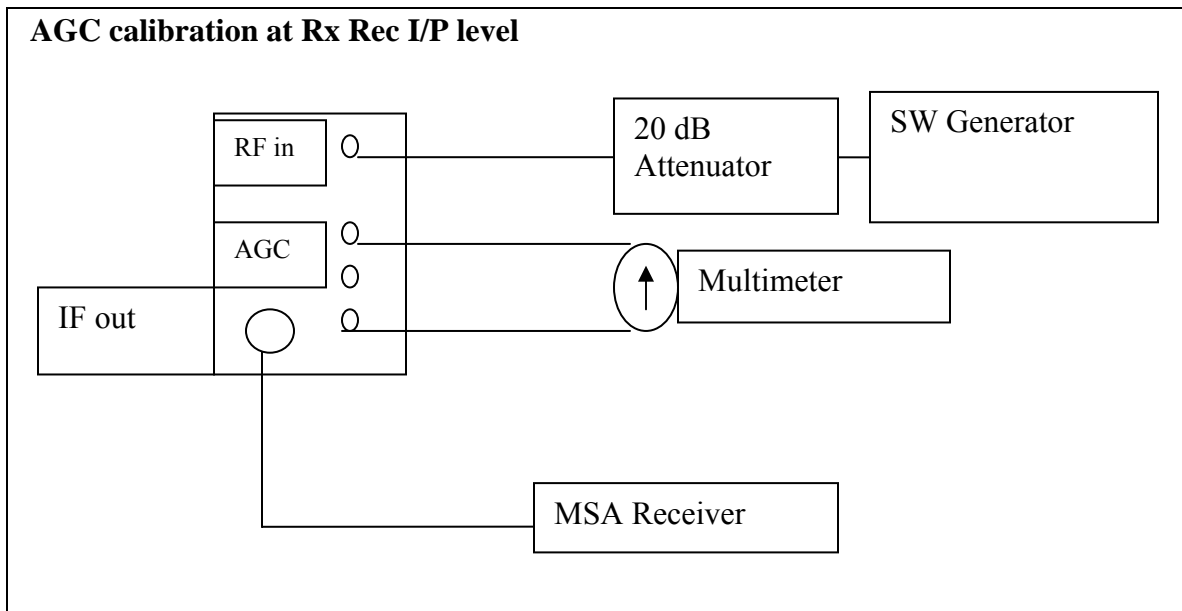

Fig. 7-7

- Make test set up as per above diagram no 7-7 for 7 GHz system.
- Sweep oscillator output is to be calibrated with spectrum analyzer with -20 dB attenuator for -20 dBm level.
- Adjust -3 dBm by IF level potentiometer and then vary AGC input level by microwave Variable attenuator.
- Start by -20 dBm as -17 is overload and note down the BITE reading and DC Mon voltage.
- Go low by 10 dB step up to -70 dBm and after that lower the level by 1 dBm until a receive alarm is monitored. The level at which Rx fail LED glows, is a threshold level for BER of 1×10^{-3} and squelch will be monitored when BER 1×10^{-5} i.e. degradation starts and change over takes place, say at a level 2 to 3 dBm less than the threshold level.
- Now go to back to restore the squelch and note down difference. This is hysteresis reading.- Limit . -17 dBm overload, -75 dBm receive threshold Range 50 dB from threshold.

7-2.2 VSWR: - Voltage standing wave ratio

Standing wave :- If the impedance of the load (Antenna) and source (Generator) is not equal, that is not matching then part of the energy is reflected back towards the source., some power is absorbed and rest is reflected .this interference form one set of waves V & I traveling towards the load and reflected set travels back to generator. These two sets of traveling wave moving in opposite direction 180 out of phase. This reflected wave which varies in Voltage/ Current combines with transmitted wave and summation of both produces a wave called standing wave. It forms a set of interference in the form of standing wave. See Fig. 7-8

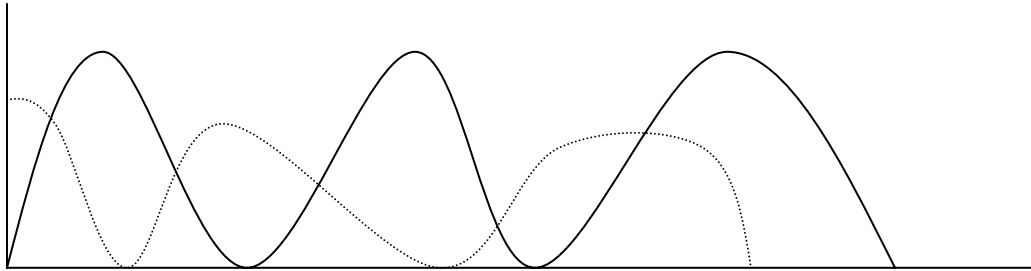

Fig. 7-8

SWR: - The ratio of maximum voltage to minimum voltage along with a transmission line is called SWR. When impedance of source (Transmitter), media (Waveguide), and load (Antenna) is matching perfectly then SWR = 1.

VSWR: - Due to the irregularities in waveguide, voltage tends to add to get maximum voltage and due to phase difference voltage tends to minimum also.

Cause of worst VSWR: - Inside damage of waveguide, bends, inside water, loose connections, inside holes etc.

If not within limit then required receive level is not possible at distant end , degradation of services, poor coverage in case of GSM.

Return Loss: - It is a ratio of amplitude of reflected wave to the amplitude of incident wave. This loss shows reduction in amplitude of reflected energy compared to transmitted energy. Is is expressed in dB. It is a measure of irregularities in W/G. Return loss should be always more to suppress echo distortion, inter modulation noise and to maintain group delay and response within limit.

$$\text{Return Loss} = -20 \text{ Log } \rho \text{ (Reflection coefficient)} = \frac{V_r}{V_i}$$

Vr: - Reflected voltage wave and Vi: - Incident voltage wave.

How to measure Return loss:-

- Make set up of System Analyzer Transmitter, Receiver, Termination Bridge as per diagram no. 7-9, 7-10, 7-11.
- adjust sweep oscillator for desired band of frequency, confirmed by frequency counter.
- Calibrate level with open/ short and load connectors.
- remove Connectors and connect W/G to the test port.
- Read the trace and return loss over the required frequency band.

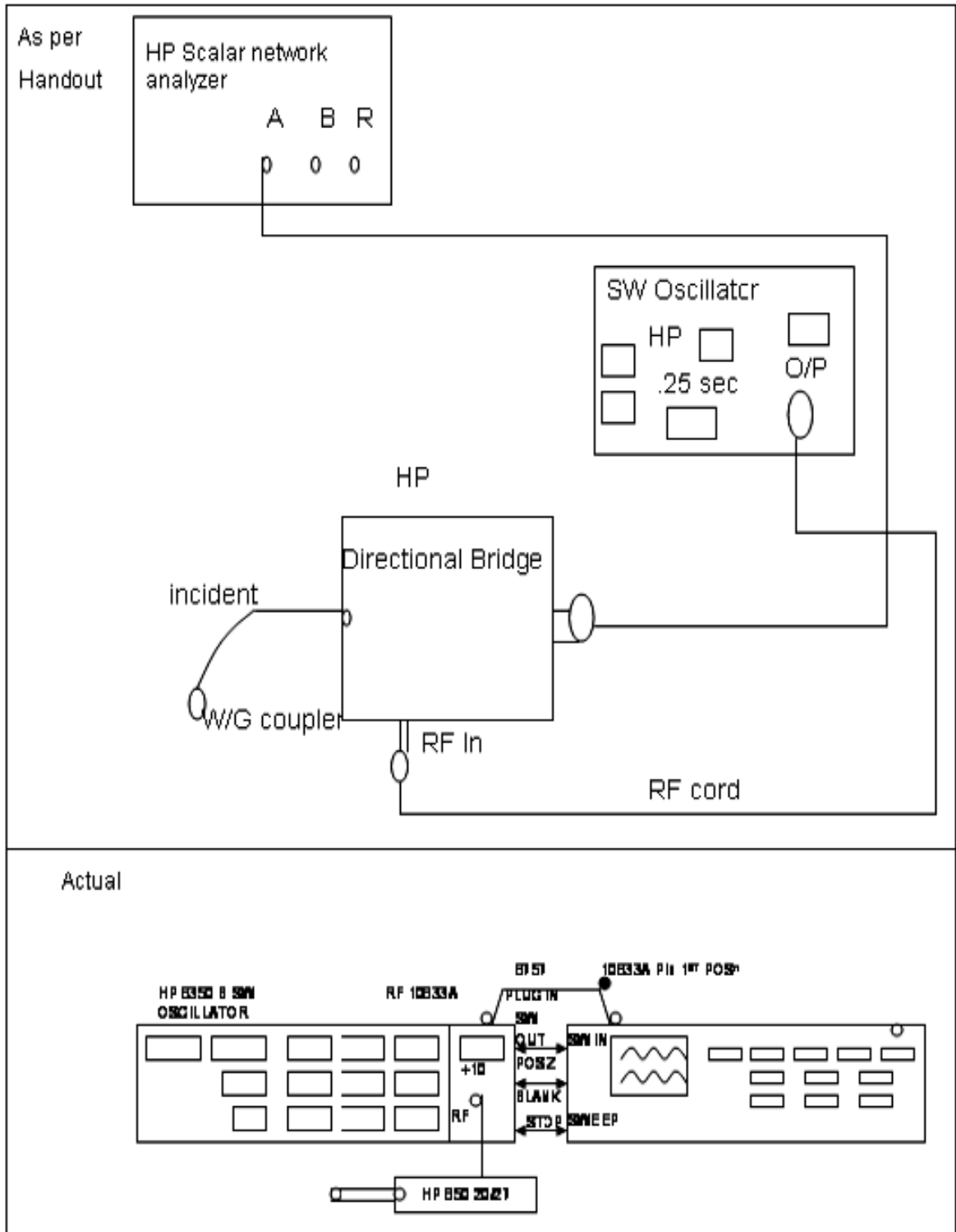

Fig. 7-9

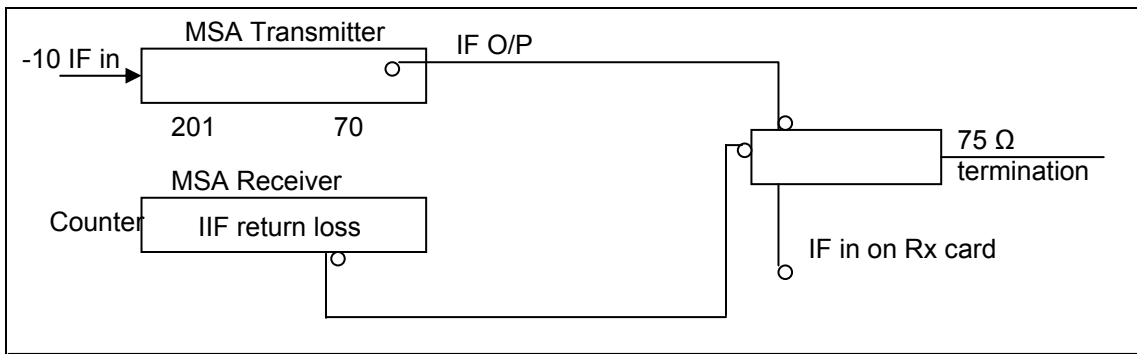

Fig. 7-10

Conversion chart of VSWR, Return Loss and SWR.

VSWR	Return loss In dB	Reflection Coefficient	SWR In dB
1.01	46.1	0.5	0.086
1.02	40.1	1.0	0.172
1.03	36.6	1.5	0.257
1.04	34.2	2.0	0.341
1.05	32.3	2.4	0.424
1.06	30.7	2.9	0.506
1.07	29.4	3.4	0.588
1.08	28.3	3.8	0.668
1.09	27.3	4.3	0.749
1.10	26.4	4.8	0.828
1.11	25.7	5.2	0.906
1.12	24.9	5.7	0.984
1.13	24.3	6.1	1.06
1.14	23.7	6.5	1.04
1.15	23.1	7.0	1.14
1.18	21.7	8.3	1.21
1.20	20.8	9.1	1.44
1.30	17.7	13.0	1.58
1.50	14.0	19.95	2.28
1.43	15.0	17.78	
1.38	16.0	15.85	
1.33	17.0	14.13	
1.29	18.0	12.59	
1.25	19.0	11.12	
1.222	20.0	10.00	
1.196	21.0	8.93	
1.173	22.0	7.943	
1.152	23.0	7.079	
1.135	24.0	6.310	
1.119	25.0	5.563	
1.106	26.0	5.012	
1.094	27.0	4.467	

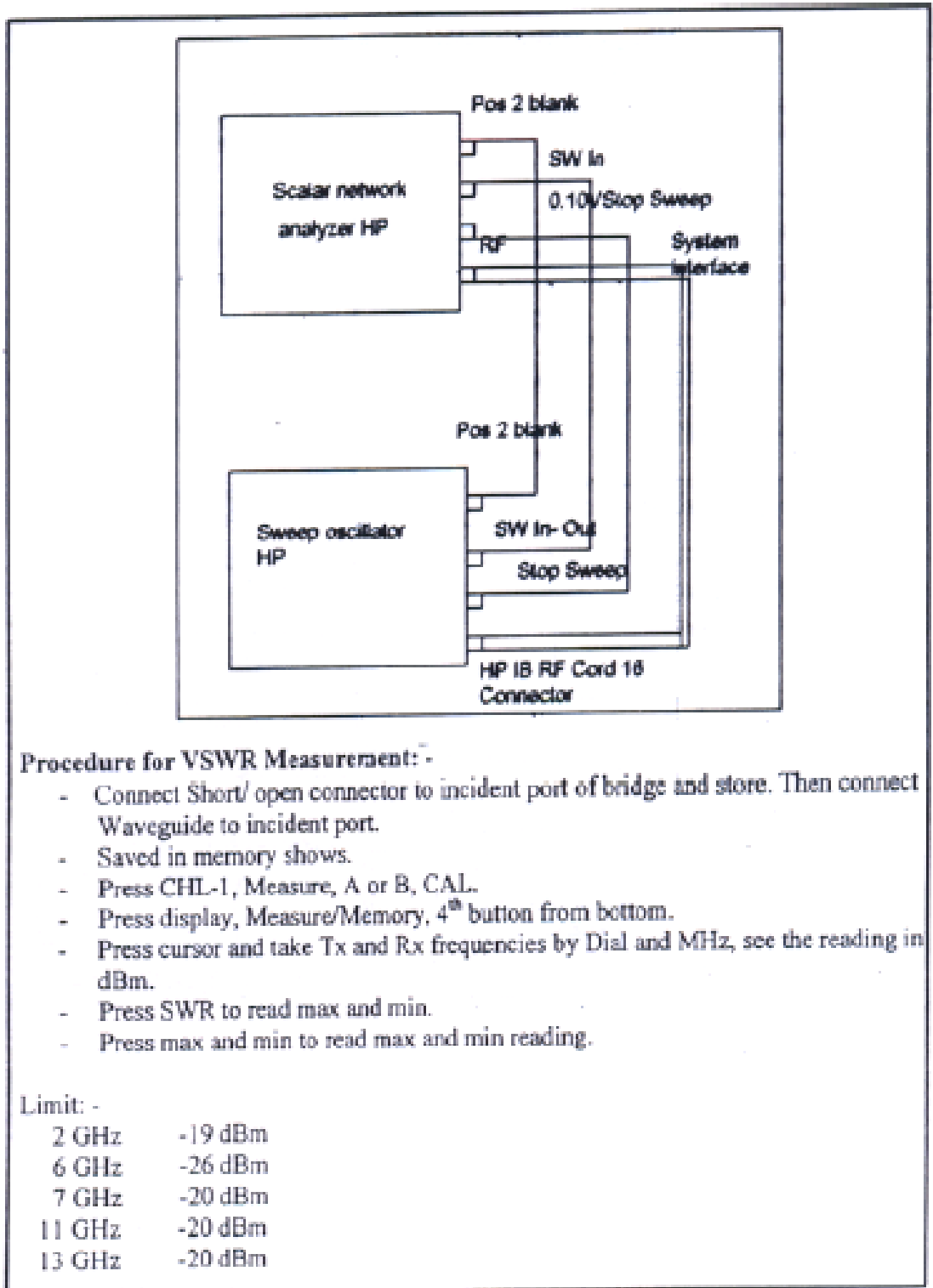

Fig. 7-11

VSWR With WILTRON SET

Wiltron 56100A Scalar network analyzer

Wiltron synthesized sweep generator 68147B

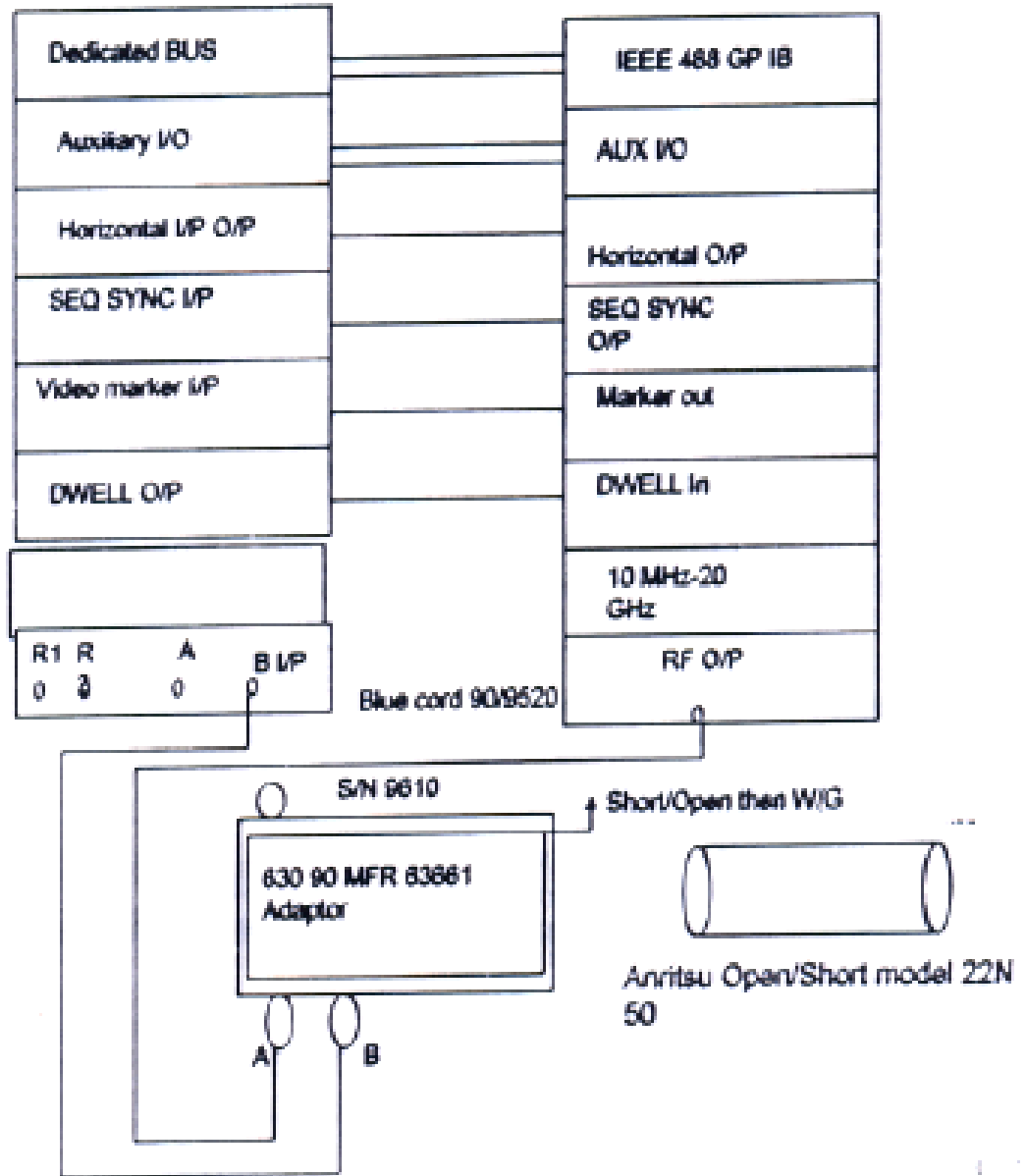

Fig. 7-12

Please see the Wiltron diagram,
Anritsu detector converts power into voltages.

- Connect Open , select
 - Connect Short , select
 - Connect device ,
 - Start select,
 - Function,
 - Max /select -20 dBm,
 - Min / select -34 dBm,
 - Cursor also move for max to minimum.
- Wiltron Generator: - See Fig. 7-12, 7-13.
- Take 10.7 to 11.7 GHz
 - Level +10 dBm (+ 7 to + 12 can be taken) and calibrate Analyzer,
 - Start calibration ,
 - Select Open / Short ,
 - Calibration completed,
 - Connect device,
 - Move cursor on; get trace for max and minimum.

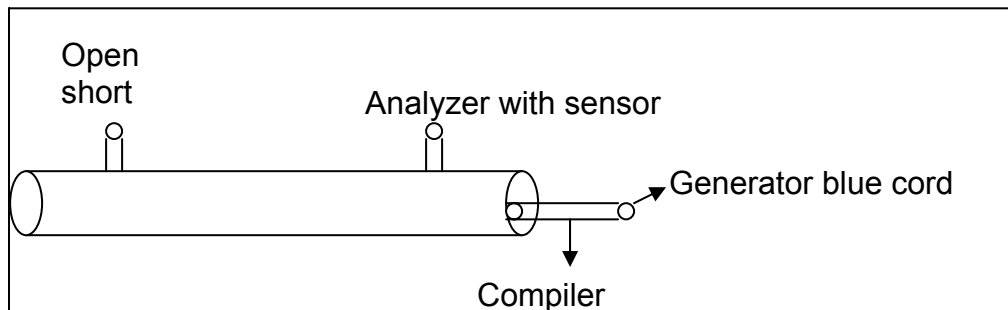

Fig. 7-13

- Select 11 GHz band, take marker on max and min by function switch and select max -26 & -34 dBm.

7-2.3 Some General test: -

Image Frequency Rejection test: -

- Image Frequency = Receive frequency + 2 IF
- Feed Image frequency at a nominal level of the system, at antenna port.
- Measure IF Out level at RRF out.
- Image frequency Suppression should be > -65 dBm.

4. Check of BER with IF Loop: -

Loop IF Trans to If Receive and test 140 Mb/ STM-1 on DTA set for 0 PPM and ± 15 PPM. The result should be $0.00 E^{-11}$

5. a) Trans Branching Filter loss: -

The difference between Trans Power at PA out and antenna port will be a Trans Branching Filter loss.

b) Receive Filter loss: -

Feed RF Frequency at a nominal level to antenna port and measure at Rx in, Calculate receive filter loss.

Limit: - Tx + Rx combined filter loss should be 6 dB max.

6. Isolation between Transmitter and Receiver:-

- **TX – Rx**

- Keep Transmitter ON, for Tx – Rx isolation.
- Tune the transmitter frequency at RRF in point on spectrum analyzer.
- Limit: Better than 70 dB

- **Rx-Tx**

- Feed Rx RF at antenna port and measure at co-axial cable connected to PA out ,
- Limit: Better than 70 dB

7. Waveguide pressurization in Kg/ Cm²

- Note down Waveguide pressure in Kg/ Cm²

8. Some test of 7 GHz system: - **ALC Test (Automatic level control)**

- Make the test set up as below Fig. 7-14
 - feed -3 dBm to IF in
 - Adjust +30 dBm at PA out
 - Vary IF level from -1 to -7 dBm
 - Observe level at PA out which should be near about constant , one example,
- | IF | PA |
|----|---------|
| -1 | +30.000 |
| -3 | +30.05 |
| -5 | +29.99 |
| -7 | +30.05 |

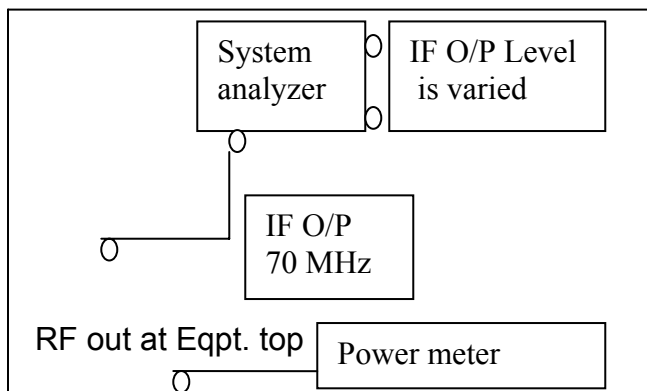

Fig. 7-14

Low Transpower alarm:-

- Same set up ALC and go IF level low to see Transpower alarm LED to glow by 3 dB minimum
- This alarm on display shows at > 33 dBm and < 25 dBm Transpower
- Go low by 1 dB step to get this alarm.

7-2.4 HOP A/T OF 11 GHz 140 Mbps or STM-1

1] Receive level: - Note down Surveyed level, Nominal level and measure Rx RF level at Rx IN by power meter with suitable sensor and pad by removing the W/G from RF IN.

- The same Rx RF level can be measured with calibrated spectrum analyzer and by tuning the required frequency of a channel, deviation between measured and surveyed should be within ± 1 dBm.

- The deviation between surveyed and nominal level should be within ± 3 dBm. As per the test schedule of DOT ML section..
- Measure Rx level on all Main and Protection channel with ATPC ON , (If provided)
- Measure Rx level at RF Rx IN due to X- Polarization (if provided) which should be Better than -30 dBmo from measured RF level or better.

2] Measure IF level at AGC out. Limit is -5 ± 1 dBm and at Mon skt Limit -10 dBm.

Measure AGC voltage at connector M-69 pin 1-8, reading may be -6.0 V, this is for reference only.

3] Group delay and IF response:- See Fig. 7-15

It is the transit time delay effect. The transit time for a transmission path is a time required by a specific voltage or current to travel through the transmission path. This time is given by the rate of phase shift & angular frequency.

Take test in MGC (Manual Gain control) only, keep all station MOD off.

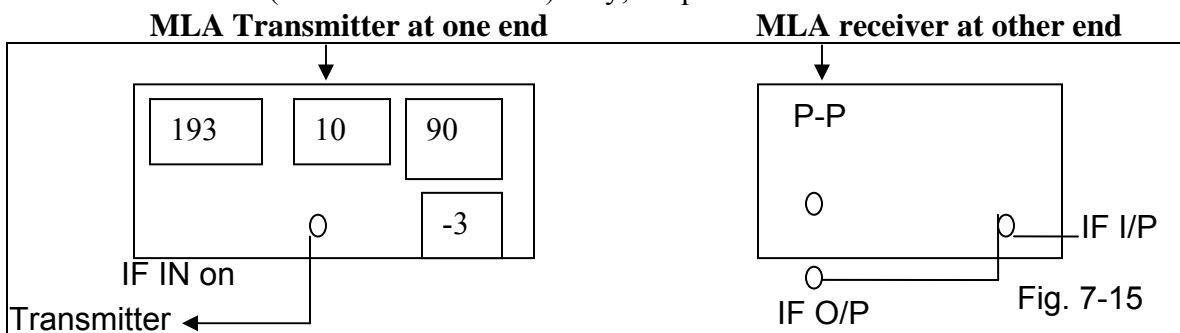

Front

- Blinking ON
- X select IF
- Counter
- P-P chose frequency
- Auto at 83.5 KHz
- IF (BB frequency)

Rear

- BB select NML
- Character ON
- PLL out frequency high
- CRT Trace CM O/P
- Threshold EXT Off
- EXT/Line selector
- Line marker selector

Received CF – 70 MHz

Sweep width – Type A ± 10 or Type B ± 6 or ± 9.5 as per system, Adjust IF to -3 F = 200 KHz rms, BF= 250 MHz

Y1= IF Amp 1.87dB P-P,

Y2 = Delay 16.1 nanosec. P-P

- Sent 200 KHz deviation, Sweep ± 10 or ± 6 MHz, 70 MHz and 250 KHz BF, -3.0 dBm from MLA Transmitter at IF in
- Distance station will receive on display.
- When IF is through Sweep shows 0.00MHz. Adjust AGC and MGC conditions for -3 dBm and then from MSA generator.

4] BER measurement:-

- Ask distant station loop on 140 Mb or STM-1 which is installed.
- Carry out BER Test as usual for 0 and $\pm 15/20$ PPM.
- Take out printout for each channel/PPM ,
- Limit: - 1×10^{-11}

5] Jitter measurement :- (as mentioned in OFC systems Pl)

Carry out I/P Jitter test for both Main and Protection channels for the following frequencies: - 200 Hz, 500 Hz, 10 KHz, 3500 KHz, and note down the results in UIPP.

O/P Jitter: - Select Filters as HP-1+LP & HP-2 +LP.

For Limits pl see the table.

6] AIS measurement:-

Measure AIS frequency by frequency counter when there is no data input at other end. Limit: - ± 15 or 20 PPM

7] BER performance at different Receive RF level:-

Arrange Microwave variable attenuator; connect it in RF Receive path. Check BER performance at various levels e.g. -40, -65, -70, -75 dBm at 0 PPM, note down the ber along with AGC voltage in each case.

8] Check of ORDER WIRE:-

Feed -3.5 dBm tone at various frequencies in O/W Tx pin point and measure at O/W Rx in point at other station , check O/W response over 0.3 KHz to 3.5 KHz
Limit :- ± 2 dBm.

- Measure idle channel noise ,
- Check O/W availability of O/W in the absence of data ,
- Check O/W for signaling and speech by dialing all stations order wire nos.

9] Protection Switching: - Protection switching may be carried out as per test schedule under various conditions.

10] Monitoring with BITE: - If Hand held terminal (BITE) is provided with system then Tx , Rx power and other 10 to 12 parameters are to be checked as per sheet.

11] Remote Supervision on PC, in service monitoring :- Trans , Receive power , Alarms like RF IF , DEMOD, X-PIC Tx power are to be monitored with PC.

12] Way side dropping test: - Arrange 2 Mb loops from distant station and check BER for 0 and ± 50 PPM. The result should be no Error.

7-3 Microwave constituents

7-3.1 1. Antenna: - It is a metallic device which transmits and receives Radio signals in the form of electromagnetic waves. Antenna used for the transmission of Radio, TV, M/W, GSM and CDMA network.

There are two types of antennas. 1. Omni directional (radiates equally in all direction)

It is a simple rod.

2. Directional (radiates in one direction only)

- Yagi : - Directional antenna of array of dipoles.

- Parabolic: - It is made up of 2 to 4 meter diameter

and its components are Reflector, Feed, Support (Tie beam)

$$\text{Antenna gain: } - = \frac{4 \Pi A \text{ (equivalent area of antenna.)}}{\Lambda^2 \text{ (Wavelength)}} \quad \text{Or} \quad \frac{4\pi \text{ (frequency)} A \text{ (area)}}{2}$$

- If size of antenna is reduced, gain is reduced.

- If frequency is increased, gain increased.

- Size of antenna depends upon operating frequency, Atmospheric losses and Rain losses.

Antenna Gain as per the system and diameter:-

2.0 – 2.3 GHz 0.6 M dia 19.6 dB

1.2 M dia 25.6 dB

1.8 M dia 28.9 dB

12.75 – 13.25 GHz 1.2 M dia 41.7 dB

1.8 M dia 45.1 dB

Diameter	2 G	6G	7 G	11 G
1.8 M	29	38.3	39.2	43.8 dB
2.4 M	31.5	40.2	41.2	46.2 dB
3.0 M	33.4	43.0	45.0	48.1 dB
3.7 M	35.0	44.8	46.4	49.6 dB

2. Wave-guide Pressurization and dehydration:-

It is to be done to avoid moisture, dirt, and corrosive gasses. W/G are to be filled by gas and it is to be properly sealed. Pressure may go down for any leakage. The machine to generate this slight pressure is called Dehydrator. Sometime high pressure is also required for sealing against leaks. One of such dehydrator is from High Tech Pneumatics Dehydrator. LEDs are provided on front panel such as,

- Compressor ON,
- Low power,
- Overload ,
- Alarm, and
- Pressure and Humidity indicators.

Maximum operating Pressure: - 0.25 Kg / cm²

Minimum -----'----- :- 0.10 Kg / cm²

Low pressure alarm :- 0.08 Kg / cm²

Pressure should hold for 12 Hours.

7-3.2 3. Link Budget:-

Link budget is to calculate particular M/W system Receive level taking into consideration all gains and losses in the network. It accounts attenuation of transmitted signal due to propagation.

Formula: - $P_t + G_t + G_r - L - FL - Br$ Where

P_t - A Transmitter power.

$G_t + G_r$ - Antenna gain in both directions.

L - Free space loss.

FL - Feeder cable loss in both directions.

Br - Branching filter loss at both end.

This Receive power to be calculated for RF IN or Rx IN and not for at antenna port.

e.g. Free space loss	=	$20 \log FD + 92.4 = 144.60$	dB
Branching filter loss	=	5.60	dB
Feeder loss	=	7.52	dB (4.70 dB / 100 Meter.)
Total loss	=	157.72	dB
Antenna gain	=	45.60×2	91.20 dB
Trans power	=	30.0	dBm
Total gain	=	121.20	dB
Calculated Receive level	=	- 36.52	dBm

4. Wave guide: - It is a hollow copper corrugated with thick blanket in different shape for carrying electromagnetic waves. It provides most efficient path for electrical energy at higher frequencies. It is guided electrical energy to flow just like a water pipe.

Three types of waveguides: -

1. Rectangular
2. Circular
3. Elliptical

Rectangular and circular waveguides are rigid and elliptical waveguide is flexible.

Rectangular wave guide: -		Loss
4 GHz	WR229	0.85/100ft
6 GHz	WR137	2.0/100 ft
	WR159	1.4/100 ft
7-8 GHz	WR112	2.7/100 ft
11 GHz	WR90	3.5/100 ft
13 GHz	WR75	4.5/100 ft

Used where Critical application and low VSWR is required.

Circular wave guide: - Lowest loss, Support to orthogonal polarization.

Loss:- 4 GHz	1.5 dBm /100 M
6 GHz	1.9 dBm /100 M
11GHz	1.8 dBm /100 M

3. Elliptical W/G	RF Band	Type	Loss/Meter
	6.425-7.125 GHz	CWSP 7L	0.046 dB
	7.725-8.275 GHz	CWSP 8M	0.060 dB
	10.7-11.7 GHz	CWSP 8M	0.090 dB

7-3.3

5. Fresnel zone: -

No. of concentric ellipsoid revolutions which defines volumes in radiation pattern of circular aperture and it is due to diffraction by circular aperture

The first zone is circular; sub second zones are annular in cross section and concentric with first.

This zone concept is used to analyze interference by obstacle near the path of radio beam.

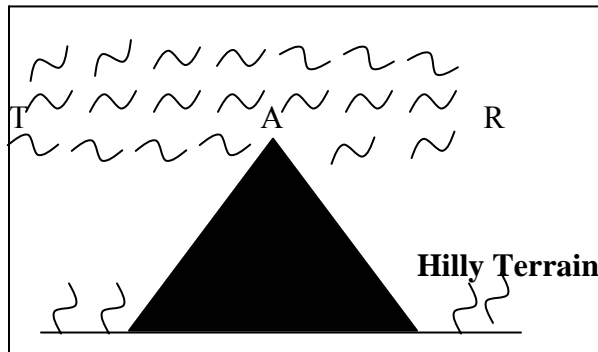

TR – Direct path and TAR –
Secondary transmission path
by reflection of M/W energy from A.

6. Fading: - It is a distortion in micro media and introduces errors in radio system

There are two types of fading: -

1. Slow (shadow) fading: - It is on large scale due to movements of mobile or obstruction within propagation environment.
2. Fast fading/ Multipath fading / Slow fading: - It is due to multipath propagation by superimposition of transmitted signal that have experiences due to diffraction, in attenuation, delay and phase shift while traveling from the source to receiver. This is by attenuation of single signal. It refers to the time variation of received signal caused by changes in transmission media. It occurs with small movement of mobile obstacle.

Remedy: - Diversity through multiple antenna.

Fade Margin: - There should be sufficient margin or sensitivity to accommodate expected fading to achieve the requisite system quality. It is margin by which Rx level may be reduced without causing system performance to fall below a specific value.

e.g. let Rx level -40 dBm and system will continue to work till -80 dBm. It means fade margin is 40 dB

7. X- PIC: - Cross polarization interference cancellers: -

Frequency reuse technique is adopted in micro system due to limited frequency spectrum a microwave signal is transmitted to both vertical and horizontal feeds and are coupled, in the antenna. These two vertical and horizontal polarized signals can cause the interference due to cross polarization, due to rain or hydrometers which is called cross polarization interference the reasons are rain, hydro, multipath propagation, antenna characteristics the cross pick use to cancel the effect of XPD of both signal in received direction

E.g. now station A transmit power on M1 channel measure at station B on receive of M1 channel.

Now let M2 channel transmit the power, measure receive power at station B of M1 channel again so

XPD will be difference of these two readings.

XPD: - Both received signals are decoupled by XPD of antenna at the receiving end.

7-3.4 8. Rain attenuation: - As the water droplets scatters and absorbs radiation the effect of rain goes on increasing with the increase of frequencies i.e. it is more in 13 GHz system compared to 4 and 6 GHz

Formula $A \text{ (dB)} = 0.0308 f - 0.1872R$, R - Rain rate at that location = -----

Where f = operating frequency within 10-15 GHz

This rain attenuation can be reduced by interconnecting two stations separated by distance greater than likely size of rain cell i.e. by space diversity.

9, Diversity: - If channel is affected by fading then second channel will take load here in 1+1 configuration, Parallel system is provided so that two systems can carry the same traffic, called equipment/ frequency diversity. As it is required two sets of equipment/ frequencies, cost of the equipment is more. Signal is spread out over a large frequency band width.

Types of diversity: -

1. Time diversity: - Multiple version of the same signal are transmitted at different time instance which is useful for forward error correction.

2. Frequency diversity: - A parallel system is provided 1+1 so that both systems should carry the same traffic. It requires two sets of frequencies. This method is providing both equipment as well as frequency diversity so it is expensive. This technique a high order of reliability as fading is least likely to affect both frequencies.

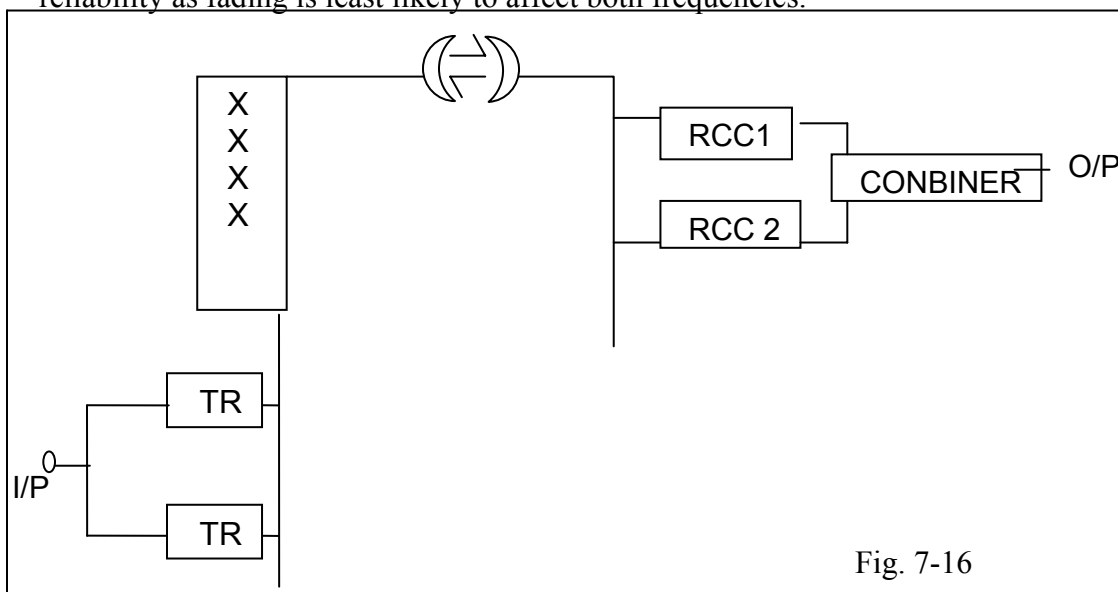

3. Space diversity: - It is applicable in W/B system for larger hops. Each site is provided with two Antennas. Main antenna at station A transmits signals of all frequencies, at station B signal received by both antennas main and space diversity which will detect the signal with lowest path loss between two sites.

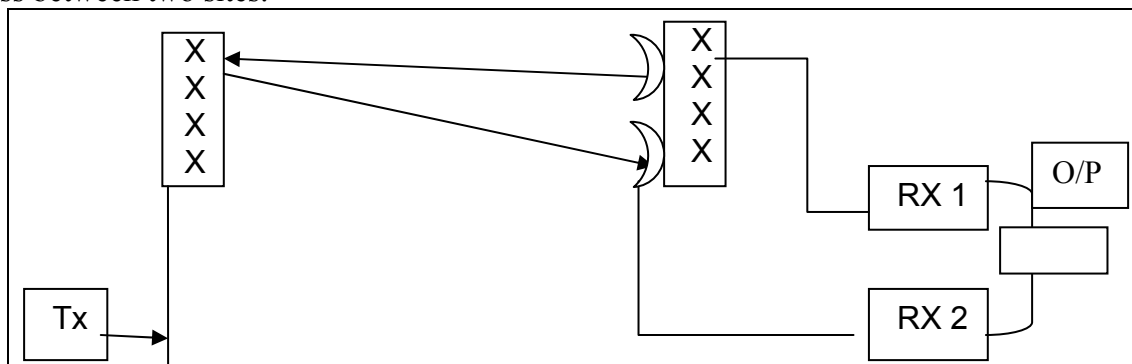

Antenna diversity: - In this diversity scheme microwave signals are transmitted along with different propagation path with the help of second antenna at receiving end to improve received performance.

7-3.5

10. Hot stand by: -

If main equipment fails automatic switch over takes place on a stand by equipment set i.e. a complete set of parallel equipment is switched in almost instantaneously on failure of operating equipment. This is also called a equipment diversity. It requires only one set of frequency for frequency for a particular route. Here there is no frequency diversity so one band of frequency is saved. In this Configuration system is 1+1 on 6+1 i.e. 1 or 6 main channel and one is protection channel.

11. Hitless switching [Error less switching]:-

This is carried out at base band stage only for fading condition and manual switching is for maintenance purpose. Protection switching is inhibited at receive side and change over taken place when,

1. BER > 10
2. Frame Synch loss when BER > 10⁻³
3. CMI O/P to Mux is lost

Here Priority is 3 > 2 > 1

Process:-

- Fault in regular channel detected at receiving end.
- Faulty channel switching control is transmitted from received end to transmitted end.
- Transmitted end switch control disconnect radio pilot signal from the protection channel and transmit the I/C regular and Prot. channel is detected.
- Hitless switching for regular to protection channel takes place.

12. Free Space loss: -

It is the loss between two similar antennas in free Space where there is no ground interference, obstruction.

Free space loss = 32.45 + 20 log D + 20 log F

Where D = Distance in Km

F = Frequency in MHz or

Free loss = 20 Log FD + 92.4

Loss of signal strength due to absorbing, diffracting, obstructing, Refracting, Scattering and reflecting when two Antennas are in free space without connector, Cable loss.

13. Wayside dropping: - If any small station in any hop requires 2 MB stream, an additional card is provided in system so as to handle the traffic of small station along with main M/W system.

14. IF DADE: - Differential Absolute Delay Equalizer.

It is to adjust the phase difference between signals received through main and space diversity antenna. This phase difference causes loss of bits. DADE cable is used and it is placed between IF out and RX2 IN. It contains a delay cable of length L to compensate the delay time difference between main and Receiver and space diversity receiver.

15. ATPC: - Automatic Trans Power Control.

ATPC facility was introduced first time by BOSCH in 6 GHz M/W system. It is available in order to reduce interference from neighboring system this can be achieved by strapping in conf. management facility in craft terminal. There are three types of settings, Auto, Tran's power high and Low. ATPC threshold also can be set to -40, -50, or -60. Receive power can be adjusted to -33 to -50 dBm by adjusting Trans power at distant end. This is achieved by some strapping in MOD unit. e.g. for ATPC ON strap between 8 to 9 and ATPC OFF strap between 10 to 8 .

16. Signature Test :- (M curve test) See Fig. 7-18 for Curve

This test is to see how much notch depth can be tolerated for 10^{-3} rate. For this test Fade simulator is required.

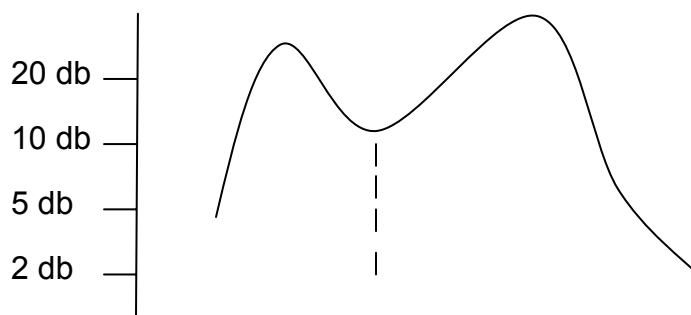

Fig. 7-18

7-4 2 GHz / 8 MB D/ UHF System A/T
Make: - ARM-2208-M3

7-4.1 Specification: -

- Frequency band 2.0 to 2.3 GHz.
- Bit Rate 8.448 MHz 75 Ω.
- Tx- Rx Spacing 161 MHz.
- RF Tx: +30 to +32 dBm at antenna port.
- Receive IF frequency 70 MHz.
- Transmitter PA out +34 dBm max.
- AGC dynamic range 45 dBm for threshold.
- Ref Rec. I/P level -42 dBm ± 1 dBm.
- Overload of LNA -35 dBm or better.
- Receive Threshold for BER of 1×10^{-3} -86 dBm at Rx In.
- O/W response ± 2 dBm.
- Noise level -53 dBm.

7-4.2 Before starting Local A/T,

- Ensure availability of M/W testing meters.
- Ask for purchase order/ allotment letter of the system.
- Get Q/A report /stamp.
- Ask for survey report and check surveyed level and nominal level, the deviation should not be more than ± 3 dBm.
- Mostly towers are existing but whether Tower is A/Td or not? Insist for Tower clearance letter.
- Mostly SACFA is not applied or registered for clearance, Please note down registration no.
- Carry out physical inspection of equipment installation, W/G up to the bay and vertical runway above the bay for power cable is provided or not? And W/G is properly earthed or not?
- Also take care regarding Air conditioning, Fire detector/ Extinguisher, Sufficient illumination Light etc.
- Carry out earth resistance test of Equipment, tower and if it is not checked within 6 months.

Make: - ARM Sub- Rack.New-7-19 & 20

P/S-1	P/S-2	Trans receiver	Diplexer	Trans Receiver	MUX	O/W
+ 12.8					0 T	+ SUPY
0		TLO In		TLO In	0 R	
+12.8					0	
0		Mon		Mon	0	
0					0	
- 48					0	
					0	

Fig. 7-19

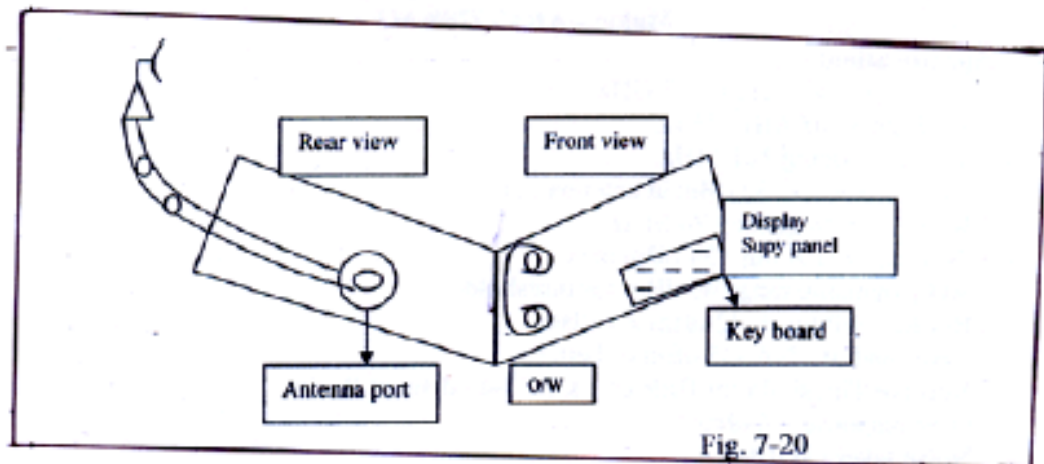

Fig. 7-20

N.B:- Source of limits :- from ARM Manual.

7-4.3 Local A/T: -

1. Check of power supply: -

- Carry out voltage drop test as usual limit 1.0 V.
- Measure -48 V and +12.8 V on front panel of PS1 and PS2.

2. Test on Transmitter: -

- Note down TLO frequency: - for Ex. 2223.5 MHz.
- Measure TLO frequency on TLO MON socket.
- Deviation should be within ± 20 PPM (Here TLO and RF Tx frequency is same)
- Measure Trans power at Tx out on Trans Receive module by connecting M/W Power meter with Sensor and 30 dB pad and that to after calibration only by cal O/P. Put ON Main transmitter.
- Note O/P power of both channels i.e. Main and Protection.
- Limit: - +34 dBm (Maximum)
- Measure Trans power at antenna port (Rear side) Limit: - +30 dBm to +32 dBm.
- Calculate Branching filler loss, Limit: - 2 to 4 dB

3. Test on Receiver: -

- Note down RLO frequency:- e.g. 2132.5 MHz (RF Rx 2062.5 + IF 70 MHz)
- Measure RLO frequency at RLO Mon.

Dynamic range/ AGC Calibration:-Make connections as shown in the following diagram no.7-21

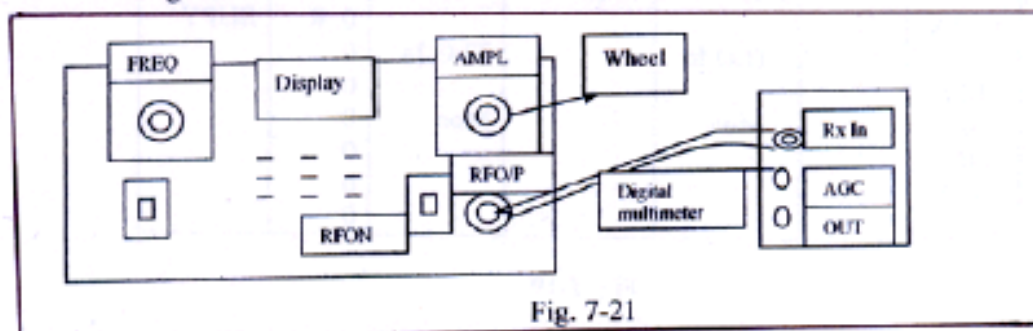

Fig. 7-21

- Disconnect RF cable from Rx In.
- Make a test set up as above for AGC calibration.
- Select RF frequency and level say -40 dBm and calibrate it for the correct O/P level.
- Put ON RF O/P and monitor AGC voltage.
- Note down AGC voltage up to -75 dBm in steps of -10 dBm and there after in 5 dBm steps when E⁻³ LED lights.
- Reading will be -86 to -89 dBm.
- Limit is -86 dBm at Rx IN.
- This will be a squelch point,
- Though -35 dBm is an overload point but do not take risk to reach at -35 dBm just to avoid damage of receiver.
- Go back to restore the E⁻³ LED to monitor hysteresis point.
- Repeat test for protection channel.

4. Check of alarms: -

Verify the following alarm by simulating the conditions.

- a. Rx select
- b. Tx select
- c. Tx power low
- d. E⁻⁶ ⓄAGC voltage
- e. E⁻³ ⓄGround
- f. Data unlock
- g. RLO unlock
- h. Data fail
- i. RF fail
- j. Synch. fail
- k. BER LED O.K
- l. Alarm in BITE O.K
- m. AIS

5. Bay Meter readings: -

- AGC voltage for both channels.
- P/S checks -48 and +12.8 V.
- BER E⁻³ and E⁻⁶.

6. Check of Mux Equipment :-

- There are four 2 Mb tributaries.
- Loop IF Out to IF In.
- Connect DTA set TX and Rx to 1st Trbs TX and Rx on DDF.
- Observe loop OK and monitor for 5 minutes for 0 and ±50 PPM.
- Repeat BER test for other 3 Trbs also.

Please note that after Local A/T is over write Punch points to the installer and proceed for Through A/T only when all points have been attended by the installer.

7-4.4 HOP/ through A/T

1. Receive level: -
 - Measure RF Rx level at Rx IN and compare it with surveyed level.
 - Deviation between surveyed and measured level should be within ± 1 dBm. (Ref: - DOT ML sector 7 GHz/ 34 Mb)
2. BER test: - Ask distant station to loop all four tributaries and check BER on all four Trbs for 0 and ± 50 PPM for 5 minutes each.
Limit: - $0.00 E^{-10}$, No Error.
3. Check of switching operation: -
 - Take loop on one tributary from distant station.
 - Connect DTA to 1st tributary and monitor loop getting O.K.
 - Now put OFF main transmitter channel.
 - Observe that loop getting still OK, It means that data has been switched to protection channel.
 - Same observe by making receiver off.
 - Repeat test vice versa and ask other end to observe protection switching.
4. O/W function: -
 - O/W response: - Feed 0.3 to 3.4 KHz tone at 0 level and measure at Rx pts of O/W at the other end.
 - Limit: -10 dB \pm 1 dBm / \pm 2 dB for 1 KHz
 - Measure noise performance -53 dBmop.
 - Check O/W for speech and signally O.K or not O.K.
5. BITE Monitoring: -

The following observations can be red on supervisory channel by operating mode parameter keys Local/ Remote etc on supervisory channel on front of sub rack.

 - AIS status enables.
 - Buzzer O.K
 - BER is zero.
 - terminal status: - Tx-1 O.K Tx-2 O.K
 - PS₁ +12.8 and PS₂: - +12.8
 - Equipment status O.K
 - Transmission status: - O.K
 - Tran's selection TXA- Auto.
 - HDB-3 I/P O.K
 - Tx frequency 2.0625 GHz
 - Tx power A : - +33 dBm B: - +33 dBm
 - Receive status: - O.K, O.K.
 - Rx Selection: Rx Auto.
 - RF level: - -46 to -55 dBm A
-46 to -55 dBm B
 - Rx synch A: - O.K B:- O.K
 - Rx Synthesizer lock.
 - Rx frequency 2.2235 GHz.
 - Rx path O.K, O.K
 - User alarm US1, US2 – OFF

- Tele command status TC1, TC2 OFF.
- 6. BITE Alarms: -
 - Eqpt fail: - Any Eqpt failure.
 - System fail: - Any System failure.
 - Microprocessor fail: - When processor in supervisory card out.
 - OB call tone busy: - When Bus call is sent
 - EOW: - When O/W call is in progress.
- 7. Alarms: - Monitor following various alarm on Transmitter.
 - Data fail T/R unit when I/P HDB3 data failure.
 - RF fails in BITE. When power <+30 dBm.
 - TLO unlock when synthesizer goes out

Receiver

 - RLO unlock in BITE/ front panel synthesizer goes 0/0 lock.
 - Synch fail in BITE when synch is not recovered.
 - BER LED in BITE BER worst than E^{-3} .
- 8. Check all Tower A/T points as per test schedule along with Earth measurement.
- 9. Stability: - Put ON stability for 24 Hours by arranging loop from other station.

Limit: -	% ES	0.18
	% SES	0.003 revised 0.00045
	% DM	0.045

7-4.5 Components of System in brief:-

- Feeder cable: - Coaxial Feeder.
- Cable LCF, 7/8 coaxial Cu 50 Ω.
- Inner Cu tube 9.1 mm.
- Dielectric foam : - P.E 22.0mm
Outer conductor 24.9mm
- Jacket: - polythene black 28.9 mm
- Attenuation 6.5 dB/ 100 m
- Antenna
- 2.4 meter diameter.
- Grid parabolic.

Free Manuals Download Website

<http://myh66.com>

<http://usermanuals.us>

<http://www.somanuals.com>

<http://www.4manuals.cc>

<http://www.manual-lib.com>

<http://www.404manual.com>

<http://www.luxmanual.com>

<http://aubethermostatmanual.com>

Golf course search by state

<http://golfingnear.com>

Email search by domain

<http://emailbydomain.com>

Auto manuals search

<http://auto.somanuals.com>

TV manuals search

<http://tv.somanuals.com>