

Portable CD Player



AX 1100
AX 1101



Let's make things better.



PHILIPS

Portable CD Player

English

Français

Español

Deutsch

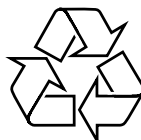

Meet Philips at the Internet
<http://www.philips.com>

**CLASS 1
LASER PRODUCT**

AX1100
AX1101

Printed in China

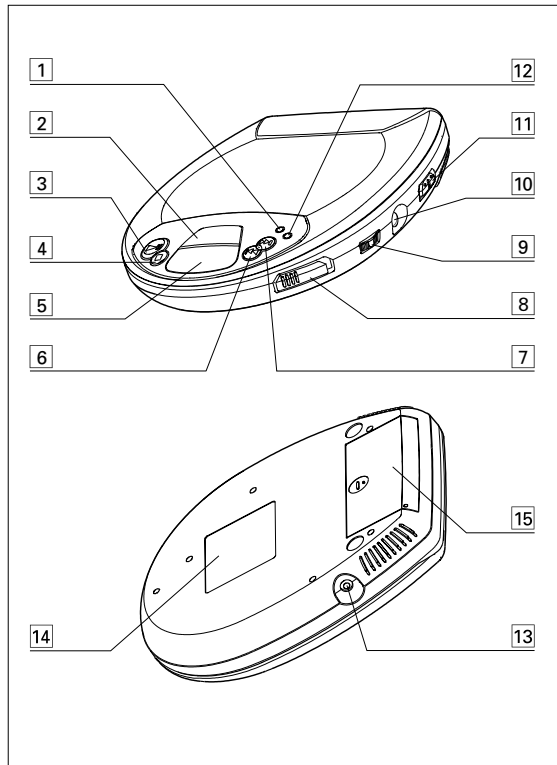

QUICK START

MISE EN SERVICE RAPIDE

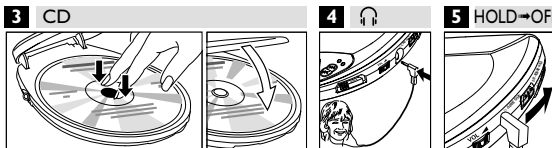
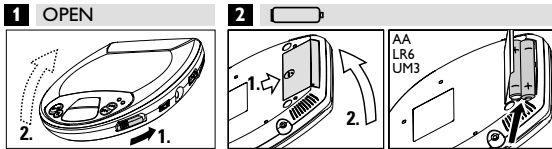

English

CONTROLS

- 1 MODEselects the different playing possibilities: **SHUFFLE**, **SHUFFLE REPEAT ALL**, **REPEAT** and **REPEAT ALL**
- 2 BASS.....switches the bass enhancement on and off. This button also switches acoustic feedback (the beep) on/off when it is pressed for more than 2 seconds
- 3 ►||switches the player on, starts or pauses CD play
- 4 ■stops CD play, clears a program or switches the player off
- 5display
- 6 ◀◀skips and searches CD tracks backwards
- 7 ▶▶skips and searches CD tracks forwards
- 8 OPEN ►opens the CD lid
- 9 VOL ◀adjusts the volume
- 10 ☎/LINE OUT.....3.5 mm headphone socket, socket to connect the player to another audio input of an additional appliance
- 11 OFF.....switches RESUME and HOLD off
RESUMEstores the last position of a CD track played
HOLD.....locks all buttons
- 12 PROGRAMprograms tracks and reviews the program
- 13 4.5V DC.....socket for external power supply
- 14typeplate
- 15battery compartment

CD PLAYER AND CD HANDLING

- Do not touch the lens (A) of the CD player.
- Do not expose the unit, batteries or CDs to humidity, rain, sand or excessive heat (caused by heating equipment or direct sunlight).
- You can clean the CD player with a soft, slightly dampened, lint-free cloth. Do not use any cleaning agents as they may have a corrosive effect.
- To clean the CD, wipe it in a straight line from the center toward the edge using a soft, lint-free cloth. A cleaning agent may damage the disc! Never write on a CD or attach a sticker to it.
- The lens may cloud over when the unit is moved suddenly from cold to warm surroundings. Playing a CD is not possible then. Leave the CD player in a warm environment until the moisture has evaporated.
- Active mobile phones in the vicinity of the CD player may cause malfunctions.
- Avoid dropping the unit as this may cause damage.

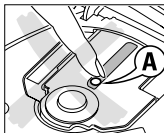

ENVIRONMENTAL INFORMATION

- All redundant packing material has been omitted. We have done our best to make the packaging easily separable into two materials: cardboard and polyethylene.
- Your unit consists of materials which can be recycled if disassembled by a specialized company. Please observe the local regulations regarding the disposal of packing materials, exhausted batteries and old equipment.

CAUTION

Use of controls or adjustments or performance of procedures other than herein may result in hazardous radiation exposure.

BATTERIES (supplied or optionally available)

You can use the following batteries with this CD-player:

- normal batteries type **LR6**, **UM3** or **AA** (preferably Philips), or
- alkaline batteries type **LR6**, **UM3** or **AA** (preferably Philips).

Note: – Old and new or different types of batteries should not be used in combination. Remove batteries if they are empty or if the player is not going to be used for a long time.

Inserting batteries

- Open the battery compartment and insert either 2 normal or alkaline batteries.

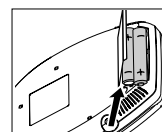

Battery indication

The approximate power level of your batteries is shown in the display.

- If  is shown or flashing (depending on the version) and $\text{b} \text{A} \text{E} \text{E} \text{E}$ is displayed, the batteries are empty.



Average playing time of batteries under normal conditions

Battery type	Playing time
Normal	7 hours
Alkaline	20 hours

Batteries contain chemical substances, so they should be disposed of properly.

POWER ADAPTER (supplied or optionally available)

Use only the AY 3170 adapter (4.5 V/300 mA direct current, positive pole to the centre pin). Any other product may damage the player.

- 1 Make sure that the adapter's voltage corresponds to the local voltage.
- 2 Connect the adapter to the 4.5V DC socket of the player and to the wall socket.

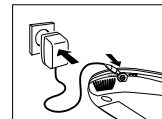

Note: Always disconnect the adapter when you are not using it.

HEADPHONES HE 035

- Connect the supplied headphones to the ☎/LINE OUT socket of the player.

Note: ☎/LINE OUT can also be used for connecting the player to your HiFi system (with a signal lead) or to your car radio (with a cassette adapter or signal lead). In both cases, the volume of the player must be set to position 8.

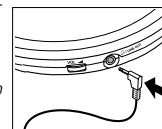

IMPORTANT!

Hearing safety: Do not play your headphones at a high volume. Hearing experts advise that continuous use at high volume can permanently damage your hearing.
Traffic safety: Do not use headphones while driving a vehicle. It may create a hazard and it is illegal in many countries. Even if your headphones are an open-air type designed to let you hear outside sounds, do not turn up the volume so high that you cannot hear what is going on around you.

PLAYING A CD

This CD player can play all kinds of **Audio Discs** such as CD-Recordables and CD-Rewritables. Do not try to play a CD-ROM, CDi, VCD, DVD or computer CD.

1 Push OPEN ► to open the CD compartment lid.

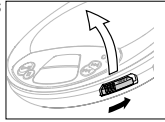

2 Insert an audio CD, printed side up, by pressing the CD center onto the hub.



3 Close the player by pressing the lid down.

4 Press ►II to switch the player on and start CD playback.

→ The current track number and the elapsed playing time are displayed.



- You can pause playback by pressing ►II.
- The time where playback was paused will flash.
- You can continue playback by pressing ►II again.

5 Press ■ to stop playback.

→ The total number of tracks and the total playing time of the CD are displayed.



6 Press ■ again to switch off the player.

- To remove the CD, hold it by its edge and press the hub gently while lifting the CD.

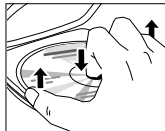

Note: If there is no activity, the unit will automatically switch off after a while to save energy.

PLAYBACK INFORMATION

- If a CD-Recordable (CD-R) or a CD-Rewritable (CD-RW) is not recorded properly, **RF 15%** is displayed. In that case, use FINALIZE on your CD-recorder to complete the recording.
- If you want to play a CD-Rewritable (CD-RW), it takes 3–15 seconds for sound reproduction to start once you have pressed ►II.
- Playback will stop if you open the CD lid.
- While the CD is being read, **---** flashes in the display.

VOLUME AND BASS

Volume adjustment

Adjust the volume by using VOL ◀.

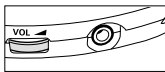

Bass adjustment

- Press BASS to switch the bass enhancement on or off.
- **DBB** is shown if the bass enhancement is activated.

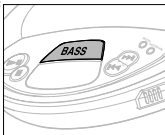

This product complies with the radio interference requirements of the European Union.

Both the model number and production number are located on the bottom of the set.

SELECTING A TRACK AND SEARCHING

Selecting a track during playback

- Briefly press ◀◀ or ▶▶ once or several times to skip to the beginning of the current, previous or next track.
- Playback continues with the selected track, and its number is displayed.

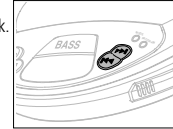

Selecting a track when playback is stopped

- Briefly press ◀◀ or ▶▶ once or several times.
- The selected track number is displayed.
- Press ►II to start CD play.
- Playback starts with the selected track.

Searching for a passage during playback

- Keep ◀◀ or ▶▶ pressed to find a particular passage in a backward or forward direction.
- Searching is started and playback continues at low volume. After 2 seconds the search speed increases.
- Release the button when you reach the desired passage.
- Normal playback continues from this position.

Notes: – During SHUFFLE, SHUFFLE REPEAT ALL, REPEAT or while playing a program, searching is only possible within the particular track.

PROGRAMMING TRACK NUMBERS

You can select up to 15 tracks to play in a program. A single track may be played more than once in the program.

- While playback is stopped, select a track with ◀◀ or ▶▶.
- Press PROGRAM to store the track.
- **PROGRAM** lights; the track number programmed and **P**, with the total number of stored tracks, are displayed.
- Select and store all desired tracks in this way.
- Press ►II to start playback of your selected tracks.
- **PROGRAM** is shown and playback starts.
- You can review the program by pressing PROGRAM for more than 2 seconds.
- The display shows all stored tracks in sequence.



Notes: – If you press PROGRAM and no track is selected, SELE is displayed.
– If you try to store more than 15 tracks, FULL is displayed.

Clearing the program

- While playback is stopped, press ■ to clear program.
- **CLEAR** is displayed once, **PROGRAM** disappears, and the program is cleared.



Notes: – The program also will be cleared if you
– interrupt the power supply, or
– open the CD compartment lid, or
– if the unit switches off automatically.

MODE

It is possible to play tracks in random order, to repeat a single track or the entire CD.

1 Press MODE during playback as often as required in order to activate one of the following 'modes'. The active mode is shown in the display.

- **SHUFFLE**: All tracks of the CD are played in random order until all of them have been played once.
- **SHUFFLE REPEAT ALL**: All tracks of the CD are played repeatedly in random order.
- **REPEAT**: The current track is played repeatedly.
- **REPEAT ALL**: The entire CD is played repeatedly.

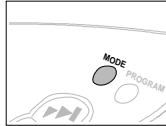

2 Playback starts in the chosen mode after 2 seconds.
• To return to normal playback, press MODE repeatedly until the display shows no active modes.

TROUBLESHOOTING

If a fault occurs, first check the points listed below before taking the set for repair. If you are unable to remedy a problem by following these hints, consult your dealer or service centre.

WARNING: Under no circumstances should you try to repair the set yourself, as this will invalidate the guarantee. Do not open the set as there is a risk of electric shock!

No power, playback does not start

Batteries

- Batteries inserted incorrectly
- Insert the batteries correctly
- Batteries are empty
- Change the batteries
- Contact pins are dirty
- Clean them with a cloth

Mains adapter

- Loose connection
- Connect the adapter securely

no d . 5 L indication

- The CD is badly scratched or dirty
- Replace or clean the CD
- CD is not or incorrectly inserted
- Insert a CD, label upwards
- The laser lens is steamed up
- Wait until the lens has cleared

RESUME

You can interrupt playback and continue (even after an extended period of time) from the position where playback stopped (RESUME) and you can lock all buttons of the set so that no action will be executed (HOLD). Use the RESUME–HOLD–OFF slider for these functions.

1 Switch the slider to RESUME during playback to activate RESUME.

- RESUME is shown.

2 Press ■ whenever you want to stop playback.

3 Press ►|| whenever you want to resume playback.

- RESUME is shown and playback continues from where you have stopped last.

• To deactivate RESUME, switch the slider to OFF.

- RESUME goes off.

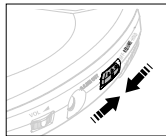

HOLD

You can lock the buttons of the set by switching the slider to HOLD. Now, when a key is pressed, no action will be executed. This is of use, for example, when transporting the player in a bag. With HOLD activated, you can avoid accidental activation of other functions.

1 Switch the slider to HOLD to activate HOLD.

- All buttons are locked. *H o l d* is shown when you press any button. If the set is switched off, *H o l d* will be shown only when ►|| is pressed.

2 To deactivate HOLD, switch the slider to OFF.

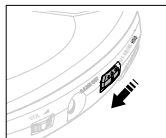

Note: If you deactivate HOLD by switching the slider to RESUME, you will be activating the RESUME function.

no d . 5 L indication

- CD-RW (CD-R) is not recorded
- Use FINALIZE on the properly CD recorder to complete the recording

H o l d indication and/or no reaction to controls

- HOLD is activated
- Deactivate HOLD
- Electrostatic discharge
- Disconnect the set from power supply or take out the batteries for a few seconds

The CD skips tracks

- The CD is damaged or dirty
- Replace or clean the CD
- RESUME, SHUFFLE or PROGRAM is active
- Switch RESUME, SHUFFLE or PROGRAM off

No sound or bad sound quality

- PAUSE is activated
- Press ►||
- Loose, wrong or dirty connections
- Check and clean connections
- Volume is not adjusted
- Adjust the volume
- Malfunctions due to nearness of active mobile phones
- Keep the player away from active mobile phones
- Strong magnetic fields near the player
- Change the player's position or connections

Free Manuals Download Website

<http://myh66.com>

<http://usermanuals.us>

<http://www.somanuals.com>

<http://www.4manuals.cc>

<http://www.manual-lib.com>

<http://www.404manual.com>

<http://www.luxmanual.com>

<http://aubethermostatmanual.com>

Golf course search by state

<http://golfingnear.com>

Email search by domain

<http://emailbydomain.com>

Auto manuals search

<http://auto.somanuals.com>

TV manuals search

<http://tv.somanuals.com>