

Portable CD Player

AX2400
AX2401
AX2420

user manual
manuel d'utilisation
manual del usuario
Manual do usuário



PHILIPS

Meet Philips at the Internet
<http://www.philips.com>

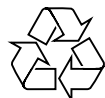

AX2400, AX2401, AX2420

**CLASS 1
LASER PRODUCT**

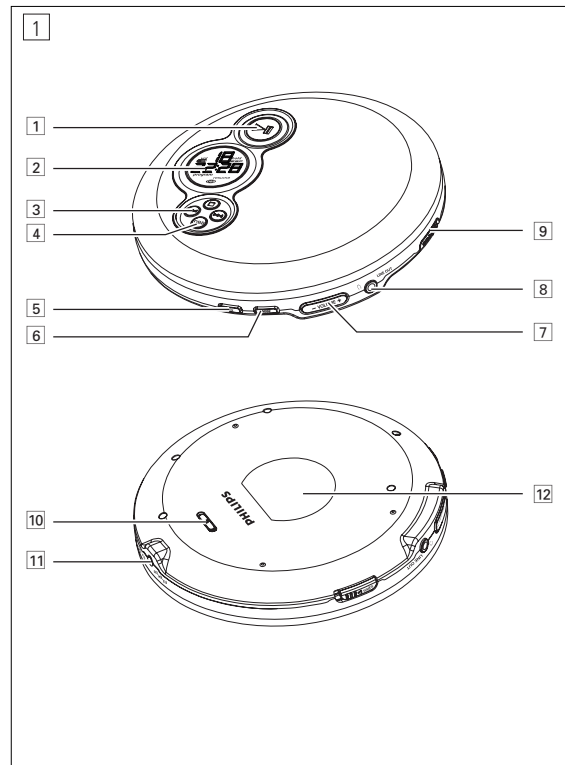

QUICK START

MISE EN SERVICE RAPIDE

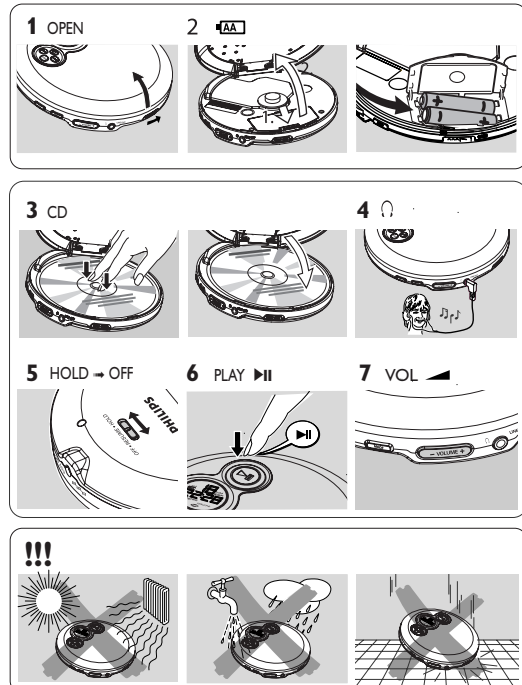

English

CONTROLS / POWER SUPPLY

POWER SUPPLY / GENERAL INFORMATION

CONTROLS (see figure 1)

- 1 **▶||**switches the player on, starts or pauses CD play
- 2display
- 3 **■**stops CD play, clears a program or switches the player off
 - ◀◀skips and searches CD tracks backwards
 - ▶▶skips and searches CD tracks forwards
- 4 **DBB**switches the bass enhancement on and off. This button also switches acoustic feedback (the beep) on/off when it is pressed for more than 2 seconds
- 5 **PROG**programs tracks and reviews the program
- 6 **MODE/ESP**selects the different playing possibilities: **SHUFFLE**, **SHUFFLE REPEAT ALL**, **REPEAT**, **REPEAT ALL** and **5 C R R**, switch ESP on/off
- 7 **VOLUME +/-**adjust the volume
- 8 **🔌/LINE OUT**3.5 mm headphone socket, socket to connect the player to another audio input of an additional appliance.
- 9 **OPEN ▲**opens the CD lid
- 10 **HOLD**locks all buttons
 - RESUME**stores the last position of a CD track played
 - OFF**switches RESUME and HOLD off
- 11 **4.5V DC**socket for external power supply
- 12type plate

Mains adapter (supplied or optionally available)

Use only the AY 3162 adapter (4.5 V / 300 mA direct current, positive pole to the center pin). Any other product may damage the player.

- 1 Make sure the local voltage corresponds to the power adapter's voltage.
- 2 Connect the power adapter to the 4.5V DC socket of the player and to the wall socket.

Note: Always disconnect the adapter when you are not using it.

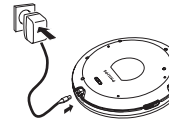

Environmental information

- All redundant packing material has been omitted. We have done our utmost to make the packaging easily separable into two materials: cardboard (box) and polyethylene (bags, protective foam sheet).
- Your set consists of materials which can be recycled if disassembled by a specialized company. Please observe the local regulations regarding the disposal of packing materials, exhausted batteries and old equipment.

Batteries (supplied or optionally available)

You can use the following batteries with this CD-player:

- normal batteries type **LR6**, **UM3** or **AA** (preferably Philips), or
- alkaline batteries type **LR6**, **UM3** or **AA** (preferably Philips).

Notes:— Old and new or different types of batteries should not be combined.

— Remove batteries if they are empty or if the player is not going to be used for a long time.

Inserting batteries

- 1 Push **OPEN ▲** to open the CD lid.
- 2 Open the battery compartment and insert either 2 normal or alkaline batteries.

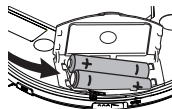

Battery indication

The approximate power level of your batteries is shown in the display.

- Battery full
- Battery two-thirds full
- Battery one-third full
- Battery dead or empty. When the batteries are dead or empty, the symbol flashes, **b A t t** is displayed, and the beep tone sounds repeatedly.



Batteries contain chemical substances, so they should be disposed of properly.

CD player and CD handling

- Do not touch the lens (A) of the CD player.
- Do not expose the unit, batteries or CDs to humidity, rain, sand or excessive heat (caused by heating equipment or direct sunlight).
- You can clean the CD player with a soft, slightly dampened, lint-free cloth. Do not use any cleaning agents as they may have a corrosive effect.
- To clean the CD, wipe it in a straight line from the center toward the edge using a soft, lint-free cloth. A cleaning agent may damage the disc! Never write on a CD or attach a sticker to it.
- The lens may cloud over when the unit is moved suddenly from cold to warm surroundings. Playing a CD is not possible then. Leave the CD player in a warm environment until the moisture has evaporated.
- Active mobile phones in the vicinity of the CD player may cause malfunctions.
- Avoid dropping the unit as this may cause damage.

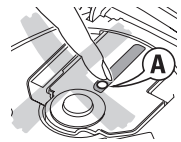

Headphones AY 3806 (AE500 for AX2420 only)

- Connect the supplied headphones to the **🔌/LINE OUT** jack of the player.

Note: **🔌 / LINE OUT** can also be used for connecting this set to your HiFi system. To adjust the sound and volume, use the controls on the connected audio equipment and on the CD player.

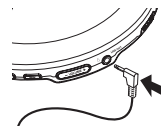

IMPORTANT!

Hearing safety: Do not play your headphones at a high volume. Hearing experts advise that continuous use at high volume can permanently damage your hearing.
Traffic safety: Do not use headphones while driving a vehicle. It may create a hazard and it is illegal in many countries. Even if your headphones are an open-air type designed to let you hear outside sounds, do not turn up the volume so high that you cannot hear what is going on around you.

FEATURES

Programming track numbers

You can store up to 30 tracks to play in a program. A single track may be stored more than once in the program.

- 1 While playback is stopped, select a track with ◀◀ or ▶▶.
 - 2 Press PROG to store the track.
 - **program** lights up; the track number programmed and **P** with the total number of stored tracks are displayed.
 - 3 Select and store all desired tracks in this way.
 - 4 Press ▶▶ to start playback of your selected tracks.
 - **program** is shown and playback starts.
- You can review the program by pressing PROG for more than 2 seconds.
 - The display shows all the stored tracks in sequence.

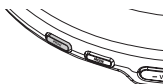

Notes: – If you press **PROG** and there is no track selected, **SEL** is displayed.
 – If you try to store more than 30 tracks, **FULL** is displayed.



Clearing the program

- While playback is stopped, press ■ to clear program.
 - **CLF** is displayed once, **program** goes off, and the program is cleared.



Note: The program will also be cleared if the power supply is interrupted, or if the CD-player lid is opened, or if the set switches off automatically.

Selecting different playing possibilities-MODE

It is possible to play tracks in random order, to repeat a single track or the entire CD, and to play the first few seconds of each track.

- 1 Press MODE during playback as often as required in order to activate one of the following 'modes'. The active mode is shown in the display.
 - **SHUFFLE**: All tracks of the CD are played in random order until all of them have been played once.
 - **SHUFFLE REPEAT ALL**: All tracks of the CD are played repeatedly in random order.
 - **REPEAT**: The current track is played repeatedly.
 - **REPEAT ALL**: The entire CD is played repeatedly.
 - **SEL**: The first 10 seconds of each of the remaining tracks are played in sequence.
 - 2 Playback starts in the chosen mode after 2 seconds.
- To return to normal playback, press MODE repeatedly until the display shows no active modes.



ESP

With a conventional portable CD-player you might have experienced that the music stopped e.g. when you were jogging. The **Electronic Skip Protection** prevents loss of sound caused by light vibrations and shocks. Continuous playback is ensured. However ESP does not prevent playback interruptions during vigorous running. It also does not protect the unit against any damage caused by dropping!

In this set ESP is default ON. It is possible to set ESP off.

- Press MODE/ESP for more than 3 seconds.
 - **ESP** disappears.
- Press MODE/ESP again for more than 3 seconds.
 - **ESP** is displayed.

ESP on ⇒ **ESP off** ⇒ **ESP on**

FEATURES / TROUBLESHOOTING

RESUME and HOLD

You can interrupt playback and continue (even after an extended period of time) from the position where playback stopped (RESUME) and you can lock all buttons of the set so that no action will be executed (HOLD). Use the RESUME–HOLD–OFF slider for these functions.



RESUME – continuing from where you have stopped

- 1 Switch the slider to RESUME during playback to activate RESUME.
 - **RESUME** is shown.
 - 2 Press ■ whenever you want to stop playback.
 - 3 Press ▶▶ whenever you want to resume playback.
 - **RESUME** is shown and playback continues from where you have stopped.
- To deactivate RESUME, switch the slider to OFF.
 - **RESUME** goes off.



HOLD – locking all buttons

You can lock the buttons of the set by switching the slider to HOLD. Now, when a key is pressed, no action will be executed. This is of use, for example, when transporting the player in a bag. With HOLD activated, you can avoid accidental activation of other functions.

- 1 Switch the slider to HOLD to activate HOLD.
 - All buttons are locked. **Hold** is shown when you press any button. If the set is switched off, **HOLD** will be shown only when ▶▶ is pressed.
- 2 To deactivate HOLD, switch the slider to OFF.



Note: If you deactivate HOLD by switching the slider to RESUME, you will be activating the RESUME function.

Troubleshooting

WARNING: Under no circumstances should you try to repair the set yourself as this will invalidate the warranty. If a fault occurs, first check the points listed, before taking the unit for repair. If you are unable to solve a problem by following these hints, consult your dealer or service center.

The CD player has no power, or playback does not start

- Check that your batteries are not dead or empty, that they are inserted correctly, that the contact pins are clean.
- Your adapter connection may be loose. Connect it securely.
- For in-car use, check that the car ignition is on. Also check player's batteries.

The indication **NO CD** is displayed

- Check that the CD is clean and correctly inserted (label-side upward).
- If your lens has steamed up, wait a few minutes for this to clear.

The indication **NO CD** is displayed

- CD-RW (CD-R) was not recorded properly. Use FINALIZE on your CD-recorder.

The indication **HOLD** is on and/or there is no reaction to controls

- If HOLD is activated, then deactivate it.
- Electrostatic discharge. Disconnect power or remove batteries for a few seconds.

The CD skips tracks

- The CD is damaged or dirty. Replace or clean the CD.
- RESUME, SHUFFLE or PROGRAM is active. Switch off whichever is on.

No sound or bad sound quality.

- PAUSE might be active. Press ▶▶.
- Loose, wrong or dirty connections. Check and clean connections.
- Volume might not be appropriately adjusted. Adjust the volume.
- Strong magnetic fields. Check player's position and connections. Also keep away from active mobile phones.
- For in-car use, check that the cassette adapter is inserted correctly, that the car cassette player's playback direction is correct (press autoreverse to change), and that the cigarette lighter jack is clean. Allow time for temperature change.

AUSTRALIA-Philips 3 years Manufacturers Warranty for Australia only

These warranty conditions are valid for the following consumer electronics products: Colour Televisions, Video Cassette Recorders, CD Players and Recorders, DVD Players and Recorders, Audio Systems and Portable Audio. The benefits given to the purchaser by this warranty are in addition to all other rights and remedies which the purchaser has in respect of the product under the Trade Practices Act or other Commonwealth or State Law.

Philips Consumer Electronics warrants its products to the purchaser as follows and subject to the stated conditions.

3 YEARS free Repair Service

Colour Televisions, CD Players and Recorders, DVD Players and Recorders and Audio Systems.

3 YEARS free Replacement – at your Retailer

All Portable Audio products and all Video Cassette recorders (VCR's) only.

Conditions of Repair Warranty

1. All claims for warranty service should be made to your nearest Philips Authorised Service Centre. Reasonable evidence of date of purchase must be provided.
2. This warranty extends only to defects in material or workmanship occurring under normal use of the product when operated in accordance with the instructions.
3. This warranty applies for original purchase only. It is not transferable if sold.
4. Home service within the normal service area of one of our Authorised Service Centres will only be provided for television receivers with screen size 48 cm and above. All other products are to be taken or sent to the workshop of your nearest Authorised Service Centre (at Consumer's expense).
5. This Manufacturers Warranty is limited to 3 months for above listed Consumer Electronics products if used in commercial applications.
6. Philips may, at its discretion choose to replace rather than repair any product covered by this warranty.
7. This Manufacturers Warranty is neither transferable nor valid in countries other than Australia.

This warranty does not cover:

- a) Mileage or travelling time, pickup or delivery, installations and cost of insurance.
- b) Mileage or travel outside the normal service area covered by selected Authorised Service Centre.
- c) Service costs arising from failure to correctly adjust the controls of the product or to observe the instructions, or inspections that reveal that the product is in normal working order.

- d) Product failures caused by misuse, neglect, accidental breakage, transit damage, inexpert repairs or modification by un-authorised persons, external fires, lightning strikes, floods, vermin infestation or liquid spillage.
- e) Cleaning of video or audio heads.
- f) Inadequate receiving antennae.
- g) Replacement of worn or used batteries or other consumables.
- h) Consumer products used in commercial applications (This warranty is limited to 3 months only).
- i) Second hand products.

The conditions contained in this warranty card replace and override the provision of the Philips World-Wide Guarantee for products purchased in Australia and used in Australia.

Philips Authorised Service Centres

Service is provided through 200 accredited Authorised Service Centres throughout Australia. For direct contact with your nearest recommended Authorised Service Centre in major cities:

Adelaide	Melbourne	Geelong	Sydney
Launceston	Canberra	Perth	Hobart
Brisbane	Newcastle	Gold Coast	Wollongong

or to find the location of your nearest recommended Authorised Service Centre outside the above cities please call our National Service telephone number:

1300 361 392

Please record the following information for your records and keep in a safe place.

Model number.....

Serial number.....

Date of purchase.....

Retailer.....

We recommend you retain your purchase receipt to assist in any warranty claim.

Philips Consumer Electronics
a division of Philips Electronics Australia Limited
ABN 24 008 445 743,
Level 2, 65 Epping Road NORTH RYDE NSW 2113

3 year Warranty valid for all new products purchased after 1st July 2002

NEW ZEALAND-Guarantee and Service for New Zealand

Thank-you for purchasing this quality Philips product.

Philips New Zealand Ltd guarantees this product against defective components and faulty workmanship for a period of 12 months. Any defect in materials or workmanship occurring within 12 months from the date of purchase subject to the following conditions will be rectified free of charge by the retailer from whom this product was purchased.

Conditions

1. The product must have been purchased in New Zealand. As proof of purchase, retain the original sales docket indicating the date of purchase.
2. The guarantee applies only to faults caused by defective components, or faulty workmanship on the part of the manufacturer.
3. The guarantee does not cover failures caused by misuse, neglect, normal wear and tear, accidental breakage, use on the incorrect voltage, use contrary to operating instructions, or unauthorised modification to the product or repair by an unauthorised technician.
4. Reasonable evidence (in the form of a sales docket) must be supplied to indicate that the product was purchased no more than 12 months prior to the date of your claim.
5. In the event of a failure, Philips shall be under no liability for any injury, or any loss or damage caused to property or products other than the product under guarantee.

This guarantee does not prejudice your rights under common law and statute, and is in addition to the normal responsibilities of the retailer and Philips.

How to claim

Should your Philips product fail within the guarantee period, please return it to the retailer from whom it was purchased. In most cases the retailer will be able to satisfactorily repair or replace the product. However, should the retailer not be able to conclude the matter satisfactorily, or if you have other difficulties claiming under this guarantee, please contact

The Guarantee Controller Philips New Zealand Ltd.

✉ P.O. Box 41.021

Auckland

☎ (09) 84 94 160

fax ☎ (09) 84 97 858

Free Manuals Download Website

<http://myh66.com>

<http://usermanuals.us>

<http://www.somanuals.com>

<http://www.4manuals.cc>

<http://www.manual-lib.com>

<http://www.404manual.com>

<http://www.luxmanual.com>

<http://aubethermostatmanual.com>

Golf course search by state

<http://golfingnear.com>

Email search by domain

<http://emailbydomain.com>

Auto manuals search

<http://auto.somanuals.com>

TV manuals search

<http://tv.somanuals.com>