

Portable CD Player

AX3211, AX3212, AX3213, AX3214, AX3215
AX3216, AX3217, AX3218, AX3219, AX3220
AX3221, AX3222, AX3223, AX3224, AX3225

Audio



Read this manual first!

If you have any problems, do not attempt to return this product to the store.

For fast help, call us first!

1-800-531-0039

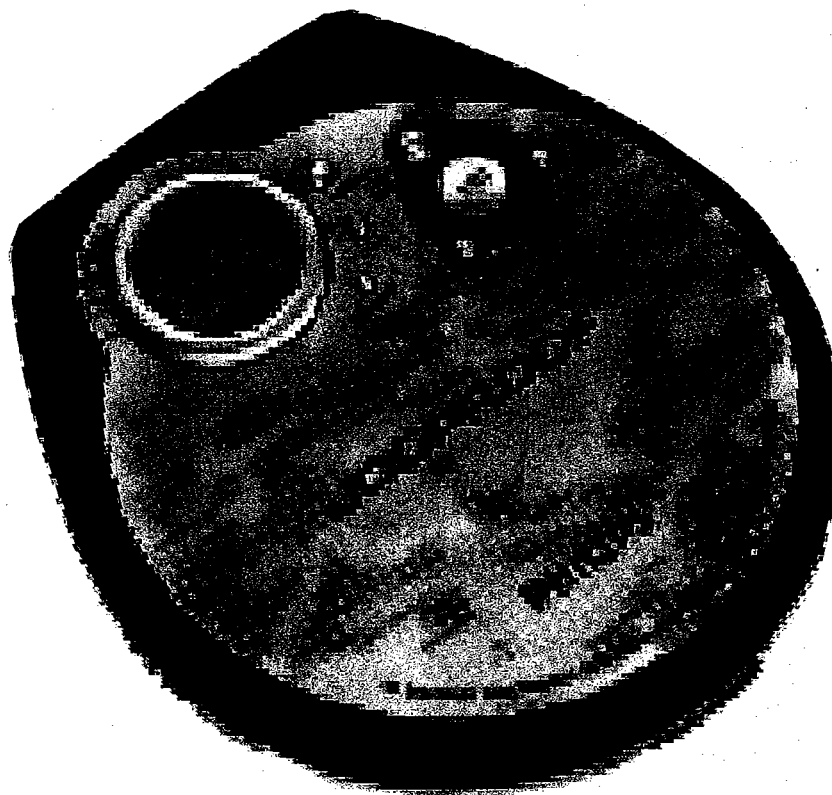

314011529681

Let's make things better.



PHILIPS

PHILIPS CONSUMER ELECTRONICS NORTH AMERICA

Knoxville, Tennessee 37914-1810, U.S.A.

Download from www.somanuals.com. All Manuals Search And Download.

6

5

7

4

8

3

9

2

10

1

11

12

13

14

15

1

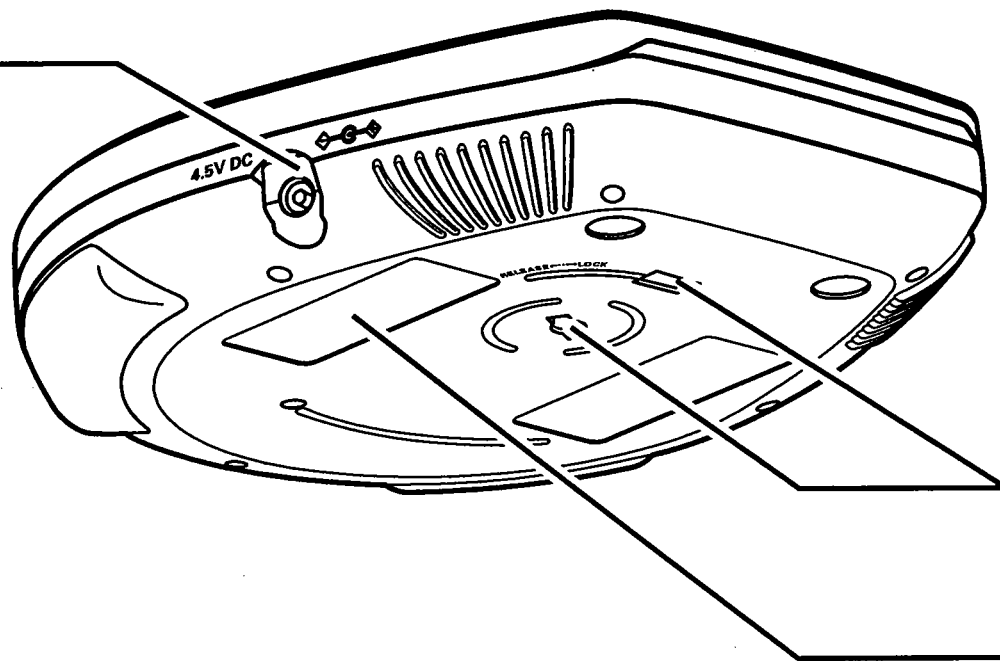
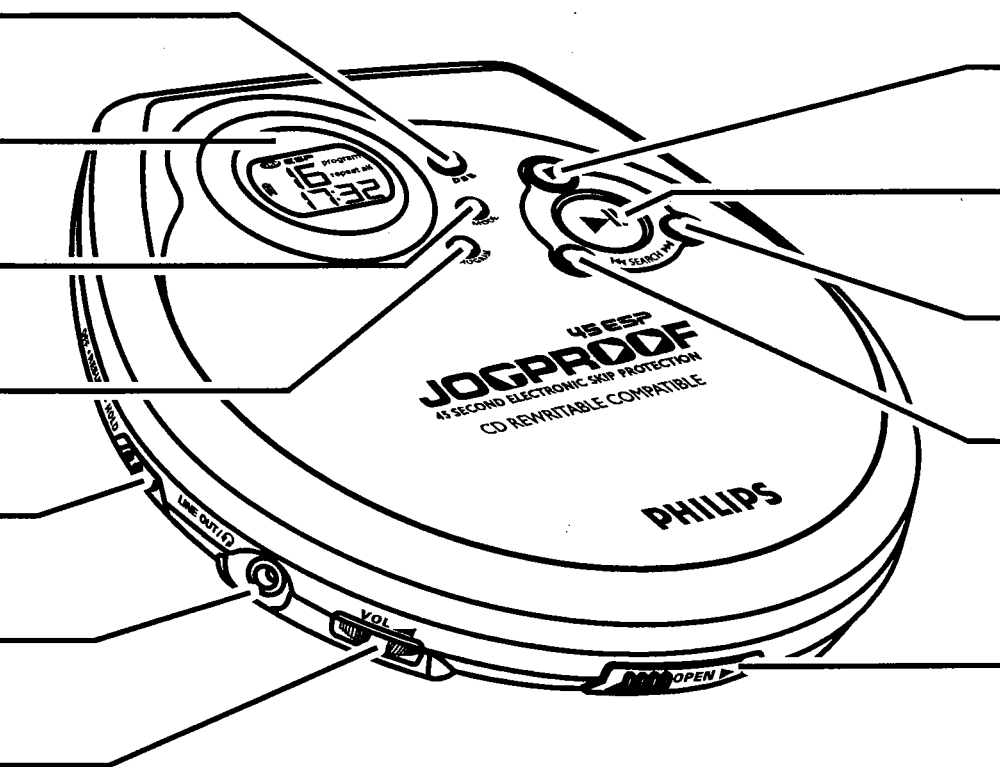

1 OPEN

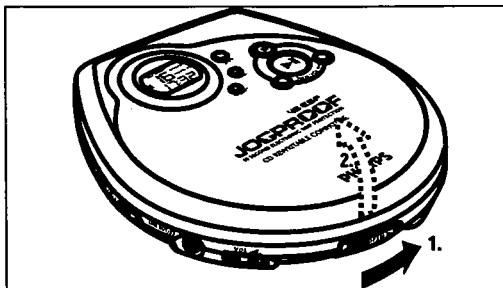

2

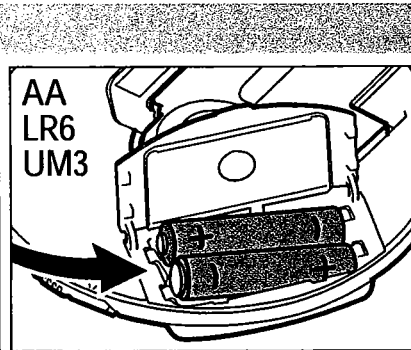
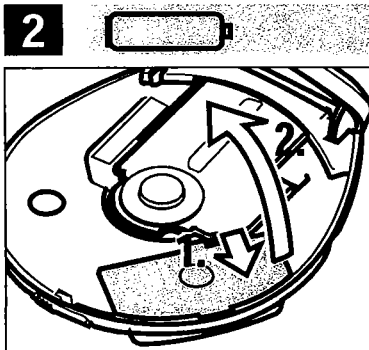

3 CD

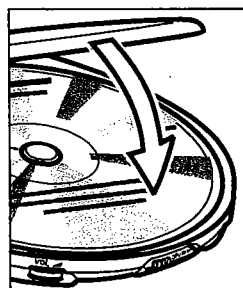
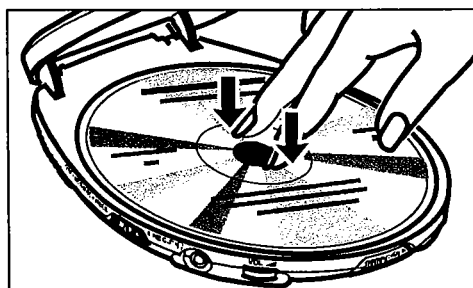

4

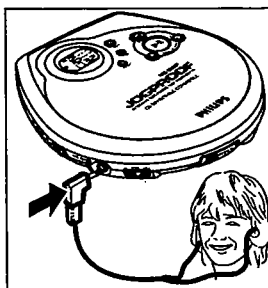

5 HOLD-OFF

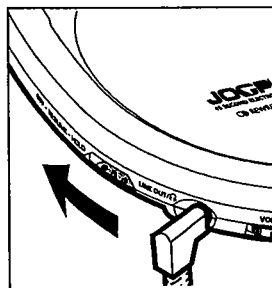

6 PLAY

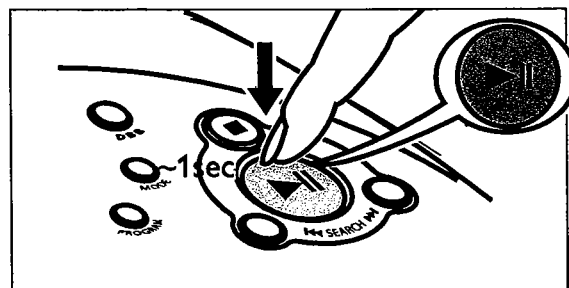

7 VOLUME

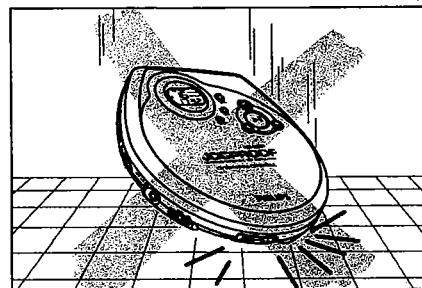
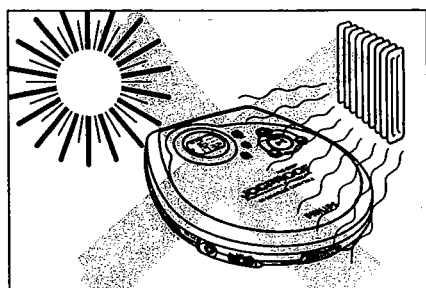
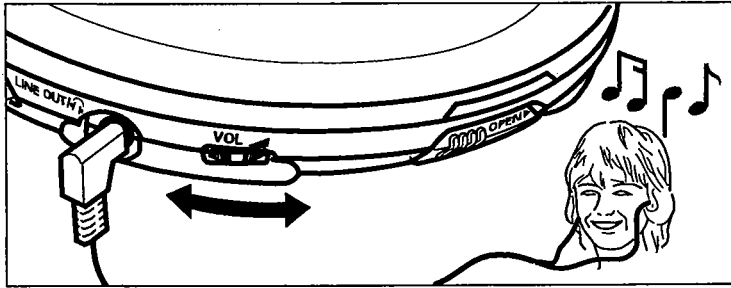

IMPORTANT SAFETY INSTRUCTIONS

1. **Read these instructions.**
2. **Keep these instructions.**
3. **Heed all warnings.**
4. **Follow all instructions.**
5. **Do not use this apparatus near water.**
6. **Clean only with a dry cloth.**
7. **Do not block any of the ventilation openings. Install in accordance with the manufacturers instructions.**
8. **Do not install near any heat sources** such as radiators, heat registers, stoves, or other apparatus (including amplifiers) that produce heat.
9. **Only use attachments/accessories** specified by the manufacturer.
10.  **Use only with a cart**, stand, tripod, bracket, or table specified by the manufacturer or sold with the apparatus. When a cart is used, use caution when moving the cart/apparatus combination to avoid injury from tip-over.
11. **Refer all servicing** to qualified service personnel. Servicing is required when the apparatus has been damaged in any way, such as if the power-supply cord or plug is damaged, liquid has been spilled or objects have fallen into the apparatus, or when the apparatus has been exposed to rain or moisture, does not operate normally, or has been dropped.
12. **Battery usage CAUTION** – To prevent battery leakage which may result in bodily injury, property damage or damage to the unit:
 - Install **ALL** batteries correctly, + and - as marked on the unit.
 - Do not mix batteries (**OLD** and **NEW** or **CARBON** and **ALKALINE**, etc.).
 - Remove batteries when the unit is not used for a long time.

EL 6474-E004: 02/8

Return your Warranty Registration card today to ensure you receive all the benefits you're entitled to.

- Once your Philips purchase is registered, you're eligible to receive all the privileges of owning a Philips product.
- So complete and return the Warranty Registration Card enclosed with your purchase at once, and take advantage of these important benefits.

Warranty Verification

Registering your product within 10 days confirms your right to maximum protection under the terms and conditions of your Philips warranty.

Owner Confirmation

Your completed Warranty Registration Card serves as verification of ownership in the event of product theft or loss.

Model Registration

Returning your Warranty Registration Card right away guarantees you'll receive all the information and special offers which you qualify for as the owner of your model.

Know these *safety* symbols

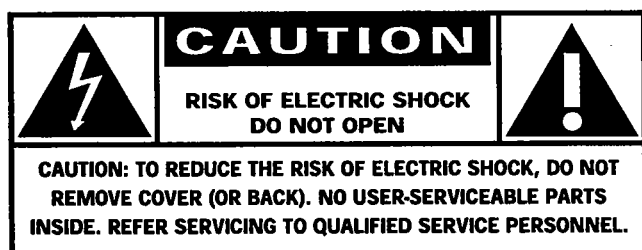

 This "bolt of lightning" indicates uninsulated material within your unit may cause an electrical shock. For the safety of everyone in your household, please do not remove product covering.

 The "exclamation point" calls attention to features for which you should read the enclosed literature closely to prevent operating and maintenance problems.

For Customer Use

Enter below the Serial No. which is located on the rear of the cabinet. Retain this information for future reference.

Model No. _____

Serial No. _____

WARNING: TO PREVENT FIRE OR SHOCK HAZARD, DO NOT EXPOSE THIS EQUIPMENT TO RAIN OR MOISTURE.

CAUTION: To prevent electric shock, match wide blade of plug to wide slot, and fully insert.

MAC5097

LIMITED WARRANTY

PORTABLE COMPACT DISC

One Year Free Exchange

This product must be carried in for an exchange.

WHO IS COVERED?

You must have proof of purchase to exchange the product. A sales receipt or other document showing that you purchased the product is considered proof of purchase. Attach it to this owner's manual and keep both nearby.

WHAT IS COVERED?

Warranty coverage begins the day you buy your product. For one year thereafter, a defective or inoperative product will be replaced with a new, renewed or comparable product at no charge to you. A replacement product is covered only for the original warranty period. When the warranty on the original product expires, the warranty on the replacement product also expires.

WHAT IS EXCLUDED?

Your warranty does not cover:

- labor charges for installation or setup of the product, adjustment of customer controls on the product, and installation or repair of antenna systems outside of the product.
- product repair and/or part replacement because of misuse, accident, unauthorized repair or other cause not within the control of Philips.
- reception problems caused by signal conditions or cable or antenna systems outside the unit.
- a product that requires modification or adaptation to enable it to operate in any country other than the country for which it was designed, manufactured, approved and/or authorized, or repair of products damaged by these modifications.
- incidental or consequential damages resulting from the product. (Some states do not allow the exclusion of incidental or consequential damages, so the above exclusion may not apply to you. This includes, but is not limited to, prerecorded material, whether

that is used for commercial or institutional purposes.

EXCHANGE AVAILABLE?

Exchange the product in all countries where the product is officially distributed. In countries where Philips does not distribute the product, the local Philips organization will attempt to provide a replacement product (although there may be no appropriate product is not readily available).

**Philips, P.O. Box 520890, Miami,
FL 33152, USA, (402) 536-4171**

BEFORE REQUESTING EXCHANGE...

Please check your owner's manual for assistance. If you have additional questions, call us at 1-800-531-0039.

**EXCHANGING A PRODUCT IN U.S.A.,
PUERTO RICO, OR U.S.VIRGIN ISLANDS...**

Contact 1-800-531-0039 to arrange an exchange. Or, ship the product, insured and freight prepaid, and with proof of purchase enclosed, to the address listed below.

Philips Exchange Program
Suite A
406 North Irish Street
Greeneville TN 37745

(In U.S.A., Puerto Rico, and U.S. Virgin Islands, all implied warranties, including implied warranties of merchantability and fitness for a particular purpose, are limited in duration to the duration of this express warranty. But, because some states do not allow limitations on how long an implied warranty may last, this limitation may not apply to you.)

EXCHANGING A PRODUCT IN CANADA...

Please contact Philips at:

1-800-661-6162 (French Speaking)
1-800-531-0039 (English or Spanish Speaking)

(In Canada, this warranty is given in lieu of all other warranties. No other warranties are expressed or implied, including any implied warranties of merchantability or fitness for a particular purpose. Philips is not liable under any circumstances for any direct, indirect, special, incidental or consequential damages, howsoever incurred, even if notified of the possibility of such damages.)

REMEMBER...

Please record below the model and serial numbers found on the product. Also, please fill out and mail your warranty registration card promptly. It will be easier for us to notify you if necessary.

MODEL # _____

SERIAL # _____

This warranty gives you specific legal rights. You may have other rights which vary from state/province to state/province.

EL4967E007 / 8-02

BELT CLIP

CLIP CEINTURE

CINTURÓN DE CIERRE

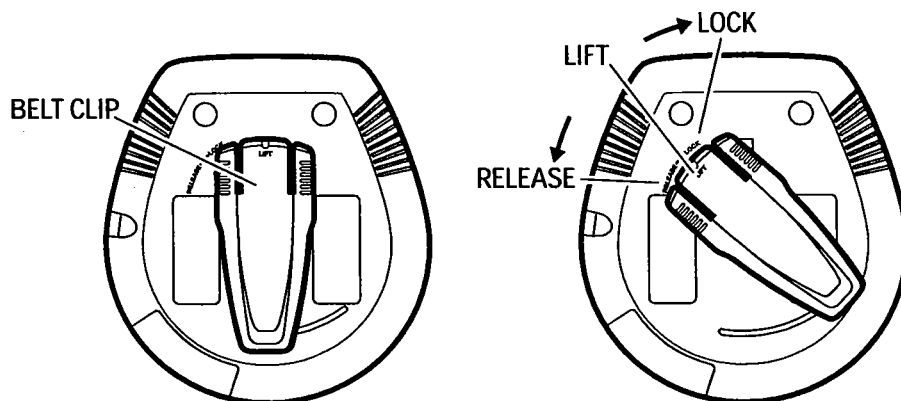

English (supplied or optionally available)

- 1 To attach the belt clip to the CD player, position the shaped grip (found on the back of the belt grip) so that it fits into the belt clip hole of the CD player. Turn the clip to LOCK as indicated on the CD player.
- 2 To detach, gently lift the belt clip and turn to RELEASE as indicated on the CD player.

Français (fourni ou en option)

- 1 Pour fixer le clip ceinture, placez l'attache (située sur le dos du clip) dans le trou prévu à cet effet sur l'appareil. Tournez l'attache jusqu'à LOCK, comme indiqué sur l'appareil.
- 2 Pour enlever l'attache, soulevez-la doucement et tournez-la jusqu'à RELEASE.

Español (suministrado o disponible de forma opcional)

- 1 Para ponerse el cinturón, encaje el broche (en la parte posterior del cinturón) en el orificio del cinturón de cierre. Gire el cierre hasta LOCK tal y como se indica.
- 2 Para quitárselo, levante con cuidado el cinturón y gire hasta RELEASE tal y como se indica.

El aparato cumple las normas FCC, Parte 15 y 21 CFR 1040.10. Funcionamiento dependiente de dos condiciones siguientes:

1. Este aparato no puede provocar interferencia dañina, y
2. Este aparato debe aceptar cualquier interferencia recibida, incluyendo las interferencias que pueden provocar un funcionamiento insuficiente.

L'appareil répond aux normes FCC, Part 15 et 21 CFR 1040.10. Fonctionnement soumis aux deux conditions suivantes :

1. Cet appareil ne doit pas provoquer d'interférences nuisibles, et
2. Cet appareil doit accepter toute interférence reçue, y compris les interférences susceptibles de provoquer un fonctionnement peu satisfaisant.

The set complies with the FCC-Rules, Part 15 and with 21 CFR 1040.10.

Operation is subject to the following two conditions:

1. This device may not cause harmful interference, and
2. This device must accept any interference received, including interference that may cause undesired operation.

Canada

English: This digital apparatus does not exceed the Class B limits for radio noise emissions from digital apparatus as set out in the Radio Interference Regulations of the Canadian Department of Communications.

Français : Cet appareil numérique n'émet pas de bruits radioélectriques dépassant les limites applicables aux appareils numériques de Classe B prescrites dans le Règlement sur le Brouillage Radioélectrique édicté par le Ministère des Communications du Canada.

CAUTION

Use of controls or adjustments or performance of procedures other than herein may result in hazardous radiation exposure or other unsafe operation.

ATTENTION

L'utilisation de commandes ou de réglages ou l'exécution de procédures autres que celles décrites dans le présent manuel risque d'entraîner une exposition à un rayonnement dangereux ou d'avoir d'autres conséquences sur la sécurité.

PRECAUCIÓN

La utilización de controles o ajustes y la realización de procedimientos distintos de los contenidos en este manual pueden provocar la exposición a radiaciones peligrosas y a otros peligros.

CONTROLS (see figure 1)

- 1 OPEN ►opens the CD lid
- 2 ◀◀skips and searches CD tracks backwards
- 3 ▶▶skips and searches CD tracks forwards
- 4 ►||switches the player on, starts or pauses CD play
- 5 ■stops CD play, clears a program or switches the player off
- 6 DBBswitches the bass enhancement on and off. This button also switches acoustic feedback (the beep) on/off when it is pressed for more than 2 seconds
- 7display
- 8 MODEselects the different playing possibilities: **shuffle**, **shuffle repeat all**, **repeat**, **repeat all** and **SCAN**
- 9 PROGRAMprograms tracks and reviews the program
- 10 RESUMEstores the last position of a CD track played
HOLD.....locks all buttons
OFF.....switches RESUME and HOLD off
- 11 LINE OUT/🔊.....3.5 mm headphone jack and LINE OUT jack to connect the player to another audio input of an additional appliance, remote control (not on all versions)
- 12 VOL ◀adjusts the volume
- 13 4.5V DC.....jack for external power supply
- 14belt clip holder
- 15type plate

Batteries (supplied or optionally available)

You can use the following batteries with this CD-player:

- normal batteries type **LR6**, **UM3** or **AA** (preferably Philips), or
- alkaline batteries type **LR6**, **UM3** or **AA** (preferably Philips).

Notes: – Old and new or different types of batteries should not be combined.
– Remove batteries if they are empty or if the player is not going to be used for a long time.

Inserting batteries

- 1 Push OPEN ► to open the CD lid.
- 2 Open the battery compartment and insert either 2 normal or alkaline batteries.

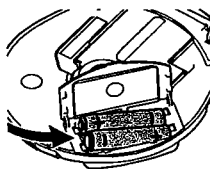

Battery indication

The approximate power level of your batteries is shown in the display.

- Battery full
- Battery two-thirds full
- Battery one-third full
- Battery dead or empty. When the batteries are dead or empty, the symbol flashes, **ERR** is displayed, and the beep tone sounds repeatedly.

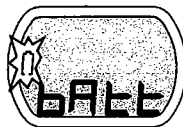

Average playing time of batteries under normal conditions

Battery type	ESP on	Power Save
Normal	5 hours	6 hours
Alkaline	16 hours	20 hours

Batteries contain chemical substances, so they should be disposed of properly.

Mains adapter (supplied or optionally available)

Use only the AY 3170 adapter (4.5 V / 300 mA direct current, positive pole to the center pin). Any other product may damage the player.

- 1 Make sure the local voltage corresponds to the power adapter's voltage.
- 2 Connect the power adapter to the 4.5V DC jack of the player and to the wall outlet.

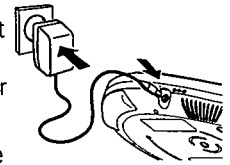

Note: Always disconnect the adapter when you are not using it.

Environmental information

- All redundant packing material has been omitted. We have done our utmost to make the packaging easily separable into two materials: cardboard (box) and polyethylene (bags, protective foam sheet).
- Your set consists of materials which can be recycled if disassembled by a specialized company. Please observe the local regulations regarding the disposal of packing materials, dead batteries and old equipment.

CD player and CD handling

- Do not touch the lens (A) of the CD player.
- Do not expose the unit, batteries or CDs to humidity, rain, sand or excessive heat (caused by heating equipment or direct sunlight).
- You can clean the CD player with a soft, slightly dampened, lint-free cloth. Do not use any cleaning agents as they may have a corrosive effect.
- To clean the CD, wipe it in a straight line from the center toward the edge using a soft, lint-free cloth. A cleaning agent may damage the disc! Never write on a CD or attach a sticker to it.
- The lens may cloud over when the unit is moved suddenly from cold to warm surroundings. Playing a CD is not possible then. Leave the CD player in a warm environment until the moisture has evaporated.
- Active mobile phones in the vicinity of the CD player may cause malfunctions.
- Avoid dropping the unit as this may cause damage.

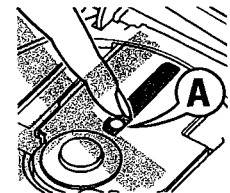

Headphones

- Connect the supplied headphones to the LINE OUT/🔊 jack of the player.

Note: LINE OUT/🔊 can also be used for connecting this set to your HiFi system. To adjust the sound and volume, use the controls on the connected audio equipment and on the CD player.

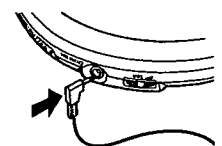

IMPORTANT!

Hearing safety: Do not play your headphones at a high volume. Hearing experts advise that continuous use at high volume can permanently damage your hearing.
Traffic safety: Do not use headphones while driving a vehicle. It may create a hazard and it is illegal in many countries. Even if your headphones are an open-air type designed to let you hear outside sounds, do not turn up the volume so high that you cannot hear what is going on around you.

GENERAL INFORMATION / CD PLAY

In-car use (connections supplied or optionally available)

Only use the AY 3545 (4822 219 10033) or AY 3548 (3140 118 71890) car voltage converter (4.5 V DC, positive pole to the center pin) and the AY 3501 cassette car adapter. Any other product may damage the set.

- 1 Put the set on a horizontal, vibration-free and stable surface. Make sure it is in a safe place, where the set is neither a danger nor an obstacle to the driver and the passengers.
 - 2 Plug the voltage converter into the cigarette lighter jack (**only for 12 V car battery, negative grounding**), then connect the wired end with 4.5V DC input jack on the set.
 - 3 If necessary, clean the cigarette lighter jack to obtain a good electrical contact.
 - 4 Turn down the volume and connect the cassette adapter plug to LINE OUT/Ω on the set.
 - 5 Carefully insert the cassette adapter into the car radio's cassette compartment.
 - 6 Make sure the cord does not hinder your driving.
 - 7 Decrease the volume on the set if necessary. Start playback on the set and adjust the sound with the car radio controls.
- **Always remove the voltage converter from the cigarette lighter jack when the set is not in use.**

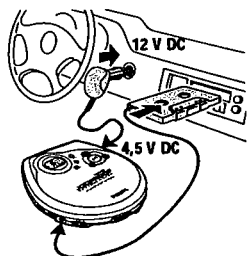

Note: If your car radio has a LINE IN jack, it is better to use it for the car radio connection instead of the cassette adapter. Connect the signal lead to this LINE IN jack and to LINE OUT/Ω on the set.

Playing a CD

This CD-player can play all kinds of **Audio Discs** such as CD-Recordables and CD-Rewritables. Do not try to play a CD-ROM, CDi, VCD, DVD or computer CD.

- 1 Push the OPEN ► slider to open the player.
 - 2 Insert an audio CD, printed side up, by pressing the CD onto the hub.
 - 3 Close the player by pressing the lid down.
 - 4 Press ►|| to switch the player on and start playback.
→ The current track number and elapsed playing time are displayed.
- You can pause playback by pressing ►||.
→ The time at which playback was paused starts flashing.
 - You can continue playback by pressing ►|| again.
- 5 Press ■ to stop playback.
→ The total number of tracks and the total playing time of the CD are displayed.
 - 6 Press ■ again to switch the player off.
- To remove the CD, hold it by its edge and press the hub gently while lifting the CD.

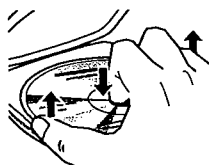
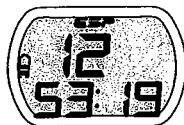
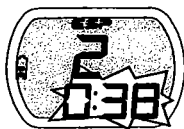
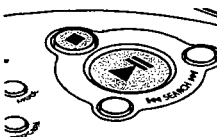
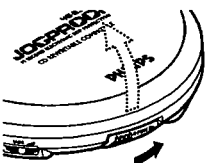

Note: If there is no activity, the set will automatically switch off after a while to save energy.

CD PLAY / FEATURES

Playback information

- If a CD-Recordable (CD-R) or a CD-Rewritable (CD-RW) is not recorded properly, *RF 15%* is displayed, indicating that the CD has not been finalized. In that case, use FINALIZE on your CD recorder to complete the recording.
- When playing a CD-Rewritable (CD-RW), please note that it takes 3–15 seconds after pressing ►|| for sound reproduction to start.
- Playback will stop if you open the CD lid.
- While the CD is read, *1 - -* flashes in the display.

Volume and bass

Volume adjustment

- Adjust the volume by using VOL ◀▶.

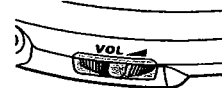

Bass adjustment

- Press DBB to switch the bass enhancement on or off
→ **DBB** is shown if the bass enhancement is activated.

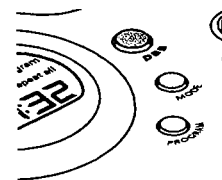

Remote control (supplied or optionally available)

Use the AY 3768 cord remote control. The buttons on the remote control have the same functions as the corresponding buttons on the set.

- 1 Press ■ twice to switch off the set.
- 2 Firmly connect the remote control to LINE OUT/Ω on the set.
- 3 Adjust the volume VOL ◀▶ on the CD player and remote control.

Selecting a track and searching

Selecting a track during playback

- Briefly press ◀◀ or ▶▶ once or several times to skip to the current, previous or next track.
→ Playback continues with the selected track, and the track's number is displayed.

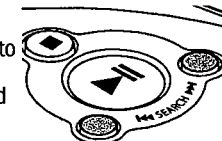

Selecting a track when playback is stopped

- 1 Briefly press ◀◀ or ▶▶ once or several times to select the desired track. The track number is displayed.
- 2 Press ►|| to start CD play.
→ Playback starts with the selected track.

Searching for a passage during playback

- 1 Keep ◀◀ or ▶▶ pressed to find a particular passage in a backward or forward direction.
→ Searching starts while playback continues at low volume. After 2 seconds the search speeds up.
- 2 Release the button when you reach the desired passage.
→ Playback continues from this position.

Notes: – If the player is in SCAN mode (see MODE chapter), searching is not possible.
– In shuffle, shuffle repeat all or repeat mode (see MODE chapter), or while playing a program, searching is only possible within the particular track.

FEATURES

Programming track numbers

You can store up to 30 tracks to play in a program. A single track may be stored more than once in the program.

- 1 While playback is stopped, select a track with **◀◀** or **▶▶**.
 - 2 Press PROGRAM to store the track.
→ **program** lights up; the track number programmed and **P** with the total number of stored tracks are displayed.
 - 3 Select and store all desired tracks in this way.
 - 4 Press **▶▶** to start playback of your selected tracks.
→ **program** is shown and playback starts.
- You can review the program by pressing PROGRAM for more than 2 seconds.
→ The display shows all the stored tracks in sequence.

Notes: – If you press PROGRAM and there is no track selected, **SEL** is displayed.
– If you try to store more than 30 tracks, **FULL** is displayed.

Clearing the program

- While playback is stopped, press **■** to clear program.
→ **CLF** is displayed once, **program** goes off, and the program is cleared.

Note: The program will also be cleared if the power supply is interrupted, or if the CD-player lid is opened, or if the set switches off automatically.

Selecting different playing possibilities—MODE

It is possible to play tracks in random order, to repeat a single track or the entire CD, and to play the first few seconds of each track.

- 1 Press MODE during playback as often as required in order to activate one of the following 'modes'. The active mode is shown in the display.
→ **shuffle**: All tracks of the CD are played in random order until all of them have been played once.
→ **shuffle repeat all**: All tracks of the CD are played repeatedly in random order.
→ **repeat**: The current track is played repeatedly.
→ **repeat all**: The entire CD is played repeatedly.
→ **SCRR**: The first 10 seconds of each of the remaining tracks are played in sequence.
 - 2 Playback starts in the chosen mode after 2 seconds.
- To return to normal playback, press MODE repeatedly until the display shows no active modes.

ESP / Power Save Mode

With a conventional portable CD-player you might have experienced that the music stopped e.g. when you were jogging. The **ELECTRONIC SKIP PROTECTION** prevents loss of sound caused by light vibrations and shocks. Continuous playback is ensured. However ESP does not prevent playback interruptions during vigorous running. It also does not protect the unit against any damage caused by dropping! On this set ESP is default on. It is possible to set ESP off and enter the Power Save mode. The Power Save mode helps to extend battery lifetime for longer playback.

- Press MODE for more than 2 seconds.
→ **ESP** disappears, power save mode is now activated.
- Press MODE again for more than 2 seconds.
→ **ESP** is displayed once

ESP on → Power Save → ESP on

FEATURES / TROUBLESHOOTING

RESUME and HOLD

You can interrupt playback and continue (even after an extended period of time) from the position where playback stopped (RESUME) and you can lock all buttons of the set so that no action will be executed (HOLD). Use the RESUME-HOLD-OFF slider for these functions.

RESUME – continuing from where you have stopped

- 1 Switch the slider to RESUME during playback to activate RESUME.
→ **resume** is shown.
 - 2 Press **■** whenever you want to stop playback.
 - 3 Press **▶▶** whenever you want to resume playback.
→ **resume** is shown and playback continues from where you have stopped.
- To deactivate RESUME, switch the slider to OFF.
→ **resume** goes off.

HOLD – locking all buttons

You can lock the buttons of the set by switching the slider to HOLD. Now, when a key is pressed, no action will be executed. This is of use, for example, when transporting the player in a bag. With HOLD activated, you can avoid accidental activation of other functions.

- 1 Switch the slider to HOLD to activate HOLD.
→ All buttons are locked. **hold** is shown when you press any button. If the set is switched off, **hold** will be shown only when **▶▶** is pressed.
- 2 To deactivate HOLD, switch the slider to OFF.

Note: If you deactivate HOLD by switching the slider to RESUME, you will be activating the RESUME function.

Troubleshooting

WARNING: Under no circumstances should you try to repair the set yourself as this will invalidate the warranty. If a fault occurs, first check the points listed, before taking the unit for repair. If you are unable to solve a problem by following these hints, consult your dealer or service center.

The CD player has no power, or playback does not start

- Check that your batteries are not dead or empty, that they are inserted correctly, that the contact pins are clean.
- Your adapter connection may be loose. Connect it securely.
- For in-car use, check that the car ignition is on. Also check player's batteries.

The indication **no disc** is displayed

- Check that the CD is clean and correctly inserted (label-side upward).
- If your lens has steamed up, wait a few minutes for this to clear.

The indication **of disc** is displayed

- CD-RW (CD-R) was not recorded properly. Use FINALIZE on your CD-recorder.

The indication **HOLD** is on and/or there is no reaction to controls

- If HOLD is activated, then deactivate it.
- Electrostatic discharge. Disconnect power or remove batteries for a few seconds.

The CD skips tracks

- The CD is damaged or dirty. Replace or clean the CD.
- RESUME, SHUFFLE or PROGRAM is active. Switch off whichever is on.

No sound or bad sound quality.

- PAUSE might be active. Press **▶▶**.
- Loose, wrong or dirty connections. Check and clean connections.
- Volume might not be appropriately adjusted. Adjust the volume.
- Strong magnetic fields. Check player's position and connections. Also keep away from active mobile phones.
- For in-car use, check that the cassette adapter is inserted correctly, that the car cassette player's playback direction is correct (press autoreverse to change), and that the cigarette lighter jack is clean. Allow time for temperature change.

English

Français

Español

Meet Philips at the Internet
<http://www.philipsusa.com>

**CLASS 1
LASER PRODUCT**

3140 115 2968.1

Free Manuals Download Website

<http://myh66.com>

<http://usermanuals.us>

<http://www.somanuals.com>

<http://www.4manuals.cc>

<http://www.manual-lib.com>

<http://www.404manual.com>

<http://www.luxmanual.com>

<http://aubethermostatmanual.com>

Golf course search by state

<http://golfingnear.com>

Email search by domain

<http://emailbydomain.com>

Auto manuals search

<http://auto.somanuals.com>

TV manuals search

<http://tv.somanuals.com>