

Portable CD Player
AX3311, AX3312, AX3315

Audio

STOP!

Need help? Call us!
Philips representatives are ready to help you with any questions about your new product.
CALL US BEFORE YOU CONSIDER RETURNING THE PRODUCT!
1-800-531-0039
or visit us on the web at www.philips.com

IMPORTANT!
Return your Warranty Registration Card within 10 days
SEE WHY INSIDE



PHILIPS

Portable CD Player

English

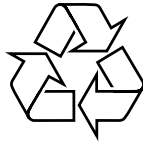

Meet Philips at the Internet
<http://www.philips.com>

**CLASS 1
LASER PRODUCT**

3140 115 31422



Printed in China

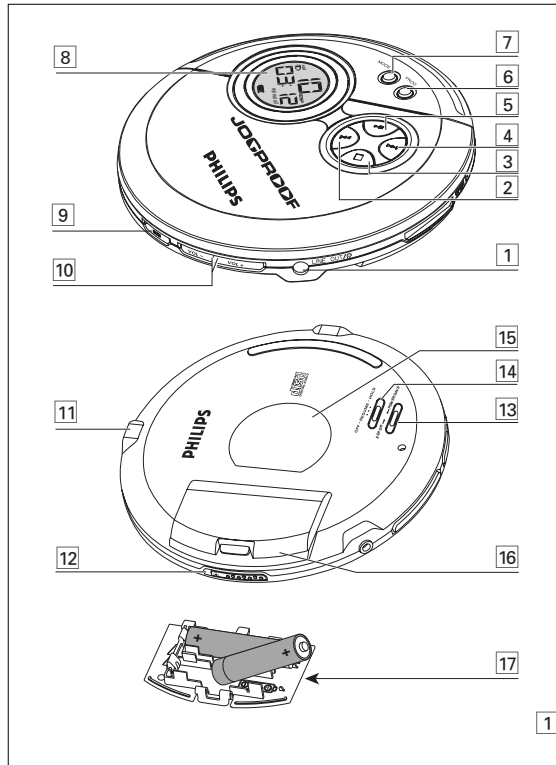

QUICK START

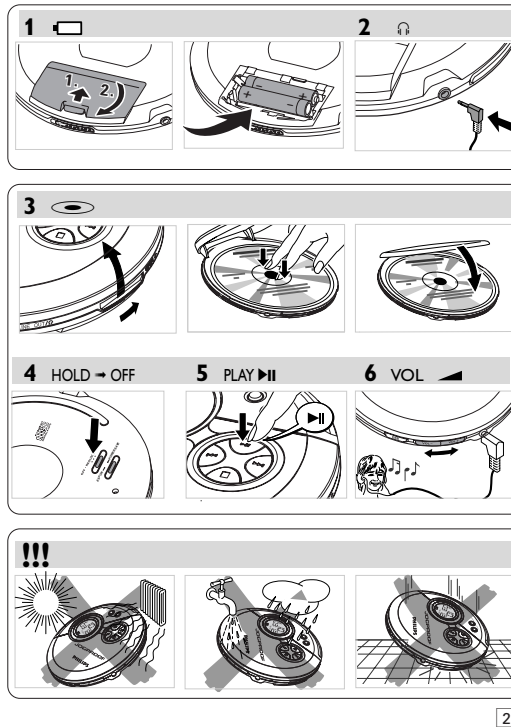

IMPORTANT SAFETY INSTRUCTIONS

1. Read these instructions.
2. Keep these instructions.
3. Heed all warnings.
4. Follow all instructions.
5. Do not use this apparatus near water.
6. Clean only with a dry cloth.
7. Do not block any of the ventilation openings. Install in accordance with the manufacturers instructions.
8. Do not install near any heat sources such as radiators, heat registers, stoves, or other apparatus (including amplifiers) that produce heat.
9. Only use attachments/accessories specified by the manufacturer.
10.  Use only with a cart, stand, tripod, bracket, or table specified by the manufacturer or sold with the apparatus. When a cart is used, use caution when moving the cart/apparatus combination to avoid injury from tip-over.

11. Refer all servicing to qualified service personnel. Servicing is required when the apparatus has been damaged in any way, such as if the power-supply cord or plug is damaged, liquid has been spilled or objects have fallen into the apparatus, or when the apparatus has been exposed to rain or moisture, does not operate normally, or has been dropped.
12. **Battery usage CAUTION** – To prevent battery leakage which may result in bodily injury, property damage, or damage to the unit:
 - Install **ALL** batteries correctly, + and - as marked on the unit.
 - Do not mix batteries (**OLD** and **NEW** or **CARBON** and **ALKALINE**, etc.).
 - Remove batteries when the unit is not used for a long time.

EL 6474-E004: 02/8

LIMITED WARRANTY

PORTABLE COMPACT DISC

One Year Free Exchange
This product must be carried in for an exchange.

WHO IS COVERED?

You must have proof of purchase to exchange the product. A sales receipt or other document showing that you purchased the product is considered proof of purchase. Attach it to this owner's manual and keep both nearby.

WHAT IS COVERED?

Warranty coverage begins the day you buy your product. For one year thereafter, a defective or inoperative product will be replaced with a new, renewed or comparable product at no charge to you. A replacement product is covered only for the original warranty period. When the warranty on the original product expires, the warranty on the replacement product also expires.

WHAT IS EXCLUDED?

Your warranty does not cover:

- labor charges for installation or setup of the product, adjustment of customer controls on the product, and installation or repair of antenna systems outside of the product.
- product repair and/or part replacement because of misuse, accident, unauthorized repair or other cause not within the control of Philips.
- reception problems caused by signal conditions or cable or antenna systems outside the unit.
- a product that requires modification or adaptation to enable it to operate in any country other than the country for which it was designed, manufactured, approved and/or authorized, or repair of products damaged by these modifications.
- incidental or consequential damages resulting from the product. (Some states do not allow the exclusion of incidental or consequential damages, so the above exclusion may not apply to you. This includes, but is not limited to, prerecorded material, whether copyrighted or not copyrighted.)
- a product that is used for commercial or institutional purposes.

WHERE IS EXCHANGE AVAILABLE?

You may exchange the product in all countries where the product is officially distributed by Philips. In countries where Philips does not distribute the product, the local Philips service organization will attempt to provide a replacement product (although there may be a delay if the appropriate product is not readily available).

BEFORE REQUESTING EXCHANGE...

Please check your owner's manual for assistance. If you have additional questions, call us at 1-800-531-0039.

EXCHANGING A PRODUCT IN U.S.A., PUERTO RICO, OR U.S. VIRGIN ISLANDS...

Contact 1-800-531-0039 to arrange an exchange. Or, ship the product, insured and freight prepaid, and with proof of purchase enclosed, to the address listed below.

Philips Exchange Program
Suite A
406 North Irish Street
Greenville TN 37745

(In U.S.A., Puerto Rico, and U.S. Virgin Islands, all implied warranties, including implied warranties of merchantability and fitness for a particular purpose, are limited in duration to the duration of this express warranty. But, because some states do not allow limitations on how long an implied warranty may last, this limitation may not apply to you.)

EXCHANGING A PRODUCT IN CANADA...

Please contact Philips at:

1-800-661-6162 (French Speaking)
1-800-531-0039 (English or Spanish Speaking)

(In Canada, this warranty is given in lieu of all other warranties. No other warranties are expressed or implied, including any implied warranties of merchantability or fitness for a particular purpose. Philips is not liable under any circumstances for any direct, indirect, special, incidental or consequential damages, howsoever incurred, even if notified of the possibility of such damages.)

REMEMBER...

Please record below the model and serial numbers found on the product. Also, please fill out and mail your warranty registration card promptly. It will be easier for us to notify you if necessary.

MODEL # _____

SERIAL # _____

Philips, P.O. Box 520890, Miami,
FL 33152, USA, (402) 536-4171

This warranty gives you specific legal rights. You may have other rights which vary from state/province to state/province.

EL4967E007 / 8-02

Controls (see figure 1)

- 1 LINE OUT/.....3.5 mm headphone socket, socket to connect the player to another audio input of an additional appliance
- 2 <<<.....skips and searches CD tracks backwards
- 3 ■.....stops CD play, clears a program or switches the player off
- 4 >>>.....skips and searches CD tracks forwards
- 5 ▶||.....switches the player on, starts or pauses CD play
- 6 PROG.....programs tracks and reviews the program
- 7 MODE.....selects the different playing possibilities: **shuffle**, **shuffle repeat all**, **repeat**, **repeat all** and *S C R R*
- 8display
- 9 DBB.....switches the bass enhancement on and off. This button also switches acoustic feedback (the beep) on/off when it is pressed for more than 2 seconds
- 10 VOL **-/+**.....adjusts the volume
- 11 4.5V DC.....socket for external power supply
- 12 OPEN ▶.....opens the CD lid
- 13 ESP ON / POWER SAVE.....to select between the battery powersave mode and **Electronic Skip Protection (ESP)**. ESP ensures continuous CD playback regardless of vibrations and shocks
- 14 OFF.....switches RESUME and HOLD off
RESUME.....stores the last position of a CD track played
HOLD.....locks all buttons
- 15typeplate
- 16battery compartment
- 17AAA battery door

Batteries (supplied or optionally available)

For convenience, this model is designed with 2 different detachable battery doors. This allows you to operate the player using 2 choices of battery size. You can use the following batteries with this CD-player:

- alkaline batteries type **AAA (LR03, UM4)** or **AA (LR6, UM3)** preferably Philips.

Notes:— *Old and new or different types of batteries should not be combined.*
— *Remove batteries if they are empty or if the player is not going to be used for a long time.*

Inserting AAA (LR03, UM4) or AY 3363 batteries

- 1 Open the **AAA** battery door.
- 2 Insert **AAA** batteries as shown onto the back of the door.
- 3 Replace the battery-loaded **AAA** door back onto the set.



AAA (LR03, UM4)

Inserting AA (LR6, UM3) batteries

To double playback time, insert **AA** batteries into the battery compartment and use the **AA** marked battery door.

- Open the battery compartment and insert either 2 normal or alkaline batteries.

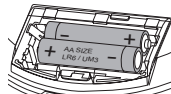

AA (LR6, UM3)

Battery indication

The approximate power level of your batteries is shown in the display.

■ Battery full

■ Battery two-thirds full

■ Battery one-third full

■ Battery dead or empty. When the batteries are dead or empty, the symbol ■ flashes, *b A L L* is displayed, and the beep tone sounds repeatedly.



Average playing time of batteries under normal conditions

Battery type	ESP on	Power Save
Alkaline AA	15 hours	20 hours
Alkaline AAA	7 hours	9 hours
Rechargeable ECO-PLUS NiMH battery	3 hours	5 hours

Batteries contain chemical substances, so they should be disposed of properly.

ECO-PLUS NiMH battery information (for versions supplied with the rechargeable ECO-PLUS NiMH battery AY 3363)

Recharging works only on players supplied with the rechargeable ECO-PLUS NiMH battery AY 3363.

Recharging the ECO-PLUS NiMH battery on board

- 1 Insert the rechargeable ECO-PLUS NiMH battery AY 3363.

- 2 Connect the mains adapter to the 4.5V DC socket of the player and then to the wall socket.

→ ■ is pulsing.

- Recharging stops after a maximum of 7 hours, or when you start playback.

- 3 When the battery is fully recharged, *F U L L* appears in the display.



Notes:— *It is normal for the batteries to become warm during recharging.*

— *If the batteries become too warm, recharging will be interrupted for approximately 30 minutes.*

— *To ensure proper recharging on board, take care that contacts are clean.*

— *Use only the ECO-PLUS NiMH battery AY 3363.*

Handling instructions

- Recharging already charged or half-charged batteries will shorten their lifetime. We therefore recommend that you let the rechargeable ECO-PLUS NiMH battery run till it is completely empty before you recharge it.
- To avoid a short circuit, do not let the battery touch any metal object.
- If the battery becomes empty soon after recharging, then either its contacts are dirty or it has reached the end of its lifetime.

Mains adapter (supplied or optionally available)

Use only the AY 3170 adapter (4.5 V / 300 mA direct current, positive pole to the center pin). Any other product may damage the player.

- 1 Make sure the local voltage corresponds to the power adapter's voltage.

- 2 Connect the power adapter to the 4.5V DC socket of the player and to the wall socket.

Note: *Always disconnect the adapter when you are not using it.*

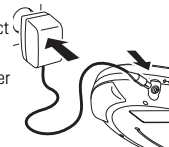

Environmental information

- All redundant packing material has been omitted. We have done our utmost to make the packaging easily separable into two mono materials: cardboard (box) and polyethylene (bags, protective foam sheet).
- Your set consists of materials which can be recycled if disassembled by a specialized company. Please observe the local regulations regarding the disposal of packing materials, exhausted batteries and old equipment.

GENERAL INFORMATION

CD player and CD handling

- Do not touch the lens (A) of the CD player.
- Do not expose the unit, batteries or CDs to humidity, rain, sand or excessive heat (caused by heating equipment or direct sunlight).
- You can clean the CD player with a soft, slightly dampened, lint-free cloth. Do not use any cleaning agents as they may have a corrosive effect.
- To clean the CD, wipe it in a straight line from the center toward the edge using a soft, lint-free cloth. A cleaning agent may damage the disc! Never write on a CD or attach a sticker to it.
- The lens may cloud over when the unit is moved suddenly from cold to warm surroundings. Playing a CD is not possible then. Leave the CD player in a warm environment until the moisture has evaporated.
- Active mobile phones in the vicinity of the CD player may cause malfunctions.
- Avoid dropping the unit as this may cause damage.

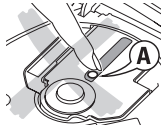

Headphones HE225

- Connect the supplied headphones to the LINE OUT/ear socket of the player.

Note: LINE OUT/ear can also be used for connecting this set to your HiFi system. To adjust the sound and volume, use the controls on the connected audio equipment and on the CD player.

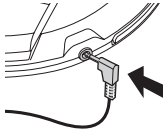

IMPORTANT!

Hearing safety: Do not play your headphones at a high volume. Hearing experts advise that continuous use at high volume can permanently damage your hearing.

Traffic safety: Do not use headphones while driving a vehicle. It may create a hazard and it is illegal in many countries. Even if your headphones are an open-air type designed to let you hear outside sounds, do not turn up the volume so high that you cannot hear what is going on around you.

In-car use (connections supplied or optionally available)

Only use the AY 3545 or AY 3548 car voltage converter (4.5 V DC, positive pole to the centre pin) and the AY 3501 car cassette adapter. Any other product may damage the set.

- Put the set on a horizontal, vibration-free and stable surface. Make sure it is in a safe place, where the set is neither a danger nor an obstacle to the driver and the passengers.
- Plug the voltage converter into the cigarette lighter socket (**only for 12 V car battery, negative grounding**), then connect the wired end with 4.5V DC input socket on the set.
- If necessary, clean the cigarette lighter socket to obtain a good electrical contact.
- Turn down the volume and connect the cassette adapter plug to LINE OUT/ear on the set.
- Carefully insert the cassette adapter into the car radio's cassette compartment.
- Make sure the cord does not hinder your driving.
- Decrease the volume on the set if necessary. Start playback on the set and adjust the sound with the car radio controls.

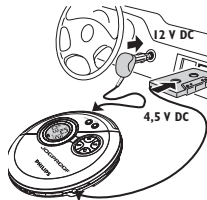

- **Always remove the voltage converter from the cigarette lighter socket when the set is not in use.**

Note: If your car radio has a LINE IN socket, it is better to use it for the car radio connection instead of the adapter cassette. Connect the signal lead to this LINE IN socket and to LINE OUT/ear on the set.

CD PLAY

Playing a CD

This CD-player can play all kinds of **Audio Discs** such as CD-Recordables and CD-Rewritables. Do not try to play a CD-ROM, CDi, VCD, DVD, MP3-CD or computer CD.

- Push the OPEN ► slider to open the player.
- Insert an audio CD, printed side up, by pressing the CD onto the hub.
- Close the player by pressing the lid down.
- Press ►|| to switch the player on and start playback.
 - The current track number and elapsed playing time are displayed.

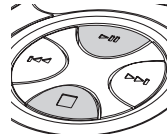
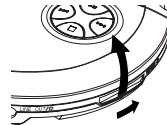

- You can pause playback by pressing ►||.
 - The time at which playback was paused starts flashing.
 - You can continue playback by pressing ►|| again.
- Press ■ to stop playback.
 - The total number of tracks and the total playing time of the CD are displayed.



- Press ■ again to switch the player off.

- To remove the CD, hold it by its edge and press the hub gently while lifting the CD.

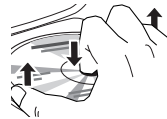

Note: If there is no activity, the set will automatically switch off after a while to save energy.

Playback information

- If a CD-Recordable (CD-R) or a CD-Rewritable (CD-RW) is not recorded properly, **RF d 15 C** is displayed, indicating that the CD has not been finalized. In that case, use FINALIZE on your CD recorder to complete the recording.
- When playing a CD-Rewritable (CD-RW), please note that it takes 3–15 seconds after pressing ►|| for sound reproduction to start.
- Playback will stop if you open the CD lid.
- While the CD is read, **:-:-** flashes in the display.



Volume and bass

Volume adjustment

- Adjust the volume by using VOL -/+ on the CD player or the slider on the headphone cord.

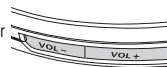

Bass adjustment

- Press DBB to switch the bass enhancement on or off.
 - **DBB** is shown if the bass enhancement is activated.

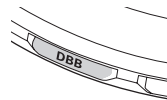

FEATURES

Selecting a track and searching

Selecting a track during playback

- Briefly press ◀◀ or ▶▶ once or several times to skip to the current, previous or next track.
 - ▶ Playback continues with the selected track, and the track's number is displayed.

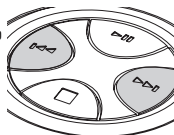

Selecting a track when playback is stopped

- Briefly press ◀◀ or ▶▶ once or several times to select the desired track. The track number is displayed.

- Press ▶|| to start CD play.
 - ▶ Playback starts with the selected track.

Searching for a passage during playback

- Keep ◀◀ or ▶▶ pressed to find a particular passage in a backward or forward direction.
 - ▶ Searching starts while playback continues at low volume. After 2 seconds the search speeds up.
- Release the button when you reach the desired passage.
 - ▶ Playback continues from this position.

Notes: – If the player is in SCAN mode (see MODE chapter), searching is not possible.

FEATURES

Selecting different playing possibilities–MODE

It is possible to play tracks in random order, to repeat a single track or the entire CD, and to play the first few seconds of each track.

- Press MODE during playback as often as required in order to activate one of the following 'modes'. The active mode is shown in the display.
 - ▶ **shuffle**: All tracks of the CD are played in random order until all of them have been played once.
 - ▶ **shuffle repeat all**: All tracks of the CD are played repeatedly in random order.
 - ▶ **repeat**: The current track is played repeatedly.
 - ▶ **repeat all**: The entire CD is played repeatedly.
 - ▶ **SCAN**: The first 10 seconds of each of the remaining tracks are played in sequence.

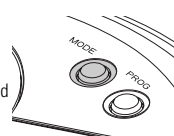

- Playback starts in the chosen mode after 2 seconds.
 - To return to normal playback, press MODE repeatedly until the display shows no active modes.

ESP / Power Save Mode

With a conventional portable CD-player you might have experienced that the music stopped e.g. when you were jogging. The **ELECTRONIC SKIP PROTECTION** prevents loss of sound caused by light vibrations and shocks. Continuous playback is ensured. However ESP does not prevent playback interruptions during vigorous running. It also does not protect the unit against any **damage** caused by **dropping!**

- Switch the slider to ESP ON during playback to activate the shock protection.
 - ▶ ESP is shown and the protection is activated.
- To deactivate the shock protection and enter the power save mode, switch the slider to POWER SAVE.
 - ▶ ESP goes off.

Programming track numbers

You can store up to 30 tracks to play in a program. A single track may be stored more than once in the program.

- While playback is stopped, select a track with ◀◀ or ▶▶.
- Press PROG to store the track.
 - ▶ **program** lights up; the track number programmed and P with the total number of stored tracks are displayed.
- Select and store all desired tracks in this way.
- Press ▶|| to start playback of your selected tracks.
 - ▶ **program** is shown and playback starts.

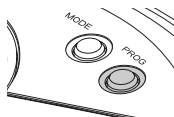

- You can review the program by pressing PROG for more than 2 seconds. The display shows all the stored tracks in sequence.
 - ▶ Display P 0 3 if no tracks programmed.

Notes: – If you press PROG and there is no track selected or no tracks programmed, 5 E L or P 0 3 is displayed.
– If you try to store more than 30 tracks, F U L L is displayed.

Clearing the program

- While playback is stopped, press ■ to clear program.
 - ▶ C L F is displayed once, **program** goes off, and the program is cleared.



Note: The program will also be cleared if the power supply is interrupted, or if the CD-player lid is opened, or if the set switches off automatically.

RESUME and HOLD

You can interrupt playback and continue (even after an extended period of time) from the position where playback stopped (RESUME) and you can lock all buttons of the set so that no action will be executed (HOLD). Use the OFF–RESUME–HOLD slider for these functions.



RESUME – continuing from where you have stopped

- Switch the slider to RESUME during playback to activate RESUME.
 - ▶ **resume** is shown.
 - Press ■ whenever you want to stop playback.
 - Press ▶|| whenever you want to resume playback.
 - ▶ **resume** is shown and playback continues from where you have stopped.
- To deactivate RESUME, switch the slider to OFF.
 - ▶ **resume** goes off.



HOLD – locking all buttons

You can lock the buttons of the set by switching the slider to HOLD. Now, when a key is pressed, no action will be executed. This is of use, for example, when transporting the player in a bag. With HOLD activated, you can avoid accidental activation of other functions.

- Switch the slider to HOLD to activate HOLD.
 - ▶ All buttons are locked H o L d is shown when you press any button. If the set is switched off, H o L d will be shown only when ▶|| is pressed.



- To deactivate HOLD, switch the slider to OFF.

Note: If you deactivate HOLD by switching the slider to RESUME, you will be activating the RESUME function.

TROUBLESHOOTING

Troubleshooting

WARNING: Under no circumstances should you try to repair the set yourself as this will invalidate the warranty. If a fault occurs, first check the points listed, before taking the unit for repair. If you are unable to solve a problem by following these hints, consult your dealer or service center.

The CD player has no power, or playback does not start

- Check that your batteries are not dead or empty, that they are inserted correctly, that the contact pins are clean.
- Your adapter connection may be loose. Connect it securely.
- For *in-car use*, check that the car ignition is on. Also check player's batteries.

The indication *NO* or *ISC* is displayed

- Check that the CD is clean and correctly inserted (label-side upward).
- If your lens has steamed up, wait a few minutes for this to clear.

The indication *RF* or *ISC* is displayed

- CD-RW (CD-R) was not recorded properly. Use FINALIZE on your CD-recorder.

The indication **HOLD** is on and/or there is no reaction to controls

- If HOLD is activated, then deactivate it.
- Electrostatic discharge. Disconnect power or remove batteries for a few seconds.

The CD skips tracks

- The CD is damaged or dirty. Replace or clean the CD.
- resume, shuffle or program is active. Switch off whichever is on.

Troubleshooting

No sound or bad sound quality.

- PAUSE might be active. Press **II**.
- Loose, wrong or dirty connections. Check and clean connections.
- Volume might not be appropriately adjusted. Adjust the volume on the CD player or slider on your remote control.
- Strong magnetic fields. Check player's position and connections. Also keep away from active mobile phones.
- For *in-car use*, check that the cassette adapter is inserted correctly, that the car cassette player's playback direction is correct (press autoreverse to change), and that the cigarette lighter jack is clean. Allow time for temperature change.

CAUTION

Use of controls or adjustments or performance of procedures other than herein may result in hazardous radiation exposure or other unsafe operation.

Return your Warranty Registration card today to ensure you receive all the benefits you're entitled to.

• Once your Philips purchase is registered, you're eligible to receive all the privileges of owning a Philips product.

• So complete and return the Warranty Registration Card enclosed with your purchase at once, and take advantage of these important benefits.

Warranty Verification	Owner Confirmation	Model Registration
Registering your product within 10 days confirms your right to maximum protection under the terms and conditions of your Philips warranty.	Your completed Warranty Registration Card serves as verification of ownership in the event of product theft or loss.	Returning your Warranty Registration Card right away guarantees you'll receive all the information and special offers which you qualify for as the owner of your model.

Know these safety symbols



This "bolt of lightning" indicates uninsulated material within your unit may cause an electrical shock. For the safety of everyone in your household, please do not remove product covering.

The "exclamation point" calls attention to features for which you should read the enclosed literature closely to prevent operating and maintenance problems.

For Customer Use

Enter below the Serial No. which is located on the rear of the cabinet. Retain this information for future reference.

Model No. _____

Serial No. _____

WARNING: TO PREVENT FIRE OR SHOCK HAZARD, DO NOT EXPOSE THIS EQUIPMENT TO RAIN OR MOISTURE.

APPARATUS SHALL NOT BE EXPOSED TO DRIPPING OR SPLASHING.

DO NOT PLACE ANY SOURCES OF DANGER ON THE APPARATUS (e.g. liquid filled objects, lighted candles).

MACS097

El aparato cumple las normas FCC, Parte 15 y 21 CFR 1040.10. Funcionamiento dependiente de dos condiciones siguientes:

1. *Este aparato no puede provocar interferencia dañina, y*
2. *Este aparato debe aceptar cualquier interferencia recibida, incluyendo las interferencias que pueden provocar un funcionamiento insuficiente.*

CAUTION

Use of controls or adjustments or performance of procedures other than herein may result in hazardous radiation exposure or other unsafe operation.

Canada

English: This digital apparatus does not exceed the Class B limits for radio noise emissions from digital apparatus as set out in the Radio Interference Regulations of the Canadian Department of Communications.

Français : Cet appareil numérique n'émet pas de bruits radioélectriques dépassant les limites applicables aux appareils numériques de Classe B prescrites dans le Règlement sur le Brouillage Radioélectrique édicté par le Ministère des Communications du Canada.

Free Manuals Download Website

<http://myh66.com>

<http://usermanuals.us>

<http://www.somanuals.com>

<http://www.4manuals.cc>

<http://www.manual-lib.com>

<http://www.404manual.com>

<http://www.luxmanual.com>

<http://aubethermostatmanual.com>

Golf course search by state

<http://golfingnear.com>

Email search by domain

<http://emailbydomain.com>

Auto manuals search

<http://auto.somanuals.com>

TV manuals search

<http://tv.somanuals.com>