

Portable CD Player

AX5002

AX5003

AX5004



Let's make things better.



PHILIPS
The Power of Music

Es necesario que lea cuidadosamente su instructivo de manejo.



Descripción:	Tocadiscos de CD portatil
Modelo:	AX 5002/01, /11, /16, AX 5003/01, /11, /16, AX 5004/01, /11, /16
Alimentación:	110-127/220-240 V~ 50-60 Hz
Consumo:	4 W (AY 3170)
Importador:	Philips Mexicana, S.A. de C.V.
Domicilio:	Norte 45, # 669, Col. Industrial Vallejo
Localidad y Telefono:	C.P. 02300 México D.F., Tel. 5728 4200
Exportador:	Philips Electronics Hong Kong, Ltd.
País de Origen:	China

Nº de Serie: _____

**LEA CUIDADOSAMENTE ESTE INSTRUCTIVO
ANTES DE USAR SU APARATO.**

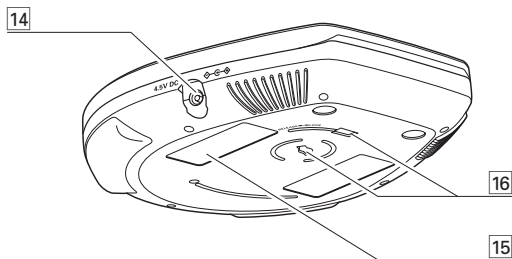
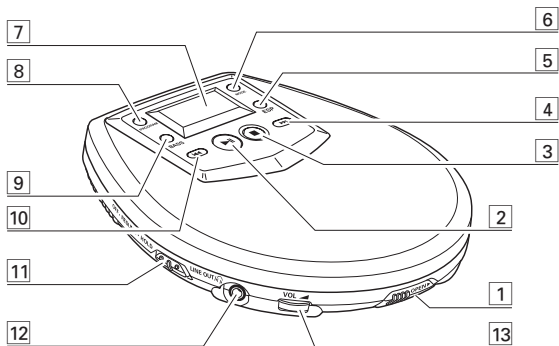

English

Controls	6	CD play	12–13
Quick start	7	Features	14–18
Power supply	8–10	In-car connection	19
General information	10–11	Troubleshooting	20–21

English

Français

Commandes	22	Lecture CD	28–29
Mise en service rapide	23	Caractéristiques	30–34
Alimentation électrique	24–26	Raccordement en voiture	35
Informations générales	26–27	Pannes et remèdes	36–37

Français

Español

Controles	38	Reproducción de un CD	44–45
Encendido rápido	39	Características	46–50
Alimentación eléctrica	40–42	Conexión al automóvil	51
Información general	42–43	Localización de averías	52–53

Español

中文

Controls	54	CD play	60–61
Quick start	55	Features	62–66
Power supply	56–58	In-car connection	67
General information	58–59	Troubleshooting	68–69

中文

Guarantees

Polizia de garanția

Mexico70–71

Philips product warranty for

Australia72–73

Guarantee and service for

New Zealand74

CONTROLS, refer to the illustration on page 3

- 1 OPEN ►.....opens the CD lid
- 2 ►►.....switches the player on, starts or pauses CD play
- 3 ■.....stops CD play, clears a program or switches the player off
- 4 ►►.....skips and searches CD tracks forwards
- 5 ESP.....**ELECTRONIC SKIP PROTECTION** ensures continuous CD playback regardless of vibrations and shocks
- 6 MODE.....selects the different playing possibilities: **SHUFFLE**, **SHUFFLE REPEAT ALL**, **REPEAT**, **REPEAT ALL** and **SCRIP**
- 7display
- 8 PROGRAM.....programs tracks and reviews the program
- 9 BASS.....switches the bass enhancement on and off. This button also switches acoustic feedback (the beep) on/off when it is pressed for more than 2 seconds
- 10 ◀◀.....skips and searches CD tracks backwards
- 11 RESUME.....stores the last position of a CD track played
HOLD.....locks all buttons
OFF.....switches RESUME and HOLD off
- 12 LINE OUT/🔊.....3.5 mm headphone socket, socket to connect the player to another audio input of an additional appliance, remote control socket (not on all versions)
- 13 VOL ◀.....adjusts the volume
- 14 4.5V DC.....socket for external power supply
- 15typeplate
- 16belt clip holder

Remote control (not on all versions)

Use only the Philips AY 3767 cord remote control with your CD-player. The buttons on the remote control have the same functions as the corresponding buttons on the CD-player.

- 1 If necessary, press ■ once or twice until the set is switched off,
- 2 Firmly plug the remote control into the LINE OUT/🔊 socket of the CD-player, and then connect the headphones to the socket of the remote control.
- 3 Turn the volume down with VOL ◀ on the remote control and set VOL ◀ on the CD-player to position 8.

QUICK START

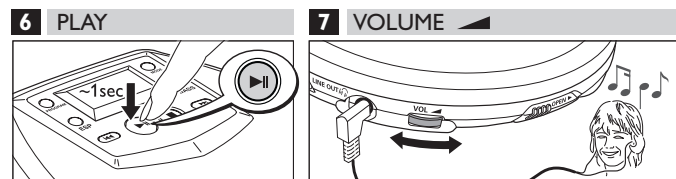
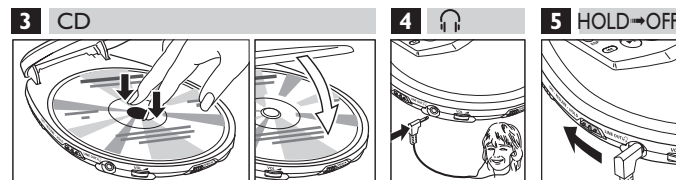
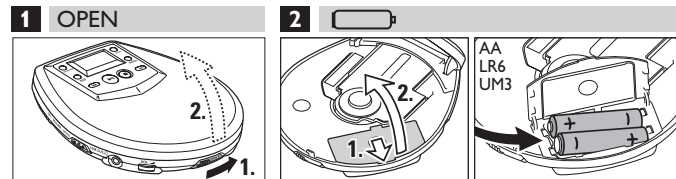

This set complies with the radio interference requirements of the European Community.

POWER SUPPLY

POWER SUPPLY

Batteries (supplied or optionally available)

You can use the following batteries with this CD-player:

- normal batteries type **LR6, UM3** or **AA** (preferably Philips), or
- alkaline batteries type **LR6, UM3** or **AA** (preferably Philips).

Note: – Old and new or different types of batteries should not be used in combination. Remove batteries if they are empty or if the player is not going to be used for a long time.

Inserting batteries

- 1 Push OPEN ► to open the CD lid.
- 2 Open the battery compartment and insert either 2 normal or alkaline batteries, or the rechargeable NiMH battery AY 3362 (if supplied).

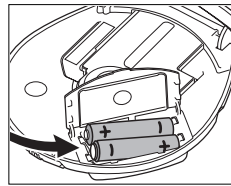

Battery indication

The approximate power level of your batteries is shown in the display.

- Battery full
- Battery two-thirds full
- Battery one-third full
- Battery dead or empty. When the batteries are dead or empty, the symbol flashes, *BAE* is displayed, and the beep tone sounds repeatedly.



Average playing time of batteries under normal conditions

Battery type	ESP on	ESP off
Normal	7 hours	6 hours
Alkaline	22 hours	19 hours
Rechargeable ECO-PLUS NiMH battery	10 hours	9 hours

Batteries contain chemical substances, so they should be disposed of properly.

ECO-PLUS NiMH battery information (for versions supplied with the rechargeable ECO-PLUS NiMH battery AY 3362)

Recharging works only on players supplied with the rechargeable ECO-PLUS NiMH battery AY 3362.

Recharging the ECO-PLUS NiMH battery on board

- 1 Insert the rechargeable ECO-PLUS NiMH battery AY 3362.
- 2 Connect the mains adapter to the 4.5V DC socket of the player and then to the wall socket.
 - is shown and *CHARGE* is displayed for 5 seconds.
- 3 When the battery is fully recharged, and *FULL* appear briefly in the display, before the display switches off.



- Notes: – It is normal for the batteries to become warm during recharging.*
- *If the batteries become too warm, recharging will be interrupted for approximately 30 minutes and *HOLD* is displayed.*
 - *To ensure proper recharging on board, take care that contacts are clean.*
 - *Use only the ECO-PLUS NiMH battery AY 3362.*

Handling instructions

- Recharging already charged or half-charged batteries will shorten their lifetime. We therefore recommend that you let the rechargeable ECO-PLUS NiMH battery run till it is completely empty before you recharge it.
- To avoid a short circuit, do not let the battery touch any metal object.
- If the battery becomes empty soon after recharging, then either its contacts are dirty or it has reached the end of its lifetime.

POWER SUPPLY / GENERAL INFORMATION

Mains adapter (supplied or optionally available)

Use only the AY 3170 adapter (4.5 V/300 mA direct current, positive pole to the centre pin). Any other product may damage the player.

- 1 Make sure that the adapter's voltage corresponds to the local voltage.
- 2 Connect the adapter to the 4.5V DC socket of the player and to the wall socket.

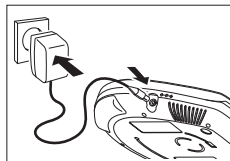

Note: Always disconnect the adapter when you are not using it.

Belt Clip (not on all versions)

- 1 To attach the belt clip to the CD-player, position the shaped grip (found on the back of the belt clip) so that it fits into the belt clip hole of the CD-player.
- 2 Turn the clip to LOCK as indicated on the set.
- 3 To detach, gently lift the belt clip and turn to RELEASE as indicated on the set.

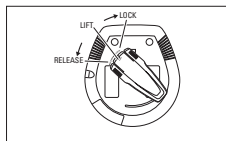
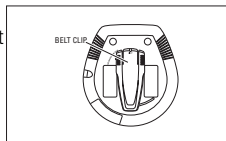

Environmental information

- All redundant packing material has been omitted. We have done our utmost to make the packaging easily separable into two mono materials: cardboard (box) and polyethylene (bags, protective foam sheet).
- Your set consists of materials which can be recycled if disassembled by a specialized company. Please observe the local regulations regarding the disposal of packing materials, exhausted batteries and old equipment.

GENERAL INFORMATION

CD-player and CD handling

- Do not touch the lens (A) of the CD-player.
- Do not expose the set, batteries or CDs to humidity, rain, sand or excessive heat (caused by heating equipment or direct sunlight).
- You can clean the CD-player with a soft, slightly dampened, lint-free cloth. Do not use any cleaning agents as they may have a corrosive effect.
- To clean the CD, wipe it in a straight line from the centre towards the edge using a soft, lint-free cloth. A cleaning agent may damage the disc! Never write on a CD or attach a sticker to it.
- The lens may cloud over when the set is moved suddenly from cold to warm surroundings. Playing a CD is not possible then. Leave the CD-player in a warm environment until the moisture has evaporated.
- Active mobile phones in the vicinity of the CD-player may cause malfunctions.
- Avoid dropping the set as this may cause damage.

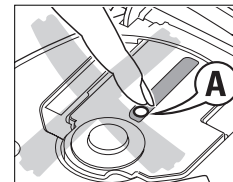

Headphones HE 545

- Connect the supplied headphones to the LINE OUT/ear socket of the player.

Note: LINE OUT/ear can also be used for connecting the player to your HiFi system (with a signal lead) or to your car radio (with a cassette adapter or signal lead). In both cases, the volume of the player must be set to position 8.

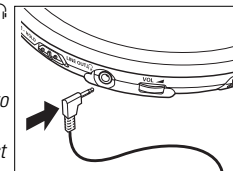

Use your head when using headphones

Hearing safety: Do not play your headphones at a high volume. Hearing experts advise that continuous use at high volume can permanently damage your hearing.

Traffic safety: Do not use headphones while driving a vehicle. It may create a hazard and it is illegal in many countries. Even if your headphones are an open-air type designed to let you hear outside sounds, do not turn up the volume so high that you cannot hear what is going on around you.

Playing a CD

This CD-player can play all kinds of **Audio Discs** such as CD-Recordables and CD-Rewritables. Do not try to play a CD-ROM, CDi, VCD, DVD or computer CD.

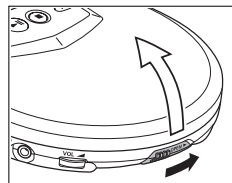

1 Push the OPEN ► slider to open the player.

2 Insert an audio CD, printed side up, by pressing the CD onto the hub.

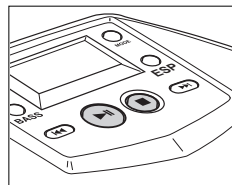

3 Close the player by pressing the lid down.

4 Press ►► to switch the player on and start playback.
→ The current track number and elapsed playing time are displayed.



• You can pause playback by pressing ►◄.

→ The time at which playback was paused starts flashing.

• You can continue playback by pressing ►► again.

5 Press ■ to stop playback.

→ The total number of tracks and the total playing time of the CD are displayed.



6 Press ■ again to switch the player off.

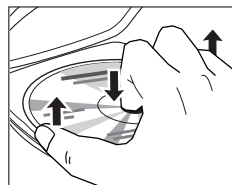

• To remove the CD, hold it by its edge and press the hub gently while lifting the CD.

Note: If there is no activity, the set will automatically switch off after a while to save energy.

Playback information

- If a CD-Recordable (CD-R) or a CD-Rewritable (CD-RW) is not recorded properly, *no F d 15 C* is displayed, indicating that the CD has not been finalized. In that case, use FINALIZE on your CD recorder to complete the recording.
- When playing a CD-Rewritable (CD-RW), please note that it takes 3–15 seconds after pressing ►► for sound reproduction to start.
- Playback will stop if you open the CD lid.
- While the CD is read, *1 - 1 -* flashes in the display.

Volume and bass

Volume adjustment

- Adjust the volume by using VOL ◀▶.

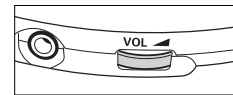

Bass adjustment

You can choose between the bass enhancement levels *dbb 1* and *dbb 2*.

1 Press BASS once for *dbb 1* and twice for *dbb 2*.

→ *dbb 1* or *dbb 2* is displayed and **DBB** is shown.

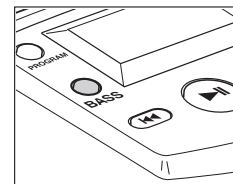

2 To switch *dbb 1* or *dbb 2* off, press BASS twice or once, respectively.

→ **DBB** goes off.



Selecting a track and searching

Selecting a track during playback

- Briefly press ◀◀ or ▶▶ once or several times to skip to the current, previous or next track.
 - ▶ Playback continues with the selected track, and the track's number is displayed.

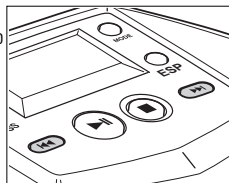

Selecting a track when playback is stopped

- Briefly press ◀◀ or ▶▶ once or several times to select the desired track. The track number is displayed.
- Press ▶▶ to start CD play.
 - ▶ Playback starts with the selected track.

Searching for a passage during playback

- Keep ◀◀ or ▶▶ pressed to find a particular passage in a backward or forward direction.
 - ▶ Searching starts while playback continues at low volume. After 2 seconds the search speeds up.
- Release the button when you reach the desired passage.
 - ▶ Playback continues from this position.

Notes: – If the player is in SCAN mode (see MODE chapter), searching is not possible.
 – In SHUFFLE, SHUFFLE REPEAT ALL or REPEAT mode (see MODE chapter), or while playing a program, searching is only possible within the particular track.

Programming track numbers

You can store up to 30 tracks to play in a program. A single track may be stored more than once in the program.

- While playback is stopped, select a track with ◀◀ or ▶▶.
- Press PROGRAM to store the track.
 - ▶ PROGRAM lights up; the track number programmed and P with the total number of stored tracks are displayed.
- Select and store all desired tracks in this way.
- Press ▶▶ to start playback of your selected tracks.
 - ▶ PROGRAM is shown and playback starts.

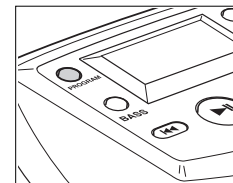

- You can review the program by pressing PROGRAM for more than 2 seconds.
 - ▶ The display shows all the stored tracks in sequence.

Notes: – If you press PROGRAM and there is no track selected, 5 5 5 5 is displayed.
 – If you try to store more than 30 tracks, F U L L is displayed.

Clearing the program

- While playback is stopped, press ■ to clear program.
 - ▶ CLEAR is displayed once, PROGRAM goes off, and the program is cleared.



Note: The program will also be cleared if the power supply is interrupted, or if the CD-player lid is opened, or if the set switches off automatically.

Selecting different playing possibilities – MODE

It is possible to play tracks in random order, to repeat a single track or the entire CD, and to play the first few seconds of each track.

- 1 Press MODE during playback as often as required in order to activate one of the following 'modes'. The active mode is shown in the display.
 - **SHUFFLE**: All tracks of the CD are played in random order until all of them have been played once.
 - **SHUFFLE REPEAT ALL**: All tracks of the CD are played repeatedly in random order.
 - **REPEAT**: The current track is played repeatedly.
 - **REPEAT ALL**: The entire CD is played repeatedly.
 - **SCAN**: The first 10 seconds of each of the remaining tracks are played in sequence.

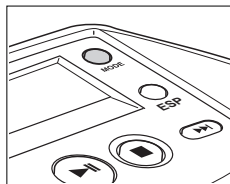

- 2 Playback starts in the chosen mode after 2 seconds.
 - To return to normal playback, press MODE repeatedly until the display shows no active modes.

RESUME and HOLD

You can interrupt playback and continue (even after an extended period of time) from the position where playback stopped (RESUME) and you can lock all buttons of the set so that no action will be executed (HOLD). Use the RESUME–HOLD–OFF slider for these functions.

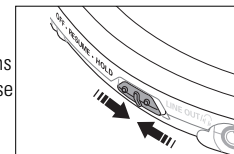

RESUME – continuing from where you have stopped

- 1 Switch the slider to RESUME during playback to activate RESUME.
 - RESUME is shown.
- 2 Press ■ whenever you want to stop playback.
- 3 Press ►|| whenever you want to resume playback.
 - RESUME is shown and playback continues from where you have stopped.



- To deactivate RESUME, switch the slider to OFF.
 - RESUME goes off.

HOLD – locking all buttons

You can lock the buttons of the set by switching the slider to HOLD. Now, when a key is pressed, no action will be executed. This is of use, for example, when transporting the player in a bag. With HOLD activated, you can avoid accidental activation of other functions.

- 1 Switch the slider to HOLD to activate HOLD.
 - All buttons are locked. **HOLD** is shown when you press any button. If the set is switched off, **HOLD** will be shown only when ►|| is pressed.
- 2 To deactivate HOLD, switch the slider to OFF.

Note: If you deactivate HOLD by switching the slider to RESUME, you will be activating the RESUME function.



FEATURES

ESP

Conventional portable CD-players subjected to a shock or vibration during playback often skip parts of the CD. The **ELECTRONIC SKIP PROTECTION (ESP)** feature, with which your set is equipped, however, prevents such loss of continuity when your player is subjected to light vibrations. But ESP does not prevent playback interruptions caused by vigorous exercise. Nor does it protect against damage resulting from the player being dropped!

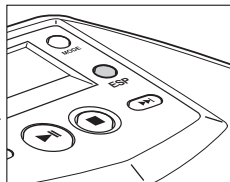

- Press ESP during playback to activate the skip protection.
→ **ESP** is shown and the protection is activated.
- To deactivate the skip protection, press ESP again.
→ **ESP** goes off and the protection is deactivated.



Pouch AY 3266 (supplied or optionally available)

The pouch enables you to conveniently carry the CD-player so you can listen to music while exercising.

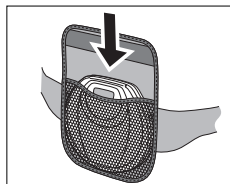

- 1 Make sure ESP is activated.
- 2 Fasten the pouch belt tightly around your waist.
- 3 Put the CD-player into the pouch with the keys facing away from your body, and close the flap.

Notes: – While exercising, take care that the CD-player is not hit by a limb or other object, such as a branch or post.

- Do not use the pouch if you are suffering from a skin irritation.
- Do not machine-wash the pouch as it could lose shape or colour.

IN-CAR CONNECTION

In-car use (connections supplied or optionally available)

Only use the AY 3545 car voltage converter (4.5V, DC, positive pole to the centre pin) and the AY 3501 car cassette adapter. Any other product may damage the set.

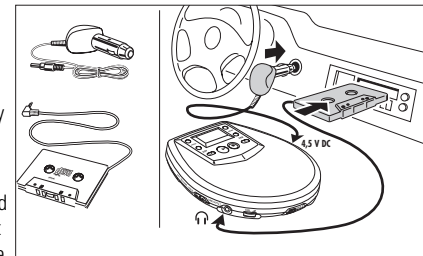

- 1 Put the CD-player on a horizontal, vibration-free and stable surface. Make sure it is in a safe place, where the player is neither a danger nor obstacle to either driver or passenger.
 - 2 Connect the DC plug of the voltage converter to the 4.5V DC socket of the CD-player (**only for a 12 V car battery, negative grounding**).
 - 3 Insert the voltage converter into the cigarette lighter socket. If necessary, clean the cigarette lighter socket to obtain a good electrical contact.
 - 4 Turn down the volume and connect the cassette adapter plug to the LINE OUT/🔊 socket of the CD player.
 - 5 Carefully insert the cassette adapter into the car radio's cassette compartment.
 - 6 Make sure the cord does not hinder your driving.
 - 7 Start the CD-player, set VOL ◀ to position 8 and adjust the sound with the car radio controls.
- Always remove the voltage converter from the cigarette lighter socket when the CD-player is not in use.

Note: – Avoid excessive heat from the car heating or from direct sunlight (e.g. in a parked car in the summer).
– If your car radio has a **LINE IN** socket, it is better to use this instead of the cassette adapter. Simply connect a signal lead from the **LINE OUT/🔊** socket of the CD-player to this **LINE IN** socket.

WARNING

Under no circumstances should you try to repair the set yourself as this will invalidate the guarantee.

Problem	Possible cause	Solution
No power, playback does not start	Batteries	
	Batteries inserted incorrectly	Insert the batteries correctly.
	Batteries are empty.	Change the batteries.
	Contact pins are dirty.	Clean them with a cloth.
	Mains adapter	
	Loose connection	Connect the adapter securely.
	In-car use	
	Cigarette lighter is not powered when ignition is off.	Switch on ignition or insert batteries.
RF indication	CD-RW (CD-R) is not recorded properly.	Use FINALIZE on the CD recorder to complete the recording.
no disc indication	The CD is badly scratched or dirty.	Replace or clean the CD.
	CD is not or incorrectly inserted.	Insert a CD, label upwards.
	The laser lens is steamed up.	Wait until the lens has cleared.
HOLD indication and/or no reaction to controls	HOLD is activated.	Deactivate HOLD.
	Electrostatic discharge	Disconnect the set from power supply or take out the batteries for a few seconds.

If a fault occurs, first check the points listed, before taking the set for repair. If you are unable to solve a problem by following these hints, consult your dealer or service centre.

Problem	Possible cause	Solution
The CD skips tracks.	The CD is damaged or dirty.	Replace or clean the CD.
	RESUME, SHUFFLE or PROGRAM is active.	Switch RESUME, SHUFFLE or PROGRAM off.
No sound or bad sound quality	PAUSE is activated.	Press ▶ .
	Loose, wrong or dirty connections	Check and clean connections.
	Volume is not adjusted.	Adjust the volume.
	Malfunctions due to nearness of active mobile phones	Keep the player away from active mobile phones.
	Strong magnetic fields near the player	Change the player's position or connections.
	In-car use	
	cassette adapter is inserted incorrectly.	Insert the cassette adapter correctly.
Temperature inside the car is too high/low.	Let the player adjust to the temperature.	
Cigarette lighter socket is dirty.	Clean the cigarette lighter socket.	
Wrong playback direction of the car cassette player's autoreverse feature	Change the autoreverse direction.	

CAUTION

Use of controls or adjustments or performance of procedures other than herein may result in hazardous radiation exposure or other unsafe operation.

Free Manuals Download Website

<http://myh66.com>

<http://usermanuals.us>

<http://www.somanuals.com>

<http://www.4manuals.cc>

<http://www.manual-lib.com>

<http://www.404manual.com>

<http://www.luxmanual.com>

<http://aubethermostatmanual.com>

Golf course search by state

<http://golfingnear.com>

Email search by domain

<http://emailbydomain.com>

Auto manuals search

<http://auto.somanuals.com>

TV manuals search

<http://tv.somanuals.com>