

Register your product and get support at
www.philips.com/welcome

User manual



PHILIPS

CAUTION

Use of controls or adjustments or performance of procedures other than herein may result in unsafe operation.

The type plate is located on the rear of the set.

1

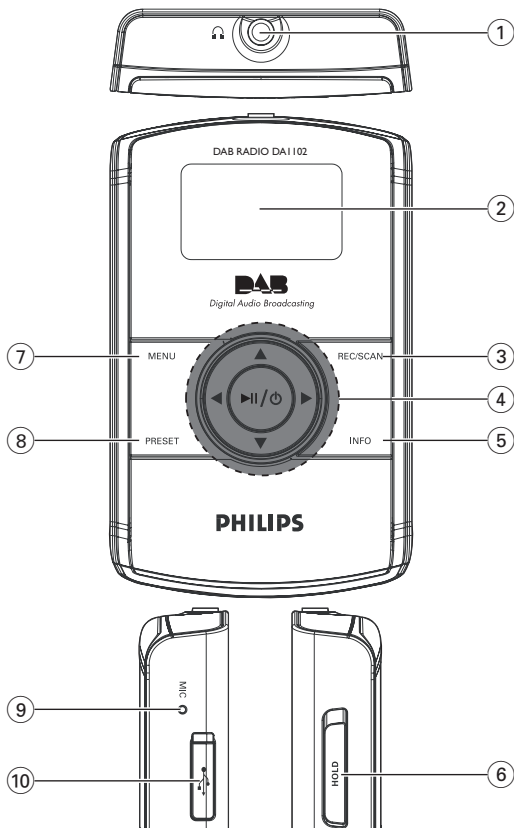

2



A pleine puissance, l'écoute prolongée du baladeur
peut endommager l'oreille de l'utilisateur
Continuous use at full output might damage the ears

1



OPEN

IGB







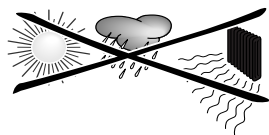

2

3



Controls	6
General Information	
Safety instructions	7
Environmental information	7
Hearing safety	7-8
About Digital Audio Broadcasting (DAB)	9
Getting started	
Power supply	10
Transfer	10
Headphones	11
Adjusting the volume	11
HOLD: Locking buttons	11
DAB radio	
Radio reception	12
Switching off, Tuning/retuning	13
Selecting a station	14
Saving & recalling presets	14
Deleting a preset	15
Viewing the service info (DAB only)	15
Music mode	
Playing stored music	16
Setting play mode	16
Recordings	
Make recordings	17
Play back recordings	17
Upload recordings to PC	17
Delete recordings	17
Settings	18
Technical Specifications	19
Troubleshooting	20

Controls (see Figure 1)

- ① 
- 3.5mm headphone socket.
- ② **Display**
- shows menu, options, track information and station information.
- ③ **REC/SCAN**
- searches and stores DAB stations (Local Scan/Full Scan/Manu Tune).
 - press and hold to record voices in recording mode.
- ④ 
- navigation controls (left, right, up, down) for scrolling through the option lists.
- 
- scrolls radio stations.
- 
- increases / decreases the volume.
- 
- confirms selection.
 - starts playback.
 - press and hold to switch on/off the set.
- ⑤ **INFO** (for DAB only)
- displays station information in seven types.
- ⑥ **HOLD**
- adjusts slider to select lock function on/off.
- ⑦ **MENU**
- enters the main menu or returns to previous menu.
 - enables access to advanced setup options.
- ⑧ **PRESET**
- saves 20 stations for quick access.
- ⑨ **MIC**
- Microphone.
- ⑩ 
- USB jack.

Supplied accessories

- 1 x USB cable
- 2 x AAA batteries
- 1 x headphones

This set complies with the radio interference requirements of the European Union.

PHILIPS reserves the right to make design and specification changes for product improvement without prior notice.

Safety instructions (see Figure 3)

- Do not expose the unit or batteries to humidity, rain, sand or excessive heat (caused by heating equipment or direct sunlight).
- You can clean the radio with a soft, slightly dampened, lint-free cloth. Do not use any cleaning agents as they may have a corrosive effect.
- Active mobile phones in the vicinity of the radio may cause malfunctions.
- Avoid dropping the radio as this may cause damage.
- Apparatus shall not be exposed to dripping or splashing.

Environmental information

- All redundant packing material has been omitted. We have done our utmost to make the packaging easily separable into two mono materials: cardboard and polyethylene.
- Your set consists of materials which can be recycled if disassembled by a specialized company. Please observe the local regulations regarding the disposal of packing materials, exhausted batteries and old equipment.

Hearing Safety

Listen at a moderate volume:

- Using headphones at a high volume can impair your hearing. This product can produce sounds in decibel ranges that may cause hearing loss for a normal person, even for exposure less than a minute. The higher decibel ranges are offered for those that may have already experienced some hearing loss.
- Sound can be deceiving. Over time your hearing “comfort level” adapts to higher volumes of sound. So after prolonged listening, what sounds “normal” can actually be loud and harmful to your hearing. To guard against this, set your volume to a safe level before your hearing adapts and leave it there.

General information

To establish a safe volume level:

- Set your volume control at a low setting.
- Slowly increase the sound until you can hear it comfortably and clearly, without distortion.

Listen for reasonable periods of time:

- Prolonged exposure to sound, even at normally “safe” levels, can also cause hearing loss.
- Be sure to use your equipment reasonably and take appropriate breaks.
Be sure to observe the following guidelines when using your headphones:
- Listen at reasonable volumes for reasonable periods of time.
- Be careful not to adjust the volume as your hearing adapts.
- Do not turn up the volume so high that you can't hear what's around you.
- You should use caution or temporarily discontinue use in potentially hazardous situations.
- Do not use headphones while operating a motorized vehicle, cycling, skateboarding, etc.; it may create a traffic hazard and is illegal in many areas

Disposal of your old product

Your product is designed and manufactured with high quality materials and components, which can be recycled and reused.

When this crossed-out wheeled bin symbol is attached to a product it means the product is covered by the European Directive 2002/96/EC



Please inform yourself about the local separate collection system for electrical and electronic products. Please act according to your local rules and do not dispose of your old products with your normal household waste. The correct disposal of your old product will help prevent potential negative consequences for the environment and human health.

About Digital Audio Broadcasting (DAB)

DAB digital radio is a new way of broadcasting radio via a network of terrestrial transmitters. It provides listeners with more choice and information delivered in crystal clear, crackle-free sound quality.

- The technology allows the receiver to lock on to the strongest signal it can find.
- With DAB digital stations there are no frequencies to remember, and sets are tuned by station name, so there's no retuning on the move.

What is a multiplex?

Digital radio operation is made up of a single block of frequencies called a multiplex. Each multiplex works within a frequency spectrum, such as Band III for DAB broadcasts.



Helpful Hints:

- *You will receive only those stations within your transmission area.*

DAB BROADCASTERS AND DLS

Each DAB broadcaster (or multiplex operator) also provides text and audio data services. Some programmes are supported by Dynamic Label Segments (DLS). This is data which you can read as scrolling text on your DAB radio display. Some stations transmit the latest news, travel, and weather, what's on now and next, website addresses and phone numbers.

For more information on digital radio coverage and services, please visit: www.drdb.org.

Getting started

POWER SUPPLY

Inserting batteries (see Figure 2)

- Open the battery door and insert **2 x AAA** batteries with the correct polarity as indicated.

Battery power level indication



Full



Two-thirds full



Half full



Low



Empty

Batteries contain chemical substances, so they should be disposed of properly.

Please ensure that used batteries are disposed of in accordance with local/national legislation. Do not short circuit. Do not dispose of in a fire.

POWER ON/OFF

Press and hold  to switch on/off the set.

TRANSFER

Your player appears as a USB mass storage device on your computer. You can manage files and transfer music to your player during USB connection.

- 1 Use the supplied USB cable to connect your player to a computer.
- 2 Click and highlight one or more songs to transfer between your player and your computer.
- 3 Use drag and drop actions to complete your transfer.

Disconnect your player safely

Exit any active application working with your player. Remove your player safely by clicking  in the task tray in your PC.

**Helpful Hints :**

- Simply disconnect the player when the animation  stops which means the transfer is complete.

HEADPHONES

- Connect the supplied headphones to the  socket of the player.
- The headphone cable also serves as an aerial. To get optimal signal reception, avoid coiling the headphone cord.

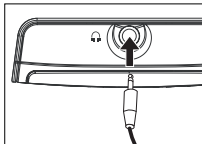
**Adjusting the volume**

- In play mode, press ▲/▼ to adjust the volume.

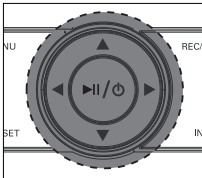
**HOLD: Locking buttons**

You can lock the buttons of the set by switching the slider to LOCK. With Lock activated, you can avoid accidental action of other functions, and help save battery power (accidental switching on).

- 1 Adjust the **HOLD** slider to LOCK to activate.
→ The lock icon is shown.
- 2 To deactivate, switch the **HOLD** slider to UNLOCK.
→ All buttons are unlocked. The unlock icon is shown.





**Helpful Hints :**

- In HOLD mode, all buttons except ▲/▼ are locked.

DAB Radio

RADIO RECEPTION

With this DAB pocket radio, you can tune to DAB radio stations. The headphone cable also serves as an aerial.

- 1 Connect the supplied headphones to the  socket of the player.
- 2 Press and hold  to switch on the set.
→ Display shows the main menu.
- 3 Press  to select the DAB radio mode, and then press .
→ The last detected station plays and the list of available stations is stored.

Helpful Hints :

- If the tuning fails, the display shows **No Available Station**. You can press **REC/SCAN** to select **Local Scan**, **Full Scan** or **Manu Tune** (see **Tuning/retuning**).

TO SWITCH OFF THE RADIO

- Press **MENU** to select another mode.
- Press and hold  for **3 seconds**.
→ Display shows **Bye**
→ The display backlight goes out.

Helpful Hints :

- Activate the HOLD function to save battery power and to prevent switching on the set accidentally.

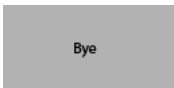
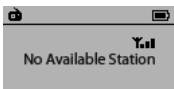
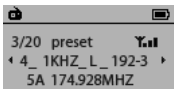

TUNING/ RETUNING

In DAB mode

- 1 Press **REC/SCAN**.
- 2 Press **▲/▼** to select a desired tuning option (Local Scan/Full Scan/Manu Tune).
- 3 Press **▶** or **▶II/⏻** to confirm.

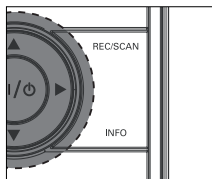

Autoscan

Local scan – scans all the local frequencies.

Full scan – scans the full range of DAB frequencies.

→ Display shows **Scanning** and the scanning progress bar.

→ The number of detected radio stations appears.

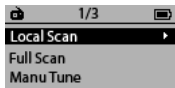

Manual tune

- 1 Press **▲/▼** once or more until you stop in the desired frequency.
- 2 Press **▶II/⏻** to confirm.

DAB Radio

SELECTING A STATION

In DAB mode

After your radio has been tuned, you can select a station using the **navigation control**.

- 1 Press **◀/▶** repeatedly until your desired station name is displayed.
- After successful tuning, the display shows the selected station name, battery level, and signal reception strength.

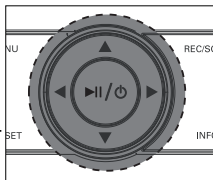

SAVING & RECALLING PRESETS

With stations saved as presets, you can quickly access your desired station after the radio is switched on.

Saving a preset

- 1 During playing a station, press and hold **PRESET**.
- Display shows: **Add preset < X >** (X denotes a preset station number).
- 2 Press **◀/▶** to select a desired preset number.
 - 3 Press **▶||/⏻** to confirm.
- The station is successfully saved.

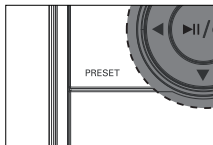

Helpful Hints :

- You can save up to 20 preset radio stations.

RECALLING A PRESET

- 1 Press **PRESET**.
- Display shows: current preset number, current station name, battery level, signal reception strength, and DAB service information.
- 2 Press **◀/▶** once or more to find your desired preset.
- Your desired preset radio station plays.

DELETING A PRESET

- 1 Press **PRESET** to enter the Preset radio station mode.
- 2 Press ◀/▶ once or more to select your desired preset number.
- 3 Press and hold **PRESET**.
→ Display shows: **Delete preset < X >** (X denotes a preset station number).
- 4 Press ▶||/⏻ to confirm.
→ The station is successfully deleted.

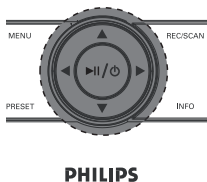

VIEWING THE SERVICE INFO (DAB ONLY)

You can view the DAB service info in the following 7 information types.

- To scroll through the information options, press **INFO** repeatedly until your desired option appears.
- 1 **DLS** Dynamic Label Segments.
 Displays the scrolling broadcasting text (default setting).
 - 2 **Signal error** Displays signal errors.
 - 3 **Bitrate mode** Displays the transmission rate of broadcasting data in bits per second.
 - 4 **Channel & frequency** Displays the channel and frequency of your current service.
 - 5 **Clock** Shows the time of the current multiplex.
 - 6 **Multiplex name** Specifies the multiplex of the current service.
 (A multiplex is a group of stations broadcast by a multiplex operator.)
 - 7 **Program type** Describes content type.

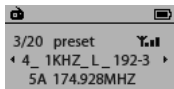

Music mode

PLAYING STORED MUSIC

You can transfer music to the player from your PC (see **TRANSFER**). After successful transfer, you can enjoy the stored music.

- In power-on mode, press **MENU** to enter the main menu.
- Press ◀/▶ once or more to select the Music icon.
- Press ▶II/⏻ to confirm.
 - Display shows the categories of your music library: Play All, Artists, Albums, Playlists.
 - Play All:** plays all tracks.
 - Artists:** collection of albums sorted by artist name in alphanumeric order.
 - Albums:** collection of albums sorted by album name in alphanumeric order.
 - Playlists:** collection of your favorite tracks sorted by the name of the playlists in alphanumeric order.
- Press ▲/▼ to select your option.
- Press ▶ or ▶II/⏻ to start playback.
 - The playback screen appears.
- To pause playback, press ▶II/⏻. To resume playback, press the button again.

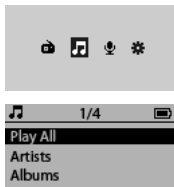

SETTING PLAY MODE

- Press **MENU** and select the settings icon.
- Press ▶II/⏻ to enter the settings menu.
- Press ▲/▼ to select **Play Mode**.
- Press ◀/▶ to select Shuffle/Repeat/Repeat All/OFF.
- Press ▶II/⏻ to confirm.

Icon	Meaning
	Play all songs randomly
	Play one song repeatedly
	Play all songs repeatedly
OFF	Normal playback

MAKE RECORDINGS

- 1 In power-on mode, press **MENU** to enter the main menu.
- 2 Press ◀/▶ once or more to select the recording mode.
- 3 Press ▶II/⏻ to enter the recording mode.
- 4 Press and hold **REC/SCAN** to start voice recording.
- 5 To pause recording, press ▶II/⏻. To resume recording, press the button again.
- 6 To save the recording, press and hold **REC/SCAN** again.



PLAY BACK RECORDINGS

- 1 In the recording mode, press ▲/▼ once or more to select **Play All** or the desired recording file.
 - 2 Press ▶ or ▶II/⏻ to start the playback.
- The playback screen appears.

UPLOAD RECORDINGS TO THE COMPUTER

- 1 Connect your player to your computer.
 - 2 Open the disc folder (your player).
- You will find a **RECORD** folder. This folder contains the recordings.
- 3 Copy and paste the recordings to any desired location on your computer.

DELETE RECORDINGS

Recordings can only be deleted on the computer.

- 1 Connect your player to your computer.
- 2 Open the disc folder (your player).
- 3 Double click the **RECORD** folder.
- 4 Select the files you want to delete and press **Delete** on your computer keyboard.

Settings

You can set your preferences in your player to suit your needs.

- 1 Press **MENU** and select the settings icon.
- 2 Press **▶II/⏻** to enter the settings menu.
- 3 Press **▲/▼** to select your desired option.
- 4 Press **◀/▶** to select your desired settings.
- 5 Press **MENU** to exit.



Settings	Options
EQ	ROCK/JAZZ/CLASSIC/POP/OFF
Play Mode	Shuffle/Repeat/Repeat All/OFF
Contrast	00/10/20/30/40
Backlight	ON/5s Off/10s Off/15s Off/20s Off
Free Cap	Free capacity of the memory
Version	Version information

The making of unauthorized copies of copy-protected material, including computer programmes, files, broadcasts and sound recordings, may be an infringement of copyrights and constitute a criminal offence. This equipment should not be used for such purposes.



Be responsible
Respect copyrights

TECHNICAL SPECIFICATIONS

General	Stereo digital radio (stereo output possible with auxiliary speaker) with full Band III reception capability. Fully compliant with ETS300 401 and capable of decoding all DAB transmission modes 1-4.
Power supply	2 x AAA alkaline.
Compression format	MP3 (8-320 kbps and VBR) /WMA (5-384 kbps)
Audio capturing	Built-in microphone
Storage media	1 GB* Flash memory
Approvals	CE marked. Compliant with the EMC and Low Voltage Directives (89/336/EEC and 73/23/EEC)
Dimensions	59 mm x 95 mm x 17.5 mm
Weight	64g
Battery playtime	up to 10 hours**

* Full memory capacity may not be available as some memory will be reserved for the player.

**Battery life varies by use and settings.

Troubleshooting

Warning: Under no circumstance should you try to repair the set yourself as this will invalidate the guarantee. If a fault occurs, first check the points listed before taking the unit to repair. If you are unable to solve a problem by following these hints, consult your dealer or service centre.

The radio has no power

- Check that your batteries are not drained, that they are inserted correctly, that the contact pins are clean.

The indication "No station available" is displayed

- You may have moved to a new area which is blocking the range of the transmitter. Autoscan your radio and refresh the list of stations in service (see chapter **Tuning/retuning**, local scan/full scan).
- The station is out of service. In the DAB mode, search for a new station in the station list (see chapter **Selecting a station**).

The indication "Station off air" is displayed

- The station is out of service. The radio will wait until the service resumes. You can also tune to a new station.

No sound is heard

- Check that the headphones is connected and you allow the headphone cord to hang freely.
- Check that the volume level is not too low.
- Adjust the position of the radio to obtain better signal reception.
- The station is currently out of service. Wait until the service resumes, or tune to a new station.

No response to buttons or the set 'hangs'

- Electrostatic discharge. Remove batteries for 1 minute, replace batteries then switch on again.
- LOCK activated. Adjust the HOLD slider to UNLOCK.



Need help?
Online

Go to www.philips.com/support



Be responsible
Respect copyrights

© Royal Philips Electronics N.V. 2007

Meet Philips at the Internet
<http://www.philips.com>



Printed in China

PDCC-2007

Free Manuals Download Website

<http://myh66.com>

<http://usermanuals.us>

<http://www.somanuals.com>

<http://www.4manuals.cc>

<http://www.manual-lib.com>

<http://www.404manual.com>

<http://www.luxmanual.com>

<http://aubethermostatmanual.com>

Golf course search by state

<http://golfingnear.com>

Email search by domain

<http://emailbydomain.com>

Auto manuals search

<http://auto.somanuals.com>

TV manuals search

<http://tv.somanuals.com>