

DIRECTV
Satellite Receiver

User Manual

DSX 5150

DSX 5353

DSX 5375



Let's make things better.



PHILIPS

Return your Warranty Registration card today to ensure you receive all the benefits you're entitled to.

Once your PHILIPS purchase is registered, you're eligible to receive all the privileges of owning a PHILIPS product. So complete and return the Warranty Registration Card enclosed with your purchase at once, and take advantage of these important benefits.

Warranty Verification

Registering your product within 10 days confirms your right to maximum protection under the terms and conditions of your PHILIPS warranty.

Owner Confirmation

Your completed Warranty Registration Card serves as verification of ownership in the event of product theft or loss.

Model Registration

Returning your Warranty Registration Card right away guarantees you'll receive all the information and special offers which you qualify for as the owner of your model.

Congratulations on your purchase, and welcome to the "family!"



PHILIPS



Dear PHILIPS product owner:

Thank you for your confidence in PHILIPS. You've selected one of the best-built, best-backed products available today. And we'll do everything in our power to keep you happy with your purchase for many years to come.

As a member of the PHILIPS "family," you're entitled to protection by one of the most comprehensive warranties and outstanding service networks in the industry.

What's more, your purchase guarantees you'll receive all the information and special offers for which you qualify, plus easy access to accessories from our convenient home shopping network.

And most importantly you can count on our uncompromising commitment to your total satisfaction.

All of this is our way of saying welcome—and thanks for investing in a PHILIPS product.

Sincerely,

Robert Minkhorst
President and Chief Executive Officer

P.S. Remember, to get the most from your PHILIPS product, you must return your Warranty Registration Card within 10 days. So please mail it to us right now!

Know these safety symbols



This "bolt of lightning" indicates uninsulated material within your unit may cause an electrical shock. For the safety of everyone in your household, please do not remove product covering.

The "exclamation point" calls attention to features for which you should read the enclosed literature closely to prevent operating and maintenance problems.

WARNING: TO PREVENT FIRE OR SHOCK HAZARD, DO NOT EXPOSE THIS EQUIPMENT TO RAIN OR MOISTURE.

CAUTION: To prevent electric shock, match wide blade of plug to wide slot, and fully insert.

ATTENTION: Pour éviter les chocs électriques, introduire la lame la plus large de la fiche dans la borne correspondante de la prise et pousser jusqu'au fond.

Visit our World Wide Web Site at <http://www.philipsusa.com>

Download from www.SoftManuals.com. All Manuals Search And Download.

SAFETY INSTRUCTIONS - READ BEFORE OPERATING EQUIPMENT.

WARNING: TO PREVENT FIRE OR SHOCK HAZARD, DO NOT EXPOSE ANY ELECTRICAL EQUIPMENT TO RAIN OR MOISTURE.

1. **Read Instructions** – All the safety and operating instructions should be read before the appliance is operated.
2. **Retain Instructions** – The safety and operating instructions should be retained for future reference.
3. **Heed Warnings** – All warnings on the appliance and in the operating instructions should be adhered to.
4. **Follow Instructions** – All operating and use instructions should be followed.
5. **Attachments** – Do not use attachments not recommended by the manufacturer as they may cause hazards.
6. **Water and Moisture** – Do not use this product near water – for example, near a bath tub, wash bowl, kitchen sink, or laundry tub, in a wet basement, near a swimming pool, etc.
7. **Accessories** – Do not place this product on an unstable cart, stand, tripod, bracket, or table. The product may fall, causing serious injury to a child or adult, and serious damage to the appliance. Use only with a cart, stand, tripod, bracket, or table recommended by the manufacturer or sold with the product. Any mounting of the appliance should follow the manufacturer's instructions, and should use a mounting accessory recommended by the manufacturer.
- 7A.  An appliance and cart combination should be moved with care. Quick stops, excessive force, and uneven surfaces may cause the appliance and cart combination to overturn.
8. **Ventilation** – Slots and openings on the cabinet are provided for ventilation and to ensure reliable operation of the product and to protect it from overheating. These openings must not be blocked or covered. The openings should never be blocked by placing the product on a bed, sofa, rug, or other similar surface. This product should not be placed near or over a radiator or heat register. This product should not be placed in a built-in installation such as a bookcase or rack unless proper ventilation is provided or the manufacturer's instructions have been adhered to.
9. **Power Sources** – This product should be operated only from the type of power source indicated on the marking label. If you are not sure of the type of power supply to your home, consult your appliance dealer or local power company.
10. **Grounding or Polarization** – This product is equipped with a polarized alternating-current line plug (a plug having one blade wider than the other). This plug will fit into the power outlet only one way. This is a safety feature. If you are unable to insert the plug fully into the outlet, try reversing the plug. If the plug should still fail to fit, contact your electrician to replace your obsolete outlet. Do not defeat the safety purpose of the polarized plug.
11. **Power Cord Protection** – Route power supply cords so that they are not likely to be walked on or pinched by items placed upon or against them. Pay particular attention to cords at plugs, convenience receptacles, and the point where they exit from the appliance.
12. **Outdoor Antenna Grounding** – If an outside antenna or cable system is connected to the product, be sure the antenna or cable system is grounded to provide protection against voltage surges and built-up static charges.

Section 810 of the National Electrical Code, ANSI/NFPA 70, provides information with regard to proper grounding of the mast and supporting structure, grounding of the lead-in wire to an antenna discharge unit, size of grounding conductors, location of antenna-discharge unit, connection to grounding electrodes, and requirements for the grounding electrode. See Figure A.

13. **Phone Line Use** – Avoid using a telephone (other than a cordless type) during an electrical storm. There may be a remote risk of electric shock from lightning. Do not use the telephone to report a gas leak in the vicinity of the leak.

14. **Lightning** – For added protection for this product during a lightning storm or when it is left unattended and unused for long periods of time, unplug it from the wall outlet and disconnect the antenna or cable system. This will prevent damage to the product from lightning and power line surges.
15. **Power Lines** – An outside antenna system should not be located in the vicinity of overhead power lines or other electric light or power circuits, or where it can fall onto such power lines or circuits. When installing an outside antenna system, extreme care should be taken to keep from touching such power lines or circuits as contact with them might be fatal. Refer to Satellite Dish Antenna Assembly & Alignment Guide.
16. **Overloading** – Do not overload wall outlets and extension cords as this can result in a risk of fire or electric shock.
17. **Object and Liquid Entry** – Never push objects of any kind into this product through openings as they may touch dangerous voltage points or short-out parts that could result in a fire or electric shock. Never spill liquid of any kind on the product.
18. **Servicing** – Do not attempt to service this product yourself, as opening or removing covers may expose you to dangerous voltage or other hazards. Refer all servicing to qualified service personnel.
19. **Damage Requiring Service** – Unplug this product from the wall outlet and refer servicing to qualified service personnel under the following conditions:
 - a. When the power supply cord or plug is damaged.
 - b. If liquid has been spilled, or objects have fallen into the product.
 - c. If the product has been exposed to rain or water.
 - d. If the product does not operate normally when following the operating instructions. Adjust only those controls that are covered by the operating instructions, as an improper adjustment of other controls may result in damage and will often require extensive work by a qualified technician to restore the product to its normal operation.
 - e. If the product has been dropped or the cabinet has been damaged in any way.
 - f. When the product exhibits a distinct change in performance – this indicates a need for service.
20. **Replacement Parts** – When replacement parts are required, be sure the service technician has used replacement parts specified by the manufacturer or which have the same characteristics as the original part. Unauthorized substitutions may result in fire, electric shock or other hazards.
21. **Safety Check** – Upon completion of any service or repairs to this product, ask the service technician to perform safety checks to determine that the product is in proper operating condition.
22. **Carts and Stands** – The appliance should be used only with a cart or stand recommended by the manufacturer.
23. **Heat** – The product should be situated away from heat sources such as radiators, heat registers, stoves, or other products that produce heat.

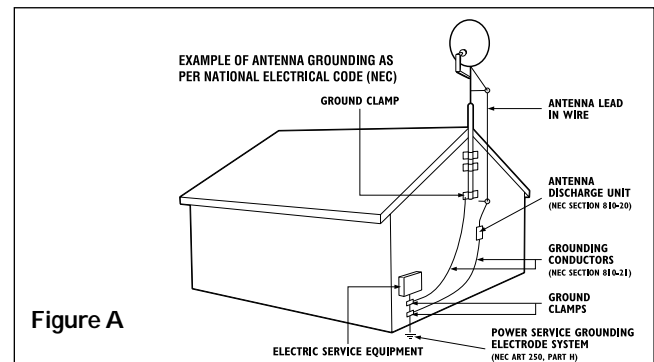

Figure A

SAFETY INSTRUCTIONS (CONT'D)

NOTE TO CATV SYSTEM INSTALLER

Article 820-40 of the NEC (National Electrical Code) provides guidelines for proper grounding and, in particular, specifies that the cable ground shall be connected to the grounding system of the building, as close to the point cable entry as practical.

WARNING

This device complies with Part 15 of the FCC (U.S.A.) Rules.

Operation is subject to the following two conditions:

- (1) This device may not cause harmful interference, and
- (2) This device must accept any interference received, including interference that may cause undesired operation.

FCC Regulations and Information

This equipment has been tested and found to comply with the limits for a Class B digital device, pursuant to Part 15 of the FCC Rules. These limits are designed to provide reasonable protection against harmful interference in a residential installation. This equipment generates, uses and can radiate radio frequency energy and, if not installed and used in accordance with the instructions, may cause harmful interference to radio communications.

However, there is no guarantee that interference will not occur in a particular installation. If this equipment does cause

interference to radio or television reception (which you can determine by turning the equipment off and on), you are encouraged to try to correct the interference by one or more of the following measures:

1. Change the position of the Satellite Receiver with respect to the radio or television equipment that is receiving the interference.
2. Move the Satellite Receiver away from the equipment that is receiving the interference.
3. Plug the Satellite Receiver into a different outlet so that the Satellite Receiver and the equipment receiving the interference are on different branch circuits.
4. Use shielded cables and I/O cords with this equipment to comply with the relevant FCC regulations.
5. If these measures do not eliminate the interference, you should consult your dealer or an experienced radio/television technician for help.

IMPORTANT

Any change or modifications to the equipment by the user not expressly approved by the warranty or manufacturer could void the user's authority to operate the equipment.

Domestic use U.S.A – For units used at 100-120V, use only the power supply cord which is supplied with the product.

GENERAL INFORMATION

Federal Communication Commission (FCC) Part 68 ANALOG DEVICE WARNINGS

This equipment complies with part 68 of the FCC rules.

A label on the rear panel of this equipment contains, among other information, the FCC registration number and ringer equivalence number (REN) for this equipment. If requested, this information must be provided to the telephone company.

The REN is used to determine the number of devices which may be connected to the telephone line. Excessive RENs on the telephone line may result in the devices not ringing in response to an incoming call. In most, but not all areas, the sum of RENs should not exceed five (5.0). To be certain of the number of devices that may be connected to a line, as determined by the total RENs, contact the local telephone company.

Note: RENs are associated with loop-start and ground-start ports. Do not use for E & M or digital ports.

This equipment uses the following USOC jack: RJ-11C.

No modular plug is provided with this equipment.

If the DSX 5350 causes harm to the telephone network, the telephone company will notify you in advance that

temporary interruption of service may be required. But if advance notice isn't practical, the telephone company will notify the customer as soon as possible. Also, you will be advised of your right to file a complaint with the FCC if you believe it is necessary.

The telephone company may make changes in its facilities, equipment, operations or procedures that could affect the operation of the equipment. If this happens, the telephone company will provide advance notice in order for you to make necessary modifications to maintain uninterrupted service.

If the equipment is causing harm to the telephone network, the telephone company may request that you disconnect the equipment until the problem is resolved.

This equipment cannot be used on public coin phone service provided by the telephone company. Connection to party line service is subject to state tariffs. (Contact the state public utility commission, public service commission or corporation commission for information.)

For repair or warranty information on hardware service only, please call:

1-800-464-1131.

TABLE OF CONTENTS

Overview	6	Messages	29
Modes	7	Using the Menu	30
Preparing your Remote Control	8	General Settings	30
Controls and Connections	9	Screen Format	31
Connecting to your Existing Equipment	10	Banner Duration	31
Inserting your Access Card	12	Favorite Channels	32
Replacing the Access Card	13	Access Control	33
Remote Control Use	14	Language	35
On Screen Installation	19	Purchases	36
General Operation of your DIRECTV Receiver	22	Upgrades	41
Banner	22	Mail	41
Notification Displays	23	Smart Help	42
DIRECTV Programming Guide	24	Glossary	45
Themes	27	Specifications	46
Alternate Audio	28	Index	47
Options Menu	29	Limited Warranty	48

DISCLAIMERS

Programming subject to change. You must be physically located in the U.S. to receive DIRECTV service. DIRECTV services not available outside the U.S. DIRECTV programming is sold separately and independently of DIRECTV System hardware. A valid programming subscription is required to operate DIRECTV System hardware. Activate your DIRECTV programming today at 1-800-DIRECTV (1-800-347-3288).

DIRECTV and the Cyclone Design logo are trademarks of DIRECTV, Inc., a unit of Hughes Electronics Corp., and are used with permission.

Philips is a registered trademark of Koninklijke Philips Electronics, NV.

This product includes software developed by the University of California, Berkeley and its contributors.

Copyright (c) 1982, 1986, 1988, 1990, 1993

The Regents of the University of California. All rights reserved.

Redistribution and use in source and binary forms, with or without modification, are permitted provided that the following conditions are met:

1. Redistributions of source code must retain the above copyright notice, this list of conditions and the following disclaimer.
2. Redistributions in binary form must reproduce the above copyright notice, this list of conditions and the following disclaimer in the documentation and/or other materials provided with the distribution.
3. All advertising materials mentioning features or use of this software must display the following acknowledgment: This product includes software developed by the University of California, Berkeley and its contributors.
4. Neither the name of the University nor the names of its contributors may be used to endorse or promote products derived from this software without specific prior written permission.

THIS SOFTWARE IS PROVIDED BY THE REGENTS AND CONTRIBUTORS "AS IS" AND ANY EXPRESS OR IMPLIED WARRANTIES, INCLUDING, BUT NOT LIMITED TO, THE IMPLIED WARRANTIES OF MERCHANTABILITY AND FITNESS FOR A PARTICULAR PURPOSE ARE DISCLAIMED. IN NO EVENT SHALL THE REGENTS OR CONTRIBUTORS BE LIABLE FOR ANY DIRECT, INDIRECT, INCIDENTAL, SPECIAL, EXEMPLARY, OR CONSEQUENTIAL DAMAGES (INCLUDING, BUT NOT LIMITED TO, PROCUREMENT OF SUBSTITUTE GOODS OR SERVICES; LOSS OF USE, DATA, OR PROFITS; OR BUSINESS INTERRUPTION) HOWEVER CAUSED AND ON ANY THEORY OF LIABILITY, WHETHER IN CONTRACT, STRICT LIABILITY, OR TORT (INCLUDING NEGLIGENCE OR OTHERWISE) ARISING IN ANY WAY OUT OF THE USE OF THIS SOFTWARE, EVEN IF ADVISED OF THE POSSIBILITY OF SUCH DAMAGE.

OVERVIEW

This user manual will help you set up and use your Philips manufactured DIRECTV Satellite Receiver. On-screen messages will provide additional help, as will the glossary on page 40 of this manual.

FEATURES

Your Satellite Receiver lets you receive television signals from up to three satellites. You can customize your viewing schedules, set up favorite programs, set viewing preferences, and order pay per view (PPV) programs.

- Use the on-screen DIRECTV® Programming Guide to see what's on.
- Create your own list of favorite channels.
- Restrict viewing based on the ratings of programs.
- Tag programs for future viewing, or recording to a VCR.
- Receive mail messages from DIRECTV.



Outside Satellite Dish Antenna



Satellite Receiver



SMART HELP

Your Satellite Receiver has a first time setup on-screen guide. This offers important and helpful operation instructions. For details, refer to page 19.

MODES

Your Satellite Receiver has four modes:

- Standby - Satellite Receiver is on but inactive; television is off.
- TV - displays television programming.
- Guide - for viewing schedules and tuning to a program.
- Menu - for setting preferences and access codes.

To change modes, press the POWER, GUIDE, or MENU buttons on the remote. Features available in each mode are described below.

Standby Mode

When you press the POWER button on either the Satellite Receiver or remote control, the Satellite Receiver enters Standby mode. When you are not using the Satellite Receiver, **DO NOT TURN OFF THE POWER** to the Satellite Receiver; when the Satellite Receiver is in Standby mode, the Guide refreshes itself continuously to ensure that it is up to date.

Temporarily unlocked channels are **NOT** kept in memory when the system goes into standby mode; themes and favorite channels are kept in memory.

TV Mode

This is the normal viewing mode in which programs are viewed without Guide or Menu displayed.

Guide Mode

In Guide mode, you can view lists of programs according to their time slot and channel. You can tune to a program, receive notification when a program is about to start, order pay per view programs, search through listings for a specific type of program, and tag programs for future viewing. You can also access the menu, other guides, a tag list, or help.

Menu Mode

Menu mode lets you access or customize the features of your Satellite Receiver. Categories include Guide, General Settings, Access Control, Preferred Language, Purchases, Installation, Upgrades, and Mail. Details of each option are explained in this user manual.

Guide Mode Screen



Menu Mode Screen



Getting Started

Before you can use your system, you must do the following:

- Install your Satellite Receiver according to the instructions in the Satellite Dish Antenna Assembly & Alignment Guide.
- Install the Access Card as described on page 12.
- Connect the telephone line to the Satellite Receiver so that you can purchase pay per view programs.
Note: A telephone cord is included with the Satellite Receiver.
- To activate your service call:
DIRECTV at 1-800-DIRECTV (347-3288).

The next few pages will explain these processes in detail.

It's time to connect the Satellite Receiver to your TV and other equipment. Go to page 8 to begin.

PREPARING YOUR REMOTE CONTROL

BATTERY INSTALLATION

- 1 Remove the battery compartment cover.
- 2 Insert the two batteries (type LR6/AA - 1.5 V) supplied.
- 3 Position them, as shown in the diagram, in the battery compartment.
- 4 Replace the cover.

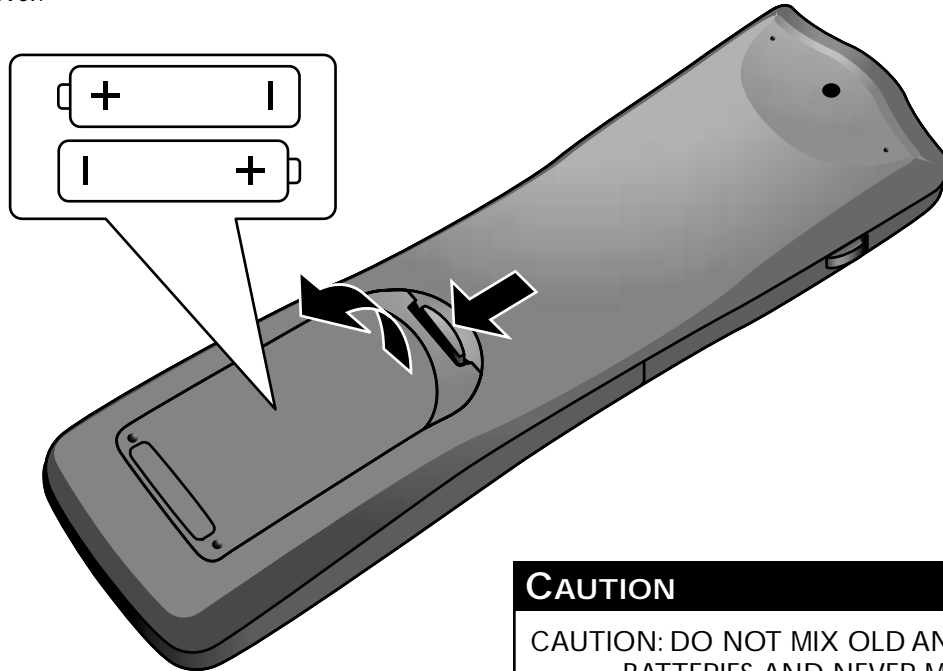

Note: For more information on using your remote control refer to page 14.

CAUTION

CAUTION: DO NOT MIX OLD AND NEW BATTERIES, AND NEVER MIX DIFFERENT TYPES OF BATTERIES (STANDARD, ALKALINE, AND SO ON).

The batteries supplied with your Satellite Receiver's remote control do not contain heavy metals such as mercury or nickel cadmium. Nevertheless, in many countries exhausted batteries may not be disposed of with your household waste. Please dispose of exhausted batteries according to local regulations.

Now, go to Controls and Connections on page 9.

CONNECTING TO YOUR EXISTING EQUIPMENT

Unplug all equipment from the AC power before hooking up.

If your Television has RF (UHF/VHF) Connection Only

Refer to the illustration:

- 1 Using a RF coaxial cable, connect the Satellite Receiver's 'TO TV/VCR' output jack to the TV's UHF/VHF input jack.
- 2 If the RF coaxial cable from the satellite dish has not been connected to the Satellite Receiver, connect it to SAT IN jack.
- 3 Connect one end of the AC power cord to the Satellite Receiver's AC IN jack. Connect the plug end to an AC outlet. The power LED should light to indicate that the power is on.
- 4 Connect other equipment to an AC outlet.
- 5 Switch on your TV first and select channel 3 or 4, whichever channel is not used or least used in your area. Set the CHANNEL 3/4 switch on the back of the Satellite Receiver to the same channel.

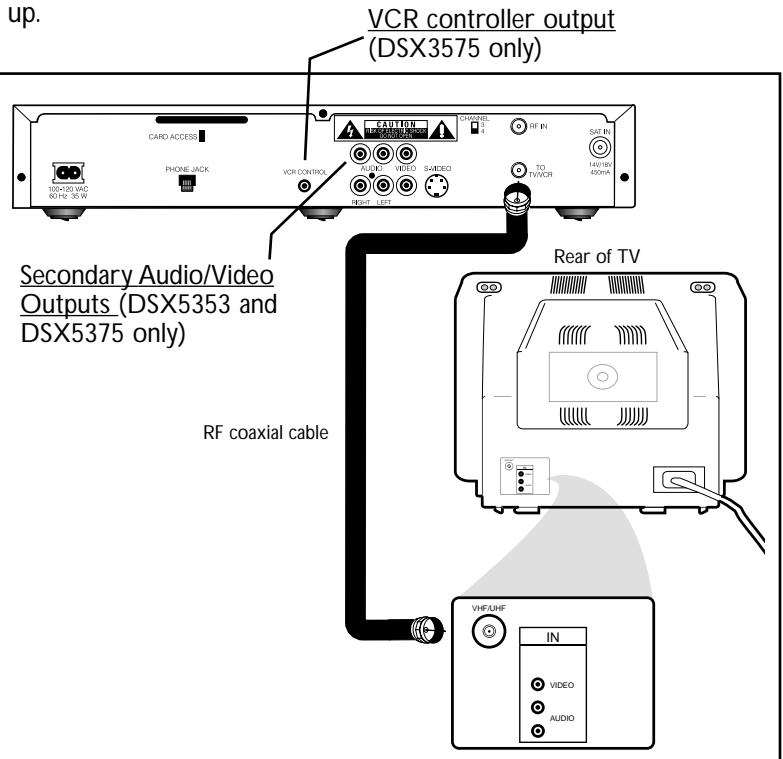

Next, go to Inserting Your Access Card on page 12.

If your Television has Audio/Video (A/V) Connectors

Refer to the illustration:

- 1 Using RCA type cables (red, white, and yellow, not included), connect the Satellite Receiver AUDIO OUT and VIDEO OUT jacks to the TV's A/V IN jacks. Connect the red cable to the red jacks, the white cable to the white jacks, and the yellow cable to the yellow jacks. Note: you can also connect the Satellite Receiver's AUDIO out jacks to your audio receiver's AUDIO IN jacks using audio cables. With models DSX 5353 and DSX 5375, you may connect the second set of A/V outputs to an audio receiver or second TV.
- 2 If the RF coaxial cable from the satellite dish has not been connected to the Satellite Receiver, connect it to SAT IN jack.
- 3 Connect one end of the AC power cord to the Satellite receiver's AC IN jack. Connect the plug end to an AC outlet.
- 4 Connect other equipment to an AC outlet.
- 5 Switch on your TV first and select the appropriate A/V mode. Refer to the user manual of your TV set to select the proper A/V mode (AUX/VCR, S-VIDEO, ...)

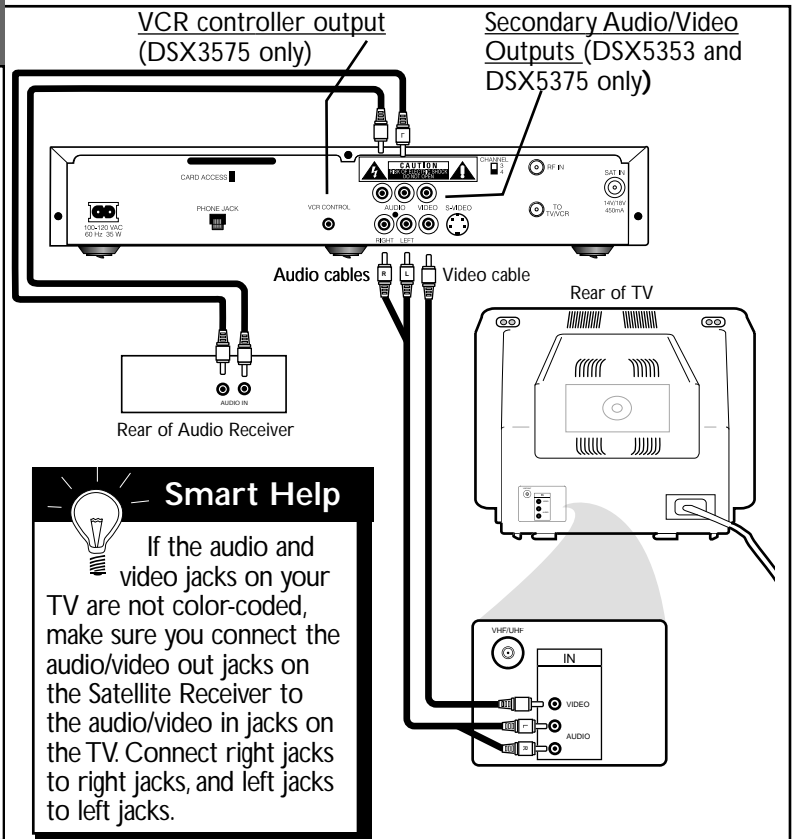

Smart Help

If the audio and video jacks on your TV are not color-coded, make sure you connect the audio/video out jacks on the Satellite Receiver to the audio/video in jacks on the TV. Connect right jacks to right jacks, and left jacks to left jacks.

Next, go to Inserting Your Access Card on page 12.

CONNECTING TO YOUR EXISTING EQUIPMENT (CONT'D)

Unplug all equipment from the AC outlet before making connections.

If you have a TV and a VCR

Refer to the illustration at right:

- 1 Connect the Satellite Receiver A/V jacks to the VCR's A/V IN jacks. Connect the red cable to the red jacks, the white cable to the white jacks, and the yellow cable to the yellow jacks.
- 2 Connect the VCR's A/V OUT jacks to the TV's A/V IN jacks.
- 3 Connect TV, VCR or other equipment to AC outlet.
- 4 Switch on your TV first and select the appropriate channel or A/V mode depending on the connection chosen in step 2. Refer to the user manuals for your TV and VCR to select proper channel or A/V mode (AUX/VCR, S-VIDEO, ...).

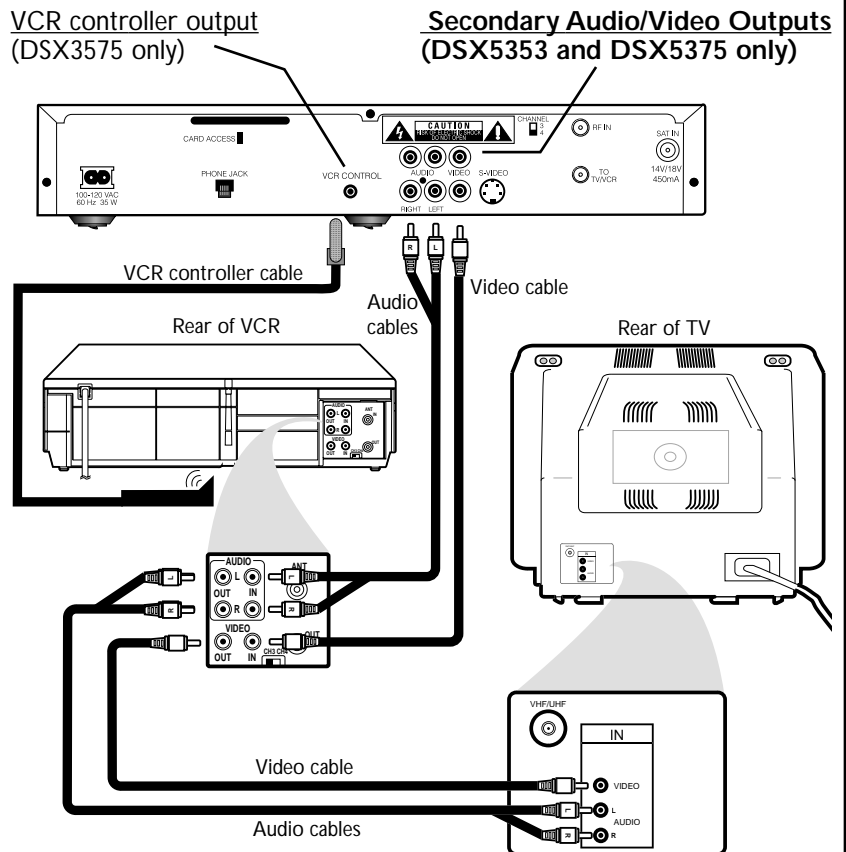

Connecting the VCR Controller (DSX 5375R only)

Refer to the illustration:

- 1 Connect the VCR Controller cable to the VCR CONTROL jack on the Satellite Receiver.
- 2 Place the VCR Controller under and in front of the VCR close to the sensor.
- 3 Your VCR Controller is now ready to be set up for your VCR



Smart Help

- If the audio and video jacks on your TV are not color-coded, make sure you connect the audio/video out jacks on the Satellite Receiver to the audio/video in jacks on the TV. Connect right jacks to right jacks, and left jacks to left jacks.
- If your VCR or TV does not have audio and video jacks, use RF coaxial cables for connections instead. Connect the RF coaxial cable to the TV/VCR jack on the Satellite Receiver and to the RF or ANTENNA IN jack on the VCR.

Then, connect a second RF coaxial cable to the ANTENNA OUT or RF OUT jack of the VCR and to the ANTENNA IN, RF in, or UHF/VHF IN jack of the TV.

Next, go to Inserting Your Access Card on page 12.

INSERTING YOUR ACCESS CARD

The access card provided with your system includes information about your purchase authorization and other data. To watch channels, your viewing access card needs to be inserted in the access card slot on the rear of your Satellite Receiver.

When the card is removed, the system will not display any programming guides or video signal. The message, "Please insert your Access Card" will show on the TV screen.

The access card only needs to be inserted during system setup and generally does not need to be removed. Each access card has a unique number. Be sure to record this number in the space provided on the back cover of this manual.

- 1 Hold the card with the arrow facing upwards and pointing toward the slot in the Satellite Receiver rear panel.
- 2 Gently push the card into the slot until it meets the stop. Do not use undue force when inserting. The end will be visible outside of the slot.
- 3 Keep your access card permanently inserted in your Satellite Receiver.
- 4 Connect one end of the AC power cord to the Satellite Receiver's AC IN jack. Connect the plug end to an AC outlet. This will turn unit on.

REPLACING THE ACCESS CARD

When replacing the access card, the system will prompt you with instructions. Gently remove the card from its slot. If you have to reinsert the card, you should have the ARROW facing forward into the box and the GOLD CHIP facing down. Push the card into the slot as far as it will go, the end will be visible outside of the slot.

The old card passes information to the new card, and then the old card no longer functions.

Caution



- YOUR ACCESS CARD IS FRAGILE.
- ALWAYS INSERT CORRECTLY AND CAREFULLY.
- DO NOT BEND.
- DO NOT REMOVE AND RE-INSERT UNNECESSARILY.
- NEVER SUBMERGE IN LIQUID OR APPLY CLEANING FLUIDS.

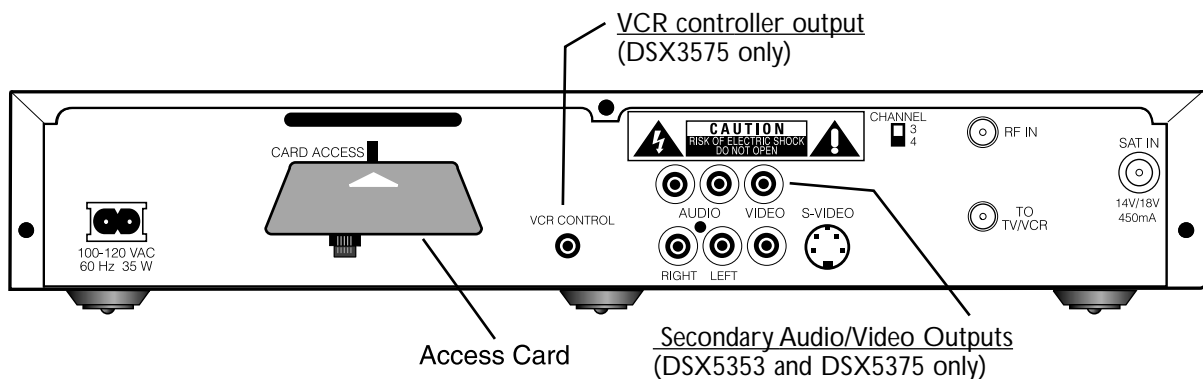

SMART HELP

Once the Satellite Receiver is powered on, the Installation Wizard will appear on your TV screen. You should then proceed to the Installation Wizard details on page 19.

Note: The Installation Wizard will remain on the screen only for a few minutes and needs to be accessed as quickly as possible. This screen will **ONLY** appear the very first time your Satellite Receiver is in use.

Next, go to Switching your Satellite Receiver On and Off on page 13.

REPLACING THE ACCESS CARD

Your service provider may periodically send you a new access card. You will need to use this card in place of the current card.

To Replace the Access Card

- 1 Press MENU.
- 2 Use the ▲ / ▼ buttons to highlight Access Control. Press OK.
- 3 Choose Replace Access card, then press OK. Be sure the current access card is inserted in the Satellite Receiver. "Copying OLD access card information..." will appear on the screen.
- 4 When prompted, remove the old card, insert the new card, then press OK. Data from the old card will be copied to the new card. A message will inform you when the process is complete.
- 5 Press OK to return to the previous menu.
- 6 Discard the old card. It no longer works.

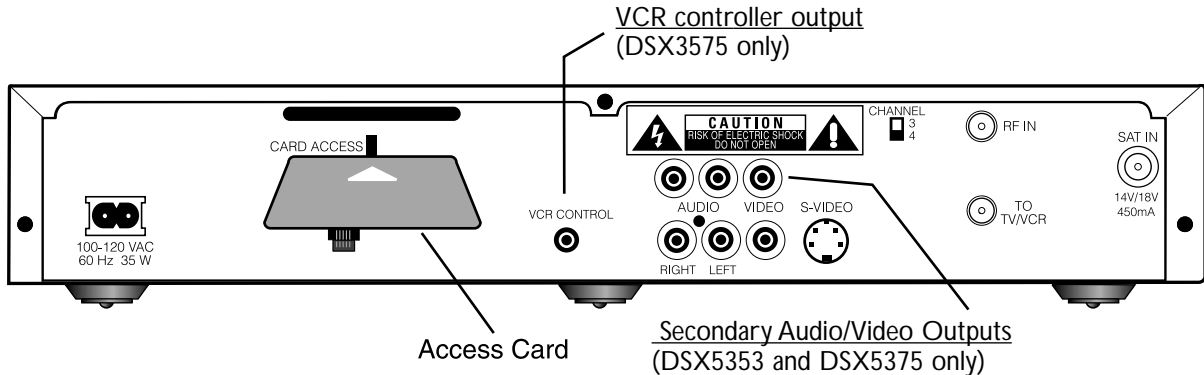

SWITCHING YOUR SATELLITE RECEIVER ON AND OFF

Pressing the POWER button on your remote control or on the front of the Satellite Receiver will turn on or turn off your Satellite Receiver.

Note: Pressing the POWER button on your remote control again will put the Satellite Receiver into standby. There is no need to remove power from the Satellite Receiver (by unplugging the AC power cord).

Next, go to Preparing your Remote Control on page 14.

REMOTE CONTROL USE - SATELLITE

SMART HELP
 Some of the buttons on this remote control operate differently depending on whether you are in Guide, Menu, or TV mode.

INFO

- **Guide mode:** pressing INFO switches between short and long program information in the banner.
- **Menu mode:** inactive.
- **TV mode:** switches between short and extended banners.

MODE

- Three different modes (SAT,VCR,TV) are selected by pressing the "MODE" button. The mode selected is the one with the lighted LED.

FAVORITES

- **Guide mode:** switches display of Favorite channel list.
- **Menu mode:** inactive.
- **TV mode:** switches display of the Favorites dialog.

PAGE+/-

- **Guide mode:** displays the contents of the next or previous Guide screen.
- **Menu mode:** used with long lists of options such as favorite channels, system information, PPV, and system test to scroll a full page of selection items.
- **TV mode:** lets you view the program banner of other channels while still viewing the video in from the current channel.

GUIDE

- **Guide mode:** switches display of the Guide.
- **Menu mode:** inactive.
- **TV mode:** displays the Guide.



- **Guide mode:** navigates through the Guide.
- **Menu mode:** ▲ ▼ select and highlight menu options and move between items on a screen. ◀ ▶ change settings in an item on the screen.
- **TV mode:** ◀ ▶ inactive. ▲ ▼ for channel surfing.

TV/SAT

- **All modes:** switches to local cable or antenna broadcasts.

0-9

- **Guide mode:** goes to channel entered in Guide.
- **Menu mode:** lets you enter numeric values.
- **TV mode:** allows direct number entry for tuning to a channel. Tuning occurs immediately after the channel is entered, or you can press OK after entering the third digit to tune immediately to the channel.



POWER

- **All modes:** switches the satellite receiver between active and standby modes but does NOT turn off power to the unit.

THEMES

- **Guide mode:** switches display of themes. Themes indicate the type of program, for example, movie/action adventure.
- **Menu mode:** inactive.
- **TV mode:** displays the Themes menu.

MENU

- **Guide mode:** enables selection of icons at the bottom of the Guide. A second press redisplay the Guide.
- **Menu mode:** removes the menu from the screen and accepts changes. Pressing MENU again exits the menu and returns to the TV confirming any previously set values.
- **TV mode:** displays the main menu.

OK

- **Guide mode:** confirms current programming. Pressing OK confirms a selection in a dialog. For future programming, tags the selection or starts the PPV sequence.
- **Menu mode:** confirms the selection of a menu option or list choice.
- **TV mode:** when browsing channels, goes to the channel displayed in the browse banner.

BACK

- **Guide mode:** returns to the previous state.
- **Menu mode:** exits the current menu and confirms selections in dialogs with non-exclusive options.
- **TV mode:** jump to previous channel.

EXIT

- **In Guide and Menu modes:** returns to video and cancels the transaction.
- **TV mode:** inactive.

 reserved for future use.

ALT AUDIO

- **Guide mode:** when alternate audio tracks are available, lets you select another audio track.
- **Menu mode:** inactive.
- **TV mode:** displays a dialog for selecting alternate audio tracks.

REMOTE CONTROL USE - TV

 **SMART HELP**
This remote control will operate most TVs and VCRs. See Programming the Universal Remote on page 17.

MODE

Three different modes (SAT,VCR,TV) are selected by pressing the "MODE" button. The mode selected is the one with the lighted LED.

POWER

Press to turn TV on or off.

VOL +/-

Increases and decreases volume.

 for channel surfing.

0-9

Allows direct number entry for tuning to a channel.

MUTE

• Switches audio on and off.



REMOTE CONTROL USE - VCR

SMART HELP

 This remote control will operate most TVs and VCRs. See Programming the Universal Remote on page 17.

MODE

Three different modes (SAT,VCR,TV) are selected by pressing the "MODE" button. The mode selected is the one with the lighted LED.

POWER

Press to turn VCR on or off.

RECORD

Press once to start a recording.

FF

When tape playback is stopped, press to advance the tape at high speed. During tape playback, press to advance the tape while the picture stays on the screen.

REWIND

When tape playback is stopped, press to rewind at high speed. During tape playback, press to rewind the tape while the picture stays on the screen.

PLAY

Press to play a tape.

STOP

Press to stop the tape.



▲▼ for channel surfing.

0-9

Allows direct number entry for tuning to a channel.



Next, go to On Screen Installation on page 19.

PROGRAMMING THE UNIVERSAL REMOTE CONTROL

Manually Setting the Remote to Operate a TV or VCR

Your remote control **may** operate your TV or VCR (TV/VCR). If the remote control doesn't operate your TV/VCR now, follow the steps below.

- 1 Point the remote control at your TV/VCR and press the MODE button until the TV or VCR LED lights. Then, press the POWER button. If your TV/VCR turns on or off, try the other TV/VCR function buttons. If your TV/VCR doesn't turn on or off, or if the other buttons don't work, go to step 2.
- 2 Find the brand of your TV/VCR on the accompanying list, and remember the four digit number beside it.
- 3 Press the MODE button until the TV or VCR LED lights.
- 4 Press and hold the number 1 button and the number 3 button for 3 seconds. The LED will blink twice and remain on.
- 5 Enter the 4-digit code within one minute. The LED will blink after each button press. Note: If the 4-digit code is not entered within one minute, the LED will turn off and the remote control will return to the previously programmed code.
- 6 After a valid 4-digit code has been entered, the LED will turn off and blink twice to confirm the new 4-digit code has been programmed. The LED will then turn off.
- 7 If an invalid 4-digit code has been entered, the LED will turn off and then display a long Blink.
- 8 Press the POWER button.
- 9 If the remote control works your TV/VCR, you're finished. If the remote control still doesn't work your TV/VCR, repeat steps 2-7. If your TV/VCR brand has more than one 4-digit code, try using the next code number.

If the remote still does not operate your TV/VCR, follow the Automatic Search steps below.

Automatic Search

- 1 Turn on your TV or VCR. Point your remote control toward the remote sensor on your TV/VCR. Press and hold the number 1 button and the number 3 button for three seconds. The LED will blink twice and remain on.
- 2 Press the POWER button. The LED will turn off. Note: If the Power button is not pressed within 1 minute, the remote will return to the previously programmed code. The automatic search will begin after the Power button has been released.
- 3 Each time a code is transmitted, the LED will blink. This process could take several minutes.
- 4 When the correct code is found, the TV/VCR should turn off. Immediately press the POWER button. The LED will blink twice, then turn off. If all codes have been tried and the TV/VCR has not turned **on or off** the LED will stay on briefly, then turn off.

Note: To stop the search process at any time, press any button other than the POWER button. The LED will give a long blink and turn off.



SMART HELP

The remote may only operate some features of your TV or VCR. For example, the remote control may turn on the TV power, but it may not change channels at the TV.

When you replace the batteries in the remote control, you may have to program the remote control again. Remember to point the remote control toward the TV or VCR during the Automatic Search.

There is no guarantee that the remote control will work with your TV or VCR.

TV CODES

AOC.....0046, 0057	Brockwood.....0046	Crown.....0066, 02070046, 0181
Admiral.....0120, 0490	Broksonic.....0263, 0490	Curtis Mathes.....0087, 0057,	Envision.....0057
Aiko.....0119	CXC.....02070043, 0066, 0074, 0078, 0081,	Fisher.....0181
Akai.....0057	Candle.....0057, 00830083, 0120, 0172, 0181, 0193,	Fujitsu.....0206, 0710
Alaron.....0206	Carnivale.....00570478, 0774	Funai.....0207, 0198, 0206
Ambassador.....0204	Carver.....0081	Daewoo.....0119, 0046, 0478,	Futuretech.....0207
America Action.....0207	Celebrity.....00270066	GE.....0048, 0074, 0078, 0205,
Ampro.....0778	Cineral.....0478, 0119	Daytron.....00460478, 0120, 0162, 0309,
Anam.....0207	Citizen.....0083, 0057, 0066,	Denon.....01720774
Audiovox.....0119, 0207, 04780087, 0119	Dumont.....0044, 0046	Gibraltar.....0044, 0046, 0057
Baysonic.....0207	Concerto.....0083	Dwin.....0747, 0801	GoldStar 0205, 0046, 0057, 0083
Belcor.....0046	Contec.....0207	Electroband.....0027	Gradiente.....0083, 0080
Bell & Howell.....0043, 0181	Craig.....0207	Emerson.....0263, 0207, 0205,	
Bradford.....0207	Crosley.....00810206, 0490, 0204, 0309, 0066,	

Continued on next page.

PROGRAMMING THE UNIVERSAL REMOTE CONTROL (CONT'D)

TV Codes (Cont'd)

Grunpy0206, 0207	Midland0044, 0066, 0074,	Pulsar.....0044, 0046	Signature0043
Hallmark02050078, 0162, 0774	Quasar0078, 0277, 0192	Sony0027
Harley Davidson0206	Minutz0048	RCA0074, 0162, 0046, 0078,	Soundesign0205, 0206, 0207
Harman/Kardon0081	Mitsubishi0177, 0205, 0046,0117, 0120, 0774	Squareview0198
Harvard02070120	Radio Shack ...0192, 0207, 0057,	Starlite0207
Hitachi ..0172, 0178, 0083, 0043	Motorola01200205, 0066, 0181, 0046, 0074,	Supreme0027
Infinity0081	Multitech02070083, 0774	Sylvania0081, 0057
Inteq0044	NAD0183, 0193, 0205	Realistic0192, 0207, 0181,	Symphonic.....0198
JBL0081	NEC0057, 0046, 00830057, 0066, 0205, 0046, 0083	TMK0083, 0204, 0205
JCB0027	NTC0119	Runco0044, 0057	Tandy0120
JVC0080	Nikko0205, 0057, 0119	SSS0046, 0207	Technics0078, 0277
KEC0207	Onwa0207	Sampo0057, 0066	Technol Ace0206
KTV0207, 0057, 0066	Optimus.....0277, 0193, 0181	Samsung0087, 0046, 0205,	Techwood.....0078, 0083
Kenwood0057, 0046	Optonica0120, 01920057, 0083	Teknika0043, 0081, 0206,
LG0083	Orion0490, 0206, 0263	Samsux00660207, 0046, 0066, 0119, 0083,
LXI0181, 0074, 0081, 0183,	Panasonic0078, 0277	Sansei04780087, 0177
.....0205, 0774	Penney.....0074, 0087, 0057,	Sansui0490	Telefunken0083
Logik00430048, 0162, 0205, 0078, 0066,	Sanyo0181	Toshiba0183, 0087, 0181
Luxman00830046, 0083, 0183, 0774	Scimitsu0046	Totevision0066
MGA0177, 0046, 0057, 0205	Philco ...0172, 0046, 0057, 0081,	Scotch0205	Vector Research0057
MTC0087, 0057, 0046, 00830490	Scott0263, 0046, 0205, 0206,	Victor0080
Magnavox0081, 0057, 0206	Philips00810207	Vidikron0081
Majestic0043	Pilot0046, 0057, 0066	Sears0181, 0083, 0183, 0074,	Vidtech0046, 0205
Marantz0081, 0057	Pioneer01930081, 0198, 0205, 0206, 0774	Wards ...0081, 0192, 0205, 0043,
Matsushita0277	Portland0046, 0066, 0119	Semivox02070046, 0048, 0057, 0083, 0206
Megatron0172, 0205	Prism0078	Semp0183	White Westinghouse0490
Memorex0205, 0043, 0083,	Proscan0074, 0774	Sharp0120, 0192, 0066	Yamaha0046, 0057
.....0177, 0181, 0277, 0490	Proton0205	Shogun0046	Zenith ...0044, 0043, 0119, 0490

VCR Codes

Admiral0075, 0236	Fuji0060, 0062	Minolta0069	Sanky0066, 0075
Adventura0027	Funai0027	Mitsubishi0070, 0075, 0094	Sansui ...0068, 0027, 0094, 0236,
Aiko0305	GE0062, 0087, 0075, 0267,	Motorola0062, 00750298
Aiwa0334, 0027, 00640787	Multitech0027, 0099	Sanyo0074, 0073, 0131, 0267
Akai0133, 0068	Garrard0027	NEC0065, 0068, 0094, 0131	Scott0211, 0148, 0070, 0072
America Action0305	Go Video0553	Nikko0064	Sears.....0064, 0069, 0027, 0062,
American High0062	GoldStar0064, 0065	Noblex.....02670073, 0074, 0131
Asha0267	Gradiente0027	Olympus0062	Semp.....0072
Audiovox0064	HI-Q0074	Optimus ...0189, 0075, 0064, 0131	Sharp0075
Beaumarck0267	Harley Davidson0027	Orion0029, 0211, 0236	Shintom0099
Bell & Howell0131	Harman/Kardon0065, 0108	Panasonic0062, 0189, 0252,	Shogun0267
Broksonic0148, 0211, 0029,	Harwood00990643	Singer0099
.....0236	Headquarter0073	Penney.....0062, 0267, 0064,	Sony.....0060, 0059, 0027, 0062
CCE0099, 0305	Hitachi0069, 0027, 00680069, 0065	Sylvania ..0062, 0108, 0027, 0070
Calix0064	Hughes Network Systems ..0069	Pentax0069	Symphonic.....0027
Canon0062	JVC0094, 0068	Philco0062, 0236	TMK0267
Capehart0047	Jensen0068	Philips0108, 0062, 0645	Tatung.....0068
Carver0108	KEC0064, 0305	Pilot0064	Teac0027, 0068
Cineral0305	KLH0099	Pioneer0094	Technics0062, 0189
Citizen.....0305, 0064	Kenwood0068, 0094, 0065	Portland0047	Teknika0027, 0062, 0064
Colt0099	Kodak0062, 0064	Profitronic.....0267	Thomas0027
Craig.....0064, 0099, 0074, 0267,	LXI0064	Proscan0087, 0787	Tivo0645
.....0298	Lloyd's0027	Protec0099	Toshiba0072, 0070
Curtis Mathes0062, 0068,	Logik0099	Pulsar0066	Totevision.....0064, 0267
.....0087, 0189, 0787	MEI0062	Quarter0073	Unitech0267
Cybernex0267	MGA0070, 0267	Quartz0073	Vector0072
Daewoo0305, 0588, 0047,	MGN Technology0267	Quasar0062, 0189	Vector Research0065
.....0072	MTC0027, 0267	RCA0087, 0176, 0069, 0062,	Video Concepts.....0072
Daytron0047	Magnasonic03050075, 0133, 0267, 0787	Videosonic0267
Denon0069	Magnavox0062, 0108, 0027,	Radio Shack0027	Wards ...0062, 0087, 0027, 0074,
Dynatech00270066, 0176	Radix00640267, 0069, 0075, 0099, 0108,
Electrohome0064	Magnin0267	Randex00640176, 0787
Electroponic0064	Marantz.....0108, 0062	Realistic0027, 0131, 0074,	White Westinghouse0305,
Emerex.....0059	Marta00640075, 0064, 0062, 0073	XR-10000099, 0027, 0062
Emerson0211, 0029, 0236,	Matsushita0062, 0189	ReplayTV0641, 0643	Yamaha0065
.....0305, 0148, 0588, 0027, 0064,	Memorex0131, 0074, 0027,	Runco0066	Zenith ...0066, 0027, 0060, 0236
.....00700064, 0075, 0062, 0073, 0267,	STS0069	
Fisher0074, 01310334, 0066, 0189, 0236	Samsung0072, 0267	

ON SCREEN INSTALLATION

When you install a new system, you can skip the installation procedure if all the defaults listed on page 30 apply. When the Welcome screen displays, press the ▼ button and OK.

The Installation Wizard is a first time setup that includes entering your zip code, selecting the dish configuration, pointing the dish, setting up the VCR controls (DSX5375R only), and testing the system. A series of screens will be displayed and you will be prompted with onscreen instructions. Once you have entered all the requested information, a System Test screen displays. Be sure you have contacted DIRECTV and arranged for service. For installing your satellite dish and making connections, refer to the separate installation guide for the satellite dish.

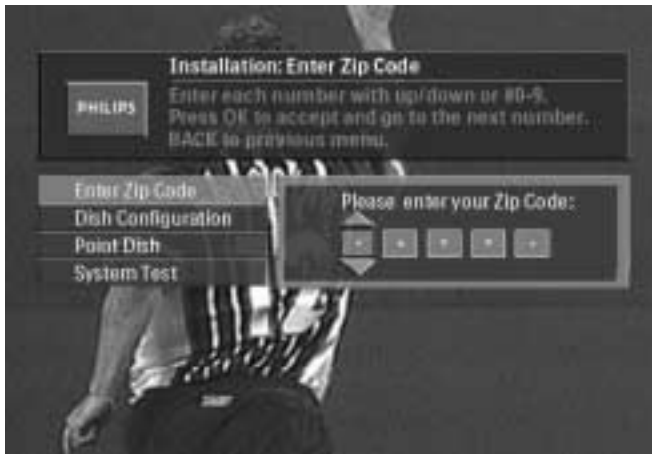

Dish Configuration

Use this function to identify the type of satellite antenna dish.

- 1 At the Installation menu, select Dish Configuration by using the ▲ ▼ buttons to highlight this option. Press OK.
- 2 Use the ▲ / ▼ buttons to highlight the dish you have.
- 3 Press BACK to return to the Installation menu.

Welcome

Follow these 4 easy steps and be on your way to enjoying a new viewing experience.

Select **OK** to go to the Installation Wizard.

Skip the Installation Wizard by pressing **▼** then **OK**.

Go to the Installation Wizard
Skip the Installation Wizard

Enter Zip Code

Use this function to correctly position the satellite antenna.

- 1 At the installation menu, select Enter Zip Code by using the ▲ ▼ buttons to highlight this option. Press OK.
 - 2 Enter the zip code using the numeric buttons on the remote.
- Or,
- 3 Use the ▲ / ▼ buttons to increment the number in the zip code field. Press the ► button to move to the next field. When all the digits have been entered, press BACK or OK to return to the Installation menu.



Please choose the option that best matches your setup.

SMART HELP



- If you don't see these screens, go to Access Control on page 33.
- If the incorrect zip code is entered follow the instructions detailed on this page.

Next, go to Dish Configuration on page 20.

ON SCREEN INSTALLATION (CONT'D)



VCR Control (DSX5375R only)

Use this function to set up the receiver to automatically record programs on your VCR. Please make sure the VCR Controller is correctly positioned in front of your VCR and connected to the VCR CONTROL output jack.

- 1 At the installation menu, select VCR Control by using the ▲ or ▼ buttons to highlight this option. Press OK
- 2 An intermediate screen will appear stating that it is important to consult this section of the manual before proceeding. Press OK
- 3 Refer to page 21 for setting up the VCR Controller

System Test

This option performs a test of system. This information is useful if you need to contact customer service.

- 1 At the Installation menu, select System Test, then press OK. After a few seconds, the test results will appear on screen.
- 2 Use the ▲ or ▼ buttons to scroll through the dialog. Press the Page +/- buttons to scroll by a full page.
- 3 Press BACK to return to the Installation menu.

The on-screen Installation should now be complete. If you are not receiving a good picture (or are encountering other signal problems), first repeat these steps. If this does not help, refer to the Smart Help section of this manual (page 39).

Point Dish

Use this function to manually point the dish to determine that it is correctly aligned with the satellite(s). Refer to the separate satellite dish Installation Guide for instructions on how to physically adjust the satellite dish angles. You may want to have a helper to read the onscreen displays during this procedure. Signal strength readings change approximately 2 seconds after the adjustment is made. Note that single dish installations often show higher signal strength than installations which receive signals from two or three satellites. The onscreen display will tell you how to align your dish based on your zip code.

- 1 At the Installation menu, select Point Dish by using the ▲/▼ buttons to highlight this option. Press OK.
- 2 The on screen displays a signal strength meter. Adjust the dish until the signal strength meter stabilizes at a maximum reading. The range is 0 to 100. It is recommended to obtain a signal strength of at least 60.
- 3 Press BACK to return to the installation menu.

NOTE:

Use the ▲ or ▼ buttons to switch between satellites. Use the ◀ or ▶ buttons to switch between transponders for the selected satellite.



ON SCREEN INSTALLATION (CONT'D)

After the initial installation, you may want to later access the installation features, for example, if you have moved the dish. The following sections describe the steps in the Installation menu.

To access the installation menu:

- 1 Press the MENU button on the remote.
- 2 Choose Installation by using the ▼ button to highlight this option. Press OK.
- 3 Follow instructions beginning with enter zip code on page 19.



VCR CONTROLLER (DSX 5375R ONLY)

VCR Controller Set Up (DSX5375R only)

This section describes how to select a VCR Brand, VCR Code, and make sure it all works.

To access the installation menu:

- 1 Highlight your VCR Brand in the list of VCR manufacturers using the ▲ or ▼ buttons. Using PAGE+/- buttons will move through the list more quickly. Press OK
- 2 Use the ▲ or ▼ buttons to highlight VCR Code. Press OK
- 3 Select the first code, if more than one, in the list. Press OK
- 4 Using the ▲ or ▼ buttons, select Test and press OK.
A message will appear asking for a blank tape to be inserted, the VCR to be tuned to the correct input channel, and power turned off. Follow the instructions and press OK
- 5 A sequence of events will occur to power on the VCR, record a program, stop recording, and power off the VCR.
- 6 Power on the VCR, rewind the tape, and press play to see if a recording was made.
- 7 If recording is not successful, select the next code in the VCR code list, press OK, and return to step 4. Repeat these steps as necessary.
- 8 If recording is still not successful, check the VCR controller, cord, and connection to the receiver. Make sure the VCR controller is positioned in front of the VCR infrared sensor.



Banner Recording (DSX5375R only)

Allows the information banner to be turned on or off at the beginning of the recording.

- 1 Use the ▲ or ▼ buttons to highlight Banner Recording. Press OK.
- 2 If you want the banner to be recorded, select Yes using the ▲ or ▼ buttons and press OK.
- 3 If you do not want the banner to be recorded, select No using the ▲ or ▼ buttons and press OK.

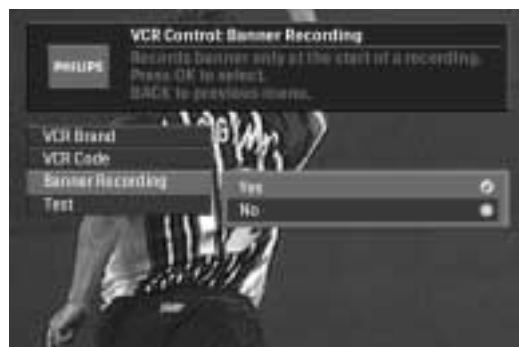

GENERAL OPERATION OF YOUR DIRECTV RECEIVER

Throughout this manual, you will notice that the everyday operation of your Satellite Receiver is based on a series of user friendly onscreen displays and menus. These displays will help you get the most from your Satellite Receiver, guiding you through initial installation, channel selection, timer settings and many other functions.

Most functions can be carried out using either the buttons on the front of your Satellite Receiver or the remote control. However, you may find it easier to use your remote control in most instances.

BANNER

You can display a program banner by pressing the INFO button on the remote when in TV mode. The banner can also display notices, help text, icons, and details about the selected program.

Short Banner

- 1 While you're viewing a program, pressing the INFO button on remote displays the Short banner.
- 2 Pressing INFO again displays the long banner. The banner displays for the time duration you set in Menu mode (refer to page 31).
- 3 To remove the banner, press EXIT.

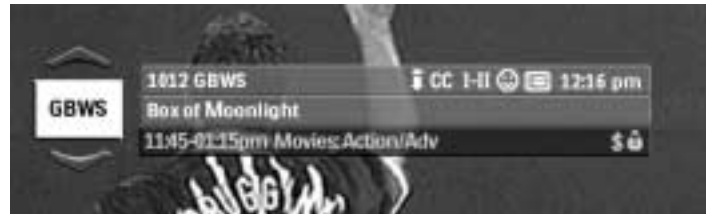

Long Banner

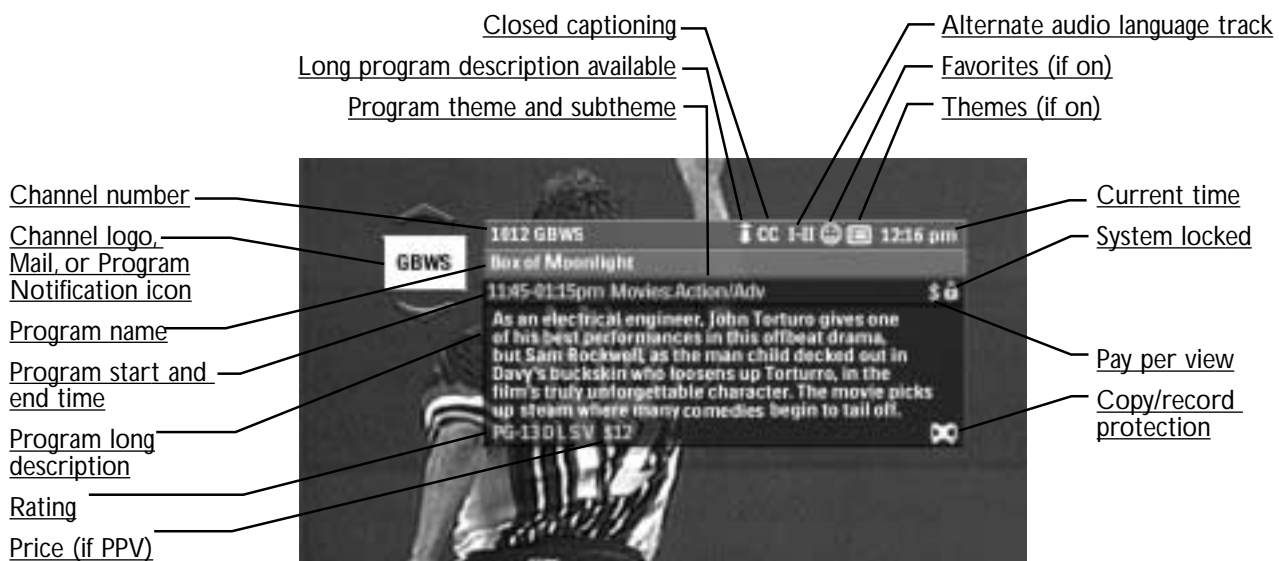

NOTIFICATION DISPLAYS

Browse Banner

While watching a program, you can view information about other programs using the Browse Banner feature. Press the PAGE+/- buttons to cycle through channels. As you select a channel, the short banner for the program is displayed.

Long program information is not available in the Browse banner.

Press EXIT to return to the same channel, or press OK to tune to the browsed channel.

When FAVORITES or THEMES are selected, the short and browse banners show only information about programs from the favorites and/or themes lists (refer to page 27).



Song ID Displays

When you select a channel that contains audio only, information about the currently playing music selection is displayed for each new song. Pressing INFO redisplay the song information and the short banner.

Notification Displays

Notifications that a tagged program (see page 28) is about to begin and the arrival of new mail are displayed in the channel logo space.

Notifications are displayed in the order in which they are received. After 10 seconds, the next notification displays.



Tagged program notification icon displays three minutes before a tagged program is about to start. Press OK to tune to the channel. Press EXIT to remove icon.



The mail icon appears if you have received new mail. See page 38 for details



DIRECTV® PROGRAMMING GUIDE

The DIRECTV Programming Guide offers complete TV listings and access to much more. The Guide lists programs according to their time slot and channel. With it, you can tune to a program, be notified when a program is about to start, order pay per view programs, search through listings by the type of program you're looking for, and tag programs for future viewing. You can also access the menu, other guides, a tag list, and online help from the Guide.

The **channel scroll elevator bar** shows the position of the channel relative to the total number of channels. The number of channels is based on the FAV/THEMES list (refer to page 27). To move up or down, press the PAGE+/- buttons.

The **channel list** shows the channels available based on FAVS/THEMES/SUBTHEMES currently selected.

Arrows indicate that the program extends beyond the time slot shown.

The **Tag mark** indicates that the program has been selected for future viewing. If a program is tagged, the tag will always display in the Guide cell. The system will notify you before the program starts so that you can tune to it.

The **Program list** shows all the programs airing in a given time slot. If program names are too long to fit into a guide cell, they may be shortened or not displayed at all. When a program is selected, its full name appears in the banner.

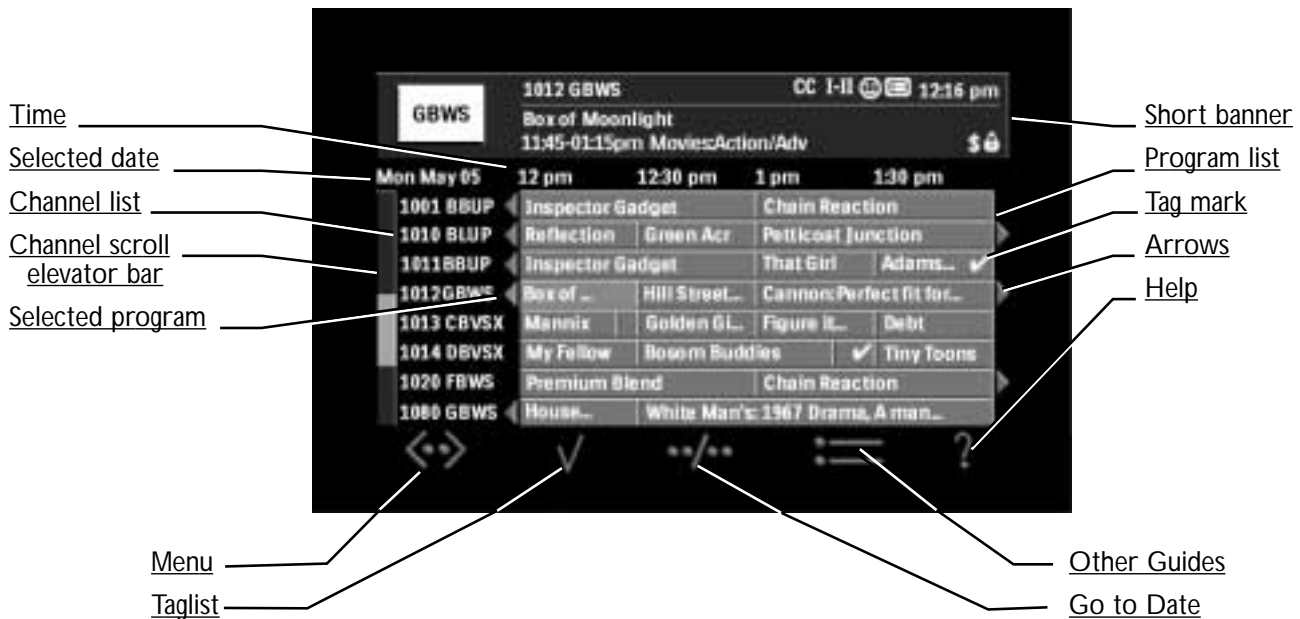





What's In the Guide

The Guide shows the programming available for a 1 1/2 hour period. Programs you can tune to are determined by settings you make in Menu mode. For example, if you set maturity rating at PG-13, you will not be able to tune to programs with higher maturity ratings such as R without first entering an access code if you have locked the system (see page 33).

The Guide also displays network channel information in the banner. When you are displaying programming for the current time, press the ◀ button, the highlight will shift to the channel list and display the selected channel's information in the banner. Long channel information is available when you press INFO. To redisplay program information, press the ▶ button.

Using the Guide

To do this....	Do this....
Display the Guide	Press the GUIDE button on the remote control.
Scroll through the program list	Press the ▲ / ▼ buttons. Press a button continuously to scroll faster. You can use the PAGE+/- buttons to scroll a full page at a time.
Tune to a current program	Use the ▲ / ▼ buttons to scroll through the list of current programs, then press OK. Or Enter the channel's number on the remote control's numeric pad and press OK.
Scroll to another time slot	Press the ◀ / ▶ buttons. Press a button continuously to scroll faster. When you go into past programming, channel information displays in the banner.
Choose a program to view	Press the arrow buttons until the program you want to view is highlighted in the Guide. If the program is in the current time slot, pressing OK tunes to the selected channel and displays the short banner for the program. If the selected program is PPV, the PPV dialog displays. If the program is in a future time slot, the Tag dialog displays so you can add the program to your viewing schedule. If it is already tagged, the Untag dialog displays.
View the "long" information	You can toggle between the display of short and long program and channel banner information by pressing the INFO button on the remote.
Display Favorites 	Press FAVORITES on the remote control. The Favorites dialog displays allowing you to select a personalized channel list. When the dialog is dismissed, the Favorites icon displays at the top of the banner and the Guide contains listings of channels that belong to the selected Favorites list. FAVORITES lists are set up in Menu mode. Refer to page 27.
Display Themes 	Press the THEMES button on the remote control. The Themes dialog displays letting you select from program themes and sub-themes. When the dialog is dismissed, the Themes icon displays at the top of the banner and the Guide lists programs for the selected theme. Refer to page 27.
Purchase a PPV program 	When you select a PPV program, a \$ displays in the banner, indicating that it is PPV. When you press OK, the PPV dialogs display and prompt you through the purchase procedure. If it is a future program, it is tagged. Refer to page 26.
Lock the Satellite Receiver 	In Menu mode, you can lock the Satellite Receiver to prevent unauthorized viewing (details on pages 33-34). When locked, a lock icon displays in the banner. When you try to tune to a locked item (channel, exceed maturity rating threshold or PPV), a dialog displays. It prompts you to enter the four-digit access code. The Satellite Receiver then tunes to the channel and the banner displays the unlock icon for the rest of the viewing session. The system remains unlocked until it enters standby mode.

Using the Guide (cont'd)

To do this....

Tag a program for future viewing or recording to a VCR



Tag for viewing



Tag for recording

Do this....

You can set up your viewing or recording schedule ahead of time, so that you will be automatically notified of the shows you want to see, or using the VCR Controller, automatically record future programs to your VCR. This is called 'tagging'. On the Guide, tagged programs either have a check mark or a loop to the right of the program title

When a program has been tagged for future viewing or recording, the notification banner displays 3 minutes before the program starts. For programs tagged for viewing, press OK to tune to the channel. For programs tagged for recording, the receiver will automatically tune to the channel.

You can still purchase future PPV programs after 25, but you will not receive a tag notice.

To tag a non-PPV program:

1. Highlight a future program to tag and press OK. In the Tag for Notification dialog, choose whether you want to tag this program once, daily, weekly, or Monday-Friday. Remember, you are actually tagging the time slot, so if the program moves to a different time slot, you will want to retag it.
2. Press OK on the Tag for Notification dialog.

If the program is in the same time slot as another tagged program, the system will prompt you that a conflict exists.

To tag a PPV program:

1. Highlight a future program to tag.

The PPV dialog displays. When you have completed the purchase, the program will be tagged.

Untagging a tagged program

To untag a program:

1. Highlight the program and press OK.
2. In the dialog, choose Once if you want to untag a program for one time slot only, or Always if a program has been tagged more than once, for example, a program that airs every day. Then, press OK.

Pay per view programs include special programming, movies, and sporting programs and are indicated by a "\$" in the banner. In the Guide, you can preview most currently airing PPV programs, purchase current and future PPV programs, and cancel a purchase. In Menu mode, you can view the purchase history, cancel purchases, and restrict this feature by setting rating and spending limits.



Some PPV programs cannot be taped. This is indicated by the recording restriction icon at the lower right corner of the banner. Some copy protected programs may be taped using the VCR control feature (DSX5375R only), but will have a higher purchase price.

To preview a PPV program occurring up to 30 minutes into the program:

- 1 Highlight the currently airing program in the Guide and also while using the ▲ / ▼ buttons.
- 2 If a preview exists, it will automatically be tuned to when you press OK or use the ▲ / ▼ buttons.
- 3 You can purchase the program by pressing OK at any time during the preview. At the end of the preview, a dialog displays containing alternate start times (if available) and pricing. If you decide to purchase the program,

Pay Per View (PPV)

To purchase a PPV program:

Highlight the program in the Guide and press OK.

- 1 In the purchase dialog, choose "Buy Now" and press OK.
- 2 If alternate start times or pricing are available, a dialog displays in which you can choose the start time. Press the ◀ / ▶ buttons to select alternate start times.
- 3 Press the ▲ / ▼ buttons to move to the next selectable item (if available), then press the ◀ / ▶ buttons to select an option.
- 4 If you select a program start time that conflicts with a tagged program, you will be notified to untag the conflict program before you can tag the new program.
Press OK to confirm the selections and remove the dialog.
- 5 If you have locked your Satellite Receiver and have not entered your access code during this session, the access code dialog displays and prompts you to enter your access code. Enter the access code and press OK.
- 6 If you purchased a future PPV program, the program will have a checkmark next to it in the Guide.
Press the EXIT button to exit out of this setting.

FAVORITE CHANNELS

Favorite channels is an exciting way to customize the listing of channels so that only programming that interests you will be displayed within the Program Guide. For information on configuring, editing, and navigating Favorite Channels, please turn to page 32.

THEMES

 Choosing Themes causes the Guide to highlight the programs whose themes match your choices. When changing channels, you will go only to channels containing programs that have the selected themes (smart surf). You can choose any or all of the themes and sub-themes. When themes are selected, the Themes icon displays on the top line of the banner.

To select Themes:

- 1 Press THEMES on the remote control. The Themes dialog displays (has slight delay).
- 2 Press the ▲ / ▼ buttons to highlight the desired theme. Themes which have sub-themes are indicated by an arrow to the right of the theme. To view the sub-themes, press the ▶ button.
- 3 Press OK to switch selection on and off the highlighted theme.
- 4 Press BACK to return to the main THEMES menu. Press BACK again to exit out of this mode.



ALTERNATE AUDIO

I-II Many programs are broadcast with alternate audio tracks. When alternate audio is available, the alternate audio icon displays on the top line of the banner.

To change audio tracks (when available):

- 1 Press the Alt Audio button on the remote.
- 2 A dialog displays the languages available for the selected program. In the dialog, use the ▲ / ▼ buttons to highlight the language you want and press OK.

If no alternate audio tracks are available for a particular channel, the screen will state only the language available with a check mark to the side. To exit press EXIT.



OPTIONS MENU

The bottom of the Guide screen contains five icons which you can access by pressing the MENU button on the remote control when the Guide is displayed. Use the ◀ / ▶ buttons to highlight an icon and press OK to view its dialog box. To exit press EXIT.



Menu

Selecting Menu takes you to the menu module, which is described in detail in the next section.

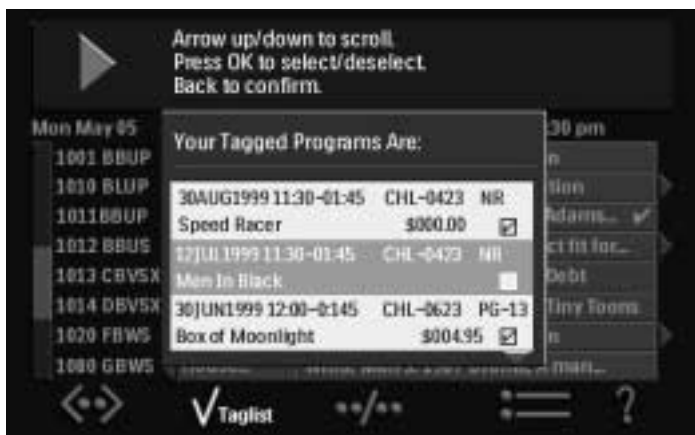
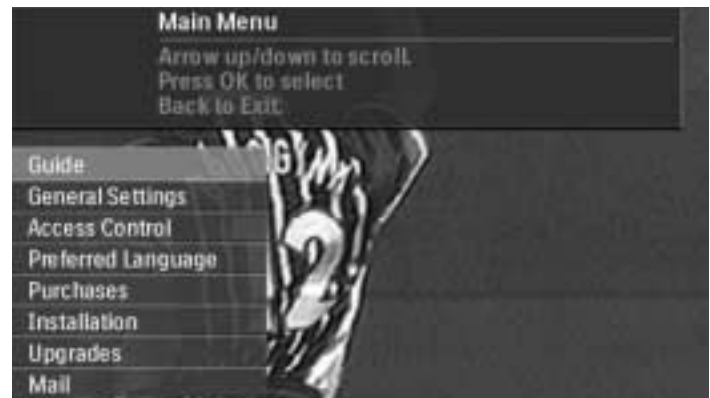

Taglist

Selecting Taglist displays the list of your tagged programs, both free and PPV. Use the ▲ / ▼ buttons to move through the list, or the PAGE+/- buttons to scroll by a full page. You can untag any program in the list. To untag a program, highlight it and press OK. Press BACK to return to the Guide. When you return to the Guide, any items untagged in the taglist will be unchecked in the Guide.

OPTIONS MENU

Go to Date

Selecting the Go to Date option lets you look at a list of programs for another day in the week. Use the ▲ / ▼ buttons to move to the day of interest, then press OK. The programming information available is limited to the master and extended program guides. When you press OK, the Guide displays programming information for the same 1.5 hour block of time displayed before you selected Go to Date, but for the day you selected.

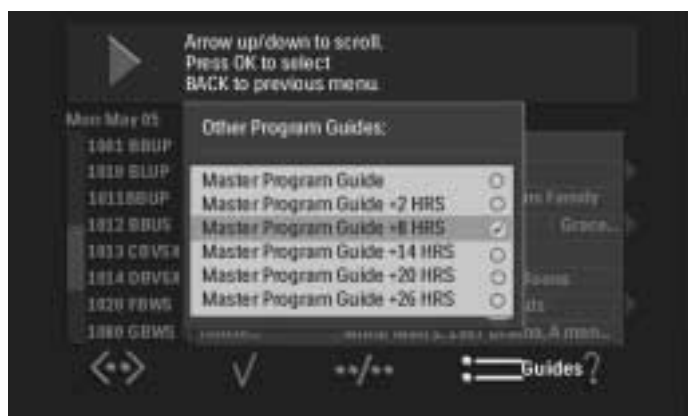

Other Guides

Selecting Other Guides displays a dialog in which you can choose a type of guide to view. Use the ▲ / ▼ buttons to scroll through the list. Use the PAGE+/- buttons to scroll to the next page. Press OK to select and display the highlighted guide. You can view and tag programs contained in any guide. To exit press EXIT.

Help

Selecting Help opens a window in which high-level help information displays. You can scroll through the help information using the ▲ / ▼ or PAGE+/- buttons. Context sensitive help is often available in the banner.

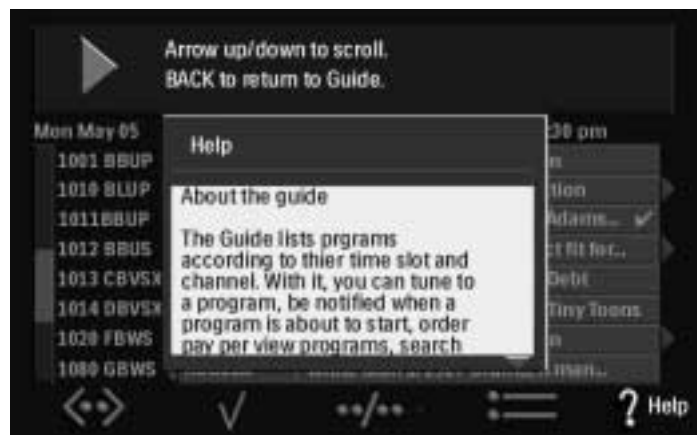

MESSAGES

The Satellite Receiver may occasionally display messages which overlay the Programming Guide. To dismiss a message, press OK.

Software Upgrade Message

When DIRECTV schedules or transmits a software upgrade, you will be notified by an onscreen message. Once a software upgrade is complete, your Satellite Receiver is ready to use. Old software cannot be restored.

USING THE MENU

The Menu lets you customize the features of your Satellite Receiver. Categories include Guide, General Settings, Access Control, Language, Purchases, Installation, Upgrades, and Mail.

In Menu mode, the following buttons on the remote control are inactive: FAVORITES, THEMES, GUIDE, and ALT AUDIO.

To access the main menu from the Guide:

Press the MENU button on the remote control then press OK.

To access the main menu from the TV:

Press the MENU button on the remote control.

To exit the menu:

Press the MENU button on the remote control. This removes the menu from the screen and accepts all the changes you have made.

To return to your program and cancel a transaction: Press EXIT.

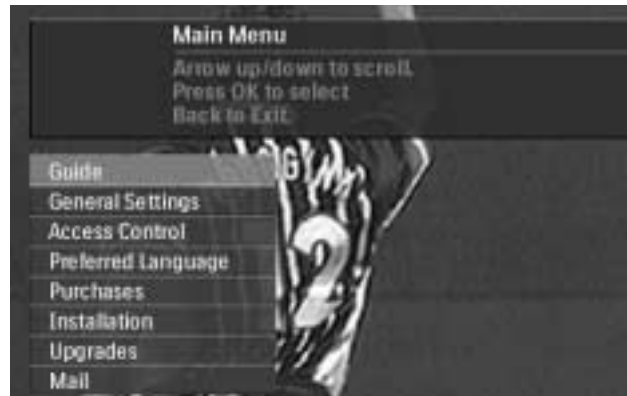

Menu Mode Defaults

Menu mode has the following defaults:

Screen Format:	Full screen (4:3)
Banner Duration:	5 seconds
Favorites Names:	Maximum 4 lists. List 1, List 2, List 3, List 4. 10 Ten characters per list name
Favorites Channels:	All channels selected for each list
Channel Lock:	None
Maturity Rating:	R
Per-Purchase Limit:	\$10.00
Access Code:	0000
Access Code Mode:	Unlocked
Menu & Guide Language:	English
Audio Track Language:	English
Dish Configuration*:	Single

The following sections tell you how to change these settings.

* Described in the Installation section (see page 19).

Navigating In Menu Mode

To navigate through the menus, use the ▲ / ▼ buttons to highlight an option. Then press OK to confirm the selection and display a sub-menu or dialog. Selecting items on a sub-menu displays a dialog in which you can change settings or review parameters. To navigate within a dialog, press the ▲ / ▼ buttons. To accept changes and return to a sub-menu, press OK. If the dialog contained non-exclusive choices, press OK and BACK. Or, to simply return to the previous menu, press BACK.

When selections in the menu are made, checks (✓) appear next to the selections.

GENERAL SETTINGS

The General Settings option on the main menu let you change the screen format, change the banner duration, and set the favorite channels list. To change general settings, navigate to the General Settings option on the main menu and press OK. In the menus that display, use the ▲ / ▼ buttons to highlight your selection, then press OK to confirm the selection. Press BACK to return to the main menu.

GENERAL SETTINGS (CONT'D)

Screen Format

Screen format defines the width/height ratio of the picture. Options are wide (16:9) or full screen (4:3). Because programs are transmitted in a variety of formats, your screen format settings will affect position of the picture on your TV. The effects of these settings are shown in the chart below.

RESULTS

- A: images appear as broadcasted
- B: black bars are added to the left and right of the images, or the image is stretched (dependent on your TV set)
- C: image is truncated at the left and right
- D: image appears as broadcasted

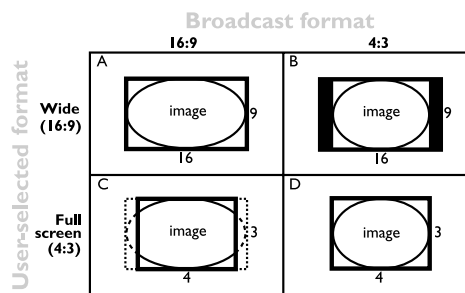

Selecting a Screen Format Header

- 1 Press MENU.
- 2 The Guide option will be highlighted. Press ▼ to select General settings. Press OK.
- 3 "Screen Format" will be highlighted. Press OK.
- 4 Use the ▲ / ▼ buttons to choose from the selections.
- 5 Once you have made your selection, press OK.

Banner Duration

Banner durations define how long the program information banner remains on the screen after you tune to a program. Options are 5, 10, 15, or 20 seconds.

- 1 Press MENU.
- 2 The Guide option will be highlighted. Press ▼ to select General settings. Press OK.
- 3 "Banner Format" will be highlighted.
- 4 Use the ▲ / ▼ buttons to choose from the selections.
- 5 Once you have made your selection, press OK.
- 6 Press BACK twice to exit.

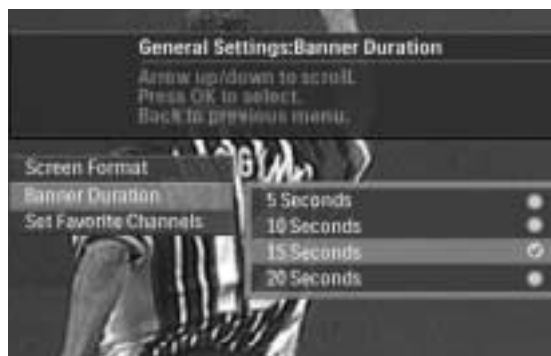

Favorite Channels



Once Favorites is configured, the Favorites icon displays on the top line of the banner and programs displayed in the Program Guide are only those in the selected list. When using the CH ▲ and CH ▼ buttons, you are limited to channels in the favorites list; however, you can access any channel by entering its number from the remote control.

You can save up to four different favorite channel lists. This way, members of a household can each set their own favorite channels.

To Configure or Edit A Favorites List:

- 1 Go to the Set Favorite Channel menu.
- 2 Choose Change List and select the list you want to change.
- 3 Press OK. The Change List submenu displays.
- 4 Use the ▲ and ▼ buttons to choose Manual, Select All, or Deselect All.

Manual Select shows a list of all available channels. A checkmark is displayed next to channels on your favorites list. You can switch the checkmark by highlighting the channel and pressing OK.

Select All selects all channels in the list. You can then manually deselect any channel by using the Manual Select functions.

Deselect All deselects all the channels in the list. You can then manually select any channel.

Use the ▲ and ▼ buttons to navigate through the list, or use the PAGE +/- buttons to scroll the list up or down by a complete page.

You can also move to a channel by entering its number using the numeric buttons on the remote control. The channels list automatically scrolls to the channel whose number you entered.

Press OK to switch the check marks on the channel. Press BACK to confirm the selection(s).

To Edit A Favorites List Name:

- 1 Press MENU.
- 2 Use the ▲ / ▼ buttons to choose General Settings. Press OK.
- 3 Select the Set Favorite Channel menu. Press OK.
- 4 Choose Change Name.
- 5 Use the ▲ / ▼ buttons to select the list whose name you want to edit. Press OK. The Edit Name dialog displays.
- 6 Use the ▲ / ▼ buttons to scroll through the alphabet. When the letter you want displays, press the ◀ or ▶ to confirm the selection and move to the next character in the name.
- 7 Press OK to confirm the edited name.
- 8 Press BACK to return to the previous menu.



To display favorite channels:

- 1 Press FAVORITES on the remote. A dialog displays in which you can select a favorites list.
- 2 Press the ▲ / ▼ buttons to highlight the desired list and press OK. A checkmark displays to the right of the selected list. Program Guide displays only programs from your favorite channel list. You will only be able to use the CH ▲ and CH ▼ buttons to select channels on the list.

ACCESS CONTROL

With Access Control, you can lock or unlock the system, change the password, lock channels, set spending limits, set maturity ratings, and replace the access card when requested by DIRECTV.

- 1 Press MENU.
- 2 The Guide option will be highlighted. Press ▼ to select Access Control.
- 3 Press OK.
- 4 Use the ▲ / ▼ buttons to choose from the selections.
- 5 Once you have made your selection, press OK.

Access to all of these functions can be restricted by a password. If the access code mode was previously set to locked (details below) a lock icon displays in the banner.

You can view settings including Channel Lock, Purchase Limit, and Maturity Rating without unlocking your system. However, you must unlock it to change any of these settings. Unlocking the system (if locked) requires knowledge of the correct password.

Change Password

The password is four digits. You can change it at any time. Be sure to write it down in case you forget it.

To change your password:

- 1 Be sure you have unlocked the system using the steps above.
- 2 Choose Change Password from the Access Control menu and press OK.
- 3 Enter the current password using the numeric buttons on the remote or by using the ◀ / ▶ buttons to move from one field to another. Use the ▲ / ▼ buttons to scroll password numbers. Press OK.
Enter the new password.
- 4 You will be prompted to enter it again to verify it. Press OK. Press BACK to return to the previous menu.



Lock/Unlock The System



Your Satellite Receiver can be locked or unlocked. When it is locked, the system will prompt you to enter the password whenever you want to change settings in the following: lock channels, change maturity levels, change purchase limits, change the password, or replace the access card.

A locked system is indicated by the lock icon in the banner. To unlock the system, enter the password as described below.

To lock or unlock the system:

Choose Lock/Unlock the System from the Access Control menu. When the system prompts you for a password, enter it using the numeric buttons on the remote control. After the last digit is correctly entered, the password is automatically validated.

ACCESS CONTROL (CONT'D)

Channel Lock

Locking channels prevents a viewer from accessing the channels by requiring that the password be entered first. You must lock the system to enforce these settings. Locked channels are indicated by the lock icon to their right. Use the ▲ / ▼ buttons to choose Manual Lock, Lock All, or Unlock All.

Manual lock lets you lock individual channels. When you choose this option, a list of all available channels displays. A lock icon to the right of the channel name indicates that it is locked. Use the ▲ / ▼ buttons to navigate to a channel. Use the PAGE +/- buttons to scroll by a full page. Press OK to confirm the selections and go to the previous menu.

Lock All lets you lock all channels. Use the ▲ / ▼ buttons to highlight either Yes or No, then press OK to confirm the selection and go to the previous menu.

Unlock All lets you unlock all channels. Use the ▲ / ▼ buttons to highlight either Yes or No, then press OK to confirm the selection and go to the previous menu.

Press BACK to return to the previous menu.

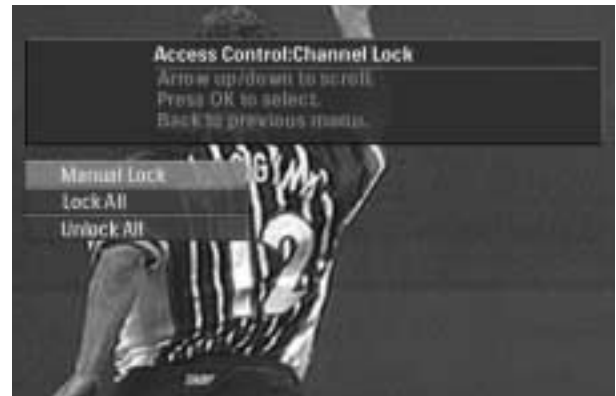

Set Spending Limit

You can set a price limit on pay per view programs up to \$655.35. This limit is per program; it is not a cumulative limit.

To set the Purchase Limit:

- 1 Choose Purchase Limit from the Access Control menu and press OK.
A dialog displays the current purchase limit.
- 2 Enter the purchase limit using the numeric buttons on the remote. Or, use the ◀ / ▶ buttons to move from digit to another, then use the ▲ / ▼ buttons to scroll the numeric entry for each digit.
- 3 Press OK to confirm the selection. Press BACK to return to the previous menu.

ACCESS CONTROL (CONT'D)

Rating Limit

Maturity ratings help you determine a program's content, similar to the way films are rated. For example, a rating of "G" is a program suitable for general audiences, while a rating of "R" might be suitable for adult only viewing. When you lock a particular rating, all ratings exceeding the locked rating are automatically locked as well. For example, if you lock "NC-17", "R" will be automatically locked. Locked programs are displayed in the Guide and the Lock icon is displayed in the banner. To view a locked program, you must first enter an password. You must lock the system to enforce these settings.

To set the Maturity Rating:

- 1 Choose Maturity Rating from the Access Control menu and press OK.
A ratings list displays. A lock icon to the right of the rating indicates that it is locked.
- 2 Use the ▲ / ▼ buttons to navigate to a rating.
- 3 Press OK to confirm the selection.



Replace Access Card

Occasionally, your service provider may require you to replace your access card. If so, you will receive instructions with the card for performing the function.

PREFERRED LANGUAGE

Many programs are broadcast with program guide information and audio tracks in different languages. You can choose the language you prefer for the Menu and Guide and for the audio track.

Note: not all programs offer multiple languages. If the selected program is not available in the language, it defaults to the first listed audio track.

To choose the language:

- 1 Press MENU.
The Guide option will be highlighted. Press ▼ to select Preferred Language.
- 2 Press OK.
- 3 Use the ▲ / ▼ buttons to choose either Menu and Guide or Audio Track.
The currently selected language has a checkmark to its right.
- 4 Use the ▲ / ▼ buttons to choose the language from the list.
- 5 Press OK.
If desired, repeat steps 3-5 to change the other option.

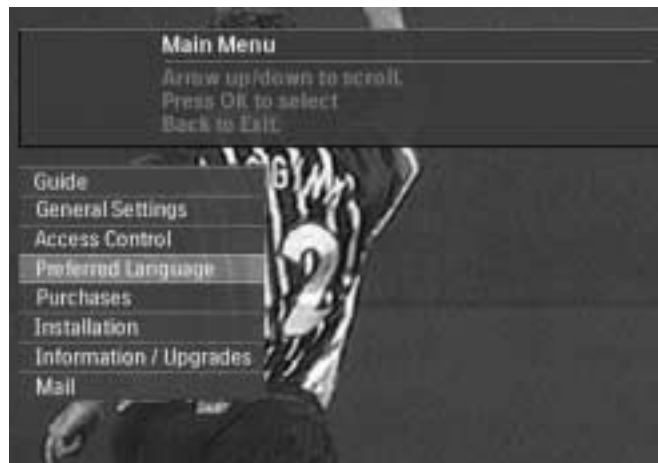

PURCHASES

Use the Purchases dialog to view completed or pending purchases.

Completed Purchases

Completed Purchases displays a summary of your past purchases including the program and channel name, program date, presentation start and end time, price, and whether the program was viewed or cancelled. Information for all past purchases is stored on the access card and displayed with the most recent purchase first.

To view completed purchases:

- 1 Press MENU.
- 2 The Guide option will be highlighted. Use the ▲ / ▼ buttons to choose from the selections.
- 3 Choose Purchases from the main menu and press OK.
- 4 Use the ▲ / ▼ buttons to choose Completed.
- 5 Press OK.
- 6 A list of completed purchases displays indicating whether they were viewed or cancelled. You can scroll through the list using the ▲ / ▼ buttons or using the PAGE+/- buttons to scroll by a full page.
- 7 Press BACK to return to the previous menu.



Pending Purchases

The Purchases: Pending screen displays all pay per view (PPV) programs that you have purchased but have not yet viewed. You can cancel any PPV programs which you have not yet watched or did not watch. Information displayed to cancel a purchase includes the program and channel name, program date, presentation start and end time, price, and rating. Information for all purchases is stored on the access card and displayed with the most recent purchase first.

Note: you cannot cancel a PPV purchase if you have already tuned to the program.

To cancel purchases:

- 1 Press MENU.
- 2 The Guide option will be highlighted. Use the ▲ / ▼ buttons to choose from the selections.
- 3 Choose Purchases from the main menu & press OK.
- 4 Use the ▲ / ▼ buttons to choose Pending. Press OK.
- 5 A list of pending purchases and purchases that were ordered but not viewed displays. You can scroll through the list using the ▲ / ▼ buttons or using the PAGE+/- buttons to scroll by a full page.
- 6 To delete a pending purchase, highlight it and press OK. The checkmark disappears from the right of the program's name.
- 7 Press BACK to return to the previous menu. All unchecked programs will be deleted from the pending purchases list.
- 8 If desired, you can verify the purchase was canceled by viewing Purchases: Pending.

INSTALLATION

For Installation instructions, please turn to page 21.

UPGRADES

The Upgrades dialog displays configuration and version data which is helpful if you need to report problems to a customer service representative. This dialog lets you scroll line by line both forward and back as well as complete page up and page down. The information presented is for viewing only.

To view upgrades:

- 1 Press MENU.
- 2 The Guide option will be highlighted.
- 3 Use the ▲ / ▼ buttons to choose Upgrades from the selections.
- 4 Once you have made your selection, press OK.

Software Upgrade Message

An on-screen message will notify you when DIRECTV schedules or sends a software upgrade. Once a software upgrade is complete, your Satellite Receiver is ready to use. Old software cannot be restored.

Your Satellite Receiver is able to receive upgrades or modifications to some of its features and functions. These modifications will occur automatically, usually at times when the Satellite Receiver is likely to be turned off. If your Satellite Receiver is on when an upgrade or modification is sent, reception may be interrupted for a minute or two. Reception should return to normal after the modification is complete. Your Satellite Receiver must be plugged in to receive an upgrade. Do not unplug your Satellite Receiver while an upgrade is in progress. Consult the Upgrade Menu to find a schedule of upgrades or modifications planned by DIRECTV.

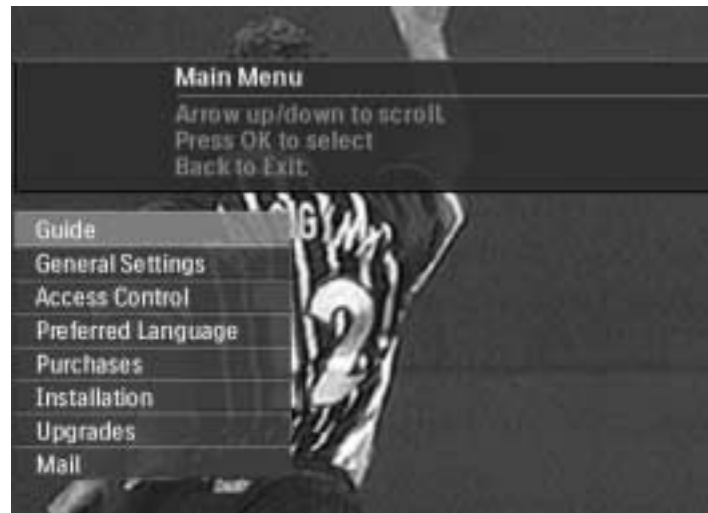

MAIL



Your service provider will periodically send you messages. When you receive new mail, the pigeon mail icon appears at the logo space on the main menu and Guide. You can view and delete messages. Each message includes the date and time it was sent. A maximum of 30 messages can be stored. When new messages are received, the oldest message is automatically deleted if the maximum amount of messages is exceeded. The banner on the Mail screen indicates how many messages you have.

To view mail:

- 1 Press MENU.
- 2 The Guide option will be highlighted.
- 3 Use the ▲ / ▼ buttons to choose Mail from the selections.
- 4 Once you have made your selection, press OK.

To delete a message:

- 1 When a message is displayed, press OK to remove the checkmark to its right. When you press BACK, all unchecked messages are deleted.

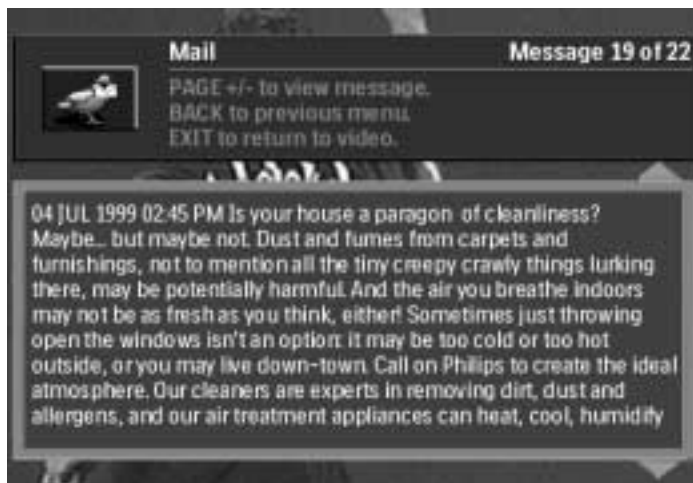

SMART HELP

Where To Find Help



The banner area at the top of the display provides context sensitive help text based on the menu, sub-menu, or object you select. General help is available by highlighting the "?" icon at the bottom of the Guide screen and pressing OK.

Error messages that display on the screen are self-explanatory. Some possible error messages are explained below. To remove an error message from the screen, press OK.

No picture, no sound, power indicator LED does not light.

- Receiver is not plugged into the AC outlet or is not switched on.
- Check AC outlet connection. Press the ON/OFF button on the front of the Satellite Receiver.
- Check batteries in the remote.

No picture, no sound.

- The receiver is in standby.
- Check connections from the Satellite Receiver to the TV.
- Turn Satellite Receiver off, unplug, wait 10 to 15 seconds, plug back in, and try.

Arrow buttons don't work.

- Make sure no objects obstruct the line of sight between the remote and the Satellite Receiver.
- The remote control may need new batteries.
- See also "Screen is frozen."



Where To Find Help

The banner area at the top of the display provides context sensitive help text based on the menu, sub-menu, or object you select. General help is available by highlighting the "?" icon at the bottom of the Guide screen and pressing OK.

Error messages that display on the screen are self-explanatory. Some possible error messages are explained below. To remove an error message from the screen, press OK.

Cannot access program.

- Check that you are subscribing to the station to which you want to tune. Call DIRECTV if you are not sure.
- Be sure the system is not locked as indicated by the lock icon in the banner.

Cannot order PPV program.

- It may be too late to purchase this program. Check for other showtimes.
- Make sure the PPV option is not locked (see page 27).
- Program may exceed purchase limit.
- Your access card may be full. Call DIRECTV.
- Telephone line(s) not installed or attached correctly.

Cannot cancel PPV.

- You cannot cancel PPV orders that you've watched or tuned to. However, you can cancel programs you've ordered but haven't watched even if it has already aired.

Guide does not tune to the selected program.

- Press OK to select the program you highlighted.

Cannot display favorite stations.

- You must set up your Favorites list before favorite channels will display (see page 32).

Locks not working.

- Check that the system is locked (see page 33).

Cannot access lock screens.

- The system must be unlocked before you can make changes to the access control lock settings (see page 33).

Cannot lock or unlock the system

- Make sure you enter the correct access code. If you've lost or forgotten your access code, call DIRECTV.

No picture.

- Make sure the TV power is on.
- Make sure all power cords are connected.
- Make sure the TV input is set properly.
- Make sure the TV source is set properly on the TV. Press the TV/SAT button on the remote control.
- If you are receiving only a few stations, call DIRECTV to have your programming activated. Check that the Satellite Receiver is on. Check that the smart card is inserted properly in the Satellite Receiver (see page 12).
- Check the satellite antenna's signal strength (see page 20). To ensure a quality picture, make sure the signal is coming directly from the Satellite Receiver and not through your VCR.
- Make sure the coaxial cable is properly connected to the antenna's LNB.
- Check the cable for kinks.

Alternate audio track is not available.

- Not all programs offer alternate audio tracks and are indicated by the I-II symbol in the banner. Press ALT AUDIO to see a list of available languages.

Audio track language is incorrect.

- Check the default language settings (see page. 35). The program provider may not make available all the languages

SMART HELP (CONT'D)

displayed in the Language screen accessed in the main menu.

Access card problems.

- Check that the card is inserted properly (see page 12). Call DIRECTV.

Remote control doesn't work.

- Make sure the batteries are inserted correctly (see page 18) and are not dead. Be sure you are within operating range of the receiver.

No sound.

- Make sure the Mute isn't on.

Volume too high.

- Set TV volume to medium loudness. You can adjust the volume with the remote if it is programmed for your make and model of TV.

Screen is frozen or completely black, or Power button doesn't work.

- Try turning the Satellite Receiver power off and on again.
- Make sure the TV and VCR are set to the correct channel.

You see a message that says a software upgrade is available.

- Select Update Now. New software is available and will be installed on your Satellite Receiver automatically. Doing so is in your best interest because new features will be available and/or possible difficulties will be corrected.

During channel Up/Down, box does not go to next channel.

- When Favorites or Themes are selected, only selected channels will display in the guide.

GLOSSARY

AV Audio/Video

access card A credit-card-sized plastic card that uses smart card technology to control authorizations.

alternate audio program Alternate Audio Program lets viewers choose an alternate audio channel which may broadcast a different language, or alternate versions of the audio program.

azimuth The angular distance from true north, along the horizon, to the satellite. It is used during the process of setting up the left and right adjustment of the dish antenna. Azimuth and elevation angles are displayed on a set-up screen based on a zip code and/or latitude and longitude.

CAM Card Access Module.

CC When the closed caption symbol is displayed, the audio track can be presented as text on the viewing screen.

channel Channels are defined in the DIRECTV System to transmit a specific sequence of programming. Once defined, the guide lists programs by channel, allowing a customer to select a particular show. Valid channel numbers range from 0000 to 9999, but not all possible channels are defined and not all defined channels transmit programming all the time.

DIRECTV Service High-power, direct broadcast satellite system, developed and managed by DIRECTV, Inc.

EPG Electronic program guide

favorites A selection of channels that you like.

guide An onscreen television program guide. When you press GUIDE on the remote control, you'll see a list of TV programs broadcast on each channel. You can highlight a program title for more information about a program.

IPPV Impulse pay per view - a PPV offering that can be purchased in the home directly by the customer. This function is only available when your telephone line is connected to the satellite receiver. Purchases are captured by the access card and forwarded to DIRECTV at the next callback.

letterbox The format of a program or movie originally created for a 16 x 9 theater screen. When a letterbox program is viewed on a 4 x 3 television screen, a black area appears above and below the picture to preserve the aspect ratio.

lock symbol If you see a symbol of a padlock, it means program can be viewed only by authorized people.

Pay per view A program that has an associated viewing cost, and which may be purchased separately from any package or subscription. This could include a movie, special program, sporting program, or an adult program.

PPV Pay per view.

purchase limit The maximum dollar amount of the PPV purchase balance allowed by the access card or purchase limit set in the menu. This limit is per-program rather than a limit on total spending. Also referred to as "spending limit".

rating limit A limit set by the customer to prevent

GLOSSARY (CONT'D)

unauthorized viewing of programs with a rating at or above the set limit. For example, if a limit of R has been set, then programs rated R, TV-M, NR-Mature, or NC17 cannot be viewed without first entering an access code.

rating level Standard rating levels applied to movies and other programs to help customers determine the amount of strong language, violence, and/or sex contained in that program.

scroll A method of moving around the guide or text box when the contents are too big to fit the screen or box. When you scroll, part of the page becomes visible onscreen,

while another part moves offscreen. To scroll, you select an arrow pointing down (to see more at the bottom) or up (to see more at the top), or press the PAGE +/- button on the remote.

spending limit See purchase limit.

SPG Special program guide; for example, a program guide which contains only programs of a selected theme.

tuner A device that receives television signals and determines which TV channel is displayed. Most VCRs have tuners in them. The Satellite Receiver also has a tuner.

SPECIFICATIONS

Video Decoding

- MPEG-2 compliant (up to Main Profile/Main Level)
- Video bit rate: up to 15 Mbit/sec
- Video format: 4:3 and 16:9
- Resolution: up to 720 x 480 pixels

Audio Decoding

- MPEG-1 layer II
- Sampling frequency: 48KHz
- MPEG-1 system packets

Satellite Antenna Interface

- RF input: F-type connector
- LNB supply: 0V / 14V /18V
- LNB current: max. 450mA on 14V, 450mA on 18V
- Tone switching (on/off): 22kHz

Reception Demodulation

- QPSK Type
- Input frequency range: 950 to 1450 MHz
- Input level range: -69 to -23 dBm

Input / Output Interfaces

- Satellite input
- RF input (antenna, etc.)
- Video output: CVBS
- Audio output: Audio L/R
- Channel 3/4 (TV/VCR) output
- RJ-11 (telephone)
- S-video output (Y/C)
- VCR Control

Integrated telephone modem (Return Path)

- Built-in RJ-11 connector
- Modem type: v.22bis, Bell 212A, Bell 103
- Dialing mode: DTMF & pulse

Electrical

- Main power supply: 100V - 120V, 60Hz
- Power consumption: max. 35W (Max. 450mA of LNB current)

Environmental

- Temperature
 - Operating: 5 to 45°C
 - Storage: -10 to 70°C

Physical Dimensions

- Size: 15 in. (W) x 2.8 in. (H) x 11.4 in. (L)
(380 mm x 71 mm x 290 mm)
- Weight: 5.1 lbs. (2.3 kg)

Package Contents

- Digital Satellite Receiver
- Infrared (IR) universal remote control
 - Two AA batteries
- Access card
- Power supply cord
- User Manual
- RF coaxial cable
- RJ-11 telephone cord

INDEX

◀▶▲▼ buttons	14	Guides		entering	36
A		other	29	power on	9, 14
A/V connectors	9-11	H		PPV	27
access card	12, 13	Help	29, 39	previewing	27
inserting	12	I		purchasing	27
replacing	13	i button	14	program	
Access Control	33	info button	14	choosing	25
audio		installation		tagging for future view	26
alternate	28	connecting a TV and VCR	10, 11	untagging	26
audio tracks		connecting existing equipment	10	program banner	22
changing	28	dish configuration	20	program guide	
B		onscreen instructions	19	using	24
Back button	14	point dish	20	program notification icon	23
banner	22	zip code	19	purchase limit	
browse	23	L		setting	34
long	22	language		purchases	
short	22	choosing preference	35	future	36
viewing the long banner	25	Language button	35	future - viewing	36
banner duration	31	locking a channel	34	history	36
C		manually	34	R	
channel		locking all channels	34	rear view	9
tuning to	25	M		remote control	
channel lock	33	mail	38	installing batteries	8
channels		deleting	38	preparing for use	8
accessing locked	34	viewing	38	remote control use	14, 15, 16
favorite	32	maturity rating	35	RF connection	10
locking all	33	setting	35	S	
unlocking all	33	menu		screen format	31
D		exit	30	settings	
Date		viewing	30	general	30
go to	29	Menu	31	smart help	39
E		Menu button	14	Software Download Message	29
email icon	23	menu mode		song ID	23
Exit button	14	defaults	30	standby mode	7
F		navigating in	30	system test	20
favorite channel	32	using	30	T	
favorites		message		Taglist	28
displaying	23	deleting	38	themes	
favorites button	14	software download	38	displaying	27
favorites list		messages	38	setting	23
editing	32	Messages	29	Themes button	14
features	6	modes	7	TV/SAT button	14
front view	9	Mute button	14	U	
G		O		unlocking the system	33
general operation	21	OK button	14	untagging	26
general settings	30	Options Menu	28	V	
glossary	40	Other Guides	29	viewing purchase history	39
Guide	24	overview	6	Vol +/- buttons	14
displaying	25	P		Z	
using	25	Password		zip code	19
Guide button	14	changing	33		

LIMITED WARRANTY

Digital Satellite Receiver

90 Days Free Exchange / 91 Days-One Year Nominal Fee Exchange
This product must be carried in for repair.

WHO IS COVERED?

You must have proof of purchase to receive warranty service. A sales receipt or other document showing that you purchased the product is considered proof of purchase.

WHAT IS COVERED?

Warranty coverage begins the day you buy your product. For 90 days from the date of purchase, the Digital Satellite Receiver will be replaced with a new, repaired, renewed, or comparable product (whichever is deemed necessary) if it becomes defective or inoperative. This exchange is done at no charge to you.

From 91 days to one year from the date of purchase, you must pay a nominal fee for a new or renewed product. This exchange offer ends one year after the date of purchase.

All products, including replacement products, are covered only for the original warranty period. When the warranty on the original product expires, the warranty on the replacement product also expires.

WHAT IS EXCLUDED?

Your warranty does not cover:

- labor charges for installation or setup of the product.
- installation, performance of, or repair of audio/video cabling, telephone line, or accessory attachments used in accessory ports outside of the product.
- product replacement because of misuse, accident, lightning damage, unauthorized repair, or other cause not within the control of Philips.
- incidental or consequential damages resulting from the product. (Some states do not allow the exclusion of incidental or consequential damages, so the above exclusion may not apply to you.)
- reception transmission problems caused by signal conditions, telephone line, or cable or antenna systems outside the unit.
- a product that requires modification or adaptation to enable it to operate in any country other than the country for which it was designed, manufactured, approved and/or authorized, or repair of products damaged by these modifications.
- a product used for commercial or institutional purposes.
- DIRECTV Service is separate and distinct from this product (hardware) warranty.

WHERE IS EXCHANGE AVAILABLE?

You may exchange the product in all countries where the product is officially distributed by Philips Consumer Electronics. In countries where Philips Consumer Electronics does not distribute the product, the local Philips service organization will attempt to provide a replacement product (although there may be a delay if the appropriate product is not readily available).

MAKE SURE YOU KEEP..

Please keep your sales receipt or other document showing proof of purchase. Attach it to this owner's manual and keep both nearby. Also keep the original box and packing material in case you need to return your product.

BEFORE REQUESTING EXCHANGE...

Please check your owner's manual before requesting exchange. Adjustments of the controls discussed there may save you a call.

TO EXCHANGE YOUR PRODUCT...

An exchange will be managed by Philips. If you believe you need to exchange your Digital Satellite Receiver, contact Philips Service Solutions Group at 1-800-464-1131. A representative will go through a diagnostic checklist with you. If it is determined that the product needs to be exchanged, you will receive a return authorization number. The representative will give you complete shipping details.

TO GET OUT-OF-WARRANTY EXCHANGE...

To exchange your product after the warranty expires, contact Philips Service Solutions Group at 1-800-464-1131 to determine the cost of out-of-warranty exchange for your product.

REMEMBER...

Record below the model and serial numbers found on the product. Also, fill out and mail your warranty registration card promptly. It will be easier for us to notify you if necessary. (The return of the warranty registration card is not a condition for warranty coverage.)

Model Number _____

Serial Number _____

All implied warranties, including implied warranties of merchantability and fitness for a particular purpose, are limited in duration to the duration of this express warranty. Some states do not allow limitations on how long an implied warranty lasts, so the above limitation may not apply to you.

This warranty gives you specific legal rights. You may have other rights which vary from state/province to state/province.

Philips Service Solutions Group, P.O. Box 2976, Longview, Texas 75606, (903) 242-4800

EL6471E001 / 6-00

Free Manuals Download Website

<http://myh66.com>

<http://usermanuals.us>

<http://www.somanuals.com>

<http://www.4manuals.cc>

<http://www.manual-lib.com>

<http://www.404manual.com>

<http://www.luxmanual.com>

<http://aubethermostatmanual.com>

Golf course search by state

<http://golfingnear.com>

Email search by domain

<http://emailbydomain.com>

Auto manuals search

<http://auto.somanuals.com>

TV manuals search

<http://tv.somanuals.com>