

# DIRECTV® Receiver User Manual

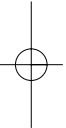
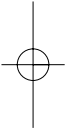

### **Read this manual first!**

*Congratulations on purchasing this Philips product.  
We've included everything you need to get started.*

*If you have any problems, Philips Representatives can  
help you get the most from your new product by explaining:*

- Hookups,
- First Time Setup, and
- Feature Operation.

*Do not attempt to return this product to the store.*

**For fast help, call us first!  
1-800-464-1131**

*Thank you for making Philips a part of your home!*

3111 176 50891

*Let's make things better.*



# PHILIPS

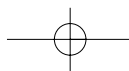

 **PHILIPS** Visit our World Wide Web Site at <http://www.philips.com>

# PHILIPS

*Congratulations on your purchase, and welcome to the "family!"*

**Dear PHILIPS product owner:**

Thank you for your confidence in PHILIPS. You've selected one of the best-built, best-backed products available today. And we'll do everything in our power to keep you happy with your purchase for many years to come. As a member of the PHILIPS "family," you're entitled to protection by one of the most comprehensive warranties and outstanding service networks in the industry. What's more, your purchase guarantees you'll receive all the information and special offers for which you qualify, plus easy access to accessories from our convenient home shopping network. And most importantly you can count on our uncompromising commitment to your total satisfaction. All of this is our way of saying welcome-and thanks for investing in a PHILIPS product.

Sincerely,



Lawrence J. Blanford  
President and Chief Executive Officer

Know these  
**safety symbols**



 This "bolt of lightning" indicates uninsulated material within your unit may cause an electrical shock. For the safety of everyone in your household, please do not remove product covering.

 The "exclamation point" calls attention to features for which you should read the enclosed literature closely to prevent operating and maintenance problems.

**WARNING:** TO PREVENT FIRE OR SHOCK HAZARD, DO NOT EXPOSE THIS EQUIPMENT TO RAIN OR MOISTURE.

**CAUTION:** To prevent electric shock, match wide blade of plug to wide slot of the outlet and fully insert.

**ATTENTION:** Pour éviter les choc électriques, introduire la lame la plus large de la fiche dans la borne correspondante de la prise et pousser jusqu'au fond.

**For Customer Use**

Enter below the Model, Serial and Access Card Number and Receiver ID located on the rear panel of the DIRECTV® Receiver. Retain this information for future reference.

Model No. \_\_\_\_\_

Serial No. \_\_\_\_\_

Access Card No. \_\_\_\_\_

Receiver ID \_\_\_\_\_

*Let's make things better.*



**PHILIPS**

## Safety Instructions - Read Before Operating Equipment

**WARNING: TO PREVENT FIRE OR SHOCK HAZARD, DO NOT EXPOSE ANY ELECTRICAL EQUIPMENT TO RAIN OR MOISTURE.**

1. **Read Instructions** – All the safety and operating instructions should be read before the appliance is operated.
2. **Retain Instructions** – The safety and operating instructions should be retained for future reference.
3. **Heed Warnings** – All warnings on the appliance and in the operating instructions should be adhered to.
4. **Follow Instructions** – All operating and use instructions should be followed.
5. **Attachments** – Do not use attachments not recommended by the manufacturer as they may cause hazards.
6. **Water and Moisture** – Do not use this product near water – for example, near a bath tub, wash bowl, kitchen sink, or laundry tub, in a wet basement, near a swimming pool, etc.
7. **Accessories** – Do not place this product on an unstable cart, stand, tripod, bracket, or table. The product may fall, causing serious injury to a child or adult, and serious damage to the appliance. Use only with a cart, stand, tripod, bracket, or table recommended by the manufacturer or sold with the product. Any mounting of the appliance should follow the manufacturer's instructions, and should use a mounting accessory recommended by the manufacturer.
- 7A  An appliance and cart combination should be moved with care. Quick stops, excessive force, and uneven surfaces may cause the appliance and cart combination to overturn.
8. **Ventilation** – Slots and openings on the cabinet are provided for ventilation and to ensure reliable operation of the product and to protect it from overheating. These openings must not be blocked or covered. The openings should never be blocked by placing the product on a bed, sofa, rug, or other similar surface. This product should not be placed near or over a radiator or heat register. This product should not be placed in a built-in installation such as a bookcase or rack unless proper ventilation is provided or the manufacturer's instructions have been adhered to.
9. **Power Sources** – This product should be operated only from the type of power source indicated on the marking label. If you are not sure of the type of power supply to your home, consult your appliance dealer or local power company.
10. **Grounding or Polarization** – This product is equipped with a polarized alternating-current line plug (a plug having one blade wider than the other). This plug will fit into the power outlet only one way. This is a safety feature. If you are unable to insert the plug fully into the outlet, try reversing the plug. If the plug should still fail to fit, contact your electrician to replace your obsolete outlet. Do not defeat the safety purpose of the polarized plug.
11. **Power Cord Protection** – Route power supply cords so that they are not likely to be walked on or pinched by items placed upon or against them. Pay particular attention to cords at plugs, convenience receptacles, and the point where they exit from the appliance.
12. **Outdoor Antenna Grounding** – If an outside antenna or cable system is connected to the product, be sure the antenna or cable system is grounded to provide protection against voltage surges and built-up static charges.  
Section 810 of the National Electrical Code, ANSI/NFPA 70, provides information with regard to proper grounding of the mast and supporting structure, grounding of the lead-in wire to an antenna discharge unit, size of grounding conductors, location of antenna-discharge unit, connection to grounding electrodes, and requirements for the grounding electrode. See Figure A.
13. **Phone Line Use** – Avoid using a telephone (other than a cordless type) during an electrical storm. There may be a remote risk of electric shock from lightning. Do not use the telephone to report a gas leak in the vicinity of the leak.
14. **Lightning** – For added protection for this product during a lightning storm or when it is left unattended and unused for long periods of time, unplug it from the wall outlet and disconnect the antenna or cable system. This will prevent damage to the product from lightning and power line surges.
15. **Power Lines** – An outside antenna system should not be located in the vicinity of overhead power lines or other electric light or power circuits, or where it can fall onto such power lines or circuits. When installing an outside antenna system, extreme care should be taken to keep from touching such power lines or circuits as contact with them might be fatal. Refer to Satellite Dish Antenna Assembly & Alignment Guide.
16. **Overloading** – Do not overload wall outlets and extension cords as this can result in a risk of fire or electric shock.
17. **Object and Liquid Entry** – Never push objects of any kind into this product through openings as they may touch dangerous voltage points or short-out parts that could result in a fire or electric shock. Never spill liquid of any kind on the product.
18. **Servicing** – Do not attempt to service this product yourself, as opening or removing covers may expose you to dangerous voltage or other hazards. Refer all servicing to qualified service personnel.
19. **Damage Requiring Service** – Unplug this product from the wall outlet and refer servicing to qualified service personnel under the following conditions:
  - a. When the power supply cord or plug is damaged.
  - b. If liquid has been spilled, or objects have fallen into the product.
  - c. If the product has been exposed to rain or water.
  - d. If the product does not operate normally when following the operating instructions. Adjust only those controls that are covered by the operating instructions, as an improper adjustment of other controls may result in damage and will often require extensive work by a qualified technician to restore the product to its normal operation.
  - e. If the product has been dropped or the cabinet has been damaged in any way.
  - f. When the product exhibits a distinct change in performance – this indicates a need for service.
20. **Replacement Parts** – When replacement parts are required, be sure the service technician has used replacement parts specified by the manufacturer or which have the same characteristics as the original part. Unauthorized substitutions may result in fire, electric shock or other hazards.
21. **Safety Check** – Upon completion of any service or repairs to this product, ask the service technician to perform safety checks to determine that the product is in proper operating condition.
22. **Carts and Stands** – The appliance should be used only with a cart or stand recommended by the manufacturer.
23. **Heat** – The product should be situated away from heat sources such as radiators, heat registers, stoves, or other products that produce heat.

**Operating Temperature:** 40 to 110°F  
**Storage Temperature:** 15 to 155°F

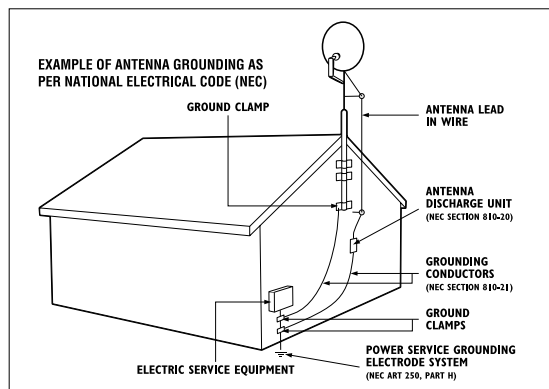
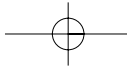

Figure A



## Safety Instructions (cont'd), General Information

This device incorporates an anticopy process technology that is protected by U.S. patents and other intellectual property rights. The anticopy process is licensed for non-commercial, home use only. Reverse engineering or disassembly is prohibited.

### NOTE TO CATV SYSTEM INSTALLER

Article 820-40 of the NEC (National Electrical Code) provides guidelines for proper grounding and, in particular, specifies that the cable ground shall be connected to the grounding system of the building, as close to the point cable entry as practical.

### WARNING

This device complies with Part 15 of the FCC (U. S. A.) Rules.

Operation is subject to the following two conditions:

- (1) This device may not cause harmful interference, and
- (2) This device must accept any interference received, including interference that may cause undesired operation.

### FCC Regulations and Information

This equipment has been tested and found to comply with the limits for a Class B digital device, pursuant to Part 15 of the FCC Rules. These limits are designed to provide reasonable protection against harmful interference in a residential installation. This equipment generates, uses and can radiate radio frequency energy and, if not installed and used in accordance with the instructions, may cause harmful interference to radio communications.

However, there is no guarantee that interference will not occur in a particular installation. If this equipment does cause interference to radio or television reception (which you can determine by turning the equipment off and on), you are encouraged to try to correct the interference by one or more of the following measures:

1. Change the position of the DIRECTV® Receiver with respect to the radio or television equipment that is receiving the interference.
2. Move the DIRECTV Receiver away from the equipment that is receiving the interference.
3. Plug the DIRECTV Receiver into a different outlet so that the DIRECTV Receiver and the equipment receiving the interference are on different branch circuits.
4. Use shielded cables and I/O cords with this equipment to comply with the relevant FCC regulations.
5. If these measures do not eliminate the interference, you should consult your dealer or an experienced radio/television technician for help.

### IMPORTANT

Any change or modifications to the equipment by the user not expressly approved by the warranty or manufacturer could void the user's authority to operate the equipment.

Domestic use U. S. A – For units used at 110V, use only the power supply cord which is supplied with the product.

### ANALOG DEVICE WARNINGS

#### Federal Communication Commission (FCC) Part 68 and Administrative Council for Terminal Attachments (ACTA)

This device complies with Part 68 of the FCC rules and the requirements adopted by the ACTA. A label on the rear panel of this equipment contains, among other information, a product identifier in the format US:AAAEQ##TXXXX. If requested, this information must be provided to the telephone company. The REN is used to determine the number of devices that may be connected to the telephone line. Excessive RENs on the telephone line may result in the devices not ringing in response to an incoming call. In most, but not all areas, the sum of RENs should not exceed five (5.0). To be certain of the number of devices that may be connected to a line, as determined by the total RENs, contact the local telephone company. The REN for this product is part of the product identifier that has the format US:AAAEQ##TXXXX. The digits represented by ## are the REN without a decimal point. For the DSX 5500 or DSX 5540, 01 means a REN of 0.1.

**Note: RENs are associated with loop-start and ground-start ports. Do not use for E & M or digital ports.**

This equipment uses the following USOC jack: RJ-11C.

#### No modular plug is provided with this equipment.

If the DSX 5500 or DSX 5540 causes harm to the telephone network, the telephone company will notify you in advance that temporary interruption of service may be required. But if advance notice isn't practical, the telephone company will notify the customer as soon as possible. Also, you will be advised of your right to file a complaint with the FCC if you believe it is necessary.

The telephone company may make changes in its facilities, equipment, operations or procedures that could affect the operation of the equipment. If this happens, the telephone company will provide advance notice in order for you to make necessary modifications to maintain uninterrupted service.

If the equipment is causing harm to the telephone network, the telephone company may request that you disconnect the equipment until the problem is resolved.

This equipment cannot be used on public coin phone service provided by the telephone company. Connection to party line service is subject to state tariffs (Contact the state public utility commission, public service commission or corporation commission for information).

If your home has specially wired alarm equipment connected to the telephone line, ensure the installation of this DSX 5500 or DSX 5540 does not disable your alarm equipment. If you have questions about what will disable alarm equipment, consult your telephone company or a qualified installer.

**For repair or warranty information on hardware service only, please call: 1-800-464-1131.**

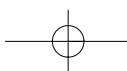

## Contents

Package Contents .....	6	Main Menu	
Front and Rear Panels .....	7	Using the Main Menu .....	26
Access Card .....	8	Interactive services.....	26
Connections		Preferences .....	27-29
Antenna and Phone .....	9	Preferred Language .....	27
Video .....	10	Screen Format .....	27
Audio .....	11	Banner Duration.....	28
A/V Matrix .....	12	Set Favorite Channels .....	28
Preparing your Remote Control.....	13	A/V Matrix.....	28
Remote Control Use.....	13-17	Remote Control ID .....	28
Setup Wizard .....	18	Digital Audio (DSX 5540 only) .....	29
Watching TV .....	19	Parental Controls .....	29-30
Enhanced User Features		Lock the System.....	29
EZ Search PPV .....	20	Channel Locks.....	29
SmartSurf .....	20	Set Spending Limit.....	30
Favorite Channels.....	21	Set Rating Limit .....	30
Program Guide		Replace Access Card .....	30
DIRECTV ADVANCED PROGRAM GUIDE™		Purchases .....	31
.....	22-23	Setup.....	32-33
Reminders .....	23	System Upgrades .....	33
PPV (Pay Per View) .....	23	Messages .....	34
Guide Menu .....	24-25	Caller ID .....	34
		Troubleshooting .....	35
		Limited Warranty.....	36

**NOTE:** This owner's manual may be used with several different models. Not all features (or drawings) discussed in this manual will necessarily match those found with your system. This is normal and does not require you contacting your dealer or requesting service.

DIRECTV programming sold separately. ACTIVATION OF PROGRAMMING MAY BE SUBJECT TO CREDIT APPROVAL AND REQUIRES VALID SERVICE ADDRESS, SOCIAL SECURITY NUMBER AND/OR MAJOR CREDIT CARD. DEPOSIT OR PREPAYMENT MAY BE REQUIRED. Programming subject to change. DIRECTV service not available outside the U.S. DIRECTV programming is sold separately and independently of DIRECTV System hardware. A valid programming subscription is required to operate DIRECTV System hardware. Activate your DIRECTV programming today at 1-800-DIRECTV (1-800-347-3288)

DIRECTV and the Cyclone Design logo, ADVANCED PROGRAM GUIDE and DIRECTV INTERACTIVE are trademarks of DIRECTV, Inc., a unit of Hughes Electronics Corp., and are used with permission.

Philips is a registered trademark of Koninklijke Philips Electronics, NV.

This product includes software developed by the University of California, Berkeley and its contributors.

Copyright (c) 1982, 1986, 1988, 1990, 1993

The Regents of the University of California. All rights reserved.

Redistribution and use in source and binary forms, with or without modification, are permitted provided that the following conditions are met:

1. Redistribution of source code must retain the above copyright notice, this list of conditions and the following disclaimer.
2. Redistribution in binary form must reproduce the above copyright notice, this list of conditions and the following disclaimer in the documentation and/or other materials provided with the distribution.
3. All advertising materials mentioning features or use of this software must display the following acknowledgment: This product includes software developed by the University of California, Berkeley and its contributors.
4. Neither the name of the University nor the names of its contributors may be used to endorse or promote products derived from this software without specific prior written permission.

THIS SOFTWARE IS PROVIDED BY THE REGENTS AND CONTRIBUTORS "AS IS" AND ANY EXPRESS OR IMPLIED WARRANTIES, INCLUDING, BUT NOT LIMITED TO, THE IMPLIED WARRANTIES OF MERCHANTABILITY AND FITNESS FOR A PARTICULAR PURPOSE ARE DISCLAIMED. IN NO EVENT SHALL THE REGENTS OR CONTRIBUTORS BE LIABLE FOR ANY DIRECT, INDIRECT, INCIDENTAL, SPECIAL, EXEMPLARY, OR CONSEQUENTIAL DAMAGES (INCLUDING, BUT NOT LIMITED TO, PROCUREMENT OF SUBSTITUTE GOODS OR SERVICES; LOSS OF USE, DATA, OR PROFITS; OR BUSINESS INTERRUPTION) HOWEVER CAUSED AND ON ANY THEORY OF LIABILITY, WHETHER IN CONTRACT, STRICT LIABILITY, OR TORT (INCLUDING NEGLIGENCE OR OTHERWISE) ARISING IN ANY WAY OUT OF THE USE OF THIS SOFTWARE, EVEN IF ADVISED OF THE POSSIBILITY OF SUCH DAMAGE.

The software included in this product is based in part on the work of the Independent JPEG-Group and on the PNG Reference Library which is copyright © 1998-2001 Glenn Randers-Pehrson, copyright © 1996, 1997 Andreas Dilger, and copyright © 1995, 1996 Guy Eric Schalnat, Group 42, Inc.

For the software in this product no license under Philips IPR is granted, except for the use of the software in combination with this product.

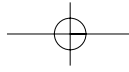

# Package Contents



DIRECTV® Receiver

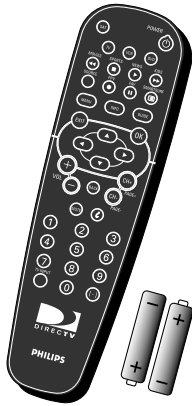

Infrared (IR) Universal Remote Control with Two AA Batteries



User Manual

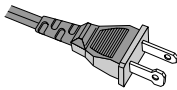

Power Supply Cord

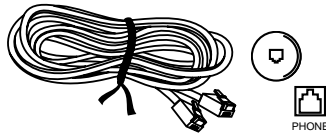

RJ-11 Telephone Cord



Access Card

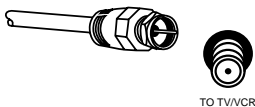

RF Coaxial Cable

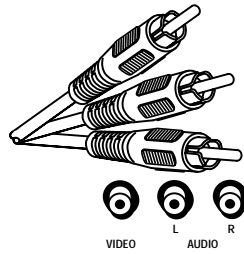

RCA Type Audio/Video Connecting Cable

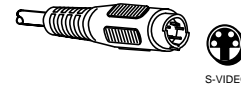

S-Video Connecting Cable (not included with all products)

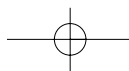

## Front and Rear Panels

### Front Panel

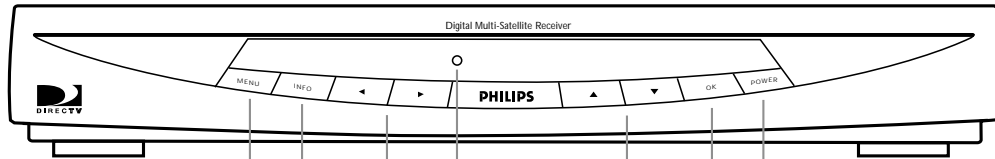

**MENU button**

Displays the Main Menu.

**INFO button**

Switches between program information in the banner and the program details screen.

**Arrow buttons (◀▶▶▶▶)**

Use to navigate through the Guide and menus. While watching Satellite programming, use the ▲▼ arrows to channel up or down.

**Power indicator**

Lights when the DIRECTV Receiver is on.

**POWER button**

Press to turn the DIRECTV® Receiver on or press to place the DIRECTV Receiver in Standby.

**OK button**

Confirms a selection in the menus or Program Guide.

### Rear Panel

**Card Access**

Install Access Card here. Details are on page 8.

**Receiver ID Number**

AC power input  
Connect the supplied power cord here.

**Serial Number**

**Model Number**

**Sat In**

Connect the coaxial cable from the Satellite Dish antenna here. Details are on page 9.

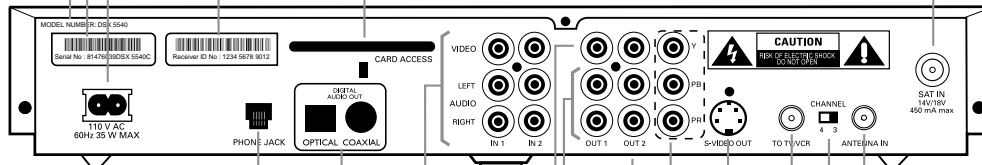

**Phone jack**

Connect the supplied phone cord here and to a wall phone jack in your home.

**Dolby Digital outputs\* (optical and coaxial)**

\* DSX 5540 only

**AV Matrix (refer to page 12)**

Left/Right Audio/Video Inputs 1 and 2

Video output 1

Left/right Audio output 1

Secondary Audio/Video Outputs

**Antenna Input**

Connect to an off-air antenna or analog cable system.

**Channel 3/4 switch**  
Details on page 10.

**TV/VCR Output**

**S-Video Output**

**Component Video Output\***

\* DSX 5540 only

## Access Card

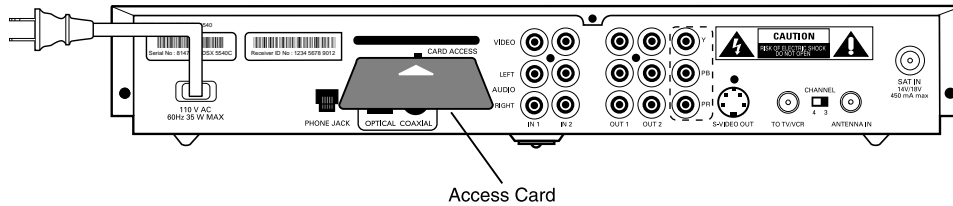

The access card provided with your system includes information about your purchase authorization and other data. To watch channels, your viewing access card needs to be inserted in the access card slot on the rear of your DIRECTV® Receiver.

The access card needs to be inserted during system setup and generally does not need to be removed. Each access card has a unique number. Be sure to record this number in the space provided on the second page of this manual in the "For Customer Use" section for future reference.

1. Hold the card with the arrow facing upwards and pointing toward the slot in the DIRECTV Receiver rear panel.
2. Gently push the card into the slot until it meets the stop. Do not use undue force when inserting. The end will be visible outside of the slot.
3. Keep your access card permanently inserted in your DIRECTV Receiver.

If you have to reinsert the card, you should have the arrow facing forward into the box and the gold chip facing down.

 <b>Caution</b>	
<ul style="list-style-type: none"> <li>• YOUR ACCESS CARD IS FRAGILE.</li> <li>• ALWAYS INSERT CORRECTLY AND CAREFULLY.</li> <li>• DO NOT BEND.</li> <li>• DO NOT REMOVE AND RE-INSERT UNNECESSARILY.</li> <li>• NEVER SUBMERGE IN LIQUID OR APPLY CLEANING FLUIDS.</li> </ul>	



## Connections

### Antenna and Phone

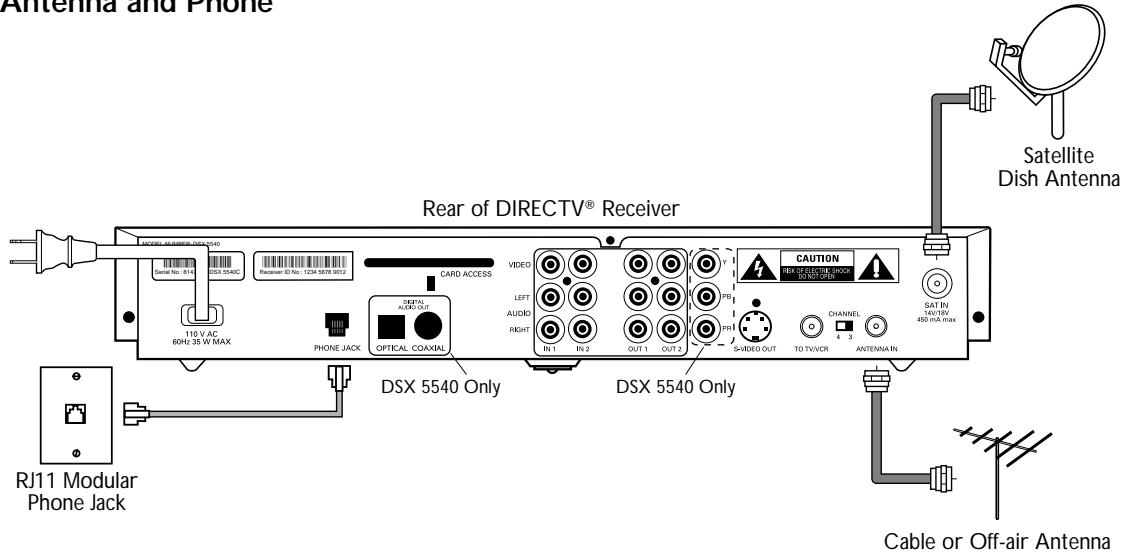

Unplug all equipment from the AC outlet before making connections.

1. Connect the RF coaxial cable from the satellite dish to the SAT IN jack.
2. If you have cable (CATV) or an off-air antenna, connect its RF coaxial cable to the ANTENNA IN jack.
3. Using the telephone cord (supplied), connect one end of it to a phone jack in your home. Connect the other end to the PHONE JACK input on the rear of the Receiver. To enjoy uninterrupted programming and to order pay per view programs, the DIRECTV® Receiver must be continuously connected to a land-based phone line.
4. Connect one end of the AC power cord (supplied) to the Receiver's AC IN jack.

## Connections (cont'd)

### Video

Unplug all equipment from the AC outlet before making connections.

There are several options for connecting the video and audio outputs of your DIRECTV® Receiver, depending on the type of equipment you want to connect and the quality of signal you want to achieve. The following chart summarizes your options for video connections. Select either A, B, C or D and refer to the illustration and steps below to connect.

Option	Video Signal Quality	Video Output
A	Excellent	Component * (Y, PB, PR)
B	Very Good	S-VIDEO OUT
C	Good	VIDEO OUT1
D	Standard	TO TV/VCR

\* DSX 5540 Only

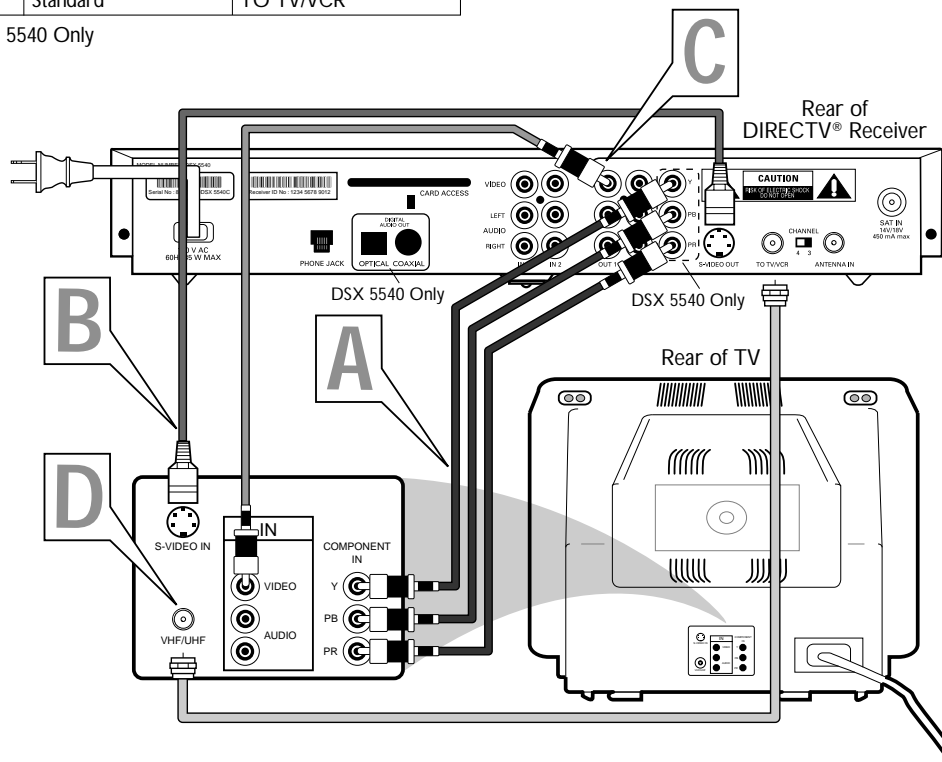

**Note:** The TV rear jack panel shown above has jacks for all possible connections. Your TV's rear jack panel may differ.

- (For model DSX 5540 only.) Using a component cable (not included), connect the jacks on one end to the component Y (green), PB (blue), PR (red) jacks on the rear of the Receiver. Connect the other ends to the TV's COMPONENT IN jacks. Select the proper input on your TV.
- Using a S-VIDEO cable, connect one end to the S-VIDEO OUT jack on the Receiver to the S-VIDEO IN on the TV. Select the proper input on your TV.
- Using the RCA type connector (supplied), connect one end to the OUT 1 VIDEO jack (yellow) on the Receiver to the VIDEO IN on the TV. Select the proper input on your TV.
- Using the RF coaxial cable (supplied), connect one end to the TO TV/VCR jack on the Receiver to the RF IN jack on the TV. Turn the TV on and select channel 3 or 4, whichever is not used or least used in your area. Set the CHANNEL switch on the back of the Receiver to the same channel.

## Connections (cont'd)

### Audio

Unplug all equipment from the AC outlet before making connections.

There are several options for connecting the audio outputs of your DIRECTV® Receiver, depending on the type of equipment you want to connect. If you connected video with option D on page 10, you will get audio from your TV when using that input. The following chart summarizes your additional options for audio connections. Select either A, B, or C and refer to the illustration and steps below to connect.

Option	Audio Signal	Audio Output
A	Dolby Digital*	OPTICAL
B	Dolby Digital*	COAXIAL
C	Stereo	AUDIO LEFT/RIGHT OUT1

\* DSX 5540 Only

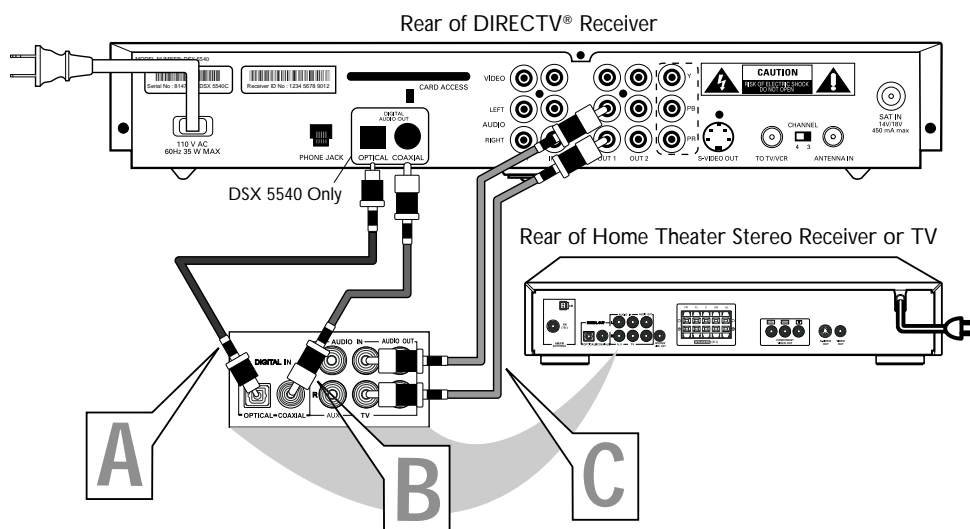

**Note:** This illustration shows a home theater stereo receiver and TV rear jack panel for possible connections. Your home theater system stereo receiver or TV rear jack panel may differ.

- (For model DSX 5540 only.) Using an OPTICAL cable (not included), connect one end to the OPTICAL DIGITAL AUDIO OUT on the Receiver to the home theater stereo receiver or TV's OPTICAL IN jack.
- (For model DSX 5540 only.) Using a COAXIAL cable (not included), connect one end to the COAXIAL DIGITAL AUDIO OUT on the Receiver to the home theater stereo receiver or TV's COAXIAL DIGITAL IN jack.
- Using the RCA type connectors (supplied), connect the left (white) and right (red) jacks of one end of the cables to the OUT 1 AUDIO LEFT and RIGHT jacks on the Receiver and the other ends to the left and right AUDIO IN on the home theater stereo receiver or TV. Select the proper input on the home theater stereo receiver or TV.

## Connections (cont'd)

### A/V Matrix

Unplug all equipment from the AC outlet before making connections.

Does your TV have only one video or RF input but you own a VCR, DVD player or other video equipment? Philips offers the industry's first A/V Matrix that allows you to command and control other video devices such as a DVD player or a VCR without additional equipment. You can use this DIRECTV® Receiver as the video gateway of your entertainment center.

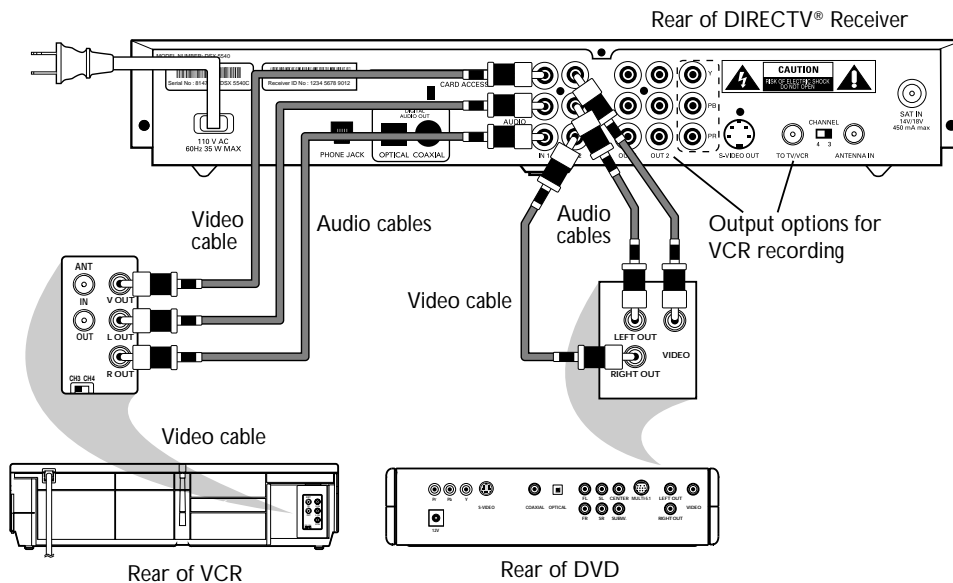

**Note:** For additional hookups and operation information, refer to the owner's manuals for the devices you are connecting to the DIRECTV Receiver.

1. Connect the outputs of your other devices (such as a DVD player or VCR) to the corresponding VIDEO and AUDIO LEFT/RIGHT inputs (IN1 or IN2) of the A/V Matrix on the rear of the DIRECTV Receiver.
2. To record satellite programming, connect the VIDEO and AUDIO LEFT/RIGHT outputs of OUT2 on the rear of the DIRECTV Receiver to the corresponding video and audio inputs on the VCR. These outputs always output satellite programming and are not affected by the A/V Matrix. Alternatively, you can connect the TO TV/VCR RF output to the RF input on the VCR but this output will output the selected video source of the A/V Matrix when this feature is enabled.
3. To use the A/V Matrix, you must use video output option C (VIDEO OUT1) or D (TO TV/VCR) from page 10 and you must first enable it in the Main Menu (refer to page 28).

## Remote Control

### Preparing Your Remote Control

#### Battery Installation

1. Remove the battery compartment cover. Insert the two batteries (type/AA) supplied.
2. Position them in the battery compartment, as shown in the diagram.
3. Replace the cover.

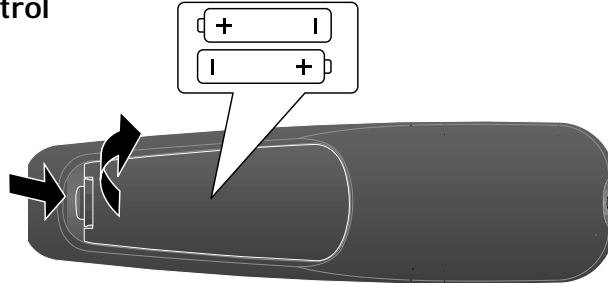

### Satellite Functions

#### SAT

Press SAT to control the DIRECTV® Receiver. LED will blink when other buttons are pressed while in satellite mode.

#### PPV

Use the EZ Search PPV function to view list of PPV programs and events for purchasing.

#### SOURCE

Switches between the inputs of the A/V Matrix (refer to page 12 and 28).

#### MENU

Displays the Main Menu.

#### EXIT

Returns to video and cancels the transaction.

#### INFO

Displays program or channel information.

#### Navigation

Navigates through the Guide and menus.

#### 0-9

Lets you enter numeric values or channel numbers.

#### POWER

#### POWER

Switches the DIRECTV® Receiver between active and standby modes.

#### MOVIES, SPORTS, NEWS, KIDS

Predefined SmartSurf buttons (refer to page 20).

#### SmartSurf

Displays categories you can use for Guide and channel surfing.

#### FAVORITES

Allows you to select one of four custom lists to view or edit.

#### GUIDE

Switches between the "DIRECTV ADVANCED PROGRAM GUIDE™" and the "Guide Menu".

#### OK

Confirms a selection.

#### CHANNEL

Displays the next or previous channel. While in the guide or menu, allows you to page up and down.

#### BACK

While in the menu or guide, returns you to the previous screen. While watching TV, pressing BACK will jump you to the previous channel.



DIRECTV INTERACTIVE™ powered by Wink Communications™. Press this button when the DIRECTV INTERACTIVE icon appears on the screen to access interactive services.

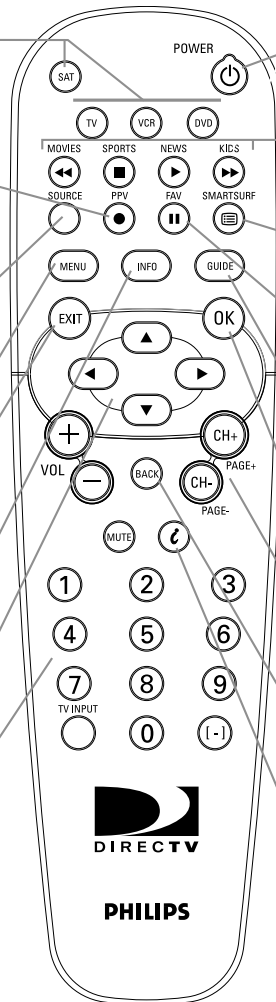

## Remote Control (cont'd)

### Programming the Universal Remote control

Your remote control **may** already operate your TV, VCR or DVD player. If the remote control does not properly operate your TV, VCR or DVD player, follow the steps below. These instructions guide you through setting the remote control to operate your TV. For VCR and DVD player, follow the same steps, but press the VCR or DVD button at step 3.

1. Point the remote control at your TV and press the TV button. Then, press the POWER button. If your TV turns on or off, try the other TV function buttons (see page 16). If the other functions work, the remote is ready to operate the TV without any more steps. If your TV does not turn on or off, or if the other buttons do not work, go to step 2.
2. Find the brand and code number(s) of your TV on page 15.
3. Press the TV button.
4. Press and hold the number 1 & number 3 buttons simultaneously for 3 seconds. The LED will blink twice and remain on.
5. Enter the 4-digit code from step 2 within one minute. The LED will blink after each button press. Note: If the 4-digit code is not entered within one minute, the LED will turn off and the remote control will return to the previously programmed code.
6. After a valid 4-digit code has been entered, the LED will turn off and blink twice to confirm the new 4-digit code has been programmed. The LED will then turn off.
7. If an invalid 4-digit code has been entered, the LED will turn off.
8. Press the POWER button. If the remote control operates your TV, you're finished.
9. If the remote control doesn't operate your TV and if there is more than 1 code for your TV brand, repeat steps 2-8.
10. For future reference, list the 4 digit code numbers you program into your remote:  
TV code: \_\_\_\_\_  
VCR code: \_\_\_\_\_  
DVD code: \_\_\_\_\_
11. If you cannot find a code that operates your TV, if the remote still does not operate your TV, follow the Automatic Search steps below.

### Automatic Search

To automatically program your remote control to operate your TV, VCR or DVD player, follow the steps below. For a VCR and DVD player, follow the same steps but substitute that component for the TV.

1. Turn on your TV. Stand close to your TV (within 5 to 10 feet) and point your remote control towards the remote sensor on your TV. Press the TV button. Press and hold the number 1 and the number 3 buttons simultaneously for 3 seconds. The TV LED will blink twice and remain on.
2. Press the POWER button. The LED will turn off. If the POWER button is not pressed within 1 minute, the remote will return to the previously programmed code. The automatic search will begin after the POWER button has been released.
3. Each time a code is transmitted, the LED will blink. This process could take several minutes.
4. When the correct code is found, the TV should turn off. Immediately press the POWER button. The LED will blink twice, then turn off. If all codes have been tried and the TV has not turned on or off the LED will stay on briefly, then turn off.

**Note:** To stop the search process at any time, press any button other than the POWER button. The LED will give a long blink and turn off. There is no guarantee that the remote control will work with your TV, VCR or DVD player.

## Remote Control (cont'd)

### TV Codes

AOC.....0046, 0057	.....0490, 0204, 0309,0066, 0046, 0181	Midland.....0044, 0066, 0074, 0078,0162, 0774	Sansui.....0490
Admiral.....0120, 0490	Envision.....0057	Minutz.....0048	Sanyo.....0181
Aiko.....0119	Fisher.....0181	Mitsubishi.....0177, 0205, 0046, 0120	Scimitsu.....0046
Aikai.....0057	Fujitsu.....0206, 0710	Motorola.....0120	Scotch.....0205
Alaron.....0206	Funai.....0207, 0198, 0206	Multitech.....0207	Scott.....0263, 0046, 0205, 0206, 0207
Ambassador.....0204	Futuretech.....0207	NAD.....0183, 0193, 0205	Sears.....0181, 0083, 0183, 0074, 0081,
America Action.....0207	GE.....0048, 0074, 0078, 0205, 0478,	NEC.....0057, 0046, 0083	.....0198, 0205, 0206, 0774
Ampro.....0778	.....0120, 0162, 0309, 0774	NTC.....0119	Semivox.....0207
Anam.....0207	Gibraltar.....0044, 0046, 0057	Nikko.....0205, 0057, 0119	Semp.....0183
Audiovox.....0119, 0207, 0478	GoldStar.....0205, 0046, 0057, 0083	Onwa.....0207	Sharp.....0120, 0192, 0066
Baysonic.....0207	Gradiente.....0083, 0080	Optimus.....0277, 0193, 0181	Shogun.....0046
Belcor.....0046	Grumpy.....0206, 0207	Optonica.....0120, 0192	Signature.....0043
Bell & Howell.....0043, 0181	Hallmark.....0205	Orion.....0490, 0206, 0263	Sony.....0027
Bradford.....0207	Harley Davidson.....0206	Panasonic.....0078, 0277	Soundesign.....0205, 0206, 0207
Brockwood.....0046	Harman/Kardon.....0081	Penney.....0074, 0087, 0057, 0048, 0162,	Squareview.....0198
Broksonic.....0263, 0490	Harvard.....0207	0205, 0078, 0066, 0046, 0083, 0183, 0774	Starlite.....0207
CXC.....0207	Hitachi.....0172, 0178, 0083, 0043	Philco.....0172, 0046, 0057, 0081, 0490	Supreme.....0027
Candle.....0057, 0083	Infinity.....0081	Philips.....0081	Sylvania.....0081, 0057
Carnivale.....0057	Inteq.....0044	Pilot.....0046, 0057, 0066	Symphonic.....0198
Carver.....0081	JBL.....0081	Pioneer.....0193	TMK.....0083, 0204, 0205
Celebrity.....0027	JCB.....0027	Portland.....0046, 0066, 0119	Tandy.....0120
Cineral.....0478, 0119	JVC.....0080	Prism.....0078	Technics.....0078, 0277
Citizen.....0083, 0057, 0066, 0087, 0119	KEC.....0207	Proscan.....0074, 0774	Technol Ace.....0206
Concerto.....0083	KTV.....0207, 0057, 0066	Proton.....0205	Techwood.....0078, 0083
Contec.....0207	Kenwood.....0057, 0046	Pulsar.....0044, 0046	Teknika.....0043, 0081, 0206, 0207,
Craig.....0207	LG.....0073	Quasar.....0078, 0277, 0192	.....0046, 0066, 0119, 0083, 0087, 0177
Crosley.....0081	LXI.....0181, 0074, 0081, 0183, 0205, 0774	RCA.....0074, 0162, 0046, 0078, 0117,	Telefunken.....0083
Crown.....0066, 0207	Logik.....0043	.....0120, 0774	Toshiba.....0183, 0087, 0181
Curtis Mathes.....0087, 0057, 0043,	Luxman.....0083	Radio Shack.....0192, 0207, 0057, 0205,	Totevision.....0066
.....0066, 0074, 0078, 0081, 0083, 0120,	MGA.....0177, 0046, 0057, 0205	.....0066, 0181, 0046, 0074, 0083, 0774	Vector Research.....0057
.....0172, 0181, 0193, 0478, 0774	MTC.....0087, 0057, 0046, 0083	Realistic.....0192, 0207, 0181, 0057, 0066,	Victor.....0080
Daewoo.....0119, 0046, 0478, 0066	Magnavox.....0081, 0057, 0206	.....0205, 0046, 0083	Vidikron.....0081
Daytron.....0046	Majestic.....0043	Runco.....0044, 0057	Vidtech.....0046, 0205
Denon.....0172	Marantz.....0081, 0057	SSS.....0046, 0207	Wards.....0081, 0192, 0205, 0043,
Dumont.....0044, 0046	Matsushita.....0027	Sampo.....0057, 0066	.....0046, 0048, 0057, 0083, 0206
Dwin.....0747, 0801	Megatron.....0172, 0205	Samsung.....0087, 0046, 0205, 0057, 0083	White Westinghouse.....0490
Electroband.....0027	Memorex.....0205, 0043, 0083, 0177,	Samsux.....0066	Yamaha.....0046, 0057
Emerson.....0263, 0207, 0205, 0206,	.....0181, 0277, 0490	Sansei.....0478	Zenith.....0044, 0043, 0119, 0490

### VCR Codes

Admiral.....0075, 0236	Funai.....0027	Minolta.....0069	Samsung.....0072, 0267
Adventura.....0027	GE.....0062, 0087, 0075, 0267, 0787	Mitsubishi.....0070, 0075, 0094	Sanky.....0066, 0075
Aiko.....0305	Garrard.....0027	Motorola.....0062, 0075	Sansui.....0068, 0027, 0094, 0236, 0298
Aiwa.....0334, 0027, 0064	Go Video.....0553	Multitech.....0027, 0099	Sanyo.....0074, 0073, 0131, 0267
Aikai.....0133, 0068	GoldStar.....0064, 0065	NEC.....0065, 0068, 0094, 0131	Scott.....0211, 0148, 0070, 0072
America Action.....0305	Gradiente.....0027	Nikko.....0064	Sears.....0064, 0069, 0027, 0062, 0073,
American High.....0062	HI-Q.....0074	Noblex.....0267	.....0074, 0131
Asha.....0267	Harley Davidson.....0027	Olympus.....0062	Semp.....0072
Audiovox.....0064	Harman/Kardon.....0065, 0108	Optimus.....0189, 0075, 0064, 0131	Sharp.....0075
Beaumont.....0267	Harwood.....0099	Orion.....0029, 0211, 0236	Shintom.....0099
Bell & Howell.....0131	Headquarter.....0073	Panasonic.....0062, 0189, 0252, 0643	Shogun.....0267
Broksonic.....0148, 0211, 0029, 0236	Hitachi.....0069, 0027, 0068	Penney.....0062, 0267, 0064, 0069, 0065	Singer.....0099
Broksonic.....0131	Hughes Network Systems.....0069	Pentax.....0069	Sony.....0060, 0059, 0027, 0062,
CCE.....0099, 0305	JVC.....0094, 0068	Philco.....0062, 0236	Sylvania.....0062, 0108, 0027, 0070
Call.....0064	Jensen.....0062	Philips.....0108, 0062, 0645	Symphonic.....0027
Canon.....0047	KEC.....0064, 0305	Pilot.....0064	TMK.....0267
Capehart.....0108	KLH.....0099	Pioneer.....0094	Tatung.....0068
Carver.....0108	Kenwood.....0068, 0094, 0065	Portland.....0047	Teac.....0027, 0068
Cineral.....0305	Kodak.....0062, 0064	Profitronic.....0267	Technics.....0062, 0189
Citizen.....0305, 0064	LXI.....0064	Proscan.....0087, 0787	Teknika.....0027, 0062, 0064
Colt.....0099	Lloyd's.....0027	Protec.....0099	Thomas.....0027
Craig.....0064, 0099, 0074, 0267, 0298	Logik.....0099	Pulsar.....0066	Tivo.....0645
Curtis Mathes.....0062, 0068, 0087, 0189,	MEI.....0062	Quarter.....0073	Toshiba.....0072, 0070
.....0787	MGA.....0070, 0267	Quartz.....0073	Totevision.....0064, 0267
Cybernex.....0267	MGN Technology.....0267	Quasar.....0062, 0189	Unitech.....0267
Daewoo.....0305, 0588, 0047, 0072	MTC.....0027, 0267	RCA.....0087, 0176, 0069, 0062, 0075,	Vector.....0072
Daytron.....0047	Magnasonic.....0305	.....0133, 0267, 0787	Vector Research.....0065
Denon.....0069	Magnavox.....0062, 0108, 0027, 0066, 0176	Radio Shack.....0027	Video Concepts.....0072
Dynatech.....0027	Magnin.....0064	Radix.....0064	Videosonic.....0267
Electrohome.....0064	Marantz.....0108, 0062	Randex.....0064	Wards.....0062, 0087, 0027, 0074, 0267,
Electrohome.....0064	Marta.....0064	Realistic.....0027, 0131, 0074, 0075,	.....0069, 0075, 0099, 0108, 0176, 0787
Emerex.....0059	Matsushita.....0062, 0189	ReplayTV.....0064, 0062, 0073	White Westinghouse.....0305, 0236
Emerson.....0211, 0029, 0236, 0305, 0148,	Memorex.....0131, 0074, 0027, 0064,	Runco.....0066	XR-1000.....0099, 0027, 0062
.....0588, 0027, 0064, 0070	.....0075, 0062, 0073, 0267, 0334, 0066,	STS.....0069	Yamaha.....0065
Fisher.....0074, 0131	.....0189, 0236		Zenith.....0066, 0027, 0060, 0236
Fuji.....0060, 0062			

### DVD Codes

Aiwa.....0668	Hitachi.....0600, 0691	Oritron.....0678	Sharp.....0657
Apex.....0699	Hiteker.....0699	Panasonic.....0517, 0704, 0659	Sherwood.....0660
Arcam.....0759	JVC.....0650, 0585	Pelican Accessories.....0758	Sony.....0560
B & K.....0682, 0689	Kenwood.....0764, 0709, 0561	Philips.....0566, 0530	Technics.....0517
Denon.....0517, 0661	Konka.....0746, 0738, 0747, 0748	Pioneer.....0598, 0552, 0659	Techwood.....0719
Fisher.....0697	Magnavox.....0530, 0702	Princeton.....0701	Theta Digital.....0598
GE.....0549	Marantz.....0566	Proscan.....0549	Toshiba.....0530
Go Video.....0742	Mitsubishi.....0548	RCA.....0549, 0598, 0731	Yamaha.....0517, 0572
Gradiente.....0678	Onkyo.....0654, 0530	Saitek.....0758	Zenith.....0618, 0530
Harman/Kardon.....0609, 0729	Optimus.....0598	Samsung.....0600	

## Remote Control (cont'd)

### TV Functions

Once programmed (refer to page 14), your DIRECTV® Remote Control should control certain functions of your TV. Be sure to press the TV button before operating your TV.

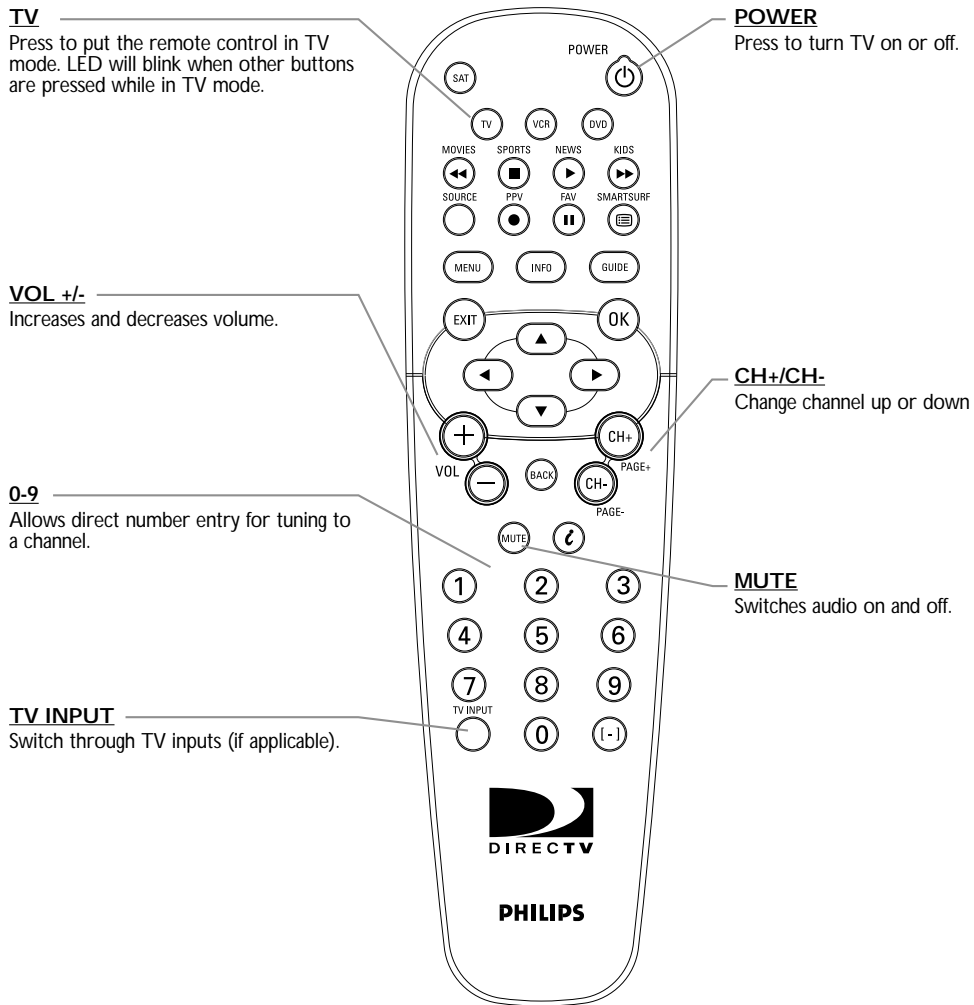

**Note:** All features on your TV may not be supported by this remote.



## Remote Control (cont'd)

### VCR/DVD Functions

Once programmed (refer to page 14), your DIRECTV® Remote Control should control certain functions of your VCR or DVD. Be sure to press the VCR or DVD button before operating each unit.

**VCR**

Press to put the remote control in VCR mode. LED will blink when other buttons are pressed while in VCR mode.

**REWIND**

VCR - When tape playback is stopped, press to rewind at high speed. During tape playback, press to rewind the tape while the picture stays on the screen.

DVD - Press and release to select previous chapter. Press and hold to scan backwards.

**STOP**

Press to stop the tape or disc.

**RECORD (VCR only)**

Press once to start a recording.

**0-9**

Allows direct number entry for tuning to a channel or chapter.

**POWER**

Press to turn VCR or DVD player on or off.

**DVD**

Press to put the remote control in DVD mode. LED will blink when other buttons are pressed while in DVD mode.

**FF**

VCR - When tape playback is stopped, press to advance the tape at high speed. During tape playback, press to advance the tape while the picture stays on the screen.

DVD - Press and release to select next chapter. Press and hold to scan forward.

**PLAY**

Press to play a tape or disc.

**PAUSE**

Press to pause a tape or disc.

**CH+/CH- (VCR only)**

Change channel up or down

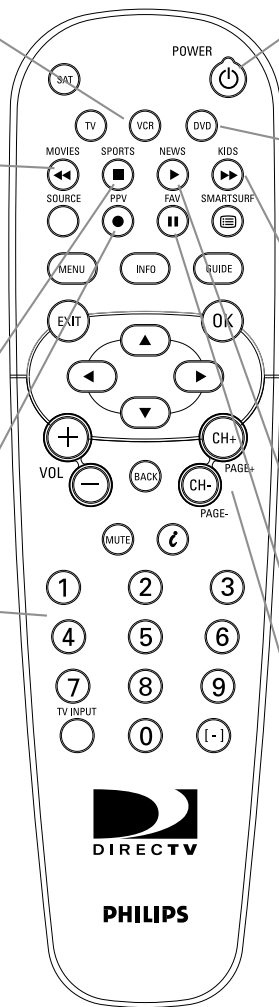

**Note:** All features on your VCR or DVD player may not be supported by this remote.

## Setup Wizard

If your equipment has been professionally installed, skip this first time setup section and go to page 19.

After the DIRECTV® Receiver has been connected to your components, it is time to turn the DIRECTV Receiver on.

1. Press the SAT button on the remote control. The LED will blink.
2. Press the POWER button on the remote control.
3. Use the ▲▼ buttons to select your preferred language of the on screen menus and guide and press OK.
4. When the Welcome screen displays, press the OK button on the remote control to start the Setup Wizard. The Setup Wizard is a first time setup that automatically steps you through the installation process. This screen will **ONLY** appear the very first time your DIRECTV Receiver is turned on.
  - a. Enter the ZIP code.
 

**Note:** The ZIP code is critical to point your dish accurately (refer to page 32).
  - b. Configure the dish (refer to page 32).
  - c. Point the dish (refer to page 32).
  - d. Test the System (refer to page 33).
5. After you have installed your DIRECTV System, you should contact DIRECTV to order DIRECTV® programming at 1-800 DIRECTV (1-800-347-3288).

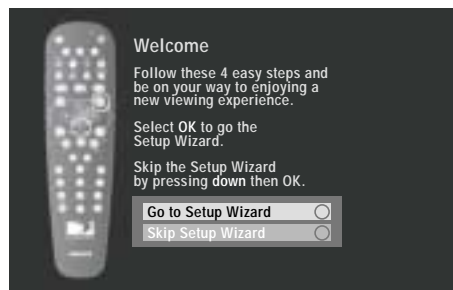
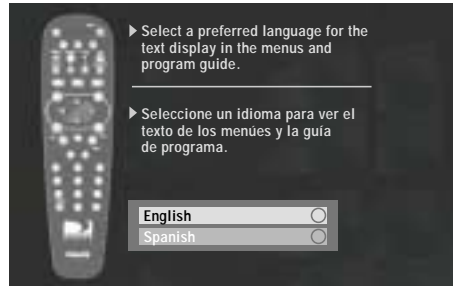

## Watching TV

The Info Banner shows information on the currently tuned program such as the rating, title, start and end time, program description, and channel number. It also displays the current time and date and indicates if any special features are currently enabled, such as Favorite Channels (page 21) or SmartSurf (page 20).

ALLDAY All Day Ticket (Pay Per View)	LB Letterbox format
ALT Alternate Audio Track	System Locked
CC Closed Captioning	System Temporarily Unlocked
Dolby Digital (DSX 5540 only)	Pay Per View
New Incoming Messages	DIRECTV Interactive Service

Channel Number & Name

Start/End Time & Date

Channel Icon

Program Name & Description

On screen Display (OSD) message space indicates error messages or status or song ID information (when you select a channel that contains audio only).

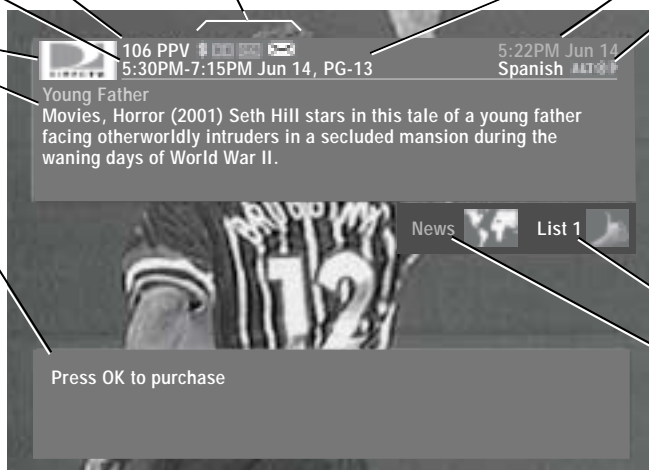

Rating

Current Time & Date

Current Alternate Audio Track

- The alternate audio icon indicates an alternate audio track is available. To change audio tracks, press the ◀ or ▶ button on the remote.

Favorites (page 21) status

SmartSurf (page 20) statue

### Watching TV

#### To do this....

#### Do this....

Display the banner

Press INFO button on the remote

View program details

1. Press INFO to display the banner
2. Press INFO again to display program details

View other channels with the Browse Banner

- You can see or "browse" what is on other channels without tuning away from the currently viewed program with the Browse Banner.
1. While watching a program, press the INFO button on the remote to display the banner.
  2. While the banner is displayed, press the ▲▼ buttons to see what is showing on other channels.
  3. Press OK to switch to the new channel displayed in the Banner or exit to remove the banner.

**Note:** When Favorite Channels (page 21) or SmartSurf (page 20) is in use, the Browse Banner will only show programs from those lists.

## Enhanced User Features

### EZ Search Pay Per View (PPV)

Philips offers a unique feature for searching pay per views. By pressing the PPV button on the remote, a listing of all pay per view programs starting within a chosen time period will be displayed alphabetically.

1. Press the PPV button on the remote.
2. Use the ▲▼ to select a time period to search in (Note: The full 3.5 day search takes about 10 seconds and cannot be interrupted) and press OK.
3. Use the ▲▼ to select a pay per view program and press OK. View details about your selected pay per view program, purchase it or display other showings of your selection.

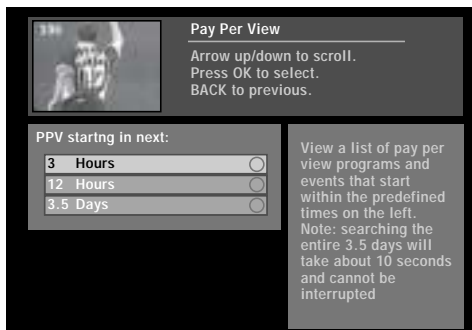

Select time period for pay per view search



List of pay per views starting within chosen time period

### SmartSurf™

Choosing SmartSurf is an easy way to highlight the programs whose categories or themes match your choice in the guide. Also, when changing channels, you will go only to the channels containing programs that have the selected category. When SmartSurf is active, the SmartSurf icon displays in the lower right hand corner of the banner.

There are four pre-defined SmartSurf categories. Refer to the buttons on the remote.

Pre-defined SmartSurf icons:



Movies Sports News Kids

#### To select specific SmartSurf category:

1. Press SmartSurf on the remote control. You have a choice to clear an existing setting (if active already), cancel, or continue with setting the SmartSurf.
2. Press the ▲▼ buttons to highlight the desired category or subcategory. The presence of subcategories is indicated by an arrow to the right of the category. To view the subcategories, press the ► button.
3. Press OK to select the category or subcategory.

**Note:** To turn off SmartSurf, press any of the SmartSurf keys, select "Clear SmartSurf" and press OK. When the POWER button is pressed and the receiver goes into standby, SmartSurf is automatically turned off.

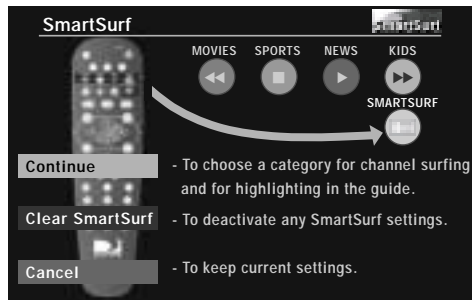

SmartSurf options

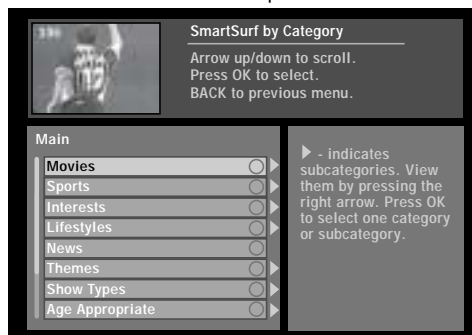

List of categories for SmartSurf

## Enhanced User Features (cont'd)

### Favorite Channels

 Favorite Channels is an easy way to customize the listing of channels. Once Favorites is configured, the Favorites icon displays in the banner and programs displayed in the Program Guide are only those in the selected list. **When using the CH+ and CH- buttons, you are limited to channels in the Favorites list;** however, you can access any channel by entering its number directly on the remote control. You can save up to four different favorite channel lists. This way, members of a household can each set their own favorite channel list.

#### To access Favorite Channels:

1. Press FAVORITES (FAV) on the remote.

#### Or from the Main menu:

1. Press MENU.
2. Use the ▼ button to select "Preferences" and press OK.
3. Use the ▼ button to select "Set Favorite Channels" and press OK.

#### Then, to select or edit a Favorite channel list:

1. Press the ▲▼ buttons to highlight the desired list, and press OK. Or, to turn off any previously selected Favorites list, highlight "All Channels", and press OK
2. Then, use the ▲▼ buttons to highlight "Select" to activate your Favorite list and press OK. Or, to edit the name or customize a Favorite channel list, select "Select and Edit" and press OK.

#### Select & Edit: Change List Name:

1. Select "Change List Name" and press OK.
2. Use the ◀▶▲▼ buttons to scroll through the alphabet. When the letter you want is selected, press OK. Repeat until you have spelled the list name..
3. When finished, select "Done" on the on-screen keyboard and press OK.

#### Select & Edit: Customize Favorites:

1. Select "Customize Favorites" and press OK.
2. You can manually select/deselect channels by highlighting a channel and pressing OK. Use the ▲▼ buttons to navigate through the list, or use the PAGE +/- buttons to scroll the list up or down by a complete page.  
 "Select All" selects all channels in the list. You can then manually deselect any channel.  
 "Deselect All" deselects all the channels in the list. You can then manually select any channel.
3. When customization is complete, Select "Save Changes" and press OK. Press BACK to return to the previous menu without saving your changes.

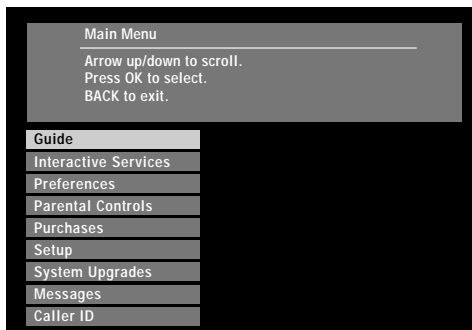

To access Favorites from the Main Menu, press MENU and select "Preferences"

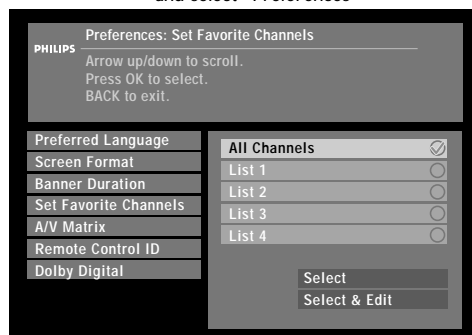

Select "Set Favorite Channels" in the "Preferences" menu



Change List Name

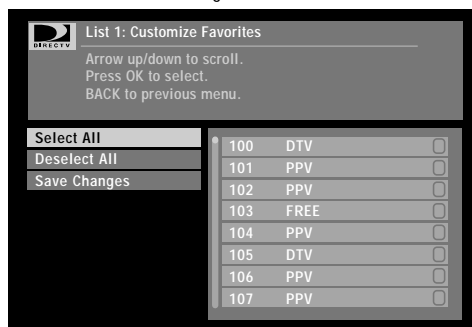

Customize Favorites

## DIRECTV ADVANCED PROGRAM GUIDE™

### DIRECTV ADVANCED PROGRAM GUIDE

The DIRECTV ADVANCED PROGRAM GUIDE offers complete TV listings for up to 3 1/2 days plus access to much more. The Guide lists programs according to their time slot and channel. With it, you can tune to a program, be notified when a program is about to start, order pay per view programs, search through listings by the type of program you're looking for, and set reminders for future viewing.

The **Channel Scroll Bar** shows the position of the channel relative to the total number of channels.

The **Channel List** shows the channels available.

**Arrows** indicate that the program extends beyond the time slot shown.

The **Clock** indicates that a Reminder for the program has been set for future viewing. If a Reminder is set, it will always display in the Guide cell. You will get notification before the program starts so that you can tune to it.

The **Program List** shows all the programs airing in a given time slot. If program names are too long to fit into a guide cell, they may be shortened. When a program is selected, its full name appears in the banner.

The **Banner** in the guide shows information on the highlighted program such as the rating, title, start and end time, program description, and channel number. It also displays the current time and date and indicates if any special features are currently enabled, such as Favorite Channels (page 21) or SmartSurf (page 20).

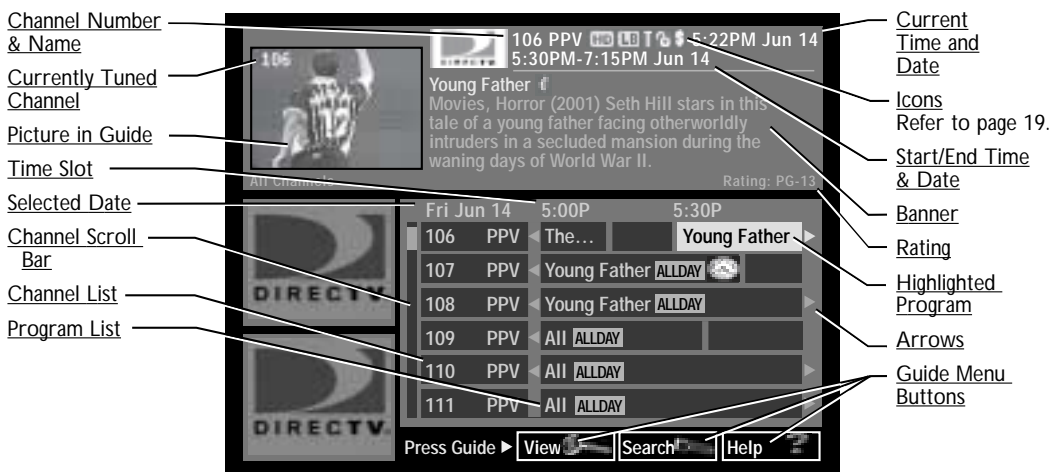

### Using the Guide

To do this....	Do this....
<b>Display the Guide</b>	Press the GUIDE button on the remote control or select "Guide" from the Main Menu.
<b>Scroll through the Program List</b>	Press the ▲▼ buttons. You can use the PAGE+/- buttons to scroll a full page at a time.
<b>Scroll to another time slot</b>	Press the ◀▶ buttons. Program information displays in the banner.
<b>Choose a program to view</b>	Press the arrow buttons until the program you want to view is highlighted in the Guide. If the program is in the current time slot, pressing OK tunes to the selected channel and displays the information for the program in the banner. If the program is in a future time slot, you are given the option to set a Reminder (refer to page 23). If the selected future program is pay per view, you are also given the option to purchase the program.
<b>View program details</b>	You can toggle between the guide and program details by pressing the INFO button on the remote.

## DIRECTV ADVANCED PROGRAM GUIDE™ (cont'd)

### Using the Guide (cont'd)

#### To do this....

#### Do this....

#### Set a Reminder for future viewing



You can set up your viewing schedule ahead of time, so that you will be automatically notified of the shows you want to see. In the Guide, Reminders display as a clock to the right of the program title.

If you wish to record a program using your VCR, set the VCR's timer recording also. Refer to your VCR's owner's manual for timer recording instructions. The DIRECTV® Receiver will turn on at the correct time and tune to the channel if a Reminder is set.

#### To set a Reminder for a non-pay per view program

1. Highlight a future program in the guide and press OK. In the Reminder screen, choose whether you want to select this program once, daily, weekly, or Monday-Friday. Remember, you are actually setting the Reminder by the time slot, so if the program moves to a different time slot, you will need to reset the Reminder.
2. Press OK.

If the program is in the same time slot as another Reminder, the system will prompt you that a conflict exists.

#### To set a Reminder for a pay per view program

1. When a future pay per view is purchased, you are given the option to set a Reminder in the purchase details screen. If you set the Reminder for a purchased pay per view, you will be charged when the event airs.

#### To cancel a Reminder for a program

1. Highlight the program in the guide and press OK.
2. Choose "Once" if you want to cancel a Reminder program for one time slot only, or "Always" if a program has been set as a Reminder more than once, for example, a program that airs every day. Then, press OK.

### PPV (Pay Per View)

Pay per view programs include special programming, movies, and sporting programs and are indicated by a "\$" in the banner. In the Guide, you can preview currently airing PPV programs, purchase current and future PPV programs, and cancel a purchase. From the Main Menu, you can view the purchase history, cancel purchases, and restrict this feature by setting rating and spending limits.

#### To purchase a PPV program:

1. Highlight the program in the Guide and press OK.
2. Select "Buy" and press OK. The price will display on the button. If you have locked your DIRECTV Receiver and the rating or spending limit is exceeded, you must enter your access code to temporarily unlock the receiver (refer to page 29) before you can purchase it.
3. Select "Showings" to see a list of alternate show times. Press the ▲▼ buttons to move to the next selectable showing (if available), then press the OK button to select it.
4. Press OK to confirm your purchase.

**Note:** To order PPV, the DIRECTV Receiver must be continuously connected to a land-based phone line.

## Guide Menu

### Guide Menu

The bottom of the Guide screen (refer to page 22) contains three buttons that can be accessed by pressing the GUIDE button on the remote control when the Guide is already displayed.

- Use the ◀▶ buttons to highlight a button and press OK to view its list of options.
- To close the list of options and select another Guide Menu button, press BACK.
- To return to the Guide press BACK again or GUIDE.
- To exit to watch TV, press Exit.

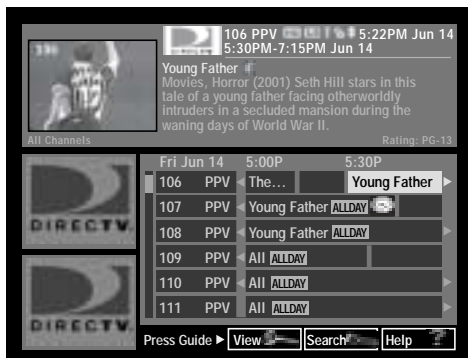

Access the Guide Menu by pressing the GUIDE button while in the Guide

### Guide Menu: View

Selecting "View" displays "Go To Time, Pay Per View, Reminder List and Time Reminder." Use the ▲▼ buttons to select from the View options. Press OK or ▶ to select an option.

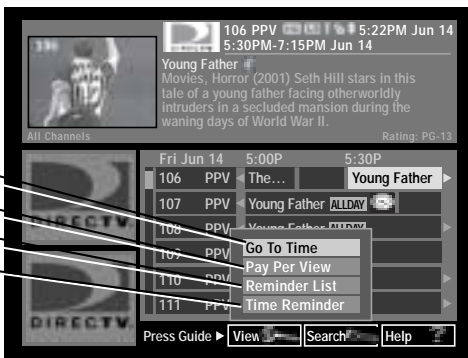

"View" menu options

- Jump to specific time slot in guide
- EZ Search Pay Per View (see page 20)
- List of Reminders set (see page 23)
- Set a Reminder by specific date, time and duration

### Guide Menu: Search

Selecting "Search" allows you to search programs based on Category, Title, Actor and Director. Use the ▲▼ buttons to select from the Search options, and press OK or ▶ to select a search option.

- Category
- Title, Actor, Director

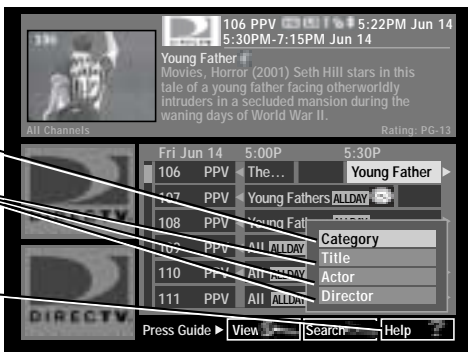

"Search" menu options. "Help" menu available by selecting "Help" and pressing OK

### Guide Menu: Help

Displays help information on screen. Use the ▲▼ arrows to select a topic and press OK. Press the PAGE+/- to scroll through help information.



## Guide Menu (cont'd)

### Guide Menu: Search: Category

A category search allows you to choose from a predefined list of categories and subcategories. The ► arrow indicates the category has subcategories.

1. Use the ▲▼ buttons to highlight a category or the ► arrow to view a list of subcategories.
2. Press OK to select one category or subcategory to search.



Choose a category to search

### Guide Menu: Search: Title/Actor/Director

To search for a specific title, actor or director:

1. Use the ◀▶▲▼ buttons to scroll through the alphabet. Highlight the letter you want, and press OK. Repeat until you have spelled part or all of the title, actor or director's name.
2. When finished, highlight "Done" on the on-screen keyboard and press OK.

**Note:** Ignore punctuation and accents. For example, enter JOHN'S as JOHNS and DAY-TO-DAY as DAYTODAY. When entering a full name, enter FIRST <space> LAST.



Enter the name of the title, actor or director with the on-screen keyboard

### Guide Menu: Search Results

Once your search is completed you will see a list of results on the screen. Use the ▲▼ buttons to highlight a program and press INFO to view the program details or OK to view a list of program showing times.

In addition to the icons on page 19, the list of program showing times includes additional icons to reflect the available alternate audio tracks.

<b>ENG</b> English	<b>ITA</b> Italian
<b>ESP</b> Spanish	<b>JPN</b> Japanese
<b>FRA</b> French	<b>KOR</b> Korean
<b>DEU</b> German	<b>CHN</b> Chinese

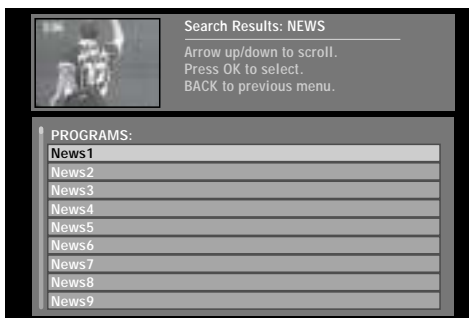

"Search Results" screen

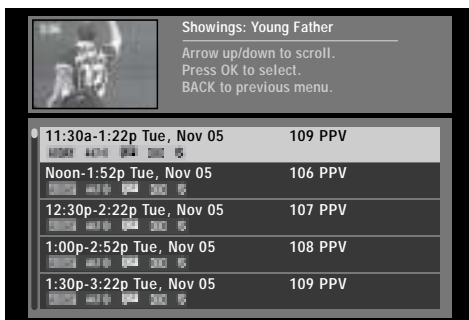

"Showings" screen

## Main Menu

### Using the Main Menu

The Main Menu lets you customize the features of your DIRECTV® Receiver.

**To access the Main Menu from the Guide or TV:**

Press the MENU button on the remote control.

**To exit the menu:**

Press the MENU button or EXIT.

**To navigate through the menus:**

Use the ▲▼ buttons to highlight an option. Then press OK or ► to confirm the selection and display a sub-menu. Selecting items in a sub-menu displays options in which you can change or review settings.

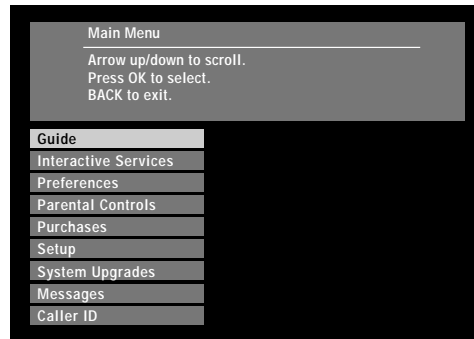

Press MENU button to view Main Menu

### Interactive Services

DIRECTV INTERACTIVE™ powered by Wink Communications® offers an interactive television service that lets you use your remote control to access up-to-the-minute news, sports and weather, get program trivia, respond to free offers and shop, all while you watch TV. Look for the flashing  and press OK to open the interactive window.

To learn more about the DIRECTV INTERACTIVE™ services:

1. Press MENU.
2. Use ▼ to highlight "Interactive Services" and press OK.
3. Press the OK button to tune directly to the DIRECTV INTERACTIVE™ Center (channel 499) to get more information about: Getting Started, Interactive Channels, Shopping Sign Up, Order History, Messages, Help & Settings, and About DIRECTV.

DIRECTV INTERACTIVE™ service only available on select model receivers. Receiver must be connected to a phone line. Wink and Wink Logo are registered trademarks of Wink Communications Inc.



## Main Menu (cont'd)

### Main Menu: Preferences

The Preferences option in the Main Menu lets you change the "Preferred Language", screen format, or banner duration, set or edit the favorite channels list, enable/disable the A/V Matrix and set the remote control ID. To change your preferences, select "Preferences" in the Main Menu and press OK. In the sub-menus that display, use the ▲▼ buttons to highlight your selection. Press BACK to return to the Main Menu.

#### Preferences: Preferred Language

Many programs are broadcast with program information and audio tracks in different languages. You can choose the preferred language for the text in the Menu and Guide and for the audio tracks of programs.

**Note:** Not all programs offer multiple languages. If the selected program is not available in the language you prefer, it defaults to English.

##### To choose a language:

1. Press MENU. The Guide option will be highlighted. Press ▼ to select "Preferences" and press OK.
2. Select "Preferred Language" and press OK.
3. Use the ▲▼ buttons to choose either "Menu & Guide" or "Audio Track" and press OK. The currently selected language has a checkmark to its right.
4. Use the ▲▼ buttons to choose a language from the list. Press OK.

If desired, repeat steps 3-4 to change the other option.

**Note:** Once the language of the "Menu & Guide" menu is changed, the Receiver will reset and the new language will be used.

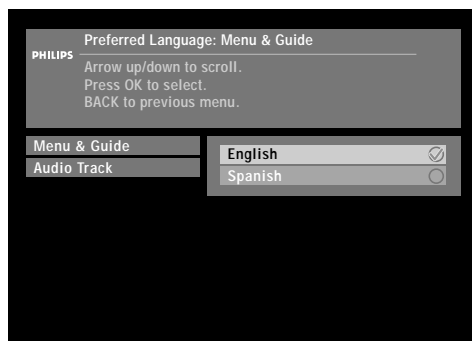

Select preferred language of text in the Menus and Guide in the "Menu & Guide" menu



Select preferred language of every program in the "Audio Track" menu

#### Preferences: Screen Format

##### To select a screen format:

1. Press MENU.
2. Press ▼ to select "Preferences" and press OK.
3. Press ▼ to select the "Screen Format" and press OK.
4. Use the ▲▼ buttons to choose from the options.
5. Once you have made your selection, press OK.

**Note:** Most standard TVs are 4:3 and that is the recommended setting. If you have a widescreen TV, select 16:9.

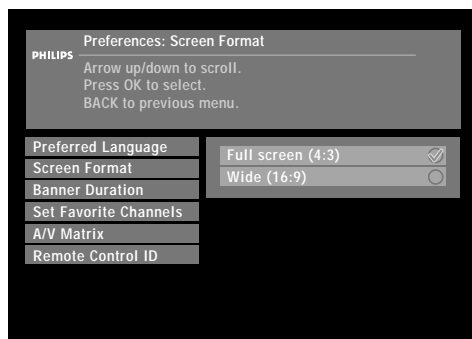

"Screen Format" menu

## Main Menu (cont'd)

### Preferences: Banner Duration

Banner durations define how long the banner remains on the screen after you press INFO. Options are 5, 10, 15, or 20 seconds. The default value is 10 seconds.

#### To select the banner duration:

1. Press MENU.
2. Press ▼ to select "Preferences" and press OK.
3. Press ▼ to select "Banner Duration" and press OK.
4. Use the ▲▼ buttons to choose from the options.
5. Once you have made your selection, press OK.

### Preferences: Set Favorite Channels

Refer to Enhanced User Features section, page 21.

### Preferences: A/V Matrix

If you connected the A/V matrix as described in the Connections portion of the user manual (refer to page 12), then you must enable the A/V Matrix in the DIRECTV® Receiver before you can use it.

#### To enable/disable the A/V Matrix:

1. Press MENU.
2. Press ▼ to select "Preferences" and press OK.
3. Press ▼ to select "A/V Matrix" and press OK.
4. Select "Enable" and press OK.

Once enabled and connected, pressing the SOURCE button on the remote will switch between the video source(s) connected to Video IN1 and Video IN2 and satellite programming.

**Note:** If a video source is not connected or turned on and the A/V Matrix is enabled, pressing the SOURCE button will still point to that video input. Your TV will go blank. Hit the SOURCE button to cycle to the next video input or to satellite programming.

### Preferences: Remote Control ID

If you purchase two DSX 5500 or DSX 5540 receivers and use them in close proximity of each other, control them independently by assigning a separate ID number to each remote.

#### To change the ID number of the remote control:

1. Press MENU.
2. Press ▼ to select "Preferences" and press OK.
3. Press ▼ to select "Remote Control ID" and press OK.
4. The only option available is the alternate ID. Select and press OK.
5. Press and hold down the SAT and MUTE buttons on the remote until the SAT light stays on.
6. To set the ID number to 1, enter "111" or to set the ID to 0, enter "000". The SAT button will blink twice to confirm the entry.
7. Point the remote at the Receiver and press OK to complete the process.

**Note:** It is important at the end of the procedure to point the remote at the corresponding DIRECTV Receiver and press OK. Otherwise, the remote control will change its ID but the Receiver will not and communication will be lost between the two.

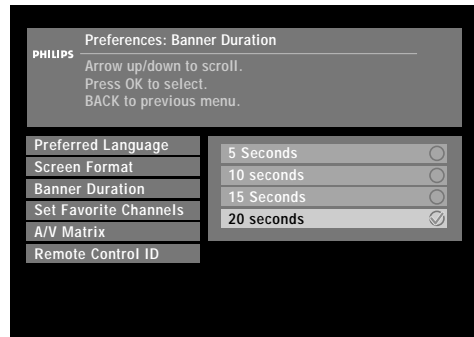

"Banner Duration" menu options

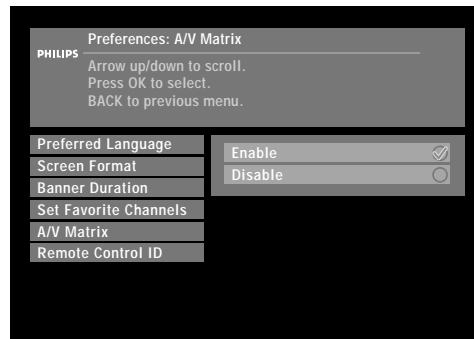

"A/V Matrix" menu

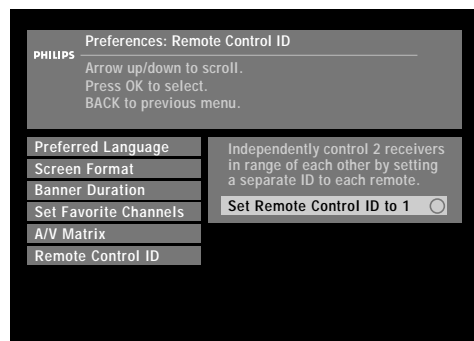

"Remote Control ID" menu

## Main Menu (cont'd)

### Preferences: Digital Audio (DSX 5540 only)

To get the full theater experience with Dolby Digital surround sound (when available), connect one or both of your digital audio outputs (refer to page 11) to your home theater equipment.

**To access this feature:**

1. Press MENU.
2. Press ▼ arrow to select "Preferences" and press OK.
3. Press ▼ arrow to select "Digital Audio" and press OK.
4. Use the ▲▼ arrows to select whether you want the outputs to only output Dolby Digital or PCM audio or if you want the DIRECTV® Receiver to auto-detect the type of audio stream present.

**Note:** The Dolby Digital audio track will always be the default audio track when enabled. If an alternate audio track is desired as the default selection, you must select the "PCM only" option.

"Dolby" and the double-D symbol are trademarks of Dolby Laboratories. Manufactured under license from Dolby Laboratories.

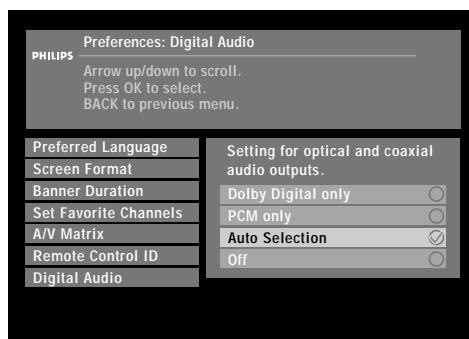

Options in the "Digital Audio" menu

### Main Menu: Parental Controls

If you want to control what channels and programs are being watched or how much is being spent on each pay per view purchase, Parental Controls allows you to do this with channel locks, spending limits, and rating limits. Parental Controls are protected by a 4-digit numeric password that you set.

**To access this feature:**

1. Press MENU.
2. Press ▼ to select "Parental Controls" and press OK.
3. Use the ▲▼ buttons to choose from the options and press OK.

#### Parental Controls: Lock The System (Lock/Unlock The DIRECTV® Receiver)

Once any Parental Control setting has been configured, the DIRECTV Receiver must be locked in order for those changes to take effect. Your DIRECTV Receiver can be locked or unlocked. When it is locked, the system will prompt you to enter the password whenever you want to change settings in the following menus: "Channel Locks", "Set Rating Limits", or "Set Spending Limits". The lock icon in the banner indicates a locked system.

**To lock or unlock the system:**

1. Choose "Lock The System" or "Unlock The System" from the "Parental Controls" menu.
2. When the system prompts you for a password, enter it using the numeric buttons on the remote control. If locking the system, you will need to confirm it before it takes effect. If you have forgotten or lost your password, contact your service provider.

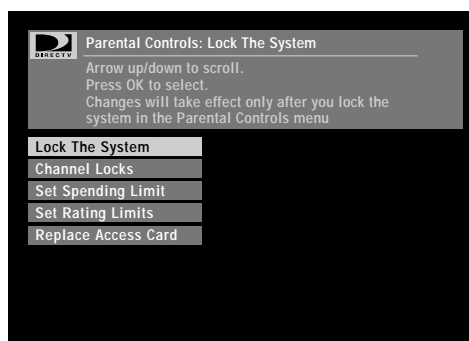

"Parental Controls" menu

#### Parental Controls: Channel Locks

Locking channels prevents a viewer from accessing the channels by requiring a password. You must lock the DIRECTV Receiver to enforce these settings (see above).

**To set Channel Locks:**

1. Choose "Channel Locks" from the "Parental Controls" menu and press OK.
2. To lock /unlock all channels, use the ▲▼ buttons to select "Lock All", or "Unlock All" and press OK.
3. To manually lock/unlock individual channels, press ►. Then, use the ▲▼ buttons to select a channel and press OK to toggle between lock and unlock.
4. Use the PAGE +/- buttons to scroll the channel list by a full page.
5. To store your new settings, select "Save Changes" and press OK.

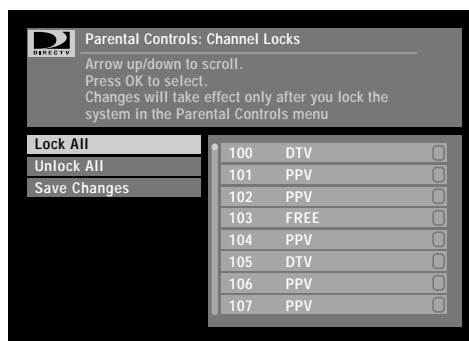

"Channel Locks" menu

## Main Menu (cont'd)

### Parental Controls: Set Spending Limit

You can set a per purchase spending limit on pay per view programs. It is not a cumulative limit. You must lock the DIRECTV® Receiver to enforce this setting (refer to page 29).

#### To set the Spending Limit:

1. Choose "Set Spending Limit" from the "Parental Controls" menu and press OK. The current purchase limit displays.
2. Enter the spending limit using the numeric buttons on the remote. Or, use the ◀▶ buttons to move from one digit to another, then use the ▲▼ buttons to set the value for each digit.

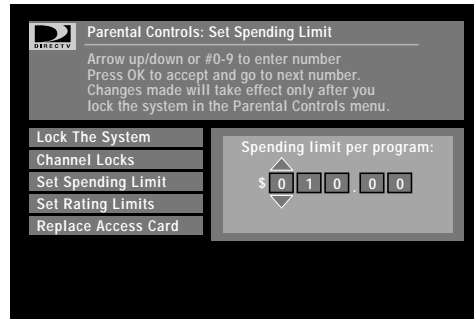

"Set Spending Limit" menu

### Parental Controls: Set Rating Limit

You can restrict viewing by setting the rating limits to certain levels. Ratings help you determine programming content, similar to the way films are rated. For example, a rating of "G" is a program suitable for general audiences, while a rating of "R" might be suitable for adults only. You must lock the system to enforce these settings. To view a locked program, you must first enter a password.

#### To set the Rating Limits:

1. Choose "Set Rating Limits" from "Parental Controls" menu and press OK.
2. There are three rating systems to set: Children-TV, Entire Audience-TV, and MPAA-Movies. You can lock or unlock all ratings in each system. When you lock a particular rating, all ratings exceeding the locked rating are automatically locked as well. For example, if you lock "R", "NC-17" and "X" will be automatically locked. Press ▲▼ to select the desired limit and press OK to lock or unlock it. The Children-TV and Entire Audience-TV options contain sublevel ratings that can further identify the programming content.

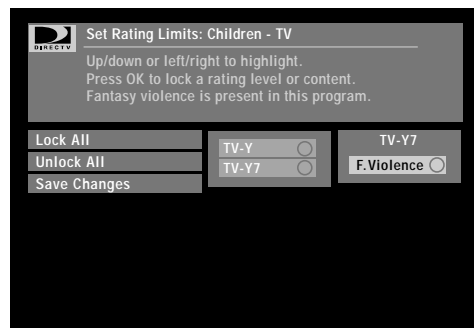

"Children-TV" rating system

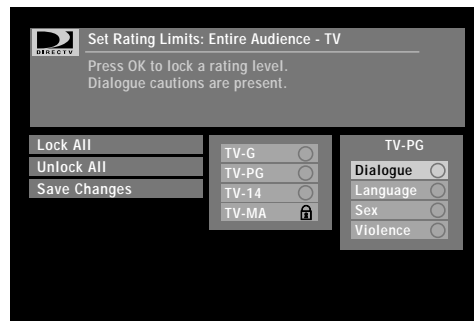

"Entire Audience" rating system

### Parental Controls: Replace Access Card

Use this menu to replace your current card with a new one, sent by your service provider. Be sure to follow the on-screen instructions. For information on inserting access cards, see page 8.

#### To replace your access card:

1. Press MENU.
2. Use the ▲▼ buttons on the remote control to highlight "Parental Controls". Press OK.
3. Choose "Replace Access Card", then press OK. Be sure the current access card is inserted in the DIRECTV Receiver. "Copying OLD access card information" will appear on the screen.
4. When prompted, remove the old card, insert the new card, then press OK.
5. When this process is completed, press OK to return to the previous menu.
6. Discard the old card since it no longer works.

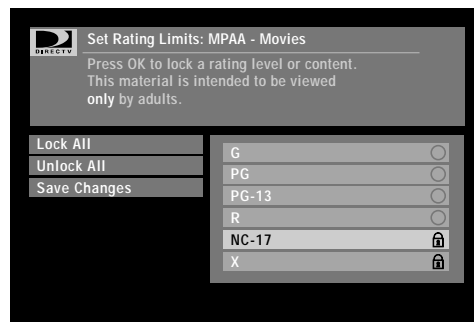

"MPAA-Movies" rating system

## Main Menu (cont'd)

### Main Menu: Purchases

#### Purchases: Past Purchases

The Past Purchases menu displays a summary of your past pay per view purchases. It includes the program name and channel number, program date, start and end time, price, and whether the program was viewed or cancelled. Information for all past purchases is stored on the access card and displayed with the most recent purchase first.

#### To view past purchases:

1. Press MENU.
2. Choose "Purchases" from the main menu and press OK.
3. Use the ▲▼ buttons to choose "Past Purchases" and press OK.
4. A list of past purchases displays indicating whether they were viewed or cancelled. You can scroll through the list using the ▲▼ buttons or using the PAGE+/- buttons to scroll by a full page.

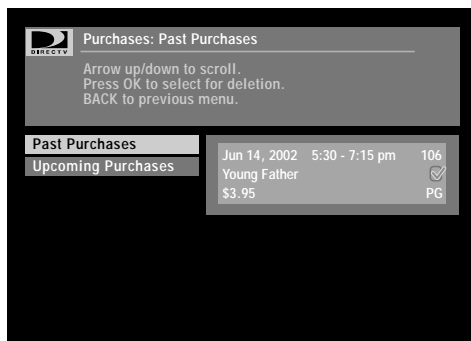

"Past Purchases" menu

#### Purchases: Upcoming Purchases

The Upcoming Purchases menu displays all future pay per view programs that you have purchased but not cancelled. You may cancel any pay per view program you have not yet watched that was purchased through the DIRECTV Receiver.

**Note:** You cannot cancel a PPV purchase if you have already tuned to the program.

#### To cancel purchases:

1. Press MENU.
2. Choose "Purchases" from the main menu and press OK.
3. Choose "Upcoming Purchases" and press OK.
4. A list displays of upcoming purchases that were ordered but not viewed. You can scroll through the list using the ▲▼ buttons or using the PAGE+/- buttons to scroll by a full page.
5. To delete a pending purchase, highlight it and press OK. A checkmark will appear.
6. Select "Save Changes" and press OK to cancel all checked programs from the upcoming purchases list.
7. You can verify the purchase was cancelled by checking in the "Past Purchases" menu.

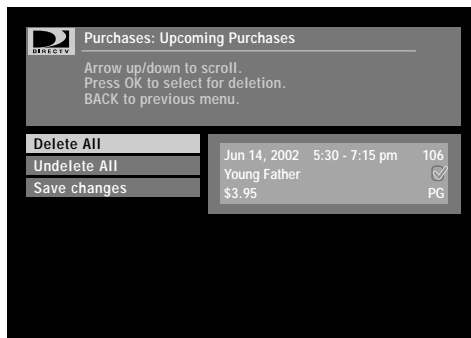

"Upcoming Purchases" menu

## Main Menu (cont'd)

### Main Menu: Setup

Use this menu to run through the setup process (professional installation is highly recommended). Configure each setting within "Enter ZIP Code" and "Dish Configuration." Use "Point Dish" and "System Test" to confirm your setup.

#### To view Setup options:

1. Press MENU.
2. Select "Setup" and press OK.
3. Use the ▲▼ buttons to select one of the "Setup" menu options.

### Setup: Enter ZIP Code

Use this function to correctly position the satellite antenna.

#### To enter your ZIP code:

1. At the "Setup" menu, select "Enter ZIP Code" and press OK.
2. Enter the ZIP code using the numeric buttons on the remote, or use the ▲▼ buttons to select each digit in the ZIP code field. Press the ► button to move to the next field.

#### Helpful Hint

- Your ZIP code is critical to the installation process.

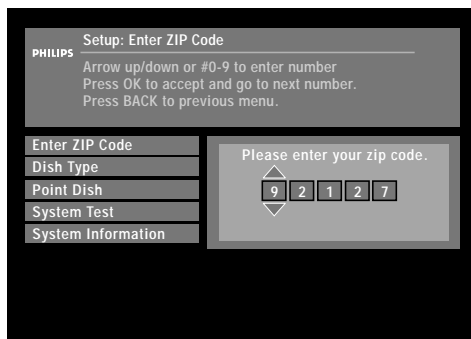

"Enter ZIP Code" menu

### Setup: Dish Type

Use this function to identify your type of satellite antenna dish.

#### To select your dish type:

1. At the "Setup" menu, select "Dish Type" and press OK.
2. Use the ▲▼ buttons to select "Manual Selection" if you know the type of dish you have. Otherwise, contact your installer or select "Auto Selection" and press OK.
3. Use the ▲▼ buttons to manually select your dish type and press OK.

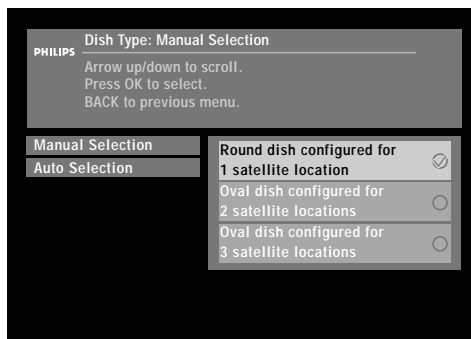

"Manual Selection" menu options

### Setup: Point Dish

Use this function to manually point the dish and correctly align it with the satellite(s). You may want to have a helper to read the onscreen displays for you during this procedure. Signal strength readings change approximately 2 seconds after each adjustment is made.

**Note:** Single dish installations often show higher signal strength than installations that receive signals from two or three satellites. The onscreen display will tell you how to align your dish based on your ZIP code.

#### To point your dish:

1. At the Setup menu, select "Point Dish" and press OK.
2. A signal strength meter displays. Adjust the dish until the signal strength meter stabilizes at a maximum reading. The range is 0 to 100. It is recommended to obtain a signal strength of at least 60. An audible tone will help with this procedure. The tones or beeps get faster as the signal strength increases until it becomes a continuous sound. If you have problems getting a signal, refer to the troubleshooting section of the user manual (page 35).

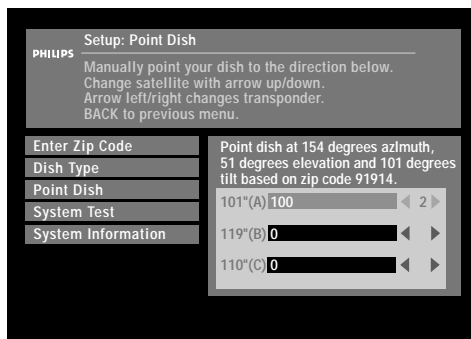

**Note:** Use the ▲ or ▼ buttons to switch between satellites. Use the ◀ or ▶ buttons to switch between transponders for the selected satellite.



## Main Menu (cont'd)

### Setup: System Test

This option performs a test of the system. This information is useful in troubleshooting if you need to contact customer service.

#### To run a system test:

1. At the Setup menu, select "System Test" and press OK. A message "Test in progress, Please Wait . . ." may appear. After a few seconds, the test results will display.

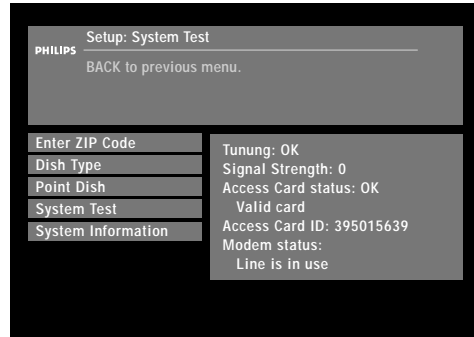

"System Test" menu

### Setup: System Information

This option shows information about your hardware and software that will be useful in troubleshooting if you need to contact customer service.

#### To view system information:

1. At the Setup menu, select "System Information" and press OK.
2. Use the PAGE +/- buttons to scroll the information.

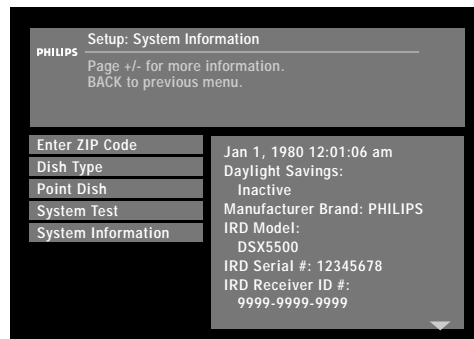

"System Information" menu

## Main Menu: System Upgrades

Your DIRECTV® Receiver is able to receive upgrades or modifications to some of its features and functions. These modifications will occur automatically, usually at times when the DIRECTV Receiver is not likely to be in use. If your DIRECTV Receiver is on when an upgrade or modification is sent, reception may be interrupted for a minute or two. Reception should return to normal after the modification is complete. Your DIRECTV Receiver must be plugged in to receive an upgrade. Do not unplug your DIRECTV Receiver while an upgrade is in progress. Consult the System Upgrades Menu to find a schedule of upgrades or modifications planned by DIRECTV.

#### To view past or future upgrades:

1. Press MENU.
2. Select "System Upgrades" in the Main Menu and press OK.
3. Use the ▲▼ buttons to select "Past Upgrades" or "Future Upgrades" and press OK.

## Main Menu (cont'd)

### Main Menu: Messages



When you receive a new message, the New Incoming Messages icon appears in the banner. You can view and delete messages. Each message includes the date and time it was sent. When new messages are received, the oldest message is automatically deleted if the maximum amount of messages (30) is exceeded. The banner on the Message screen indicates how many messages you have.

#### To view messages:

1. Press MENU.
2. Use the ▲▼ buttons to choose "Messages" and press OK.
3. Use the ▲▼ buttons to select and view a message.
4. When a message is displayed, press OK to delete a message (the torn envelope icon indicates a deleted message).
5. When you press BACK or EXIT, all deleted messages are removed permanently and will not display the next time you view messages.



"Messages" menu

### Main Menu: Caller ID

**Note:** You must have phone line connected to your Receiver and be subscribed to Caller ID service from your phone service provider.

When a phone call comes in, a display will appear containing call information.

#### To enable or disable Caller ID:

1. Press the MENU button. Use the ▲▼ buttons to select "Caller ID" and press OK.
2. Use the ▲▼ buttons to select "Enable/Disable" and press OK.
3. Use the ▲▼ buttons to select either "Enable" or "Disable" and press OK.

#### To view Caller ID history:

At the Caller ID screen, use the ▲▼ buttons to select "Call History" and press OK. The history information will be displayed.

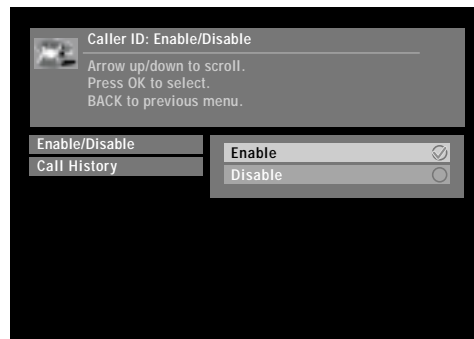

"Caller ID" options

## Troubleshooting

### Where To Find Help

General help is available by highlighting the "HELP" button in the Guide menu and pressing OK.

<b>No picture / poor picture</b>	<ol style="list-style-type: none"> <li>1. Press the POWER button on the front panel of the DIRECTV® Receiver if the power indicator LED is not on.</li> <li>2. Make sure TV power is on.</li> <li>3. Check TV connection from the DIRECTV Receiver.             <ol style="list-style-type: none"> <li>a. If using RF output, tune TV to channel 3 or 4 to match the channel switch on the rear panel of the DIRECTV Receiver.</li> <li>b. If using composite, S-Video, or component outputs, select the proper input on your TV.</li> </ol> </li> <li>4. Make sure the SAT IN coaxial cable is properly connected to the antenna's LNB or multi-switch. Check the cable for kinks.</li> <li>5. Check the satellite antenna's signal strength (see page 32). To ensure a quality picture, make sure the output signal is coming directly from the DIRECTV Receiver and not through your VCR.</li> <li>6. If the A/V Matrix is enabled, press the SOURCE button on the remote to select from satellite programming, VIDEO IN1, or VIDEO IN2.</li> <li>7. Turn DIRECTV Receiver off, unplug, wait 10 to 15 seconds, and plug back in.</li> </ol> <p><b>Note:</b> Adverse weather conditions may affect picture quality.</p>
<b>No sound</b>	<ol style="list-style-type: none"> <li>1. Make sure that the TV volume is not set to mute.</li> <li>2. Check audio connections from the DIRECTV Receiver to the TV.             <ol style="list-style-type: none"> <li>a. If using AUDIO LEFT/RIGHT OUT1, select the proper inputs on your TV.</li> <li>b. If using DIGITAL AUDIO OUT (optical or coaxial – DSX 5540 only), select the proper input(s) on your home theater receiver.</li> </ol> </li> <li>3. Check if the problem exists on other channels. If so, turn DIRECTV Receiver off, unplug, wait 10 to 15 seconds, and plug back in.</li> </ol>
<b>Remote does not work</b>	<ol style="list-style-type: none"> <li>1. Make sure the batteries are inserted correctly (see page 13) and are not dead.</li> <li>2. Be sure you are within operating range of the DIRECTV Receiver.</li> <li>3. Make sure no objects obstruct the line of sight between the remote and the DIRECTV Receiver.</li> <li>4. Press the SAT button on the remote.</li> <li>5. If remote control ID was changed so the DIRECTV Receiver and the remote no longer communicate, change the ID number back to the previous ID number (see page 28).</li> </ol>
<b>Ordering or cancelling pay per view</b>	<ol style="list-style-type: none"> <li>1. Cannot order -             <ol style="list-style-type: none"> <li>a. It may be too late to purchase the program. Check for other show times.</li> <li>b. Check phone cord connection on rear panel of the DIRECTV Receiver and at the wall jack. Keep phone cord connected.</li> </ol> </li> <li>2. Cannot cancel - you cannot cancel pay per view orders that you've watched or tuned to, or ones not ordered through your DIRECTV Receiver.</li> </ol>
<b>Parental Controls</b>	<ul style="list-style-type: none"> <li>• The system must be locked before your Parental Controls settings will take effect (see page 29).</li> <li>• The system must be unlocked before you can make changes to the Parental Controls settings.</li> </ul>
<b>Favorites / SmartSurf</b>	<p>Cannot disable – press the POWER button to go into standby and press the POWER again to bring DIRECTV Receiver out of standby.</p>
<b>Audio track incorrect</b>	<ol style="list-style-type: none"> <li>1. Check the default language settings (see page 27).</li> <li>2. The program provider may not provide audio in all the languages listed in the "Preferred Language" menu.</li> <li>3. If using a DSX 5540, a Dolby audio track will always be the default audio track for the "Dobly Digital Only" setting. If an alternate audio track is desired as the default selection, change the Digital Audio setting to "PCM only" in the "Preferences" menu.</li> </ol>
<b>Cannot access channel(s)</b>	<ol style="list-style-type: none"> <li>1. Check that you are subscribing to the station to which you want to tune to.</li> <li>2. Be sure the system is not locked as indicated by a lock icon in the banner.</li> <li>3. Make sure SmartSurf and/or Favorites is not turned on. See "Favorites/SmartSurf" above for instructions to cancel either feature.</li> </ol>

## Limited Warranty

### Digital Satellite Receiver

90 Days Free Exchange / 91 Days-One Year Nominal Fee Exchange  
This product must be carried in for repair.

#### WHO IS COVERED?

You must have proof of purchase to receive warranty service. A sales receipt or other document showing that you purchased the product is considered proof of purchase.

#### WHAT IS COVERED?

Warranty coverage begins the day you buy your product. For 90 days from the date of purchase, the Digital Satellite Receiver will be replaced with a new, repaired, renewed, or comparable product (whichever is deemed necessary) if it becomes defective or inoperative. This exchange is done at no charge to you.

From 91 days to one year from the date of purchase, you must pay a nominal fee for a new or renewed product. This exchange offer ends one year after the date of purchase.

All products, including replacement products, are covered only for the original warranty period. When the warranty on the original product expires, the warranty on the replacement product also expires.

#### WHAT IS EXCLUDED?

Your warranty does not cover:

- labor charges for installation or setup of the product.
- installation, performance of, or repair of audio/video cabling, telephone line, or accessory attachments used in accessory ports outside of the product.
- product replacement because of misuse, accident, lightning damage, unauthorized repair, or other cause not within the control of Philips.
- incidental or consequential damages resulting from the product. (Some states do not allow the exclusion of incidental or consequential damages, so the above exclusion may not apply to you.)
- reception transmission problems caused by signal conditions, telephone line, or cable or antenna systems outside the unit.
- a product that requires modification or adaptation to enable it to operate in any country other than the country for which it was designed, manufactured, approved and/or authorized, or repair of products damaged by these modifications.
- a product used for commercial or institutional purposes.
- DIRECTV service is separate and distinct from this product (hardware) warranty.

#### WHERE IS EXCHANGE AVAILABLE?

You may exchange the product in all countries where the product is officially distributed by Philips. In countries where Philips does not distribute the product, the local Philips service organization will attempt to provide a replacement product (although there may be a delay if the appropriate product is not readily available).

#### MAKE SURE YOU KEEP...

Please keep your sales receipt or other document showing proof of purchase. Attach it to this owner's manual and keep both nearby. Also keep the original box and packing material in case you need to return your product.

#### BEFORE REQUESTING EXCHANGE...

Please check your owner's manual before requesting exchange. Adjustments of the controls discussed there may save you a call.

#### TO EXCHANGE YOUR PRODUCT...

An exchange will be managed by Philips. If you believe you need to exchange your Digital Satellite Receiver, contact Philips at 1-800-464-1131. A representative will go through a diagnostic checklist with you. If it is determined that the product needs to be exchanged, you will receive a return authorization number. The representative will give you complete shipping details.

#### TO GET OUT-OF-WARRANTY EXCHANGE...

To exchange your product after the warranty expires, contact Philips at 1-800-464-1131 to determine the cost of out-of-warranty exchange for your product.

*All implied warranties, including implied warranties of merchantability and fitness for a particular purpose, are limited in duration to the duration of this express warranty. Some states do not allow limitations on how long an implied warranty lasts, so the above limitation may not apply to you.*

*This warranty gives you specific legal rights. You may have other rights which vary from state/province to state/province.*

Philips, P. O. Box 520890, Miami, FL 33152 (402) 536-4171

EL6471E002 / 8-02

3111 176 50891

Printed in Mexico

## Free Manuals Download Website

<http://myh66.com>

<http://usermanuals.us>

<http://www.somanuals.com>

<http://www.4manuals.cc>

<http://www.manual-lib.com>

<http://www.404manual.com>

<http://www.luxmanual.com>

<http://aubethermostatmanual.com>

Golf course search by state

<http://golfingnear.com>

Email search by domain

<http://emailbydomain.com>

Auto manuals search

<http://auto.somanuals.com>

TV manuals search

<http://tv.somanuals.com>