

Register your product and get support at

www.philips.com/welcome

User manual

PHILIPS

Contents

1	Important	2
	Safety	2
	Notice	3

2	Your Wireless Hi-Fi Speaker	4
	Introduction	4
	What's in the box	4
	What else you need	4
	Overview of the main unit	4

3	Prepare	6
	Connect power and switch on	6

4	Connect AW3000 to your home	
	Wi-Fi network	7
	Option 1: Set up wired connection	7
	Option 2: Set up wireless connection	8

5	Play	10
	Stream audio to AW3000	10
	Listen to Internet radio stations through AW3000	11
	Play from an external device	12

6	Product information	14
	Specifications	14

7	Troubleshooting	15
----------	------------------------	-----------

1 Important

Safety

Information for Europe:
Know these safety symbols



The 'exclamation mark' calls attention to features for which you should carefully read the supplied literature to prevent operating and maintenance problems. The 'lightening bolt' symbol indicates uninsulated components within the product that can cause an electric shock. To reduce the risk of fire or electric shock, do not expose the product to rain or moisture and do not place any objects filled with liquids, such as vases, on the product.

- 1 Read these instructions.
- 2 Keep these instructions.
- 3 Heed all warnings.
- 4 Follow all instructions.
- 5 Do not use this product near water.
- 6 Clean only with dry cloth.
- 7 Do not block any ventilation openings. Install in accordance with the manufacturer's instructions.
- 8 Do not remove the casing of this product.

- 9 Do not expose the product to dripping / splashing water, rain or high humidity.
- 10 Keep this product away from direct sunlight, naked flames or heat.
- 11 Do not install near any heat sources such as radiators, heat registers, stoves, or other electrical equipment (including amplifiers).
- 12 Do not place any other electrical equipment on the product.
- 13 Do not place any sources of danger on the product (e.g. objects containing liquids, burning candles).
- 14 Where the mains plug or an appliance coupler is used as the disconnect device, the disconnect device shall remain readily operable.

Warning

- Never remove the casing of this apparatus.
- Never lubricate any part of this apparatus.
- Never place this apparatus on other electrical equipment.
- Keep this apparatus away from direct sunlight, naked flames or heat.
- Ensure that you always have easy access to the power cord, plug or adaptor to disconnect this apparatus from the power.

Risk of overheating! Never install this apparatus in a confined space. Always leave a space of at least four inches around this apparatus for ventilation. Ensure curtains or other objects never cover the ventilation slots on this apparatus.

Notice



This product complies with the radio interference requirements of the European Community.

CE 0560		R&TTE Directive 1999/5/EC				
BG ✓	RO ✓	BE ✓	LT ✓	LI ✓	IS ✓	SE ✓
DK ✓	ES ✓	CZ ✓	NL ✓	AT ✓	LV ✓	SK ✓
FR ✓	UK ✓	FI ✓	PT ✓	CY ✓	MT ✓	PL ✓
HU ✓	NO ✓	GR ✓	SI ✓	EE ✓		
IT ✓	LU ✓	IE ✓	CH ✓	DE ✓		

The device can be operated in the EU without restrictions indoors, but cannot be operated outdoors in France in the whole of the band until further notice.

This product complies with the requirement of the 1999/5/EC directive.

Modifications

Modifications not authorized by the manufacturer may void user's authority to operate this product.



Your product is designed and manufactured with high quality materials and components, which can be recycled and reused.



When this crossed-out wheeled bin symbol is attached to a product it means that the product is covered by the European Directive 2002/96/EC.

Please inform yourself about the local separate collection system for electrical and electronic products.

Please act according to your local rules and do not dispose of your old products with your normal household waste. Correct disposal of your old product helps to prevent potential negative consequences for the environment and human health.

Environmental information

All unnecessary packaging has been omitted. We have tried to make the packaging easy to separate into three materials: cardboard (box), polystyrene foam (buffer) and polyethylene (bags, protective foam sheet.)

Your system consists of materials which can be recycled and reused if disassembled by a specialized company. Please observe the local regulations regarding the disposal of packaging materials, exhausted batteries and old equipment.

Android is a trademark of Google Inc. Use of this trademark is subject to Google permissions.

Class II equipment symbol:



CLASS II apparatus with double insulation, and no protective earth provided.

Note

- The type plate is located on the bottom of the apparatus.

2 Your Wireless Hi-Fi Speaker

Congratulations on your purchase, and welcome to Philips! To fully benefit from the support that Philips offers, register your product at www.philips.com/welcome.

If you contact Philips, you will be asked for the model and serial number of this apparatus. The model number and serial number are on the bottom of the apparatus. Write the numbers here:

Model No. _____

Serial No. _____

Introduction

With this wireless Hi-Fi speaker, you can:

- stream audio from your iOS or Android device.
- listen to Internet radio stations.
- stream audio from a PC/Mac installed with Media Manager downloaded from www.philips.com/mediamanager.
- play music from other audio devices through the MP3-LINK socket.

What's in the box

Check and identify the contents of your package:

- Wireless Hi-Fi speaker with built-in Wi-Fi
- 1 x AC power adaptor
- 1 x MP3 link cable
- Quick start guide
- Safety sheet and other documents

What else you need

To stream audio wirelessly to AW3000, you need:

- a certified Wi-Fi router
- an iOS or Android device, such as an iPod touch/iPhone/iPad or an Android phone or tablet; or a PC/Mac enabled with Wi-Fi
- the **Philips AirStudio** app available on Apple **App Store** (for iOS devices) or Google **Play Store** (for Android devices)

Your AW3000 should be connected to the same local network as your iOS/Android device or PC/Mac through the Wi-Fi router.

Overview of the main unit

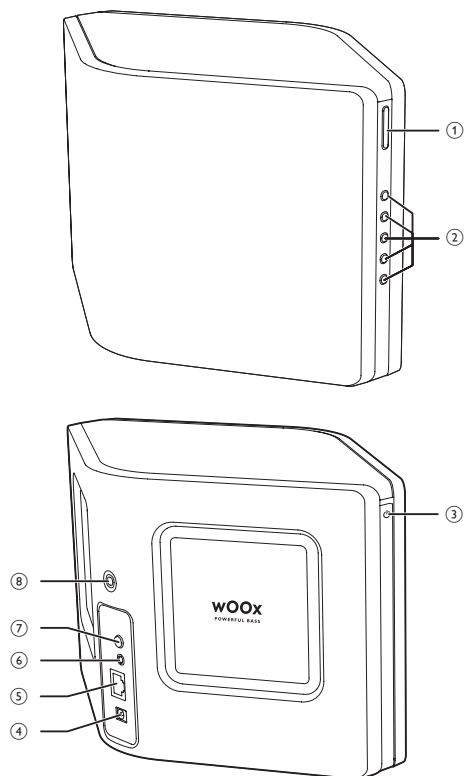

- ① +/-
 - Adjust volume.
- ② Numeric keys (1 to 5)
 - Select an Internet radio station.
- ③ Power indicator/button ϕ
 - Show the current status of the unit.
 - Press to turn the unit on/off.
- ④ DC IN
 - Connect the power adaptor.
- ⑤ ETHERNET
 - (Optional) Connect to a wireless router through an Ethernet cable (not supplied).
- ⑥ MP3-LINK
 - Connect an external audio player through the supplied MP3 link cable.
- ⑦ WI-FI SETUP button
 - Connect the unit to a Wi-Fi network.
- ⑧ Screw hole for wall mounting

Tip

- Through the 1/4" (6.35mm) hole (depth: 9mm) on the back of AW3000, you can mount the device onto wall close to an AC outlet. Before the wall mounting operation, you need to prepare the following accessories (note supplied): (1) A suitable wall mounting bracket; (2) A screw nut with the specifications of 1/4"-20UNS (M6.35 x p1.27mm); (3) A screw (length: at least 15mm) that matches the specified screw nut.
- To facilitate cabling, leave a distance of more than 35mm between the wall mounting bracket and the back of AW3000.

3 Prepare

Always follow the instructions in this chapter in sequence.

Connect power and switch on

! Caution

- Risk of product damage! Make sure that the power supply voltage matches the voltage printed on the bottom of the unit.
- Risk of electric shock! When you unplug the AC adaptor; always pull the plug from the socket. Never pull the cord.
- Before you connect the AC adaptor; make sure that you have completed all the other connections.

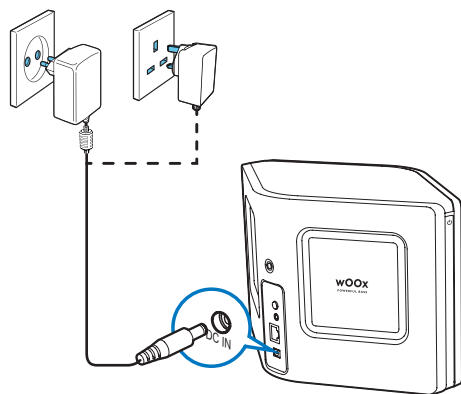

- Connect the AC power cord to
 - the **DC IN** socket on the back of the unit.
 - the wall power socket.

↳ The unit switches on automatically.

↳ The power indicator blinks amber; and after a while turns to solid amber.
- To switch the unit to standby mode, press the power button/indicator above ϕ .

- To switch the unit on from standby mode, press the power button/indicator above ϕ again.

4 Connect AW3000 to your home Wi-Fi network

There are two options for you to set up connection between AW3000 and your existing home Wi-Fi network.

- **Wired connection**

Use an Ethernet cable (not supplied) to connect AW3000 to your home Wi-Fi router directly. After successful connection, you can enjoy wireless streaming to AW3000 through your home Wi-Fi network.

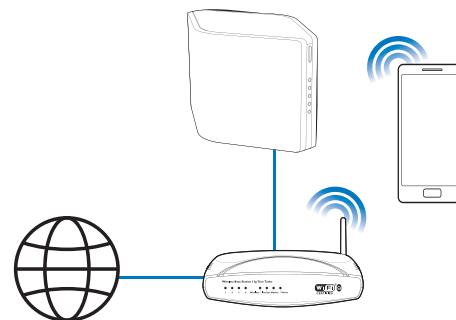

- **Wireless connection**

Apply your home Wi-Fi settings to AW3000 from an iOS or Android device. Once connected successfully, AW3000 will remember your home Wi-Fi settings. Then you can enjoy wireless streaming whenever AW3000 is powered on and connected to your home Wi-Fi network automatically.

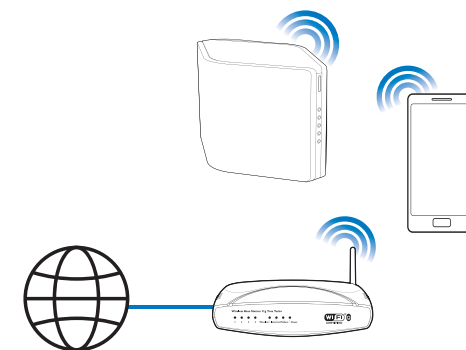

Before connection of AW3000 to you home Wi-Fi network, make sure that:

- ① your Wi-Fi router is powered on and working properly.
- ② AW3000 is powered on and the power indicator stays amber steadily.

Option 1: Set up wired connection

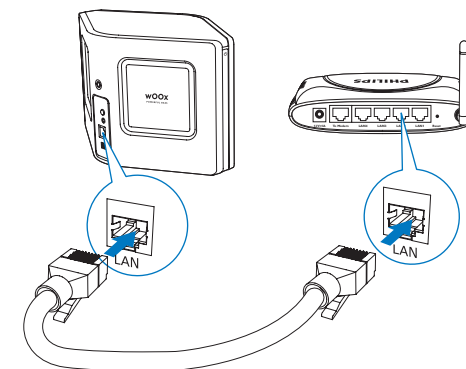

- Connect an Ethernet cable (not supplied) to:
 - the **ETHERNET** socket on the back of the unit
 - one of the Ethernet ports on your home Wi-Fi router

Option 2: Set up wireless connection

- 1 (For iPod touch/iPhone/iPad users) Install **Philips AirStudio** from Apple App Store and run the app.



- (For users of Android smartphones or tablets) Install **Philips AirStudio** from Android Market and run the app.



- 2 Find the activation code at the bottom of your AW3000, then type in the box.



- 3 Tap **Setup a new speaker**, read the general setup steps, then tap **Next** to continue.



- 4 Check the power-on status of your AW3000 as instructed, then tap **Next** to continue.



- 5 Follow the on-screen instructions until successful setup of Wi-Fi connection between AW3000 and your home Wi-Fi network.



5 Play

Stream audio to AW3000

Note

- Make sure that your iOS/Android device or PC/Mac is connected to the same Wi-Fi network as AW3000.



- 4 Select a song from the list to start play.



Stream from your iOS or Android smartphone or tablet

- 1 Run **Philips AirStudio** on your iOS or Android smartphone or tablet.
- 2 Hold and drag the icon of your device towards the speaker to set up Wi-Fi connection.

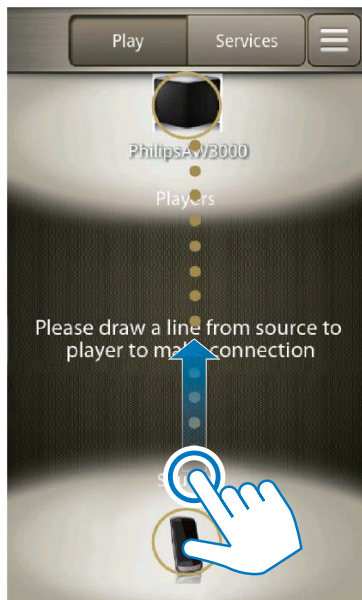

- 3 Tap the icon of your device to show music available for streaming.

Stream from your PC/Mac

To stream music from your PC/Mac to AW3000, you need to install a media sharing software (such as Media Manager available on www.philips.com/mediamanager) to your PC/Mac first. In this way, your PC/Mac can work as a media sharing server that streams music to compliant players.

- 1 Download Media Manager from www.philips.com/mediamanager.
- 2 Install Media Manager onto your PC/Mac with the license key available on the quick start guide.
- 3 Run **Philips AirStudio** on your iOS or Android smartphone or tablet.
- 4 Hold and drag the icon of your PC/Mac towards the speaker to set up Wi-Fi connection.

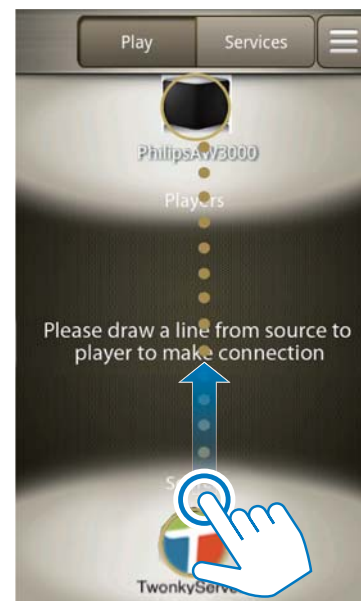

- 5 Tap the icon of your PC/Mac to show music available for streaming.
- 6 Select a song from the list to start play.



Tip

- You can also control music play from the media sharing software on your PC/Mac.

Listen to Internet radio stations through AW3000

- 1 Run **Philips AirStudio** on your iOS or Android smartphone or tablet.
- 2 Tap **Services** -> **Philips AW3000**.

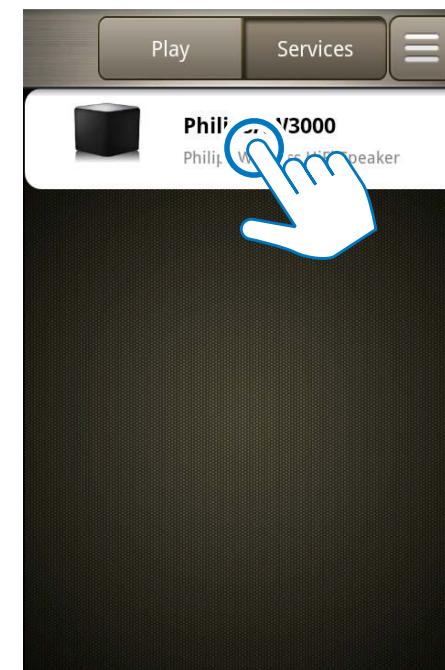

- 3 Tap **Internet radio** to select the Internet radio source.

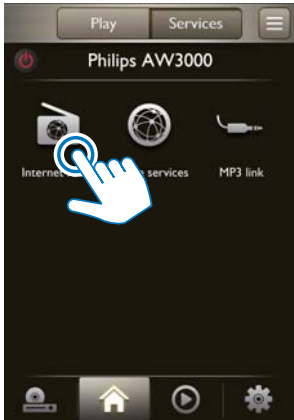

- 1 Connect the supplied MP3 link cable to:
 - the **MP3-LINK** socket on the back of the unit.
 - the headphone socket on an external audio player.

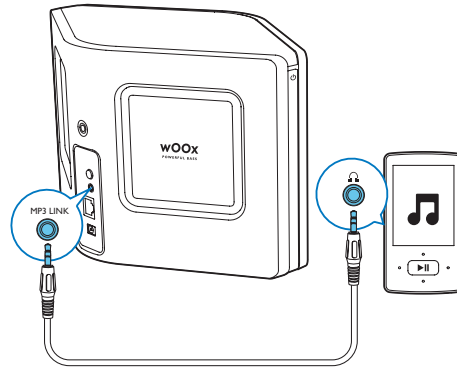

- 2 Run **Philips AirStudio** on your iOS or Android smartphone or tablet.
- 3 Tap **Services** -> **Philips AW3000**.

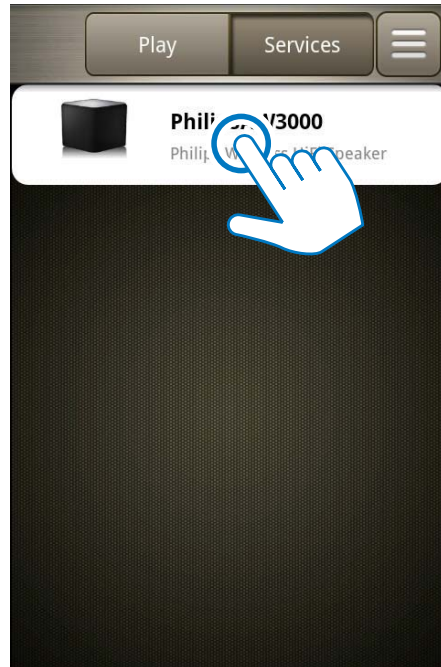

- 4 Tap **MP3 link** to select the MP3 link source.



- 5 Use the controls on your audio player to control music play.

- 4 Follow the on-screen instructions to tune to your favorite radio stations.



Tip

- You can add your favorite stations to the preset list as instructed on the app. Then, you can press the **numeric keys (1-5)** on AW3000 directly to tune to the corresponding radio station.

Play from an external device

You can also listen to an external audio player through the unit.

6 Product information

Note

- Product information is subject to change without prior notice.

Specifications

Amplifier

Rated Output Power	2 X 18 W RMS
Frequency Response	80 Hz - 18 kHz, ±3 dB
Signal to Noise Ratio	> 86 dB
MP3 Link	800 mV RMS 20 kohm

Speakers

Speaker Impedance	8 ohm
Speaker Driver	66 mm full range
Sensitivity	82 dB/m/W

Wireless

Wireless standard	802.11b/g
Wireless security	WEP (64 or 128 bit), WPA/WPA2 (8-63 characters)
Frequency range	2412 - 2462 MHz (CH1-CH11) (for /79, /37, /55, /97) 2412 - 2472 MHz (CH1-CH13) (for /12, /10, /05)
PBC (one button push)	Yes

General information

AC power	Input: 100 ~ 240V, 50/60 Hz 2A
PHILIPS SWITCHING POWER SUPPLY MODEL: EFS05001800250 CE	Output: 18 V --- 2.5 A
Operation Power Consumption	40 W
Power Consumption in Standby Mode	< 0.5 W
Dimensions - Main Unit (L x W x H)	358 x 137 x 203 mm
Weight - With Packing - Main Unit	3.05 kg 2.1 kg

7 Troubleshooting

Warning

- Never remove the casing of this apparatus.

To keep the warranty valid, never try to repair the system yourself.

If you encounter problems when using this apparatus, check the following points before requesting service. If the problem remains unsolved, go to the Philips web site (www.philips.com/welcome). When you contact Philips, ensure that the apparatus is nearby and the model number and serial number are available.

No power

- Make sure that the AC power plug of the device is connected properly.
- Make sure that there is power at the AC outlet.

No sound or poor sound

- Adjust volume on the Philips AirStudio app or on AW3000 directly.
- If you have chosen the wired connection, check whether the Ethernet cable has been connected properly and securely (see 'Option 1: Set up wired connection' on page 7).
- Check the Wi-Fi network connection. Set up the network again if needed (see 'Option 2: Set up wireless connection' on page 8).
- If the audio source is an external audio player, adjust volume on the audio player directly.

No response from the unit

- Restart AW3000, and then set up the Wi-Fi network for AW3000 again (see 'Option 2: Set up wireless connection' on page 8).
- Disconnect and reconnect the AC power plug, and then switch on the device again.

Wi-Fi network connection failed

- Check if your Wi-Fi router is Wi-Fi 802.11b/g certified. This device is only compatible with Wi-Fi 802.11b/g certified routers.
- If your Wi-Fi router is Wi-Fi 802.11n certified, make sure to enable the 802.11b/g mode. AW3000 does not support connection to routers with 802.11n only.
- This device does not support the WPS-PIN method.
- Enable SSID broadcast on the Wi-Fi router.
- Keep away from potential sources of interference which may affect Wi-Fi signal, such as microwave ovens.
- Make sure that the SSID name of your home router consists of alphanumeric characters, with no space or special characters like %/#/* inserted.
- If you choose to rename your AW3000 manually on the **Philips AirStudio** app, do not use special characters or symbols.
- For some new types of Wi-Fi routers, a network name (SSID) may be created automatically when you use WPS for connection. Always change the default network name (SSID) to a simple one that consists of alphanumeric characters, and also change the Wi-Fi security mode to secure your network.

Occasional breaking of music streaming

Do one or all of the following:

- Move AW3000 closer to your Wi-Fi router.
- Remove any obstacles between AW3000 and your Wi-Fi router.
- Avoid using Wi-Fi channel which is overlapped by the nearby Wi-Fi network.
- Check if your network speed is fast enough (in cases where multiple devices share the same router, the wireless performance may be affected). Turn off the other devices connected to your home router.
- Enable the Quality of Service (QoS) option (if available on the Wi-Fi router).
- Turn off other Wi-Fi routers.

Music streaming failed with PC/Mac

- Temporarily disable the firewall and security software to see whether it blocks the ports that the media sharing software (Media Manager) uses to stream content. See the help documentation of your firewall and security software on how to unblock the ports used by wireless media sharing.
- When you use iPod Touch/iPhone/iPad/PC/Mac for music streaming, if the music play breaks or stops, try to restart your iPod Touch/iPhone/iPad, media sharing software, or AW3000.
- Video streaming or FTP downloads may overload your router and therefore may cause interruptions during music streaming. Try to reduce the load of your router.



Specifications are subject to change without notice
© 2012 Koninklijke Philips Electronics N.V.
All rights reserved.

Document order number: 000000000000



Free Manuals Download Website

<http://myh66.com>

<http://usermanuals.us>

<http://www.somanuals.com>

<http://www.4manuals.cc>

<http://www.manual-lib.com>

<http://www.404manual.com>

<http://www.luxmanual.com>

<http://aubethermostatmanual.com>

Golf course search by state

<http://golfingnear.com>

Email search by domain

<http://emailbydomain.com>

Auto manuals search

<http://auto.somanuals.com>

TV manuals search

<http://tv.somanuals.com>