

DVDVIDEO DIGITAL SURROUND SYSTEM

LX3750



Need help? Call us!

Philips representatives are ready to help you with any questions about your new product. We can guide you through Connections, First-time Setup, or any of the Features. We want you to start enjoying your new product right away!

**CALL US BEFORE YOU CONSIDER
RETURNING THE PRODUCT!**

1-800-531-0039

or

Visit us on the web at www.philips.com



PHILIPS

Return your Warranty Registration card today to ensure you receive all the benefits you're entitled to.

• Once your Philips purchase is registered, you're eligible to receive all the privileges of owning a Philips product.

• So complete and return the Warranty Registration Card enclosed with your purchase at once, and take advantage of these important benefits.

Warranty Verification

Registering your product within 10 days confirms your right to maximum protection under the terms and conditions of your Philips warranty.

Owner Confirmation

Your completed Warranty Registration Card serves as verification of ownership in the event of product theft or loss.

Model Registration

Returning your Warranty Registration Card right away guarantees you'll receive all the information and special offers which you qualify for as the owner of your model.

PHILIPS



Congratulations on your purchase, and welcome to the "family!"

Dear Philips product owner:

Thank you for your confidence in Philips. You've selected one of the best-built, best-backed products available today. And we'll do everything in our power to keep you happy with your purchase for many years to come.

As a member of the Philips "family," you're entitled to protection by one of the most comprehensive warranties and outstanding service networks in the industry.

What's more, your purchase guarantees you'll receive all the information and special offers for which you qualify, plus easy access to accessories from our convenient home shopping network.

And most importantly you can count on our uncompromising commitment to your total satisfaction.

All of this is our way of saying welcome – and thanks for investing in a Philips product.

Sincerely,

Lawrence J. Blanford
President and Chief Executive Officer

P.S. Remember, to get the most from your Philips product, you must return your Warranty Registration Card within 10 days. So please mail it to us right now!

Know these safety symbols



This "bolt of lightning" indicates uninsulated material within your unit may cause an electrical shock. For the safety of everyone in your household, please do not remove product covering.

The "exclamation point" calls attention to features for which you should read the enclosed literature closely to prevent operating and maintenance problems.

WARNING: TO PREVENT FIRE OR SHOCK HAZARD, DO NOT EXPOSE THIS EQUIPMENT TO RAIN OR MOISTURE.

CAUTION: To prevent electric shock, match wide blade of plug to wide slot, and fully insert.

For Customer Use

Enter below the Serial No. which is located on the rear of the cabinet. Retain this information for future reference.

Model No. _____

Serial No. _____



Canada

English:

This digital apparatus does not exceed the Class B limits for radio noise emissions from digital apparatus as set out in the Radio Interference Regulations of the Canadian Department of Communications.

Français:

Cet appareil numérique n'émet pas de bruits radioélectriques dépassant les limites applicables aux appareils numériques de Class B prescrites dans le Règlement sur le Brouillage Radioélectrique édicté par le Ministère des Communications du Canada.

English ----- 5

Français ----- 35

Español ----- 65

Manufactured under license from Dolby Laboratories. "Dolby", "Pro-Logic" and the double-D symbol are trademarks of Dolby Laboratories. Confidential Unpublished Works. ©1992-1999 Dolby Laboratories, Inc. All rights reserved.

Manufactured under license from Digital Theater Systems, inc. US Pat. No. 5,451,942,5,956,674,5,974,380,5,978,762 and other worldwide patents issued and pending. "DTS" and "DTS Digital Surround" are registered trademarks of Digital Theater Systems, Inc. Copyright 1996,2000 DigitalTheater Systems, Inc. All rights reserved.

This product incorporates copyright protection technology that is protected by method claims of certain U.S. patents and other intellectual property rights owned by Macrovision Corporation and other rights owners. Use of this copyright protection technology must be authorized by Macrovision Corporation, and is intended for home and other limited viewing uses only unless otherwise authorized by Macrovision Corporation. Reverse engineering or disassembly is prohibited.

Laser

Type	Semiconductor laser GaAlAs
Wave length	650nm
Output Power	7mW
Beam divergence	60 degree

The set complies with the FCC-Rules, Part 15 and with 21 CFR 1040.1. Operation is subject to the following two conditions:

- 1. This device may not cause harmful interference, and**
- 2. This device must accept any interference received, including interference that may cause undesired operation.**

NOTE:
PICTURES SHOWN MAY BE DIFFERENT BETWEEN COUNTRIES.

NEVER MAKE OR CHANGE CONNECTIONS WITH THE POWER SWITCHED ON.

CAUTION

Use of controls or adjustments or performance of procedures other than those specified herein may result in hazardous radiation exposure or other unsafe operation.

ATTENTION

L'utilisation des commandes ou réglages ou le non-respect des procédures ci-inclues peuvent se traduire par une exposition dangereuse à l'irradiation.

ATENCIÓN

El uso de mando o ajustes o la ejecución de métodos que no sean los aquí descritos puede ocasionar peligro de exposición a radiación.

IMPORTANT SAFETY INSTRUCTIONS

1. Read these instructions.
2. Keep these instructions.
3. Heed all warnings.
4. Follow all instructions.
5. Do not use this apparatus near water.
6. Clean only with dry cloth.
7. Do not block any ventilation openings. Install in accordance with the manufacturer's instructions.
8. Do not install near any heat sources such as radiators, heat registers, stoves, or other apparatus (including amplifiers) that produce heat.
9. Do not defeat the safety purpose of the polarized or grounding-type plug. A polarized plug has two blades with one wider than the other. A grounding type plug has two blades and a third grounding prong. The wide blade or the third prong are provided for your safety. If the provided plug does not fit into your outlet, consult an electrician for replacement of the obsolete outlet.
10. Protect the power cord from being walked on or pinched, particularly at plugs, convenience receptacles, and the point where they exit from the apparatus.

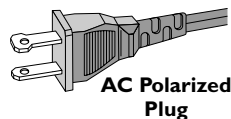

11. Only use attachments/accessories specified by the manufacturer.
12.  Use only with the cart, stand, tripod, bracket, or table specified by the manufacturer or sold with the apparatus. When a cart is used, use caution when moving the cart/apparatus combination to avoid injury from tip-over.
13. Unplug this apparatus during lightning storms or when unused for long periods of time.
14. Refer all servicing to qualified service personnel. Servicing is required when the apparatus has been damaged in any way, such as power-supply cord or plug is damaged, liquid has been spilled or objects have fallen into the apparatus, the apparatus has been exposed to rain or moisture, does not operate normally, or has been dropped.
15. Battery usage **CAUTION** – To prevent battery leakage which may result in bodily injury, property damage, or damage to the unit:
 - Install all batteries correctly, + and - as marked on the unit.
 - Do not mix batteries (old and new or carbon and alkaline, etc.).
 - Remove batteries when the unit is not used for a long time.

EL 6475-E004: 02/8

Class II equipment symbol 
This symbol indicates that the unit has a double insulation system

Instruction and General Information

Features	6
Discs for playback	6
Region Codes	
Supplied accessories	6
Environmental information.....	6
Care and safety information	7

Connections

Placing the speakers and subwoofers	7
Connecting speakers and subwoofer	8
Connecting AD905W Wireless System	8
Connecting TV	9~10
Connecting FM/AM antennas	11
Connecting the power cord	11
Connecting a VCR or Cable Satellite Box	12
Connecting digital audio equipment	12
AD905W Wireless System	13

Functional Overview

Front panels	14
Rear panel	15
Remote Control	16

Preparations

Inserting batteries into the remote control.....	17
Switching on the system	17
System Setup (DVD)	18~21
General operation	
Setting the picture	
Setting the sound	
Setting the language	
Setting the features	
Setting the Progressive Scan Mode	

Operations

Discs information	22
Basic playback	22~23
Skipping to another title (track) /chapter	
Fast Search	
Continue playback from the last stop point	
Repeat play	
Repeat A-B	
Program favorite tracks	
Special DVD/VCD features	23 ~25
Changing subtitle language	
Changing sound track language	
Playing in slow motion mode	
Searching for a particular passage	
Display the disc information during playback	
Moving to another title(track)/chapter	
Playback from a selected point	
Zooming in	
Viewing from another angle	
Advancing by frames	
Checking the contents of DVD	
Special VCD/SVCD features	25
Playback Control (PBC)	

MP3/Picture Disc Operations

Playing MP3 / Picture disc	26
(Kodak, JPEG format)	

Other Functions

Tuning to radio stations	27
Presetting radio stations	27
Listening to preset radio stations	27
Sleep timer setting	27

Sound and Volume Controls

Selecting the surround sound mode	28
Selecting the digital sound effect	28
Volume control	29
Dimming the display screen	29

Specifications

Troubleshooting

Instruction and General Information

Features

Your complete 7-piece 300-Watt Ultra Slim DVD Digital Home Cinema System with 6 channels full digital amplifier creates the same dynamic sound qualities that you find in full-fledged cinemas and incorporates some of the best features in home theater technology.

Other features include:

Built-in DTS and Dolby Digital decoder, supporting Dolby Pro Logic, Dolby Pro Logic II and virtual surround

Lets you use the Home Cinema Audio System for a movie-theater surround sound experience.

Additional Component Connections

Lets you connect other audio and audio/visual components to the DVD system so you can use the system's surround sound speakers.

Night Mode

Lets you compress the dynamic range, reducing the difference in loudness between different sounds in Dolby Digital mode.

Parental Control (Rating Level)

Lets you set a ratings level so that your children cannot watch a DVD that has a rating higher than you set.

Sleep Timer

Enables the system to switch to standby mode automatically at a preset time.

Wireless

Enables you to enjoy the Home Cinema Audio System with wireless connection between the system & rear speakers.

Progressive Scan

Provides a flicker free image with the highest effect on film based sources. It can double the vertical resolution of the picture to 525 lines every time the picture is refreshed. **To enjoy the full quality potential offered by progressive scan feature, a progressive scan TV is required.**

Discs for playback

Your DVD home cinema system will play :

- Digital Video Discs (DVDs)
- Video CDs (VCDs)
- Super Video CDs (SVCDs)
- Digital Video Discs + Rewritable (DVD+RW)
- Compact Discs (CDs)
- Picture (Kodak, JPEG) files on CDR (W)
- Supported MP3-CD format.
 - ISO 9660 / UDF format.
 - Maximum 12 characters display
 - Maximum nested directory is 8 levels
 - Maximum album number is 32
 - Maximum title number is 999
 - Supported sampling frequencies: 32 kHz, 44.1 kHz, 48 kHz
 - Supported Bit-rates: 32~256 (kbps). Variable Bit-rates
 - MPEG-1 layer 2 and 3 Audio (MP3)

- Following formats can't be supported
 - The files like *.VMA, *.AAC, *.DLF, *.M3U, *.PLS, *.WAV, *.WMA
 - Non English Album / Title name
 - The discs recorded under Jiolet format MP3 Pro and MP3 with id3 tag



Region Codes

DVDs must be labeled for **ALL** region or for **Region 1** in order to play on this DVD system. You cannot play discs that are labeled for other regions.



Note:

- If you are having trouble playing a certain disc, remove the disc and try a different one. Improper formatted discs will not play on this DVD system.

Supplied Accessories

- a PR PB Y (red/green/blue) cables for connection with your TV
- one audio (white, red) and one composite video (yellow) cable
- a remote control with two AA batteries
- an AM loop antenna and an FM wire antenna
- five satellite speakers and a subwoofer and six speaker cables
- four small speaker stands for the front and rear speakers
- four wall brackets with screws for the front and rear speakers
- this instruction booklet and a Quick Use Guide

AD905W Wireless System:

- one AD905WT wireless transmitter
- one AD905WA wireless receiver
- one 14V adapter
- one table stand for wireless receiver

If any item is damaged or missing, contact your retailer or Philips.

Environmental information

All unnecessary packaging has been omitted. We have tried to make the packaging easy to separate into three materials: cardboard (box), polystyrene foam (buffer) and polyethylene (bags, protective foam sheet).

Your system consists of materials which can be recycled and reused if disassembled by a specialized company. Please observe the local regulations regarding the disposal of packaging materials, exhausted batteries and old equipment.

Care and safety information

Avoid high temperatures, moisture, water and dust.

- Do not expose the system, batteries or discs to humidity, rain, sand or excessive heat (caused by heating equipment or direct sunlight.) Always keep the disc tray closed to avoid dust on the lens.

Avoid condensation problem

- The lens may cloud over when the player is suddenly moved from cold to warm surroundings, making it impossible to play a disc. Leave the player in the warm environment until the moisture evaporates.

Do not block the vents

- Do not operate the DVD system in an enclosed cabinet, allow about 10 cm (4 inches) of free space all around the player for adequate ventilation.

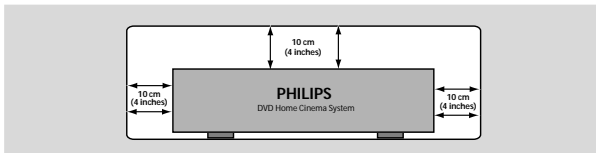

Care of disc

- To clean a CD, wipe it in a straight line from the center towards the edge using a soft, lint-free cloth. A cleaning agent may damage the disc.
- Write only on the printed side of a CDR(W) and only with a soft felt-tipped pen.
- Handle the disc by its edge, do not touch the surface.



Care of cabinet

- Use a soft cloth slightly moistened with a mild detergent solution. Do not use a solution containing alcohol, spirits, ammonia or abrasives.

Finding a suitable location

- Place the player on a flat, hard, and stable surface.

Step 1: Placing the speakers and subwoofers

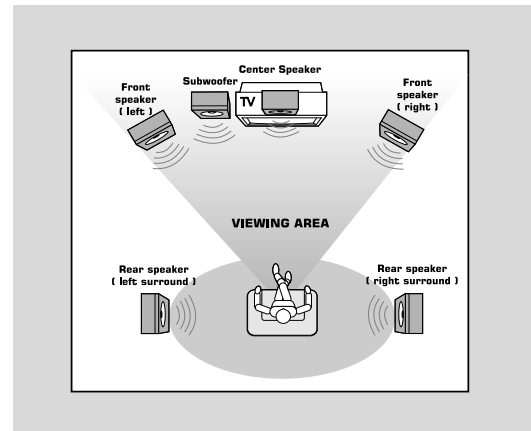

For best possible surround sound, all the speakers (except subwoofer) should be placed at the same distance from the listening position.

- ① Place the front left and right speakers at equal distances from the TV and at an angle of approximately 45 degrees from the listening position.
- ② Place the centre speaker above the TV or the DVD system so the centre channel's sound is localized.
- ③ Place the surround speakers at normal listening ear level facing each other.
- ④ Place the subwoofer on the floor near the TV.

Notes:

- To avoid magnetic interference, do not position the front speakers too close to your TV.
- Allow adequate ventilation around the DVD system.

Step 2: Connecting speakers and subwoofer

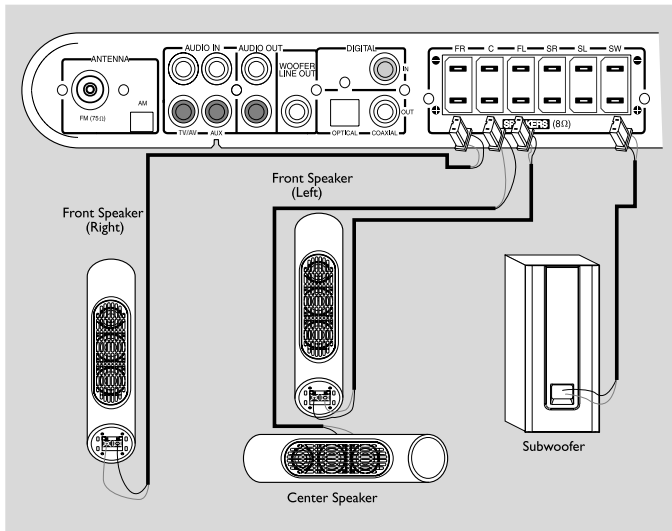

Connect the supplied speaker system using the supplied speaker cables by matching the colours of the jacks and speaker plugs. Fully insert the plugs of speaker wire into the jacks on the DVD system.

Speakers / Subwoofer	⊖	⊕
Front Left (L)	black	white
Front Right (R)	black	red
Center	black	green
Surround (Rear) Left (L)	black	blue
Surround (Rear) Right (R)	black	grey
Subwoofer	black	purple

Notes:

- Ensure that the speaker cables are correctly connected. Improper connections may damage the system due to short-circuit.
- Do not connect more than one speaker to any one pair of +/- speaker jacks.
- Do not connect speakers with an impedance lower than the speakers supplied. Please refer to the SPECIFICATIONS section of this manual.

Step 3: Connecting AD905W Wireless System

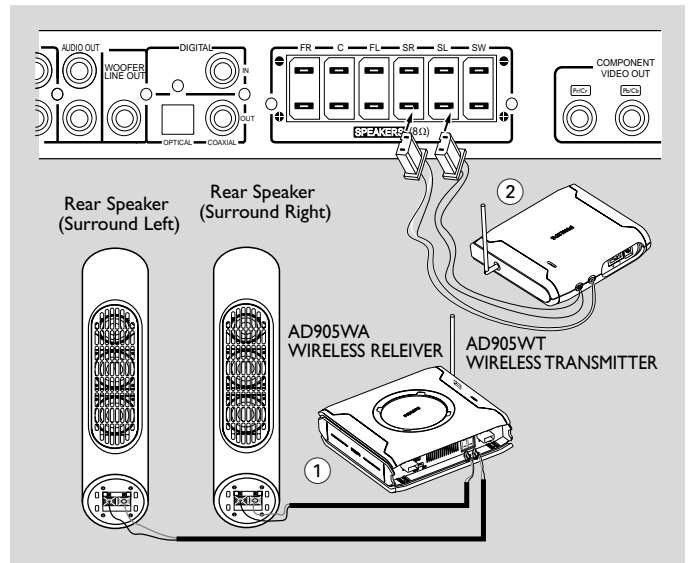

- ① Connect the supplied Surround Speaker system using the supplied speaker cables to the speaker jacks on the **AD905WA WIRELESS RECEIVER** by matching the colours of the jacks and speaker plugs. Extend the RECEIVER antenna.
- ② Connect the **AD905WT WIRELESS TRANSMITTER**'s speaker cables to the speaker jacks on the DVD system. Extend the TRANSMITTER antenna.

Notes

- Adjust the position of the antennas for optimal reception.
- Position the antennas as far as possible from your TV, VCR or other radiation sources to prevent unwanted interference.
- To prevent unwanted noise, do not place the AD905W wireless system too close to the DVD system, AC power adapter, TV or other radiation sources.

Step 4: Connecting TV

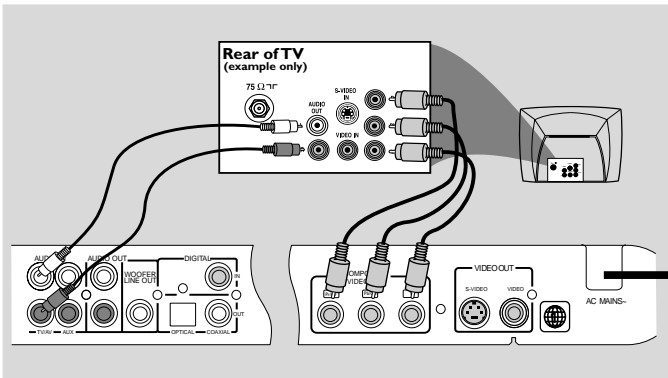

IMPORTANT!

- If both **S-Video** and **Component (Pr Pb Y)** Video connections are used to connect to your TV, the video signal will automatically switch to **Pr Pb Y** when you power up the DVD system. To set the Video Out to **S-VIDEO**, see page 19, System Setup (DVD) - Video Out.

Using Component Video in jack (Pr Pb Y)

- Use the component video cables (red/blue/green) to connect the DVD system's **Pr Pb Y** jacks to the corresponding Component video input jacks (or labeled as Pr/Cr Pb/Cb Y or YUV) on the TV.
- To hear the TV channels through this DVD system, use the audio cables (white/red) to connect TV IN (L/R) jacks to the corresponding AUDIO OUT jacks on the TV. Before starting operation, press TV/AV on the remote to select "TV/AV" in order to activate the input source.
- If you are using a Progressive Scan TV (TV must indicate Progressive Scan or ProScan capability), activate the **Progressive SCAN** function through SYSTEM MENU. See page 21, System Setup (DVD) - Setting the Progressive Scan Mode.
- If your TV does not support Progressive Scan, you will not be able to view the picture. Press the **STOP** button on the main unit for 10 seconds to restore back to normal video output.

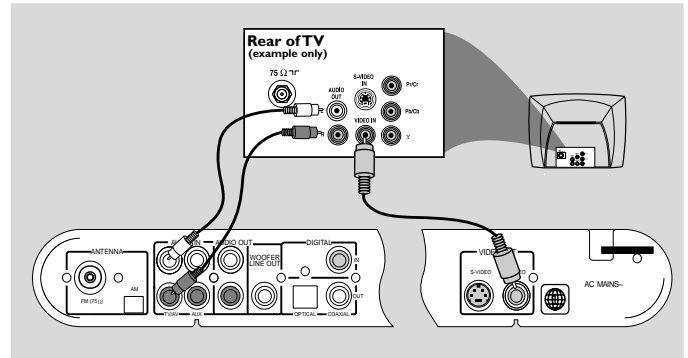

IMPORTANT!

- You only need to make one video connection from the following options, depending on the capabilities of your TV system.
- **S-Video** or **Component Video** connection provides higher picture quality. These options must be available on your TV.
- Connect the DVD system directly to the TV.

Using Video In jack

- Use the composite video cable (yellow) to connect the DVD system's **VIDEO OUT** jack to the video input jack (or labeled as A/V In, Video In, Composite or Baseband) on the TV. Before starting operation, press TV/AV on the remote to select "TV/AV" in order to activate the input source.
- To hear the TV channels through this DVD system, use the audio cables (white/red) to connect TV IN (L/R) jacks to the corresponding AUDIO OUT jacks on the TV. Before starting operation, press TV/AV on the remote to select "TV/AV" in order to activate the input source.
- Deactivate Progressive Scan through System Menu. See page 21, System Setup (DVD) - Setting the Progressive Scan Mode.

Connections

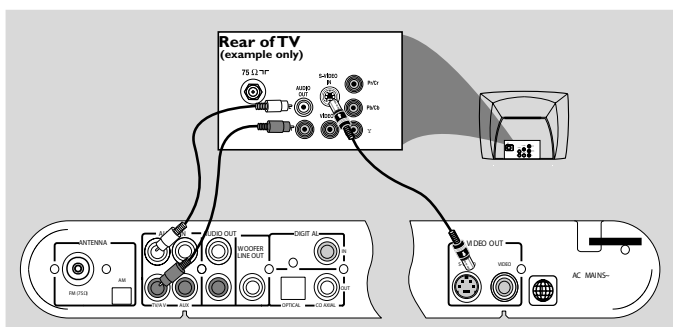

IMPORTANT!

- If the picture is distorted, check the **Video Output setting**. Make sure it is set to '**S-Video**', see page 19, System Setup (DVD) - Video Out.

Using S-Video In jack

- Use the S-video cable (not supplied) to connect the DVD system's **S-VIDEO OUT** jack to the S-Video input jack (or labeled as Y/C or S-VHS) on the TV.
- To hear the TV channels through this DVD system, use the audio cables (white/red) to connect **TV IN (L/R)** jacks to the corresponding **AUDIO OUT** jacks on the TV. Before starting operation, press TV/AV on the remote to select "TV/AV" in order to activate the input source.
- Deactivate Progressive Scan through System Menu. See page 21, System Setup (DVD) - Setting the Progressive Scan Mode.

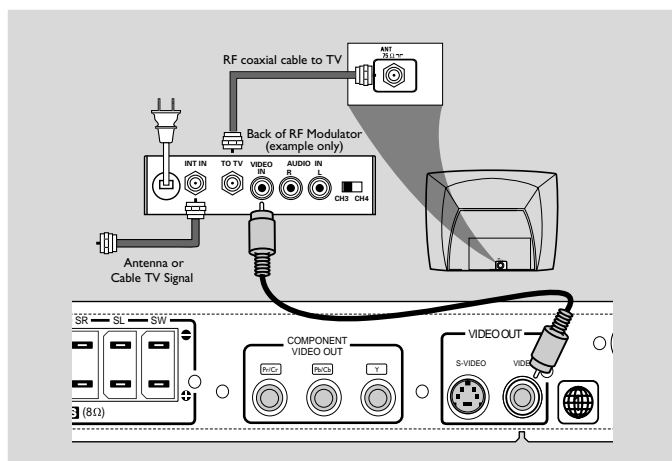

IMPORTANT!

- If your TV only has a single **Antenna In** jack (or labelled as **75 ohm** or **RF In**), you will need an **RF modulator** in order to view the **DVD** playback on the TV. See your electronics retailer or contact **Philips** for details on **RF modulator** availability and operations.

Using an accessory RF modulator

- Use the composite video cable (yellow) to connect the DVD system's **VIDEO OUT** jack to the video input jack on the RF modulator.
- Use the RF coaxial cable (not supplied) to connect the RF modulator to your TV's RF jack.
- Deactivate Progressive Scan through System Menu. See page 21, System Setup (DVD) - Setting the Progressive Scan Mode.

Step 5: Connecting FM/AM antennas

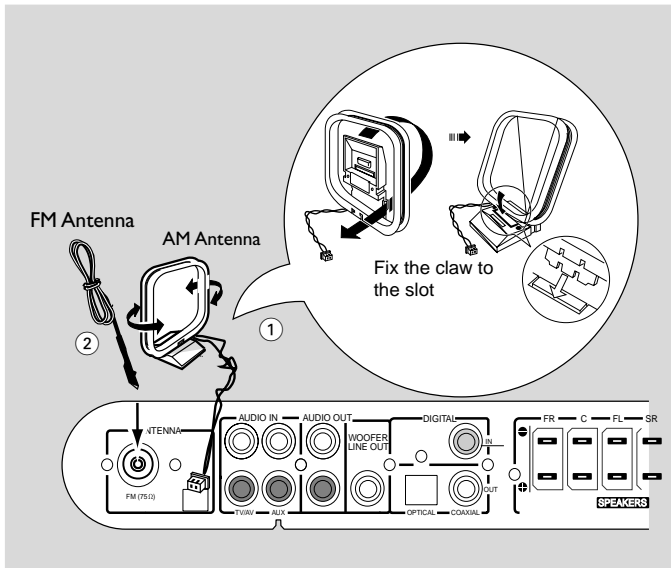

- ① Connect the supplied **AM** loop antenna to the **AM** jack. Place the **AM** loop antenna on a shelf or attach it to a stand or wall.
- ② Connect the supplied **FM** antenna to the **FM** jack. Extend the FM antenna and fix its ends to the wall.

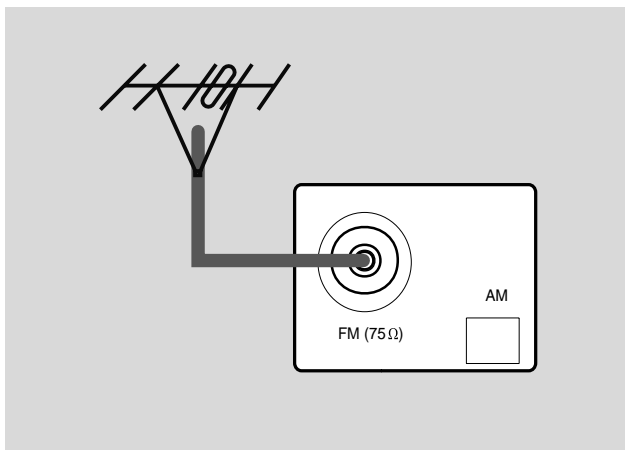

Notes:

- Adjust the position of the antennas for optimal reception.
- Position the antennas as far as possible from your TV, VCR or other radiation sources to prevent unwanted interference.

Step 6: Connecting the power cord

After everything is connected properly, plug in the **AC power cord to the power outlet.**

Never make or change any connections with the power switched on.

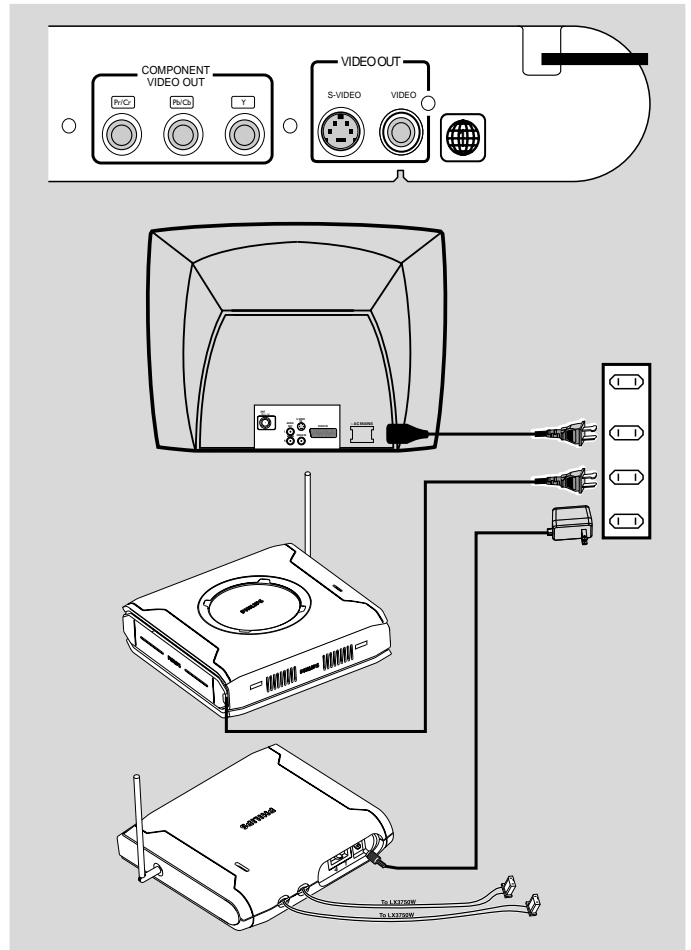

IMPORTANT!

The type plate is located at the bottom of the system.

The apparatus shall not be exposed to dripping or splashing and that no objects filled with liquid such as vases shall be placed on the apparatus.

To avoid overheating of the system, a safety circuit has been built in. Therefore, your system may switch to Standby mode automatically under extreme conditions. If this happens, let the system cool down before reusing it.

Connections

Step 7: Connecting a VCR or Cable /Satellite Box

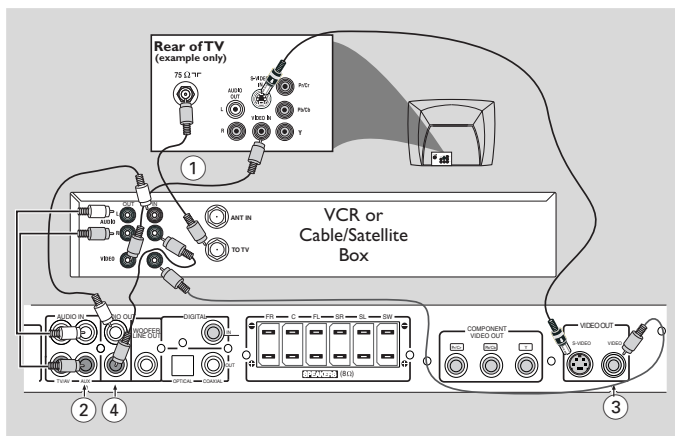

Viewing and listening to the playback

- ① Connect the VCR or Cable/Satellite Box to the TV as shown.
- ② Connect the DVD system's **AUDIO IN-AUX** jacks to the **AUDIO OUT** jacks on the VCR or cable / satellite box.

Before starting operation, press **AUX/DI** on the remote to select "AUX--ANA" in order to activate the input source.

Recording DVDs

Some DVDs are copy-protected. You cannot record or dub protected discs using a VCR.

- ③ Connect the DVD system's **VIDEO** jack to the VIDEO IN jack on the VCR.
- ④ Connect the DVD system's **AUDIO OUT** jacks to the AUDIO IN jacks on the VCR. This will allow you to make analogue stereo (two channel, right and left) recordings.

To view DVD playback while recording. You must connect the DVD system to your TV using the Pr PbY or the S-VIDEO connection.

Step 8: Connecting digital audio equipment

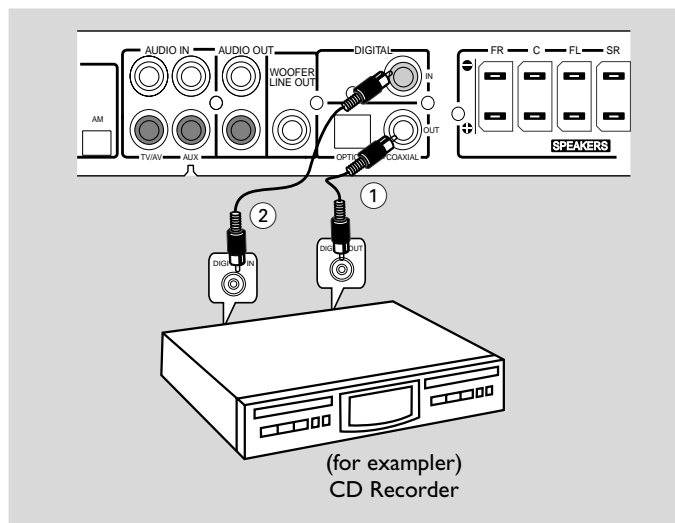

Listening to the playback

- ① Connect the DVD system's **DIGITAL IN** jack to the DIGITAL OUT jack on a digital audio device.

Before starting operation, press **AUX/DI** on the remote to select "AUX--DIG" in order to activate the input source.

Recording (digital)

- ② Connect the DVD system's **DIGITAL OUT (COAXIAL or OPTICAL)** jack to the DIGITAL IN jack on a digital recording device (DTS-Digital Theatre System compatible, with a Dolby Digital decoder, for example).

Before starting operation, set the DIGITAL OUTPUT according to the audio connection. See page 19, Setting the Sound - Digital Output.

Notes:

- Always refer to the owner's manual of the other equipment for complete connection and use details.

AD905W Wireless System

The **AD905W** accessory gives you the option for wireless speaker connection.

Please check you have all the supplied parts for your **AD905W** wireless set:

- 1 x **AD905WT WIRELESS TRANSMITTER**
- 1 x **AD905WA WIRELESS RECEIVER**
- 1 x 14V adapter
- 1 x table stand

- 1 Remove the PHILIPS cover from the **AD905WA WIRELESS RECEIVER** as shown in **Fig. ①**, to access the connection terminal. Connect your rear speaker terminals with the corresponding color terminals on the **AD905WA WIRELESS RECEIVER**
- 2 Insert the table stand into the brackets as shown in **Fig. ②**.
- 3 Connect the **AD905WA WIRELESS RECEIVER** power cord to your power supply.
- 4 Check / adjust the **AD905WA WIRELESS RECEIVER OFF-ON** switch to the **ON** position (see **Fig. ①**).
→ The **AD905WA WIRELESS RECEIVER** power indicator lights up green.
- 5 Connect the 14V power adapter to the **AD905WT WIRELESS TRANSMITTER** and power supply as shown in **Fig. ③**.
- 6 Make sure you position both the **AD905WT WIRELESS TRANSMITTER** and **AD905WA WIRELESS RECEIVER** at least 2 meters apart.
- 7 Connect and carefully match the **AD905WT WIRELESS TRANSMITTER** inputs to the corresponding surround speaker jacks on your **LX3750W** DVD system.
→ The **AD905WT WIRELESS TRANSMITTER** power indicator lights up red.
- 8 Check and adjust the 4-channel toggle switch on the **AD905WT WIRELESS TRANSMITTER** and **AD905WA WIRELESS RECEIVER (CHANNEL SELECTOR)** switch), so that both units are using the same channel.
- 9 On your **LX3750W** DVD system, play an audio source and activate the surround sound mode option. Adjust the volume to reproduce surround sound in the rear speakers.
- 10 Extend the antenna vertically on both the **AD905WT WIRELESS TRANSMITTER** and **AD905WA WIRELESS RECEIVER** to improve reception. Check the antennas are safely positioned without obstruction.

To ensure quality sound production and transmission

- Place both the **AD905WT WIRELESS TRANSMITTER** and

AD905WA WIRELESS RECEIVER off the ground (recommended minimum height of 30cm).

- Avoid placing the **AD905WT WIRELESS TRANSMITTER** too close to your DVD receiver, AC power adapter, TV or other electrical equipment as it may cause electrical interference.
- In case of sound distortion, please select another channel for both the **AD905WA WIRELESS RECEIVER** and **AD905WT WIRELESS TRANSMITTER**. The distortion could be the result of interference caused by other equipment using same frequency channel in your house or neighbourhood.

Notes

- After you switch off your DVD system, the **AD905WT WIRELESS TRANSMITTER** automatically enters standby mode and the red power indicator eventually comes out. On receiving an incoming audio signal from your DVD system again, the **AD905WT WIRELESS TRANSMITTER** automatically powers up.
- When the **AD905WA WIRELESS RECEIVER** enters the Eco-power standby mode, the power indicator lights up red.

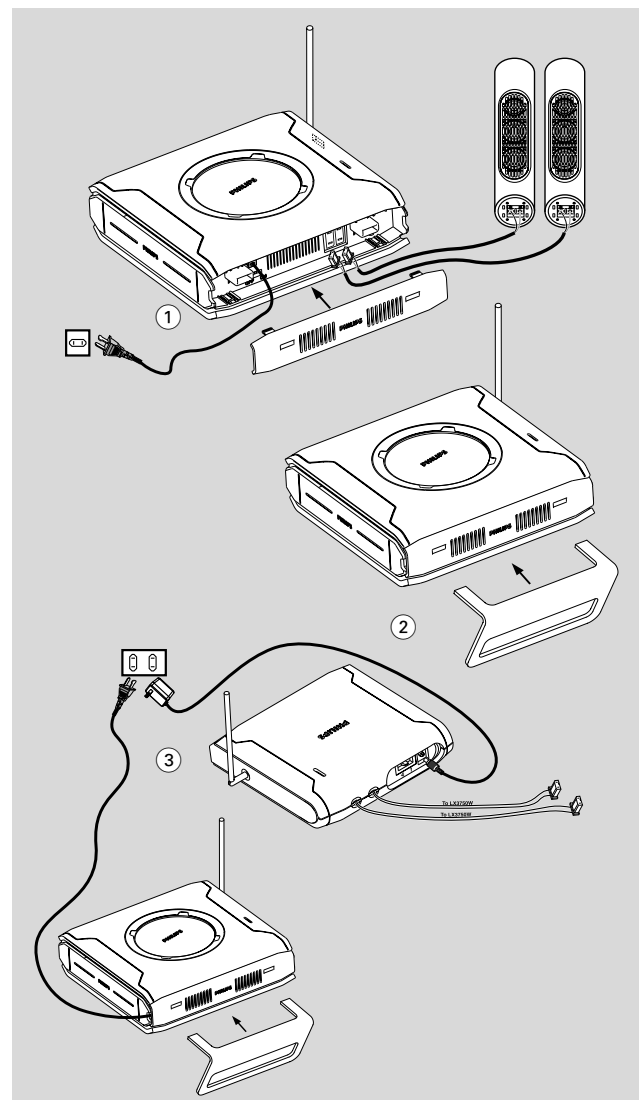

Functional Overview

Front panels

Front view

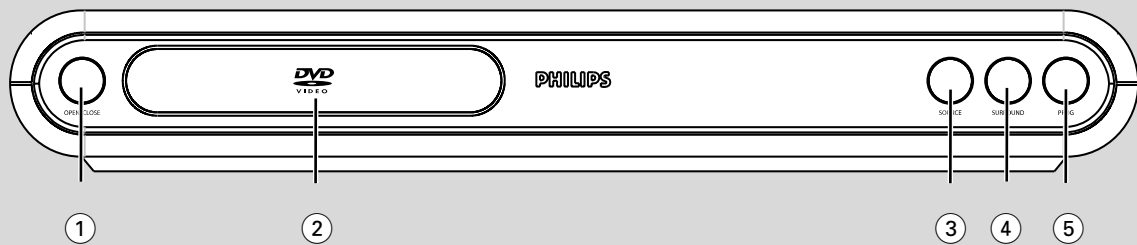

Top view

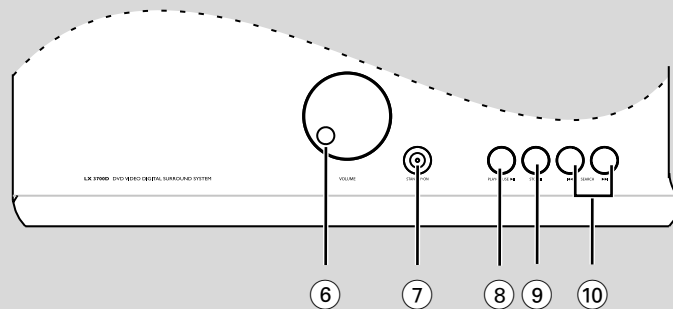

Side view

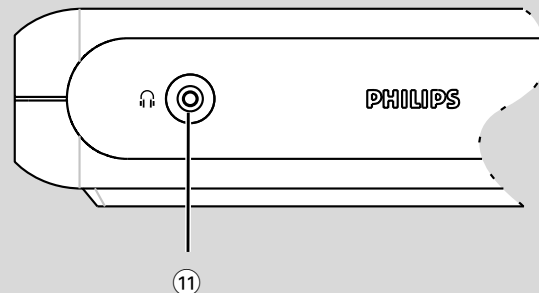

① OPEN / CLOSE

- to open or close the disc tray.

② Disc Tray

③ SOURCE

- to select the relevant active mode: TV/AV, DISC, TUNER or AUX/DI.

④ SURROUND

- to select multichannel surround (Dolby Digital, DTS, VSS Dolby ProLogic or Dolby ProLogic II) or stereo sound effect.

⑤ PROGRAM

- in Disc mode, to program disc tracks.
- in Tuner mode, to program preset radio station.

⑥ VOLUME

- to adjust the master volume.

⑦ STANDBY-ON

- to switch between power on and standby modes.

⑧ PLAY / PAUSE ► II (in Disc mode only)

- to start or interrupt disc playback.

⑨ STOP ■ (in disc mode only)

- to stop playing the disc.

⑩ SEARCH ◀◀ / ▶▶

- in Disc mode, press to skip to the previous/next chapter/track.

- in Disc mode, hold down to fast reverse/forward the disc.

- in Tuner mode, to tune to a lower or higher radio frequency.

⑪

- to connect headphones.

Rear panel

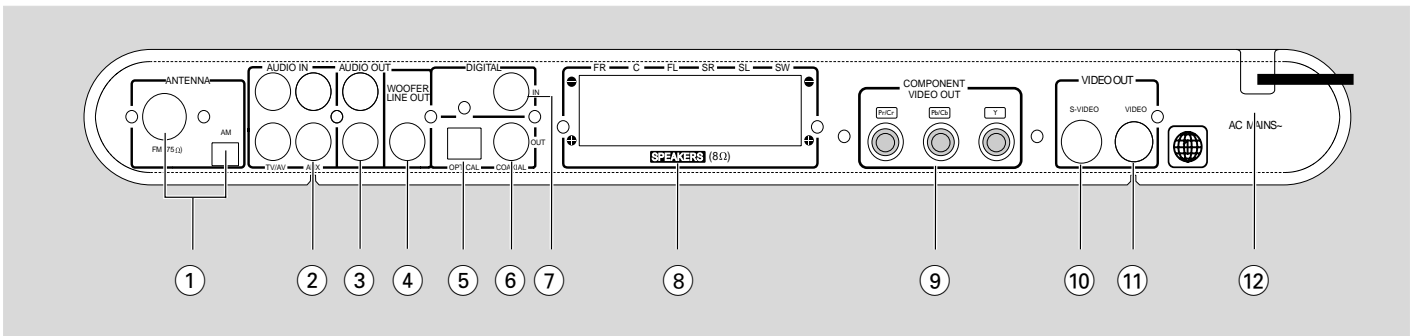

① AM / FM ANTENNA

– connect to the AM loop antenna or FM antenna.

② AUDIO IN -AUX

– connect to the analog audio outputs of a TV or VCR.

③ AUDIO OUT

– connect to the analog audio inputs of an external recording device or amplifier.

④ WOOFER LINE OUT

– connect to an active subwoofer (Optional).

⑤ DIGITAL OUT - OPTICAL

– connect to an audio equipment with digital (optical) audio input.

⑥ DIGITAL OUT - COAXIAL

– connect to an audio equipment with digital (coaxial) audio input.

⑦ DIGITAL IN

– connect from an audio equipment with digital audio output.

⑧ SPEAKERS

– connect to the front, center, rear (surround) and subwoofer speakers.

⑨ COMPONENT VIDEO OUT

– connect to TV with COMPONENT input.

⑩ S-VIDEO OUT

– connect to a TV with S-video input.

⑪ VIDEO OUT

– connect to a TV with video input.

⑫ AC Power Cord

– connect to a standard AC outlet.

Caution: Do not touch the inner pins of the jacks on the rear panel. Electrostatic discharge may cause permanent damage to the unit.

Functional Overview

Remote Control

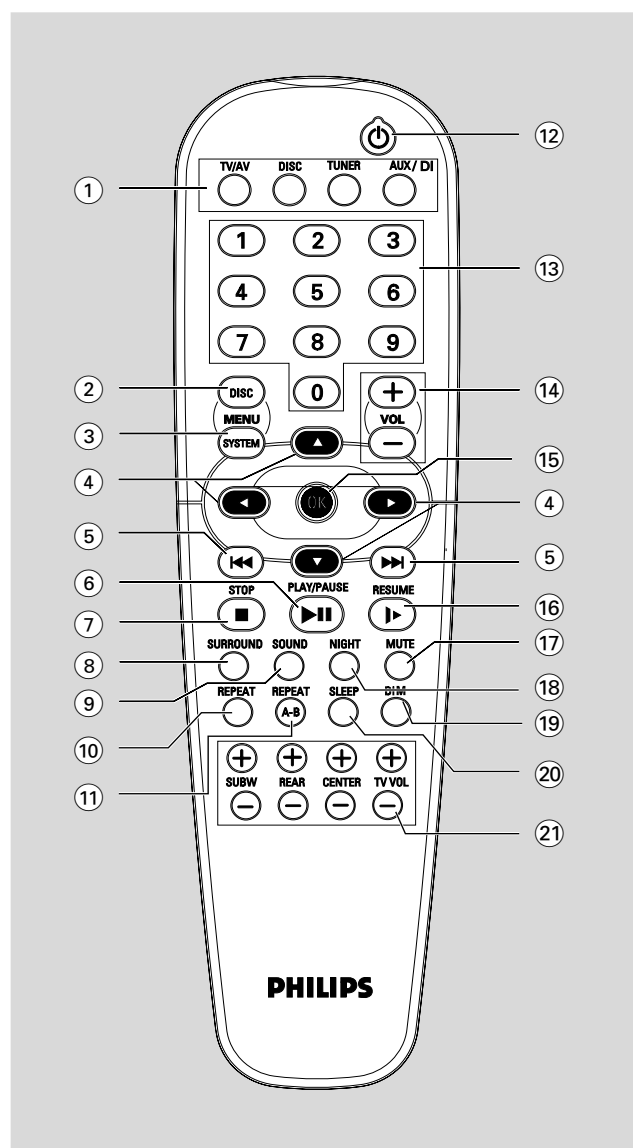

Notes for remote control:

- First, select the source you wish to control by pressing one of the source select keys on the remote control (DISC or TUNER, for example).
- Then select the desired function (▶, ◀◀, ▶▶ for example).

① SOURCE

- to select the relevant active mode: TV/AV, DISC, TUNER or AUX/DI.
- TUNER: toggles between FM and AM band.
- AUX/DI: toggles between AUX-ANA and AUX-DIG (Digital Input) mode.

② DISC MENU (disc mode only)

- to enter or exit the disc contents menu.

③ SYSTEM MENU (disc mode only)

- to enter or exit the system menu bar.

④ ▲ / ▼ / ◀ / ▶

- in Tuner mode, to select a preset radio station number (◀ or ▶).

- to select movement direction in disc contents menu/system menu bar.

⑤ ◀◀ / ▶▶

- in Disc mode, press to skip to the previous/next chapter/track.
- in Disc mode, hold down to fast reverse/forward the disc.
- in Tuner mode, to tune to a lower or higher radio frequency.

⑥ ▶ ||

- to start or interrupt disc playback.

⑦ ■

- to stop playing the disc.

⑧ SURROUND

- to select multichannel surround (Dolby Digital, DTS, VSS, Dolby Pro Logic or Dolby Pro Logic II) or stereo sound effect.

⑨ SOUND

- to select the various sound effect : CONCERT, DRAMA, ACTION, SCI-FI, CLASSIC, JAZZ, ROCK or DIGITAL.

⑩ REPEAT

- to repeat chapter, title, track, album or disc.

⑪ REPEAT A-B

- to repeat a specific section on a disc.

⑫ POWER ⏻

- to switch to standby mode.

⑬ Numeric Keypad (0-9)

- to enter a track/title number of the disc.
- to enter a number of preset radio stations.

⑭ VOL + / -

- to adjust the volume level.

⑮ OK

- to exit or confirm the selection.

⑯ RESUME

- to continue disc playback after an interruption.

⑰ MUTE

- to interrupt or resume sound reproduction.

⑱ NIGHT (Dolby Digital mode only)

- to optimize the dynamic of the sound output.

⑲ DIM

- to select different brightness for the display screen.

⑳ SLEEP

- to set the sleep (auto-off) timer function.

㉑ SUBW + / -

- to adjust the subwoofer's level.

REAR + / -

- to adjust the rear speakers' level.

CENTER + / -

- to adjust the center speaker's level.

TV + / -

- to adjust Philips's television volume level.

Inserting batteries into the remote control

- 1 Open the battery compartment.
- 2 Place the batteries in the compartment with the correct polarity as indicated by " + " and " - " symbols.
- 3 Close the cover.

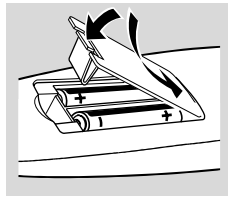

CAUTION!

- Remove batteries if they are exhausted or will not be used for a long time.
- Do not use old and new or different types of batteries in combination.
- Batteries contain chemical substances, so they should be disposed off properly.

Switching on the system

IMPORTANT!

Make sure you have completed all the necessary connections. See page 9~10, Connecting TV.

- 1 Press **STANDBY ON** to switch on the system.
 - 2 Press **SOURCE** until "BISE" appears on the display panel (or press **DISC** on the remote).
 - 3 Turn on the TV and set to the correct video-in channel. You should see the blue Philips DVD background screen on the TV.
 - Usually this channel is between the lowest and highest channels and may be called FRONT, A/V IN, or VIDEO. See your TV manual for more details.
 - Or, you may go to channel 1 on your TV, then press the Channel down button repeatedly until you see the Video In channel.
 - Or, the TV remote control may have a button or switch that chooses different video modes.
 - Or, set the TV to channel 3 or 4 if you are using an RF modulator.
- If you do not get a proper picture or sound, please refer to "System Setup (DVD)" in order to change the pre-settings as necessary to accommodate your TV system or change to your preferred settings.

Preparations

System Setup (DVD)

The system setup is carried out via the TV, it enables you to customize the DVD system to suit your particular requirement. If the preferred options selected are not available on a disc, then the disc's own preference will be used.

IMPORTANT !

To access the System Setup menu, playback must be stopped.

The default setting is underlined.

General operation

- 1 Press **SYSTEM MENU**.
→  icon will be highlighted in the menu bar on the TV screen.
- 2 Press **▼** to activate the System Setup menu.
- 3 Use **◀/▶ ▲/▼** keys to toggle through the functions and select your preferred option.
- 4 Press **OK** to confirm a highlighted selection.
- 5 Press **OK** or **◀ / ▶ /▲/▼** to quit menu to super menu. To exit the System Setup menu, press **SYSTEM MENU** or **OK**.

Setting the picture

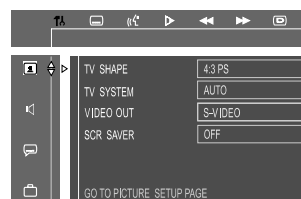

– TV Shape

Select the aspect ratio of the TV to be connected.

4:3 PS (Pan and Scan mode)

– If you have a conventional TV set and your DVD is not formatted for widescreen viewing, use this setting. A wide picture is displayed on the whole TV screen with a portion automatically cut off.

4:3 LB (Letterbox mode)

– If you have a conventional TV set and your DVD is formatted for widescreen viewing, use this setting. A wide picture with bands displayed on the upper and lower portions of the TV screen.

16:9 (Wide screen mode)

– If you have a widescreen TV set, use this setting (you must also set your widescreen TV to "full size") available on a disc, then the disc's own preference will be used.

Notes:

The format you select must be available on the disc. If it is not, the setting for TV Shape will not affect the picture during playback.

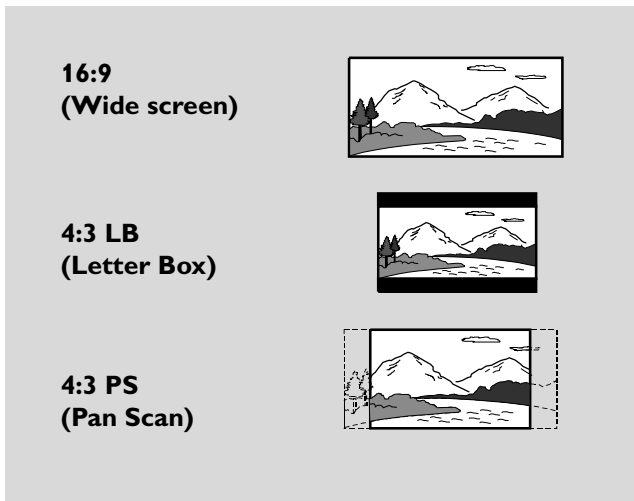

- TV System

Allows you to select the color system matching the connected TV set.

AUTO

- If the connected TV is multi system, select this mode. The output format will be in accordance with the video signal of the disc.

NTSC

- If the connected TV is NTSC system, select this mode. It will change the video signal of a PAL disc and output in NTSC format.

PAL

- If the connected TV is PAL system, select this mode. It will change the video signal of a NTSC disc and output in PAL format.

- Video Out

Video out selection enables you to choose the type of video output suitable for your DVD system.

PR PB Y / SCART (SCART only for Europe version)

- Select **PR PB Y / SCART** if you have connected the video output to your TV using PR PB Y/SCART jack.

S-VIDEO

- Select **S-VIDEO** if you have connected the S-VIDEO output to your TV using S-VIDEO jack.

Note:

- *You do not need to adjust the video output setting if you are using VIDEO jack (yellow) to connect the DVD system to your TV.*

- Screen Saver

If set to ON, when you leave the system in stop or pause mode for more than five minutes, the screen saver will be activated. The default setting is ON.

Setting the sound

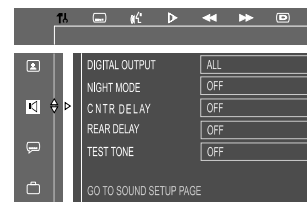

- Digital Output

Digital output selection enables you to specify the type of digital output suitable for your amplifier or receiver.

- Select **ALL** if you have connected the digital output (COAXIAL or OPTICAL) to a multichannel decoder receiver.
- Select **PCM 96K** if the external components is capable of processing digital signal input with sampling rates of 96 kHz.
- Select **PCM 48K** if the external components is incapable of processing 96 kHz digital signal input, then convert to standard signal with sampling rates of 48 kHz.
- Select **OFF** to deactivate the digital output (COAXIAL or OPTICAL).

- Night mode

Set night mode to on to level out the volume. For example, the disc will play at the same sound level throughout the movie. The default setting is OFF.

Night function can also be accessed via the remote control.

Off

Select this when you want to enjoy the surround sound with its full dynamic range.

On

Select this to level out the volume. High volume outputs will be softened and low volume outputs are brought upward to audible level. This feature is only available for movies with Dolby Digital mode.

- Center Delay

If the listening position is closer to the center speaker than the front speakers, you can set the center delay time to improve the surround sound effect.

Options : 5ms, 3ms, 2ms, 1ms or OFF.

- Rear Delay

If the listening position is closer to the rear surround speakers than the front speakers, you can set the rear delay time to improve the surround sound effect.

Options : 15ms, 12ms, 9ms, 6ms, 3ms or OFF.

- Test Tone (DISC mode only)

If set to ON, the system will test the speaker settings. The test signal is generated through the left, center, right, and rear (surround) speakers. The default setting is OFF.

Preparations

Setting the language



- **Audio**
- **Subtitle**
- **Disc Menu**

- This is to select the audio language, subtitle language and the language used on TV screen menus or DVD menus which will always be used for every disc to be played back. The default setting is English.
- If the language selected is not available on the disc, the original language designated by each disc will be selected.

Setting the features

- **Parental**

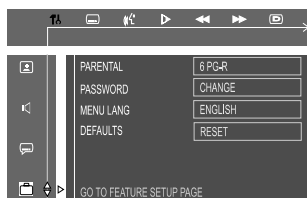

Enables setting of playback limitation level. Some DVDs may have a parental level assigned to the complete disc or to certain scenes on the disc, the rating levels are from 1 to 9 and are country dependent. You can prohibit the playing of certain discs which are not suitable for your children or to have certain discs played with alternative scenes.

The parental default initial setting is 6 PG-R .

- 1 Enter the 4-digit code. If necessary, enter the code a second time.
- 2 Use ▲ / ▼ keys select a rating level.

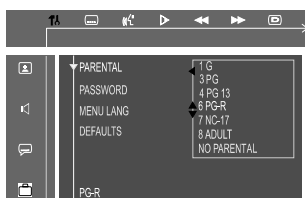

- 3 Press **OK** to confirm.

Rating - NO PARENTAL

Parental control is not activated, it will play all discs.

Rating - 1 to 8

If the player's parental level is set below 8, only discs with a lower or equal level will play. For example, if the player is set to 6, only discs with ratings of 6, 4, 3, and 1 will be played. Higher rated scenes will not be played unless an alternative which has the same rating or lower is available on the disc. For example, consider a disc that generally is suitable for most audiences, and it is rated at level 1 for the most part. However, in the middle, there are also scenes rated at 6 (not suitable for children).

NO PARENTAL – It will play all discs.

8 ADULT – Mature material; should be viewed only by adults due to graphic sexual material, violence, or language.

7 NC-17 – No children under age 17; not recommended viewing for children under age 17.

6 PG-R – Parental Guidance - Restricted; recommended that parents restrict children under 17 from viewing or allow to view only when supervised by a parent or adult guardian.

4 PG13 – Material is unsuitable for children under age 13.

3 PG – Parental Guidance suggested.

1 G – General Audience; recommended as acceptable for viewers of all ages.

To play a higher rated disc or scene than the level set

Enter the 4-digit code before resetting the rating level to a higher number (go to "Password").

If you forget the 4-digit code

- 1 Press **■** four times when forgotten the password and the system will change back to the default password.
- 2 Go to "Password" and enter your new code.

Notes:

– Some DVDs are not encoded with a rating though the movie rating is printed on the disc jacket. The rating level feature does not work for such discs.

- Password

To set a new password for the parental control or to change the password. The password supplied as default is 1234.

- Menu Language

Select the language for on screen display.

- Default

If RESET is selected, all the items in the setup menu will be reset to default setting, except Parental Setting.

Setting the Progressive Scan Mode P

The progressive- scan display present 60 complete frames per second, rather than the 30 frames per second of interlaced scanning (ordinary normal TV system). With nearly double the numbers of line, progressive scan offers higher picture resolution and eliminates bothersome motion artifacts those jagged edges on moving objects.

On

To enjoy the full quality potential offered by progressive scan feature, a progressive scan TV is required.

- Press ▼ to activate the Progressive Scan.
 - Progressive Scan icon will light up.
 - If the TV System is set to PAL, the TV System will automatically set to NTSC.

Off

Select this if a normal conventional TV is connected to your DVD system.

- Press ▼ again to restore to normal TV system.
 - Interlace Scan will appear.

Note:

- *You need to set the video out to Pr/Pb/Y. (See page 19 System Setup (DVD) - video out).*
- *When the surround mode is in Dolby Prologic or Dolby Prologic II (Music / Movie), Progressive Scan function is not available.*
- *If your TV does not support Progressive Scan, you will not be able to view the picture. Press the **STOP** button on the main unit for 10 seconds to restore back to normal video output.*

Operations

Discs information

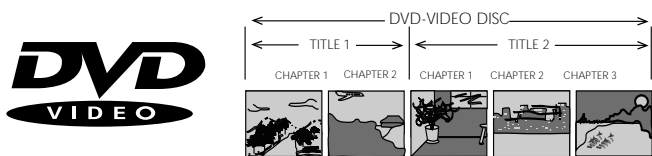

- DVD video discs may have one or more Titles, and each Title may have one or more Chapters.
- Playback stops at the end of each Title.
- Video CDs may have one or more Tracks, and each Track may have one or more Indexes.
- To make easy and convenient access, you can move between Tracks and Indexes.
- Some Video CDs have Play Back Control (PBC), which is a predefined playback sequence stored on the disc (refer to "Special VCD/SVCD features").
- Audio CDs contain only Tracks.

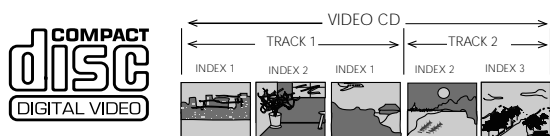

Basic playback

IMPORTANT!

- Do not move the DVD system during playback, doing so may damage the DVD system.
- Do not push on the disc tray or put any objects other than disc on the disc tray, doing so may cause the DVD system malfunction.
- DVD discs and players are designed with regional restrictions. Before playing a disc, make sure the disc is the same zone as your player.
- Depending on the DVD or VIDEO CD, some operations may be different or restricted.

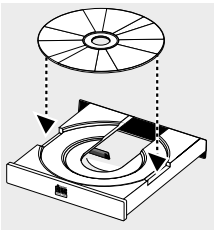
- 1 Press **STANDBY ON**  to switch on the system.
 - 2 Press **OPEN/CLOSE** to open the disc tray.
 - 3 Load a disc with the label side facing up.
 - 4 Press **OPEN/CLOSE** again to close the tray.
 - There will be a short delay while the player identifies the disc and reads the menu from the disc.
- 
- Some discs will start playing automatically, others will display the Disc Contents Menu on the TV screen. If the menu is presented, use **▲ / ▼ / ◀ / ▶** keys to highlight your selection and press **OK** to confirm. To select a play option, press **numeric keypad (0-9)**.
- 5 Press **▶||** to start playback.

Notes:

-  If the inhibit icon (or X) appears on the TV screen when a button is pressed, it means the function is not available on the disc you are playing.

To interrupt playback

- Press **▶||**.
 - The picture freezes and the sound will be muted.
- To resume playback, press **▶||** again.

To stop playback

- Press **■**.

Skipping to another title (track) / chapter

- Press **◀◀** or **▶▶** repeatedly during playback to skip backward or forward. Each press will take the disc to the beginning of the previous or next title (track) / chapter.

Note:

- If the **REPEAT - TRACK** function has been set, pressing **◀◀** or **▶▶** will replay the same title (track) / chapter.

To skip to the beginning of the current title (track) / chapter during playback

- Press **◀◀** once.

To go directly to any title (track) / chapter

- Use the **numeric keypad (0-9)** to enter the number of the desired title (track) / chapter.

Fast Search

- 1 Hold down **◀◀** or **▶▶** for about more than 1 seconds to fast reverse or forward the disc.
- 2 To resume normal play, press **▶||**.

Continue playback from the last stop point

- In stop mode and when a disc has not been removed, press **RESUME** to resume playback from the point at which it stopped.

To cancel the resume mode

- Press **■** again.

Notes:

- When the player is disconnected from the power supply or the disc tray is opened, the resume option will be cancelled automatically.
- When **PBC** is **ON** resume mode is not available.
- The resume mode may not be available on some disc.

Repeat play

You can only select the repeat play mode during playback.

For DVD - Repeat chapter / title

- Press **REPEAT** repeatedly to select the following:
REPEAT CHAPTER → REPEAT TITLE → REPEAT OFF.

For CVD/SVCD/VCD/CD - Repeat track / disc

- Press **REPEAT** repeatedly to select the following:
REPEAT TRACK → REPEAT DISC → REPEAT OFF.
- If VCD or CD has been programmed press this key repeatedly to select the following:
REPEAT TRACK → REPEAT PROGRAM → REPEAT OFF.

For MP3 Repeat - track / album / disc

MENU ON:

- Press **REPEAT** repeatedly to select the following:
REPEAT TRACK → REPEAT ALBUM → REPEAT DISC → REPEAT OFF.

MENU OFF:

- Press **REPEAT** repeatedly to select the following:
REPEAT TRACK → REPEAT DISC → REPEAT OFF.

Notes:

- Repeat play might not work correctly with some DVDs.
- For CVD, SVCD and VCD 2.0 discs, the repeat function is useless unless the PBC function is set to OFF.

Repeat A-B

You can play a specific section in a chapter/track repeatedly.

- 1 Press **REPEAT A-B** at your chosen starting point.
- 2 Press **REPEAT A-B** again at your chosen end point.
→ The passage will now repeat continuously.
- 3 To resume normal play, press **REPEAT A-B** again.

Note:

- The section A and B can be set only within the same chapter/track.
- The Repeat A-B may not be available on some disc.

Program favorite tracks

You can play the contents of the disc in the order you want by programming the order of the tracks to be played. Up to 99 tracks can be stored.

- 1 While playback is stopped, select or press **PROGRAM** to enter program mode.
→ "P 00:00" is displayed.
- 2 Use the **numeric keypad (0-9)** to input the track number in the order you want.
→ If you attempt to program more than 99 tracks, "FULL" is displayed.
- 3 Press **OK** to store the track.
- Repeat **steps 2-3** to store other tracks.
- 4 To start program play, press **▶||**.
- 5 To stop playback, press **■** once.

- 6 To cancel the program, press **■** again.

Note:

- The Program mode may not be available on some disc.

Use the menu bar to program

IMPORTANT!

You have to turn on your TV and set to the correct Video In channel. See page 17, Switching on the system.

- 1 Stop playback, then press **SYSTEM MENU**. The menu bar will appear across the top of the TV screen.
- 2 Use **◀** or **▶** and select  and press **▼** to enter the program menu.
- 3 Repeat **steps 2-6** listed above to program your favorite tracks.

Special DVD/VCD features

A number of operations can be carried out directly via the multiple menu bars on the TV screen without interrupting disc playback.

- 1 Press **SYSTEM MENU**.
→ The menu bar will be displayed across the top of the TV screen.
- 2 Press **◀** or **▶** to move through the menu bar to select:
SETUP MENU → SUBTITLE → AUDIO LANGUAGE → SLOW → FAST REVERSE → FAST FORWARD → STATUS SEARCH → TITLE SEARCH → CHAPTER SEARCH → TIME SEARCH → ZOOM → ANGLE → STEP → PBC ON/OFF → PROGRAM → INTERLACE/PROGRESSIVE.
- 3 Press **▼** to select the highlighted icon and use **▲▼** keys to select your preferred option.
- 4 Press **OK** to confirm a highlighted selection.
- 5 To exit, press **SYSTEM MENU** or **OK**.

IMPORTANT!

Some operations may be different or restricted, it depends on the disc format. Refer to the jacket or case of the disc you are playing.

Changing subtitle language

This operation works only DVDs with multiple subtitle languages.

- Select  from the menu bar and use **▼** key to select the desired language.

Operations

Changing sound track language

This operation works only on DVDs with multiple soundtrack language.

- Select  from the menu bar and use **▼** key to select the desired language.

For VCD ,CVD,SVCD:

- Press **▼** to select the desired audio channels for sound, it is only available for disc with different channels recorded :
LEFT VOCAL → RIGHT VOCAL → MONO LEFT → MONO RIGHT → STEREO

Note:

– When the desired language is not selected even after pressing the button several times, it means the language is not available on the disc.

Playing in slow motion mode

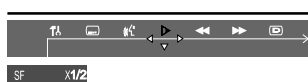

For DVD :

- 1 Select  from the menu bar and use **▼** key to select the required slow motion speed :
SF X 1/2 → SF X 1/4 → SF X 1/8 → SR X 1/2 → SR X 1/4 → SR X 1/8 → PLAY
SF = slow forward
SR = slow reverse

For CVD , SVCD or VCD:



- 1 Press **▼** key to select the required slow motion speed :
(forward): SF X 1/1 → SF X 1/2 → SF X 1/3 → PLAY
- 2 To resume normal play, press **▶||**

Note:

– The sound will be muted during slow-motion play .
– This function is not available for MP3 and CD.

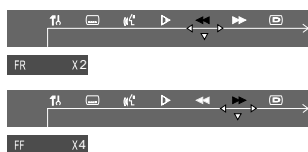
Searching for a particular passage



- 1 Select  or  from the menu bar to select fast reverse search or fast forward search respectively.
- 2 Use **▼** key to select the required search speed :

For DVD or MP3 :

(reverse): FR X 2 → FR X 4 → FR X 6 → FR X 8 → PLAY
(forward): FF X 2 → FF X 4 → FF X 6 → FF X 8 → PLAY

For VCD , CVD, SVCD, or CD:

Press **▼** key to select the required search speed :
(reverse): FR X 1 → FR X 2 → FR X 3 → FR X 4 → PLAY
(forward): FF X 1 → FF X 2 → FF X 3 → FF X 4 → PLAY

- 3 To resume normal play, press **▶||**

Display the disc information during playback

- Select  from the menu bar and press **▼** key to select the following display informations :



Moving to another title (track) /chapter

Some discs may contain more than one title or chapter. If the disc has a title or chapter menu recorded on it, you can start playback from the selected item.

- 1 Select **T** (title) or **C** (chapter) from the menu bar.
- 2 Use **numeric keypad (0-9)** to select a desired title/ chapter number.
- 3 press **OK** to start playback.

Note:

– Selecting a title or chapter might not be possible on certain discs.

Playback from a selected point

This function allows you to start playing at any chosen time on the disc.



- 1 Select  from the menu bar.
- 2 Enter hours, minutes and seconds from left to right in the time edit box using the **numeric keypad (0-9)**.
→ Each time an item has been entered, the next item will be highlighted.
- 3 Press **▶||** to start playback.

Note:

– This function is not available for MP3.
– This function is not available during repeat function.

Zooming in

This function allows you to enlarge the picture on the TV screen and to pan through the enlarged image.



- 1 Select  from the menu bar and press **▼** key repeatedly to select the zoom factor :
ZOOM x 1.5 → ZOOM x2 → ZOOM x4 → ZOOM OFF
- 2 To pan through the enlarged image, press **SYSTEM MENU** to exit and use **◀/▶/▲/▼** keys to move the zoomed picture left, right, up and down.
- 3 To exit **ZOOM** mode, select zoom factor to "ZOOM OFF" from the menu bar.

Viewing from another angle

If the disc contains sequences recorded from different camera angles, this allows you to view the picture from different angles. The selections of angle are depending on the disc format.

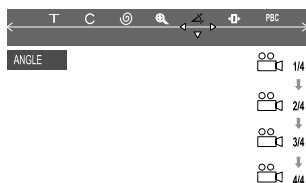

- Select  from the menu bar and press **▲/▼** keys to select the desired angle : 1/4, 2/4, 3/4 or 4/4.
→ Playback changes to the selected angle.

Advancing by frames



- 1 Select  from the menu bar and press **▼** key to play the disc step by step (one frame each step).
- 2 To resume normal play, press **▶||**

Checking the contents of DVD

- 1 Press **DISC MENU** on the remote control.
→ If the current title has a menu, the menu will appear on the screen. Otherwise, the disc menu will be displayed.
- 2 Use **◀/▶/▲/▼** keys to select the desired title or chapter, followed by **▶||** or **OK**.
→ The selected title or chapter starts playing.

Notes:

- The details of operation might differ depending on the DVD disc.
- Selecting a title or disc might not be possible on certain DVD disc.

Special VCD/SVCD features

Playback Control (PBC)

PBC playback allows you to play Video CD interactively, following the menu on the display.

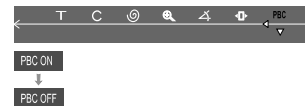

- Select **PBC** in the menu bar and press **▼** key to select PBC ON or PBC OFF.

When playing a disc with PBC function

- If PBC OFF, the system will start playback automatically.
- If PBC ON, the PBC menu (if available) will appear on the TV screen for selection. Use the **numeric keypad (0-9)** to enter your choice.

Note:

- If PBC mode is switched on, **TIME SEARCH** and **REPEAT** functions are not available.

MP3 / Picture Disc Operations

Playing MP3 / Picture disc (Kodak, JPEG)

IMPORTANT!

You have to turn on your TV and set to the correct Video In channel. See page 17, Switching on the system.

- ① Load a MP3/Picture (Kodak, JPEG) disc.
 - The disc reading time may exceed 30 seconds due to complexity of the directory/file configuration.
- ② Playback will start automatically.
 - For picture disc, you can see the still pictures one after another automatically in the slide-show playback.
 - For MP3 disc, a list of albums/titles menu will appear on the TV.

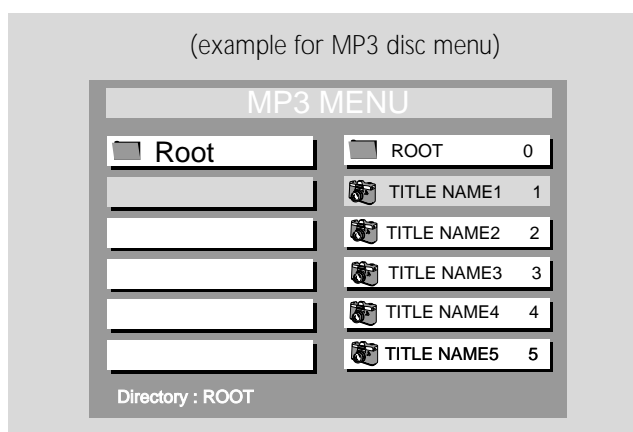

During playback, you can;

- Press |◀◀ / ▶▶| to select another title / picture in the current folder.
 - Press **REPEAT** to select available repeat mode.
 - Use ◀ / ▶ / ▲ / ▼ on the remote to rotate the picture files.
 - Press ▶|| to pause/resume playback.
- ③ To stop playback, press ■.
 - For picture disc, 9 thumbnail pictures or a list of file names will appear on the TV.

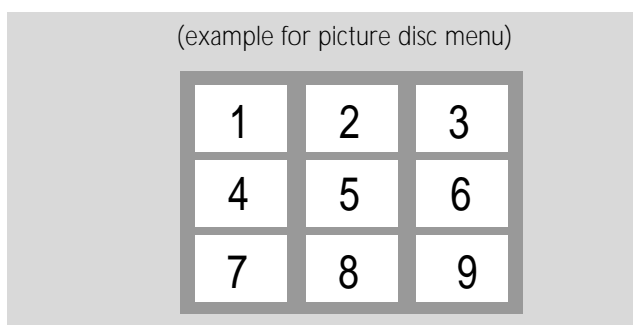

In stop mode, you can;

- Use ◀ / ▶ / ▲ / ▼ on the remote to move within the MP3 menu and press **OK** to select the desired file to play.
 - In picture menu, you can use |◀◀ or ▶▶| in the menu to view the previous/next page (if available).
 - You can set the transition effects for each picture. Twelve slide-show transition modes are provided as below.
 - Mode 0 :no special transition effect (by default)
 - Mode 1 :wipe from top to bottom
 - Mode 2 :wipe from bottom to top
 - Mode 3 :wipe from top / bottom to center
 - Mode 4 :wipe from center to top / bottom
 - Mode 5 :vertical blind
 - Mode 6 :wipe from left to right
 - Mode 7 :wipe from right to left
 - Mode 8 :wipe from left / right to center
 - Mode 9 :wipe from center to left / right
 - Mode 10:wipe from edge to center
 - Mode 11:horizontal blinds
 - Mode 12:random
- You only need to use the **RESUME** key to select.

Notes:

- Due to the recording nature of Digital Audio MP3 (DAM), only digital audio music will play.
- It is normal to experience an occasional "skip" while listening to your MP3 discs.
- Some files on Kodak or JPEG disc may be played back distortedly.
- The disc reading time may exceed 10 seconds due to the large number of songs compiled onto one disc.
- Playback of multi-session disc is supported for the first 10 sessions with the same format.
- For multi-session discs with different formats, only the first session will be available.

Tuning to radio stations

- 1 Press **STANDBY ON** to switch on the last selected source.
- 2 Press **SOURCE** (or press **TUNER**) to select TUNER mode.
- 3 Press **TUNER** again to select the desired band : FM or AM.
- 4 Press and hold **◀◀** or **▶▶** until the frequency indication starts to change, then release.
→ The system automatically tunes to the next strong radio station.

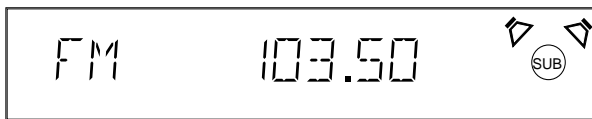

- To tune to a weak station, press **◀◀** or **▶▶** briefly and repeatedly until an optimal reception found.
- 5 Repeat **step 4** if necessary until you find the desired radio station.

Presetting radio stations

You can preset up to 40 stations regardless of the reception.

- 1 Tune to your desired radio station (refer to "Tuning to radio stations").
- 2 Press **PROGRAM**.
→ "PROGRAM" appears.

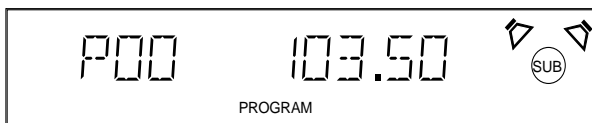

- 3 Use the **numeric keypad (0-9)** to select the desired preset number.

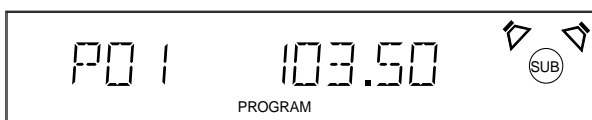

Note:

– If "PROGRAM" icon goes off before you select the desired preset number, press PROGRAM again.

- 4 Press **PROGRAM** again to store the radio station.
→ "PROGRAM" icon stops flashing.
- Repeat **steps 1–4** to store other radio stations.

Notes:

– The old stored content in the selected address will be covered when you operates the unit as above.
– During programming, if no key is pressed within five seconds, the system will exit the program mode automatically.

Listening to preset radio stations

- In tuner mode, press **◀** or **▶** or use the **numeric keypad (0-9)** to select the desired preset number.
→ The preset number, radio frequency, and waveband are displayed.

Sleep timer setting

The sleep timer enables the system to switch to standby mode automatically at a preset time.

- 1 Press **SLEEP** repeatedly to select a preset time.
→ The selections are as follows (time in minutes):
15 → 30 → 45 → 60 → 90 → 120 → OFF → 15...

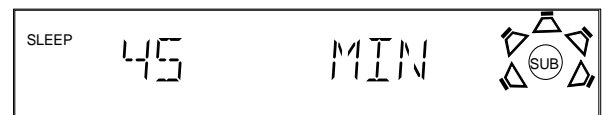

- 2 When you reach the desired length of time, stop pressing the **SLEEP** button.
→ "SLEEP" icon appears.

To check the remaining length of time after sleep timer is activated

- Press **SLEEP** once.

To change the preset sleep timer

- Press **SLEEP** again while the remaining sleep timer is shown.
→ The display will show the next sleep timer options.

To deactivate the sleep timer

- Press **SLEEP** repeatedly until "OFF" is displayed, or press the **STANDBY ON** button.

Sound and Volume Controls

Selecting the surround sound mode

IMPORTANT!

- For proper surround sound, make sure you have followed the “Connections” and “Preparations” procedures fully.
- The center and surround speakers only operate when the system is set to surround sound mode and the source material being played is recorded or broadcast in Dolby Digital Surround, DTS, Dolby Pro Logic or ProLogic II surround sound.
- Stereo broadcasts or recordings will produce some surround channel effects when played in a surround mode. However, monaural sources will not produce any sound from the surround speaker.

- Press **SURROUND** to select surround or stereo mode.
 - The availability of the various surround sound modes depend on the number of speakers used and the incoming sound information available on the disc. The available surround modes are shown below.

Dolby Digital Surround

Dolby Digital (also known as AC-3 or Dolby 5.1) and MPEG Multichannel delivered a realistic and dynamic sound similar to theater and cinema. It requires connection of all five speakers (front left/right, centre, surround left/right) and subwoofer for correct Dolby Digital Surround sound reproduction. Each channel plays its own unique role in providing the right sound. Front left, center and front right join two surround speakers to reproduce high, mid and bass frequencies in five full-range channels of surround. Bass rumble, explosions and low frequency effects you feel are delivered through the subwoofer. A large number of DVD discs are recorded in Dolby Digital Surround.

DTS Surround

The DTS Surround is a cinema surround sound format that offers superior digital audio performance. DTS offers more clarity and definition especially for higher tones. The better sound quality is a result of the limited sound compression (3:1 instead of 11:1 for Dolby Digital) and the 20-bit resolution.

Dolby Pro Logic Surround

The Dolby Pro Logic Surround system is a specially encoded two channels analog format that will produce sound through four speaker channels (front left, center, front right, monaural surround) when a Dolby Pro Logic Decoder is used. It is also compatible with stereo systems but the user will only have two channels (Front Left & Right) of sound.

Dolby Pro Logic II Surround

Dolby Pro Logic II Surround creates five full bandwidth output channels from two-channel sources. This is done using an advanced, high purity matrix surround decoder that extracts the spatial properties of the original recording without adding any new sounds or tonal colorations.

● **Movie mode**

The movie mode is for use with stereo television shows. The result is enhanced soundfield directionality that approaches the quality of discrete 5.1-channel sound.

● **Music mode**

The Music mode is for use with any stereo music recordings, and provides a wide and deep sound space.

VSS (Virtual Surround Sound)

The ProLogic MPEG or Dolby Digital surround channel is processed by a 'virtualizer' DSP to add surround effect from just the two front speakers.

Stereo

All sound is reproduced and played through the front left and right speakers. This enables standard stereo reproduction.

Selecting the digital sound effect

The digital sound effects allows you to select from various pre-set modes that control the frequency bands of sound to optimize certain musical styles. It greatly enhances the excitement and enjoyment of your favorite music.

- Press **SOUND** repeatedly to select the available sound effect.

When playing a DVD/VCD, select :

- CONCERT, DRAMA, ACTION, SCI-FI

When playing a CD/MP3 or in Tuner or AUX-ANA mode, select:

- JAZZ, ROCK, DIGITAL, CLASSIC

When DIGITAL IN received DTS or Dolby DIGITAL format, select:

- CONCERT, DRAMA, SCI-FI, ACTION

If received other signal format, select:

- JAZZ, ROCK, DIGITAL, CLASSIC

Volume Control

Changing the volume level

- Adjust **VOLUME** button (or press **VOL +/-**) to increase or decrease the volume level.
 - "VOL xx" is displayed.
 - "VOL MAX" is displayed if volume is at maximum level.
 - Press **SUBW +/-** to adjust the level of the subwoofer speaker volume.
 - "SUBW xx dB" is displayed.
 - The range is from -15dB to 10dB.
 - Press **REAR +/-** to adjust the level of the surround speakers volume.
 - "REAR xx dB" is displayed.
 - The range is from -15dB to 10dB.
 - Press **CENTER +/-** to adjust the level of the center speakers volume.
 - "CNT xx dB" is displayed.
 - The range is from -15dB to 10dB.
- For PHILIPSTVs only:**
- Press **TVVOL +/-** on the remote control to adjust the TV's volume level.

Notes

- "xx" denotes the volume level.
- When **SURROUND** mode is set to **Stereo** or **VSS** mode, **REAR +/-** and **CENTER +/-** keys are void.
- In **test tone** mode, volume control is void.

To switch off the volume temporarily

- Press **MUTE**.
 - "MUTE ON" is displayed.
- Press **MUTE** again or increase the volume level.

Note

When **MUTE** is activated **ON**, all sound on the rear jacks (**AUDIO OUT**, **DIGITAL OUT**) will remain on.

To listen through the headphones

Connecting headphones to  will switch off the speakers. The DVD system switches to **STEREO** and surround sound will be reduced to a stereo signal which is reproducible by standard headphones.

Disconnecting the headphones switches on the speakers again. If you wish to enjoy surround sound again, switch the DVD system back to surround sound.

Dimming the display screen

- Press **DIM** repeatedly to select different levels of brightness for the display screen : **HIGH**, **MID** or **LOW**.

Specifications

AMPLIFIER SECTION

Output power	
Stereo mode (DIN)	2 x 50 W RMS / 2 x 40 W FTC ^①
Surround mode (1 kHz)	50 RMS / channel
Total Harmonic Distortion	10% at rated power (kHz)
Frequency Response	180 Hz - 14 kHz / ±1 dB
Signal-to-Noise Ratio	> 65dB (CCIR)
Input Sensitivity	400 mV

^① 80hm, 180Hz ~ 12.5KHz, 10% THD

TUNER SECTION

Tuning Range	FM 87.5 – 108 MHz (100 kHz steps) AM 530 – 1700 kHz (10 kHz steps)
26 dB Quieting Sensitivity	FM 20 dB
26 dB Quieting Sensitivity	AM 5000 µV/m
Image Rejection Ratio	FM 25dB AM 28 dB
IF Rejection Ratio	FM 60 dB AM 24 dB
Signal-to-Noise Ratio	FM 55 dB AM 35 dB
AM Suppression Ratio	FM 30 dB
Harmonic Distortion	FM Mono 3 % FM Stereo 3 % AM 5 %
Frequency Response	FM180 Hz – 10 kHz / ±6 dB
Stereo Separation	FM 26 dB (1 kHz)
Stereo Threshold	FM 23.5 dB

DVD SECTION

Laser Type	Semiconductor
Disc Diameter	12cm / 8cm
Video Decoding	MPEG-2
Video DAC	10 Bits
Signal System	PAL / NTSC
Video Format	4:3 / 16:9
Video S/N	56 dB (minimum)
Composite Video Output	1.0 Vp-p, 75 Ω
S-Video Output	Y - 1.0 Vp-p, 75 Ω C - 0.286 Vp-p, 75 Ω
Audio DAC	Direct Digital Amplification
Frequency Response	4 Hz – 20 kHz (44.1 kHz) 4 Hz – 22 kHz (48 kHz) 4 Hz – 44 kHz (96 kHz)
Digital Output	SPDIF Coaxial & Optical

MISCELLANEOUS

Power Supply Rating	120V ~ 60Hz
Power Consumption	160W
Dimensions (w x h x d)	390 mm x 55 mm x 399 mm
Weight	4.4 kg
ECO Standby Power	<1 W

IR REMOTE CONTROL

Effective Range	> 8 Meter
Number of Keys	45
Battery (1.5V)	AA x 2

SPEAKERS

Front Speakers

System	2-way shielded
Impedance	8 Ω
Speaker drivers	2 x 2" woofer, 1.75" tw
Dimensions (w x h x d)	88 mm x 293 mm x 88 mm
Weight	0.61 kg

Center Speaker

System	2-way shielded
Impedance	8 Ω
Speaker drivers	2 x 2" woofer, 1.75" tw
Dimensions (w x h x d)	280mm x 79 mm x 72 mm
Weight	0.733 kg

Surround Speakers

System	2-way shielded
Impedance	8 Ω
Speaker drivers	2 x 2" woofer, 1.75" tw
Dimensions (w x h x d)	88 mm x 293 mm x 88 mm
Weight	0.61 kg

SUBWOOFER

Subwoofer (not magnetically shielded design)	6.5"
Input power	50W (8 Ω, DIN)
Dimensions (w x h x d)	140 mm x 328 mm x 376 mm
Weight	5.016 kg

AD905W Wireless System

Power supply rating	120V ~ 60Hz
Transmission frequency	864 MHz
Dimensions (w x h x d)	
AD905WT	131 mm x 34 mm x 130 mm
AD905WA	207 mm x 55 mm x 186 mm
Weight	1.7 kg

Specifications subject to change without prior notice

Philips Industrial Activities nv declares that the LX3750W DVD HOME CINEMA SYSTEMs are in conformity with the essential requirements and other relevant standards of the directive 1999/5/EG.

WARNING!

Under no circumstances should you try to repair the system yourself, as this will invalidate the warranty. Do not open the system as there is a risk of electric shock.

If a fault occurs, first check the points listed below before taking the system for repair. If you are unable to solve a problem by following these hints, consult your dealer or service center.

Problem	Solution
No power.	<ul style="list-style-type: none"> - Check if the AC power cord is properly connected.
No picture.	<ul style="list-style-type: none"> - Select the appropriate video input mode on the TV. - Check if the TV is switched on. - Check the video connection. - Check the system is securely connected.
Distorted or poor picture.	<ul style="list-style-type: none"> - Sometimes a small amount of picture distortion may appear. This is not a malfunction. - Clean the disc. - Connect the system to TV's S-video input.
The aspect ratio of the screen cannot be changed even though you have set the TV shape.	<ul style="list-style-type: none"> - The aspect ratio is fixed on the DVD disc. - Depending on the TV, it may not allow to change the aspect ratio.
No sound or distorted sound.	<ul style="list-style-type: none"> - Adjust the volume. - Check that the speakers are connected correctly. - Replace the speaker cables. - Check the speaker settings. - The system is in pause, slow motion or fast forward/reverse mode, press PLAY to resume normal play mode.
No sound is heard from the center or rear speakers.	<ul style="list-style-type: none"> - Use the CENTER + / - or REAR + / - to adjust the volume level. - Check that the center or rear surround speakers is connected correctly. - Use surround mode.
The DVD player does not start playback.	<ul style="list-style-type: none"> - Insert a readable disc. - Check the disc type, color system and region code. - Clean the disc. - Place the disc with the playback side down. - Press SYSTEM MENU to turn off the setup menu screen. - Cancel the parental control rating function or change the rating level. - Moisture has condensed inside the system. Remove the disc and leave the system turned on for about an hour.
The DVD system does not respond when the buttons are pressed.	<ul style="list-style-type: none"> - Disconnect the power plug from the outlet, and insert again.
The language for the sound or subtitle cannot be changed when playing a DVD.	<ul style="list-style-type: none"> - Multi-language sound or subtitle is not recorded on the DVD. - Changing the language for the sound or subtitle is prohibited on the DVD.
No image is output when a function is selected.	<ul style="list-style-type: none"> - Make sure the component is connected correctly. - Press the correct function button for the input source.
Considerable noise in radio broadcasts.	<ul style="list-style-type: none"> - Tune in the correct frequency. - Connect the antenna. - Route RF (AC-3) and digital cables away from the antenna terminals and wires. - Fully extend the FM wire antenna. Position for best reception and secure to a wall. - Connect an outdoor FM antenna. - Adjust the direction and position for best reception. - Connect an additional or external AM antenna. - Turn off the equipment causing the noise or move it away from the DVD system. - Place the antenna farther away from the equipment causing the noise.
The remote control does not function.	<ul style="list-style-type: none"> - Point the remote control at the remote sensor of the unit. - Reduce the distance to the player. - Remove any possible obstacles. - Replace the batteries with new ones. - Check that the batteries are loaded correctly.
The display is dark.	<ul style="list-style-type: none"> - Press DIM again.
Low hum or buzz sound.	<ul style="list-style-type: none"> - Place the DVD system as far away as possible from electric devices with interference.
Low bass response.	<ul style="list-style-type: none"> - Check all speakers for correct polarity.

LIMITED WARRANTY

AUDIO SYSTEM

One Year Free Labor

One Year Free Service on Parts

This product must be carried in for repair.

WHO IS COVERED?

You must have proof of purchase to receive warranty service. A sales receipt or other document showing that you purchased the product is considered proof of purchase.

WHAT IS COVERED?

Warranty coverage begins the day you buy your product. For one year thereafter, all parts will be repaired or replaced, and labor is free. After one year from the day of purchase, you pay for the replacement or repair of all parts, and for all labor charges. All parts, including repaired and replaced parts, are covered only for the original warranty period. When the warranty on the product expires, the warranty on all replaced and repaired parts also expires.

WHAT IS EXCLUDED?

Your warranty does not cover:

- labor charges for installation or setup of the product, adjustment of customer controls on the product, and installation or repair of antenna systems outside of the product.
- product repair and/or part replacement because of misuse, accident, unauthorized repair or other cause not within the control of Philips.
- reception problems caused by signal conditions or cable or antenna systems outside the unit.
- a product that requires modification or adaptation to enable it to operate in any country other than the country for which it was designed, manufactured, approved and/or authorized, or repair of products damaged by these modifications.
- incidental or consequential damages resulting from the product. (Some states do not allow the exclusion of incidental or consequential damages, so the above exclusion may not apply to you. This includes, but is not limited to, prerecorded material, whether copyrighted or not copyrighted.)
- a product that is used for commercial or institutional purposes.

WHERE IS SERVICE AVAILABLE?

Warranty service is available in all countries where the product is officially distributed by Philips. In countries where Philips does not distribute the product, the local Philips service organization will attempt to provide service (although there may be a delay if the appropriate spare parts and technical manual(s) are not readily available).

MAKE SURE YOU KEEP...

Please keep your sales receipt or other document showing proof of purchase. Attach it to this owner's manual and keep both nearby. Also keep the original box and packing material in case you need to return your product.

BEFORE REQUESTING SERVICE...

Please check your owner's manual for assistance. If you have additional questions, call us at 1-800-531-0039.

TO GET WARRANTY SERVICE IN U.S.A., PUERTO RICO, OR U.S. VIRGIN ISLANDS...

Take the product to a Philips factory service center (see enclosed list) or authorized service center for repair. When the product has been repaired, you must pick up the unit at the center. Centers may keep defective parts. (In U.S.A., Puerto Rico, and U.S. Virgin Islands, all implied warranties, including implied warranties of merchantability and fitness for a particular purpose, are limited in duration to the duration of this express warranty. But, because some states do not allow limitations on how long an implied warranty may last, this limitation may not apply to you.)

TO GET WARRANTY SERVICE IN CANADA...

Please contact Philips at:

1-800-661-6162 (French Speaking)
1-800-531-0039 (English or Spanish Speaking)

(In Canada, this warranty is given in lieu of all other warranties. No other warranties are expressed or implied, including any implied warranties of merchantability or fitness for a particular purpose. Philips is not liable under any circumstances for any direct, indirect, special, incidental or consequential damages, howsoever incurred, even if notified of the possibility of such damages.)

REMEMBER...

Please record below the model and serial numbers found on the product. Also, please fill out and mail your warranty registration card promptly. It will be easier for us to notify you if necessary.

MODEL # _____

SERIAL # _____

This warranty gives you specific legal rights. You may have other rights which vary from state/province to state/province.

Philips, P.O. Box 520890, Miami, FL 33152, USA, (402) 536-4171

EL4965E007 / 8-02

English

Français

Español

Meet Philips at the Internet

<http://www.philips.com>

PHILIPS CONSUMER ELECTRONICS NORTH AMERICA

Knoxville, Tennessee 37914-1810, USA

LX3750W

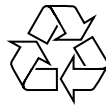

SC/JW 418.10

Free Manuals Download Website

<http://myh66.com>

<http://usermanuals.us>

<http://www.somanuals.com>

<http://www.4manuals.cc>

<http://www.manual-lib.com>

<http://www.404manual.com>

<http://www.luxmanual.com>

<http://aubethermostatmanual.com>

Golf course search by state

<http://golfingnear.com>

Email search by domain

<http://emailbydomain.com>

Auto manuals search

<http://auto.somanuals.com>

TV manuals search

<http://tv.somanuals.com>