



www.philips.com/support

For support call 0870 900 9070

EN Digital Terrestrial Receiver





PHILIPS

Table of contents

1	Important	4	7.1	Connecting a DVD player / external recorder	40
2	Your Digital Terrestrial Receiver	6	7.2	Connecting your audio equipment	40
2.1	What's in the box?	6	7.3	Universal remote control	41
2.2	What you also need (not supplied)	7	8	Guarantee and service	47
2.3	Digital Terrestrial Receiver overview	7	9	Technical data	47
2.4	Main menu overview	8	10	Frequently asked questions	49
2.5	How to read this manual	8	11	Glossary	51
3	Getting started	9	12	Index	53
3.1	Prepare	9	13	Remote control brand code list	54
3.2	Connect	10	13.1	Setup Code For All TVs	54
3.3	Install	10	13.2	Setup Code For All VCRs	55
3.4	RETUNE procedure:	11	13.3	Setup Code for All Digital Video Disks	56
4	Using your Digital Terrestrial Receiver	13	13.4	Setup Code for All Audio AMP/Tuners	57
4.1	Watching live TV	13	13.5	Setup Code for All Audio Amplifiers (A)	58
4.2	Controlling Live TV	16	Contact information	59	
4.3	Recording	18	Trademarks and partner logos	59	
4.4	HDD library	21			
4.5	Play files from an USB device	21			
5	Use more of your Digital Terrestrial Receiver	22			
5.1	Digital Terrestrial Receiver full overview	22			
5.2	Digital Terrestrial Receiver display full overview	23			
5.3	Remote control full overview	25			
5.4	Menu full overview	26			
5.5	TV guide	26			
5.6	Channel manager	30			
5.7	HDD Library	32			
5.8	USB	32			
5.9	Settings	33			
6	Maintenance	39			
6.1	Cleaning	39			
6.2	Replacement	39			
6.3	Disposal	39			
7	Accessories and connections	40			

1 Important

Take time to read this User Manual before using the Digital Terrestrial Receiver.
It contains important information and notes regarding how to operate it.

	<p>Disposal of your old product Your product is designed and manufactured with high quality materials and components, which can be recycled and reused. When this crossed-out wheeled bin symbol is attached to a product or its packaging, it means the product is covered by European Directive 2002/96/EC. Please inform yourself about the local separate collection process for electrical and electronic products. Please act according to your local rules and do not dispose of your old products with your normal household waste. The correct disposal of your old product will help prevent potential negative consequences for the environment and human health.</p>
	<p>The “Material recyclability symbol” affixed on package cardboard and user manual means these parts are recyclable. So do not dispose of them with your normal household waste.</p>
	<p>The “Material recyclability symbol” affixed on plastic packaging parts means these parts are recyclable. So do not dispose of them with your normal household waste.</p>
	<p>The “Green Dot” affixed on cardboard means PHILIPS pays a financial duty to the “Avoidance and Recovery of Packaging Waste” organization.</p>

Your receiver is powered using an AC power cord. The Digital Terrestrial Receiver has been manufactured to meet the appropriate safety standards, but the instructions below must be followed to operate it safely. These instructions must be kept for future reference.

Danger

- The Digital Terrestrial Receiver does not contain any user-serviceable parts. Do not attempt to open them. All maintenance work must be carried out by qualified services centres.
- The supplied mains plug may be a non-rewireable type or a rewireable type. Both types contain an approved 3A fuse. If you need to replace the fuse, use an ASTA- or BSI-approved BS 1362 fuse, rated at 3A and marked with either of these symbols.
- Non-rewireable plugs have the fuse beneath a fuse cover on the plug face. Use a screwdriver to lever off the fuse cover, replace the fuse with a new one and refit its cover. Never use a plug if its fuse cover is missing.
- Rewireable plugs have the fuse inside. Use a screwdriver to remove the plug's back cover, then lever out the fuse and replace it with a new one. Replace the plug's back cover. If the supplied mains plug is not suitable for your mains socket-outlet, remove its fuse and then cut the plug off the lead. Destroy the severed plug immediately to avoid the shock hazard which would exist if this were to be plugged into a mains socket. Do not attempt to repair or modify the mains lead or plug. Fit an appropriate mains plug on the lead. If this plug contains a fuse, it should be as described above. If you are using a non-fused plug, an external fuse must not exceed 5A.
- Make sure that children do not place any foreign objects in any of the openings.

Warnings

- Before connecting the AC power cord to the mains, check that the mains supply voltage corresponds to the voltage printed on it. If the mains voltage is different, consult your dealer.
- The AC power cord has been designed for indoor use only.
- It is recommended to unplug the AC power cord from the mains during lightning storms.
- Periodically inspect the AC power cord for damage. Do not use if damage is found. Always refer to qualified services centres.
- To prevent fire or shock hazard, do not expose the Digital Terrestrial Receiver to rain or moisture.
- The Digital Terrestrial Receiver should be placed on a firm surface, and the ventilation openings must not be covered with items, such as newspapers, table clothes, curtains, etc.
- Do not install the Digital Terrestrial Receiver near heat sources such as radiators, stoves or other apparatus that produce heat. Protect it from direct sunlight.
- When installing the Digital Terrestrial Receiver, ensure there is a gap of approximately 5 cm around the Digital Terrestrial Receiver to enable air to circulate freely and prevent overheating.
- Leave accessible the AC power cord in case emergency shutdown is required.
- Do not place any combustible objects on the Digital Terrestrial Receiver (candles, etc.).
- No objects filled with liquids, such as vases, shall be placed on the unit. The Digital Terrestrial Receiver shall not be exposed to dripping or splashing. Should this happen, disconnect the AC power cord from the mains and consult qualified services centres.
- Do not move the product or turn the power off suddenly while the hard disk drive is running. The company shall not be liable for any corruption of data on the hard disk drive caused by the carelessness or misuse of users.

Refer also to the cautions throughout this manual.

2 Your Digital Terrestrial Receiver

Congratulations on your purchase and welcome to Philips!

To fully benefit from the support that Philips offers, register your product at www.philips.com/welcome.

With this Digital Terrestrial Receiver, you never need to schedule your life around your favourite TV programmes. Thanks to the built in hard disk drive (HDD) that records programmes as you watch them, you can pause live TV, or repeat a scene you missed. Want to record a programme so that you can watch it later? Just press the record button.

Once you begin to record, you are free to watch other recorded programmes. You can even watch the programme that you are recording from the start without disruption to the recording, or record two channels at the same time.

Need to schedule a recording in advance? Simply access the Electronic programme guide, which lists the TV programme schedule for the next eight days.

And you can do much more than just record on this recorder

2.1 What's in the box?



Digital Terrestrial Receiver



Remote control and 2 batteries



SCART cable



AC Power cord



Quick Start Guide

! Caution

Plastic bags can be dangerous.

To avoid suffocation keep the bag away from babies and children.

2.2 What you also need (not supplied)



RF Cable



TV Set

2.3 Digital Terrestrial Receiver overview



Front Panel

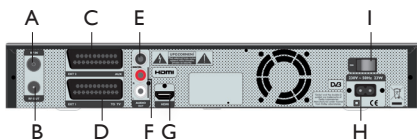

Rear Panel

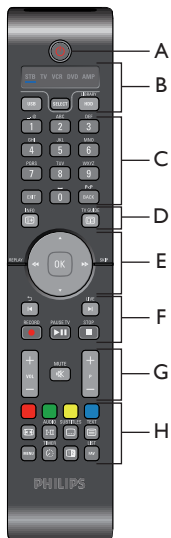

Remote control unit

Front Panel

- A Standby
- B Programme -
- C Programme +
- D Record
- E Display
- F Front panel door

Rear Panel

- A RF IN*
- B RF OUT*
- C AUX scart*
- D TV scart*
- E SPDIF audio out (digital)*
- F L/R audio out* (analogue)
- G HDMI*
- H Power**
- I ON/OFF Switch**

* Safety extra low voltage

** Hazardous voltage

Remote control unit

- A Standby
- B Source selection
- C Alphanumeric keypad, Exit, Back
- D Programme information
- E Up/Down
Left/Right
OK keys
- F Recorder functions
- G Volume control
Programme+/Programme-
- H System keys Menu Fav list,

2.4 Main menu overview

- 1 Press **MENU** on the remote control to access the main menu.



- 2 Use the **▲ / ▼ / ◀▶** arrow keys to navigate through the different options. The visible option is automatically validated. Use also these keys to navigate through different level of menus.
- 3 Press **OK** to validate your choice in a list of items.

Note

For more information, see chapter *5.4 Menu full overview*.

2.5 How to read this manual

Danger

Describes situations in injury or loss of life.

Warning

Describes actions that may cause damage to the product.

Caution

Describes the actions required to avoid dangerous or illegal situations.

Note

Additional information.

Tip

Information that is useful to know but not essential to the task. For example, information about alternative use.

3 Getting started

The basic steps to get you started are described in this chapter.

3.1 Prepare

Prepare the remote control

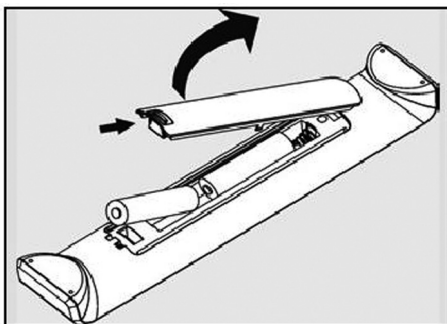

- 1 Open the battery compartment.
- 2 Insert the two batteries supplied according to the indications (+/-) inside the compartment.
- 3 Close the battery compartment.

Note

Point the remote control directly at the remote sensor on the front panel and select the desired function.

Caution

Do not mix batteries or keep them in the remote control for long periods of time without use. Batteries must not be disposed of with your household waste but to a local separate battery collection system. Do not dispose of batteries in a fire.

Prepare the smart card

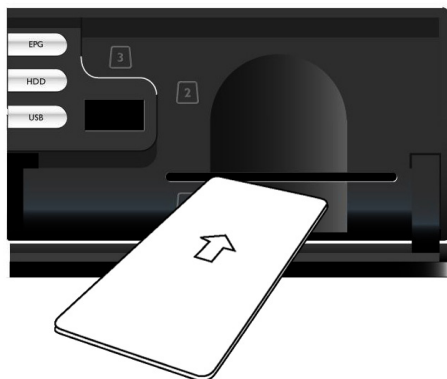

To be able to receive scrambled digital channels from pay-TV providers, you need a smart card (not supplied) from the provider broadcasting those channels.

Warning

Insert the smart card with the chip facing down.

Notes

- You can access the information stored on the smart card by selecting **MENU**, and then the **Menu/Settings/Smart Card** submenu.
- For more information about smart cards or operators, consult your installer or dealer.

3.2 Connect

Danger

Risk of electric shock!

Make sure all the devices are disconnected from the mains before making any connections.

SCART connection

Use this connection if your TV set is not fitted with a HDMI input.

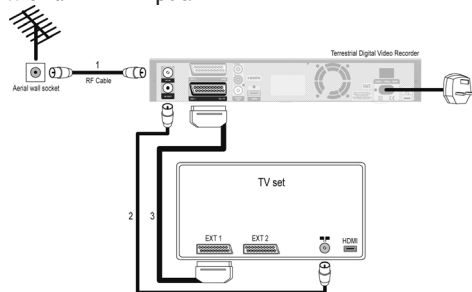

- 1 Connect the aerial cable from the wall socket to the **RF IN** socket at the rear of the Digital Terrestrial Receiver.
- 2 Connect the **RF OUT** socket at the rear of the Digital Terrestrial Receiver to the RF input of your TV set using a RF cable.
- 3 Connect the supplied scart cable to the scart input of the TV set and to the **TV** scart socket at the rear of the Digital Terrestrial Receiver.
- 4 Plug your TV set to the mains. Do not plug your Digital Terrestrial Receiver yet!

Note

The fan extracts hot air from the device: Check that there is enough place and fresh air around the device to avoid overheating.

HDMI connection

Use this connection if your TV set is fitted with a HDMI input.

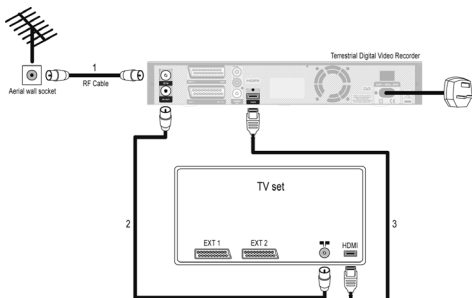

- 1 Connect the aerial cable from the wall socket to the **RF IN** socket at the rear of the Digital Terrestrial Receiver.
- 2 Connect the **RF OUT** socket at the rear of the Digital Terrestrial Receiver to the RF input of your TV set using a RF cable.
- 3 Connect a HDMI cable to the HDMI input of the TV set and HDMI socket at the rear of the Digital Terrestrial Receiver.
- 4 Plug your TV set to the mains. Do not plug your Digital Terrestrial Receiver yet!

Note

The HDMI cable is not supplied

3.3 Install

Before you start installation, make sure you have made all the required connections.

- 1 Switch on your TV set and select the correct source (refer to the user manual of your TV set).

Note

The display format being managed by the Digital Terrestrial Receiver, set your TV to “full screen” or to the similar equivalent setting.

- 2 Plug the power cord into the mains and set the switch at the rear of the Digital Terrestrial Receiver to position **ON**.

3 The **TV shape** screen appears.

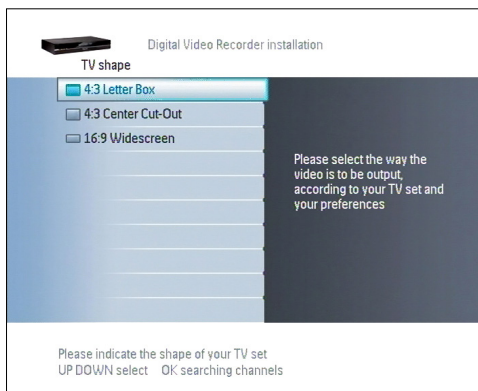

- 4 Depending on your TV set, select the appropriate TV shape setting using the ▲ / ▼ arrow keys of the remote control.

Note

For more information about TV shapes, see chapter Settings.

- 5 Press **OK**. The **Channel search** screen appears.

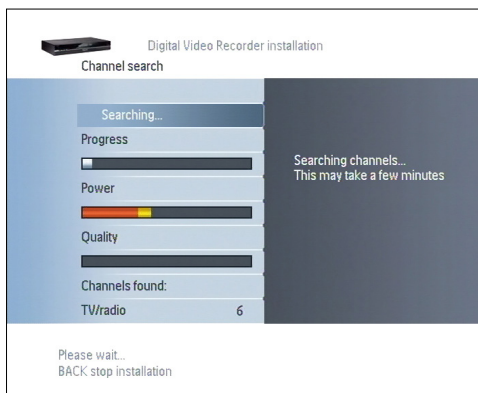

Search failure

In case of channel search failure, a black screen with a No signal message is displayed.

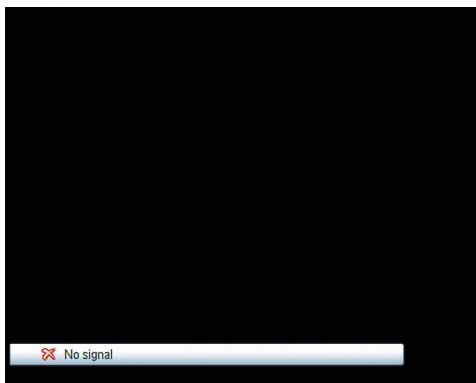

Before starting a new search, check the RF cable connection to your Digital Terrestrial Receiver as described in chapter 3.2 *Connect*.

Once you have checked all those points, apply the Retune procedure:

3.4 RETUNE procedure:

- 1 Press **MENU** on the remote control to access the main menu.



- 2 Use the ▲ / ▼ arrow keys to highlight **Settings**.
- 3 Press **OK**.

- 4 Use the ▲ / ▼ arrow keys to highlight **Installation**.

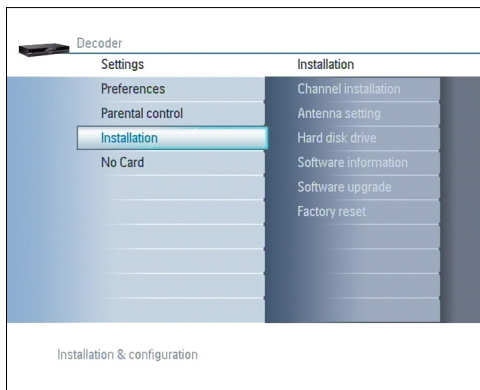

- 5 Press **OK**.
6 Use the ▲ / ▼ arrow keys to highlight **Full installation**.

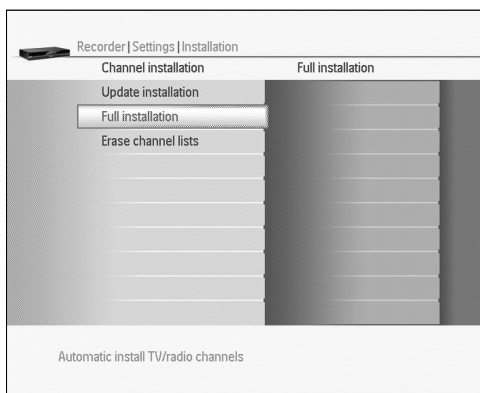

- 7 Press **OK**.
8 On screen Scan mode selection, select **Scan type fast**.

Note

If the number of TV/Radio stays at 0 value, refer to chapter 10 *Frequently asked questions*. You could try again from this step, choosing Scan type **automatic**, or **advanced** but it could take more than 30 minutes. If the problem remains, contact your dealer.

Screen Scan mode selection:

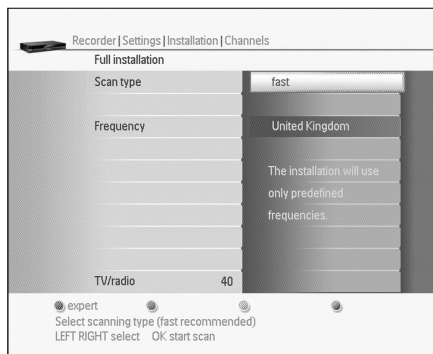

- 9 Press **OK**.
The scan process displays channels found with signal level and quality of all sources analysed

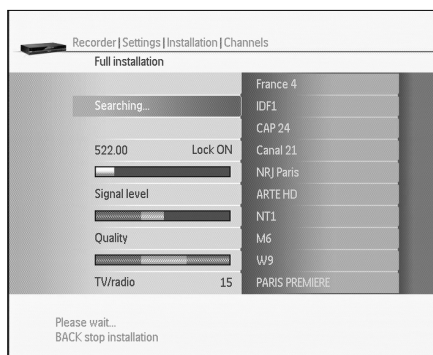

Note

If signal level stays low and red, during the full scan operation, check the cables. If Power seems ok but Quality indicator stays low and red, check the availability of digital signals in your area. If you are supposed to have access to digital signal, check your aerial installation.

If some local variant exist, these extra channels will start with number 800.

- 10 When the scan is finished, your Digital Terrestrial Receiver display again the screen of scan mode selection. Press **Exit**

Enjoy your Digital Terrestrial Receiver.

4 Using your Digital Terrestrial Receiver

4.1 Watching live TV

Digital Terrestrial Receiver wake-up

To wake up your Digital Terrestrial Receiver from standby, press: **⏻** **STANDBY** on the front panel or remote control

Note

In order to reduce power consumption, switch your Digital Terrestrial Receiver to standby mode whenever you are not using it. For maximum energy saving we recommend you to switch off the Digital Terrestrial Receiver using the switch at the back of the Digital Terrestrial Receiver if you are not using it for a long time.

Channel selection

To change channels, use **P+/P-** or the numerical keys of the remote control or on the front panel.

Press **BACK** to move to the previous channel you watched.

A quicker way is to use **FAV** to use a Channel lists. **OK** will present the channel, **OK** again hides the Channel list. You could create your own channel list, see §5.6 Channel manager. Another quick way to select a channel is using the channel banner, see on next page.

Note

When two records are ongoing at the same time on two different frequencies, zapping is only allowed on those two frequencies. Unavailable channels are in grey in the **Favorite list** menu. Recording from the time shift buffer will record the full programme even if you start the recording after the programme has already begun. At the end of this operation, the playback will start again automatically at the point where you started the recording. The recorded programme will be indicated in red in the Time Shift bar (Refer to page 19).

Channel lists

While watching digital TV, you can access existing channel lists. See creation of a channel list in chapter channel manager..

- 1 Press **FAV** to display the channels of the current list.



- 2 Press the **◀** arrow key to go to the **Channel lists** menu.
- 3 Scroll up or down to the desired channel list using the **▲ / ▼** arrow keys.
- 4 Press **OK** or **▶▶** arrow key to display the channels of the selected list.

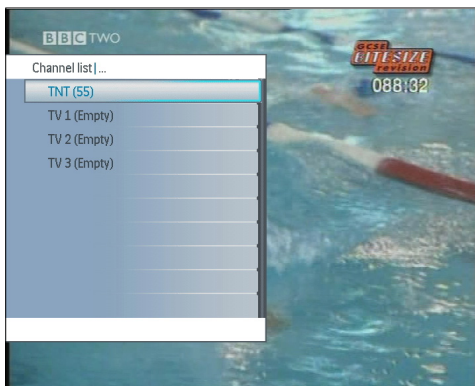

- 5 Scroll up or down to the desired channel using the **▲ / ▼** arrow keys.
- 6 Press **OK** to select the channel, or **EXIT**.
- 7 Press **OK** again or **FAV** or **EXIT** to close the channel list.

Notes

- You can only zap through the channels of the current list.
- To manage your favourite lists, see chapter 5.6 *Channel manager*.



Channel banner

Every time you tune to a channel, the channel banner appears, displaying information on this channel, including information on the current programme.

The channel banner is displayed for 4 seconds as per default.

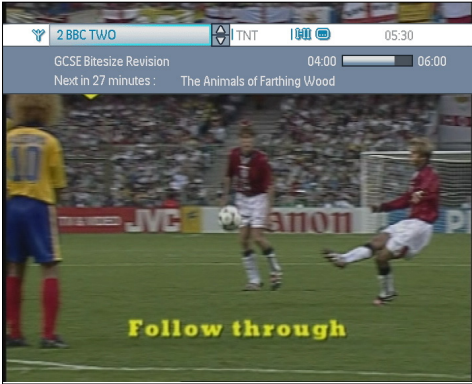
- 1 While watching a channel, you can display the channel banner at anytime by pressing info  button.



- 2 Use the  /  arrow keys to display the titles of the current and next programmes broadcast on other channels.
- 3 Press **OK** to select the channel or **EXIT** to remove the Channel banner and stay tuned to the current channel.

- 4 Press  again to display more information on the current programme.

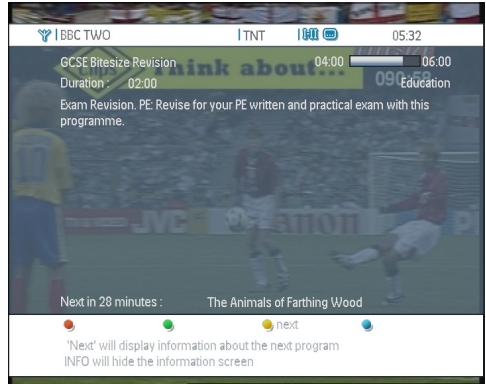

- 5 Press  a third time or **EXIT** to close the channel banner.

Volume control

To increase or decrease the volume, use the **VOL+/-** key.





To mute the sound, press .

Note

The volume level is also controlled from your TV set. It can also be controlled using your TV remote control.

In case of external amplifier, the volume level is only managed by the external device.

A change of volume is shown on-screen using a bar graph, while the  icon in the top left corner of the screen indicates audio mute.

Icon	Description
	Dolby Digital available
	Alternate audio available
	Subtitles available
	Teletext available

Options control

You can change the subtitles, audio language or TV format for a particular programme.

- 1 Press either the **I-III** key, or the **[...]** key or the **[OK]** key. Now the **Tools** menu is displayed for this programme.
- 2 Choose the relevant item using the arrow keys **▲ / ▼**.
- 3 Press the arrow key **▶▶** and then **▲ / ▼** to modify the selected item.
- 4 Press **◀◀** or **OK** to validate the modification.
- 5 Press the **EXIT** key to close the **Tools** menu.

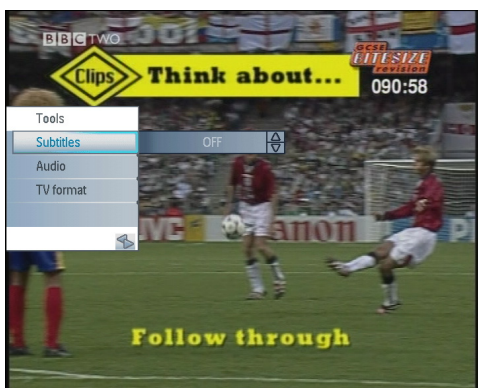

Note

Available languages depend on the transmitted content.

Note

TV format is also interpreted by your TV set. With an analog connection to a flat TV, the TV set could change the format automatically to propose a better view.

On HDMI the TV set receives information about the format of broadcast. If TV set is in automatic mode, the format chosen by TV set could update automatically.

Pause live TV

At any time, you can pause the programme that is being watched. The broadcast programme is temporarily recorded in the time-shift buffer to allow later resume of the playback.

- 1 Simply press **[PAUSE]** to pause any live TV programme. The Time shift bar appears.
- 2 Resume playback by pressing **[PAUSE]** again.
- 3 To return to the live TV programme, press **[▶]**.
- 4 Press **EXIT** or **OK** to close the time shift bar.

TV Guide

The TV Guide gives an overview of the scheduled programmes.

- 1 Press **[GUIDE]** on your remote control to view the scheduled programmes. Press **[GUIDE]** again to display the 8 days TV Guide (EPG).



- 2 Press the **◀◀ / ▶▶** arrow keys to navigate between programmes and the **▲ / ▼** arrow keys to navigate through channels.
- 3 Press **EXIT** to close the TV guide.

Note

Not all channels offer an extensive TV guide. Some channels provide the current day programme but do not offer detailed descriptions.

Watching 2 channels at the same time

While watching digital TV:

- 1 Press **PIP** once to display the current programme in an inset window (Picture in Picture, or PiP).



- 2 Press **PIP** a second time to view both programmes side by side on the screen (PaP). You can press the **P+/-** key to change the channel displayed on the left picture.

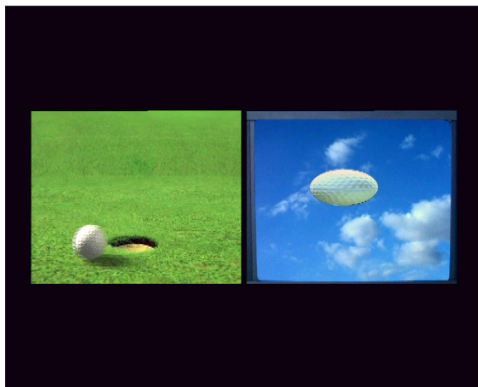

- 3 Press **PIP** a third time to return to normal viewing.

Note

When a recording is in progress, one of the two channel has to be the recorded channel. Accessing to MHEG5 interactivity (red button) is not possible when you are using Pip or Pap: this is signalled by “data service” message.

4.2 Controlling Live TV

When you begin to watch live TV, your Digital Terrestrial Receiver begins to store whatever you watch into the time shift buffer, which gives you control over live TV.

Each time you change channels, the watched programme is stored in a new title into the time shift buffer.

Once you have stored programmes into the time shift buffer, you can watch it again by using a free navigation through the time shift bar, by doing an Instant Replay or by accessing previous programmes.

Note

The time shift buffer stores up to 3 hours of live TV. After 3 hours, the oldest part of the recording is overwritten.

The time shift buffer is emptied when you turn your Digital Terrestrial Receiver to standby.

Time shift bar

The time shift bar is a bar-graph representing the contents of the time shift buffer, filled from the right leftwards.

- 1 Press **OK** to display the time shift bar.

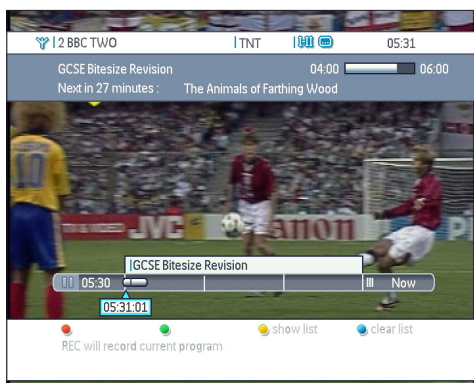

- 2 At any time, Press **OK** or **EXIT** to hide the time shift bar.

All Time shift bar commands are available on live or recorded content.

Moving within the programme:

- 1 Use the **▲ / ▼ / ◀▶** arrow keys to navigate through the time shift bar:
 - The **▲** arrow keys let you move from one title to the previous title
 - The **▼** arrow keys let you move from one title to the next title
 - The **◀▶** arrow keys allow you to move according to the chapter size (5 minutes by default).
- 2 Press the **⏪** key to return to live TV programme, and then **OK** to exit the time shift bar.

High speed playback:

- 1 Can only be activated when watching live or recorded content (not paused, or slow motion)
- 2 Press longtime (1 or 2 seconds) on **◀▶** or **▶▶** to display the Time shift bar and start the rewind or fast forward with double speed (x2).
- 3 Another press increases the speed up to x32. Available speeds are x2, x4, x8, x16 and x32.
- 4 Press **⏪** to go back to normal speed.
- 5 Press the **⏪** key to return to live TV programme, and then **OK** to exit the time shift bar.

Low speed playback:

- 1 When the playback is paused (by pressing **⏸**)
- 2 A short press on the **◀▶** or **▶▶** arrow keys lets you rewind or forward in slow motion. Available speeds in this mode are x1/2, x1/4 and x1/8.
- 4 Press the **⏪** key to return to live TV programme, and then **OK** to exit the time shift bar.

Instant Replay

This feature allows you to replay what you have seen during the last 30 seconds.

- 1 Press the **◀▶** arrow key. The time shift bar is displayed and you watch the previous 30' TV content.
- 2 Press the **⏪** key to return to live TV programme, and then **OK** to exit the time shift bar.

Access previous programmes

You can display a list of previously watched programmes to make your navigation easier.

- 1 Press **OK** to display the time shift bar
- 2 Press the **yellow-coloured** key to display the previous programmes stored on the time shift buffer.

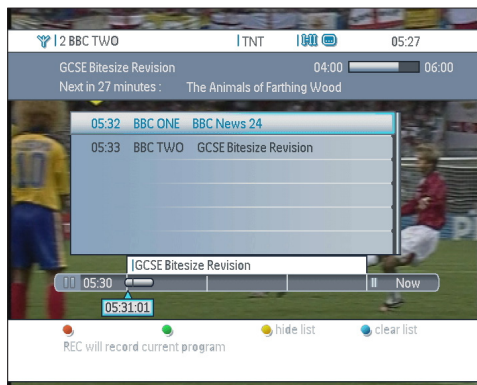

- 3 Move to the desired programme by using the **▲ / ▼** arrow keys.
- 4 Press **OK** to select the programme.
- 5 Press **EXIT** to close the time shift bar.

Clearing the Time Shift buffer

- 1 Press **OK** to display the time shift bar.
- 2 Press the blue-coloured key. The time-shift buffer is immediately emptied.

ⓘ Changing channel for more than 3 second create a new content on the time shift bar list of events.

ⓘ See also chapter 5.9 **Settings** about the **Recorder Settings** menu. to change duration of chapter.

4.3 Recording

Your Digital Terrestrial Receiver is compatible with following Freeview + requirements, it is limited to two recording at the same time.

Accurate recording

Recordings start and stop at the times sent by the broadcasters. If a programme starts early or runs late the record time will automatically be adjusted to record the whole programme. So you are sure to get your program recorded from its very beginning to its last second.

⊖ This feature could create a conflict between two recordings that seems to have no overlap at the time of programming.. Duration of such recordings cannot be changed.

Series Link

If a programme you wish to record is in a series, you can record the whole series. If the programme changes to a different day or time the Digital Terrestrial Receiver will track these changes and still record the programme

⊖ Using series recording intensively could create a lot of recordings. Your Digital Terrestrial Receiver may also have to cancel some recordings if more than two occur simultaneously (recording conflicts). Use this feature with mesure.

Split recordings

If a programme has two or more parts split by another entry in the TV Guide (e.g. a film divided into two parts by a News programme) you will be given the option to record all parts automatically.

Alternate instances

If a scheduled recording(s) overlap with other programmes set to record, you will be given the option to record one of the programmes later that day or week, on the same channel or a different channel.

⊖ by pressing **Timer button** you could check and correct decisions taken to resolve conflicts.

18

Recording a TV programme that is currently playing

1 While you watch live TV, press .

The record begins immediatly.

2 **To stop a record:** Press  to display the **Please select action** menu.



3 Select **Stop recording** by using the **▲ / ▼** arrow keys to stop recording the corresponding channel.

To ajust the duration of this record:

Press **INFO** button, then press **red button**.

⊖ Note

It is impossible to record more than two channels at the same time. If you try to record more than two channels, the Please select action menu displays a warning message:

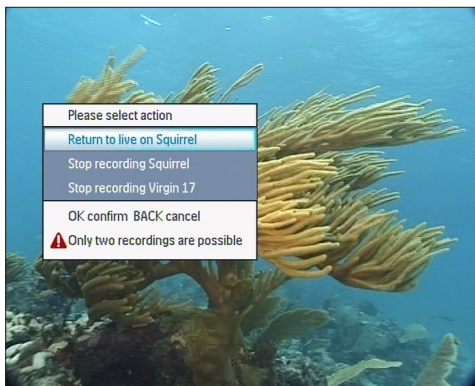

Using your Digital Terrestrial Receiver

Recording a TV programme that you have been watching

- 1 While you watch live TV, press **OK**.
The time shift bar appears.
- 2 Press the the ◀◀ arrow key to find the chapter where you want to start to record..
- 3 Press  to start the record.

Recording a TV programme through the Time Shift Bar



- 1 While you watch live TV, press **OK**.
The time shift bar appears.
- 2 Press the yellow-coloured key to display the previous programmes.
- 3 Move to the desired programme by using the ▲ / ▼ arrow keys.
- 4 Press **OK** to select the programme.
- 5 Press  to start the record.

Note

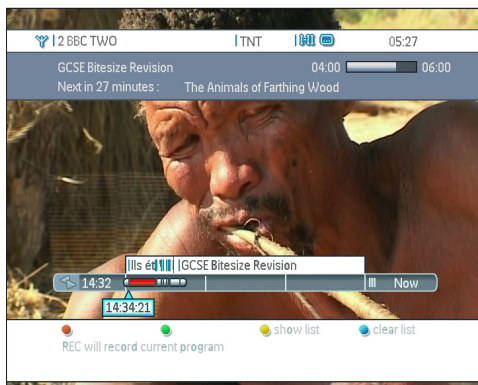

Recording from the time shift buffer will record the full programme from beginning to the end, even if you start the recording after the programme has already begun. As this is a relatively complex operation, the box does not display the image while the buffer is transferring the start of the programme (to the hard disk). At the end of this operation, the playback will start again automatically at the point where you started the recording. The recorded programme will be indicated in red in the Time Shift bar.



Recording by setting a timer through the TV guide

- 1 Press  on the remote control to go to the TV Guide.
- 2 Scroll to the programme you want to record.
- 3 Press  on the remote control.
- 4 Press **EXIT** several times to close the menu.

Recording with a series link

- 1 Press  on the remote control to go to the TV Guide.
- 2 Press  again to go to the 8 days TV Guide.
- 3 Use the ▲ / ▼ / ◀ / ▶ arrow keys to scroll to the programme you want to record.
- 4 Press the red-coloured key.

If the programme is in a series, the Digital Terrestrial Receiver displays the following screen:

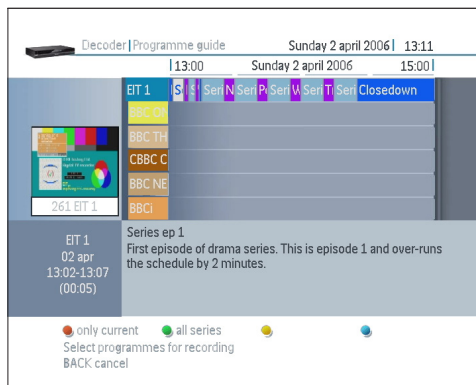

- 5 Select the action to perform:
 - Press the red-coloured key to record the current episode only.
 - Press the green-coloured key to record the whole series (see notes about limitations and conflicts).
- 6 Once you have pressed one of those two keys, the record is set.

Note: all record programming are called **Timers recording**. By pressing **Timer button** you could access to the list, check and correct decisions taken to resolve conflicts.

You can see in the **Timers recording** menu the episodes that are planned to record with a specific icon next to their titles:

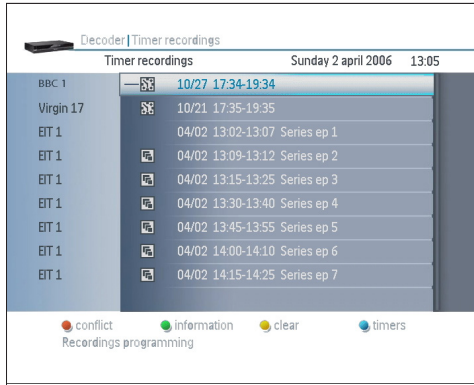

- If you try to record more than two channels using a timer, the third record will have a red symbol next to it.

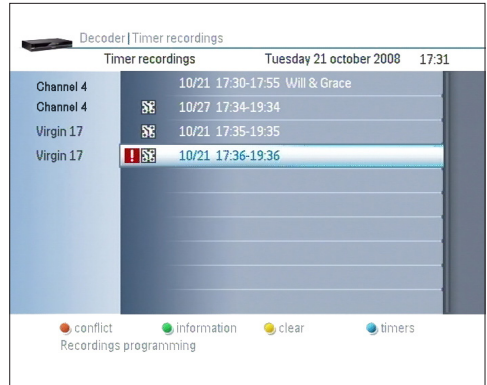

Recording by setting a timer through the timer key

- 1 Press the key.
- 2 Press the blue-coloured key.
- 3 Set the timer options by using the \blacktriangle / \blacktriangledown arrow keys and use the \blacktriangleleft / \blacktriangleright arrow keys to modify the options values:
 - Status: to enable or disable the timer
 - Repetition: once, daily, or weekly
 - Action: used to describe the action taken at the defined date and time: recording, recording (locked)
 - Day of week: available only if Repetition is set to once or weekly
 - Date: option available only if Repetition is set to once
 - Begin time
 - End time
 - Channel: press **OK** to display the list of channels and press **OK** again to make a selection
- 4 Press **EXIT** several times to close the menus, or press again to close the menu.

Note

- Set timers are represented by a clock icon.
- It is impossible to record more than two channels at the same time.

Tips

- You can start watching the programme you are recording while recording is still in progress.
- You can record any programme you have watched within the past 3 hours.
- You can watch other channels while you record. Select another using the remote control.
- When two records are ongoing at the same time on two different frequencies, zapping is only allowed on those two frequencies. Unavailable channels are in grey in the **Favorite list** menu.

List of icons in timer recordings

Icon	Description
	Series recording
	Protected content
	Programme scheduled for recording
	Conflict

4.4 HDD library

You can store up to 78 hours of video.

Playback of Records

- 1 Press **HDD** on the remote control.
- 2 Scroll to the desired item using the ▲ / ▼ arrow keys.
- 3 Press **OK**, to start viewing, “HDD” text and disque icon is displayed on the front display.
- 4 In case of protected programme, enter your PIN code.

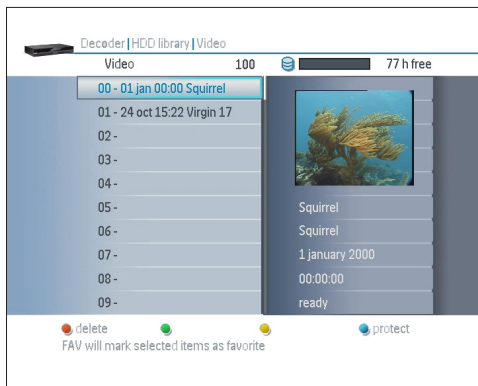

To control the playback, you have to use the Time Shift Bar: All the commands and mode of the Time shift bar are available. See page 16.

- 1 Press **OK** to display the time shift bar.
- 2 At any time, Press **OK** or **EXIT** to hide the time shift bar.

High speed playback:

- 1 When you are viewing a content with the normal speed.,
- 2 A long pressure on ◀◀ or ▶▶ will display the Time shift bar and start the rewind or fast forward with double speed (x2)..
- 3 Another pressure increase the speed up to x32. Available speeds are x2, x4, x8, x16 and x32.
- 4 Press **▶▶** to go back to normal speed.
- 5 Press the **⏪** key to return to live TV programme, and then **OK** to exit the time shift bar.

4.5 Play files from an USB device

The integrated USB port allows you to read the following files:

- Music: MP3 files
- Images: JPEG files

- 1 Insert the USB device into the USB port.
- 2 Press **USB** on your remote control or the USB button on the front panel.
- 3 Scroll to the desired type of file using the ▲ or ▼ arrow keys.
- 4 Press **OK**
- 5 Scroll to the desired file or folder using the ▲ or ▼ arrow keys.
- 6 Press **OK** to start playing.

Warning

Your Digital Terrestrial Receiver can only read files recorded with a FAT16 or FAT32-compliant file format. and USB 2.0 devices only.

5 Use more of your Digital Terrestrial Receiver

This chapter gives a complete description the functionalities of your Digital Terrestrial Receiver.

5.1 Digital Terrestrial Receiver full overview

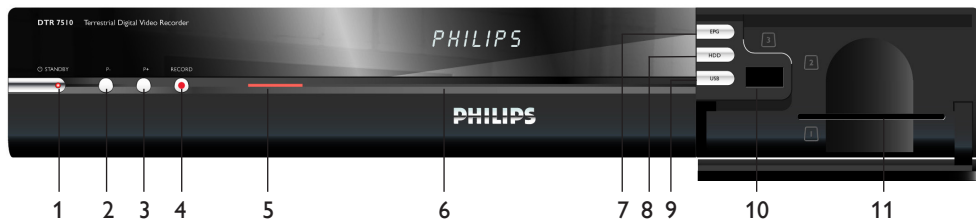

Front Panel

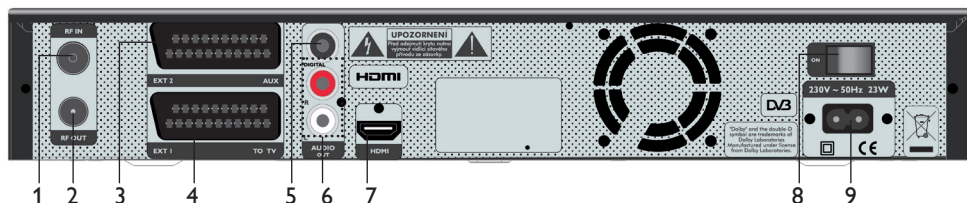

Rear Panel

Front Panel

- 1 **STANDBY** button with indicator, switch to standby/wake up
Green LED: watching mode
Red LED: standby mode
Orange LED: initialisation mode
- 2 P-, previous programme
- 3 P+, next programme
- 4 RECORD, instant recording
- 5 Recording LED, indicates recording
- 6 Display panel
- 7 EPG, open/close EPG
- 8 HDD, open/close HDD library
- 9 USB, access USB contents
- 10 USB connector*
- 11 Smart card reader

Rear Panel

- 1 RF IN*, input to connect your aerial cable from the wall socket
- 2 RF OUT*, output to connect your recorder to a VCR/TV set/another receiver
- 3 AUX scart* output to connect your external recorder or DVD player
- 4 TV scart*, output to connect your TV set
- 5 SPDIF*, digital audio output
- 6 L/R audio*, Left/Right analogue audio outputs
- 7 HDMI*, output to connect your TV set with HDMI input
- 8 ON/OFF switch**, turn on/off your Digital Terrestrial Receiver
- 9 Power**, output to connect the mains cord



* Safety extra low voltage

** Hazardous voltage









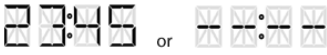

Use more of your Digital Terrestrial Receiver

5.2 Digital Terrestrial Receiver display full overview

Interpretation of front display pictograms

	Lit when playing HDD contents
	Lit when playing USB contents
DIRECT	Lit when watching live TV

Interpretation of front display messages

	Digital Terrestrial Receiver connected to mains and in standby
	Digital Terrestrial Receiver in standby
	Initiating Digital Terrestrial Receiver
	Digital Terrestrial Receiver tuned on a digital TV channel
	Digital Terrestrial Receiver tuned on a digital radio channel
	Menu
	Playback from HDD library or USB device
	Software upgrade starting
	Successful software upgrade
	Software upgrade failure
	Digital Terrestrial Receiver overheating

5.3 Remote control full overview

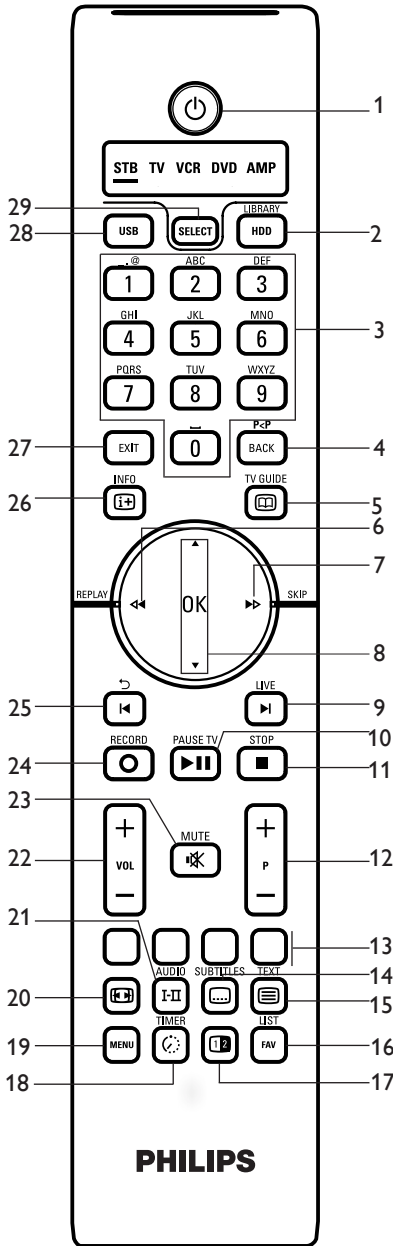

- | | | |
|----|-------------|--|
| 1 | | Switch to standby / wake up |
| 2 | HDD | Open/close HDD library |
| 3 | | Alphanumeric keypad |
| 4 | BACK | Switch to previous channel or previous section |
| 5 | | Open/close TV GUIDE |
| 6 | | Replay / Left, |
| 7 | | Skip / Right, Sub menu access. |
| 8 | | Move up/down within lists |
| | OK | Confirm selection. Time shift bar. |
| 9 | | Return to live TV |
| 10 | | Pause live TV |
| 11 | | Stop recording / playback |
| 12 | P+/- | Select next / previous channel |
| 13 | Colour keys | Contextual keys |
| 14 | | Select subtitles |
| 15 | | Display / hide teletext |
| 16 | FAV | Channel selection, Favourite lists |
| 17 | | Pip Pap selection |
| 18 | | Access to all recorded programmes. |
| 19 | MENU | Open / close menu |
| 20 | | Open / close TV format menu |
| 21 | I-II | Open / Close Tools menu |
| 22 | VOL +/- | Turn the volume up/down |
| 23 | | Mute / Restore sound |
| 24 | | Instant recording |
| 25 | | Instant replay |
| 26 | | Information banner |
| 27 | EXIT | Close Menu / Info Banner / Time shift bar |
| 28 | USB | Access USB contents |
| 29 | SELECT | Mode selection: STB must be highlighted by first press |

5.4 Menu full overview

While watching digital TV:

- 1 Press **MENU** to display the main menu.



- 2 To scroll to the appropriate menu item, press the \blacktriangle / \blacktriangledown arrow keys.
- 3 To display the corresponding sub-items, press **OK** or \blacktriangleright .

Note

To open a locked menu item, you must enter your PIN Code.

Once you have highlighted an adjustable item, you can view the list of available settings or corresponding numerical values on the right-hand side of the screen.

- Set the appropriate setting using the arrow keys.
- Use the numerical keys to enter values if necessary.
- Use the coloured keys to perform contextual actions. The actions that can be performed are described at the bottom of the screen.
- Press **BACK** or the \blacktriangleleft arrow key to save your changes and return to the previous screen.
- Press **MENU** to exit the menu system.

5.5 TV guide

In this menu you can access the programme guide and also check the timer recordings.

- 1 Press **MENU** to display the main menu
- 2 Use the \blacktriangle / \blacktriangledown arrow keys to highlight **TV Guide**.
- 3 Press **OK**. The TV Guide menu is displayed.

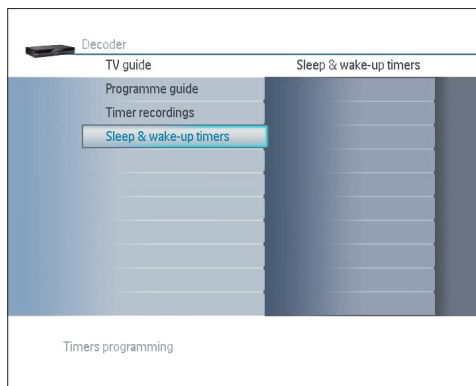

The following options are available from this screen:

- Programme guide
- Timer recordings
- Sleep & wake-up timers

 Note that Timer recordings list contains the recordings based on timer but also the recordings that are programmed through EPG including serial recording and alternate events. It is the place where you should check the conflicts that could be detected (not linked to recordings moving in time to follow the accuracy requirement).

5.5.1 TV Guide

The TV Guide offers you an overview of the programmes that will be broadcast during the next 8 days.

- 1 Once you are in the **TV Guide** menu, use the **▲ / ▼** arrow keys to highlight **Programme guide**.
- 2 Press **OK**. The **Programme guide** menu is displayed.



Note

When you are watching TV, you can directly access the **Programme guide** menu by pressing the **Ⓜ** key (What's on and Next information).

- 3 For more information on a programme, highlight it by using the **▲ / ▼ / ◀ / ▶** arrow keys.
- 4 Press the appropriate contextual keys:

- Press **OK** to preview the programme.
- Press the red-coloured key to record the highlighted programme.
- Press the green-coloured key to display informations about the programme.
- Press the yellow-coloured key to display the 8-days guide.
- Press the blue-coloured key to watch the highlighted channel.

- 5 Close the guide by pressing the **EXIT** key.

8 days TV guide (EPG)

- 1 Once you are in the **Programme guide** menu, press the yellow-coloured key to display the 8-days TV guide (EPG).

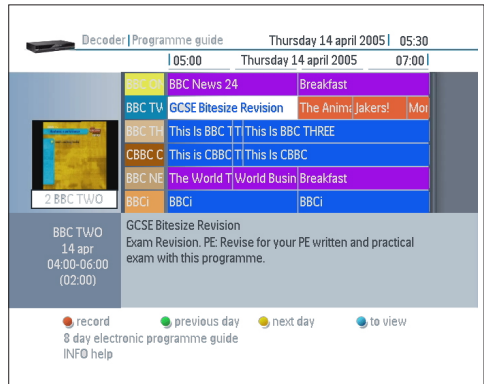

- 2 Press the appropriate contextual keys:

- Press **OK** to preview the programme.
- Press the red-coloured key to record the highlighted programme.
- Press the green-coloured key to display the guide of the previous day.
- Press the yellow-coloured key to display the next day guide.
- Press the blue-coloured key to watch the highlighted channel.

- 3 Close the guide by pressing the **EXIT** key. If you want to go back to the **Programme guide** menu, press **BACK**.

Notes

- When you are watching TV, you can directly access the **8 days TV Guide** by pressing the **Ⓜ** key twice.
- Pressing **Info** will display significance of colors.
- When you just activate your recorder, it take up to 20 minutes for the EPG to be fully complete.
- Programmes already over will not appear will not appear in EPG.

Tip If you want to record a scheduled programme, move to this programme and press the  key. When you move the focus (white color) the event will be colored in red (recording or recording programmed)

5.5.2 Timer recordings

The **Timer recordings** menu lists all the current recordings that are programmed.

- 1 Once you are in the **TV Guide** menu, use the **▲ / ▼** arrow keys to highlight **Timer recordings**.
- 2 Press **OK**.
The **Timer recordings** menu is displayed.

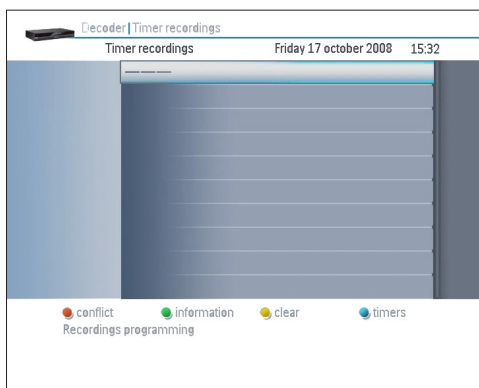

Set a timer

- 1 Once you are in the **Timer recordings** menu, press the blue-coloured key. The following screen is displayed:



- 2 Press **▶▶** to enable the timer.
- 3 Set the timer options by using the **▲ / ▼** arrow keys and use the **◀◀ / ▶▶** arrow keys to modify the options values.

- Status: to enable or disable the timer
- Repetition: once, daily, or weekly
- Action: used to describe the action taken at the defined date and time: recording, recording (locked)
- Day of week: set the day when you want to record. This option is available only if Repetition is set to once or weekly
- Date: set the date when you want to record. This option is available only if Repetition is set to once
- Begin time
- End time
- Channel: select the channel you wish to record. Press **OK** to display the list of channels and press **OK** again to make a selection

- 4 Once all the options are set, press **EXIT**. Your timer is set.

Clear timer

- 1 Select the timer by using the **▲ / ▼** arrow keys.
- 2 Press the yellow-coloured key. The timer is immediately cleared.

Modify a timer

- 1 Select the timer by using the **▲ / ▼** arrow keys.
- 2 Press the green-coloured key. You can now modify the timer settings.
- 3 Once you have modified all the options you needed to, press **EXIT** to save the changes.

Conflict

You may have conflicts between two timers. Conflicts are represented by red marks:

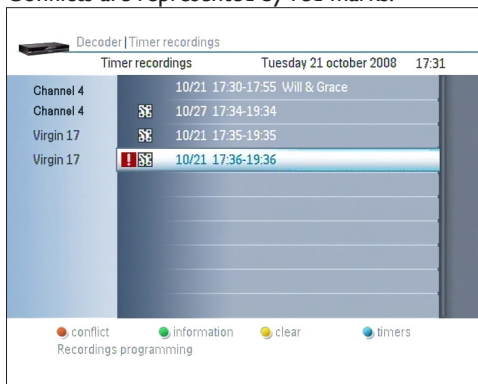

In that case:

- 1 Select the marked timer by using the ▲ / ▼ arrow keys.
- 2 Press the red-coloured key to solve the conflict.

5.5.3 Sleep & wake-up timers

The **Sleep & wake-up timers** can put the Digital Terrestrial Receiver to standby/wake-up mode, like an alarm clock.

- 1 Once you are in the **TV Guide** menu, use the ▲ / ▼ arrow keys to highlight **Sleep & wake-up timers**.
- 2 Press **OK**.
The **Sleep & wake-up timers** menu is displayed.

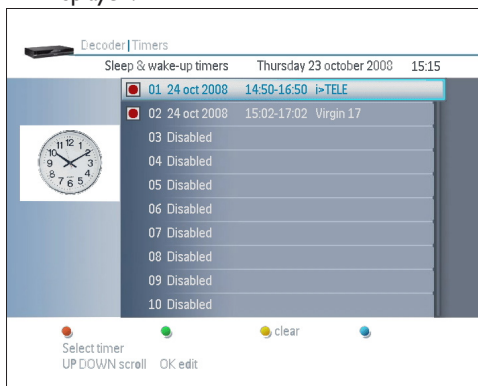

Set a timer

- 1 Once you are in the **Sleep & wake-up timers** menu, select a timer by using the ▲ / ▼ arrow keys.
- 2 Press **OK**.
The following screen is displayed:

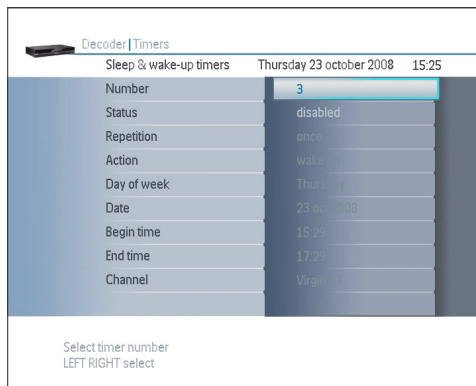

- 3 Set the timer options by using the ▲ / ▼ arrow keys and use the ◀ / ▶ arrow keys to modify the options values.

- Status: to enable or disable the timer
- Repetition: once, daily, or weekly
- Action: used to describe the action taken at the defined date and time: recording, recording (locked)
- Day of week: set the day when you want to record. This option is available only if Repetition is set to once or weekly
- Date: set the date when you want to record. This option is available only if Repetition is set to once
- Begin time
- End time
- Channel: select the channel you wish to record. Press **OK** to display the list of channels and press **OK** again to make a selection

- 4 Once all the options are set, press **EXIT**.
Your timer is set.

Clear a timer

- 1 Select the timer by using the ▲ / ▼ arrow keys.
- 2 Press the yellow-coloured key.
The timer is immediately cleared.

* Tips

- You can start watching the programme you are recording while recording is still in progress.
- You can record any programme you have watched within the past 3 hours.
- You can watch other channels while you record. Select another using the TV remote control.

5.6 Channel manager

At installation, all the channels found are added to the **All channels** list. From this list, you may create, delete, and rename favourite lists according to your preferences.

- 1 Press **MENU** to display the main menu.
- 2 Scroll to the **Channel manager** menu item using the ▲ / ▼ arrow keys, and then press **OK**.

The following options are available from this screen:

- All channels
- Favorite lists

- 3 Select **Favorite lists** using the ▲ / ▼ arrow keys.
- 4 Press **OK**.

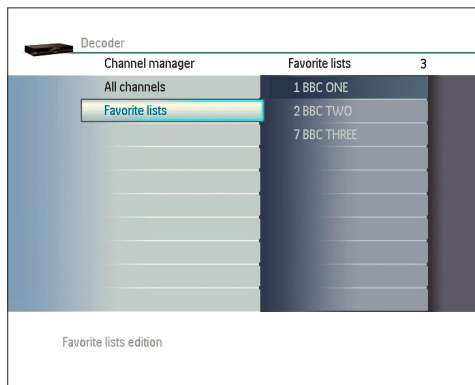

Add/remove channels from a favourite list

Three lists are created by default: **TV1** to **TV3**.

- 1 Press **OK** again.
- 2 Press **FAV** to select the current list. The name of the list is displayed on top right corner.
- 3 Press the red-coloured key.
- 4 Scroll to the channels you want to add or remove to the current list, and select them individually by pressing **OK**.
Selected channels are marked with an arrow.

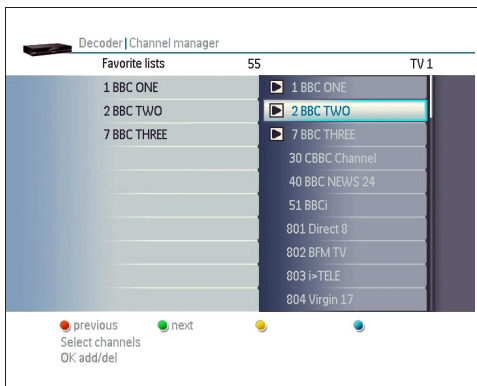

- 4 Press **◀** to return to the favourite lists. The new list is now displayed.

Rename a favourite list

- 1 Once you are in the **Favourite lists** menu, scroll to the list you want to rename using **FAV**.
- 2 Press the blue-coloured key.

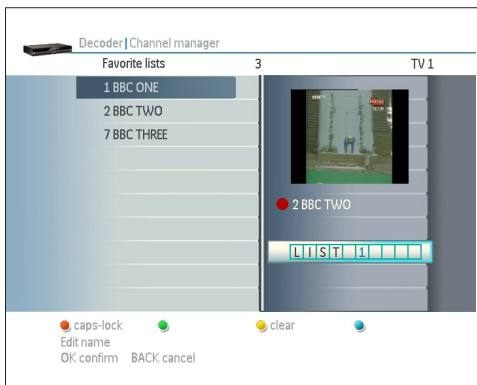

- 3 Enter the desired name using the **▲ / ▼ / ◀** / **▶** arrow keys.
- 4 Press **OK** to validate or **BACK** to cancel.

Notes

- When you activate one of the favourite lists by pressing **FAV** while watching digital TV, the Digital Terrestrial Receiver only zaps through your favourite channels. Press **FAV** again to toggle between your favourite lists and the **All channels** list.

- The **Favourites lists** menu is also used to edit individual favourite lists. To edit a given favourite list, select this list on the right hand side of the screen. You can then access various edition features.

Sort the selected list automatically:

- 1 Once you are in the **Favourite lists** menu, scroll to the list you want to sort using **FAV**.
- 2 Press the yellow-coloured key.
- 3 Press the appropriate colour key depending on the type of sorting you want to perform:

- Press the red-coloured key to sort all channels according to their name.
- Press the green-coloured key to sort all channels according to their type.
- Press the yellow-coloured key to sort all channels according to their frequency.
- Press the blue-coloured key to sort all channels according to their number.

- 4 Press **EXIT** several times to exit the **Favourite lists** menu.

Sort the selected list manually

- 1 Once you are in the **Favourite lists** menu, scroll to the list you want to sort using **FAV**.
- 2 Press the yellow-coloured key.
- 3 Press **FAV**
- 4 Press the **▲ / ▼** arrow keys to highlight the channel you want to move and press **OK**.

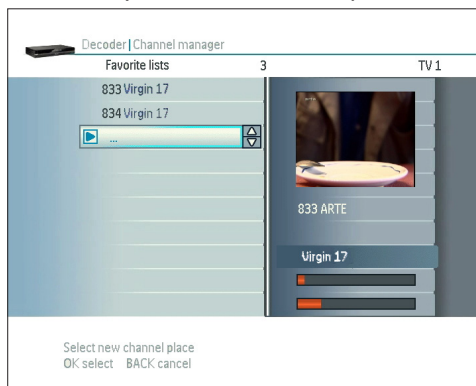

- 5 Press the **▲ / ▼** arrow keys to move the selected channel.

- 6 Press **OK**.
- 7 Press **EXIT** several times to exit the **Favorite lists** menu.

5.7 HDD Library

- 1 Press **MENU** to display the main menu.
- 2 Scroll to the **HDD Library** menu item using the **▲ / ▼** arrow keys.
- 3 Press **OK**.

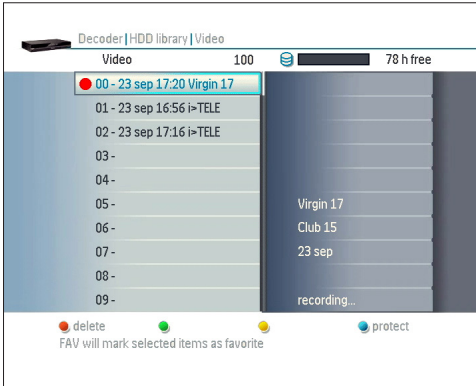

Note

Content that are currently recording are marked with a red circle next to it.

Watch recorded content

- 1 Once you are in the **HDD Library** menu, use the **▲ / ▼** arrow keys to highlight the programme you want to watch.
- 2 Press **OK**.
The programme is displayed.

Protect recorded content

- 1 Once you are in the **HDD Library** menu, use the **▲ / ▼** arrow keys to highlight the programme you want to watch.
- 2 Press the blue-coloured key. The programme is now protected.

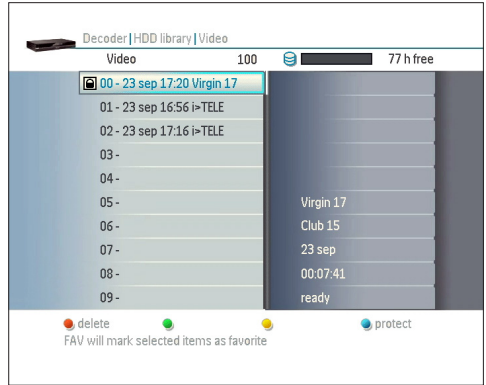

Note

Protected programmes are marked with a padlock next to it

Delete recorded content

- 1 Once you are in the **HDD Library** menu, use the **▲ / ▼** arrow keys to highlight the programme you want to watch.
- 2 Press the red-coloured key. The programme is immediately deleted.

Note

If the content is protected, your PIN-Code will be asked before deletion.

5.8 USB

The integrated USB port allows you to read the following files:

- Music: MP3 files
- Images: JPEG files

Note

Only USB keys are recognized by the Digital Terrestrial Receiver. External Hard Disk Drives, digital music players may not work with the Digital Terrestrial Receiver.

- 1 Plug an USB key into the USB port in the front panel, behind the door.
- 2 Press **MENU** to display the main menu.
- 3 Scroll to the **USB** menu item using the **▲ / ▼** arrow keys.

4 Press **OK**.

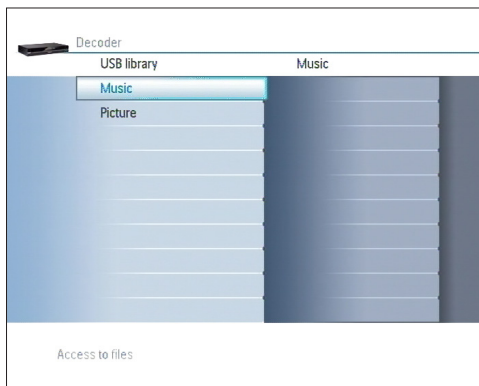

5 Choose between **Music** and **Picture** the type of files you want to play using the **▲ / ▼** arrow keys, and then press **OK**.

6 Use the **▲ / ▼ / ◀ / ▶** arrow keys to select the desired file.

7 Once the desired file is highlighted, press **OK** to start playing.

8 You can perform the following actions, depending of the type of file you are playing:

- Music: Press **▶** to play the file. Press **■** to stop playing the file. Press the red-coloured key to delete the file. Press the yellow-coloured key to toggle between playing modes (you can choose between **Single song**, **All songs** and **Shuffle**). Finally, press the blue-coloured key to enable or disable the loop.
- Picture: Use the red-coloured key to dezoom and the green-coloured key to zoom. Press the yellow-coloured key to rotate the displayed picture.

Tip

You can access directly to your USB key by pressing **USB** on the remote control, or by using the USB button on the front panel.

Warning

Only files recorded with a FAT16 or FAT32-compliant file format can be read.

5.9 Settings

- 1 Press **MENU** to display the main menu.
- 2 Use the **▲ / ▼** arrow keys to highlight the **Settings** menu item.
- 3 Press **OK**.

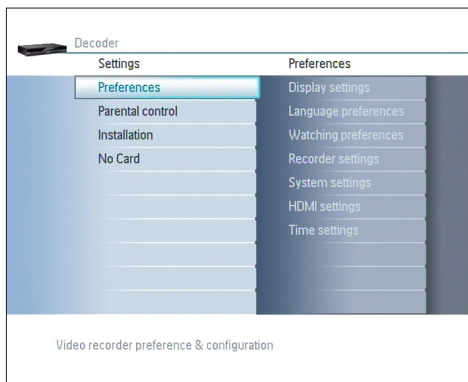

5.9.1 Preferences

- 1 Once you are in the **Settings** menu, select **Preferences** using the **▲ / ▼** arrow keys.
- 2 Press **OK**.

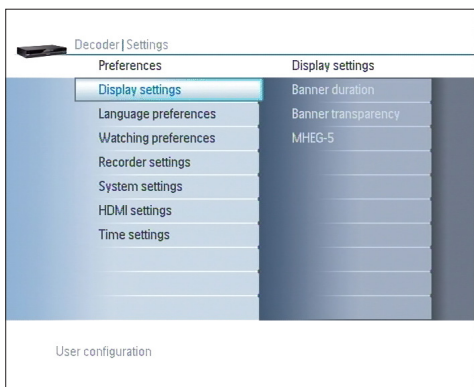

Preferences is used to set the following options:

- Display settings
- Language preferences
- Watching preferences
- Recorder settings
- System settings
- HDMI settings
- Time settings

Display settings

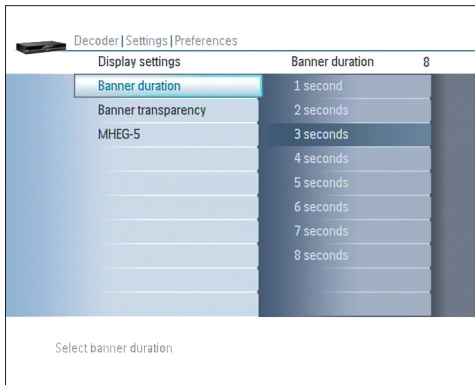





Set appropriate values for:

- Banner duration: banner display duration from 1 to 8 seconds
- Banner transparency: from 0 to 100 % in steps of 25 %
- MHEG-5: choose between ON and OFF.

Note

With the  key you may access additional text and multimedia contents. MHEG (Multimedia and Hypermedia Expert Group) is a standard that offers you information about various contents like life style, shopping or sports events and results.

- 1 Press  or the red-coloured key to bring up the text menu for the current channel.
- 2 Use the  /  arrow keys to navigate through the menu.
- 3 Use **OK** to select an item.
Additionally the four coloured keys (Red, Green, Yellow and Blue) help you to navigate through the content of a page. Their use varies for different stations. Function is commonly explained at the bottom of the display.
- 4 Press  again to leave the MHEG, or press **EXIT**.

Language preferences

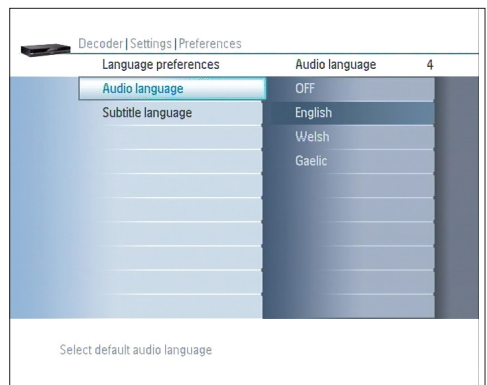

Select your preferred language for the following:

- Audio language
- Subtitle language

You can also set the **Audio language** and/or **Subtitle language** options to OFF to disable them.

Watching preferences

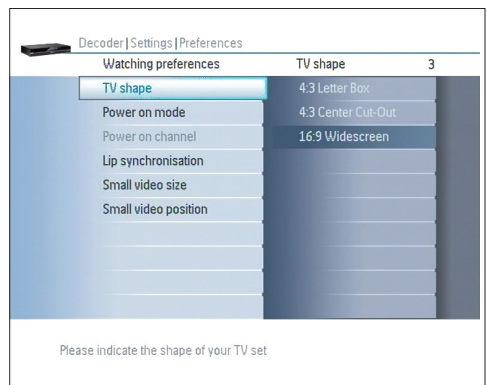

Set appropriate values for the following:

- TV shape: defines the way the video format is adapted: 4:3 Letter Box, 4:3 Center Cut-Out or 16:9 Widescreen
- Power on mode: last viewed channel or defined channel
- Power on channel: if you have set Power on mode to **defined channel**, choose the channel to be tuned at power on

- Lip synchronisation: Set to **on** by default. Other choices are **progressive** and **off**
- Small video size: size of the inset window in PiP mode, choose between **small**, **standard** and **large**
- Small video position: select the corner in which the inset window in PiP mode shall be displayed

Note

The TV shape is managed by the Digital Terrestrial Receiver. But TV set manage also the adaptation of input format to shape and size. Set your TV to the similar equivalent setting (refer to the user manual of your TV set).

Recorder settings

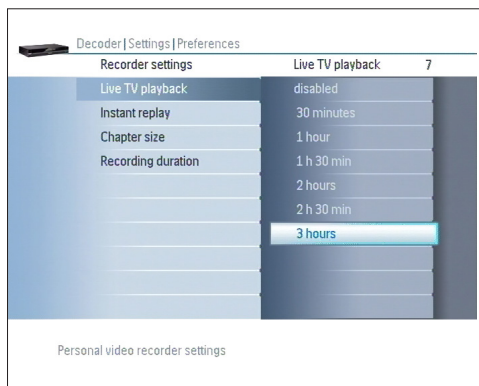

- Live TV playback: set the maximum duration of live TV playback, from 30 minutes to 3 hours, or disable it
- Instant replay: set the time of instant replay, from 10 seconds to 1 minute
- Chapter size: set the Time shift buffer's default storage size from 1 minute to 15 minutes
- Recording duration: Set the recording default duration, from 30 minute to 3 hours.

System settings

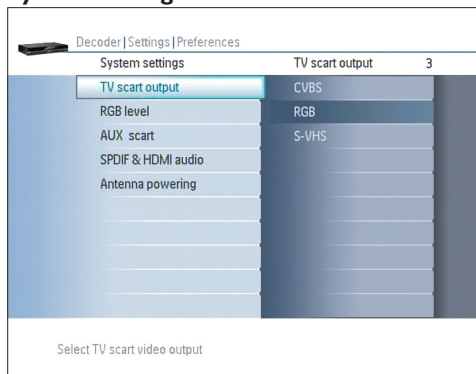

- TV scart output
- RGB level
- AUX scart
- SPDIF & HDMI audio: Set the value to **PCM** for stereo and **Dolby Digital** for multi-surround sound output on audio amplifier
- Antenna powering

HDMI settings

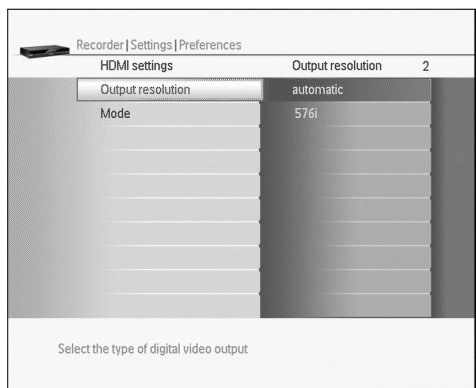

- Output resolution: only two choices are possible to set HDMI output resolution: "automatic" mode (by default) or "576i" mode.
- Mode: select HDMI if your TV set is fitted with an HDMI input or select DVI if your TV set is only fitted with a DVI input. In the latter case, you need an HDMI-DVI cable or a HDMI-DVI adapter.

Note

- All TV do not support 576i output.
- In case of black screen after selecting an HDMI output, please connect a SCART cable to your TV set to change the output HDMI resolution.

Time settings

Set the appropriate time using the coloured keys.

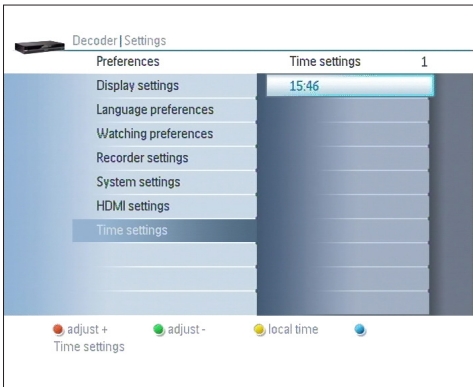

5.9.2 Parental control

- 1 Once you are in the **Settings** menu, select **Parental control** using the ▲ / ▼ arrow keys.
- 2 Press **OK**.

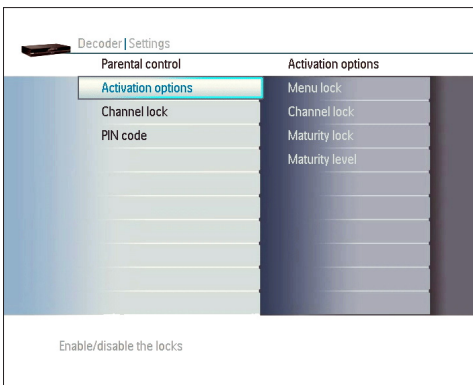

Parental Control is used to activate locking options. A PIN Code is used to prevent access to locked items.

Locking options include:

- Locking access to the menu
- Locking access to individual channels
- Locking access to programmes according to their maturity rating.

Parental Control is also used to change the PIN Code of the Digital Terrestrial Receiver.

Activation options

Enable or disable the following:

- Menu lock
- Channel lock
- Maturity lock

If you enable Maturity lock, select a Maturity level. Maturity level is used to set PIN Code protection on programmes according to their maturity rating.

This feature is based on broadcast ratings. Very few channels are broadcasting ratings.

Set a maturity level from age 2 to 18 to prevent undesired access to programmes for which maturity rating is higher. For instance, to prevent your child from watching a programme non-suitable to children below 10, set the maturity rating to 10.

To access this programme, you will be prompted to enter your PIN Code.

Channel lock

To lock or unlock channels:

- 1 Scroll to the channel you want to lock or unlock.
- 2 Press the green-coloured key to lock or unlock the channel. Locked channels are marked with a padlock.
- 3 Press **OK** to exit the channel list

Note

- Channel lock is effective only if you have enabled the channel lock option.
- A locked channel is locked in all the lists it belongs to.

PIN Code

To change your PIN Code:

- 1 Enter your PIN Code.
- 2 Enter your new PIN Code.
- 3 Enter your new PIN Code again.

Note

Once you have changed your PIN Code, keep it secret to prevent others from using it. If you forget or lose your PIN Code, refer to chapter Frequently asked questions.

Note

The PIN Code default value is 0000.

5.9.3 Installation

- 1 Once you are in the **Settings** menu, select **Installation** using the ▲ / ▼ arrow keys.
- 2 Press **OK**.

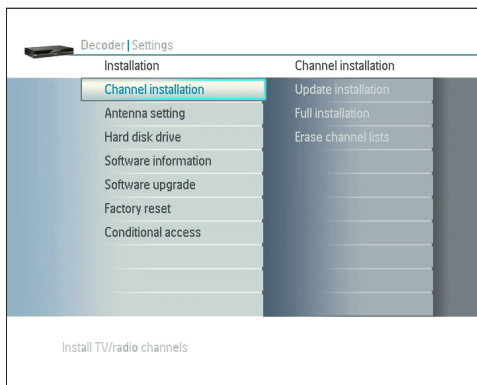

This menu is used to:

- Manage channel installation
- Position your antenna - Test signal level and quality
- Manage the Hard Disk Drive
- Check software upgrades and information
- Restore the Digital Terrestrial Receiver factory settings.

Disabling Hard drive is a way to reduce Fan noise. HDD is a source of heat and not using it reduces the need for using the internal fan.

Channel installation

This sub-menu is used to manage channel installation and update TV/Radio services in the main list

- Update installation: manual update
- Full installation: choose between **fast**, (recommended) **automatic** and **advanced**. (long) see **Retune** page 11
- Erase channel lists: Use this option to delete all channels and favorite lists.

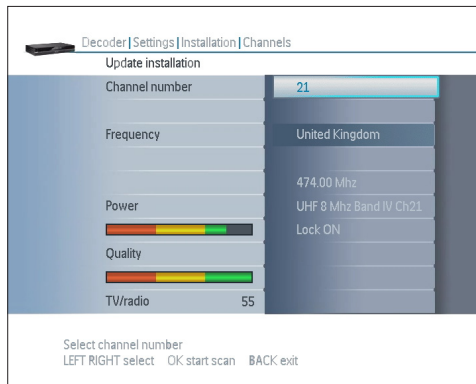

Antenna setting

This sub-menu is used to check the signal level and quality. If the signal power and quality is not adequate, adjust your antenna.

Note

For information on the UHF channels available in your area refer to your local dealer.

Hard disk drive

- Record files: press **OK** to delete all
- Format disk: press **OK** to format disk
- Hard disk drive: use the ◀◀ / ▶▶ arrow keys to enable or disable Hard Disk Drive.

Note

- Disabling the Hard Disk Drive also disables all the recording functions and Time Shift Buffer functions. You won't be able to access the recorded programmes.
- Information on the HDD reference and capacity is displayed in the bottom right corner.

Software information

This menu gives you information on the Digital Terrestrial Receiver, including the model type and current software version.

Software upgrade

Software upgrade is used to display the current software version.

In order to maintain advantages of software improvements we are carrying out, please check regularly on the DTG web site, (http://www.dtg.org.uk/industry/download_schedule.php) in the “Freeview downloads” tables, for the availability of a new software version for the Philips DTR7510/05 digital terrestrial recorder.

If there is a new software version broadcast, please follow the instructions:

- 1 Press red colored button to check if an update is available. It will take few minutes.
 - 2 If a new version is found, press **OK** to install it. Press **OK** to confirm.
- When update is finished, it will reboot the box.

Factory reset

Factory Reset is used to restart the Digital Terrestrial Receiver in its initial state: it is protected by code (default 0000)

Reset & restart: you lose all data and information previously stored, and you have to restart first installation.

 All recordings on hard drive are deleted !!



Conditional access

The Conditional access sub-menu is used to give information on the Nagra-Mediagard conditional access embedded in the software version of your digital terrestrail recorder.

5.9.4 Smart Card

- 1 Once you are in the **Settings** menu, select **Smart Card** using the **▲ / ▼** arrow keys.
- 2 Press **OK**.

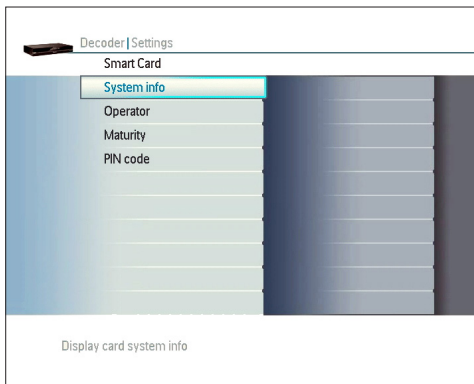

This menu provides you access to the following options:

- System info
- Operator
- Maturity
- PIN code

System info: displays card system info

Operator: displays card operators info

Maturity: provides information about maturity level

PIN code: use it to change the card PIN code

6 Maintenance

6.1 Cleaning

For cleaning, use a soft, damp (not wet) cloth. Never use any abrasive cloth and aerosol cleaners

6.2 Replacement

The Digital Terrestrial Receiver does not contain any user-serviceable parts. Do not attempt to open it. All maintenance work must be carried out by qualified service centres.

6.3 Disposal

Your product is designed and manufactured with high quality materials and components, which can be recycled and reused.

Please inform yourself about the local separate collection process for electrical and electronic products.

Please act according to your local rules and do not dispose of your old products with your normal household waste. The correct disposal of your old product will help prevent potential negative consequences for the environment and human health.

7 Accessories and connections

7.1 Connecting a DVD player / external recorder

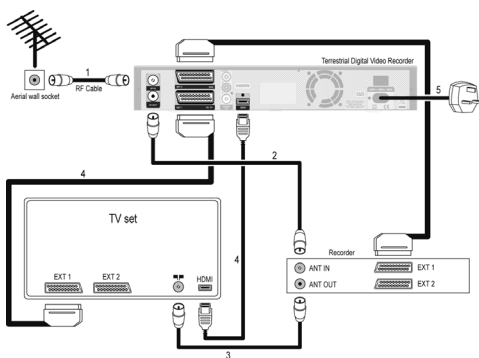

- 1 Connect the terrestrial antenna cable from the wall socket or from a table-top antenna to the “RF IN” socket at the rear of the Digital Terrestrial Receiver
- 2 Connect the “RF OUT” socket at the rear of the Digital Terrestrial Receiver to the RF input of your DVD player / external recorder using a RF cable
- 3 Connect the RF output at the rear of your recorder to the RF input of your TV set using a RF cable
- 4 Connect the SCART cable to the SCART input of the TV set and to the “EXT1 TO TV” SCART socket at the rear of the Digital Terrestrial Receiver. Your recorder does not include any recording feature from Scart input.
You could also connect an HDMI cable to the HDMI input of the TV set and to the “HDMI” socket at the rear of the Digital Terrestrial Receiver
- 5 To connect the Digital Terrestrial Receiver to the mains, refer to chapter Getting started

7.2 Connecting your audio equipment

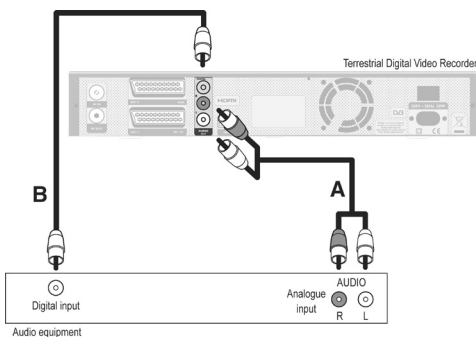

Option A – Analogue connection

Connect the L/R audio outputs to the relevant inputs of your audio equipment using a double CINCH cable (not supplied). Consult the user manual of your audio equipment to choose the proper analogue audio inputs.

Option B – Digital connection

Your audio equipment is fitted with a digital audio input:
Connect the DIGITAL audio output of the Digital Terrestrial Receiver to the relevant audio input of your audio equipment using a single CINCH cable (not supplied).
Consult the user manual of your audio equipment to choose the proper digital audio input.

ⓘ Notes

With digital connection, Mute and Volume operations are managed by your audio equipment and not any more by your recorder.

7.3 Universal remote control

Prior to using your universal remote control, check or set the following:

- Device you want to control (Mode selection)
- Volume and mute control assignment
- Brand setting for your TV, VCR, DVD and Amplifier

7.3.1 Mode selection (selecting the device you want to control)

Your 5-in-1 remote control can be used to control most of your audio/video equipment through various modes:

- **STB** mode for the control of your Digital Receiver
- **TV** mode for the control of your TV set
- **VCR** mode for the control of your VCR
- **DVD** mode for the control of your DVD or DVD Recorder
- **AMP** mode for the control of your audio tuner/amplifier.

Press **SELECT** once to check which mode is active. To change the mode, press **SELECT** repeatedly until the desired mode is signalled by the corresponding indicator.

The mode sequence is:

STB --> TV --> VCR --> DVD --> AMP.

7.3.2 Volume and mute control assignment

Default volume and mute control assignment

For each mode, you can select the device of your audio/video set-up to which volume and mute control is assigned.

When in STB mode, the volume functions (**VOL+/-** and **MUTE** keys) can be controlled through your TV set, amplifier, or digital receiver. By default, volume control is performed through a Philips brand TV set.

When in TV, VCR or DVD mode, the volume functions (**VOL+/-** and **MUTE** keys) can be controlled through your TV set or amplifier. By default, volume control is performed through a Philips brand TV set.

When in AMP mode, the volume functions (**VOL+/-** and **MUTE** keys) can be controlled through a Philips brand amplifier only.

Changing the volume and mute control assignment

The procedures below assume you start from default settings.

Your Digital Receiver (STB), TV, VCR or DVD audio outputs are "all" connected to your amplifier. We advise you to assign volume control to your amplifier for all modes (STB, TV, VCR, and DVD).

To do so:

- 1 Press **SELECT** repeatedly to select the AMP mode.
- 2 Simultaneously press keys **1** and **3** until the AMP indicator turns on then release these keys.
- 3 Enter code 993. The indicator surrounding the key blinks once after each entry.
- 4 Press the **VOL-/+** key. The indicator surrounding the key blinks twice.

From then on, whatever mode you are in, the AMP indicator turns on each time you press one of the (**VOL+/-** and **MUTE** keys).

When controlling the volume, make sure the source selector of your amplifier is properly set (refer to your amplifier user manual for source selection).

Note

If your TV set is only fitted with SCART connectors (no HDMI, no DVI and no YPbPr), we advise you to assign volume control to your digital receiver for the STB mode.

To do so:

- 1 Press **SELECT** repeatedly to select the STB mode.
- 2 Simultaneously press keys 1 and 3 until the STB indicator turns on then release the keys.
- 3 Enter code 993. The indicator surrounding the key blinks once after each digit entry.
- 4 Press the **VOL-/+** key. The indicator surrounding the key blinks twice.

You have made several setting changes and you want to restore the default volume control assignment settings (see table in next paragraph)

Default volume control assignment means:

- in TV mode, volume control is performed through a Philips brand TV set
- in VCR mode, volume control is performed through a Philips brand TV set
- in DVD mode, volume control is performed through a Philips brand TV set
- in AMP mode, volume control is performed through a Philips brand amplifier only.

To restore default settings:

- 1 Simultaneously press keys 1 and 3 until the indicator surrounding the key blinks twice then release these keys.
- 2 Enter code 981. The indicator surrounding the key blinks twice.

7.3.3 Changing the brand setting of your remote control for your TV, VCR, DVD or Amplifier

By default at first power up or at first installation, your universal remote control is pre-set to control your Digital Receiver as well as most Philips brand audio/video devices. If you have other brands of devices, or if the presets do not enable you to control your Philips device, please follow the procedure below.

- 1 Choose one brand code, made up of 4 digits, from the code list at the end of this manual. (If several codes are possible, go through this procedure with the first code and try your remote control. If you are not successful, repeat the procedure with the second code, and so on).
- 2 Press the **SELECT** key repeatedly to choose the mode corresponding to the type of device you want to set up (TV, VCR, DVD or Amp/Tuner).
- 3 Simultaneously press digits 1 and 3 until the indicator surrounding the key blinks twice then release these keys.
- 4 Enter the 4 digit code corresponding to the device brand you have chosen. The indicator surrounding the key blinks once after each one of the first three entries. The indicator surrounding the key blinks twice after the fourth entry.

If an invalid code has been entered, the indicator surrounding the key blinks once only. Restart from step 1.

Notes

- If the battery change takes more than 1 minute the remote control may return to the Philips default settings. Therefore you have to proceed with a new setting of your remote control with the help of the table above for your non-Philips branded devices.
- All manufacturers are concerned about the constant improvement of their products. Although your remote control is compatible with most of the equipment of the following list, Philips cannot guarantee its operation with the complete range of products on the market

7.3.4 Using the universal remote control with your TV

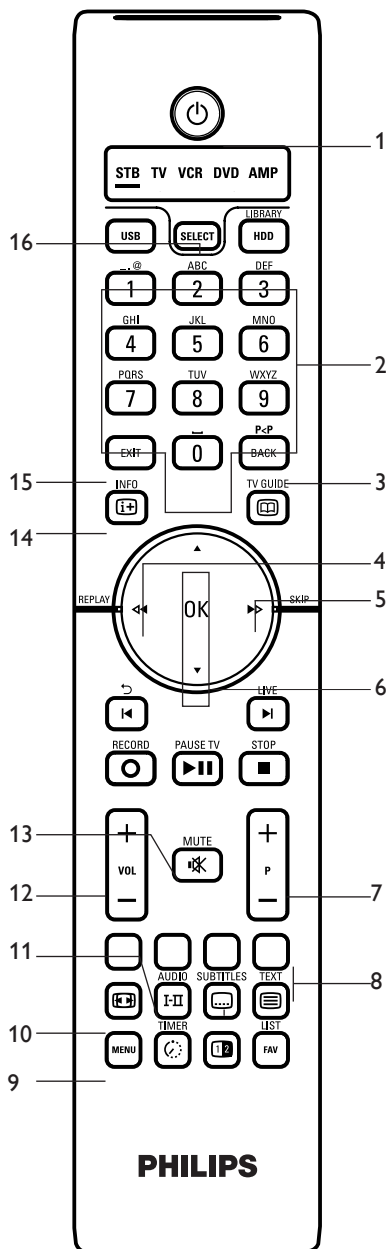

- 1 Standby
- 2 0-9 Channel selection
- 3 BACK Last channel recall
- 4 Change value of menu item option
- 5 Change value of menu item option
- 6 Item selection in menu /
OK Acknowledge of selection
- 7 P+/- Channel Up/Down
- 8 Colour keys Contextual keys in teletext
- 9 MENU Open/Close menu
- 10 Movie Expand /
TV display format
- 11 I-II Audio track selection
- 12 VOL+/- Volume Up/Down
- 13 Sound Mute
- 14 Open/close On Screen Display
- 15 EXIT Exit, menu off
- 16 SELECT Remote control Mode selection

See p25 for Digital Recorder Mode (STB)

7.3.5 Using the universal remote control with your VCR (VCR mode)

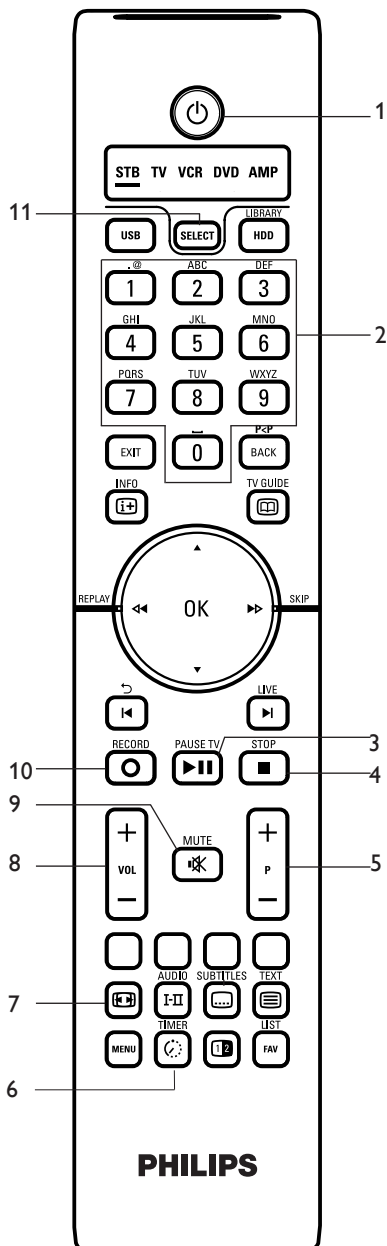

- | | | |
|----|---------|---|
| 1 | | Standby |
| 2 | | Channel selection |
| 3 | | Play/pause |
| 4 | | Stop |
| 5 | | Channel Up/Down |
| 6 | TIMER | Recording (Press TIMER + OK to start recording) |
| 7 | | Movie Expand |
| 8 | VOL +/- | Volume Up/Down |
| 9 | | Sound Mute |
| 10 | | Record |
| 11 | SELECT | Remote control Mode selection |

See p25 for Digital Recorder Mode (STB)

7.3.6 Using the universal remote control with your DVD player (DVD mode)

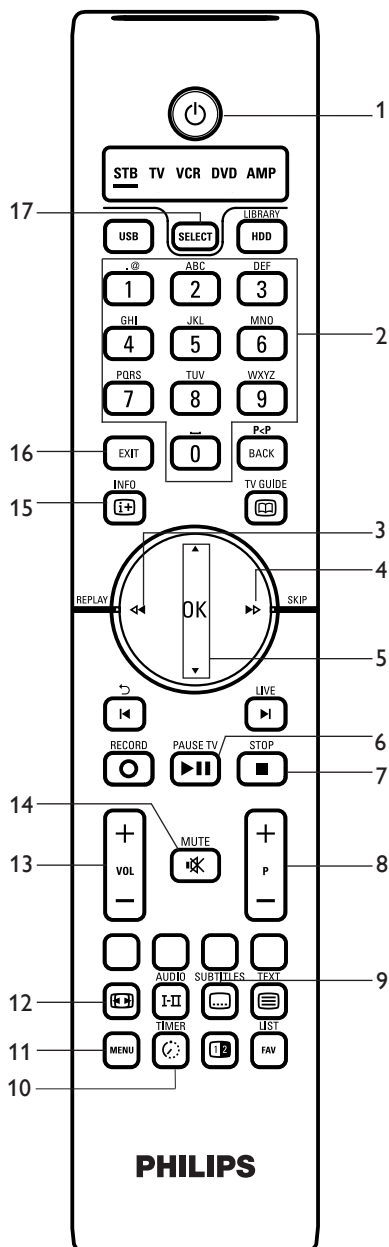

- | | | |
|----|--------|---|
| 1 | | Standby |
| 2 | 0-9 | Channel selection |
| 3 | | Change value of menu item option |
| 4 | | Change value of menu item option |
| 5 | | Item selection in menu / |
| | OK | Acknowledge of selection |
| 6 | | Play/pause |
| 7 | | Stop |
| 8 | P+/- | Channel Up/Down |
| 9 | | Subtitle selection |
| 10 | TIMER | Recording (Press TIMER + OK to start recording) |
| 11 | MENU | Open/Close menu |
| 12 | | Movie Expand / TV display format |
| 13 | VOL+/- | Volume Up/Down |
| 14 | | Sound Mute |
| 15 | | Open/close On Screen Display |
| 16 | EXIT | Exit, menu off |
| 17 | SELECT | Remote control Mode selection |

See p25 for Digital Recorder Mode (STB)

7.3.7 Using the universal remote control with your tuner/amplifier (AMP mode)

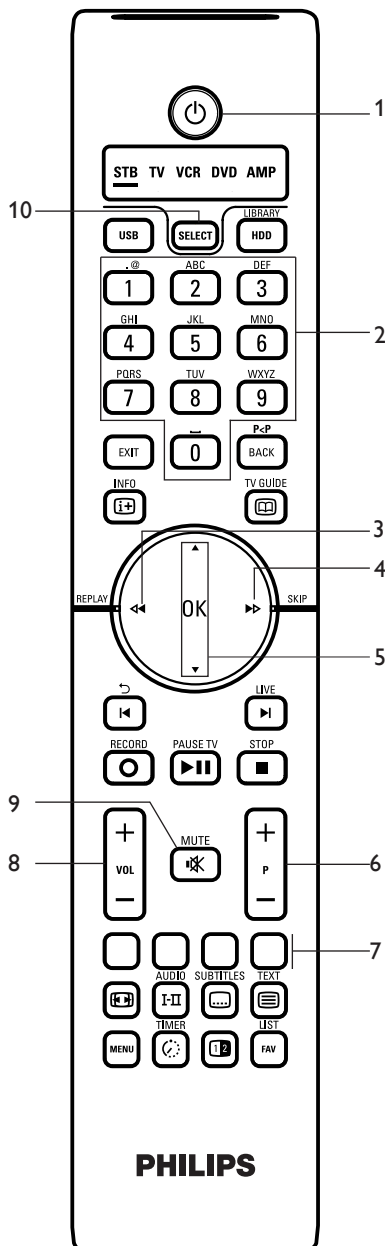

- | | | |
|----|-------------|---|
| 1 | | Standby |
| 2 | 0-9 | Channel selection |
| 3 | | Tuning Down |
| 4 | | Tuning Up |
| 5 | | Preset Up/Down |
| 6 | P+/- | Channel Up/Down |
| 7 | Colour keys | Red : Select SAT input
Green : Select TV input
Yellow : Select DVD input
Blue : Select tuner / amplifier input |
| 8 | VOL+/- | Volume Up/Down |
| 9 | | Sound Mute |
| 10 | SELECT | Remote control Mode selection |

See p25 for Digital Recorder Mode (STB)

8 Guarantee and service

For the Philips warranty applicable to this product, we refer you to the Philips website www.philips.com/guarantee. In the event you do not have an Internet connection, please contact your local Philips Consumer Care Centre. Contact details are given in the Contact information chapter of this manual.

9 Technical data

This product is in conformity with European 95/47/EC and 2002/21/EC directives. The product complies with the following European council Directives: 2006/95/EEC and 89/336/EEC.

Tuner/Reception/Transmission

- DVB: Terrestrial
- Demodulation type: COFDM 2K/8K, MPEG-2 DVB compliant, Network: MFN/SFN, QAM, QPSK
- Input frequency range: 474-862 MHz
- Number of TV tuners: 2

Video Recording

- Recording enhancements: One Touch Record (OTR), split event, series recording, accuracy

Storage Media

- Hard Disk Capacity: 160 GB
- HDD video recording capacity: 78 hrs
- HDD recording enhancements: Instant Replay, Pause Live TV, Time Shift Buffer, Hard Disk Space Used, Hard Disk Space Free
- Extra Hard Disk Technology: Simultaneous Record & Playback
- HDD Type: 3.5" HDD

Connectivity

- Terrestrial antenna interface: RF in, IEC 169-2, RF out, (bypass) IEC 169-2
- Video Output - Digital: HDMI
- TV scart out: Audio L/R, CVBS, RGB
- VCR scart out: Audio L/R, CVBS
- Audio Output - Analog: Audio L/R (cinch)
- Audio Output - Digital: Coaxial (cinch)
- USB: USB 2.0

Convenience

- Child Protection: Child Lock+Parental Control
- Convenience Enhancements: Electronic Programming Guide, Automatic Overheat Warning, On-screen Display
- Ease of Installation: Autoinstall
- Events timer/reminder: 20
- Favorite list radio programs: 4
- Favorite list TV programs: 4
- Parental control: Lock with PIN code, Child timer
- Programmable Events: 32
- Recording: Record failure alarm, Record header message
- Signal strength indication
- User Interface: 8 days Electronic program Guide, Automatic program list update, Multiple subtitles supported, Now & Next ESG, On Screen Display on TV, Software upgrade over the air, TV and Radio mode

Still Picture Playback

- Picture compression format: JPEG
- Playback Media: USB flash drive

Video Decoding

- Compression Format: MPEG-2 MP@HL (high definition), MPEG-2 MP@ML (std definition)
- Conditional access system: Mediaguard (card not supplied)
- De-scrambling: Smart Card reader
- Resolution: up to 1920 x 1080 interlaced
- Aspect Ratio: 16:9, 4:3 Letterbox, 4:3 Pan Scan
- Video bitrate: Up to 15 Mbit/s

Audio Decoding

- Compression format: Dolby Digital, MPEG layer I/II, MP3
- Sound system: Dolby Digital, Dolby Digital downmixed to stereo, Stereo

System Specifications

- CPU speed: 240 MHz
- Flash memory size: 16 MB
- Ram size: 64 MB

Power

- Mains power: 230 V
- Power consumption: < 23 W
- Standby power consumption: < 12 W

Dimensions

- Carton dimensions (WxDxH): 320x245x65mm
- Product dimensions (WxHxD): 240x44x145mm
- Temperature (storage): -20° to 60° Celsius
- Weight: 0.98 kg
- Weight incl. packaging: 1 780 kg
- Temperature (operation) 5° to 35° Celsius

Accessories

- Included Accessories: AC power cord, SCART cable, Remote Control, User Manual, Quick start guide
- Batteries: 2x AA

Due to continued improvements, this information is subject to change without notice.

10 Frequently asked questions

Connection

On-screen display working but there is no reception

Check the installation and see retune page 11.

Intermittent reception

Check all connections and cables

Aerial could also be the root cause of issues.

The picture is not sharp and on-screen text is difficult to read

- Change the **TV scart output** setting to RGB from the System settings screen
- Refer to your TV user manual
- Use the SCART cable supplied with the Digital Terrestrial Receiver

What is HDMI?

High-Definition Multimedia Interface (HDMI) is a high-speed digital interface that can transmit uncompressed high definition video and digital multi channel audio. It delivers perfect picture and sound quality, completely free from noise. HDMI is fully backward compatible with DVI

Why does it take so long to display the contents of my USB device?

- This could be due to the large number of files (>500 files/folders) or size of the files (>1MB)
- There could be other non-supported files in the device that the system is trying to read/display
- File system must be FAT16 or FAT32
- Device must be USB 2.0

No sound Nor picture but the front panel LED is lit in red

Press  on the front panel.

Set-up

The LED on the front panel does not light up after 5 seconds.

- Check that the power cord is correctly connected. Disconnect this cord and reconnect it to ensure it is in place
- Check that power is available at the wall socket

No sound or picture but the front panel LED is blinking green

Press the red-coloured key, and then enter your PIN Code to disable protection.

The remote control does not operate the Digital Terrestrial Receiver

- Press stop button to verify if you are not in playback
- Make sure the Digital Terrestrial Receiver is on STB: press Select button, the STB must be highlighted on the small screen of the remote. If no target is highlighted check the batteries, press Select again to highlight STB.
- Make sure you are pointing your remote control at the front panel of the Digital Terrestrial Receiver

You cannot find all the channels you think should be available.

Try re-tuning the Digital Terrestrial Receiver, following the relevant steps in chapter Install. Check in the 800 range.

If you are still missing channels, call your customer service adviser.

Even if you use the numerical keys, you cannot access a particular channel.

Enter your PIN Code to access the channel or unlock it. The default PIN Code is 0000.

You set a recording but did not record what you wanted.

Make sure that your recorder did not get more than two records to do at the same time.

You set a recording but did not record what you wanted.

Press Timer to check if an alternate instance was selected because of conflicts.

You have forgotten your PIN Code

When prompted for your PIN Code, enter the Master PIN Code. This will allow you to proceed as well as reset the current PIN Code to its default value (default is 0000). The Master PIN Code is 3001. Keep this code secret to prevent others from using it.

What are Titles and Chapters?

A recorded movie contains titles and chapters, which are similar to the titles and chapters of a book. A title is often a complete movie and is split into chapters, or individual scenes from the movies.

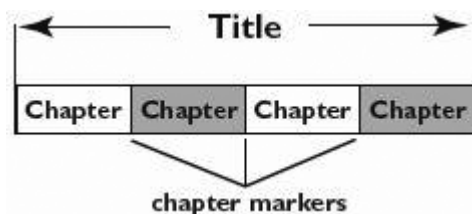

Programmes are recorded as a single title. They may consist of one chapter or a few chapters within a title, depending on the recording settings.

How do I set up titles and chapters?

The Digital Terrestrial Receiver will automatically create a new title every time you start a new recording.

The HDD doesn't respond but the power is on

Check if HDD is enabled.

Unplug the recorder from the mains. wait for 10 minutes, power on again.

If the problem persist, call your retailer.

Installation

No sound or picture but the front panel LED is lit in green

- Check the connections at the wall socket and Digital Terrestrial Receiver
- Check the EXT1 TO TV SCART connection, or the HDMI connection

The picture on some channels seems to have been stretched or squashed.

Check the Digital Terrestrial Receiver TV shape setting, following the information in paragraph Watching preferences. If you have a wide screen TV, you may also need to check the settings on your TV. The display format being managed by the Digital Terrestrial Receiver, set your TV to "full screen" or to the similar equivalent setting (refer to the user manual of your TV set).

The order of the channels has changed.

Refer to paragraph Sort the selected list: to change the order again.

❗ If you have tried all of the actions suggested above and could not solve the problem, contact your customer service adviser.

The message Overheating is displayed on the front panel

- Unplug the Digital Terrestrial Receiver from the mains to cool it down.
- Make sure that it is placed on a firm surface, with the ventilation openings not covered with items such as newspapers, table clothes, curtains, etc.
- Make sure that the heat could be evacuated: the receiver must not be included in a close cabinet
- If the problem persists, contact your local Philips Consumer Care Centre

11 Glossary

A

Analogue audio

Sound that has not been turned into numbers. Analogue sound is available from the LEFT/RIGHT AUDIO outputs. The red and white sockets send audio through two channels, the left and right.

Aspect ratio

Aspect ratio refers to the length to height ratio of TV screens. The ratio of a standard TV is 4:3, while the ratio of a high-definition or wide TV is 16:9. The letterbox format allows you to enjoy a picture with a wider perspective on a standard 4:3 screen.

D

Delay

The time difference between a sonic event and its perception at the listening position. Use the Lip Synchronization feature to cancel the delay.

De-scrambling/scrambled

Many TV channels are scrambled. To de-scramble them you need specific smart cards provided by different pay-TV providers.

Digital audio

Sound signal that has been converted into numerical values. Digital sound is available when you use the DIGITAL AUDIO OUT COAXIAL. These sockets send audio through multiple channels, instead of just two channels as analogue does. Volume and mute are managed by audio equipment.

Dolby Digital

A surround sound system developed by Dolby Laboratories containing up to six channels of digital audio (front left and right, surround left and right, centre and subwoofer). Volume and mute are managed by audio equipment.

DVB

Digital Video Broadcasting

E

EPG

Electronic Programme Guide

H

HDD

Hard Disk Drive

HDMI

HDMI is a standard for video interfacing; it can convey a massive amount of digital data. It means it can easily support all HDTV standards.

HDTV

High-Definition Television

J

JPEG

A very common digital still picture format. A still-picture data compression system proposed by the Joint Photographic Expert Group, which features small decrease in image quality in spite of its high compression ratio. Files are recognized by their file extension "JPG" or "JPEG".

L

Lip Synchronization

Setting used to synchronize sound and pictures in case a delay is experienced, in particular if the sound of speech does not match lip movements.

M

MP3

A file format with a sound data compression system. "MP3" is the abbreviation of Motion Picture Experts Group 1 (or MPEG-1) Audio Layer 3. By using the MP3 format, one CD-R or CD-RW can contain about 10 times more data than a regular CD. Files are recognized by their file extension ".mp3".

MPEG

Motion Picture Experts Group. A collection of compression systems for digital audio and video.

P

PaP

Picture and Picture

PiP

Picture in Picture

PIN Code

4-digit code used to prevent access to inappropriate programmes (parental control).

S

SCART Loop-through

Function allowing automatic signal by-pass for playback from a VCR or DVD player/recorder connected to SCART EXT2.

SDTV

Standard Definition Television.

Smart Card

Card to be inserted into the Common Interface. It is provided by the pay-TV provider whom you took out a subscription.

Surround

A system for creating three dimension sound fields full of realism by arranging multiple speakers around the listener.

U

USB key

Small size storage device. It is used to store all types of computer files. A USB key can be connected to the USB port located on the front panel of the Digital Terrestrial Receiver.

12 Index

- C**
 - Connect
 - basic connection, 10
 - Consult the TV Guide, 15
 - Control Live TV, 16
 - Control Volume, 14
- F**
 - Favorite lists
 - Rename a favorite list, 27
 - Sort a favorite list, 28
 - Front display
 - Interpret front display messages, 22
 - Interpret front display pictograms, 21
- H**
 - HDD titles
 - Playback from HDD library, 19
- I**
 - Install
 - First installation, 10
 - Search failure, 11
- P**
 - Pause live TV, 15
 - Playback
 - Playback from HDD library, 19
 - Playback from USB, 19
- R**
 - Record, 17
 - Remote control
 - Use the remote control, 23
 - Retune 11
- S**
 - Select a channel, 13
 - Set programme options, 14
- U**
 - Use channel lists, 13
 - Use the time shift bar, 16
- V**
 - View channel/program info, 14
- W**
 - Wake-up the Digital Video Recorder, 13
 - Watch 2 channels at the same time, 15
 - Watch previously broadcast programs, 17

13 Remote control brand code list

13.1 Setup Code For All TVs

Akai	0036, 0062, 0087, 0099, 0190, 0205, 0235, 0243, 0244, 0245, 0291, 0388, 0398, 0404, 0439, 0460, 0500, 0507, 0543, 0575, 0583, 0608, 0629, 0633, 0658, 0675, 0741, 0742, 0772, 0839, 1564	Hitachi	0036, 0062, 0063, 0071, 0099, 0129, 0132, 0135, 0136, 0184, 0190, 0205, 0221, 0244, 0309, 0383, 0390, 0500, 0507, 0508, 0519, 0526, 0535, 0543, 0575, 0605, 0656, 0661, 0746, 0751, 0771, 0911, 1064, 1072, 1164, 1197, 1252, 1508, 1603
Bang & Olufsen	0114, 0592	Hoher	0741, 0892
Beko	0222, 0319, 0397, 0445, 0513, 0633, 0741, 0742, 0835, 1064	InFocus	0779
BenQ	1783	JVC	0063, 0097, 0120, 0220, 0245, 0398, 0445, 0535, 0633, 0677, 0680, 0710
Daewoo	0036, 0063, 0135, 0136, 0197, 0205, 0244, 0245, 0291, 0401, 0478, 0526, 0583, 0661, 0688, 0892, 0907, 1782, 1783, 1936	LG	0087, 0135, 0205, 0583, 0671, 0741, 0742, 1175, 1664
Dell	1481	Loewe	0114, 0319, 0539, 0543, 0660, 0682
Emerson	0039, 0063, 0071, 0072, 0097, 0100, 0114, 0129, 0197, 0204, 0205, 0221, 0222, 0274, 0309, 0347, 0388, 0397, 0398, 0478, 0513, 0695, 0741, 1936	Logik	0036, 0038, 0087, 0099, 0220, 0398, 0907
Ferguson	0100, 0136, 0220, 0222, 0265, 0314, 0362, 0470, 0575, 0587, 0652, 1064	Magnavox	0062, 0063, 0087, 0309, 0462, 0733, 1481, 1782
Firstline	0036, 0099, 0235, 0243, 0244, 0262, 0265, 0274, 0348, 0388, 0401, 0438, 0558, 0571, 0583, 0695, 0741, 0835, 1064	Matsui	0036, 0038, 0062, 0063, 0099, 0190, 0204, 0222, 0235, 0243, 0244, 0262, 0362, 0379, 0382, 0383, 0390, 0398, 0460, 0470, 0482, 0514, 0543, 0571, 0583, 0606, 0656, 0741, 1064
Funai	0291, 0695	Metronic	0652
Goodmans	0036, 0038, 0062, 0063, 0099, 0243, 0244, 0245, 0262, 0265, 0291, 0362, 0398, 0401, 0507, 0514, 0526, 0543, 0583, 0587, 0606, 0614, 0657, 0661, 0688, 0695, 0741, 0835, 0907, 1064, 1190, 1927, 1936	NEC	0036, 0038, 0063, 0197, 0205, 0244, 0272, 0291, 0347, 0401, 0439, 0482, 0526, 0535, 0614, 0688, 0731, 0732, 1197, 1297, 1731
Grundig	0036, 0063, 0097, 0190, 0222, 0470, 0514, 0562, 0583, 0614, 0657, 0710, 0733	Nokia	0190, 0235, 0347, 0366, 0373, 0388, 0401, 0500, 0507, 0575, 0633, 0637, 0658
		Orion	0038, 0204, 0205, 0262, 0291, 0347, 0348, 0382, 0439, 0470, 0543, 0558, 0571, 0583, 0682, 0741, 0907, 1935, 1943
		Panasonic	0062, 0099, 0135, 0190, 0220, 0235, 0253, 0388, 0394, 0450, 0535, 0543, 0575, 0677, 0880, 1337, 1677

Philips 0036, 0039, 0072, 0114, 0135
0205, 0220, 0265, 0388, 0401
0450, 0539, 0583, 0632, 0799
1481, 1783

Pioneer 0038, 0136, 0190, 0193, 0197
0314, 0388, 0450, 0513, 0539
0787

Proline 0099, 0100, 0348, 0438, 0648
0652, 0657, 0661, 1064

Sagem 0482, 0637, 0645

Samsung 0036, 0062, 0063, 0072, 0087
0099, 0120, 0190, 0205, 0235
0243, 0244, 0253, 0291, 0317
0389, 0397, 0398, 0509, 0583
0614, 0645, 0671, 0709, 0745
0839

Sanyo 0038, 0063, 0072, 0099, 0131
0132, 0135, 0184, 0197, 0235
0243, 0244, 0291, 0366, 0397
0439, 0535, 0571, 0582, 0731
1782

Schneider 0039, 0097, 0190, 0244, 0245
0274, 0286, 0379, 0388, 0398
0421, 0571, 0583, 0675, 0695
0741, 1064, 1164

Sharp 0036, 0063, 0120, 0184, 0220
0283, 0518, 0543, 0677, 0695
0845, 1190, 1220

Siemens 0184, 0220, 0222, 0562

Sony 0038, 0063, 0120, 0129, 0184
0197, 0220, 0380, 0390, 0677
0861, 1532, 1678

TCL 0439, 0733, 1564

Technics 0253, 0583, 0677

Telefunken 0100, 0136, 0314, 0362, 0373
0513, 0525, 0587, 0614, 0652
0741

Thomson 0136, 0314, 0362, 0587, 0652

Toshiba 0036, 0038, 0062, 0063, 0072
0087, 0097, 0120, 0129, 0136
0193, 0222, 0244, 0291, 0439
0450, 0535, 0645, 0671, 0677
0741, 0745, 1190, 1535, 1731

Vestel 0244, 0583, 0695, 1064, 1190

Viewsonic 0751, 1782

13.2 Setup Code For All VCRs

Aiwa 0027, 0059, 0064, 0334, 0375
0379, 0769, 1164

Akai 0047, 0064, 0068, 0133, 0267
0342, 0375, 0379, 0669

Alba 0027, 0047, 0099, 0108, 0305
0342, 0375, 0379

Aristona 0108, 0173

Daewoo 0047, 0064, 0072, 0131, 0305
0379, 0664, 0669, 0871, 1164

Denon 0069, 0108

Emerson 0027, 0064, 0070, 0072, 0099
0267, 0305, 0375, 0620, 0664

Ferguson 0027, 0068, 0193, 0305, 0347
0348

Firstline 0064, 0070, 0072, 0099, 0305
0375, 0507, 1164

Funai 0027, 0064, 0099, 0305, 0620

Goldstar 0027, 0064, 0065, 0253, 0305
0507, 1164

Grundig 0061, 0099, 0108, 0253, 0347
0374, 0375, 0376, 0379, 0769

Hitachi 0027, 0064, 0068, 0069, 0072
0108, 0193, 0267, 0620

JVC 0068, 0072, 0094, 0108, 0411

Kenwood 0065, 0068, 0094, 0411

LG 0064, 0065, 0069, 0072, 0267
0507, 1164

Loewe 0064, 0108, 1589

Magnavox 0027, 0064, 0075, 0108, 0253,
0267, 0620, 0669

Matsui 0064, 0267, 0305, 0375, 0376
0379, 0769

Metronic 0108,

NEC 0064, 0065, 0068, 0075, 0094
0131, 0305, 1164

Nokia 0068, 0069, 0075, 0108, 0131
0133, 0267, 0305, 0342, 0579

Panasonic 0027, 0047, 0253, 0863, 0864
1589

Philips 0027, 0061, 0072, 0075, 0108
0173, 0253, 0411, 0620, 1296

Pioneer 0069, 0094, 0108, 1830

Proline 0027, 0305, 0347, 0669

Pye	0027, 0108
Radiola	0108
Samsung	0027, 0065, 0072, 0267, 0459 0647
Sanyo	0027, 0074, 0075, 0094, 0131 0267, 0375, 1164
Schneider	0027, 0064, 0069, 0099, 0108 0173, 0267, 0305, 0375, 0379 0669, 0924, 1164
Sharp	0027, 0059, 0064, 0074, 0075 0596
Siemens	0064, 0108, 0131, 0173, 0347 0374
Sony	0027, 0059, 0061, 0074, 0075 0094, 0133, 0253, 1059
Technics	0027, 0064, 0108, 0253
Telefunken	0068, 0305, 0347, 0348, 0411 0521, 0620, 0669
Thomson	0068, 0094, 0305, 0347, 0348 0411, 0521, 0749
Toshiba	0027, 0068, 0069, 0070, 0072 0094, 0108, 0267, 0379, 0411 0459, 0769

13.3	Setup Code for All Digital Video Disks
Aiwa	0560, 0668, 1163, 1270
Alba	0566, 0699, 0722, 0726, 0740 0744, 0757, 0810, 1078, 1167 1722
Bang & Olufsen	1052
BenQ	1263
Daewoo	0732, 0741, 0797, 0811, 0859 0860, 0896, 0897, 0899, 1196 1933, 1945
Denon	0517, 0661, 1661
Emerson	0618, 0702, 0732
Ferguson	0678, 0722, 0925, 1722, 1757
Firstline	0678, 0740, 0826, 0870, 0896
Funai	0702, 0722
Goodmans	0678, 0717, 0740, 0750, 0757 0810, 0817, 0860, 0906, 1031 1167, 1248, 1281, 1757, 1950 2034, 2041
Grundig	0566, 0578, 0678, 0697, 0713 0722, 0728, 0732, 0740, 0802 0817, 1031, 1063, 1722, 1757 1947, 2073
Hitachi	0600, 0691, 0692, 0722, 0740 0884, 1946, 1947, 2021
Hoher	0678, 0740, 0853, 0858, 1031 1251
Humax	0673
JVC	0530, 0566, 0650, 0894, 1191 1928, 1967
Kenwood	0517, 0561, 0764, 1090
Kiss	0692, 0868, 2030
LG	0618, 0768, 0774, 0817, 0896 1933, 2010, 2029
LiteOn	1085, 1185, 1188
Loewe	0566, 0768, 0912
Magnavox	0530, 0566, 0673, 0702, 0740 0912, 1167
Marantz	0530, 0566, 0702
Matsui	0678, 0699, 0722, 0740, 1031 1722, 1757
Metronic	0717
Mustek	0757, 1757, 1944
Nakamichi	1226, 1249

Onkyo	0530, 0654, 1639, 2012
Packard Bell	0858
Panasonic	0517, 0530, 0598, 1037, 1932 1935
Philips	0530, 0566, 0673, 0702, 0912 1185, 1839, 1840, 1938
Pioneer	0517, 0552, 0598, 0658, 1838 1927, 1992
Proline	0678, 0699, 0713, 0737, 0860 1031, 1942
Pye	0673
Samsung	0517, 0600, 0771, 0847, 1102 1955, 1959, 2035
Schneider	0566, 0678, 0732, 0740, 0806 0810, 0815, 0817, 0858, 0896 1128, 1180
Sharp	0657, 0702, 0740, 0779, 2042
Sony	0560, 0600, 0799, 0891, 1097 1122, 1160, 1560, 1660, 1930 1960, 2008
Teac	0543, 0598, 0719, 0722, 0744 0768, 0786, 0795, 0817, 0860 1033, 1224, 1254, 1956, 1957 1962, 2011
Technics	0517, 1932
Telefunken	0816, 0817, 0860, 1110, 1255
Thomson	0549, 0578
Toshiba	0530, 0566, 0600, 0722, 1072 2033
Yamaha	0517, 0566, 0673
Yukai	0757, 1757, 1944

13.4 Setup Code for All Audio AMP/ Tuners

Bang & Olufsen	0826
Bose	1382
Cambridge Audio	1674
Denon	0148, 1131, 1387, 1487
Harmon Kardon	1316, 1331, 1337
Hoher	1284
JBL	1317
JVC	0101, 0491, 1226, 1227, 1401 1522
Kenwood	0213, 0739, 1054, 1308, 1340 1596, 1597
Koss	0771
LG	1320, 1551
Magnavox	1296
Marantz	0771, 1296, 1316
Matsui	0771, 0774, 0824
NAD	0347, 0636
Nakamichi	1340
Onkyo	1325, 1347, 1558
Panasonic	1315, 1335, 1545, 1790
Philips	1296, 1316, 1742
Pioneer	0213, 0316, 1050, 1211, 1311 1486, 1683
Samsung	1226, 1308, 1322, 1331, 1451
Sony	0820, 1185, 1285, 1468, 1481 1585, 1685, 1785, 1786, 1885
Teac	0490, 0636, 0680, 0771, 0774 0781, 0824, 1205, 1226, 1253 1298, 1306, 1308, 1417, 1452 1490, 1506, 1555
Technics	0235, 1335, 1336, 1545, 1790
Telefunken	1417
Thomson	1181, 1381
Toshiba	1599
Yamaha	0203, 0213, 0739, 1050, 1303 1358

13.5 Setup Code for All Audio Amplifiers (A)

Pioneer	0327
Sony	0716
Teac	1301
Telefunken	1357
Thomson	1156
Yamaha	0381

Contact information



DTR 7510

Serial number:

UNITED KINGDOM

Philips CE, The Philips Centre,
Surrey

Phone: 0870 900 9070 (ps tn)

Trademarks and partner logos

The Philips wordmark and the Philips shield are registered trademarks of Koninklijke Philips Electronics N.V. and are used by Pace plc under license from Koninklijke Philips Electronics N.V.



Be responsible
Respect copyrights



Manufactured under license from Dolby Laboratories.

“Dolby” and the double-D symbol are trademarks of Dolby Laboratories.



HDMI, and HDMI logo and High-Definition Multimedia Interface are trademarks or registered trademarks of HDMI licensing LLC.



Trademark of the DVB Digital Video Broadcasting Project (1991 to 1996)



100% recycled paper

100% papier recyclé



© 2009 Koninklijke Philips Electronics N.V.
All rights reserved.
Document order number: 3111 176 53842

Free Manuals Download Website

<http://myh66.com>

<http://usermanuals.us>

<http://www.somanuals.com>

<http://www.4manuals.cc>

<http://www.manual-lib.com>

<http://www.404manual.com>

<http://www.luxmanual.com>

<http://aubethermostatmanual.com>

Golf course search by state

<http://golfingnear.com>

Email search by domain

<http://emailbydomain.com>

Auto manuals search

<http://auto.somanuals.com>

TV manuals search

<http://tv.somanuals.com>