

General
Magnetoresistive sensors for
magnetic field measurement

2000 Sep 06

Magnetoresistive sensors for magnetic field measurement

General

CONTENTS

General field measurement

- Operating principles
- Philips magnetoresistive sensors
- Flipping
- Effect of temperature on behaviour
- Using magnetoresistive sensors
- Further information for advanced users
- Appendix 1: The magnetoresistive effect
- Appendix 2: Sensor flipping
- Appendix 3: Sensor layout.

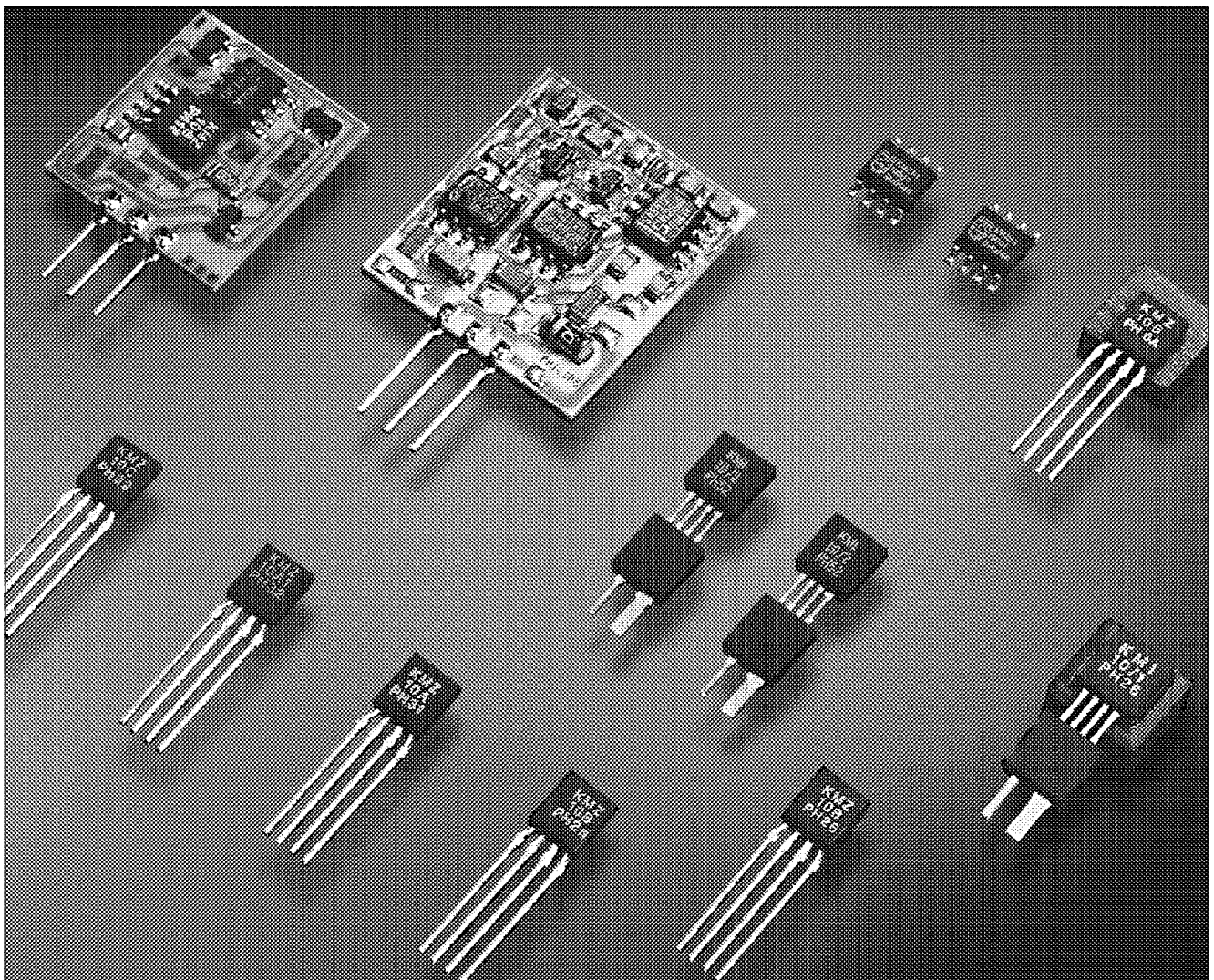

Magnetoresistive sensors for magnetic field measurement

General

The KMZ range of magnetoresistive sensors is characterized by high sensitivity in the detection of magnetic fields, a wide operating temperature range, a low and stable offset and low sensitivity to mechanical stress. They therefore provide an excellent means of measuring both linear and angular displacement under extreme environmental conditions, because their very high sensitivity means that a fairly small movement of actuating components in, for example, cars or machinery (gear wheels, metal rods, cogs, cams, etc.) can create measurable changes in magnetic field. Other applications for magnetoresistive sensors include rotational speed measurement and current measurement.

Examples where their properties can be put to good effect can be found in automotive applications, such as wheel speed sensors for ABS and motor management systems and position sensors for chassis position, throttle and pedal position measurement. Other examples include instrumentation and control equipment, which often require position sensors capable of detecting displacements in the region of tenths of a millimetre (or even less), and in electronic ignition systems, which must be able to determine the angular position of an internal combustion engine with great accuracy.

Finally, because of their high sensitivity, magnetoresistive sensors can measure very weak magnetic fields and are thus ideal for application in electronic compasses, earth field correction and traffic detection.

If the KMZ sensors are to be used to maximum advantage, however, it is important to have a clear understanding of their operating principles and characteristics, and how their behaviour may be affected by external influences and by their magnetic history.

Operating principles

Magnetoresistive (MR) sensors make use of the magnetoresistive effect, the property of a current-carrying magnetic material to change its resistivity in the presence of an external magnetic field (the common units used for magnetic fields are given in Table 1).

Table 1 Common magnetic units

1 kA/m = 1.25 mTesla (in air)
1 mT = 10 Gauss

The basic operating principle of an MR sensor is shown in Fig.2.

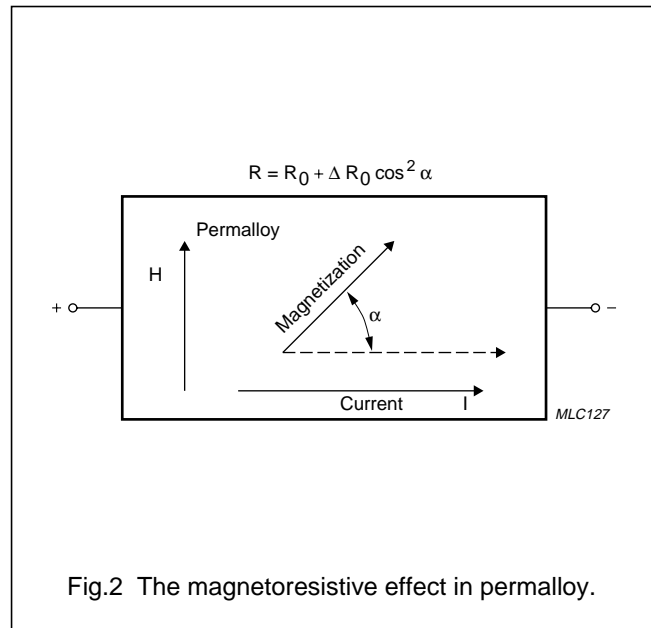

Fig.2 The magnetoresistive effect in permalloy.

Figure 2 shows a strip of ferromagnetic material, called permalloy (19% Fe, 81% Ni). Assume that, when no external magnetic field is present, the permalloy has an internal magnetization vector parallel to the current flow (shown to flow through the permalloy from left to right). If an external magnetic field H is applied, parallel to the plane of the permalloy but perpendicular to the current flow, the internal magnetization vector of the permalloy will rotate around an angle alpha. As a result, the resistance of R of the permalloy will change as a function of the rotation angle alpha, as given by:

$$R = R_0 + \Delta R_0 \cos^2 \alpha \tag{1}$$

R₀ and ΔR₀ are material parameters and to achieve optimum sensor characteristics Philips use Fe19Ni81, which has a high R₀ value and low magnetostriction. With this material, ΔR₀ is of the order of 3%. For more information on materials, see Appendix 1.

It is obvious from this quadratic equation, that the resistance/magnetic field characteristic is non-linear and in addition, each value of R is not necessarily associated with a unique value of H (see Fig.3). For more details on the essentials of the magnetoresistive effect, please refer to the Section "Further information for advanced users" later in this chapter or Appendix 1, which examines the MR effect in detail.

Magnetoresistive sensors for magnetic field measurement

General

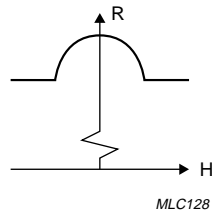

Fig.3 The resistance of the permalloy as a function of the external field.

In this basic form, the MR effect can be used effectively for angular measurement and some rotational speed measurements, which do not require linearization of the sensor characteristic.

In the KMZ series of sensors, four permalloy strips are arranged in a meander fashion on the silicon (Fig.4 shows one example, of the pattern on a KMZ10). They are connected in a Wheatstone bridge configuration, which has a number of advantages:

- Reduction of temperature drift
- Doubling of the signal output
- The sensor can be aligned at the factory.

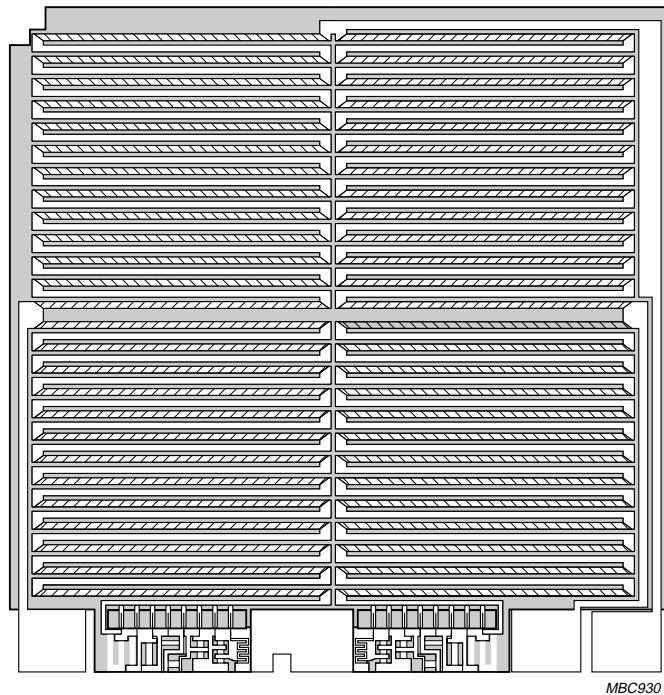

Fig.4 KMZ10 chip structure.

Magnetoresistive sensors for magnetic field measurement

General

Two further resistors, R_T , are included, as shown in Fig.5. These are for trimming sensor offset down to (almost) zero during the production process.

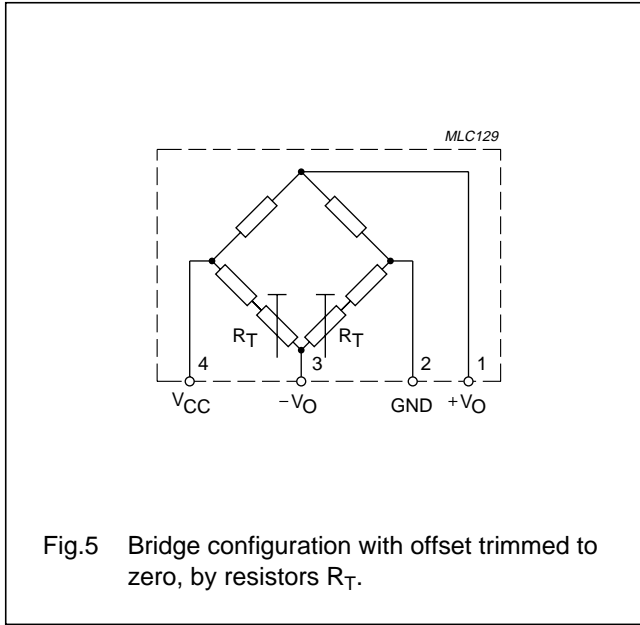

Fig.5 Bridge configuration with offset trimmed to zero, by resistors R_T .

For some applications however, the MR effect can be used to its best advantage when the sensor output characteristic has been linearized. These applications include:

- Weak field measurements, such as compass applications and traffic detection;
- Current measurement; and
- Rotational speed measurement.

For an explanation of how the characteristic is linearized, please refer to the Section “Further information for advanced users” later in this chapter.

Philips magnetoresistive sensors

Based on the principles described, Philips has a family of basic magnetoresistive sensors. The main characteristics of the KMZ sensors are given in Table 2.

Table 2 Main characteristics of Philips sensors

SENSOR TYPE	PACKAGE	FIELD RANGE (kA/m) ⁽¹⁾	V _{CC} (V)	SENSITIVITY (mV/V) / (kA/m)	R _{bridge} (kΩ)	LINEARIZE MR EFFECT	APPLICATION EXAMPLES
KMZ10A	SOT195	-0.5 to +0.5	≤9	16.0	1.2	Yes	compass, navigation, metal detection, traffic control
KMZ10A1 ⁽²⁾	SOT195	-0.05 to +0.05	≤9	22.0	1.3	Yes	
KMZ10B	SOT195	-2.0 to +2.0	≤12	4.0	2.1	Yes	current measurement, angular and linear position, reference mark detection, wheel speed
KMZ10C	SOT195	-7.5 to +7.5	≤10	1.5	1.4	Yes	
KMZ51	SO8	-0.2 to +0.2	≤8	16.0	2.0	Yes	compass, navigation, metal detection, traffic control
KMZ52	SO16	-0.2 to +0.2	≤8	16.0	2.0	Yes	

Notes

1. In air, 1 kA/m corresponds to 1.25 mT.
2. Data given for operation with switched auxiliary field.

Magnetoresistive sensors for magnetic field measurement

General

Flipping

The internal magnetization of the sensor strips has two stable positions. So, if for any reason the sensor is influenced by a powerful magnetic field opposing the internal aligning field, the magnetization may flip from one position to the other, and the strips become magnetized in the opposite direction (from, for example, the '+x' to the '-x' direction). As demonstrated in Fig.6, this can lead to drastic changes in sensor characteristics.

The field (e.g. '-H_x') needed to flip the sensor magnetization, and hence the characteristic, depends on the magnitude of the transverse field 'H_y': the greater the field 'H_y', the smaller the field '-H_x'. This follows naturally, since the greater the field 'H_y', the closer the magnetization's rotation approaches 90°, and hence the easier it will be to flip it into a corresponding stable position in the '-x' direction.

Looking at the curve in Fig.7 where H_y = 0.5 kA/m, for such a low transverse field the sensor characteristic is stable for all positive values of H_x and a reverse field of ≈1 kA/m is required before flipping occurs. At H_y = 2 kA/m however, the sensor will flip even at smaller values of 'H_x' (at approximately 0.5 kA/m).

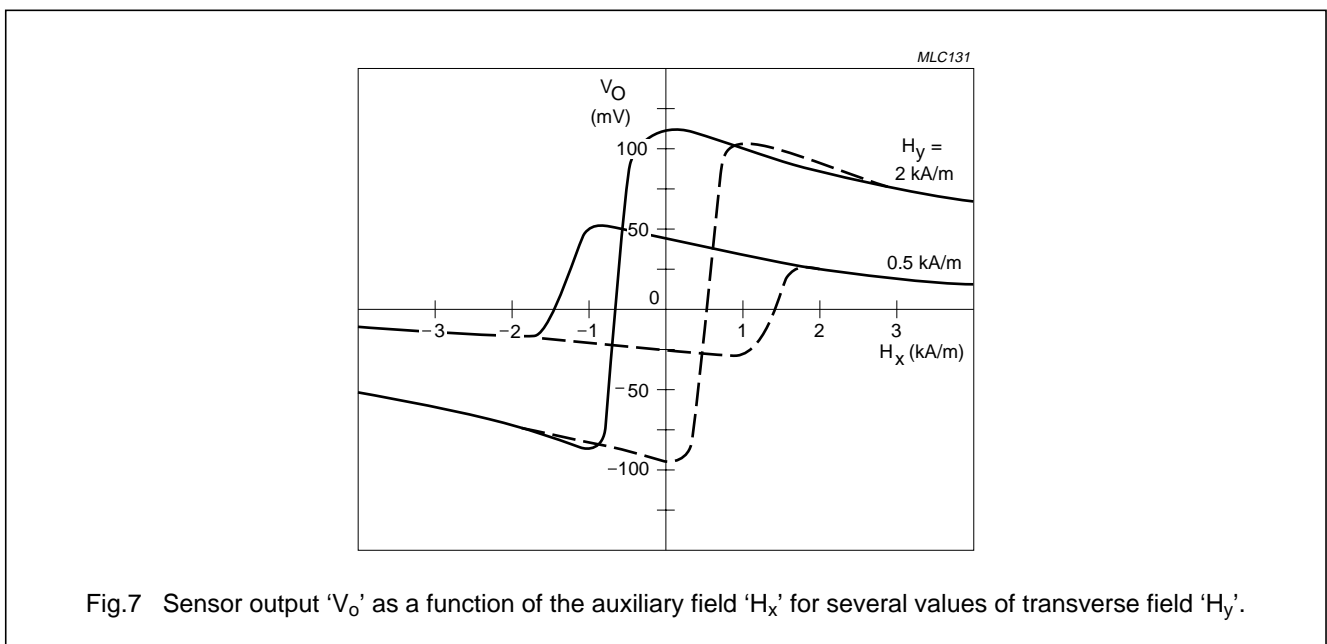
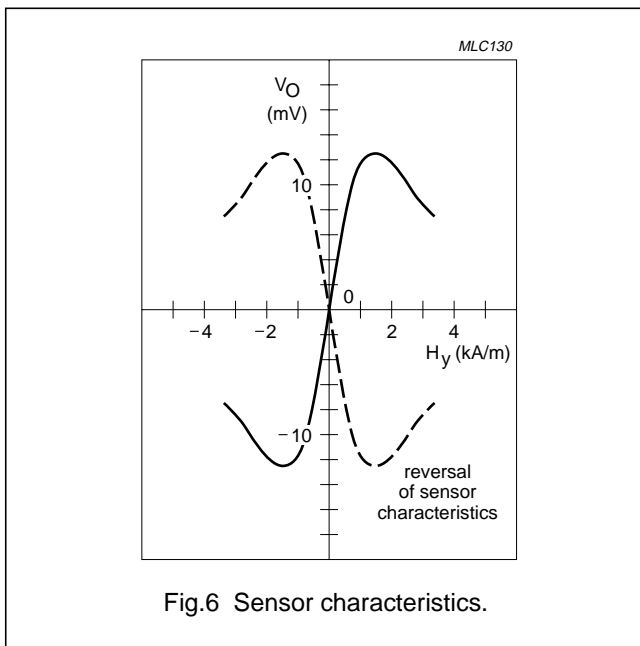

Magnetoresistive sensors for magnetic field measurement

General

Figure 7 also shows that the flipping itself is not instantaneous, because not all the permalloy strips flip at the same rate. In addition, it illustrates the hysteresis effect exhibited by the sensor. For more information on sensor flipping, see Appendix 2 of this chapter.

Effect of temperature on behaviour

Figure 8 shows that the bridge resistance increases linearly with temperature, due to the bridge resistors' temperature dependency (i.e. the permalloy) for a typical KMZ10B sensor. The data sheets show also the spread in this variation due to manufacturing tolerances and this should be taken into account when incorporating the sensors into practical circuits.

In addition to the bridge resistance, the sensitivity also varies with temperature. This can be seen from Fig.9, which plots output voltage against transverse field ' H_y ' for various temperatures. Figure 9 shows that sensitivity falls with increasing temperature (actual values for given for every sensor in the datasheets). The reason for this is rather complex and is related to the energy-band structure of the permalloy strips.

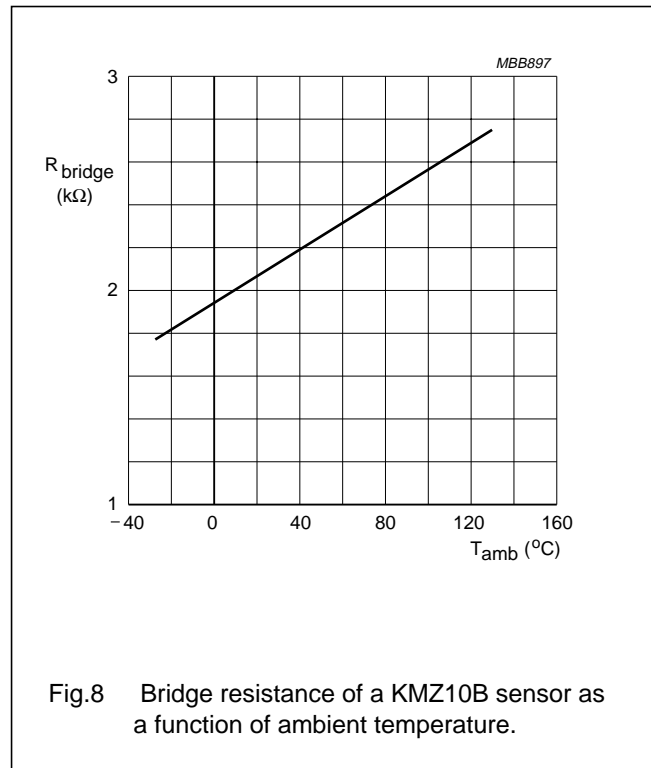

Fig.8 Bridge resistance of a KMZ10B sensor as a function of ambient temperature.

Magnetoresistive sensors for magnetic field measurement

General

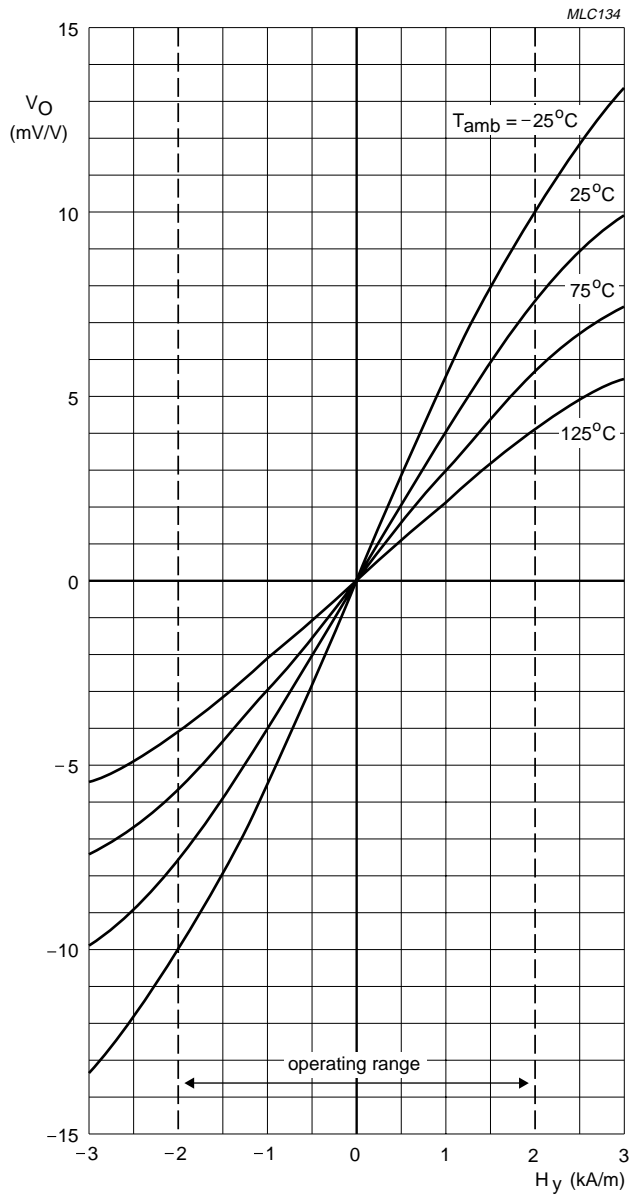

Fig.9 Output voltage 'V_o' as a fraction of the supply voltage of a KMZ10B sensor as a function of transverse field 'H_y' for several temperatures.

Magnetoresistive sensors for magnetic field measurement

General

Figure 10 is similar to Fig.9, but with the sensor powered by a constant current supply. Figure 10 shows that, in this case, the temperature dependency of sensitivity is significantly reduced. This is a direct result of the increase in bridge resistance with temperature (see Fig.8), which

partly compensates the fall in sensitivity by increasing the voltage across the bridge and hence the output voltage. Figure 8 demonstrates therefore the advantage of operating with constant current.

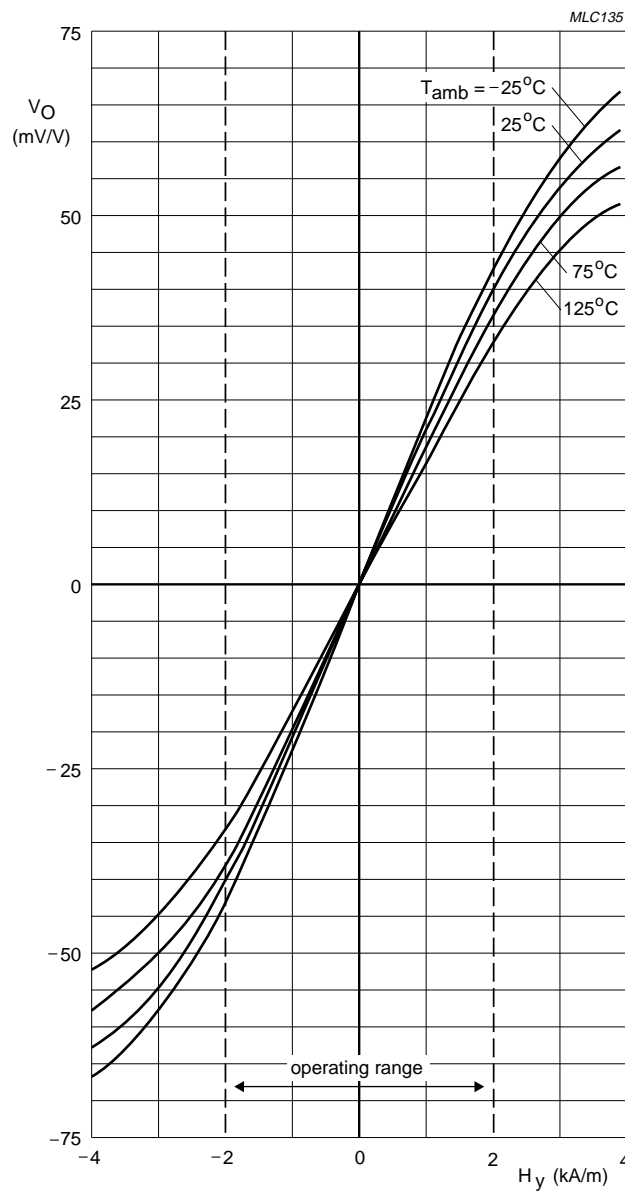

Fig.10 Output voltage 'Vo' of a KMZ10B sensor as a function of transverse field 'Hy' for several temperatures.

Magnetoresistive sensors for magnetic field measurement

General

Using magnetoresistive sensors

The excellent properties of the KMZ magnetoresistive sensors, including their high sensitivity, low and stable offset, wide operating temperature and frequency ranges and ruggedness, make them highly suitable for use in a wide range of automotive, industrial and other applications. These are looked at in more detail in other chapters in this book; some general practical points about using MR sensors are briefly described below.

ANALOG APPLICATION CIRCUITRY

In many magnetoresistive sensor applications where analog signals are measured (in measuring angular position, linear position or current measurement, for example), a good application circuit should allow for sensor offset and sensitivity adjustment. Also, as the sensitivity of many magnetic field sensors has a drift with temperature, this also needs compensation. A basic circuit is shown in Fig.11.

In the first stage, the sensor signal is pre-amplified and offset is adjusted. After temperature effects are compensated, final amplification and sensitivity adjustment takes place in the last stage. This basic circuit can be extended with additional components to meet specific EMC requirements or can be modified to obtain customized output characteristics (e.g. a different output voltage range or a current output signal).

Philips magnetoresistive sensors have a linear sensitivity drift with temperature and so a temperature sensor with

linear characteristics is required for compensation. Philips KTY series are well suited for this purpose, as their positive Temperature Coefficient (TC) matches well with the negative TC of the MR sensor. The degree of compensation can be controlled with the two resistors R7 and R8 and special op-amps, with very low offset and temperature drift, should be used to ensure compensation is constant over large temperature ranges.

Please refer to part 2 of this book for more information on the KTY temperature sensors; see also the Section "Further information for advanced users" later in this chapter for a more detailed description of temperature compensation using these sensors.

USING MAGNETORESISTIVE SENSORS WITH A COMPENSATION COIL

For general magnetic field or current measurements it is useful to apply the 'null-field' method, in which a magnetic field (generated by a current carrying coil), equal in magnitude but opposite in direction, is applied to the sensor. Using this 'feedback' method, the current through the coil is a direct measure of the unknown magnetic field amplitude and it has the advantage that the sensor is being operated at its zero point, where inaccuracies as result of tolerances, temperature drift and slight non-linearities in the sensor characteristics are insignificant. A detailed discussion of this method is covered in Chapter "Weak field measurement".

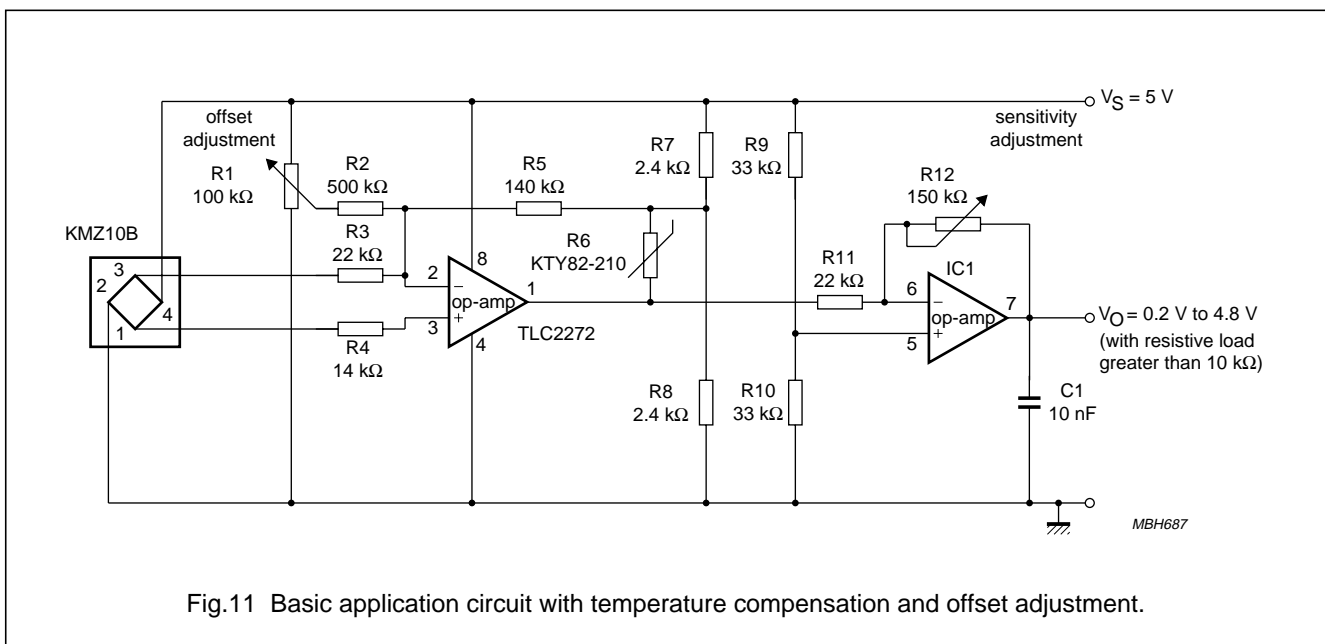

Fig.11 Basic application circuit with temperature compensation and offset adjustment.

Magnetoresistive sensors for magnetic field measurement

General

Further information for advanced users

THE MR EFFECT

In sensors employing the MR effect, the resistance of the sensor under the influence of a magnetic field changes as it is moved through an angle α as given by:

$$R = R_0 + \Delta R_0 \cos^2 \alpha \tag{2}$$

It can be shown that

$$\sin^2 \alpha = \frac{H^2}{H_0^2} \text{ for } H \leq H_0 \tag{3}$$

and

$$\sin^2 \alpha = 1 \text{ for } H > H_0 \tag{4}$$

where H_0 can be regarded as a material constant comprising the so called demagnetizing and anisotropic fields.

Applying equations (3) and (4) to equation (2) leads to:

$$R = R_0 + \Delta R_0 \left(1 - \frac{H^2}{H_0^2} \right) \text{ for } H \leq H_0 \tag{5}$$

$$R = R_0 \text{ for } H > H_0 \tag{6}$$

which clearly shows the non-linear nature of the MR effect.

More detailed information on the derivation of the formulae for the MR effect can be found in Appendix 1.

LINEARIZATION

The magnetoresistive effect can be linearized by depositing aluminium stripes (Barber poles), on top of the permalloy strip at an angle of 45° to the strip axis (see Fig.12). As aluminium has a much higher conductivity than permalloy, the effect of the Barber poles is to rotate the current direction through 45° (the current flow assumes a 'saw-tooth' shape), effectively changing the rotation angle of the magnetization relative to the current from α to $\alpha - 45^\circ$.

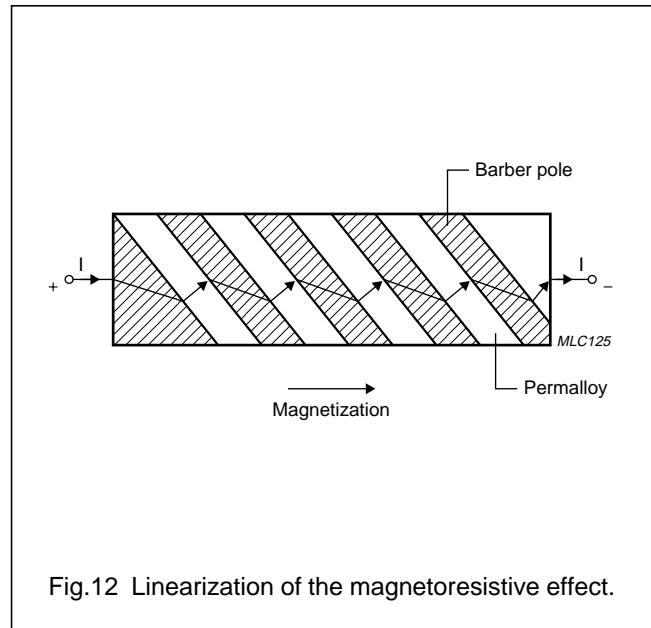

Fig.12 Linearization of the magnetoresistive effect.

A Wheatstone bridge configuration is also used for linearized applications. In one pair of diagonally opposed elements, the Barber poles are at $+45^\circ$ to the strip axis, while in another pair they are at -45° . A resistance increase in one pair of elements due to an external magnetic field is thus 'matched' by a decrease in resistance of equal magnitude in the other pair. The resulting bridge imbalance is then a linear function of the amplitude of the external magnetic field in the plane of the permalloy strips, normal to the strip axis.

Magnetoresistive sensors for magnetic field measurement

General

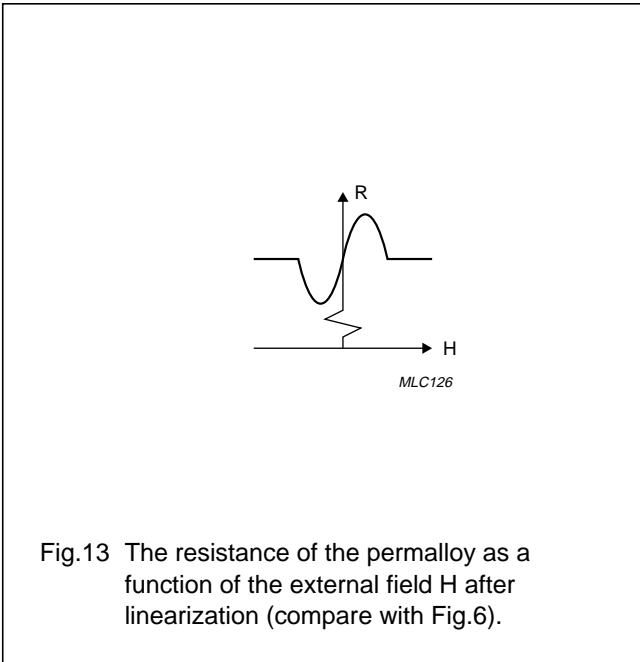

Fig.13 The resistance of the permalloy as a function of the external field H after linearization (compare with Fig.6).

For sensors using Barber poles arranged at an angle of +45° to the strip axis, the following expression for the sensor characteristic can be derived (see Appendix 1 on the MR effect):

$$R = R_0 + \frac{\Delta R_0}{2} + \Delta R_0 \left(\frac{H}{H_0} \right) \sqrt{1 - \frac{H^2}{H_0^2}} \tag{7}$$

The equation is linear where $H/H_0 = 0$, as shown in Fig.7. Likewise, for sensors using Barber poles arranged at an angle of -45°, the equation derives to:

$$R = R_0 + \frac{\Delta R_0}{2} - \Delta R_0 \left(\frac{H}{H_0} \right) \sqrt{1 - \frac{H^2}{H_0^2}} \tag{8}$$

This is the mirror image of the characteristic in Fig.7. Hence using a Wheatstone bridge configuration ensures the any bridge imbalance is a linear function of the amplitude of the external magnetic field.

FLIPPING

As described in the body of the chapter, Fig.7 shows that flipping is not instantaneous and it also illustrates the hysteresis effect exhibited by the sensor. This figure and Fig.14 also shows that the sensitivity of the sensor falls with increasing 'H_x'. Again, this is to be expected since the moment imposed on the magnetization by 'H_x' directly opposes that imposed by 'H_y', thereby reducing the degree of bridge imbalance and hence the output signal for a given value of 'H_y'.

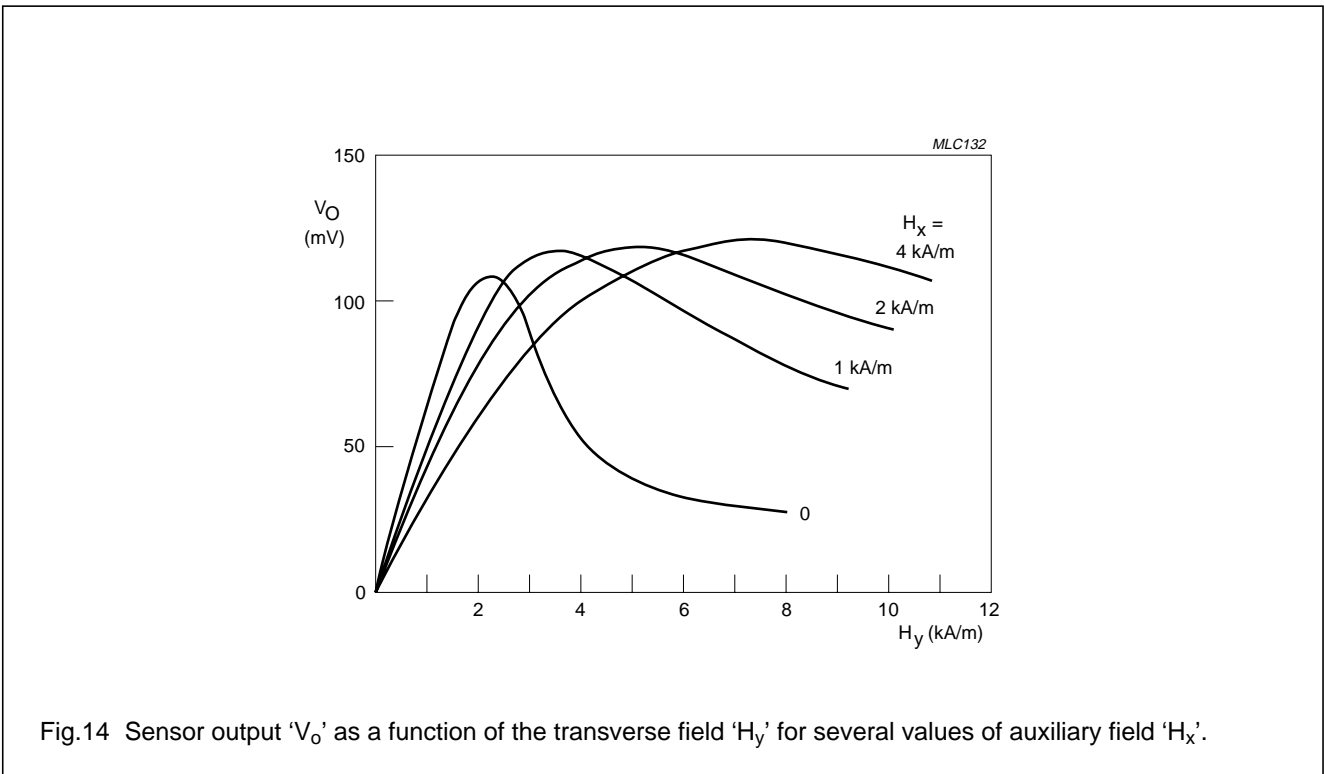

Fig.14 Sensor output 'V_O' as a function of the transverse field 'H_y' for several values of auxiliary field 'H_x'.

Magnetoresistive sensors for magnetic field measurement

The following general recommendations for operating the KMZ10 can be applied:

- To ensure stable operation, avoid operating the sensor in an environment where it is likely to be subjected to negative external fields ('-H_x'). Preferably, apply a positive auxiliary field ('H_x') of sufficient magnitude to prevent any likelihood of flipping within the intended operating range (i.e. the range of 'H_y').
- Before using the sensor for the first time, apply a positive auxiliary field of at least 3 kA/m; this will effectively erase the sensor's magnetic 'history' and will ensure that no residual hysteresis remains (refer to Fig.6).
- Use the minimum auxiliary field that will ensure stable operation, because the larger the auxiliary field, the lower the sensitivity, but the actual value will depend on the value of H_d. For the KMZ10B sensor, a minimum auxiliary field of approximately 1 kA/m is recommended; to guarantee stable operation for all values of H_d, the sensor should be operated in an auxiliary field of 3 kA/m.

These recommendations (particularly the first one) define a kind of Safe Operating Area (SOAR) for the sensors. This is illustrated in Fig.15, which is an example (for the KMZ10B sensor) of the SOAR graphs to be found in our data sheets.

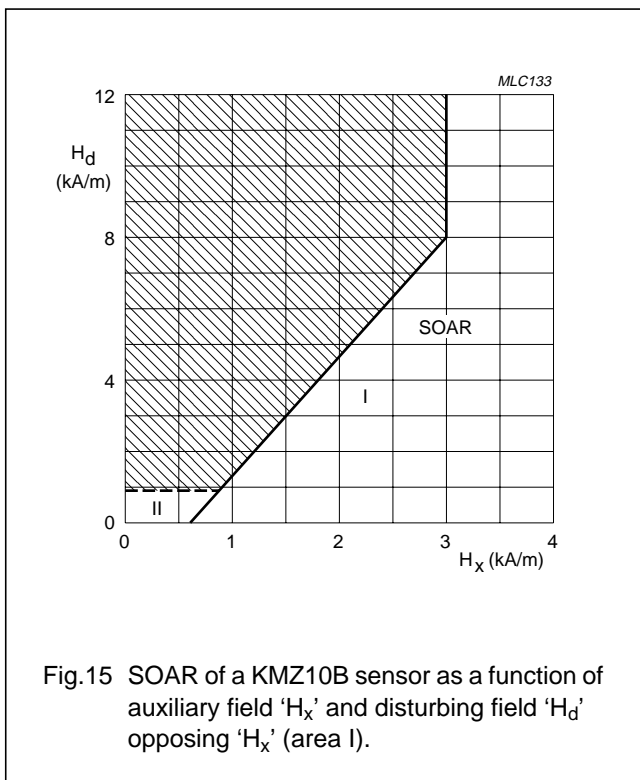

Fig.15 SOAR of a KMZ10B sensor as a function of auxiliary field 'H_x' and disturbing field 'H_d' opposing 'H_x' (area I).

The greater the auxiliary field, the greater the disturbing field that can be tolerated before flipping occurs. For auxiliary fields above 3 kA/m, the SOAR graph shows that the sensor is completely stable, regardless of the magnitude of the disturbing field. It can also be seen from this graph that the SOAR can be extended for low values of 'H_y'. In Fig.15, (for the KMZ10B sensor), the extension for H_y < 1 kA/m is shown.

TEMPERATURE COMPENSATION

With magnetoresistive sensors, temperature drift is negative. Two circuits manufactured in SMD-technology which include temperature compensation are briefly described below.

The first circuit is the basic application circuit already given (see Fig.11). It provides average (sensor-to-sensor) compensation of sensitivity drift with temperature using the KTY82-210 silicon temperature sensor. It also includes offset adjustment (via R1); gain adjustment is performed with a second op-amp stage. The temperature sensor is part of the amplifier's feedback loop and thus increases the amplification with increasing temperature.

The temperature dependant amplification A and the temperature coefficient TC_A of the first op-amp stage are approximately:

$$A = \frac{R_5}{R_3} \left(1 + \frac{2R_T}{R_7} \right) \text{ for } R_8 = R_7$$

$$TC_A = \frac{TC_{KTY}}{R_7} \text{ for } R_8 = R_7$$

$$1 + \frac{2R_T}{R_7}$$

R_T is the temperature dependent resistance of the KTY82. The values are taken for a certain reference temperature. This is usually 25 °C, but in other applications a different reference temperature may be more suitable.

Figure 16 shows an example with a commonly-used instrumentation amplifier. The circuit can be divided into two stages: a differential amplifier stage that produces a symmetrical output signal derived from the magnetoresistive sensor, and an output stage that also provides a reference to ground for the amplification stage.

To compensate for the negative sensor drift, as with the above circuit the amplification is again given an equal but positive temperature coefficient, by means of a KTY81-110 silicon temperature sensor in the feedback loop of the differential amplifier.

Magnetoresistive sensors for magnetic field measurement

General

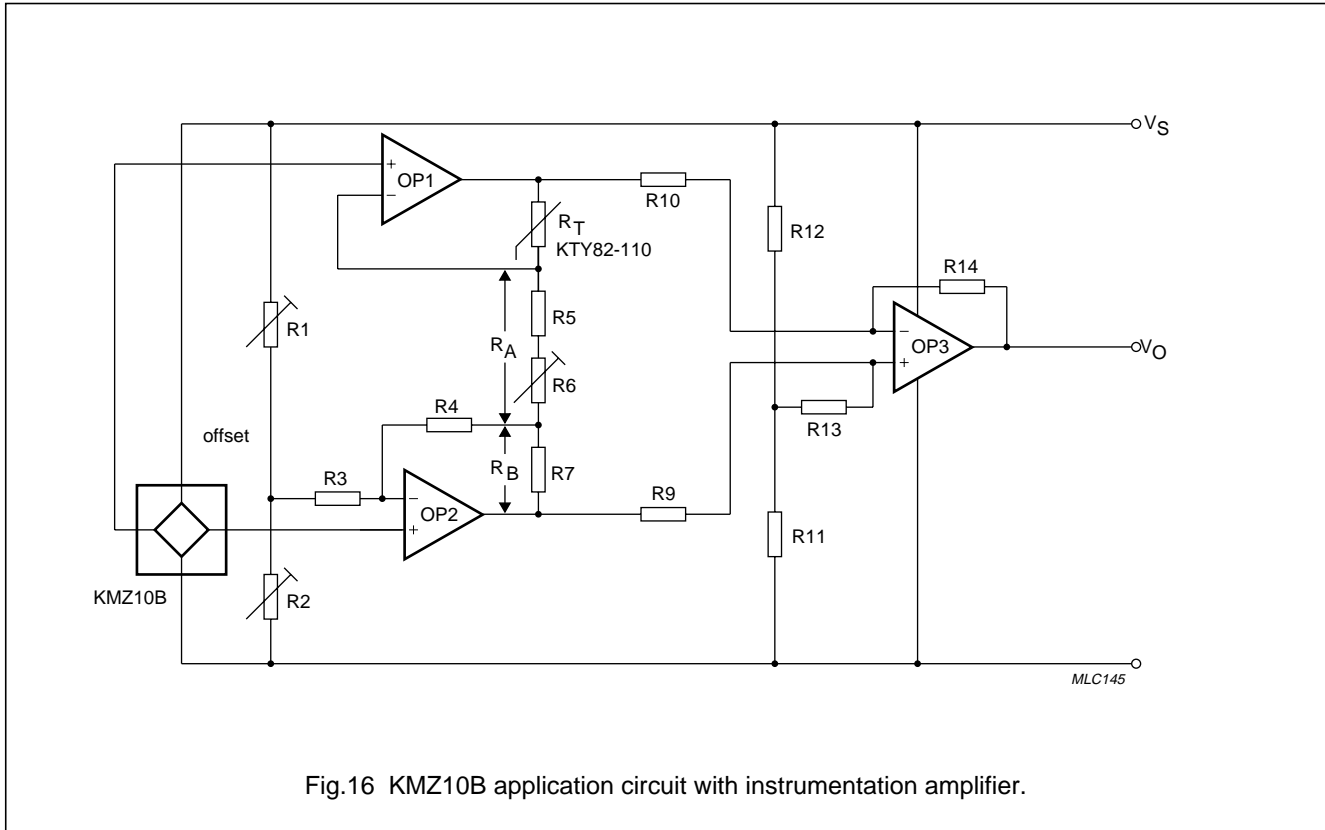

Fig.16 KMZ10B application circuit with instrumentation amplifier.

The amplification of the input stage ('OP1' and 'OP2') is given by:

$$A1 = 1 + \frac{R_T + R_B}{R_A} \tag{9}$$

where R_T is the temperature dependent resistance of the KTY82 sensor and R_B is the bridge resistance of the magnetoresistive sensor.

The amplification of the complete amplifier can be calculated by:

$$A = A1 \times \frac{R_{14}}{R_{10}} \tag{10}$$

The positive temperature coefficient (TC) of the amplification is:

$$TC_A = \frac{R_T \times TC_{KTY}}{R_A + R_B + R_T} \tag{11}$$

For the given negative 'TC' of the magnetoresistive sensor and the required amplification of the input stage 'A1', the resistance 'R_A' and 'R_B' can be calculated by:

$$R_B = R_T \times \left(\frac{TC_{KTY}}{TC_A} \times \left(1 - \frac{1}{A1} \right) - 1 \right) \tag{12}$$

$$R_A = \frac{R_T + R_B}{A1 - 1} \tag{13}$$

where TC_{KTY} is the temperature coefficient of the KTY sensor and TC_A is the temperature coefficient of the amplifier. This circuit also provides for adjustment of gain and offset voltage of the magnetic-field sensor.

Magnetoresistive sensors for magnetic field measurement

General

APPENDIX 1: THE MAGNETORESISTIVE EFFECT

Magnetoresistive sensors make use of the fact that the electrical resistance ρ of certain ferromagnetic alloys is influenced by external fields. This solid-state magnetoresistive effect, or anisotropic magnetoresistance, can be easily realized using thin film technology, so lends itself to sensor applications.

Resistance- field relation

The specific resistance ρ of anisotropic ferromagnetic metals depends on the angle Θ between the internal magnetization M and the current I , according to:

$$\rho(\Theta) = \rho_{\perp} + (\rho_{\perp} - \rho_{\parallel}) \cos^2 \Theta \tag{1}$$

where ρ_{\perp} and ρ_{\parallel} are the resistivities perpendicular and parallel to M . The quotient $(\rho_{\perp} - \rho_{\parallel})/\rho_{\perp} = \Delta\rho/\rho$ is called the magnetoresistive effect and may amount to several percent.

Sensors are always made from ferromagnetic thin films as this has two major advantages over bulk material: the resistance is high and the anisotropy can be made uniaxial. The ferromagnetic layer behaves like a single domain and has one distinguished direction of magnetization in its plane called the easy axis (e.a.), which is the direction of magnetization without external field influence.

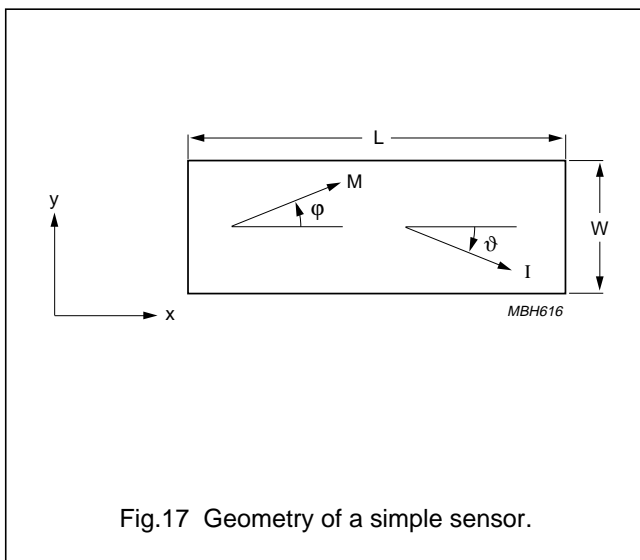

Fig.17 Geometry of a simple sensor.

Figure 17 shows the geometry of a simple sensor where the thickness (t) is much smaller than the width (w) which is in turn, less than the length (l) (i.e. $t \ll w \ll l$). With the current (I) flowing in the x -direction (i.e. $q = 0$ or $Q = f$) then the following equation can be obtained from equation 1:

$$R = R_0 + DR \cos^2\phi \tag{2}$$

and with a constant current I , the voltage drop in the x -direction U_x becomes:

$$U_x = \rho_{\perp} I \left(\frac{L}{wt} \right) \left(1 + \left(\frac{\Delta\rho}{\rho} \right) \cos^2 \phi \right) \tag{3}$$

Besides this voltage, which is directly allied to the resistance variation, there is a voltage in the y -direction, U_y , given by:

$$U_y = \rho_{\perp} I \left(\frac{1}{t} \right) \left(\frac{\Delta\rho}{\rho} \right) \sin\phi \cos\phi \tag{4}$$

This is called the planar or pseudo Hall effect; it resembles the normal or transverse Hall effect but has a physically different origin.

All sensor signals are determined by the angle ϕ between the magnetization M and the 'length' axis and, as M rotates under the influence of external fields, these external fields thus directly determine sensor signals. We can assume that the sensor is manufactured such that the e.a. is in the x -direction so that without the influence of external fields, M only has an x -component ($\phi = 0^\circ$ or 180°).

Two energies have to be introduced when M is rotated by external magnetic fields: the anisotropy energy and the demagnetizing energy. The anisotropy energy E_k , is given by the crystal anisotropy field H_k , which depends on the material and processes used in manufacture. The demagnetizing energy E_d or form anisotropy depends on the geometry and this is generally a rather complex relationship, apart from ellipsoids where a uniform demagnetizing field H_d may be introduced. In this case, for the sensor set-up in Fig.17.

$$H_d \approx \frac{t}{w} \left(\frac{M_s}{\mu_0} \right) \tag{5}$$

where the demagnetizing factor $N = t/w$, the saturation magnetization $M_s \approx 1$ T and the induction constant $\mu_0 = 4\pi \cdot 10^{-7}$ Vs/Am.

The field $H_0 = H_k + t/w(M_0/m_0)$ determines the measuring range of a magnetoresistive sensor, as f is given by:

Magnetoresistive sensors for magnetic field measurement

General

$$\sin\phi = \frac{H_y}{H_0 + \frac{H_x}{\cos\phi}} \tag{6}$$

where $|H_y| \leq |H_0 + H_x|$ and H_x and H_y are the components of the external field. In the simplest case $H_x = 0$, the voltages U_x and U_y become:

$$U_x = \rho_{\perp} I \left(\frac{L}{wt} \right) \left(1 + \left(\frac{\Delta\rho}{\rho} \right) \left(1 - \left(\frac{H_y}{H_0} \right)^2 \right) \right) \tag{7}$$

$$U_y = \rho_{\perp} I \left(\frac{1}{t} \right) \left(\frac{\Delta\rho}{\rho} \right) \left(\frac{H_y}{H_0} \right) \sqrt{1 - \left(\frac{H_y}{H_0} \right)^2} \tag{8}$$

(Note: if $H_x = 0$, then H_0 must be replaced by $H_0 + H_x/\cos\phi$).

Neglecting the constant part in U_x , there are two main differences between U_x and U_y :

1. The magnetoresistive signal U_x depends on the square of H_y/H_0 , whereas the Hall voltage U_y is linear for $H_y \ll H_0$.
2. The ratio of their maximum values is L/w ; the Hall voltage is much smaller as in most cases $L \gg w$.

Magnetization of the thin layer

The magnetic field is in reality slightly more complicated than given in equation (6). There are two solutions for angle ϕ :

$\phi_1 < 90^\circ$ and $\phi_2 > 90^\circ$ (with $\phi_1 + \phi_2 = 180^\circ$ for $H_x = 0$).

Replacing ϕ by $180^\circ - \phi$ has no influence on U_x except to change the sign of the Hall voltage and also that of most linearized magnetoresistive sensors.

Therefore, to avoid ambiguity either a short pulse of a proper field in the x-axis ($|H_x| > H_k$) with the correct sign must be applied, which will switch the magnetization into the desired state, or a stabilizing field H_{st} in the x-direction can be used. With the exception of $H_y \ll H_0$, it is advisable to use a stabilizing field as in this case, H_x values are not affected by the non-ideal behaviour of the layer or restricted by the so-called 'blocking curve'.

The minimum value of H_{st} depends on the structure of the sensitive layer and has to be of the order of H_k , as an insufficient value will produce an open characteristic (hysteresis) of the sensor. An easy axis in the y-direction leads to a sensor of higher sensitivity, as then $H_0 = H_k - H_d$.

Linearization

As shown, the basic magnetoresistor has a square

resistance-field (R-H) dependence, so a simple magnetoresistive element cannot be used directly for linear field measurements. A magnetic biasing field can be used to solve this problem, but a better solution is linearization using barber-poles (described later). Nevertheless plain elements are useful for applications using strong magnetic fields which saturate the sensor, where the actual value of the field is not being measured, such as for angle measurement. In this case, the direction of the magnetization is parallel to the field and the sensor signal can be described by a $\cos^2\alpha$ function.

Sensors with inclined elements

Sensors can also be linearized by rotating the current path, by using resistive elements inclined at an angle θ , as shown in Fig.18. An actual device uses four inclined resistive elements, two pairs each with opposite inclinations, in a bridge.

The magnetic behaviour of such a pattern is more complicated as M_0 is determined by the angle of inclination θ , anisotropy, demagnetization and bias field (if present). Linearity is at its maximum for $\phi + \theta \approx 45^\circ$, which can be achieved through proper selection of θ .

A stabilization field (H_{st}) in the x-direction may be necessary for some applications, as this arrangement only works properly in one magnetization state.

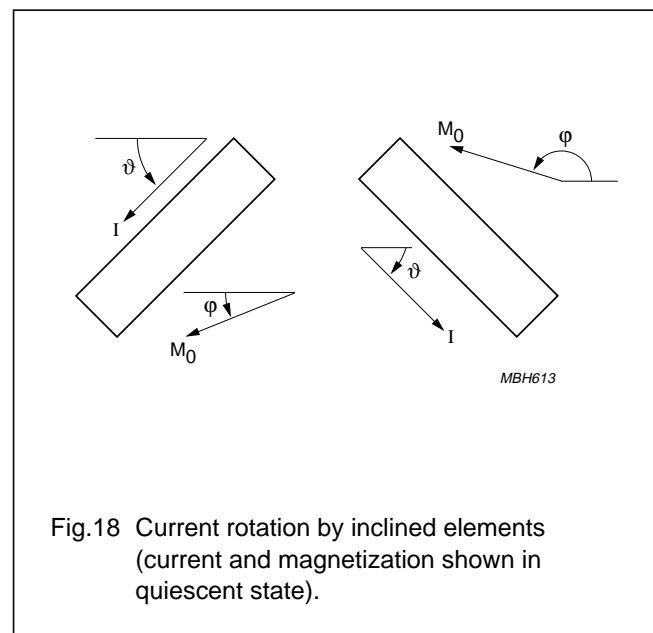

Fig.18 Current rotation by inclined elements (current and magnetization shown in quiescent state).

Magnetoresistive sensors for magnetic field measurement

General

BARBER-POLE SENSORS

A number of Philips' magnetoresistive sensors use a 'barber-pole' construction to linearize the R-H relationship, incorporating slanted strips of a good conductor to rotate the current. This type of sensor has the widest range of linearity, smaller resistance and the least associated distortion than any other form of linearization, and is well suited to medium and high fields.

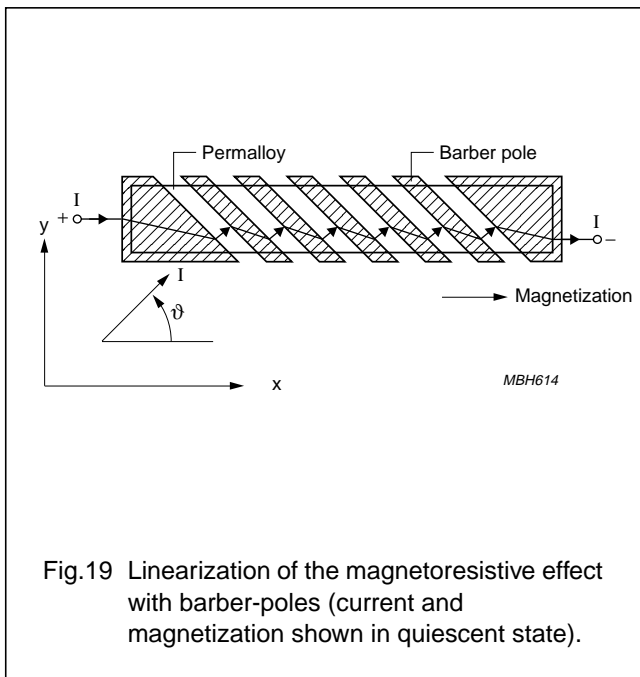

Fig.19 Linearization of the magnetoresistive effect with barber-poles (current and magnetization shown in quiescent state).

The current takes the shortest route in the high-resistivity gaps which, as shown in Fig 19, is perpendicular to the barber-poles. Barber-poles inclined in the opposite direction will result in the opposite sign for the R-H characteristic, making it extremely simple to realize a Wheatstone bridge set-up.

The signal voltage of a Barber-pole sensor may be calculated from the basic equation (1) with $\Theta = \phi + 45^\circ$ ($\theta = + 45^\circ$):

$$U_{BP} = \rho_{\perp} I \left(\frac{L}{wt} \right) \alpha \left(1 + \frac{1}{2} \left(\frac{\Delta \rho}{\rho} \right) \pm \frac{\Delta \rho}{\rho} \frac{H_y}{H_0} \sqrt{1 - \left(\frac{H_y}{H_0} \right)^2} \right) \quad (9)$$

where α is a constant arising from the partial shorting of the resistor, amounting to 0.25 if barber-poles and gaps have

equal widths. The characteristic is plotted in Fig 20 and it can be seen that for small values of H_y relative to H_0 , the R-H dependence is linear. In fact this equation gives the same linear R-H dependence as the planar Hall-effect sensor, but it has the magnitude of the magnetoresistive sensor.

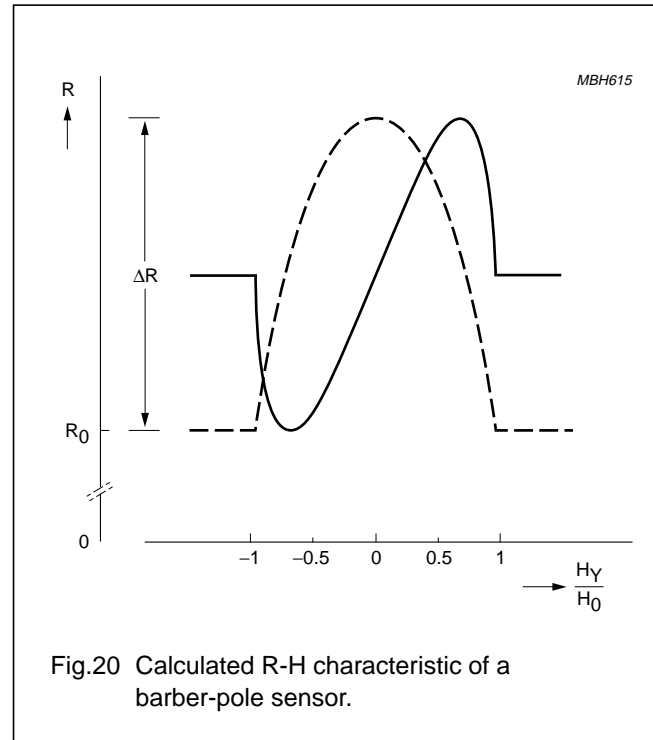

Fig.20 Calculated R-H characteristic of a barber-pole sensor.

Barber-pole sensors require a certain magnetization state. A bias field of several hundred A/m can be generated by the sensing current alone, but this is not sufficient for sensor stabilization, so can be neglected. In most applications, an external field is applied for this purpose.

Sensitivity

Due to the high demagnetization, in most applications field components in the z-direction (perpendicular to the layer plane) can be ignored. Nearly all sensors are most sensitive to fields in the y-direction, with H_x only having a limited or even negligible influence.

Definition of the sensitivity S contains the signal and field variations (ΔU and ΔH), as well as the operating voltage U_0 (as ΔU is proportional to U_0):

$$S_0 = \frac{\Delta U}{\Delta H} \left(\frac{1}{U_0} \right) = \left(\frac{\Delta U}{U_0 \Delta H} \right) \quad (10)$$

Magnetoresistive sensors for magnetic field measurement

General

This definition relates DU to a unit operating voltage. The highest (H_G) and lowest (H_{\min}) fields detectable by the sensor are also of significance. The measuring range H_G is restricted by non-linearity - if this is assumed at 5%, an approximate value for barber-pole sensors is given by:

$$H_G \approx 0.5(H_0 + H_x) \quad (11)$$

From this and equation (9) for signal voltage (U_{BP}) for a barber-pole sensor, the following simple relationship can be obtained: $H_G S_0 \approx 0.5 \left(\frac{\Delta\rho}{\rho} \right)$ (12)

Other sensor types have a narrower range of linearity and therefore a smaller useful signal.

The lowest detectable field H_{\min} is limited by offset, drift and noise. The offset is nearly cancelled in a bridge circuit and the remaining imbalance is minimized by symmetrical design and offset trimming, with thermal noise negligible in most applications (see section on sensor layout). Proper film deposition and, if necessary, the introduction of a stabilization field will eliminate magnetization switching due to domain splitting and the introduction of 'Barkhausen noise'.

Sensitivity S_0 is essentially determined by the sum of the anisotropy (H_k), demagnetization (H_d) and bias (H_x) fields. The highest sensitivity is achievable with $H_x = 0$ and $H_d \ll H_k$, although in this case S_0 depends purely on H_k which is less stable than H_d . For a permalloy with a thickness greater than or equal to 20 μm , a width in excess of 60 μm is required which, although possible, has the drawback of producing a very low resistance per unit area.

The maximum theoretical S_0 with this permalloy (at $H_k = 250 \text{ A/m}$ and $\Delta\rho/\rho = 2.5\%$) is approximately:

$$S_0(\text{max}) = 10^{-4} \left(\frac{\text{A}}{\text{m}} \right)^{-1} = 100 \frac{\left(\frac{\text{mV}}{\text{V}} \right)}{\left(\frac{\text{kA}}{\text{m}} \right)} \quad (13)$$

For the same reasons, sensors with reduced sensitivity should be realized with increased H_d , which can be estimated at a maximum for a barber-pole sensor at 40 kA/m. A further reduction in sensitivity and a corresponding growth in the linearity range is attained using a biasing field. A magnetic shunt parallel to the magnetoresistor or only having a small field component in the sensitive direction can also be employed with very high field strengths.

A high signal voltage U_x can only be produced with a sensor that can tolerate a high supply voltage U_0 . This

requires a high sensor resistance R with a large area A , since there are limits for power dissipation and current density. The current density in permalloy may be very high ($j > 10^6 \text{ A/cm}^2$ in passivation layers), but there are weak points at the current reversal in the meander (see section on sensor layout) and in the barber-pole material, with five-fold increased current density.

A high resistance sensor with $U_0 = 25 \text{ V}$ and a maximum S_0 results in a value of $2.5 \times 10^{-3} (\text{A/m})^{-1}$ for Su or, converted to flux density, $S_T = 2000 \text{ V/T}$. This value is several orders of magnitude higher than for a normal Hall effect sensor, but is valid only for a much narrower measuring range.

Materials

There are five major criteria for a magnetoresistive material:

- Large magnetoresistive effect Dr/r (resulting in a high signal to operating voltage ratio)
- Large specific resistance r (to achieve high resistance value over a small area)
- Low anisotropy
- Zero magnetostriction (to avoid influence of mechanical stress)
- Long-term stability.

Appropriate materials are binary and ternary alloys of Ni, Fe and Co, of which NiFe (81/19) is probably the most common.

Table 1 gives a comparison between some of the more common materials, although the majority of the figures are only approximations as the exact values depend on a number of variables such as thickness, deposition and post-processing.

Table 3 Comparison of magnetoresistive sensor materials

Materials	ρ ($10^{-8}\Omega\text{m}$)	$\Delta\rho/\rho(\%)$	$H_k(\text{A/m})$
NiFe 81:19	22	2.2	250
NiFe 86:14	15	3	200
NiCo 50:50	24	2.2	2500
NiCo 70:30	26	3.7	2500
CoFeB 72:8:20	86	0.07	2000

$\Delta\rho$ is nearly independent of these factors, but r itself increases with thickness ($t \leq 40 \text{ nm}$) and will decrease during annealing. Permalloys have a low H_k and zero magnetostriction; the addition of Co will increase $\Delta\rho/\rho$, but

Magnetoresistive sensors for magnetic field measurement

General

this also considerably enlarges H_k . If a small temperature coefficient of $\Delta\rho$ is required, NiCo alloys are preferable. The amorphous alloy CoFeB has a low $\Delta\rho/\rho$, high H_k and slightly worse thermal stability but due to the absence of grain boundaries within the amorphous structure, exhibits excellent magnetic behaviour.

APPENDIX 2: SENSOR FLIPPING

During deposition of the permalloy strip, a strong external magnetic field is applied parallel to the strip axis. This accentuates the inherent magnetic anisotropy of the strip and gives them a preferred magnetization direction, so that even in the absence of an external magnetic field, the magnetization will always tend to align with the strips.

Providing a high level of premagnetization within the crystal structure of the permalloy allows for two stable premagnetization directions. When the sensor is placed in a controlled external magnetic field opposing the internal aligning field, the polarity of the premagnetization of the strips can be switched or 'flipped' between positive and negative magnetization directions, resulting in two stable output characteristics.

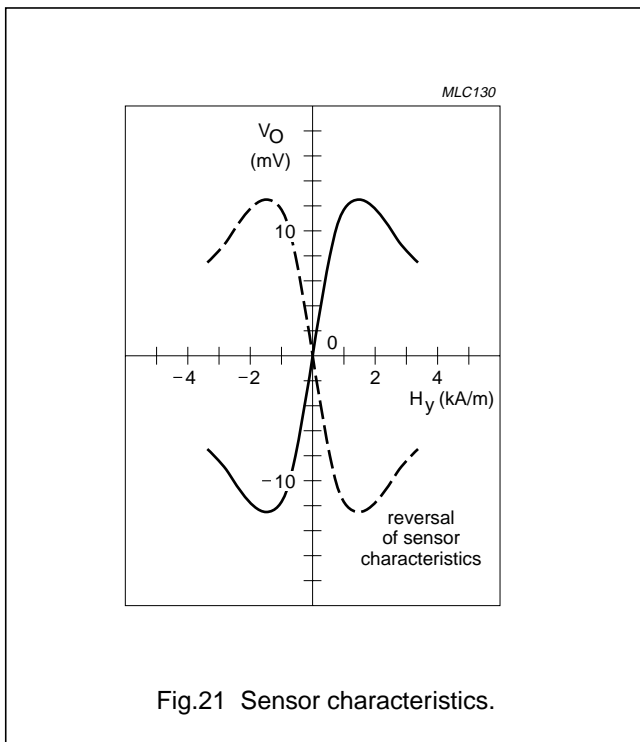

Fig.21 Sensor characteristics.

The field required to flip the sensor magnetization (and hence the output characteristic) depends on the magnitude of the transverse field H_y . The greater this field,

the more the magnetization rotates towards 90° and therefore it becomes easier to flip the sensor into the '-x' direction. This means that a smaller $-H_x$ field is sufficient to cause the flipping action

As can be seen in Fig 22, for low transverse field strengths (0.5 kA/m) the sensor characteristic is stable for all positive values of H_x , and a reverse field of approximately 1 kA/m is required to flip the sensor. However at higher values of H_y (2 kA/m), the sensor will also flip for smaller values of H_x (at 0.5 kA/m). Also illustrated in this figure is a noticeable hysteresis effect; it also shows that as the permalloy strips do not flip at the same rate, the flipping action is not instantaneous.

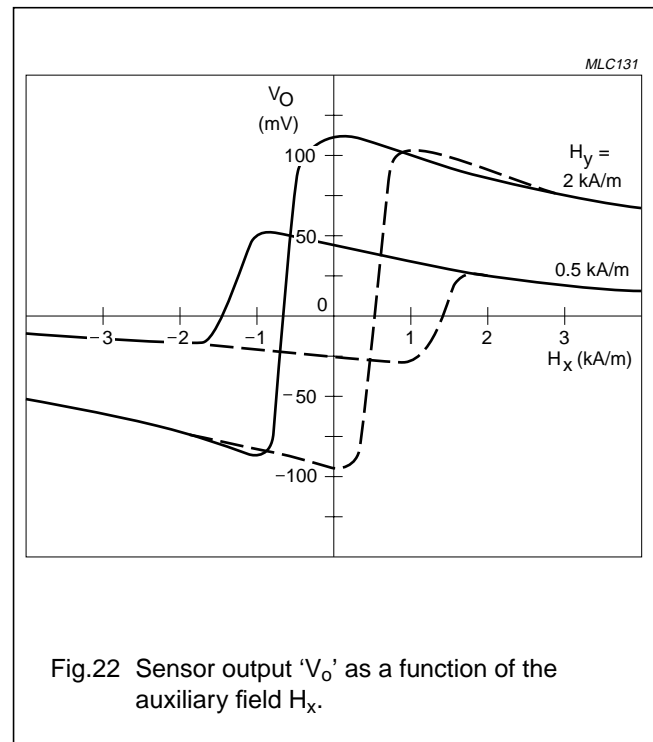

Fig.22 Sensor output 'V_O' as a function of the auxiliary field H_x .

The sensitivity of the sensor reduces as the auxiliary field H_x increases, which can be seen in Fig 22 and more clearly in Fig 23. This is because the moment imposed on the magnetization by H_x directly opposes that of H_y , resulting in a reduction in the degree of bridge imbalance and hence the output signal for a given value of H_y .

Magnetoresistive sensors for magnetic field measurement

General

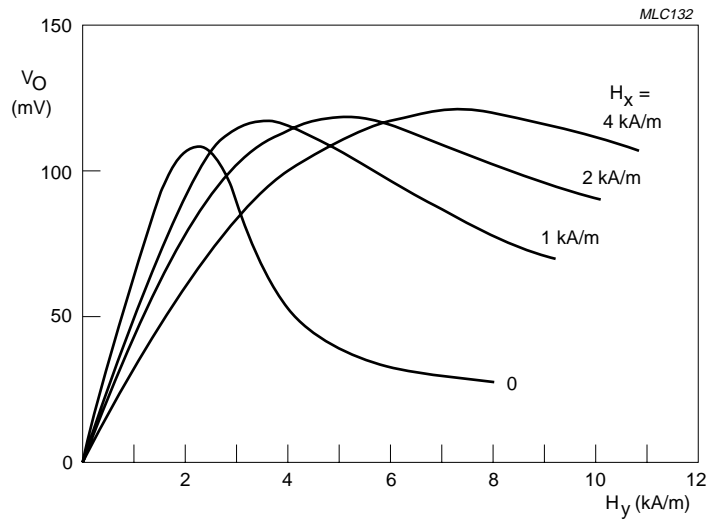

Fig.23 Sensor output 'V_o' as a function of the transverse field H_y.

A Safe Operating Area (SOAR) can be determined for magnetoresistive sensors, within which the sensor will not flip, depending on a number of factors. The higher the auxiliary field, the more tolerant the sensor becomes to external disturbing fields (H_d) and with an H_x of 3 kA/m or greater, the sensor is stabilized for all disturbing fields as long as it does not irreversibly demagnetize the sensor. If H_d is negative and much larger than the stabilising field H_x , the sensor will flip. This effect is reversible, with the sensor returning to the normal operating mode if H_d again becomes negligible (see Fig 24). However the higher H_x , the greater the reduction in sensor sensitivity and so it is generally recommended to have a minimum auxiliary field that ensures stable operation, generally around 1 kA/m. The SOAR can also be extended for low values of H_x as long as the transverse field is less than 1 kA/m. It is also recommended to apply a large positive auxiliary field before first using the sensor, which erases any residual hysteresis

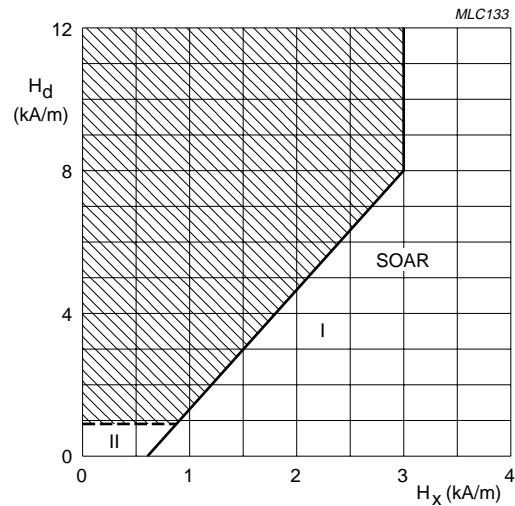

Fig.24 SOAR of a KMZ10B sensor as a function of auxiliary field 'H_x' (MLC133).

Magnetoresistive sensors for magnetic field measurement

General

APPENDIX 3: SENSOR LAYOUT

In Philips' magnetoresistive sensors, the permalloy strips are formed into a meander pattern on the silicon substrate. With the KMZ10 (see Fig 25) and KMZ51 series, four barber-pole permalloy strips are used while the KMZ41 series has simple elements. The patterns used are

different for these three families of sensors in every case, the elements are linked in the same fashion to form the four arms of a Wheatstone bridge. The meander pattern used in the KMZ51 is more sophisticated and also includes integrated compensation and flipping coils (see chapter on weak fields); the KMZ41 is described in more detail in the chapter on angle measurement.

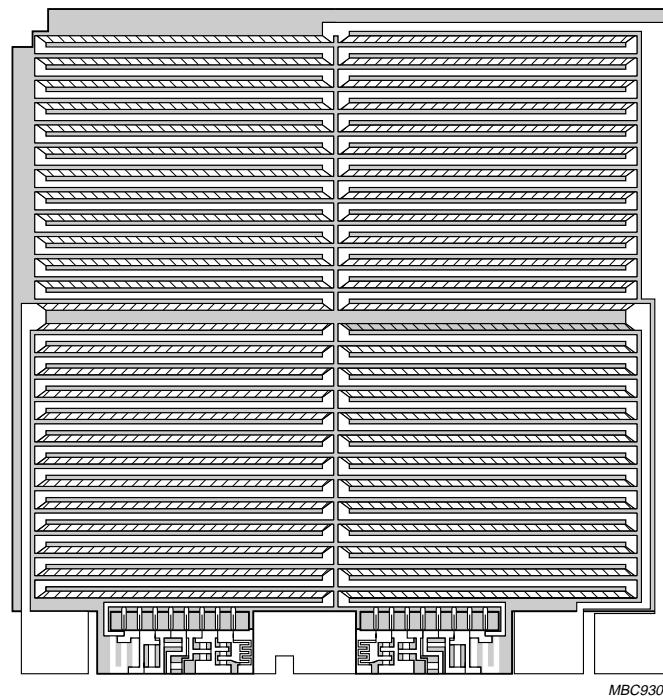

Fig.25 KMZ10 chip structure.

Magnetoresistive sensors for magnetic field measurement

General

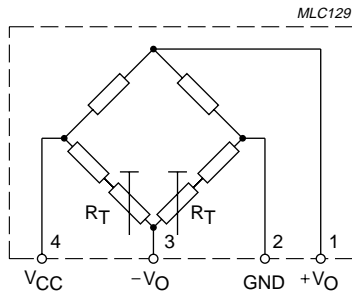

Fig.26 KMZ10 and KMZ11 bridge configuration.

In one pair of diagonally opposed elements the barber-poles are at $+45^\circ$ to the strip axis, with the second pair at -45° . A resistance increase in one pair of elements due to an external magnetic field is matched by an equal decrease in resistance of the second pair. The resulting bridge imbalance is then a linear function of the amplitude of the external magnetic field in the plane of the permalloy strips normal to the strip axis.

This layout largely eliminates the effects of ambient variations (e.g. temperature) on the individual elements and also magnifies the degree of bridge imbalance, increasing sensitivity.

Fig 26 indicates two further trimming resistors (R_T) which allow the sensors electrical offset to be trimmed down to zero during the production process.

Magnetoresistive sensors for magnetic field measurement

General

WEAK FIELD MEASUREMENT

Contents

- Fundamental measurement techniques
- Application note AN00022: Electronic compass design using KMZ51 and KMZ52
- Application circuit: signal conditioning unit for compass
- Example 1: Earth geomagnetic field compensation in CRT's
- Example 2: Traffic detection
- Example 3: Measurement of current.

Fundamental measurement techniques

Measurement of weak magnetic fields such as the earth's geomagnetic field (which has a typical strength of between approximately 30 A/m and 50 A/m), or fields resulting from very small currents, requires a sensor with very high sensitivity. With their inherent high sensitivity, magnetoresistive sensors are extremely well suited to sensing very small fields.

Philips' magnetoresistive sensors are by nature bi-stable (refer to Appendix 2). 'Standard' techniques used to stabilize such sensors, including the application of a strong field in the x-direction (H_x) from a permanent stabilization magnet, are unsuitable as they reduce the sensor's sensitivity to fields in the measurement, or y-direction (H_y). (Refer to Appendix 2, Fig. A2.2).

To avoid this loss in sensitivity, magnetoresistive sensors can instead be stabilized by applying brief, strong non-permanent field pulses of very short duration (a few μs). This magnetic field, which can be easily generated by simply winding a coil around the sensor, has the same stabilizing effect as a permanent magnet, but as it is only present for a very short duration, after the pulse there is no loss of sensitivity. Modern magnetoresistive sensors specifically designed for weak field applications incorporate this coil on the silicon.

However, when measuring weak fields, second order effects such as sensor offset and temperature effects can greatly reduce both the sensitivity and accuracy of MR sensors. Compensation techniques are required to suppress these effects.

OFFSET COMPENSATION BY 'FLIPPING'

Despite electrical trimming, MR sensors may have a maximum offset voltage of $\pm 1.5 \text{ mV/V}$. In addition to this

static offset, an offset drift due to temperature variations of about $6 (\mu\text{V/V})\text{K}^{-1}$ can be expected and assuming an ambient temperature up to 100°C , the resulting offset can be of the order of 2 mV/V .

Taking these factors into account, with no external field a sensor with a typical sensitivity of $15 \text{ mV/V (kA/m)}^{-1}$ can have an offset equivalent to a field of 130 A/m, which is itself about four times the strength of a typical weak field such as the earth's geomagnetic field. Clearly, measures to compensate for the sensor offset value have to be implemented in weak field applications.

A technique called 'flipping' (patented by Philips) can be used to control the sensor. Comparable to the 'chopping' technique used in the amplification of small electrical signals, it not only stabilizes the sensor but also eliminates the described offset effects.

When the bi-stable sensor is placed in a controlled, reversible external magnetic field, the polarity of the premagnetization (M_x) of the sensor strips can be switched or flipped between the two output characteristics (see Fig.27).

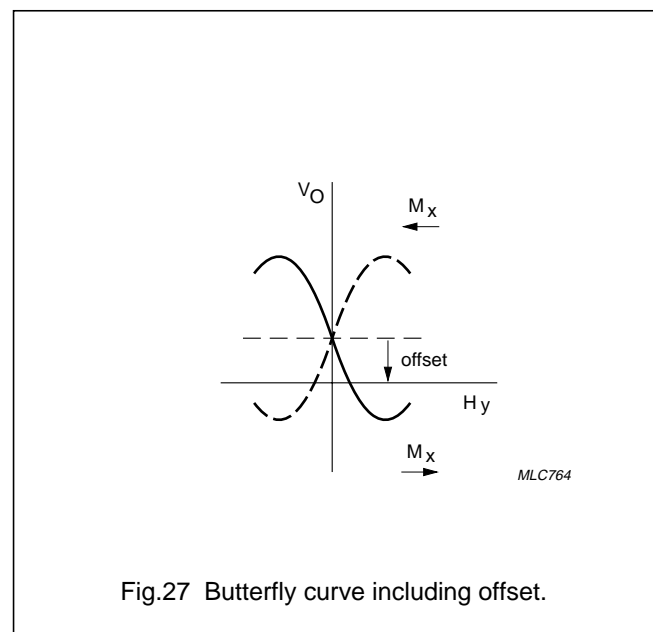
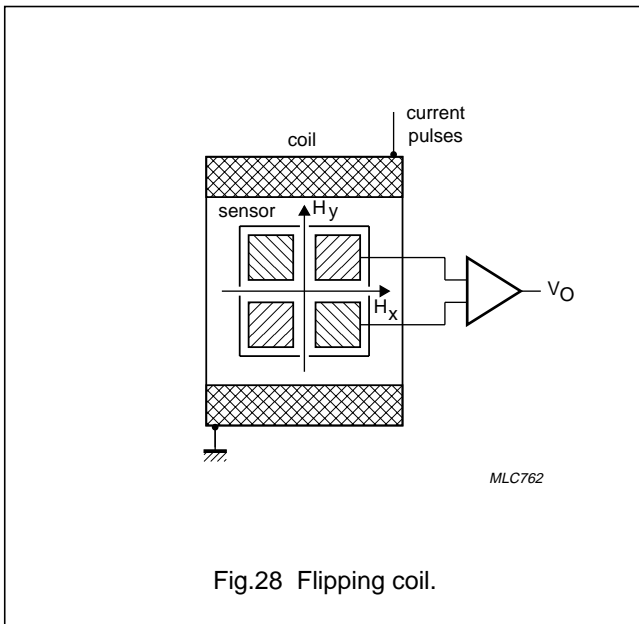

Fig.27 Butterfly curve including offset.

This reversible external magnetic field can be easily achieved with a coil wound around the sensor, consisting of current carrying wires, as described above. Depending on the direction of current pulses through this coil, positive and negative flipping fields in the x-direction ($+H_x$ and $-H_x$) are generated (see Fig.28).

Magnetoresistive sensors for magnetic field measurement

General



Flipping causes a change in the polarity of the sensor output signal and this can be used to separate the offset signal from the measured signal. Essentially, the unknown field in the 'normal' positive direction (plus the offset) is measured in one half of the cycle, while the unknown field in the 'inverted' negative direction (plus the offset) is measured in the second half. This results in two different outputs symmetrically positioned around the offset value. After high pass filtering and rectification a single, continuous value free of offset is output, smoothed by low pass filtering. See Figs 29 and 30.

Offset compensation using flipping requires additional external circuitry to recover the measured signal.

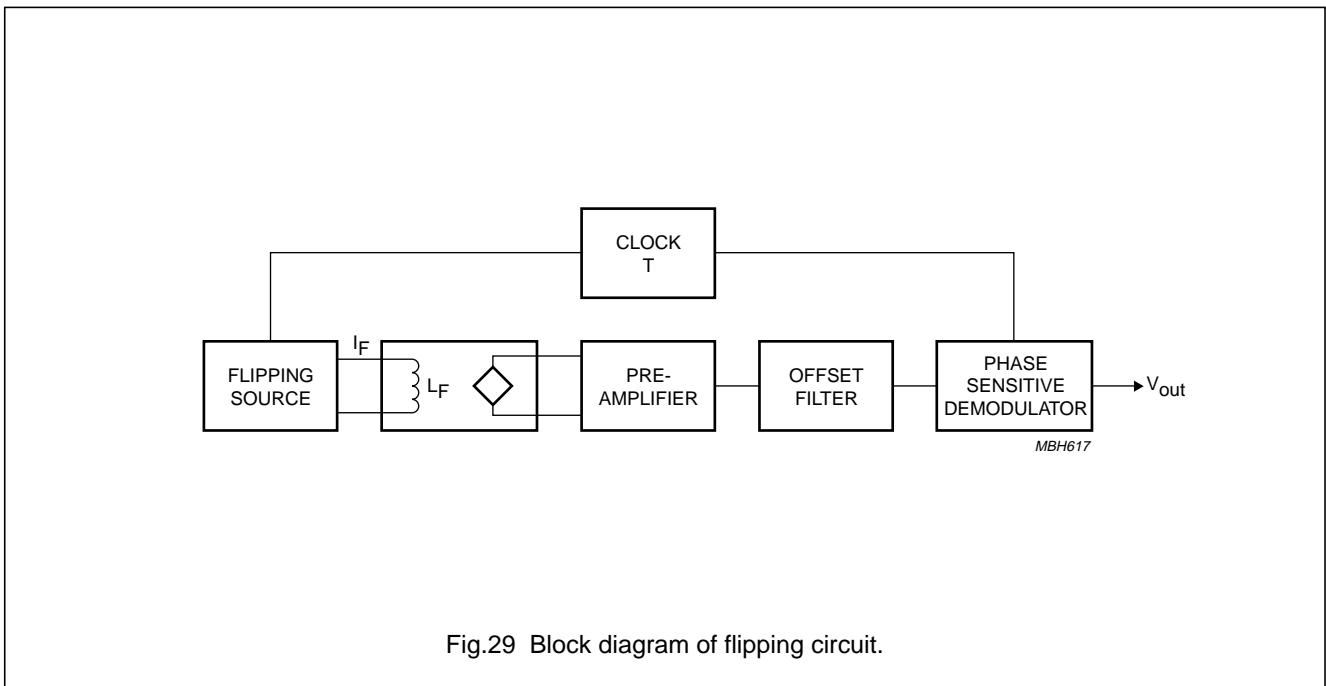

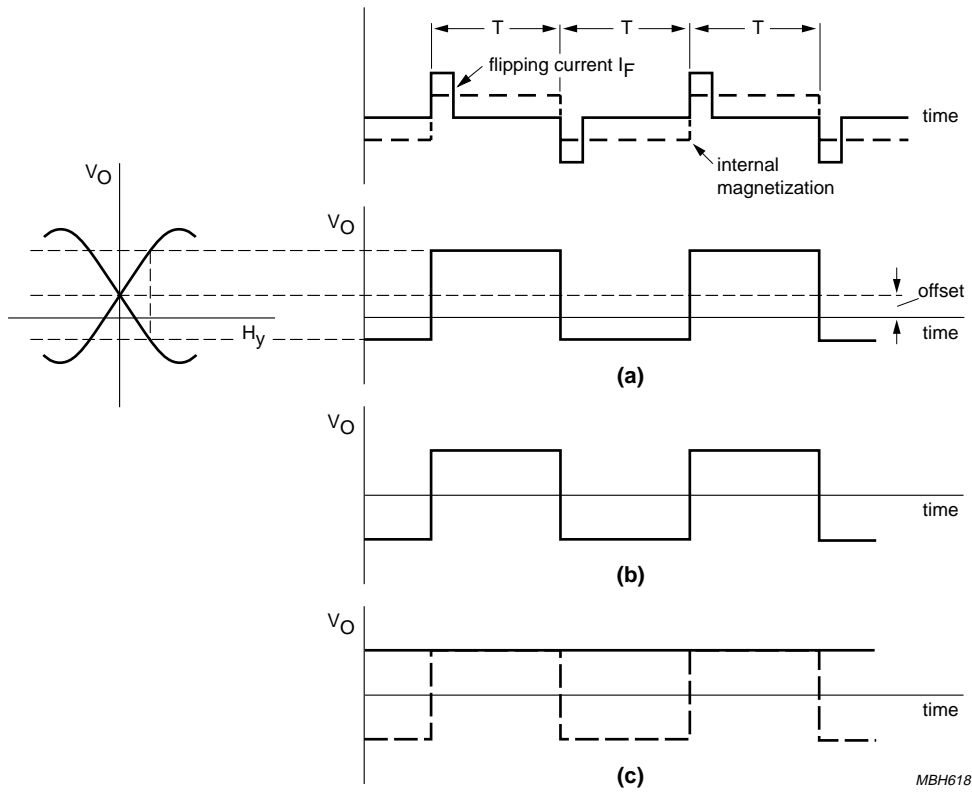

MBH618

Fig.30 Timing diagram for flipping circuit (a) output voltage; (b) filtered output voltage; (c) output voltage filtered and demodulated.

Magnetoresistive sensors for magnetic field measurement

General

SENSOR TEMPERATURE DRIFT

The sensitivity of MR sensors is also temperature dependent, with sensitivity decreasing as temperature increases (Fig.31). The effect on sensor output is certainly

not negligible, as it can produce a difference of a factor of three within a $-25\text{ }^{\circ}\text{C}$ to $+125\text{ }^{\circ}\text{C}$ temperature range, for fields up to 0.5 kA/m . This effect is not compensated for by the flipping action described in the last section.

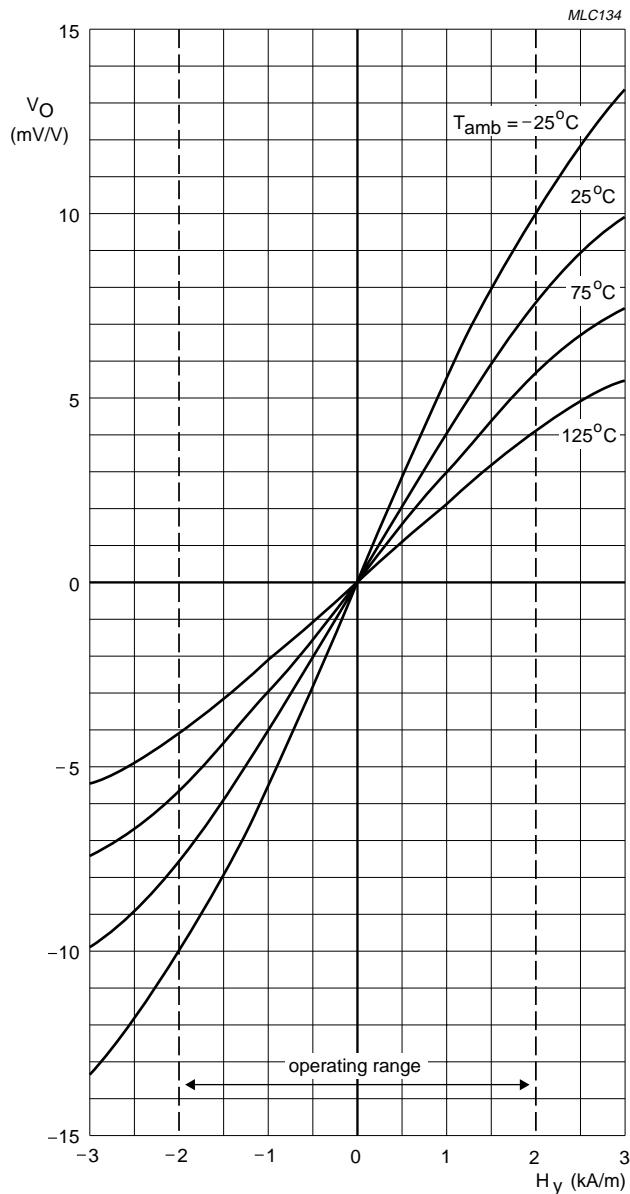

Fig.31 Output voltage ' V_O ' as a fraction of the supply voltage for a KMZ10B sensor, as a function of transverse field ' H_y ', at several temperatures.

Magnetoresistive sensors for magnetic field measurement

General

The simplest form of temperature compensation is to use a current source to supply to the sensor instead of a voltage source. In this case, the resulting reduction in sensitivity due to temperature is partially compensated by a corresponding increase in bridge resistance. Thus a current source not only improves the stability of the

output voltage 'V_o', and reduces the variation in sensitivity to a factor of approximately 1.5 (compared to a factor of three using the voltage source). However, this method requires a higher supply voltage, due to the voltage drop of the current source.

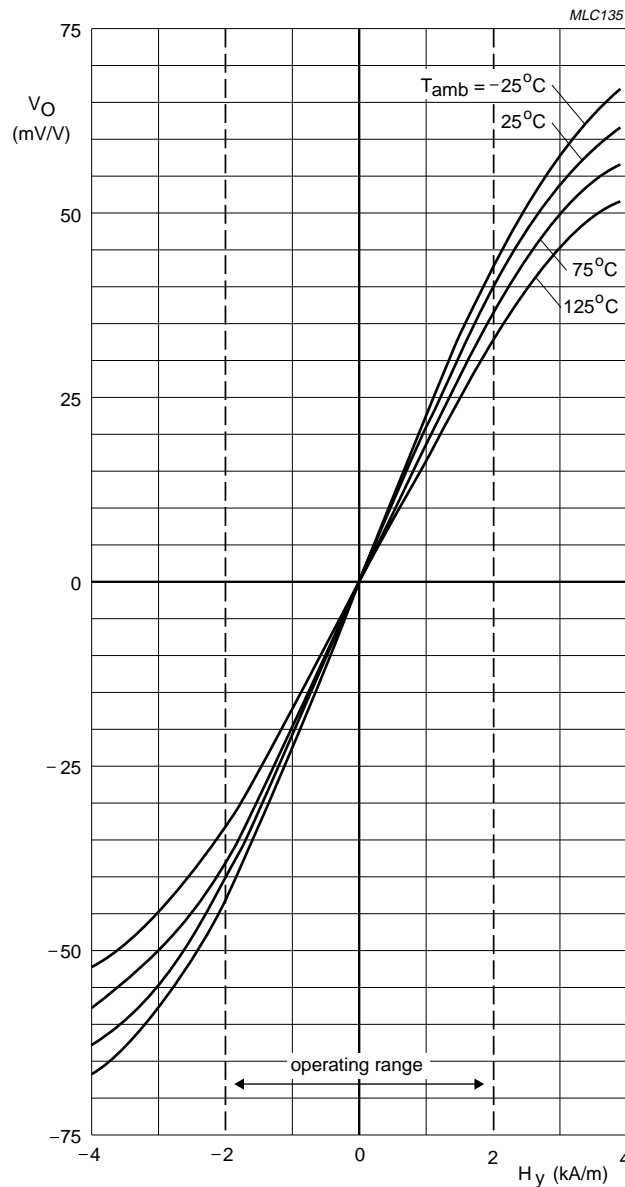

Fig.32 Output voltage 'V_o' of a KMZ10B sensor as a function of transverse field 'H_y' using a current source, for several temperatures.

Magnetoresistive sensors for magnetic field measurement

General

The optimal method of compensating for temperature dependent sensitivity differences in MR measurements of weak fields uses electro-magnetic feedback. As can be seen from the sensor characteristics in Figs 31 and 32, sensor output is completely independent of temperature changes at the point where no external field is applied (the null-point). By using an electro-magnetic feedback set-up, it is possible to ensure the sensor is always operated at this point.

To achieve this, a second compensation coil is wrapped around the sensor perpendicular to the flipping coil, so that the magnetic field produced by this coil is in the same plane as the field being measured.

Should the measured magnetic field vary, the sensor's output voltage will change, but the change will be different at different ambient temperatures. This voltage change is converted into a current by an integral controller and supplied to the compensation coil, which then itself produces a magnetic field proportional to the output voltage change caused by the change in measured field.

The magnetic field produced by the compensation coil is in the opposite direction to the measured field, so when it is added to the measured field, it compensates exactly for the change in the output signal, regardless of its actual, temperature-dependent value. This principle is called current compensation and because the sensor is always used at its 'zero' point, compensation current is independent of the actual sensitivity of the sensor or sensitivity drift with temperature.

Information on the measured magnetic signal is effectively given by the current fed to the compensating coil. If the field factor of the compensation coil is known, this simplifies calculation of the compensating field from the compensating current and therefore the calculation of the measured magnetic field. If this field factor is not precisely known, then the resistor performing the current/voltage conversion must be trimmed. Figure 34 shows a block diagram of a compensated sensor set-up including the flipping circuit.

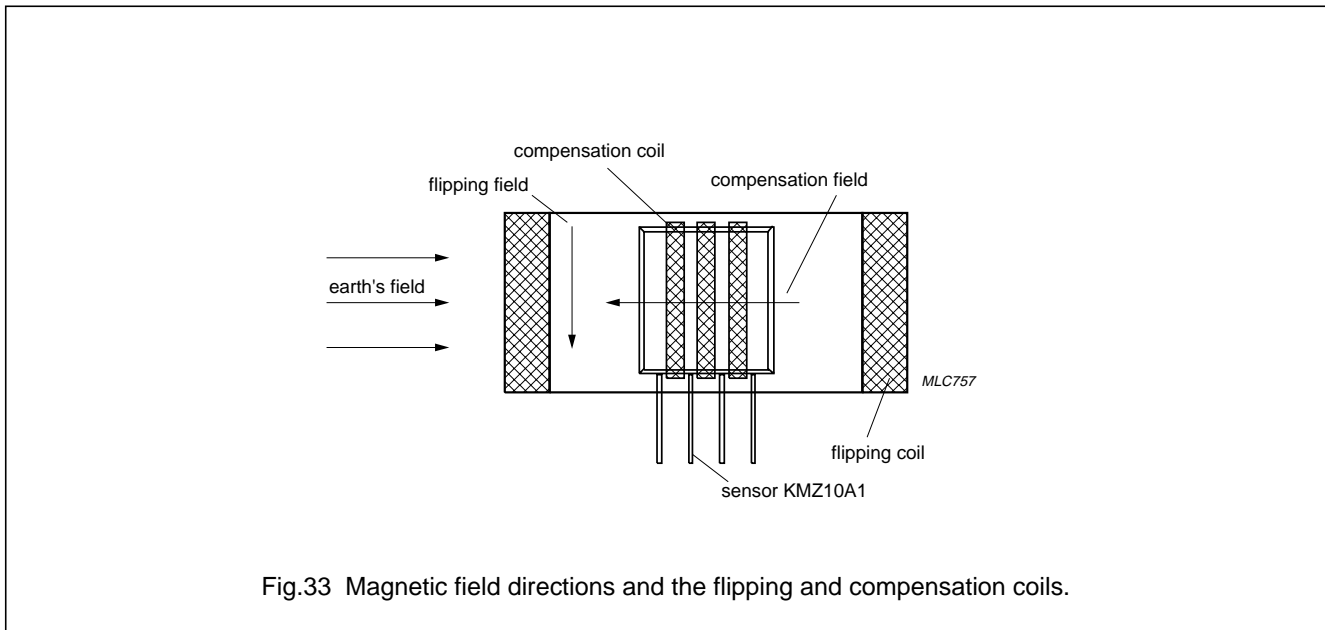

Magneto-resistive sensors for magnetic field measurement

General

The influence of other disturbing fields can also be eliminated provided they are well known, by adding a second current source to the compensating coil. Such fields might be those arising from the set-up housing, ferromagnetic components placed close to the sensor or magnetic fields from electrical motors.

The brief summary in Table 3 compares the types of compensation and their effects, so they can be assessed for their suitability in a given application. Because these options encompass a range of costs, the individual requirements of an application should be carefully analysed in terms of the performance gains versus relative costs.

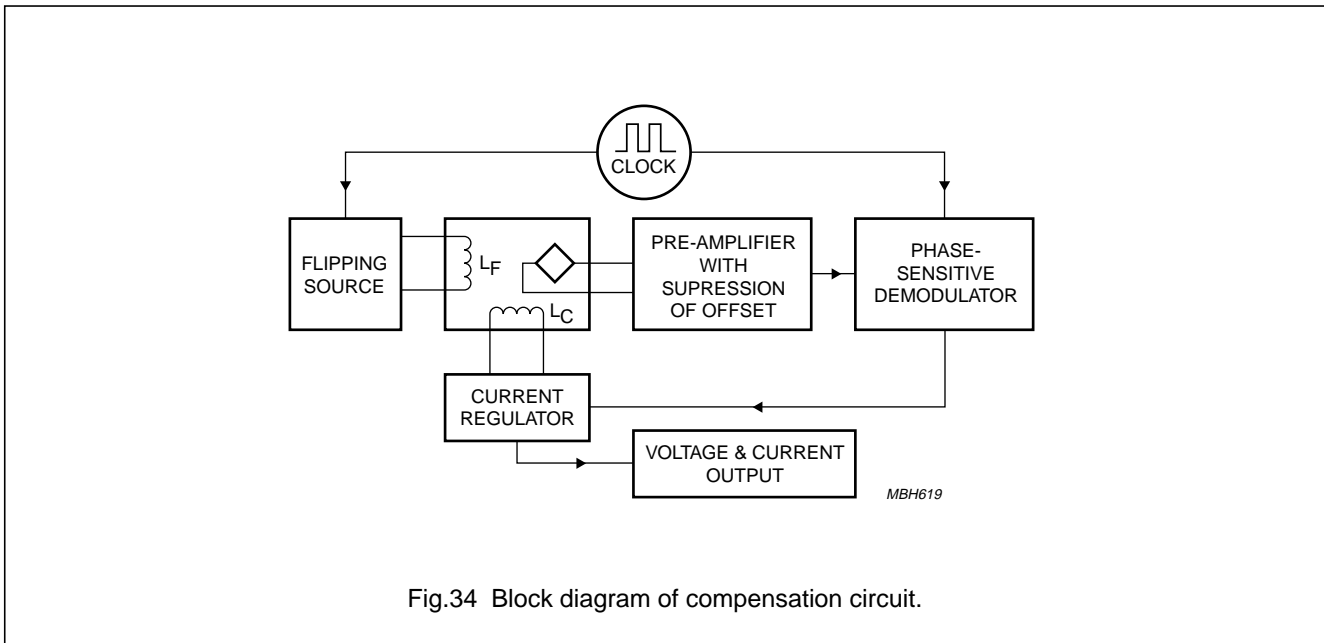

Table 4 Summary of compensation techniques

TECHNIQUE	EFFECT
Setting	avoids reduction in sensitivity due to constant stabilization field
Flipping	avoids reduction in sensitivity due to constant stabilization field, as well as compensating for sensor offset and offset drift due to temperature
Current supply	reduction of sensitivity drift with temperature by a factor of two
Electro-magnetic feedback	accurate compensation of sensitivity drift with temperature

Free Manuals Download Website

<http://myh66.com>

<http://usermanuals.us>

<http://www.somanuals.com>

<http://www.4manuals.cc>

<http://www.manual-lib.com>

<http://www.404manual.com>

<http://www.luxmanual.com>

<http://aubethermostatmanual.com>

Golf course search by state

<http://golfingnear.com>

Email search by domain

<http://emailbydomain.com>

Auto manuals search

<http://auto.somanuals.com>

TV manuals search

<http://tv.somanuals.com>