

Register your product and get support at

[www.philips.com/welcome](http://www.philips.com/welcome)

32PFL5405H/05  
37PFL5405H/05  
42PFL5405H/05  
32PFL5405H/12  
37PFL5405H/12  
42PFL5405H/12  
32PFL5405H/60  
37PFL5405H/60  
42PFL5405H/60  
32PFL5605H/05  
40PFL5605H/05  
46PFL5605H/05  
52PFL5605H/05  
32PFL56x5H/12  
40PFL56x5H/12  
46PFL5605H/12  
52PFL5605H/12  
40PFL56x5K/02  
40PFL5805H/12  
46PFL5805H/12  
32PFL6605H/12  
40PFL6605H/12

---

EN User Manual

# PHILIPS

# Contents

<b>1</b>	<b>Get started</b>	<b>3</b>	<b>6</b>	<b>Troubleshooting</b>	<b>46</b>
	Important	3		Contact us	46
	Enjoy HD TV	6		General TV issues	46
	Wall mount the TV	6		TV channel issues	46
	Product highlights	7		Picture issues	46
	Access more information	8		Sound issues	47
<b>2</b>	<b>Use your TV</b>	<b>9</b>		HDMI connection issues	47
	Overview	9		USB connection issues	48
	Side controls and indicators	9		PC connection issues	48
	Remote control	9	<b>7</b>	<b>Technical data</b>	<b>49</b>
	Basic TV menus	11		Overview	49
	Watch TV	13		Power and reception	49
	Watch a connected device	15		Display and sound	49
<b>3</b>	<b>Use more of your TV</b>	<b>16</b>		Display resolutions	49
	Use teletext	16		Multimedia	49
	Favourite channels	17		Connectivity	50
	Use EPG	17		Dimensions	50
	Use timers and locks	17	<b>8</b>	<b>Index</b>	<b>52</b>
	Use subtitles	18			
	Access multimedia	18			
	Use Scenea	19			
	Universal access	20			
<b>4</b>	<b>Set up the TV</b>	<b>21</b>			
	Change picture and sound settings	21			
	Change channel settings	22			
	Install channels	23			
	Change language settings	25			
	Change other settings	25			
	Update the TV software	26			
	Reinstall the TV	27			
<b>5</b>	<b>Connect the TV</b>	<b>28</b>			
	First connections	28			
	About cables	28			
	TV connectors overview	30			
	Connect devices	31			
	Connect more devices	37			
	Use Philips EasyLink	41			
	Use a CAM	45			

# 1 Get started

## Important

### Congratulations

Congratulations on your purchase, and welcome to Philips! To fully benefit from the support that Philips offers, register your TV at (<http://www.philips.com/welcome>).

### Safety

Read and understand all instructions before you use your TV. If damage is caused by failure to follow instructions, the warranty does not apply.

#### Risk of electric shock or fire!

Never expose the TV to rain or water. Never place liquid containers, such as vases, near the TV. If liquids are spilt on or into the TV, disconnect the TV from the power outlet immediately. Contact Philips Consumer Care to have the TV checked before use.

- Never insert objects into the ventilation slots or other openings on the TV.
- When the TV is swivelled, ensure that no strain is exerted on the power cord. Strain on the power cord can loosen connections and cause arcing.
- Never place the TV, remote control or batteries near naked flames or other heat sources, including direct sunlight. To prevent the spread of fire, keep candles or other flames away from the TV, remote control and batteries at all times.



#### Risk of short circuit or fire!

- Never expose the remote control or batteries to rain, water or excessive heat.

- Avoid force coming onto power plugs. Loose power plugs can cause arcing or fire.

#### Risk of injury or damage to the TV!

- Two people are required to lift and carry a TV that weighs more than 25 kg/55 lbs.
- When stand mounting the TV, use only the supplied stand. Secure the stand to the TV tightly. Place the TV on a flat, level surface that can support the combined weight of the TV and the stand.
- When wall mounting the TV, use only a wall mount that can support the weight of the TV. Secure the wall mount to a wall that can support the combined weight of the TV and wall mount. Koninklijke Philips Electronics N.V. bears no responsibility for improper wall mounting that result in accident, injury or damage.
- Before you connect the TV to the power outlet, ensure that the power voltage matches the value printed on the back of the TV. Never connect the TV to the power outlet if the voltage is different.

#### Risk of injury to children!

Follow these precautions to prevent the TV from toppling over and causing injury to children:

- Never place the TV on a surface covered by a cloth or other material that can be pulled away.
- Ensure that no part of the TV hangs over the edge of the mounting surface.
- Never place the TV on tall furniture, such as a bookcase, without anchoring both the furniture and TV to the wall or a suitable support.
- Educate children about the dangers of climbing on furniture to reach the TV.

#### Risk of overheating!

- Never install the TV in a confined space. Always leave a space of at least 4 inches around the TV for ventilation. Ensure curtains or other objects never cover the ventilation slots on the TV.

### Risk of injury, fire or power cord damage!

- Never place the TV or any objects on the power cord.
- To easily disconnect the TV power cord from the power outlet, ensure that you have full access to the power cord at all times.
- When you disconnect the power cord, always pull the plug, never the cable.
- Disconnect the TV from the socket and aerial before lightning storms. During lightning storms, never touch any part of the TV, power cord or aerial cable.

### Risk of hearing damage!

Avoid using earphones or headphones at high volumes or for prolonged periods of time.

### Low temperatures

If the TV is transported in temperatures below 5°C/41°F, unpack the TV and wait until the TV temperature matches room temperature before connecting the TV to the power socket.

### Screen care

- Risk of damage to the TV screen! Never touch, push, rub or strike the screen with any object.
- Unplug the TV before cleaning.
- Clean the TV and frame with a soft damp cloth. Never use substances such as alcohol, chemicals or household cleaners on the TV.
- To avoid deformations and colour fading, wipe off water drops as soon as possible.
- Avoid stationary images as much as possible. Stationary images are images that remain on-screen for extended periods of time. Stationary images include on-screen menus, black bars, time displays etc. If you must use stationary images, reduce screen contrast and brightness to avoid screen damage.

### End of use

Your product is designed and manufactured with high quality materials and components, which can be recycled and reused.



When this crossed-out wheeled bin symbol is attached to a product it means that the product is covered by the European Directive 2002/96/EC. Please inform yourself about the local separate collection system for electrical and electronic products.

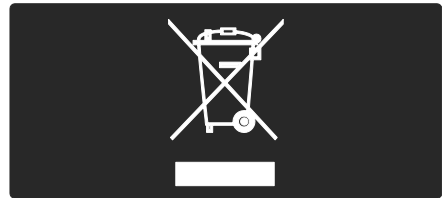

Please act according to your local rules and do not dispose of your old products with your normal household waste. Correct disposal of your old product helps to prevent potential negative consequences for the environment and human health.

Your product contains batteries covered by the European Directive 2006/66/EC, which cannot be disposed of with normal household waste. Please inform yourself about the local rules on separate collection of batteries because correct disposal helps to prevent negative consequences for the environment and human health.



## Green eco

This TV has been awarded the European Union Ecolabel for its environmental qualities.

A TV that is awarded the Ecolabel includes the following green eco features that contribute to energy-efficient use:

### Adjustable green eco settings

Access green eco settings while watching TV by pressing the green button on the remote control

These green eco settings include:

- **Energy-saving picture settings:** The [Energy saving] smart setting applies a combination of picture settings to reduce energy consumption.
- **Ambient light sensor:** To save energy, the built-in Ambient light sensor lowers the brightness of the TV screen when the surrounding light darkens.
- **Mute screen:** Turns off the TV display. Other functions, including sound, continue to operate normally. 'Muting' the screen saves energy if you just want to listen to audio from the TV.

See **Set up the TV > Change other settings > Green eco settings** (Page 25) for more information about these green eco settings.

### Built-in green eco settings

- **Low standby power consumption:** The class-leading and highly advanced power circuitry brings down the power consumption of the TV to an extremely low level, without losing out on the constant standby functionality.
- **Dedicated power switch:** Completely cut off power to the TV with the dedicated power switch located on the bottom of the set.
- **Advanced power management:** The advanced power management of this TV ensures the most efficient use of its energy. To view how your personalised TV settings affect the TV's relative power consumption, press **⬆** and select **[Setup] > [Watch demos] > [Active Control]**.

We continually focus on lowering the environmental impact of our innovative consumer products. We aim our efforts towards making environmental improvements during manufacturing, including reduction of harmful substances, promoting energy-efficient use and providing information on end of use and product recycling.



Thanks to our environmental efforts, this TV is awarded the European Ecolabel.

Find detailed information on standby energy consumption, warranty policy, spare parts and recycling of this TV at the Philips website for your country (<http://www.philips.com/>).

### Information on end of use

To find out about the correct disposal of this TV and batteries, see **Get started > Important > End of use** (Page 4).

## Use a Kensington lock

Your TV is equipped with a Kensington security slot on the bottom of the TV. Purchase a Kensington anti-theft lock (not supplied) to secure the TV.



## Enjoy HD TV

### Full HD content

This TV can display full High-Definition (HD) video content. To enjoy HD content, you must connect your TV to an HD source.

Contact your dealer for more information on where to obtain HD video content in your country.

Your TV can display HD video content from:

- a Blu-ray disc player, connected with an HDMI cable, playing a Blu-ray disc
- an upscaling DVD player, connected with an HDMI cable, playing a DVD disc
- an over-the-air HD broadcaster (DVB-T MPEG4)
- a digital HD receiver, connected with an HDMI cable, playing HD content from a cable or satellite operator
- an HD channel on your DVB-C network
- an HD game console (for example, X-Box 360 or PlayStation 3), connected with an HDMI cable, playing an HD game

### Position the TV

- Before positioning the TV, read all safety precautions. See **Get Started > Important > Safety** (Page 3).
- Position the TV where light does not shine directly on the screen.

- The ideal distance from which to watch TV is three times its diagonal screen size. For example, if the diagonal screen size of the TV is 116 cm/46", the ideal viewing distance is approx. 3.5m/138" from the front of the screen.
- While seated, your eyes should be level with the centre of the screen.

---

## Wall mount the TV

To mount the TV, purchase an appropriate TV mount for your set. Check your TV screen size and match it against the list below for the type of wall mount to purchase:

**81 cm/32 inches:** 200 mm x 200 mm, M6

**81 cm/32 inches:** 200 mm x 300 mm, M6

(For PFL6605 only)

**94 cm/37 inches:** 300 mm x 200 mm, M6

**102 cm/40 inches:** 200 mm x 200 mm, M6

**107 cm/42 inches:** 300 mm x 200 mm, M6

**117 cm/46 inches:** 300 mm x 300 mm, M8

**132 cm/52 inches:** 300 mm x 300 mm, M8

**Warning: Follow all instructions provided with the TV mount. Koninklijke Philips Electronics N.V. bears no responsibility for improper TV mounting that results in accident, injury or damage.**

To prevent damage to cables and connectors, be sure to leave a clearance of at least 5.5 cm/2.2" from the back of the TV.

**For 32-inch to 40-inch TVs (For PFL6605 only):**

Before you wall mount the TV, make a note of the correct length of the screw. You can determine the length of the screw by adding the thickness of your wall mount to the screw length shown in the graphic.

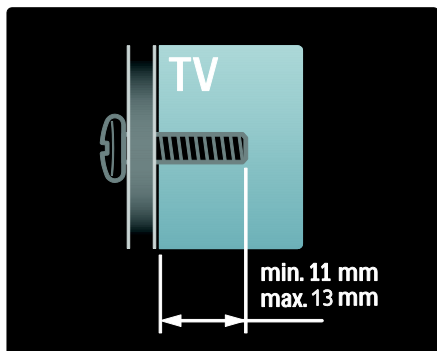

#### For 32 inch and 40 inch TVs

Before you wall mount the TV, make a note of the correct length of the screw. You can determine the length of the screw by adding the thickness of your wall mount to the screw length shown in the graphic.

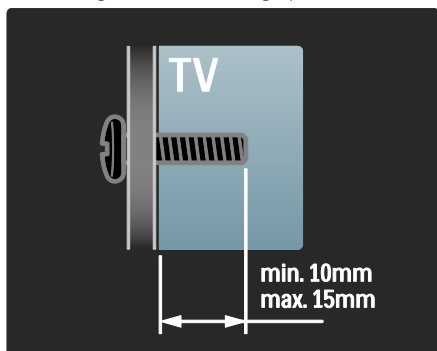

#### For 37 inch to 42 inch TVs

Before you wall mount the TV, make a note of the correct length of the screw. You can determine the length of the screw by adding the thickness of your wall mount to the screw length shown in the graphic.

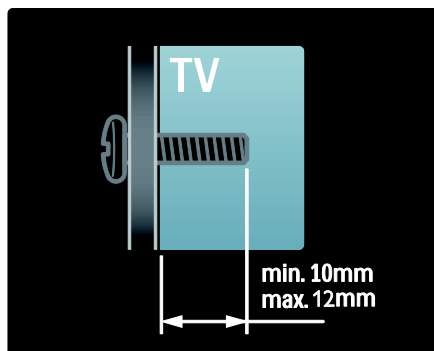

#### For 46 inch and 52 inch TVs

Before you wall mount the TV, make a note of the correct length of the screw. You can determine the length of the screw by adding the thickness of your wall mount to the screw length shown in the graphic.

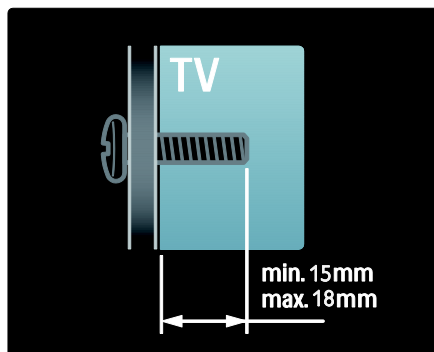

## Product highlights

### Full HD LCD display

This TV is equipped with a full High-Definition (HD) LCD display, supporting the maximum HD resolution of 1920 × 1080p.

This display offers a brilliant flicker-free progressive scan picture with optimum brightness and superb colors.

The LED backlight\* of the display offers exceptional picture contrast with exceptional energy saving.

**\*Note:** Certain models are equipped with an EEFL backlight display only. For detailed product information, go to (<http://www.philips.com/support>).

To enjoy HD content, you must connect to an HD source first; otherwise, the picture quality will be that of a normal TV. See **Get started > Enjoy HD TV > Full HD content** (Page 6).

## Digital TV

In addition to normal analogue TV broadcasts, your TV can receive digital terrestrial (DVB-T) broadcasts. Where available, your TV can also receive digital cable (DVB-C), digital satellite (DVB-S: **Not supported on all models**) and digital radio broadcasts.

DVB (Digital Video Broadcasting) gives you a better picture and better sound quality. Some digital broadcasters also include several audio (speech) and/or teletext languages with DVB.

## EPG

Electronic Programme Guide (EPG) is an on-screen guide available for digital channels. EPG allows you to:

- View a list of digital programmes being broadcast
- View upcoming programmes
- Group programmes by genre
- Set reminders when programmes start
- Set up preferred EPG channels

Notes:

- EPG is not available in all countries.
- For more information on EPG, see **Use more of your TV > Use EPG** (Page 17).

## Multimedia

View or play your own multimedia files (such as photos, music and videos) from the USB connection on the side of the TV.

See **Use more of your TV > Access multimedia** (Page 18).

---

## Access more information

### On-screen

You are reading the on-screen user manual. This manual contains all of the information you need to install and use this TV.

Access the user manual by selecting **[Help]** in the home menu.

Before carrying out instructions, temporarily close the user manual by pressing the yellow button on the remote control. Press the yellow button again to open the user manual at the same page.

### On the Internet

A printable PDF version of this user manual is available on the Internet. It contains the latest information and detailed feature explanations not covered in this on-screen user manual.

Access the PDF, as well as other product information, including FAQs and firmware upgrades, at (<http://www.philips.com/support>).



# 2 Use your TV

## Overview

This section gives you an overview of commonly used TV controls and functions.

## Side controls and indicators

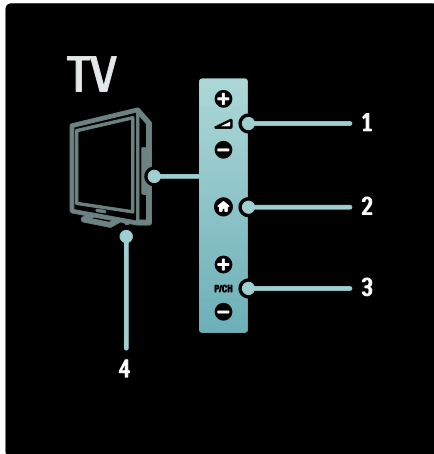

1. **▲ +/-** : Increases or decreases volume. In the home menu, these buttons allow you to move horizontally.
2. **🏠 (Home)**: Accesses the home menu. Press again to launch an activity in the home menu.
3. **P/CH +/-** : Switches to the next or previous channel. In the home menu, these buttons allow you to move vertically.
4. **Power**: Switches the TV on ('|') or off ('o').

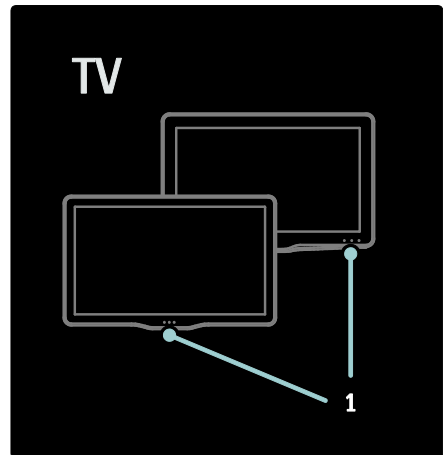

1. Standby indicator/remote control sensor.

## Remote control

### Overview



1. **⏻ (Standby)**: Switches the TV to standby if it is on. Switches on the TV if it is in standby.
2. **🏠 (Home)**: Accesses the home menu.
3. **☰ (Browse)**: Accesses the browse menu to select TV channel list, the Electronic Programme Guide and teletext.



4. **▲▼◀▶ (Navigation buttons)**: Navigates menus and selects items.
5. **⏮️⏭️ (Previous/Next)**: Switches channels. Also, skips through pages of a menu, and between tracks, albums or folders.
6. **OK**: Confirms an entry or selection.

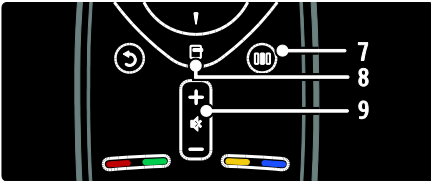

7. (Experience): Accesses the experience bar menu.

8. (Options): Accesses options for the current activity or selection.

9. +/- (Volume) and (Mute): Increases or decreases volume; mutes or restores audio.

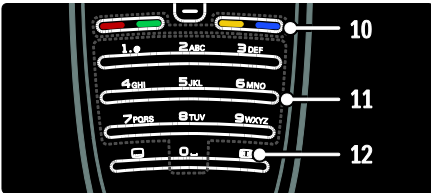

10. Colour buttons: Selects tasks or options.

11. 0-9 (Numeric buttons): Selects a channel or setting.

12. (Picture format): Selects a picture format.

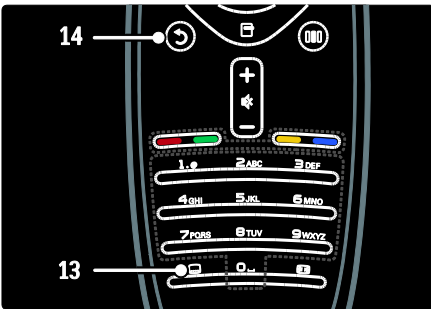

13. (Subtitle): Enables or disables subtitles.

14. (Back): Returns to a previous menu screen. Press and hold to return to watching TV.

## Batteries

Open the battery cover on the back of the remote control to insert the batteries (Type AAA-LR03-1.5 V). Make sure the + and - ends of the batteries line up correctly (+ and - are marked inside).

Remove the batteries if you are not using the remote control for a long time. Dispose of batteries according to the end of use directives. Read **Get started > Important > End of use** (Page 4).

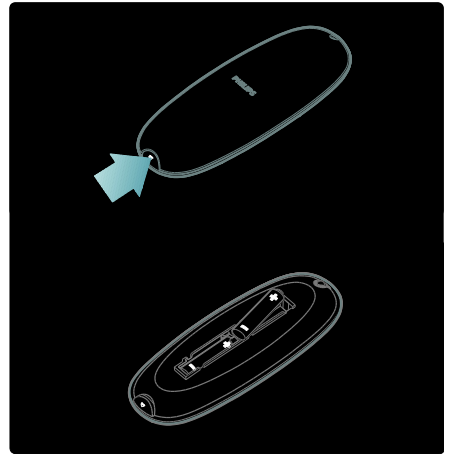

**Note:** The location of the battery compartment on some remote controls may be as follows:

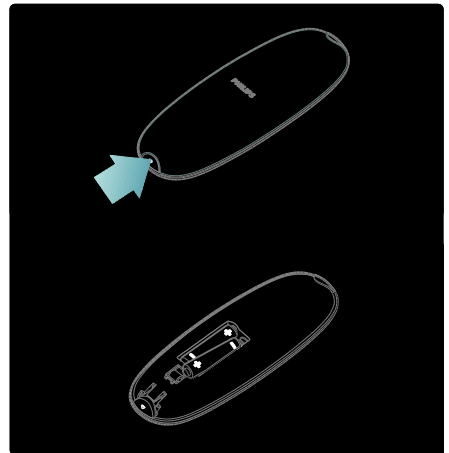

## Usage

When using the remote control, hold it close to the TV and point it at the remote control sensor.

Make sure that the line-of-sight between the remote control and TV is not blocked by furniture, walls or other objects. The following illustration is an example only -- the location of the remote control sensor may differ on your TV:

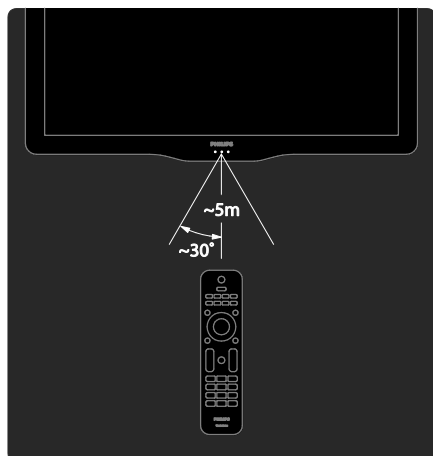

## On-screen remote control

An On-Screen Remote Control (OSRC) is available, which gives you easy access to commonly-used functions. Availability of on-screen buttons differs according to your TV setup.

### To access the OSRC

1. While watching TV or a connected device, press **OSRC**.
2. Select **[Show device keys]**, then press **OK**.
3. Use the **Navigation buttons** and **OK** to select and use an on-screen button.

## Basic TV menus

### Home

The home menu gives you easy access to connected devices, picture and sound settings, and other useful features.

1. Press **Home**.
2. Select an item in the home menu, then press **OK** to access the menu.
3. To exit the home menu, press **Home** or **Back**.



To start an activity, select the desired item with the **Navigation buttons**, then press **OK**:

- **[Help]**: Accesses the electronic user manual.
- **[Watch TV]**: Switches back to the antenna source if another source is selected.
- **[Browse USB]**: If a USB storage device is connected, accesses the content browser.
- **[Scenea]**: Switches to the Scenea wallpaper.
- **[Add your devices]**: Adds new devices to the home menu. Note that you must add a new device to the home menu in order to access it.
- **[Setup]**: Accesses menus that allow you to change picture, sound and other TV settings.

### Browse

The browse menu gives you easy access to:

- Electronic programme guide
- TV channel list
- Teletext

To access the browse menu, while watching TV, press **□**.



1. Press the **Navigation buttons** to select an item:

- **[Programme guide]:** Accesses the Electronic Programme Guide.
- **[Channel list]:** Accesses the TV channel list.
- **[Text]:** Accesses teletext.

2. Press **OK** to confirm your choice.

## Experience

Press **□** to access the experience bar menu, which provides a range of frequently-used settings.

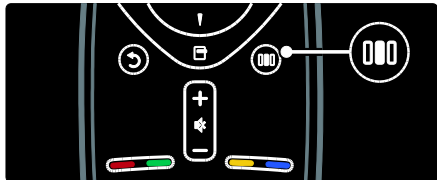

The experience bar menu gives you easy access to:

- **[Picture format]:** Changes the picture format.
- **[Smart picture]:** Frequently-used picture settings.
- **[Smart sound]:** Frequently-used sound settings.
- **[Speakers]:** Configure TV speakers for Philips EasyLink.
- **[Picture shift]:** Adjusts the position of the picture.

## Channel list

The channel list displays the TV channels and possible radio stations installed on your TV.

1. While watching TV, press **□**.
2. Select **[Channel list]**, then press **OK**.

3. Select a channel, then press **OK** to access the channel.

4. Press **↶** to exit the channel list without changing the channel.

## Add your devices

After you connect a device to the TV, add this device in the home menu for easy access.

In the home menu, select **[Add your devices]**, then press **OK**. Follow the instructions on-screen to add the device to the home menu.

To remove a device from the home menu, select the item, press **□** and select **[Remove this device]**. Press **OK**.

## Setup

**[Setup]** in the home menu allows you to change most of the TV settings, including:

- Picture or sound settings
- Installation or update of TV channels
- Update of TV software
- Other special features



1. In the home menu, select **[Setup]**, then press **OK**.

2. Select an item with the **Navigation buttons**, then press **OK**:

- **[Personalise picture and sound]:** Guides you through picture and sound settings.
- **[Advanced TV settings]:** Advanced picture and sound settings.
- **[Search for channels]** or **[Search for satellite]:** Guides you through antenna or satellite (if available) channel installation.
- **[Advanced channel settings]** or **[Advanced satellite settings]:** Advanced channel settings.
- **[Update software]:** Guides you through an update of the TV software.
- **[Advanced software update]:** Advanced TV update settings.
- **[Watch demos]:** Demos of special features available with the TV.

## Options

Option menus offer convenient settings related to what is on-screen.

1. Press  to see what options are available.
2. To exit, press  again.

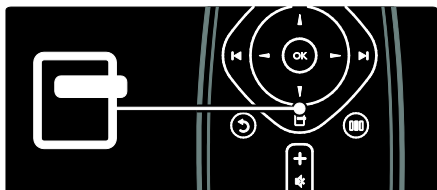

## Watch TV

### Switch on/off or to standby

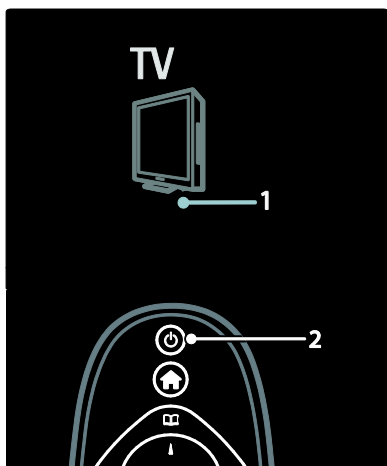

#### To switch on

- If the front LED indicator is off, press the power switch (1) on the bottom of the TV to the 'I' position.
- If the front LED indicator is red, press  on the remote control (2). Alternatively, switch on the TV from standby by pressing any key on the side of the TV.

#### Notes:

- The front LED indicator does not turn on when the TV is switched on.
- The TV requires some time to start up. During this time, the TV will not respond to the remote control or side controls. This is normal behavior.

#### To switch to standby



Press  on the remote control. The front LED indicator switches to red.

#### To switch off



Press the power switch on the bottom of the TV to the 'o' position. The TV switches off.

Though your TV consumes very little power when in standby, energy continues to be consumed. When not in use for an extended period of time, switch off the TV using the power switch on the bottom of the set.

#### Switch channels

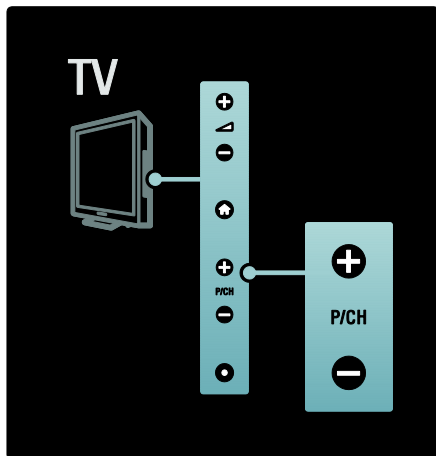
- Press  or  on the remote control or **P/CH +/-** on the side of the TV.



- Press  then select **[Channel list]** to use the channel list.
- Press  to return to the previously-viewed channel.
- Enter a channel number using the **Numeric buttons**.

#### To view analogue or digital channels only

Filter the channel list to access analogue or digital channels only.

1. In the channel list, press .
2. Select **[Select list]** > **[Analogue]** or **[Digital]**, then press **OK**.

Depending on your selection, only digital or analogue channels become available.

## Adjust volume

### To increase or decrease volume

- Press **+/-** on the remote control.
- Press **▲ +/-** on the side of the TV.

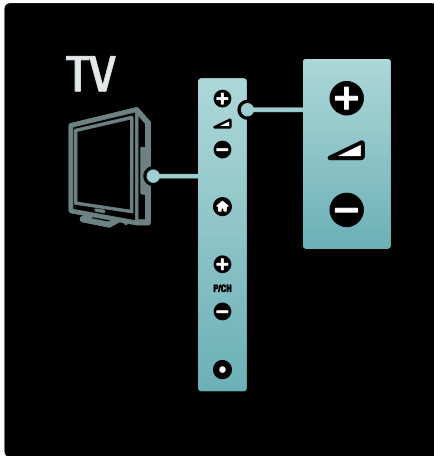

### To mute or unmute sound

- Press **⊘** to mute the sound.
- Press **⊘** again to restore the sound.

Use the **[Sound]** menu to adjust headphone volume. For more information, see **Setup the TV > Change picture and sound settings > More sound settings** (Page 22).

### Use Smart picture settings

Use the **[Smart picture]** experience bar to access frequently-used picture settings.

1. While watching TV, press **⏏**.
2. Select **[Smart picture]**, then select one of the following settings:

- **[Personal]**: Sets the TV to your personal preferences set in the **[Picture]** menus in **[Setup]**.
- **[Vivid]**: Rich and dynamic settings, ideal for daylight use.
- **[Natural]**: A natural picture setting.
- **[Cinema]**: Ideal settings for watching movies.
- **[Game]**: Ideal settings for gaming.
- **[Energy saving]**: The most energy-conscious settings.
- **[Standard]**: Adjusts picture settings to suit most environments and types of video. Factory default settings.

- **[Photo]**: Ideal settings for viewing photos.
  - **[Custom]**: Allows you to customise and store personal picture settings.
3. Press **OK** to confirm your choice.
  4. Press **⏏** to exit.

### Use Smart sound settings

Use the **[Smart sound]** experience bar to access frequently-used sound settings.

1. While watching TV, press **⏏**.
  2. Select **[Smart sound]**, then select one of the following settings:
- **[Personal]**: Sets the TV to your personal preferences set in the **[Sound]** menus in **[Setup]**.
  - **[Standard]**: Adjusts sound settings to suit most environments and types of audio.
  - **[News]**: Applies sound settings ideally suited for spoken audio, such as the news.
  - **[Movie]**: Applies sound settings ideally suited for movies.
  - **[Game]**: Ideal settings for gaming.
  - **[Drama]**: Applies sound settings ideally suited for drama.
  - **[Sports]**: Applies sound settings ideally suited for sports.

3. Press **OK** to confirm your choice.
4. Press **⏏** to exit.

### Change picture format

Change the picture format to suit your viewing experience.

1. Press **⏏**.
2. Select a picture format, then press **OK** to confirm your choice.

**Note:** Picture formats are also accessible via the experience bar menu (**⏏**) and **[Setup]** menu.

The following picture formats can be selected:

- **[Auto fill]**: Adjusts the picture to fill the screen (subtitles remain visible). Recommended for minimal screen distortion but not for HD or PC.

- **[Auto zoom]:** Enlarges the picture to fill the screen. Recommended for minimal screen distortion but not for HD or PC.
- **[Super zoom]:** Removes the black bars on the sides of 4:3 broadcasts. Not recommended for HD or PC.
- **[Movie expand 16:9]:** Scales the classic 4:3 format to 16:9. Not recommended for HD or PC.
- **[Wide screen]:** Stretches the classic 4:3 format to 16:9.
- **[Unscaled]:** Provides maximum detail for PC. Only available when **[PC mode]** is enabled in the **[Picture]** menu.

#### Notes:

- Depending on the picture source, some picture formats are not available and will not be seen on-screen.

---

## Watch a connected device

### Add new device

#### Notes:

- Before watching a connected device, you must add it to the home menu.
- HDMI ARC compliant devices connected to the **HDMI ARC** connector on the TV are automatically added to the home menu.

1. Connect and switch on the device.
2. Press **⬆️**.
3. Select **[Add your devices]**, then press **OK**. Follow the on-screen instructions.

### Watch connected device

1. Press **⬆️**.
2. Select the device from the home menu.
3. Press **OK** to confirm your choice.

# 3 Use more of your TV

## Use teletext

### Select a page

1. Press **□**.
2. Select **[Text]**, then press **OK**.
3. Select a page by:
  - Entering the page number with the **Numeric buttons**.
  - Pressing **▲▼** or **▶◀** to view the next or previous page.
  - Pressing the **Colour buttons** to select a colour coded item.
4. Press **↶** to exit teletext.

### Access teletext options

1. When in teletext, press **□**.
2. Select an option:
  - **[Freeze page] / [Unfreeze page]:** Freezes or unfreezes the current page.
  - **[Dual screen] / [Full screen]:** Enables or disables dual screen teletext, which splits the current channel or source to the left of the screen, with teletext on the right.
  - **[T.O.P. overview]:** Table Of Pages (T.O.P.) teletext broadcasts allow you to jump from one subject to another without using page numbers.
  - **[Enlarge] / [Normal view]:** For more comfortable reading, you can enlarge the teletext page. Press the **Navigation buttons** to move around the enlarged screen.
  - **[Reveal]:** Hides or reveals hidden information on a page, such as solutions to riddles or puzzles.
  - **[Cycle subpages]:** Cycles through subpages automatically if subpages are available.
  - **[Language]:** Switches to a different language group to display a language correctly when that language uses a different character set.

3. Press **□** to exit the options menu.

### Select a teletext language

Some digital TV broadcasters have several teletext languages available. You can set your primary and secondary language.

1. Press **↑**.
2. Select **[Setup] > [Advanced channel settings]** or **[Advanced satellite settings] > [Languages] > [Primary Text]** or **[Secondary Text]**.
3. Select your preferred teletext languages, then press **OK**.

### Select subpages

A teletext page number can hold several subpages. These subpages are shown on a bar next to the main page number.

When available on a teletext page, press **◀** or **▶** to select subpages.

### Search teletext

1. When in teletext, press **OK** to highlight the first word or number.
2. Press the **Navigation buttons** to skip to the word or number to search.
3. Press **OK** to begin the search.
4. Press **▲** until no word or number is highlighted to exit the search.

### Use digital teletext

Some digital TV broadcasters offer dedicated digital text or interactive services on their digital TV channels, for example, BBC1.

When in digital teletext:

- Press the **Navigation buttons** to select or highlight items.
- Use the **Colour buttons** to select an option, then press **OK** to confirm or activate.

**Note:** Digital text services are blocked when subtitles are broadcast and **[Subtitles]** are enabled. Read **Use more of your TV > Use subtitles** (Page 18).

### Use Teletext 2.5

Teletext 2.5 offers more colours and better graphics than normal teletext. If Teletext 2.5 is broadcast by a channel, it is switched on by default.



## To switch Teletext 2.5 on or off

1. Press **⬆**.
2. Select **[Setup]** > **[Advanced TV settings]** > **[Preferences]** > **[Text 2.5]** > **[On]** or **[Off]**, then press **OK**.

## Favourite channels

### Add or remove channels

1. Press **□**.
2. Select **[Channel list:]**, then press **OK**.
3. Press **⊞**.
4. Select **[Mark as favourite]** or **[Unmark as favourite]**, then press **OK**.

A star appears in the channel grid, indicating that the channel is added to the favourite list. The star disappears if you remove the channel from the favourite list.

### Select a favourite list

View only channels in a favourite list, or view all channels if a favourite list is currently selected.

1. In the channel list, press **⊞**.
2. Select **[Select list]** > **[Favourites]** to display channels in a favourite list, or **[All]** to display all channels.
3. Press **OK** to confirm your choice.

## Use EPG

### Overview

The Electronic Programme Guide (EPG) is an on-screen guide available for digital channels. EPG allows you to:

- View a list of digital programmes being broadcast
- View upcoming programmes
- Group programmes by genre
- Set reminders when programmes start
- Set up preferred EPG channels

**Note:** EPG is not available in all countries.

### Switch on EPG

1. Press **□**.
2. Select **[Programme guide]**, then press **OK**.

## EPG options

Use the EPG options menu to set or clear reminders, change day and access other useful EPG options. Depending on the broadcast service, these options are available only for seven or eight days.

1. When in EPG, press **⊞**.
2. Press the **Navigation buttons** and **OK** to select and adjust one of the following settings:

- **[Set reminder]:** Sets programme reminders.
- **[Clear reminder]:** Clears programme reminders.
- **[Change day]:** Sets the EPG day. Select **[Today]**, **[Next day]** or **[Previous day]**.
- **[More info]:** Views programme information.
- **[Search by genre]:** Searches TV programmes by genre.
- **[Scheduled reminders]:** Lists programmes reminders.
- **[Update Programme guide]:** Updates the latest programme information.

## Use timers and locks

### Sleeptimer

Sleeptimer switches the TV to standby after a pre-defined period of time. You can always switch off your TV earlier or reset the sleeptimer during the countdown.

1. Press **⬆**.
2. Select **[Setup]** > **[Advanced TV settings]** > **[Preferences]** > **[Sleeptimer]**.
3. Press the **Navigation buttons** to set the sleeptimer. The sleeptimer can be set up to 180 minutes, in steps of five minutes. The sleeptimer is switched off if it is set to zero minutes.
4. Press **OK** to activate the sleep timer. The TV switches to standby after the set period of time.

## Child lock

You can prevent your children watching TV by locking the TV.

### Set or change the child lock code

1. Press **Home**.
2. Select **[Setup]** > **[Advanced channel settings]** or **[Advanced satellite settings]** > **[Child lock]** > **[Set code]** or **[Change code]**.
3. Enter the code with the **Numeric buttons**.

**Tip:** If you forget your code, enter '8888' to override any existing codes.

### Lock or unlock channels

1. In the child lock menu, select **[Channel lock]**.
2. Enter the child lock code with the **Numeric buttons**. The **[Channel lock]** menu appears.
3. Select channels to lock or unlock.

## Parental rating

Some digital broadcasters rate their programmes according to age. You can set your TV to display only programmes with age ratings higher than your child's age.

1. Press **Home**.
2. Select **[Setup]** > **[Advanced channel settings]** or **[Advanced satellite settings]** > **[Child lock]** > **[Parental rating]**. A message appears prompting you to enter the child lock code.
3. Enter the child lock code with the **Numeric buttons**.
4. Select an age rating, then press **OK**. All programmes beyond the selected age rating are blocked.

For information on child lock codes, see **Use more of your TV > Use timers and locks > Child lock** (Page 18).

---

## Use subtitles

### On analogue channels

1. Switch the TV to an analogue TV channel.
2. Press **Text**, then select **[Text]** and press **OK**.

3. Enter the three number page number of the subtitles page (usually '888').
4. Press **Exit** to exit teletext. Subtitles display if available.

### On digital channels

1. Press **Subtitles**.
  2. In the menu that appears, select **[Off]**, **[On]** or **[On during mute]**, then press **OK**.
- Note:** With **[On during mute]**, the TV displays subtitles only when the sound is muted with **Mute**.

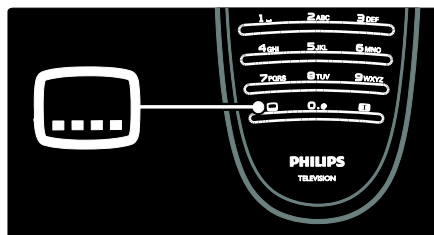

### Subtitle language

This feature is only supported on selected digital channels.

1. While watching TV, press **Subtitles**.
2. Select **[Subtitles]**.
3. Select a subtitle language from the list, then press **OK**.

**Note:** More information about language settings is available in **Set up the TV > Change language settings > Audio, Subtitle, Teletext languages** (Page 25).

---

## Access multimedia

### Browse USB

You can view photos or play music and videos on TV from a USB storage device.

**Caution:** Philips is not responsible if the USB storage device is not supported nor is it responsible for damage or loss of data from the device.

You can access the USB content browser using one of the following methods:

- When watching TV, connect the USB device to the USB port on the side of your TV.

- 1. Press .
- 2. Select **[Browse USB]**, then press **OK**.

### View slideshow

Press the **Navigation buttons** to select a picture, then press **OK**.

- To pause or stop playback, press **OK** again.
- To jump to the previous or next file, press **◀** or **▶**.
- Press  to exit content browser.

Press  to access or exit the following settings:

- **[Show info]**: Displays the file information.
- **[Stop]**: Stops slideshow.
- **[Rotate]**: Rotates the file.
- **[Repeat]**: Repeats the slideshow.
- **[Play once]**: Plays the file once.
- **[Shuffle off] / [Shuffle on]**: Enables or disables random display of pictures in the slideshow.
- **[Slideshow speed]**: Sets the display time for each picture in the slideshow.
- **[Slideshow transition]**: Sets the transition from one picture to the next.
- **[Set as Scenea]**: Sets the selected picture as wallpaper on the TV.

### Listen to music

Press the **Navigation buttons** to select a music track, then press **OK**.

- Press **◀** / **▶** to fast rewind or fast forward a track.
- Press  to exit content browser.

Press  to access or exit the following settings:

- **[Stop]**: Stops audio playback.
- **[Repeat]**: Repeats a song or an album.
- **[Play once]** Plays the file once.
- **[Shuffle on] / [Shuffle off]**: Enables or disables random play of songs.

### Watch video

Press the **Navigation buttons** to select a video file, then press **OK**.



- Press **◀** or **▶** to rewind or fast forward a file.
- Press  to exit the content browser.

During video playback, press  to access the following settings:



- **[Stop]**: Stops playback.
- **[Repeat]**: Repeats a video.
- **[Shuffle on] / [Shuffle off]**: Enables or disables random play of videos.

### Listen to digital radio

If digital broadcasting is available, digital radio channels are installed automatically during installation.

1. While watching TV, press .
2. Select **[Channel list:]**, then press **OK**.
3. In the channel list, press .
4. Select **[Select list] > [Radio]**, then press **OK**.
5. Select a radio channel, then press **OK**.

You can listen to satellite radio broadcast (if available).

1. While watching TV, press .
2. Select **[Channel list:]**, then press **OK**.
3. In the channel list, press .
4. Select **[TV/Radio] > [Radio]**, then press **OK**.

## Use Scenea

### Activate Scenea



You can use Scenea to display a picture as wallpaper on your TV. Make sure that the location of your TV is set to **[Home]** mode.

1. Press .
2. Select **[Scenea]**, then press **OK**.  
The default or pre-loaded picture is displayed.

**Note:** If the sleep timer is off, the wallpaper is displayed for 240 minutes. Otherwise, it is displayed for the duration of the sleeptimer. For more information on the sleeptimer, see **Use more of your TV > Use timers and locks > Sleeptimer** (Page 17).

### Set a picture as Scenea

**Note:** The file size of the picture must not be more than 1 MB.

1. Connect the USB storage device to the TV.
2. Press .
3. Select **[Browse USB]**, then press **OK**.
4. Select a picture, then press .
5. Select **[Set as Scenea]**, then press **OK**.
6. Select **[Yes]**, then press **OK**.
7. Press any key to exit Scenea.

---

## Universal access

### Enable universal access

Where supported by your digital TV broadcaster, this TV allows special audio and subtitles for the hearing impaired, as well as special audio for the visually impaired.



To enable these features, you must turn on universal access in the **[Preferences]** menu.

1. Press .
2. Select **[Setup]** > **[Advanced TV settings]** > **[Preferences]** > **[Universal access]** > **[On]**, then press **OK**.

### Hearing impaired

Some digital TV channels broadcast special audio and subtitles adapted for people who are hearing impaired.

#### To switch on hearing impaired audio and subtitles (if available)



1. While watching TV, press .
2. Press the red button to select **[Hearing impaired]**.
3. Press the green button to switch on hearing impaired audio and subtitles, press the red button to switch it off.
4. Press .

**Tip:** To verify whether a hearing impaired audio language is available, press  and select **[Audio language]**. Languages with an ear icon indicate hearing impaired support.

### Visually impaired

Some digital TV channels broadcast special audio adapted for people who are visually impaired. The normal audio is mixed with extra commentary.

#### To switch on visually impaired audio (if available)

1. While watching TV, press .
2. Press the green button to select **[Visually impaired]**.
3. Use the following buttons to select:
  - **Red - [Off]:** Turn off visually impaired audio.
  - **Yellow - [Headphones]:** Hear visually impaired audio from headphones only.
  - **Green - [Speakers]:** Hear visually impaired audio from speakers only.
  - **Blue - [Speakers + headphones]:** Hear visually impaired audio from speakers and headphones only.
4. Press  to exit.

**Note:** The green and yellow buttons are not applicable if EasyLink Remote Control is enabled. For more information, see **Connect the TV > Use Philips EasyLink > EasyLink features** (Page 41).

**Tip:** To verify whether visually impaired audio is available, press  and select **[Audio language]**. Languages with an eye icon indicate visually impaired support.

#### Adjust volume for the visually impaired

1. In the **[Universal access]** menu, press the yellow button to select **[Mixed volume]**.
2. Press the **Navigation buttons** to move the slider up or down, then press **OK**.
3. Press  to exit.

#### Audio feedback for the visually impaired

This feature enables audio feedback when buttons are pressed on the remote control or TV.

1. In the **[Universal access]** menu, press the blue button to select **[Key beep]**.
2. Press the green button to turn on audio feedback or press the red button to turn it off.
3. Press  to exit.

# 4 Set up the TV

## Change picture and sound settings

### Settings assistant

Use the settings assistant to guide you through the picture and sound settings.

1. While watching TV, press **▲**.
2. Select **[Setup]** > **[Personalise picture and sound]**, then press **OK**.
3. Select **[Start]**, then press **OK**.

Follow the on-screen instructions to choose your preferred settings.

### Smart picture settings

Use the **[Smart picture]** experience bar to access frequently-used picture settings.

1. While watching TV, press **000**.
2. Select **[Smart picture]**, then select one of the following settings:

- **[Personal]**: Sets the TV to your personal preferences set in the **[Picture]** menus in **[Setup]**.
  - **[Vivid]**: Rich and dynamic settings, ideal for daylight use.
  - **[Natural]**: A natural picture setting.
  - **[Cinema]**: Ideal settings for watching movies.
  - **[Game]**: Ideal settings for gaming.
  - **[Energy saving]**: The most energy-conscious settings.
  - **[Standard]**: Adjusts picture settings to suit most environments and types of video. Factory default settings.
  - **[Photo]**: Ideal settings for viewing photos.
  - **[Custom]**: Allows you to customise and store personal picture settings.
3. Press **OK** to confirm your choice.
  4. Press **↶** to exit.

### More picture settings

1. Press **▲**.
2. Select **[Setup]** > **[Advanced TV settings]** > **[Picture]**, then press **OK**.
3. Select a setting to adjust:

- **[Smart picture]**: Accesses pre-defined smart picture settings.
- **[Reset]**: Resets to factory default settings.
- **[Contrast]**: Adjusts the intensity of bright areas, keeping dark areas unchanged.
- **[Brightness]**: Adjusts the intensity and details of dark areas.
- **[Colour]**: Adjusts colour saturation.
- **[Hue]**: Compensates colour variations in NTSC encoded transmissions.
- **[Sharpness]**: Adjusts sharpness in the image.
- **[Noise reduction]**: Filters and reduces noise in an image.
- **[Tint]**: Adjusts the colour balance in an image.
- **[Custom tint]**: Customises tint setting.
- **[Pixel Plus HD]**: Accesses advanced settings, including **[HD Natural Motion]**, **[100 Hz Clear LCD]**, **[Advanced sharpness]**, **[Dynamic contrast]**, **[Dynamic backlight]**, **[MPEG artefact reduction]**, **[Colour enhancement]**, **[Gamma]**.
- **[PC mode]**: Enables picture settings adjustment when a PC is connected to the TV via HDMI. If enabled, you can select **[Picture format]** > **[Unscaled]** which provides maximum detail for display of PC content.
- **[Light sensor]**: Adjusts settings dynamically to match lighting conditions.
- **[Picture format]**: Changes the picture format.
- **[Screen edges]**: Changes the picture size.
- **[Picture shift]**: Adjusts the position of the picture.

### Smart sound settings

Use the **[Smart sound]** experience bar to access frequently-used sound settings.

1. While watching TV, press **000**.
2. Select **[Smart sound]**, then select one of the following settings:

- **[Personal]**: Sets the TV to your personal preferences set in the **[Sound]** menu in **[Setup]**.
  - **[Standard]**: Adjusts sound settings to suit most environments and types of audio.
  - **[News]**: Applies sound settings ideally suited for spoken audio, such as the news.
  - **[Movie]**: Applies sound settings ideally suited for movies.
  - **[Game]**: Ideal settings for gaming.
  - **[Drama]**: Applies sound settings ideally suited for drama.
  - **[Sports]**: Applies sound settings ideally suited for sports.
3. Press **OK** to confirm your choice.
  4. Press **↶** to exit.

### More sound settings

1. Press **⬆**.
2. Select **[Setup]** > **[Advanced TV settings]** > **[Sound]**, then press **OK**.
3. Select a setting to adjust:
  - **[Smart sound]**: Accesses pre-defined smart sound settings.
  - **[Reset]**: Resets to factory default settings.
  - **[Bass]**: Adjusts the bass level.
  - **[Treble]**: Adjusts the treble level.
  - **[Surround]**: Enables spatial sound.
  - **[Headphones volume]**: Adjusts headphone volume.
  - **[Auto volume leveling]**: Automatically reduces sudden volume changes, for example, when switching channels.
  - **[Balance]**: Adjusts the balance of the left and right speakers to best suit your listening position.

### Reset to factory settings

Resetting your TV to factory settings restores default picture and sound settings. Channel installation settings remain the same.

1. While watching TV, press **⬆**.
2. Select **[Setup]** > **[Advanced TV settings]** > **[Factory settings]**, then press **OK**.  
TV settings are reset back to the factory default.

### Start a TV demo

Start a demo to find out more about your TV's features.

**Note:** Demos are not supported on MHEG channels.

1. While watching TV, press **⬆**.
2. Select **[Setup]** > **[Watch demos]**, then press **OK**.
3. Select a demo, then press **OK**.
4. Press **↶** to exit the demo.

---

## Change channel settings

### Reorder channels

After installation, you may want to reorder the channel list to suit your preference.

1. While watching TV, press **□**.
2. Select **[Channel list]**, then press **OK**.
3. In the channel list, press **□**.
4. Select **[Reorder]**, then press **OK**.
5. Select the channel to reorder, move it to the desired location, then press **OK**.
6. Select **[Insert]** to insert the channel into the desired location, **[Swap]** to swap location with another channel or **[Cancel]** to cancel the reorder.
7. Press **OK** to activate.

### Rename channels

After installation, you may want to rename channels to suit your preference.

1. While watching TV, press **□**.
2. Select **[Channel list]**, then press **OK**.
3. In the channel list, press **□**.
4. Select **[Rename]**, then press **OK**.
5. In the entry screen that appears, press the **Navigation buttons** or **Numeric buttons** to edit the name, then press **OK**.
6. Once complete, press the **Navigation buttons** to select **[Done]**.
  - To clear the entry, select **[Clear]**.
  - To cancel, select **[Cancel]**.

7. Press **OK** to confirm your choice.
8. Press **↶** to exit.

## Hide or unhide channels

### Hide channels

Hide channels from the channel list, to prevent unauthorised access.

1. While watching TV, press **□**.
2. Select **[Channel list]**, then press **OK**.
3. In the channel list, select the channel to hide, then press **□**.
4. Select **[Hide channel]**, then press **OK**.

The channel is hidden.

### Unhide channels

1. While watching TV, press **□**.
2. Select **[Channel list]**, then press **OK**.
3. In the channel list, press **□**.
4. Select **[Show hidden channels]**, then press **OK**. Hidden channels appear in the channel list, but without channel information displayed.
5. Select the channel to unhide, then press **□**.
6. Select **[Unhide channel]**, then press **OK**.

Repeat steps 5 and 6 to unhide other channels.

## Update channel list

When the TV was switched on for the first time, a full installation of channels was performed.

You can set the TV to add or remove digital channels automatically. You can also manually start the channel update.

### Automatic update

To set the TV to update digital TV channels automatically, leave the TV in standby mode. Once a day, the TV updates earlier found channels and stores new channels. Empty channels are removed from the channel list.

If a channel update is performed, a message appears at startup.

**If you do not want this message to appear**

1. Press **⬆**.
2. Select **[Setup] > [Advanced channel settings]** or **[Advanced satellite settings] > [Channel installation] > [Channel update message] > [Off]**, then press **OK**.

- **To disable automatic updates**  
In the **[Channel installation]** menu, select **[Automatic channel update] > [Off]**.

## Other options

### Select audio language

If the TV channel has multiple or dual sound broadcast, you can select the preferred audio language.

1. While watching TV, press **□**.
- **[Audio language]**: Select the audio language for digital channels.
- **[Dual I-II]**: Select the audio language for analogue channels.

### Select video stream (for DVB-S channel only)

If available, you can view different video stream of the channel. (depending on broadcast service provider)

1. While watching TV, press **□**.
2. Select **[Video selection]** to view the various selections.

---

## Install channels

### Automatic install

When the TV was switched on for the first time, a full installation of channels was performed. You can redo this full installation again to set your language, country and install all available TV channels.

**Note:** **[Search for satellite]** is only available if the TV supports DVB-S.

1. Press **⬆**.
2. Select **[Setup] > [Search for channels]** or **[Search for satellite]**, then press **OK**.
3. Follow the on-screen instructions to complete the channel installation.
4. Once complete, select **[Finish]**, then press **OK**.

**Tip:** Press **□** to see the channel list.

### Notes

- During installation, leave **[Settings]** unchanged unless your digital provider provides you with the specific values to enter.

- When digital TV channels are found, the list of installed channels may display empty channel numbers. You can rename, reorder or uninstall these channels.

### Access DVB-C or DVB-T channels

If you have installed both DVB-C and DVB-T channels, you have to switch to the respective network to watch channels on that network.

1. While watching TV, press **⬆️**.
2. Select **[Setup]** > **[Channel settings]**.
3. Select **[Channel installation]** > **[Antenna or Cable DVB]**.
4. Select one of the following settings:
  - **[Antenna (DVB-T)]**: Access free-to-air antenna or digital DVB-T channels
  - **[Cable]**: Access cable or digital DVB-C channels.
3. Press **OK** to confirm your choice.
4. Press **⏪** to exit.

The TV switches to the selected channel list.

### Access DVB-S channels (for certain models only)

If your satellite is connected to the SAT connector, you can receive satellite channels.

Press **⬆️** > **[Watch satellite]** to watch satellite channels.

### Install analogue channels

This section describes how to search and store analogue TV channels manually.

#### Step 1: Select your system

**Note:** Skip this step if your system settings are correct.

1. While watching TV, press **⬆️**.
2. Select **[Setup]** > **[Channel settings]** > **[Channel installation]** > **[Analogue: Manual installation]** > **[System]**, then press **OK**.
3. Select the system for your country or region, then press **OK**.

#### Step 2: Search and store new TV channels

1. In the **[Analogue: Manual installation]** menu, select **[Find channel]**, then press **OK**.
2. Press:
  - The **Navigation buttons** or **Numeric buttons** to manually enter the channel frequency.

- The **Navigation buttons** to select **[Search]**. Press **OK** to automatically search for the next channel.

3. When the correct channel frequency is entered, select **[Done]**, then press **OK**.

4. Select **[Store current channel]** to store the fine tuned channel as the current channel number, or select **[Store as new channel]** to store it as a new channel number.

### Install digital channels

You can reposition your antenna to improve the reception. You need to know the correct frequency to tune. For best results, contact the service provider or get a professional installer.

1. Press **⬆️**.
2. Select **[Setup]** > **[Channel settings]** > **[Channel installation]** > **[Digital: Reception test]** > **[Search]**, then press **OK**.
3. Press the **Numeric buttons** to enter the channel frequency.
4. Select **[Search]**, then press **OK**.
5. When the correct channel is located, select **[Store]**, then press **OK**.
6. Press **⏪** to exit.

### Notes

- If the reception is poor, reposition your antenna and repeat the procedure.
- If you receive the channel with DVB-C, the options **[Symbol rate mode]** and **[Symbol rate]** are available. In **[Symbol rate mode]**, select **[Automatic]** unless your cable provider supplies you with a specific symbol rate value.

### Install satellite channels

(For certain models only)

If your satellite is connected to the SAT connector, you can receive satellite channels.

1. While watching TV, press **⬆️**.
2. Select **[Setup]** > **[Search for satellite]** > **[Reinstall channels]**.
3. Follow the on-screen instructions to complete the installation of satellite channels.
4. Once complete, select **[Finish]**, and then press **OK**.



## Fine-tune analogue channels

If the reception of an analogue TV channel is poor, try fine tuning the TV channel.

1. Press **⬆️**.
2. Select **[Setup]** > **[Channel settings]** > **[Channel installation]** > **[Analogue: Manual installation]** > **[Fine tune]**, and then press **OK**.
3. Press **▲** or **▼** to fine tune the channel.
4. When the correct channel frequency is selected, select **[Done]**, and then press **OK**.
5. Select **[Store current channel]** to store the fine tuned channel under the current channel, or select **[Store as new channel]** to store under a new channel number.

---

## Change language settings

### Audio, subtitle, teletext languages

Digital TV channels may stream several audio, subtitle and teletext languages with a broadcast. Set preferred languages when multiple languages are available.

1. Press **⬆️**.
2. Select **[Setup]** > **[Advanced channel settings]** or **[Advanced satellite settings]** > **[Language]**.
3. Select one of the following settings, then press **OK**:
  - **[Primary audio]** / **[Secondary audio]**: Selects the available audio language for digital channels.
  - **[Primary subtitles]** / **[Secondary subtitles]**: Selects the available subtitle language for digital channels.
  - **[Primary Text]** / **[Secondary Text]**: Selects the available teletext for digital channels.
  - **[Hearing impaired]**: Enables or disables hearing impaired subtitles.
  - **[Visually impaired]** (UK only): Selects the device for audio output.
  - **[Volume - Visually impaired]** (UK only): Adjusts the volume of the visually impaired audio.

- **[Preferred audio format]**: Select **[Standard]** to receive standard audio format (MPEG). Select **[Advanced]** to receive advanced audio formats (AAC, EAC-3 or AC-3 if available).
  - **[Mono/Stereo]**: Select **[Mono]** or **[Stereo]** if stereo broadcasting is available.
4. Press **⬆️** to exit.

**Tip:** Set a secondary language in the same menu. You receive this language if the primary language is unavailable.

### Menu language

1. While watching TV, press **⬆️**.
2. Select **[Setup]** > **[Advanced TV settings]** > **[Preferences]** > **[Menu language]**.
3. Select a menu language from the list, then press **OK**.

---

## Change other settings

### Green eco settings

1. While watching TV, press the green button.
2. Select one of the following settings, then press **OK**:
  - **[Energy saving]**: Applies a combination of picture settings to reduce energy consumption.
  - **[Mute screen]**: Turns off the TV display. 'Muting' the screen saves energy if you just want to listen to audio from the TV.
  - **[Light sensor]**: To save energy, the built-in ambient light sensor lowers the brightness of the TV screen when the surrounding light darkens.

### Audio lip sync

Turn on digital audio lipsync to automatically sync the image on your TV to audio from a connected Home Theatre System.

1. While watching TV, press **⬆️**.
2. Select **[Setup]** > **[Advanced TV settings]** > **[Preferences]** > **[Audio Out delay]** > **[On]**, then press **OK**.

## TV clock

You can display a clock on the TV screen. The clock displays the current time using time data received from your TV service operator.

### Display the TV clock

1. When watching TV, press .
2. Select **[Status]**, then press **OK**.

The clock is displayed on the bottom right-hand corner of the TV screen.

### Change the clock mode

By default, the clock mode is set to **[Automatic]**, syncing the TV clock to Coordinated Universal Time (UTC). If your TV cannot receive UTC transmissions, set the clock mode to **[Manual]**. **[Country dependent]** applies UTC and gives you the option of setting **[Daylight saving]**.

1. While watching TV, press .
2. Select **[Setup]** > **[Advanced TV settings]** > **[Preferences]** > **[Clock]** > **[Auto clock mode]**.
3. Select **[Automatic]**, **[Manual]** or **[Country dependent]**, then press **OK**.

### Enable or disable daylight saving

If clock mode is set to **[Country dependent]**, enable or disable daylight saving if required for your time zone.

1. In the **[Clock]** menu, select **[Daylight saving]** > **[Daylight saving time]** or **[Standard time]**, then press **OK**. Daylight saving is enabled or disabled for your time zone.

### Set the clock manually

If clock mode is set to **[Manual]**, set the date and time manually.

1. In the **[Clock]** menu, select **[Date]** or **[Time]**, then press **OK**.
2. Use the **Navigation buttons** to make your selection, then select **[Done]**.

## TV location

A range of TV settings are applied to suit the location of the TV.

## Shop or home mode

The flexibility to change settings is limited if the TV location is set to **[Shop]** mode. Set the TV location to **[Home]** mode to access all TV settings.

1. While watching TV, press .
2. Select **[Setup]** > **[Advanced TV settings]** > **[Preferences]** > **[Location]** > **[Home]** or **[Shop]**, then press **OK**.
3. Restart the TV.

## Stand mount or wall mount

Specific TV settings are applied to suit the mounting location of the TV.

1. In the **[Preferences]** menu, select **[TV placement]** > **[On a TV stand]** or **[Wall mounted]**, then press **OK**.

---

## Update the TV software

### Check software version

1. Press .
2. Select **[Setup]** > **[Software settings]** > **[Current software info]**, then press **OK**. The version of the current software is displayed.

### Update with USB

Before performing this procedure be sure to:

- Set aside some time to complete the entire update.
- Have available a USB flash drive with at least 256 MB of storage space.
- Have access to a computer with a USB port and internet access.

1. Press .
2. Select **[Setup]** > **[Update software]**, then press **OK**. The update assistant starts. Follow the on-screen instructions to complete the update.

**Note:** If you already have the upgrade file downloaded onto a USB flash drive, connect it to the TV. Then, select **[Setup]** > **[Software settings]** > **[Local updates]**.

## Update with digital broadcast

If available, your TV can receive software updates via digital broadcasts.

If an update is available, a message appears prompting you to update the software. We strongly recommend that you update the software when prompted.

---

## Reinstall the TV

Reinstalling your TV resets all picture and sound settings, and reinstalls all TV channels.

1. Press **⬆**.
2. Select **[Setup]** > **[Advanced TV settings]** > **[Reinstall TV]**, then press **OK**.
3. Follow the on-screen instructions.

# 5 Connect the TV

## First connections

### Power

Be sure that the power plug in the wall socket is accessible at all times. When disconnecting the power cable, always pull the plug, never the cable. Although this TV has a very low standby power consumption, switch off the TV using the power switch on the bottom of the TV if you do not use the TV for a long time.

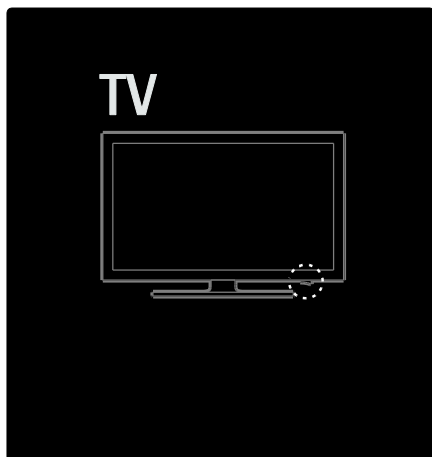

### Antenna

Locate the antenna connector at the back of the TV. Insert the antenna cable securely into the antenna connector.

**Note:** To receive DVB-S broadcasts, insert the antenna cable into the **SAT** (DVB-S) connector on the side of the TV. This is available on certain models only.

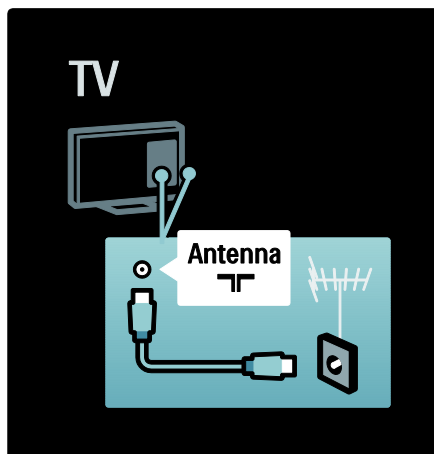

## About cables

### Overview

Before you connect devices to the TV, verify which connectors are available on the device. Connect the device to the TV with the highest quality connection available. Good quality cables ensure a good transfer of picture and sound.

The connections shown in this user manual are recommendations only. Other solutions are possible.

**Tip:** If your device only has composite/RCA connectors, use a SCART-cinch adapter to connect the device to a SCART connector on the TV.

### Add your devices

When you have connected a device to the TV, always add this device as an item in the home menu. With this item in the home menu, you can easily switch the TV to this device.

To add a new device, press **⬆**, then select **[Add your devices]**. Follow the on-screen instructions.

## HDMI

An HDMI connection has the best picture and sound quality.

- One HDMI cable combines video and audio signals. Use HDMI for High-Definition (HD) TV signals and to enable EasyLink.
- The **HDMI ARC** connector on the TV features HDMI ARC functionality. This allows output of TV audio to an HDMI ARC-compliant device.
- Do not use an HDMI cable longer than 5 metres/16.4 feet.

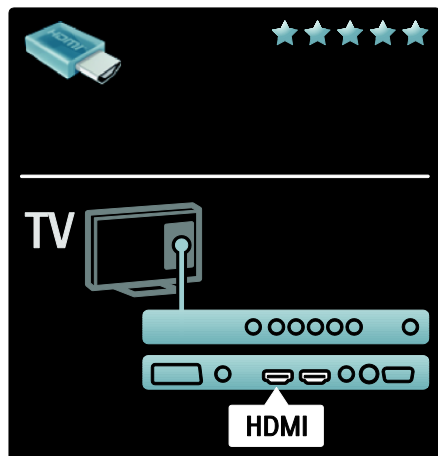

## Y Pb Pr

Use the Component Video YPbPr connection together with an Audio Left and Right connection for sound.

Match the YPbPr connector colours with the cable plugs when you connect. YPbPr can handle High Definition (HD) TV signals.

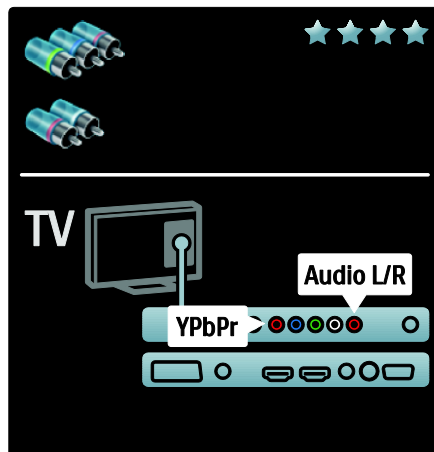

## SCART

A SCART cable combines video and audio signals. SCART connectors can handle RGB video signals but cannot handle High Definition (HD) TV signals.

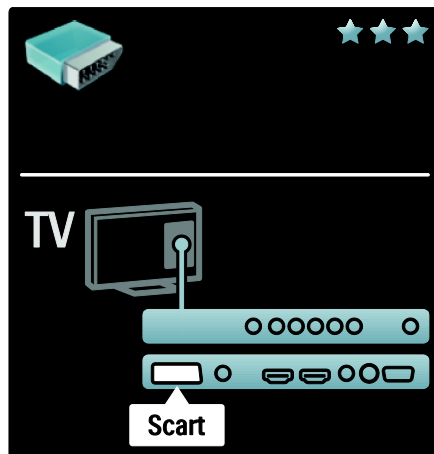

# TV connectors overview

## Rear

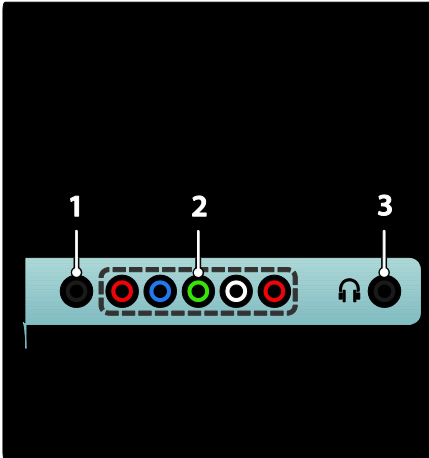

**1.SERV. U:** For use by service personnel only.

**2.EXT 2 / EXT 3Component (YPbPr):**

Analogue audio and video input from analogue or digital devices such as DVD players or game consoles.

**3. 🎧 :** Stereo audio output to headphones or earphones.

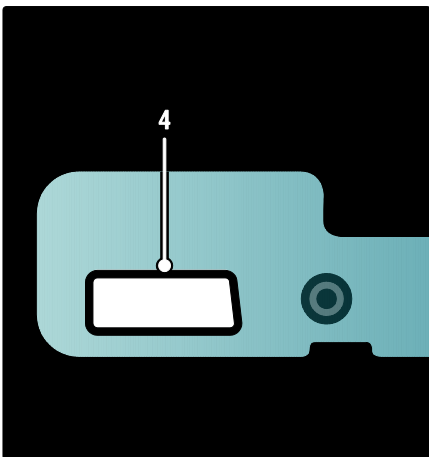

Available on certain models only:

**4. EXT 2 (SCART):** Analogue audio and video input from analogue or digital devices such as DVD players or game consoles.

## Bottom

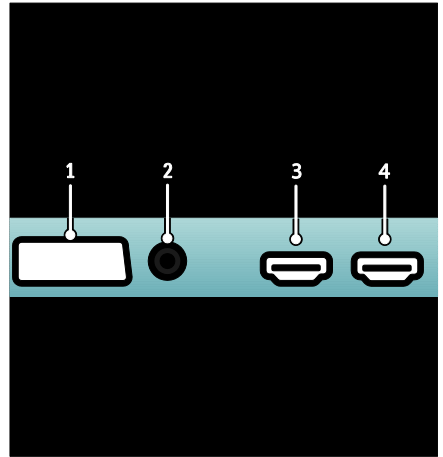

**1.EXT 1 (SCART):** Analogue audio and video input from analogue or digital devices such as DVD players or game consoles.

**2.DIGITAL AUDIO OUT:** Digital audio output to home theatres and other digital audio systems.

**3.HDMI:** Digital audio and video input from high-definition digital devices such as Blu-ray players. The second connector is available on certain models only.

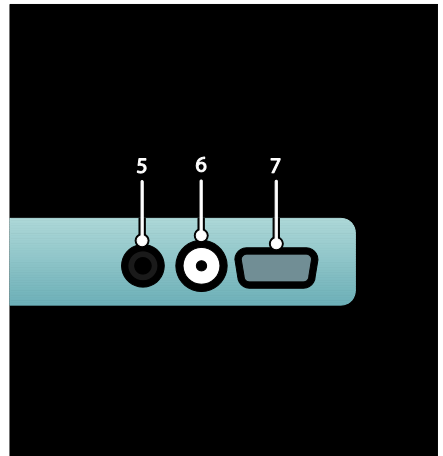

**4.HDMI ARC:** In addition to normal HDMI functionality, outputs TV audio to an HDMI ARC-compliant device, such as a home theatre system.

**5.AUDIO IN:** Audio input from a computer.

**6. ANTENNA:** Signal input from an antenna, cable or satellite.

**7. VGA:** Video input from a computer.

Side

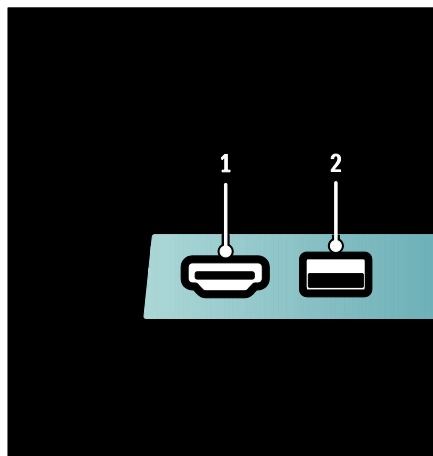

**1.HDMI:** Digital audio and video input from high-definition digital devices such as Blu-ray players.

**2. :** Data input from USB storage devices.**USB**

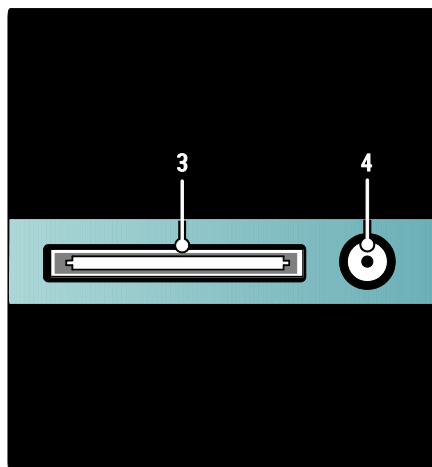

**3. CI (Common Interface +):** Slot for a Conditional Access Module (CAM).

**4. SAT (DVB-S):** Digital signal input from DVB-S broadcasts. Available on certain models only.

## Connect devices

### Blu-ray disc player

Use an HDMI cable to connect the Blu-ray disc player to an HDMI connector on the back of the TV.

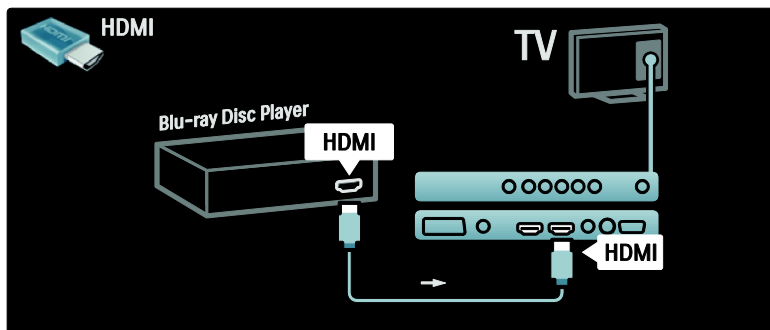

## DVD player

Use an HDMI cable to connect the DVD player to an HDMI connector on the back of the TV.

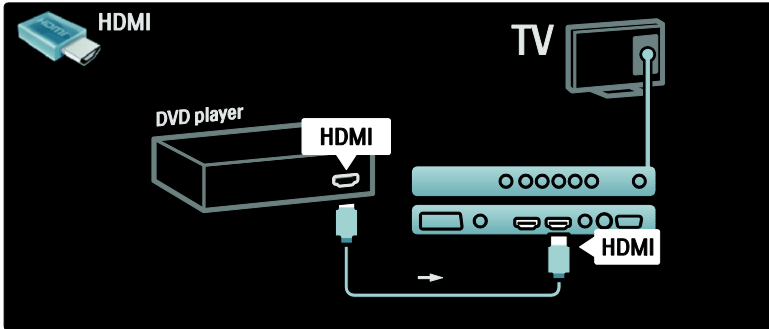

## DVD-Recorder

First, use two antenna cables to connect the antenna to the DVD Recorder and the TV. (SAT is available on certain models only)

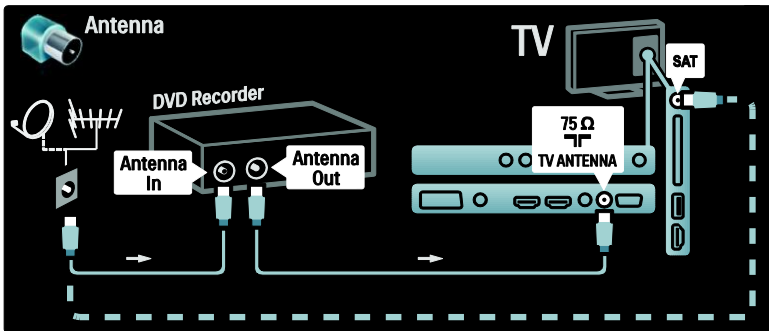

Finally, use a SCART cable to connect the DVD Recorder to a SCART connector on the back of the TV.

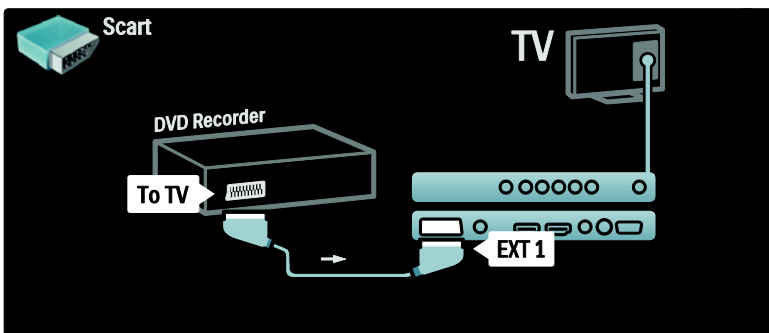



## Home Theatre System

First, use an HDMI cable to connect the device to the TV.

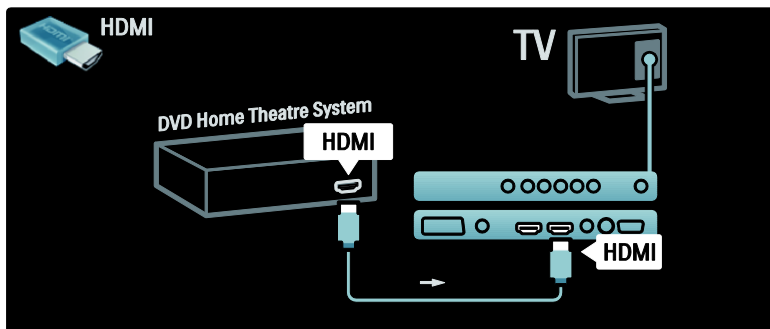

Finally, use a digital audio cinch cable to connect the device to the TV. (not required for HDMI ARC)

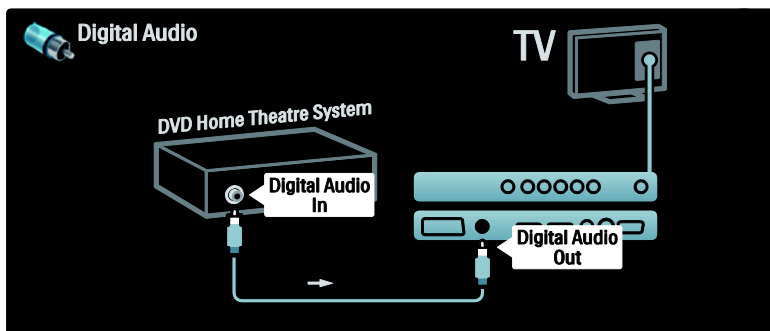

### Audio and video synchronisation (sync)

If the sound does not match with the video on screen, you can set a delay on most DVD Home Theatre Systems to match the sound and video.

### EasyLink

To automatically mute the TV speakers when content is played from your Home Theatre System, enable EasyLink. For more information, see **Connect the TV > Use Philips EasyLink > Configure TV speakers** (Page 42).

### Dig. receiver/satellite

First, use two antenna cables to connect the antenna to the receiver and the TV.

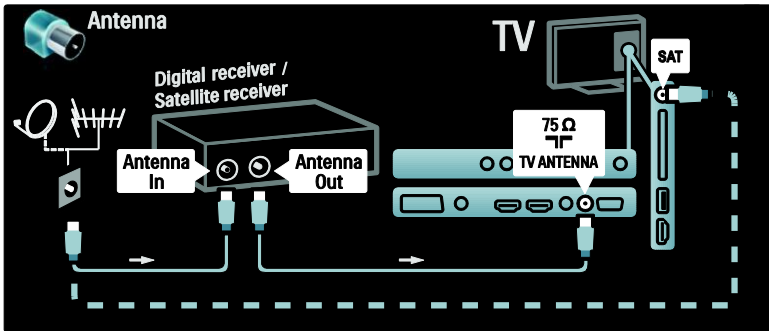

Finally, use a SCART cable to connect the receiver to the back of the TV.

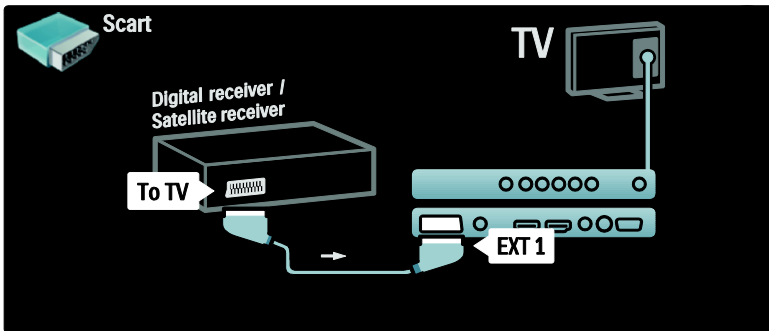

### Dig. receiver and DVD-R

First, use three antenna cables to connect the digital receiver and the DVD Recorder to the TV.

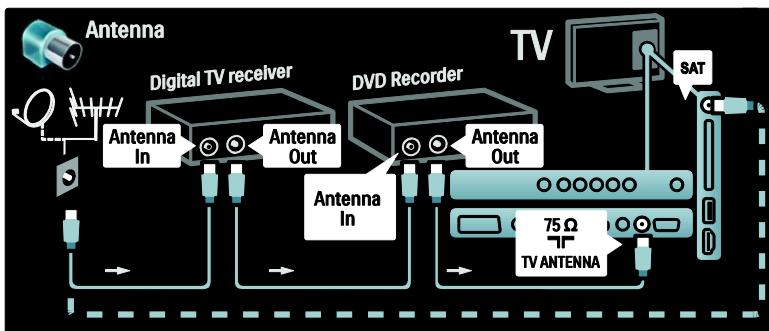

Then use a SCART cable to connect the digital receiver to the TV.

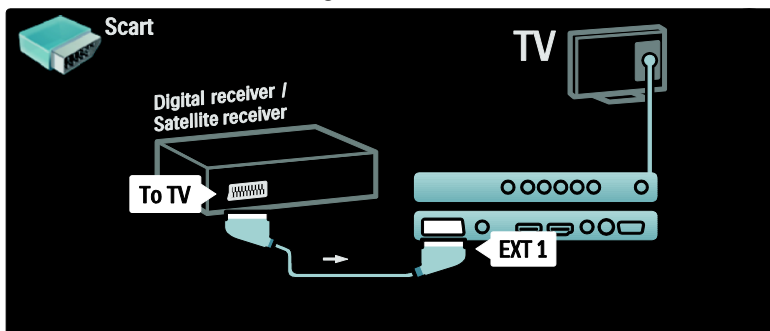

Finally, use two SCART cables to connect the two devices and the TV.

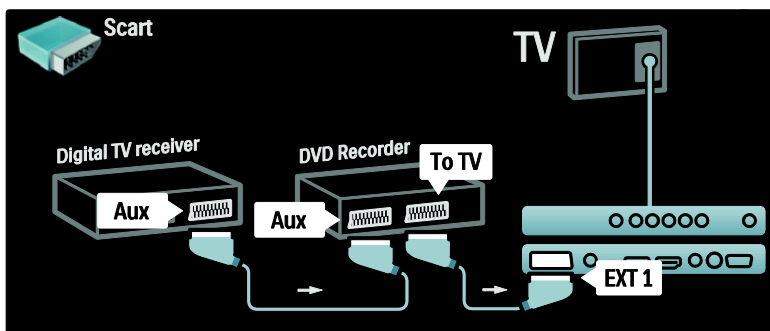

Dig. receiver, DVD-R and HTS

First, use three antenna cables to connect the two devices and the TV.

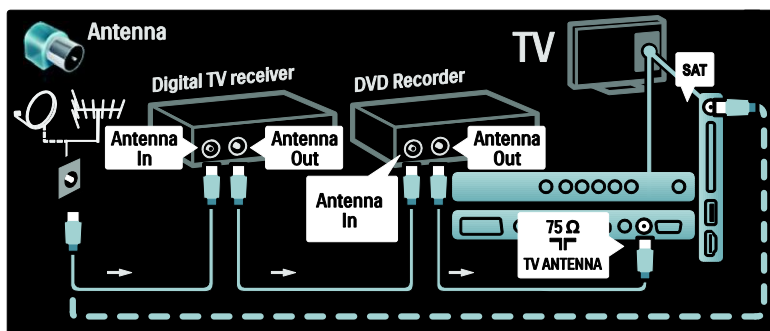

Then use two SCART cables to connect the digital receiver to the DVD Recorder and the DVD Recorder to the TV.

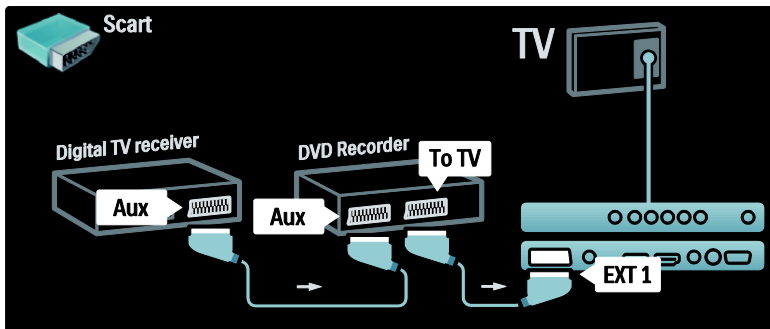

Then use an HDMI cable to connect the Home Theatre System to the TV.

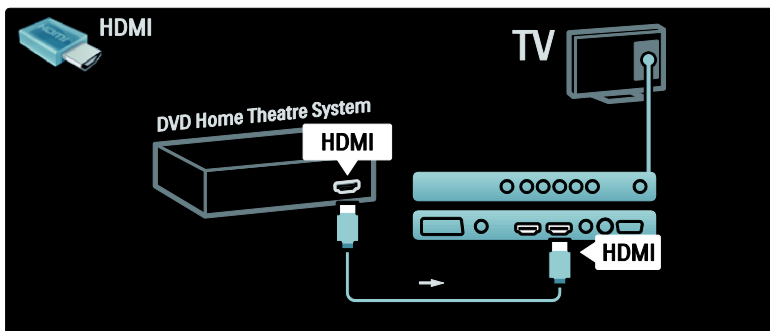

Finally, use a digital audio cinch cable to connect the Home Theatre System to the TV.

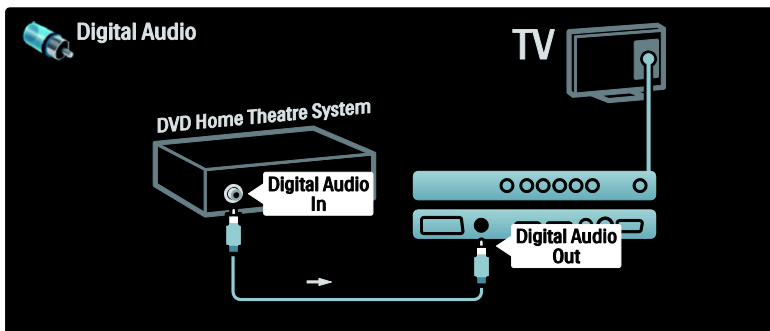

## Dig. HD receiver

First, use two antenna cables to connect the Digital HD receiver to the TV.

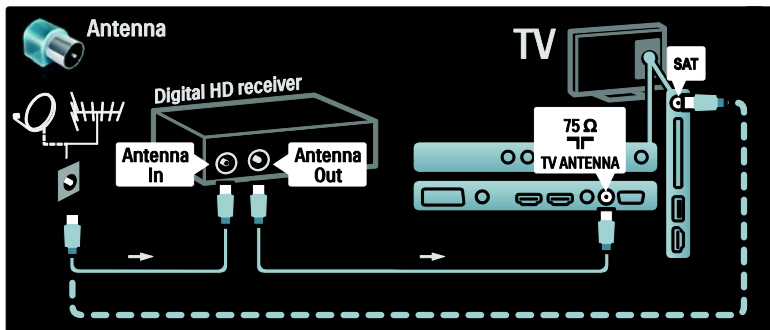

Use an HDMI cable to connect the Digital HD receiver to the TV.

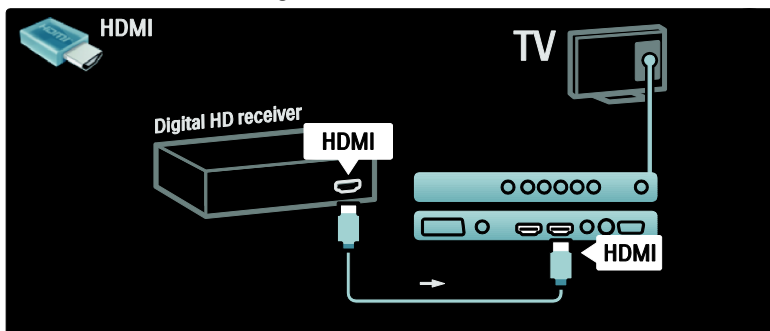

## Connect more devices

### Game console

The most practical connections for a game console are at the side of the TV. However, more connectors are available at the back of the TV if needed.

The most practical connections for a game console are at the side of the TV.

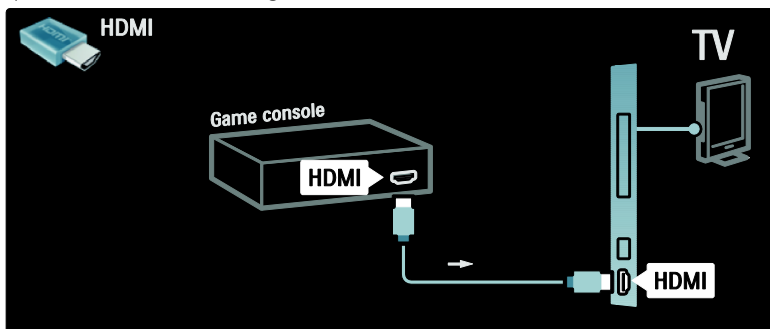

### Enable game mode

To prevent picture delay, set the TV to [Game] mode.

1. Press **OK**.
2. Select [Smart picture] > [Game], then press **OK**.
3. Press **↶** to exit.

If you cannot use the side connector, use an HDMI or the EXT2 (YPbPr and Audio L/R) cable to connect the game console to the back of the TV. (On certain models, EXT2 is labelled EXT3).

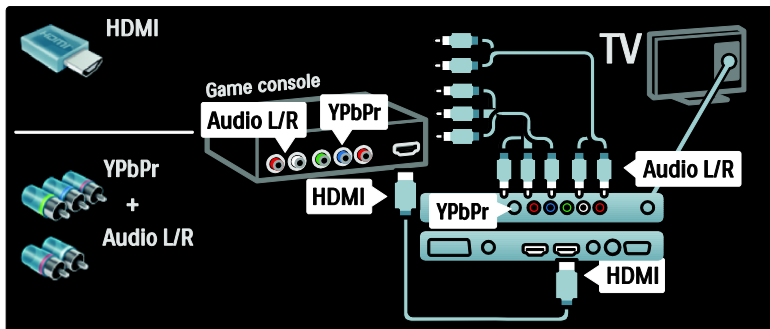

### Dig. camera

To view pictures on your digital camera, connect it to the USB connection at the side of the TV and switch it on. If the content of your camera does not appear automatically, you may need to enable Picture Transfer Protocol (PTP) on the camera. Refer to the camera's user manual for instructions.

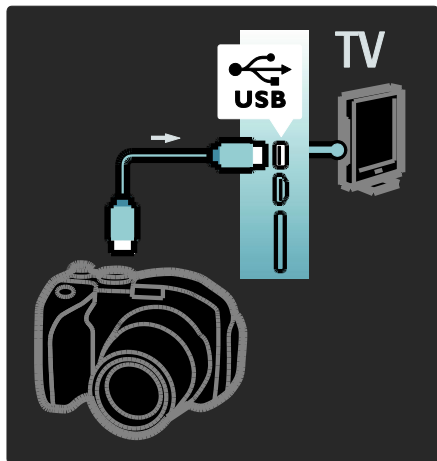

## Dig. camcorder

The most practical connection for a camcorder is at the side of the TV.

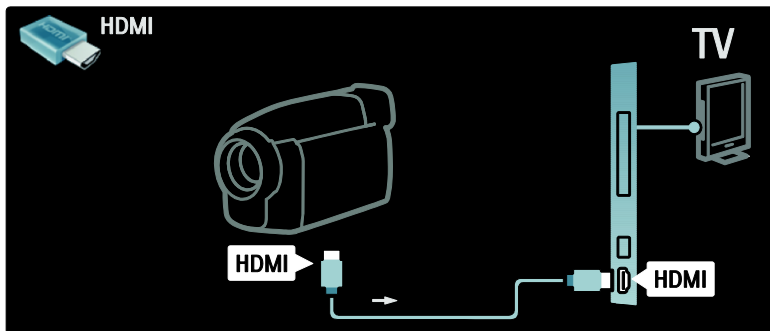

If you cannot use the side connector, use an HDMI or the EXT2 (YPbPr and Audio L/R) cable to connect the camcorder to the back of the TV. (On certain models, EXT2 is labelled EXT3).

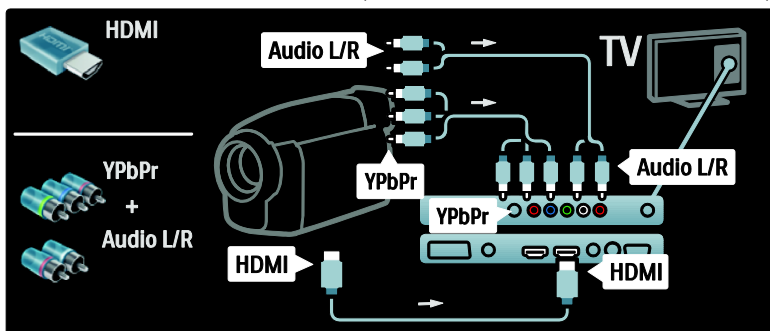

## Channel decoder

Before using a SCART digital channel decoder, select the channel to decode and assign the decoder to the SCART connector.

1. Press **↑**.
2. Select **[Setup] > [Channel settings] > [Decoder] > [Channel]**.

3. Set the channel you want to decode.
4. Select **[Status]**, then the location of the decoder.
5. Press **OK**.

## PC

Connect a computer using one of the following cables:

HDMI cable

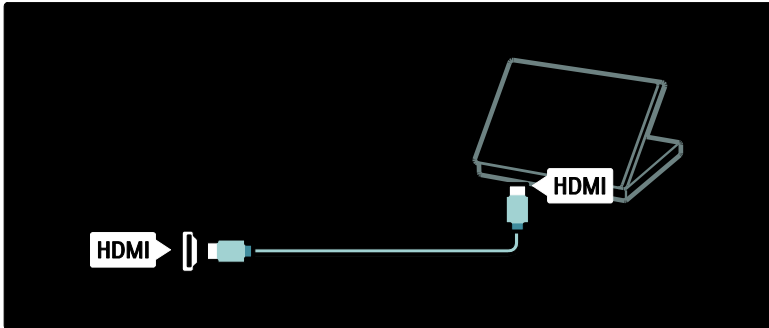

DVI-HDMI cable

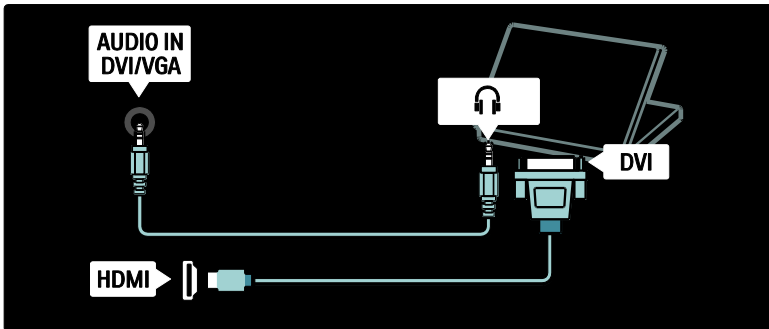

HDMI cable and HDMI-DVI adaptor

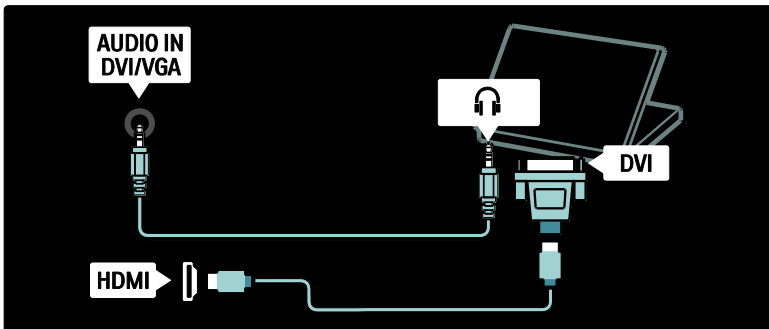



## VGA cable

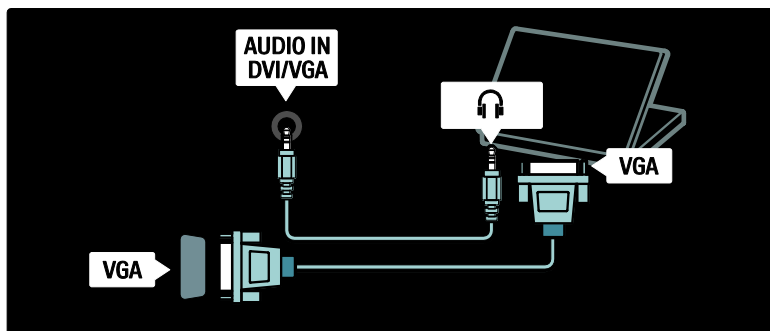

## Use Philips EasyLink

### Enable or disable EasyLink

Philips EasyLink provides several features that enable you to control devices that are connected via HDMI. Connected devices must support the HDMI-CEC standard, and must be properly configured for EasyLink to work.

**Note:** HDMI-CEC functionality is known by other names on other brands. Some examples are Anynet (Samsung), Aquos Link (Sharp) or BRAVIA Sync (Sony). Not all brands are fully compatible with Philips EasyLink.

### To enable or disable EasyLink

**Note:** Do not enable Philips EasyLink if you do not intend to use it.

1. Press .
2. Select **[Setup]** > **[Advanced TV settings]** > **[EasyLink]** > **[On]** or **[Off]**, then press **OK**.

### EasyLink features

With Philips EasyLink enabled, the following features are available:

#### One-touch play

When you play content from an HDMI-CEC compliant device, the TV switches on from standby, and switches to the correct source.

#### One-touch standby

When you connect your TV to an HDMI-CEC compliant device, pressing  on the TV remote control switches the TV and all connected HDMI devices to standby mode.

#### System audio control

When you connect your TV to, for example, an HDMI-CEC compliant Home Theatre System (HTS), your TV speakers automatically mute and audio from the TV plays through the HTS.

For more information about system audio control and other types of TV speaker configurations, see **Connect the TV > Use Philips EasyLink > TV speakers** (Page 42).

#### EasyLink Remote Control

EasyLink Remote Control allows you to control HDMI-CEC compliant devices using your TV remote control.

To enable EasyLink Remote Control, see **Connect the TV > Use Philips EasyLink > Enable or disable EasyLink Remote Control** (Page 42).

#### Pixel Plus Link

Connected Philips EasyLink devices may apply their own picture quality processing to a video, before streaming it to the TV. This may interfere with the image processing of the TV. Enable Pixel Plus Link to discard picture quality processing from connected Philips EasyLink devices.

### To enable Pixel Plus Link

1. Press **⬆️**.
2. Select **[Setup]** > **[Advanced TV settings]** > **[EasyLink]** > **[Pixel Plus link]** > **[On]**.
3. Press **OK** to activate.

### Auto subtitle shift

Auto subtitle shift displays subtitles from Philips EasyLink compliant Home Theatre Systems over the video image on your TV. The video image is thus stretched across the whole of your TV display, without the need to create a separate subtitle bar at the bottom of the screen.

### To enable auto subtitle shift

1. Press **⬆️**.
2. Select **[Setup]** > **[Advanced TV settings]** > **[EasyLink]** > **[Auto subtitle shift]**.
3. Select **[On]**, then press **OK** to activate.

### Audio only mode

Audio only mode enables you to play audio from a connected Philips EasyLink device through the TV speakers while the TV is in standby.

Press **🔊** to receive audio from the connected Philips EasyLink device. If available, audio only mode is enabled. Accept the prompt on the TV to enable audio only mode.

- Control the audio playback with the TV remote control.

### Enable or disable EasyLink Remote Control

**Caution:** This is an advanced setting. Verify that all connected HDMI-CEC compliant devices support this setting. Devices that do not support this setting will not respond to commands from the TV remote control.

1. Press **⬆️**.
2. Select **[Setup]** > **[Advanced TV settings]** > **[EasyLink]** > **[EasyLink Remote Control]** > **[On]** or **[Off]**.
3. Press **OK** to activate.

### Notes:

- If you cannot exit from the connected device's menu, press **↶**.
- To switch back to TV control, press **⬆️** and select **[Watch TV]**.

- To control another device, press **⬆️** and select the device from the home menu.
- A summary of EasyLink buttons you can use with the TV remote control is available at **Connect the TV > Use Philips EasyLink > EasyLink buttons** (Page 42).

### EasyLink buttons

Control HDMI-CEC compliant devices with the following buttons on the TV remote control.

- **OK:** Starts, pauses or resumes playback on the connected device. Also activates a selection or accesses the menu of the device.
- **⏮ (Previous) / ⏭ (Next):** Searches backwards and forwards on the connected device.
- **Numeric buttons:** When EasyLink is enabled, selects a title, chapter or track.
- **☰ (Options):** Displays the menu of the connected device. When **⬆️** is pressed, the TV menu is displayed.
- **⏻ (Standby):** Press to enable one-touch standby. This switches the TV and the connected device to standby.

Other EasyLink buttons are available via On-Screen Remote Control (OSRC).

### To access the OSRC

1. While watching a connected device, press **☰**.
2. Select **[Show remote control]**, then press **OK**.
3. Use the **Navigation buttons** and **OK** to select and use an on-screen button.
4. Press **↶** to exit.

### Configure TV speakers

You usually connect the TV to an HDMI-CEC compliant device such as a HTS using both an HDMI cable for video and a digital audio cable for audio. You can output TV audio through the HDMI cable solely, provided both the TV and device are HDMI ARC compliant (see **Connect the TV > Use Philips EasyLink > Use HDMI ARC** (Page 43)).

## Configure TV speakers

1. Press **⬆**.
2. Select **[Setup]** > **[Advanced TV settings]** > **[EasyLink]** > **[TV speakers]**.
3. Select one of the following options, then press **OK**:
  - **[Off]**: Turn off TV speakers.
  - **[On]**: Turn on TV speakers.
  - **[EasyLink]**: TV audio continues to be streamed through the TV speakers. Switch the TV audio to the connected HDMI-CEC audio device through the experience menu.
  - **[EasyLink autostart]**: Turn off TV speakers automatically and streams TV audio to the connected HDMI-CEC audio device.

## Switch TV audio in experience menu

If **[EasyLink]** or **[EasyLink autostart]** are selected, access the experience menu to switch the TV audio.

1. While watching TV, press **⏸**.
2. Select **[Speakers]**, then press **OK**.
3. Select one of the following, then press **OK**:
  - **[TV]**: On by default. Streams TV audio through TV speakers until the connected HDMI-CEC audio device switches to system audio control. Thereafter, TV audio is streamed through the connected device.
  - **[Amplifier]**: Streams audio through the connected HDMI-CEC device. If system audio mode is not enabled on the device, audio will continue to stream from TV speakers if **[EasyLink]** was selected. If **[EasyLink autostart]** was enabled, the TV prompts the connected device to switch to system audio mode.

## Use HDMI ARC

The HDMI 1 connector is HDMI 1.4-Audio Return Channel (ARC) compliant. Use it to output audio to an HDMI ARC compliant audio device, such as a Home Theatre System.

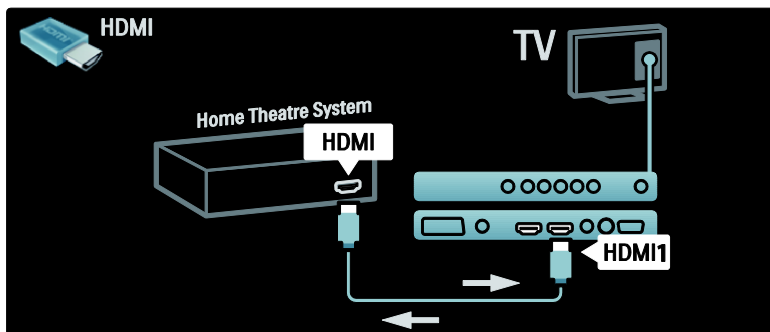



HDMI ARC allows you to use Philips EasyLink to output TV audio directly to a connected audio device, without the need for an additional digital audio cable. Be sure that the device is HDMI-CEC and ARC compliant, and that the TV is connected to the device using an HDMI cable attached to HDMI ARC connectors.

### Enable or disable HDMI ARC

**Note:** Enabling HDMI ARC automatically adds the device to the home menu.

1. Press **⬆**.
2. Select **[Setup]** > **[Advanced TV settings]** > **[EasyLink]** > **[HDMI 1 - ARC]** > **[On]** or **[Off]**.
3. Press **OK** to activate.

## Use a CAM

### Insert and activate a CAM

**Caution:** Be sure to follow the instructions described below. Incorrect insertion of a Conditional Access Module (CAM) may damage both the CAM and your TV.

#### Notes:

- This TV supports CI as well as CI+. CI+ allows service providers to offer premium HD digital programmes with a high level of copy protection.
- Refer to the documentation from your service operator on how to insert a smart card into the Conditional Access Module.

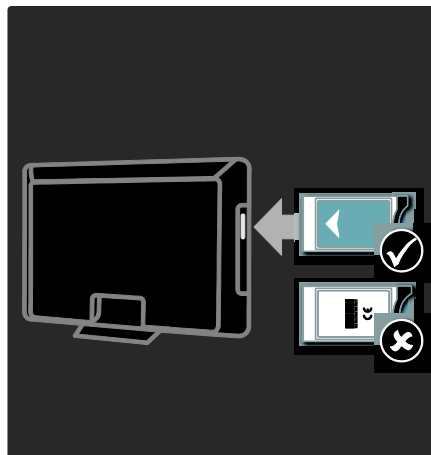

1. Switch off the TV.
2. Follow the directions printed on the CAM and insert the CAM into the Common Interface at the side of the TV.
3. Push the CAM in as far as it will go and wait for the CAM to be activated. This may take several minutes. Do not remove the CAM from the slot when in use as digital services will be deactivated.

### Access CAM services

1. After inserting and activating the CAM, press **⬆**.
2. Select **[Common interface]**, then press **OK**.
3. Select the CAM provider and press **OK**.

### Watching a CAM service

If a CAM is inserted and subscription fees are paid, the TV shows the programme from the digital TV service provider. The applications, functions, content and on-screen messages vary by CAM service.

# 6 Troubleshooting

---

## Contact us

If you cannot resolve your problem, refer to the FAQs for this TV at

(<http://www.philips.com/support>).

If the problem remains unresolved, contact Philips Consumer Care in your country as listed in the leaflet accompanying your product.

Make a note of your TV model and serial number before you contact Philips. These numbers are printed on the back of the TV and on the packaging.

**Warning: Do not attempt to repair the TV yourself. This may cause severe injury, irreparable damage to your TV or void your warranty.**

---

## General TV issues

### The TV does not switch on:

- Disconnect the power cable from the power socket. Wait for one minute then reconnect it.
- Check that the power cable is securely connected.
- Check that the **power switch** on the bottom/back of the TV is switched on.

### The TV does not respond to remote control or side controls when switched on

The TV requires some time to start up. During this time, the TV will not respond to the remote control or side controls. This is normal behaviour.

### The standby light on the TV blinks red:

Disconnect the power cable from the power outlet. Wait until the TV cools down before reconnecting the power cable. If the blinking reoccurs, contact Philips Consumer Care.

You forgot the code to unlock the child lock feature:

Enter '8888'.

### The TV menu is in the wrong language:

Change the TV menu to your preferred language.

For more information, see **Set up the TV > Change language settings > Menu language** (see "Menu language" on page 25).

### When turning the TV on/off/to standby, you hear a creaking sound from the TV chassis:

No action is required. The creaking sound is normal expansion and contraction of the TV as it cools down and warms up. This does not impact performance.

### When the TV is in standby mode, a startup splash screen is displayed, then returns to standby mode:

This is normal behavior. The startup screen is displayed when the TV is disconnected from the mains and reconnected.

To switch on the TV from standby, press  on the remote control or press any key on the side of the TV.

---

## TV channel issues

### Previously installed channels do not appear in the channel list:

Check that the correct channel list is selected.

### No digital channels were found during the installation:

Check that the TV supports DVB-T, DVB-C or DVB-S in your country. See the listed countries on the back of the TV.

---

## Picture issues

### The TV is on, but there is no picture:

- Check that the antenna is properly connected to the TV.
- Check that the correct device is selected as the TV source.

### There is sound but no picture:

Check that the picture settings are correctly set.

### There is poor TV reception from an antenna connection:

- Check that the antenna is properly connected to the TV.
- Loudspeakers, unearthed audio devices, neon lights, high buildings and other large objects can influence reception quality. If possible, try to improve the reception quality by changing the antenna direction or moving devices away from the TV.
- If reception on only one channel is poor, fine tune this channel.

### There is poor picture quality from connected devices:

- Check that the devices are connected properly.
- Check that the picture settings are correctly set.

### The TV did not save your picture settings:

Check that the TV location is set to the home setting. This mode offers you the flexibility to change and save settings.

### The picture does not fit the screen; it is too big or too small:

Try using a different picture format.

### The picture position is incorrect:

Picture signals from some devices may not fit the screen correctly. Check the signal output of the device.

### The picture from broadcasts is scrambled:

You may need to use a Conditional Access Module to access content. Check with your operator.

### An "e-sticker" banner displaying information appears on the TV display:

The TV is in **[Shop]** mode. Remove the e-sticker by setting the TV to **[Home]** mode then restarting the TV. See **Setup the TV > Change other settings > TV location** (Page 26) for more information.

---

## Sound issues

### There is a picture but sound quality is poor:

If no audio signal is detected, the TV automatically switches the audio output off — this does not indicate malfunction.

- Check that all cables are properly connected.
- Check that the volume is not set to 0.
- Check that the sound is not muted.
- Check that the TV speakers setting is on in the sound menu.
- Check that the TV audio output is connected to the audio input on the HDMI CEC enabled/EasyLink-compliant HTS device. Sound should be heard from the HTS speakers.

### There is a picture but the sound quality is poor:

Check that the sound settings are correctly set.

### There is a picture but sound comes from one speaker only:

Verify that sound balance is set to the centre.

---

## HDMI connection issues

### There are problems with HDMI devices:

- Note that HDCP (High-bandwidth Digital Content Protection) support can delay the time taken for a TV to display content from a HDMI device.
- If the TV does not recognise the HDMI device and no picture is displayed, try switching the source from one device to another and back again.
- If there are intermittent sound disruptions, check that output settings from the HDMI device are correct.
- If you use an HDMI-to-DVI adapter or HDMI to DVI cable, check that an additional audio cable is connected to AUDIO L/R or AUDIO IN (mini-jack only).

### **You cannot use EasyLink features:**

Check that your HDMI devices are HDMI-CEC compatible. EasyLink features only work with devices that are HDMI-CEC compatible.

**If an HDMI-CEC compliant audio device is connected to the TV and the TV does not display any mute or volume icon when the volume is muted, increased or decreased.**

This behaviour is normal when an HDMI-CEC audio device is connected.

---

## **USB connection issues**

### **USB device content is not displayed:**

- Check that the USB storage device is set to 'Mass Storage Class' compliant, as described in the storage device's documentation.
- Check that the USB storage device is compatible with the TV.
- Check that the audio and picture file formats are supported by the TV.

### **Audio and picture files do not play or display smoothly:**

The transfer performance of the USB storage device may limit the data transfer rate to the TV, causing poor playback.

---

## **PC connection issues**

### **The computer display on the TV is not stable:**

- Check that your PC uses the supported resolution and refresh rate.
- Set the TV picture format to unscaled.



# 7 Technical data

## Overview

Product information is subject to change without notice. For detailed product information, go to (<http://www.philips.com/support>).

## Power and reception

### Power

- Mains power: AC220-240 V; 50-60 Hz
- Ambient temperature: 5°C to 35°C
- For power and standby power consumption, see the product specifications at (<http://www.philips.com/support>).

### Reception

- Antenna input: 75ohm coaxial (IEC75)
- TV system: DVB COFDM 2K/8K
- Video playback: NTSC, PAL, SECAM
- Digital TV: MPEG-4, DVB-T (Terrestrial), DVB-C (Cable), DVB-S (Satellite - on certain models only), MHP (Multimedia Home Platform - only available in Italy).
- Tuner bands: VHF, UHF, S-Channel, Hyperband

## Display and sound

### Picture/Display

- Display type: LCD Full HD W-UXGA
- Diagonal size:
  - 81 cm/32 inch
  - 94 cm/37 inch
  - 102 cm/40 inch
  - 107 cm/42 inch
  - 117 cm/46 inch
  - 132 cm/52 inch
- Aspect ratio: Widescreen 16:9
- Panel resolution: 1920 x 1080p, 100 Hz
- Pixel Plus HD picture enhancement
- 1080p 24/25/30/50/60 Hz processing

- 100 Hz LCD

### Sound

- Output power (RMS): 20 W
- Incredible Surround
- Clear Sound
- Virtual 2.1  
(not available on all models)
- Mono/Stereo/NICAM  
(analogue NICAM on certain models)

## Display resolutions

### Computer formats - HDMI (resolution - refresh rate)

640 x 480 - 60 Hz  
 800 x 600 - 60 Hz  
 1024 x 768 - 60 Hz  
 1360 x 768 - 60 Hz  
 1280 x 1024 - 60 Hz  
 1600 x 1200 - 60 Hz  
 1920 x 1080 - 60 Hz

### Computer formats - VGA (resolution - refresh rate)

640 x 480 - 60 Hz  
 800 x 600 - 60 Hz  
 1024 x 768 - 60 Hz  
 1360 x 768 - 60 Hz  
 1280 x 1024 - 60 Hz  
 1600 x 1200 - 60 Hz  
 1920 x 1080 - 60 Hz

### Video formats (resolution - refresh rate)

480i - 60 Hz  
 480p - 60 Hz  
 576i - 50 Hz  
 576p - 50 Hz  
 720p - 50 Hz, 60 Hz  
 1080i - 50 Hz, 60 Hz  
 1080p - 24 Hz, 25 Hz, 30 Hz, 50 Hz, 60 Hz

## Multimedia

### Supported storage device

USB (FAT or DOS-formatted; Mass Storage Class-compliant only)

### Supported image files

JPEG (\*.jpg, \*.jpeg): EXIF, JFIF, SPIFF

## Supported video and audio files

- AVI video (\*.avi): MPEG-4 SP, MPEG-4 ASP, MPEG-4 Part 2
- AVI audio (\*.avi): AC3, MPEG-1 L3, MPEG L2, AAC\_ADTS, AAC\_ISO
- MPEG video (\*.mpg, \*.mpeg, \*.vob, \*.ts): MPEG-1, MPEG-2
- MPEG audio (\*.mp2, \*.mp3, \*.mpg, \*.mpeg, \*.vob): MPEG-1 Layer 2, MPEG-2 Layer 2, AC3
- MPEG-4 video (\*.mp4): MPEG-4 AVC (H.264, L2-CIF), MPEG-4 AVC (H.264, L4-HD), MPEG-4 Part 2
- MPEG-4 audio (\*.mp4): AAC-LC, AAC-HE, AC3, AAC\_ADTS, AAC\_ISO, HE-AAC (v1, v2)
- MKV video (\*.mkv): HD H264
- MKV audio (\*.mkv): HE AAC, AC3

## Supported audio files (without video)

- MPEG audio (\*.mp3): MPEG-1 Layer 3
- WMA audio (\*.wma, \*.asf): WMA (v2 to v9.2)
- LPCM audio (\*.lpcm, \*.pcm, \*.wav, \*.aif, \*.aiff): \*lpcm and \*pcm not supported on all sets.
- MPEG-4 audio (\*.aac, \*.mp4, \*.m4a): AAC-LC, HE-AAC (v1, v2)
- Playlists (\*.pls, \*.m3u)

**Note: Multimedia file names must not exceed 128 characters.**

---

## Connectivity

### Rear

- **EXT 2:** Component (Y Pb Pr), Audio L/R
- (For 40PFL6605) **EXT 2:** SCART (RGB/CVBS)
- (For 40PFL6605) **EXT 3:** Component (Y Pb Pr), Audio L/R. Available on certain models only.
- **Headphones:** Stereo 3.5 mm mini-jack
- **SERV. U:** Service port

### Bottom

- **EXT 1:** SCART (RGB/CVBS)

- **HDMI ARC (1):** HDMI 1.4, Audio Return Channel (ARC)-compliant
- **HDMI (2):** HDMI 1.3a
- (For 40PFL6605) **HDMI (3):** HDMI 1.3a
- **DIGITAL AUDIO OUT:** Coaxial
- **AUDIO IN:** DVI/VGA stereo 3.5 mm mini-jack
- **ANTENNA:** 75 ohm coaxial
- **VGA:** PC input

### Side

- **HDMI:** HDMI 1.3c
- **USB**
- **CI** (Common Interface +)

---

## Dimensions

**Note:** Dimensions and weights are approximate values only. Design and specifications are subject to change without notice.

### 32PFL6605H

... without stand  
472 mm (height) × 777 mm (width) × 42 mm (depth); 9.5 kg (estimate)

... with stand  
540 mm (height) × 777 mm (width) × 221 mm (depth); 11.6 kg (estimate)

### 40PFL6605H

...without stand  
593 mm (height) × 966 mm (width) × 41.5 mm (depth); 13 kg (estimate)

... with TV stand  
641 mm (height) × 966 mm (width) × 242 mm (depth); 16 kg (estimate)

### 32PFL5405H

... without stand  
513 mm (height) × 796 mm (width) × 90 mm (depth); 8.35 kg (estimate)

... with stand  
559 mm (height) × 796 mm (width) × 221 mm (depth); 9.67 kg (estimate)

### 32PFL5605H/32PFL5625H

... without stand  
501 mm (height) × 790 mm (width) × 92 mm (depth); 10 kg (estimate)

... with stand  
542 mm (height) × 790 mm (width) ×  
221 mm (depth); 11.5 kg (estimate)

### **37PFL5405H**

... without stand  
582 mm (height) × 912.5 mm (width) ×  
84 mm (depth); 9.55 kg (estimate)

... with stand  
626 mm (height) × 912.5 mm (width) ×  
236 mm (depth); 11.55 kg (estimate)

### **40PFL5605H/40PFL5625H/40PFL5605K/40 PFL5705H**

... without stand  
605 mm (height) × 977 mm (width) ×  
86 mm (depth); 13.7 kg (estimate)

... with stand  
649 mm (height) × 977 mm (width) ×  
236 mm (depth); 16.1 kg (estimate)

### **42PFL5405H**

... without stand  
640 mm (height) × 1019 mm (width) ×  
83 mm (depth); 11.38 kg (estimate)

... with stand  
683 mm (height) × 1019 mm (width) ×  
236 mm (depth); 13.38 kg (estimate)

### **46PFL5605H**

... without stand  
685 mm (height) × 1122 mm (width) ×  
87 mm (depth); 17.9 kg (estimate)

... with stand  
731 mm (height) × 1122 mm (width) ×  
268 mm (depth); 21.3 kg (estimate)

### **52PFL5605H**

... without stand  
764 mm (height) × 1255 mm (width) ×  
87 mm (depth); 20 kg (estimate)

... with stand  
813 mm (height) × 1255 mm (width) ×  
297 mm (depth); 24 kg (estimate)

**UMv 3139 137 03583 - 16/04/2010**

# 8 Index

---

## A

- age rating - 17
  - audio language - 24
  - audio lip sync - 25
- 

## B

- bottom connectors - 29
- 

## C

- CAM, enable - 40
- CAM, insert - 40
- care - 5
- channel list - 12
- channels, favourites - 17
- channels, fine tune (analogue) - 24
- channels, fine tune (digital) - 23
- channels, hide or unhide - 22
- channels, install (automatic) - 23
- channels, install (manual) - 23
- channels, rename - 22
- channels, reorder - 22
- channels, switch - 13
- channels, update - 22
- child lock, age rating - 17
- child lock, overview - 17
- child lock, set code - 17
- clock - 25
- common interface - 40
- connect device - 27
- connect, antenna - 27
- connect, channel decoder - 37
- connect, PC - 37
- connect, power - 27
- connect, USB - 18
- connectors, bottom - 29

- connectors, rear - 29
  - controls, side - 9
- 

## D

- decoder - 37
  - default settings - 22
  - demo - 22
  - devices, add - 15
  - devices, watch - 15
  - digital channels, fine tune - 23
  - digital channels, overview - 8
  - digital channels, subtitles - 18
  - digital radio - 19
  - digital TV - 8
  - dimensions - 44
  - display resolution - 43
- 

## E

- EasyLink, buttons - 39
  - EasyLink, enable - 38
  - EasyLink, features - 38
  - EasyLink, RC key forward - 39
  - EasyLink, TV speakers - 39
  - end of use - 5
  - environment, green eco - 5
  - EPG, enable - 17
  - EPG, menu - 17
  - EPG, overview - 17
- 

## F

- factory settings - 22
  - favourites list, add - 17
  - favourites list, select - 17
- 

## G

- green eco, overview - 5
- green eco, settings - 24

---

## H

HDMI - 27  
HDMI ARC - 40  
hearing impaired - 19  
High-Definition (HD), content - 6  
home menu - 11  
home mode - 25

---

## I

information, on Internet - 8  
information, on-screen - 8  
install channels (automatic) - 23  
install channels (manual) - 23

---

## K

kensington lock - 6

---

## L

language, menu - 24  
language, others - 24  
location, home or shop - 25  
location, stand or wall mount - 25

---

## M

menu, add device - 12  
menu, browse - 11  
menu, channel list - 12  
menu, home - 11  
menu, language - 24  
menu, options - 12  
menu, setup - 12  
multimedia, overview - 8  
multimedia, play files - 18  
mute TV speakers - 14

---

## O

options menu - 12

---

---

## P

PC, connect - 37  
pc, display resolutions - 43  
picture format - 14  
picture settings - 21  
position TV - 6  
power - 43

---

## R

rear connectors - 29  
recycle - 5  
register product - 4  
remote control, batteries - 10  
remote control, on-screen - 11  
remote control, overview - 9  
remote control, usage - 11  
rename channels - 22  
reorder channels - 22

---

## S

safety - 4  
Scenea, enable - 19  
Scenea, upload picture - 19  
screen care - 5  
settings, assistant - 21  
settings, picture - 21  
settings, sound - 21  
shop mode - 25  
sleeptimer - 17  
smart card - 40  
smart picture - 14  
smart sound - 14  
software, digital update - 25  
software, Internet update - 25  
software, version - 25  
sound settings - 21  
specifications - 43

---

standby - 13  
subtitle, analogue - 18  
subtitle, digital - 18  
subtitle, language - 24  
subtitles, language - 18  
switch channels - 13

---

## T

technical specifications - 43  
teletext 2.5 - 16  
teletext, digital text - 16  
teletext, dual screen - 16  
teletext, enable - 16  
teletext, enlarge - 16  
teletext, language - 24  
teletext, menu - 16  
teletext, search - 16  
teletext, subpages - 16  
teletext, Table Of Pages - 16

---

## U

universal access, enable - 19

---

## V

visually impaired - 19  
volume, adjust - 13  
volume, mute - 14

---

## W

wall mount TV - 7



© 2010 Koninklijke Philips Electronics N.V.  
All rights reserved.  
Document order number 313913703583

## Free Manuals Download Website

<http://myh66.com>

<http://usermanuals.us>

<http://www.somanuals.com>

<http://www.4manuals.cc>

<http://www.manual-lib.com>

<http://www.404manual.com>

<http://www.luxmanual.com>

<http://aubethermostatmanual.com>

Golf course search by state

<http://golfingnear.com>

Email search by domain

<http://emailbydomain.com>

Auto manuals search

<http://auto.somanuals.com>

TV manuals search

<http://tv.somanuals.com>