

Register your product and get support at
www.philips.com/welcome



EN User manual

40PFL9715K
46PFL9715K

PHILIPS

All rights reserved. Specifications are subject to change without notice. Trademarks are the property of Koninklijke Philips Electronics N.V. or their respective owners. Philips reserves the right to change products at any time without being obliged to adjust earlier supplies accordingly.

The material in this manual is believed adequate for the intended use of the system. If the product, or its individual modules or procedures, are used for purposes other than those specified herein, confirmation of their validity and suitability must be obtained. Philips warrants that the material itself does not infringe any United States patents. No further warranty is expressed or implied.

Philips cannot be held responsible either for any errors in the content of this document or for any problems as a result of the content in this document. Errors reported to Philips will be corrected and published on the Philips support website as soon as possible.

Terms of warranty

- Risk of injury, damage to TV or void of warranty! Never attempt to repair the TV yourself.
- Use the TV and accessories only as intended by the manufacturer.
- The caution sign on the back of the TV indicates risk of electric shock. Never remove the TV cover. Always contact Philips Customer Support for service or repairs.
- Any operation expressly prohibited in this manual, or any adjustments and assembly procedures not recommended or authorised in this manual shall void the warranty.

Pixel characteristics

This LCD product has a high number of colour pixels. Although it has effective pixels of 99.999% or more, black dots or bright points of light (red, green or blue) may appear constantly on the screen. This is a structural property of the display (within common industry standards) and is not a malfunction.

Open source software

This television contains open source software. Philips hereby offers to deliver, upon request, a copy of the complete corresponding source code for the copyrighted open source software packages used in this product for which such offer is requested by the respective licences. This offer is valid up to three years after product purchase to anyone in receipt of this information. To obtain the source code, please contact open.source@philips.com.

If you prefer not to use email or if you do not receive a confirmation receipt within a week after mailing to this email address, please write in English to

Open Source Team, Philips
Intellectual Property & Standards, P.O. Box 220, 5600
AE Eindhoven, The Netherlands

If you do not receive timely confirmation of your letter, please send an email to the email address above. The texts of the licences and acknowledgements for open source software used in this product are included on a separate leaflet.

Compliance with EMF

Koninklijke Philips Electronics N.V. manufactures and sells many products targeted at consumers which, like any electronic apparatus, in general have the ability to emit and receive electromagnetic signals. One of Philips' leading Business Principles is to take all necessary health and safety measures for our products, to comply with all applicable legal requirements and to stay well within the Electro Magnetic Field (EMF) standards applicable at the time of producing the products. Philips is committed to develop, produce and market products that cause no adverse health effects. Philips confirms that if its products are handled properly for their intended use, they are safe to use according to scientific evidence available today. Philips plays an active role in the development of international EMF and safety standards, enabling Philips to anticipate further developments in standardisation for early integration in its products.

EMC regulation

- In order to maintain conformity to the Electro Magnetic Compatibility (EMC) directive (2004/108/EC), the mains plug on this product must not be detached from the mains cord.
- In case the apparatus does not recover in DLNA/Net TV mode, user intervention is required.

Mains fuse (UK only)

This TV is fitted with an approved moulded plug. Should it become necessary to replace the mains fuse, this must be replaced with a fuse of the same value as indicated on the plug (example 10A).

1. Remove fuse cover and fuse.
2. The replacement fuse must comply with BS 1362 and have the ASTA approval mark. If the fuse is lost, contact your dealer in order to verify the correct type.
3. Refit the fuse cover.

Copyright

Windows Media is either a registered trademark or trademark of Microsoft Corporation in the United States and/or other countries.

Manufactured under licence from Dolby Laboratories. Dolby and the double-D symbol are trademarks of Dolby Laboratories.

DLNA®, the DLNA Logo and DLNA CERTIFIED® are trademarks, service marks or certification marks of the Digital Living Network Alliance.

HDMI, the HDMI logo and High-Definition Multimedia Interface are trademarks or registered trademarks of HDMI licensing LLC in the United States and other countries.

All other registered and unregistered trademarks are the property of their respective owners.



SDHC Logo is a trademark of SD-3C, LLC.

Contents

1	To begin	4
1.1	TV tour	4
1.2	Setting up	8
1.3	Keys on the TV	14
1.4	Register your TV	16
1.5	Help and support	17

2	Use your TV	18
2.1	Remote control	18
2.2	Menus	21
2.3	Watch TV	23
2.4	Watch 3D	27
2.5	Watch satellite	28
2.6	Watch a connected device	30
2.7	Subtitles and languages	31

3	More TV	32
3.1	Net TV	32
3.2	Interactive TV	34
3.3	Text	35
3.4	Videos, photos and music	37
3.5	Games	39
3.6	Locks and timers	40

4	Setup	41
4.1	Picture and sound	41
4.2	Ambilight	43
4.3	Channels	44
4.4	Satellite channels	46
4.5	Network	48
4.6	Devices	50
4.7	Universal access	51
4.8	Software	52

5	Connections	53
5.1	First connections	53
5.2	About cables	54
5.3	Connect devices	56
5.4	Connect more devices	64
5.5	Network	68
5.6	SD card	69
5.7	Common interface CAM	70
5.8	3D	71

6	Troubleshooting	72
6.1	Contact information	72
6.2	TV and remote control	73
6.3	TV channels	74
6.4	Picture and sound	75
6.5	Devices	76
6.6	Videos, photos and music	77
6.7	Network	78

7	Specifications	79
7.1	Software	79
7.2	Environmental	80
7.3	Power and reception	81
7.4	Display and sound	82
7.5	Display resolutions	83
7.6	Multimedia	84
7.7	Connectivity	85
7.8	Dimensions and weights	86

Index	87
--------------	-----------

1 To begin

1.1 TV tour

The remote control

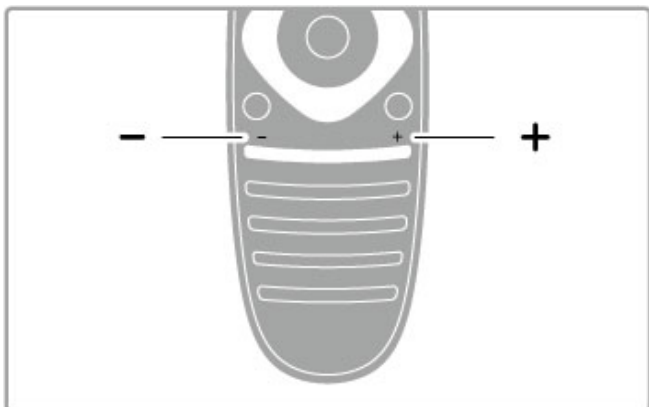

To adjust the volume.

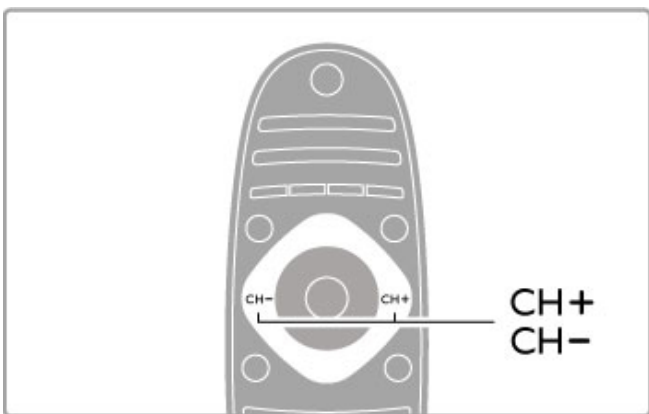

To switch TV channels.

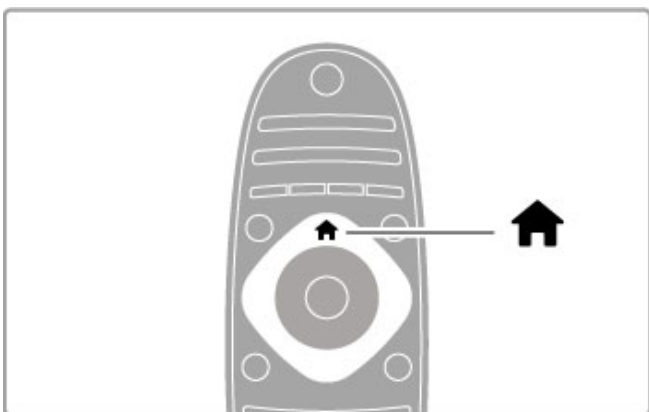

To open or close the **Home menu** .

Open the Home menu as a starting point to operate the TV.

In the Home menu, you can start or stop a TV activity. Such as watching TV - **Watch TV** - or watching a movie from a connected DVD player.

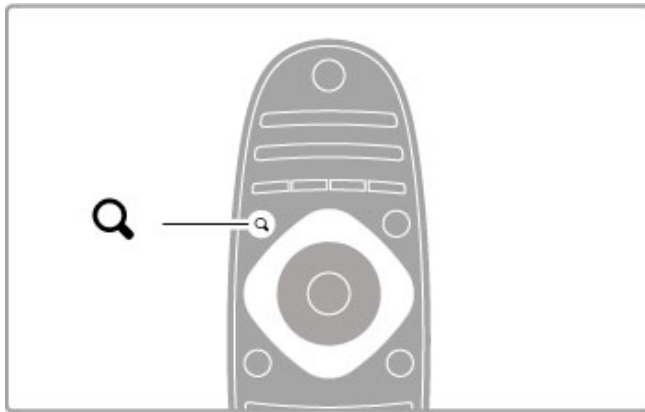

To open or close the **FIND menu** .

Open the Find menu to open the **list of channels** while you are watching TV channels or the list of videos and music while you browse your PC on TV.

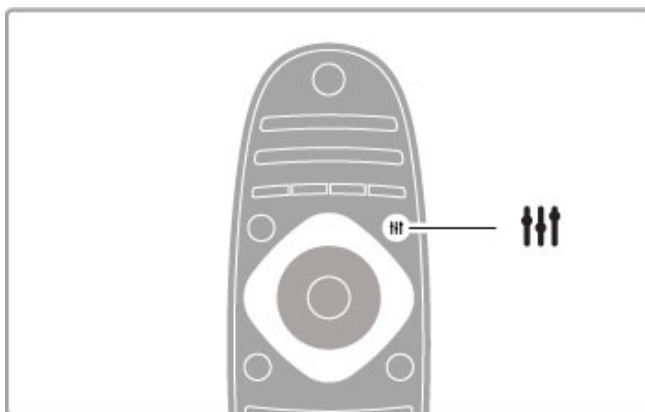

To open or close the **ADJUST menu** .

Open the Adjust menu to quickly adjust the picture and sound settings.

You can set the Smart picture setting to **Game**, which is ideal for gaming, or change the Smart sound setting of the TV loudspeakers.

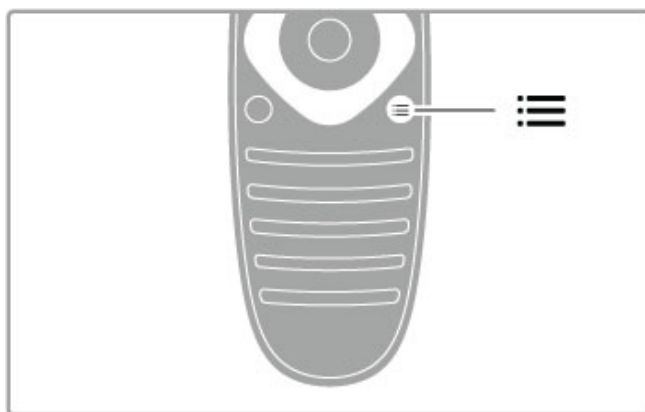

To open or close the **OPTIONS menu** .

Open the Options menu to select optional settings related to what you are watching or doing on TV.

While you watch a channel, mark it as a favourite channel or whilst watching a photo slideshow, stop the slideshow.

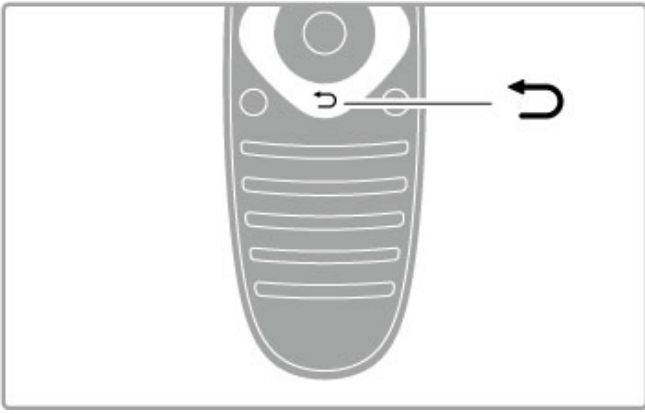

Back ↶.

With Back, you can go back to the previous TV channel or go one step back in a menu.

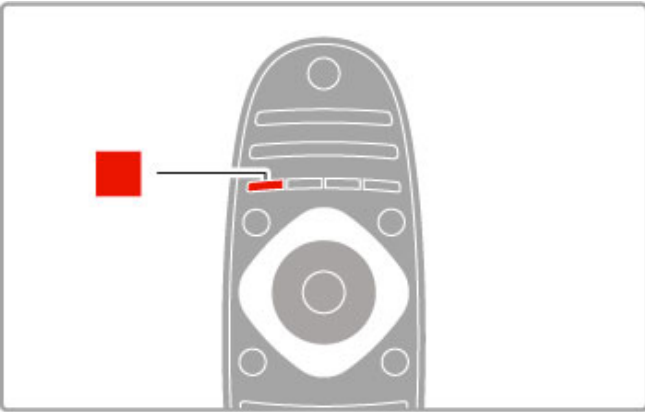

Red

With the red key, you can select the red option or open digital **Interactive TV** or some TV demonstration clips.

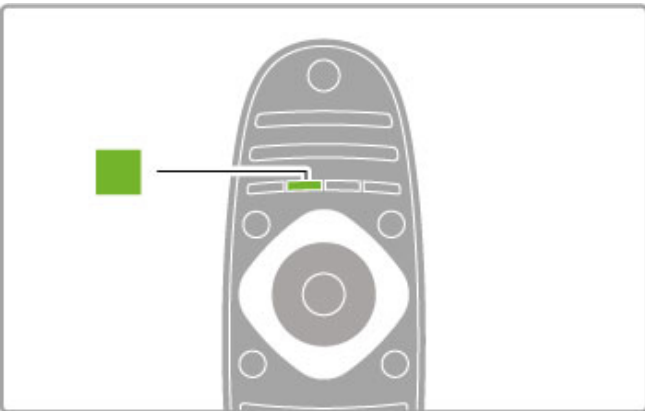

Green

With the green key, you can select the green option or the **Eco settings**.

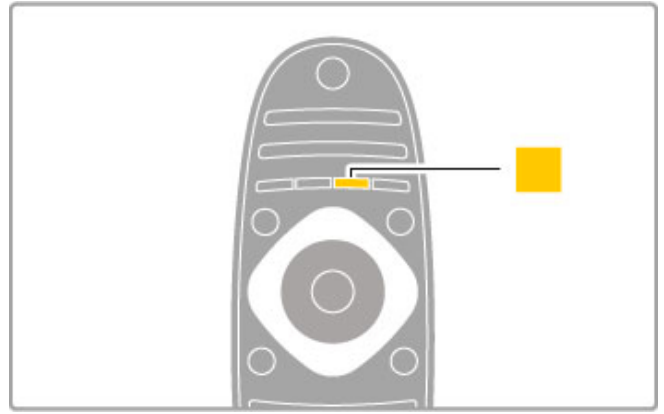

Yellow

With the yellow key, you can select the yellow option.

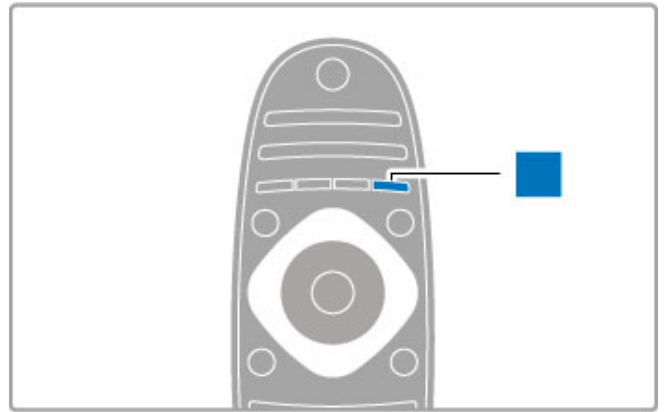

Blue

With the blue key, you can select the blue option.

Read more about the remote control in **Help > Use your TV > Remote control > Overview**.

Or go to the **Q Search** page in this Help to look for any topic.

Press **▲** to select the next TV tour.

Connecting devices

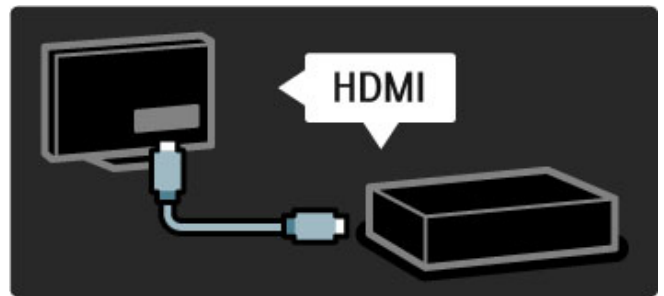

Use the **HDMI™** connection to connect a DVD, Blu-ray Disc player or game console.

The HDMI connection offers the best picture and sound quality and, if your device has **EasyLink** (HDMI-CEC), the TV can add the device in the Home menu automatically.

When a device is added in the Home menu, you can select it to watch its programme. If the device has no EasyLink or you do not use the HDMI connection, you must add the connected device in the Home menu using **Add your devices**.

Read more about Add your devices in **Help > Use your TV > Menus > Home**.

Read more about using EasyLink in **Help > Use your TV > Remote control > Operate devices**.

In the chapter **Help > Connections**, drawings like these will help you to connect most common devices.

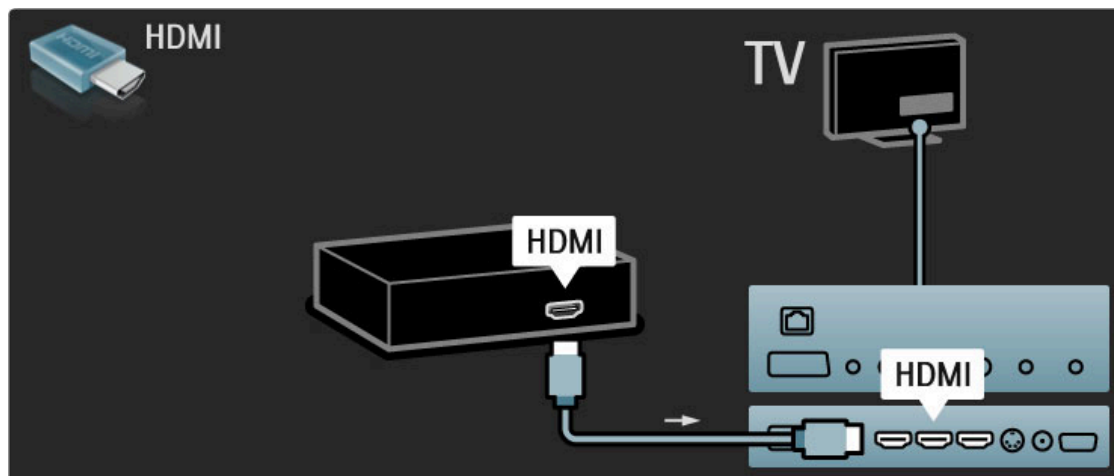

High Definition TV

This TV can display High Definition programmes, but to enjoy HD TV you need to get programmes in HD first. If you are not watching HD programmes, the picture quality will be that of a normal TV.

Watch **HD TV** programmes from . . .

- a Blu-ray Disc player
- a digital HD receiver connected with HDMI and with a subscription to HD programmes
- over-the-air HD broadcasts
- channels offering HD on a digital network
- an HD game console connected with HDMI and playing an HD game

HD video clip

To experience the stunning sharpness and picture quality of HD TV, you can start the High Definition video clip from the Home menu. Press **Home > Setup > Watch demos** (on the second page of the Setup menu).

Contact your dealer for more information.

Go to www.philips.com/support to find FAQs featuring the list of HD channels or providers in your country.

Network and Net TV

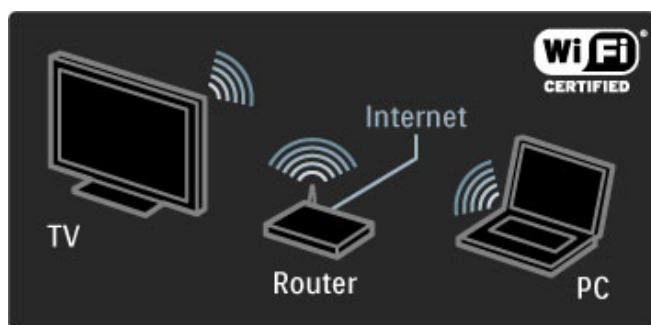

Wireless home network

Simply link up this TV to your wireless home network. There is no need for a network cable. Enjoy your videos, photos and music files from your PC on your TV screen.

Read more about Network in [Help > Setup > Network](#).



Net TV

If you have an Internet connection on your home network, you can connect to Net TV. Net TV offers you online movies, pictures, music, infotainment, games and much more.

Read more about Net TV in [Help > More TV > Net TV](#).

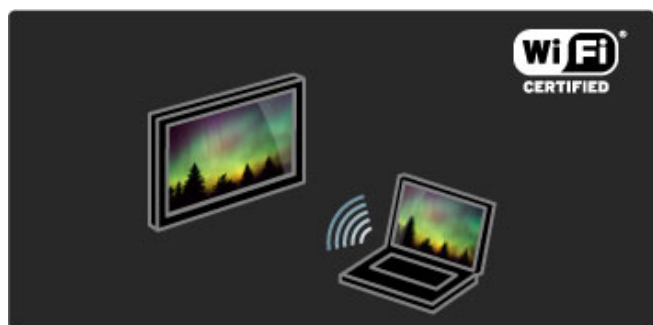

Wi-Fi MediaConnect

You can use Wi-Fi MediaConnect to project files like movies, music or presentations wirelessly from your laptop or desktop PC onto your TV.

Read more about Wi-Fi MediaConnect in [Help > Setup > Network > Wi-Fi MediaConnect](#).

Satellite receiver

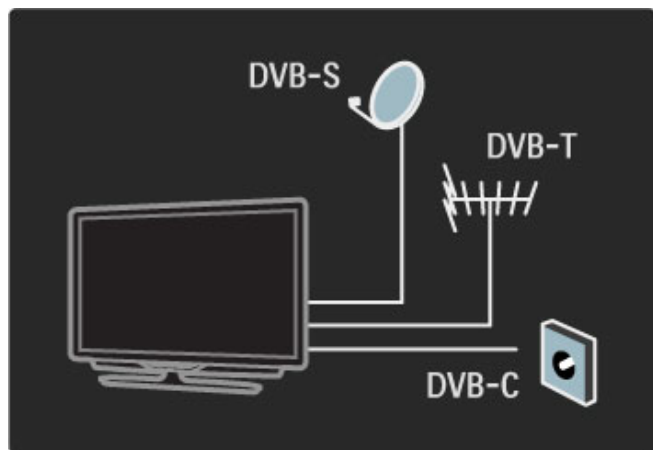

Next to the DVB-T and DVB-C reception, this TV has a built-in satellite DVB-S/S2 receiver. You can connect a satellite dish antenna and receive **digital satellite channels**.

Read more about Satellite Channels in [Help > Setup > Satellite channels](#).

1.2 Setting up

Stand or wall mounting

The 2-in-1 stand that comes with the TV, can be used as a table-top stand or as a wall mount bracket. Instructions to mount the 2-in-1 stand are also included in the printed Start guide.

Read the instructions on the following pages.

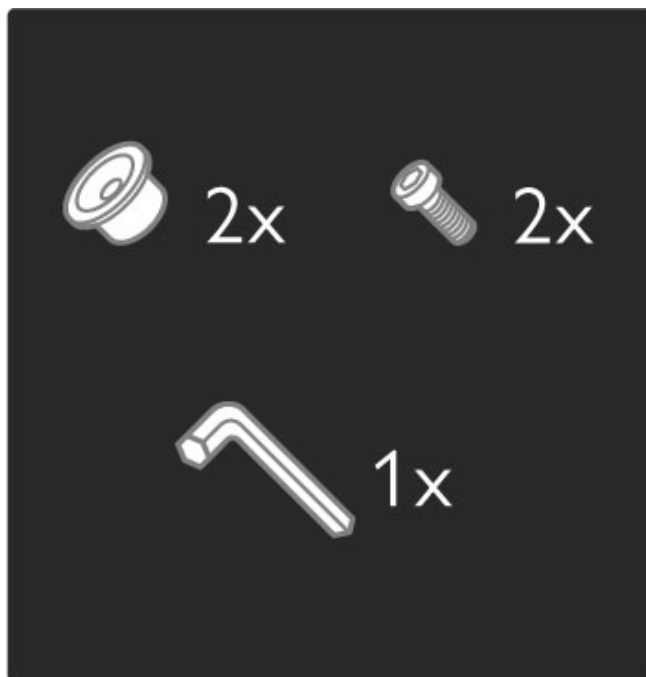
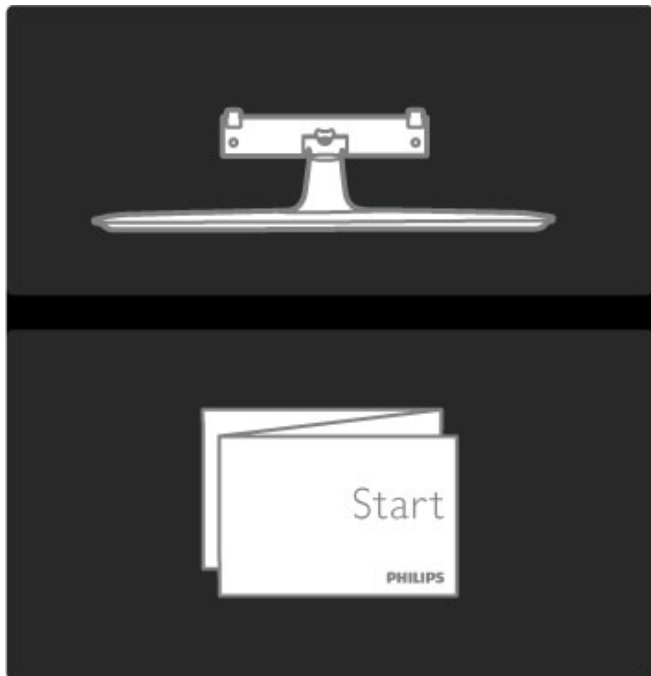

Unscrew the bolt in the middle of the bar with the supplied hex key.

Caution

Wall mounting the TV requires special skills and should only be performed by qualified personnel. The TV wall mounting should meet safety standards according to the TV's weight. Read also the safety precautions before positioning the TV.

Koninklijke Philips Electronics N.V. bears no responsibility for improper mounting or any mounting that results in accident or injury.

Unmount the TV from the stand if necessary.

To wall mount the TV, you need the 2 screws used to fix the TV onto the TV stand and the 2 mounting discs as shown.

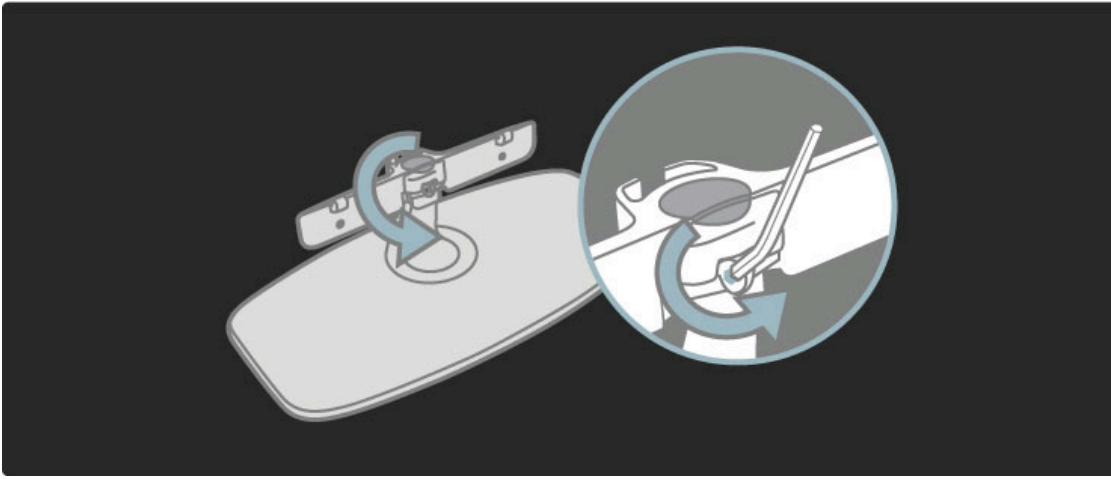

Turn the bar as shown.

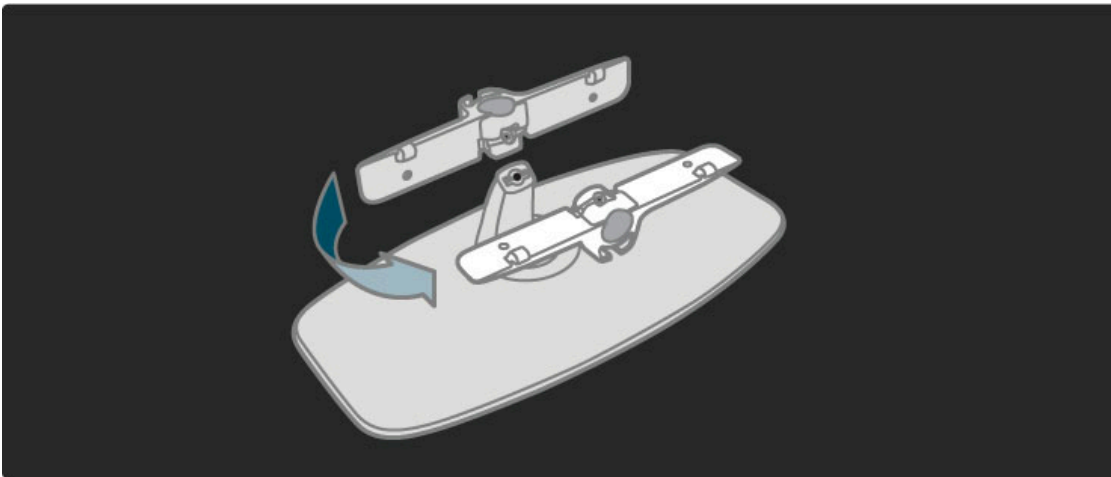

Reposition the bar on the stand and fix the bolt with the hex key.

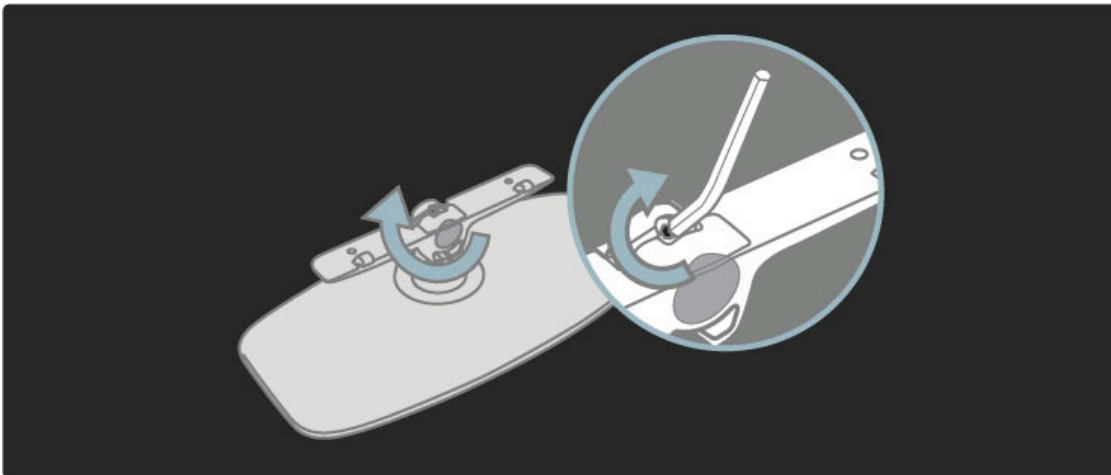

Fix the stand to the TV.

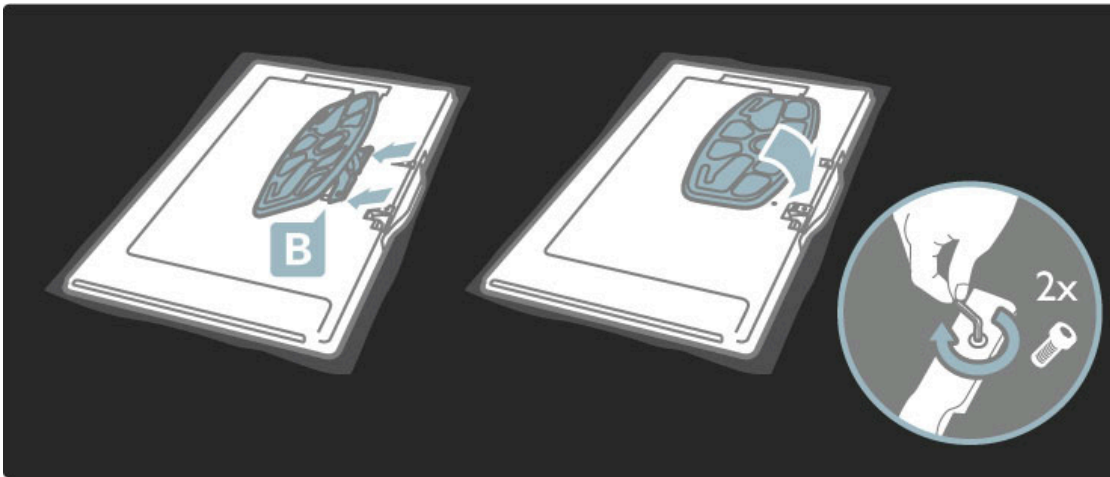

The TV is mounted at the correct height if your eyes are level with the centre of the screen when you sit down.

Distance between the 2 fixing points . . .

- 81cm/32" = 260mm
- 102cm/40" = 300mm
- 117cm/46" = 340mm

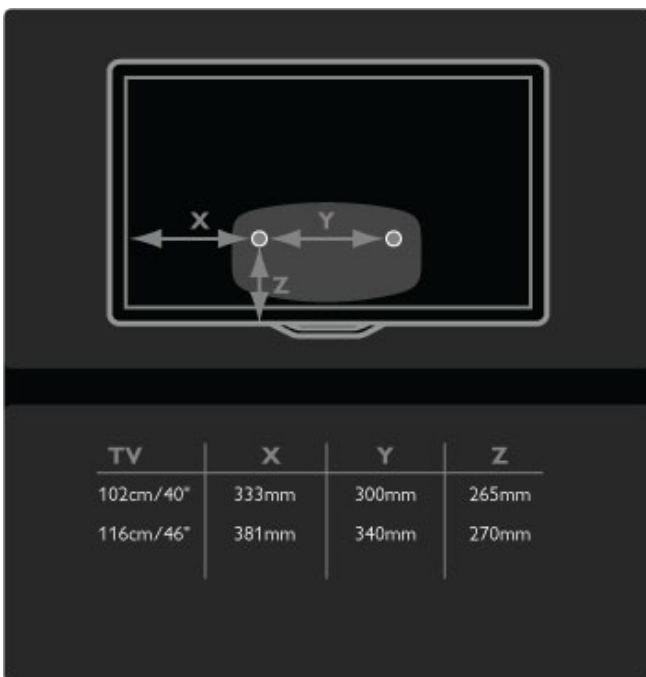

Fix the 2 mounting discs. Use screws with a diameter of max 6mm.

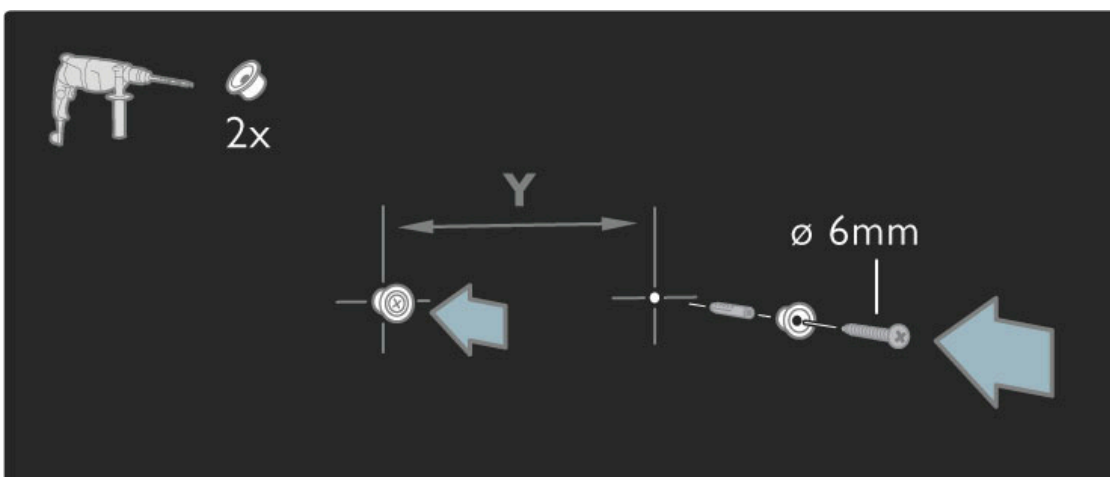

Slide the bottom plate of the stand onto the mounting discs.

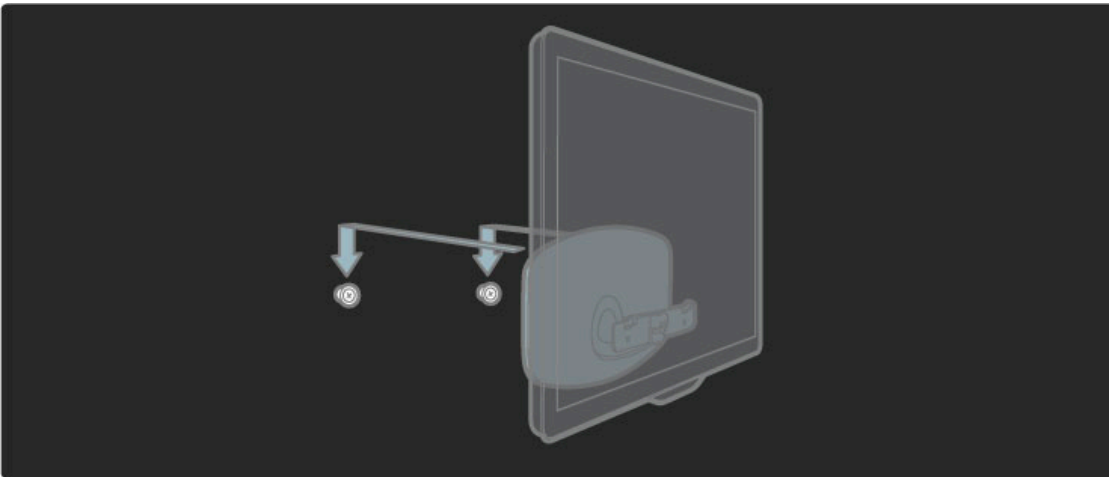

To level the TV, pull the bottom of the TV towards you slightly and let it slide on the discs.

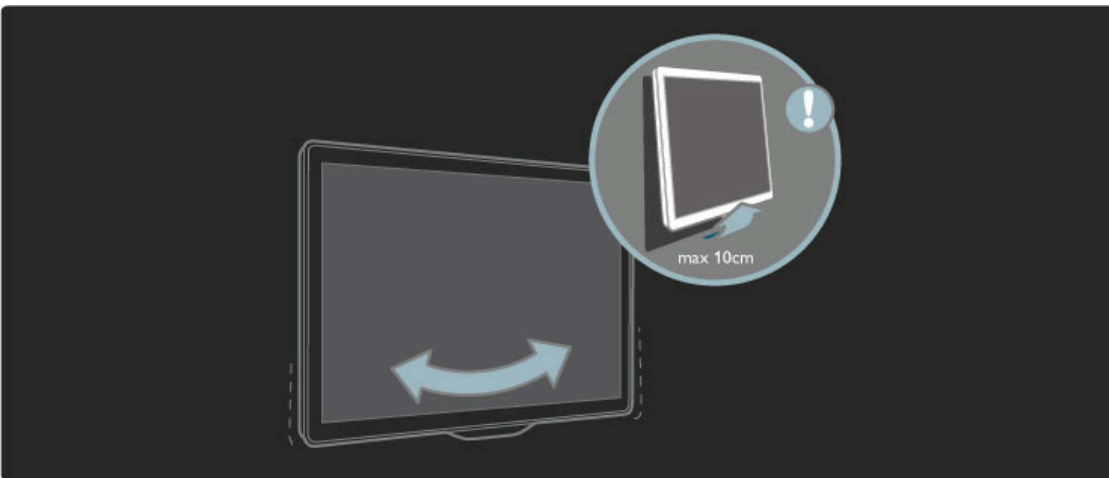

Unscrew the bolt and turn the bar in the position shown.

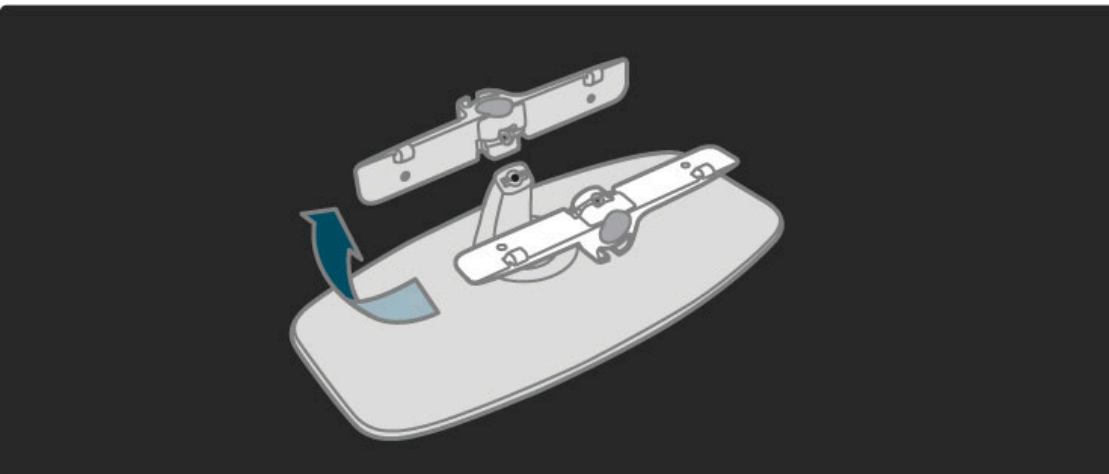

VESA info

Your TV is prepared for a VESA-compliant wall mount bracket (not included).

VESA codes to purchase the bracket:

- 40PFL9715 : VESA MIS-F 200, 300, M6
- 46PFL9715 : VESA MIS-F 300, 300, M6

Use a screw length as shown in the drawing.

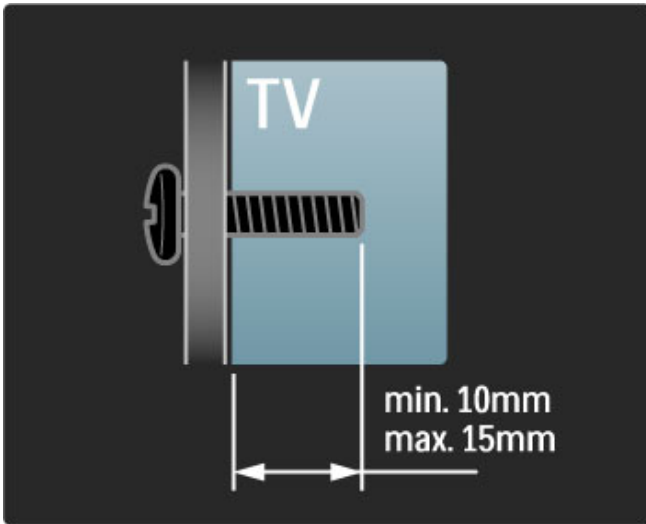

- Never expose the TV, remote control or batteries to excessive heat. Never place them near burning candles, naked flames or other heat sources, including direct sunlight.
- Never insert objects into the ventilation slots or other openings on the TV.
- Never place heavy objects on the power cord.

- Avoid force coming onto power plugs. Loose power plugs can cause arcing or fire. Ensure that no strain is exerted on the power cord when you swivel the TV screen.
- When disconnecting the power cord, always pull the plug, never the cord. Ensure that you have full access to the power plug at all times.

Risk of injury or damage to the TV!

- Two people are required to lift and carry a TV that weighs more than 25 kg or 55 lbs.
- If you mount the TV on a stand, only use the supplied stand. Secure the stand to the TV tightly. Place the TV on a flat, level surface that can support the weight of the TV and the stand.

- When wall mounted, ensure that the wall mount can safely bear the weight of the TV set. Koninklijke Philips Electronics N.V. bears no responsibility for improper wall mounting that results in accident, injury or damage.
- Parts of this product are made of glass. Handle with care to avoid injury or damage.

Risk of damage to the TV!

Before you connect the TV to the power outlet, ensure that the power voltage matches the value printed on the back of the TV. Never connect the TV to the power outlet if the voltage is different.

Risk of injury to children!

Follow these precautions to prevent the TV from toppling over and causing injury to children:

- Never place the TV on a surface covered by a cloth or other material that can be pulled away.
- Ensure that no part of the TV hangs over the edge of the mounting surface.

- Never place the TV on tall furniture, such as a bookcase, without anchoring both the furniture and TV to the wall or a suitable support.
- Teach children about the dangers of climbing on furniture to reach the TV.

Risk of swallowing batteries!

The remote control may contain coin-type batteries which can easily be swallowed by small children. Keep these batteries out of reach of children at all times.

Risk of overheating!

Never install the TV in a confined space. Always leave a space of at least 10 cm or 4 inches around the TV for ventilation. Ensure curtains or other objects never cover the ventilation slots on the TV.

Lightning storms

Disconnect the TV from the power outlet and antenna before lightning storms. During lightning storms, never touch any part of the TV, power cord or antenna cable.

Risk of hearing damage!

Avoid using earphones or headphones at high volumes or for prolonged periods of time.

Low temperatures

If the TV is transported in temperatures below 5°C or 41°F, unpack the TV and wait until the TV temperature reaches room temperature before connecting the TV to the power outlet.

Position the TV

Carefully read the safety precautions before you position the TV.

- Position the TV where light does not shine directly on the screen.
- Dim lighting conditions in the room for best Ambilight effect.
- Position the TV up to 25 cm away from the wall for the best Ambilight effect.



Position the TV at the ideal viewing distance. Get more from HD TV picture or any picture without straining your eyes. Find the 'sweet spot', right in front of the TV, for the best possible TV experience and relaxed viewing.

The ideal distance to watch TV from is three times its diagonal screen size. When seated, your eyes should be level with the centre of the screen.

Safety

Read and understand all instructions before you use the TV. If damage is caused by failure to follow instructions, the warranty does not apply.

Risk of electric shock or fire!

- Never expose the TV to rain or water. Never place liquid containers, such as vases, near the TV. If liquids are spilt on or into the TV, disconnect the TV from the power outlet immediately. Contact Philips Consumer Care to have the TV checked before use.

Care

- Never touch, push, rub or strike the screen with any object.
- Unplug the TV before cleaning.
- Clean the TV and frame with a soft damp cloth. Never use substances such as alcohol, chemicals or household cleaners on the TV.
- To avoid deformations and colour fading, wipe off water drops as quickly as possible.

- Avoid stationary images as much as possible. Stationary images are images that remain onscreen for extended periods of time. Stationary images include onscreen menus, black bars, time displays, etc. If you must use stationary images, reduce screen contrast and brightness to avoid screen damage.

Temperature and humidity

In rare occasions, depending on temperature and humidity, minor condensation can occur on the inside of the TV glass front (on some models). To prevent this, do not expose the TV to direct sunlight, heat or extreme humidity. If condensation occurs, it will disappear spontaneously while the TV is playing for a few hours. The condensation moisture will not harm the TV or cause malfunction.

1.3 Keys on the TV

Power switch

Switch the TV on or off with the power switch at the right-hand side of the TV. When switched off, the TV does not consume any energy.

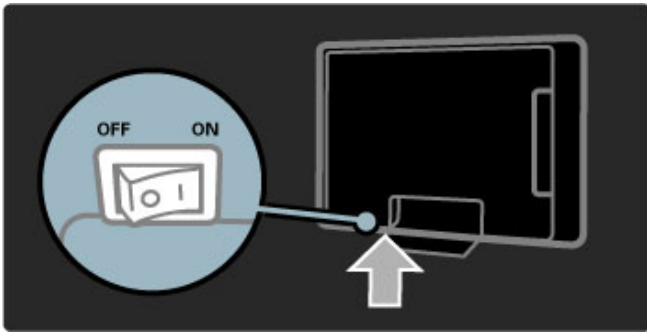

If the red indicator light is off, switch on the TV with the power switch.

If the red indicator is on (standby indication), press **⏻** on the remote control to switch on the TV. Alternatively, you can switch on the TV from standby with **CH+**, **CH-** or **🏠**. It takes a few seconds for the TV to start up.

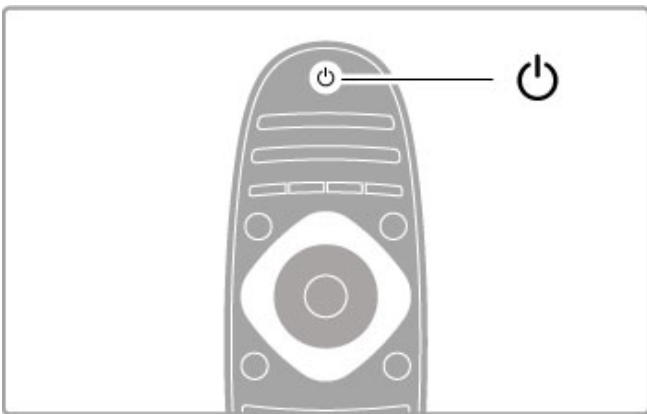

Volume

Press **🔊** (Volume) - or **+** to adjust the volume. Or use the **+** or **-** keys on the remote control.

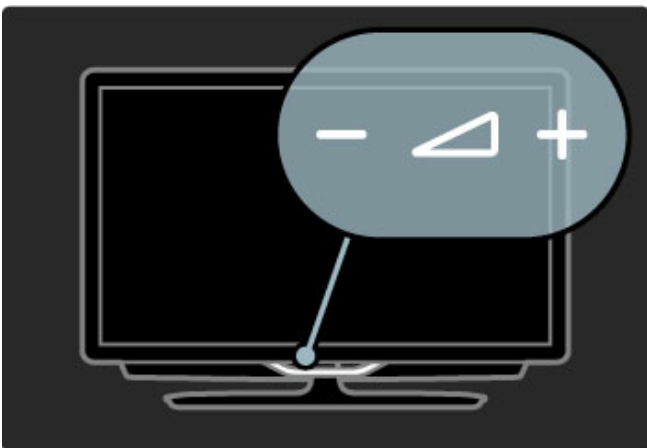

Ambilight

Press **🔊** **Ambilight**, to switch Ambilight on or off.

While the TV is on standby, you can switch Ambilight on and create an Ambilight LoungeLight effect in your room. Read more about LoungeLight in [Help > Use your TV > Use Ambilight > LoungeLight](#)

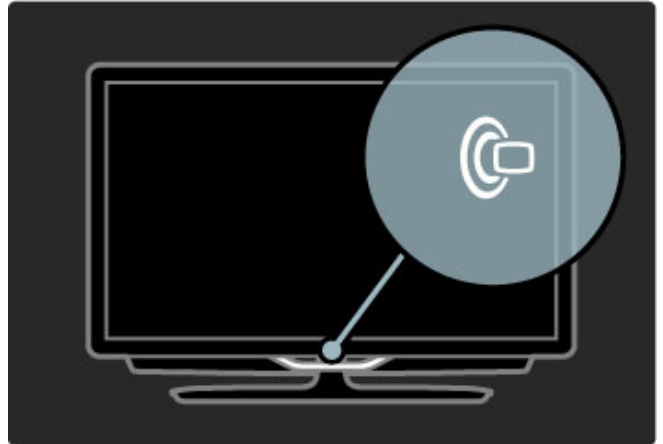

🏠 Home

Press **🏠** (Home) to open the Home menu on screen. You can navigate the Home menu with the volume - or **+** (left or right) and the channel - or **+** (down or up) keys on the TV. To confirm your choice, press **🏠** again.

Read more about Home in [Help > Use your TV > Menus > 🏠 Home](#)

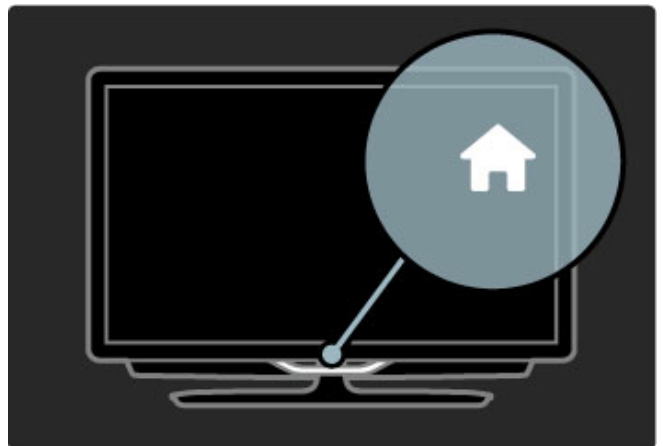

CH Channel

Press **CH** (Channel) - or **+** to switch channels. Or use the **▶** or **◀** keys on the remote control.

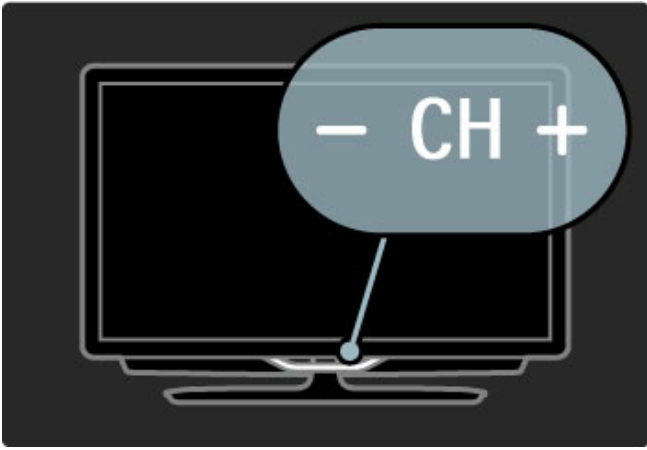

1.4 Register your TV

Congratulations on your purchase and welcome to Philips.

Register your TV and enjoy a range of benefits including full support (including downloads), privileged access to information about new products, exclusive offers and discounts, the chance to win prizes and even participate in special surveys about new releases.

Go to www.philips.com/welcome

1.5 Help and support

Using Help and Search

Help

You can open Help from the Home menu. In most cases, you can also press the **yellow** key on your remote control to open or close Help directly. For some activities, like Text, the colour keys have specific functions and cannot open Help.

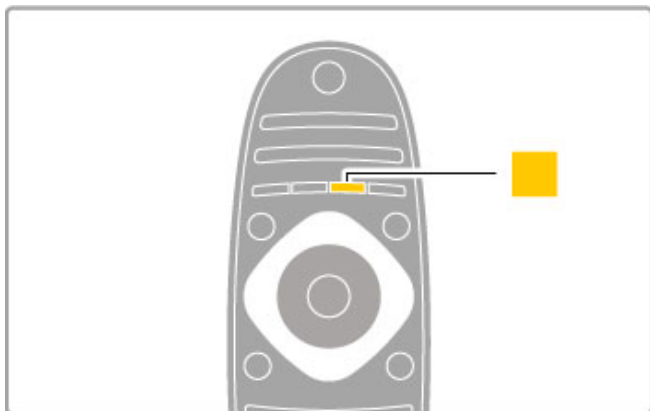

Before you follow the Help instructions, close Help. Press the **yellow** key or press **Home** to close Help. When you press the **yellow** key again, Help will open on the page where you closed it.

Search

In Help, use **Search** to find a topic you need. Select a topic from the list with the navigation keys and press **OK**. The topic you are looking for might not be on the first page but a few pages further on. Press **Next** to go to the next page.

Online support

To solve any Philips TV related problem, you can consult our online support. You can select your language and enter your product model number.

Go to www.philips.com/support

On the support site you can find your country's telephone number to contact us as well as answers to frequently asked questions (FAQs).

You can download new TV software or the manual to read on your PC. You can email a specific question or, in some countries, chat online to one of our collaborators.

Contact Philips

For support, you can call the Philips Consumer Care hotline in your country. Find the telephone number in the printed documentation that came with the TV.

Or consult our website www.philips.com/support

TV model number and serial number

You might be asked to provide the TV product model number and serial number. Find these numbers on the packaging label or on the type label on the back or bottom of the TV.

2 Use your TV

2.1 Remote control

Overview

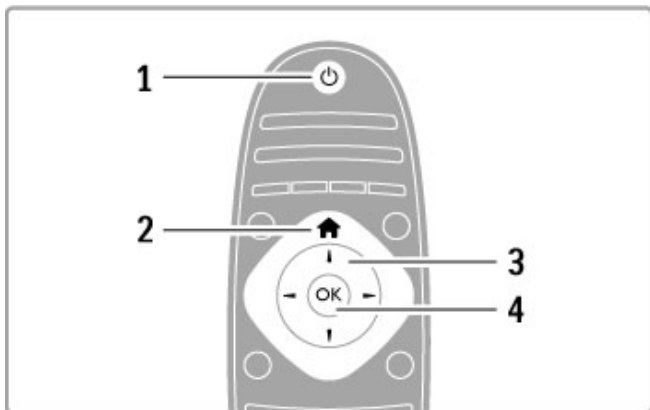

1 Standby

To switch the TV on or back to standby.

2 Home

To open or close the Home menu.

3 Navigation key

To navigate up, down, left or right.

4 OK key

To activate a selection.

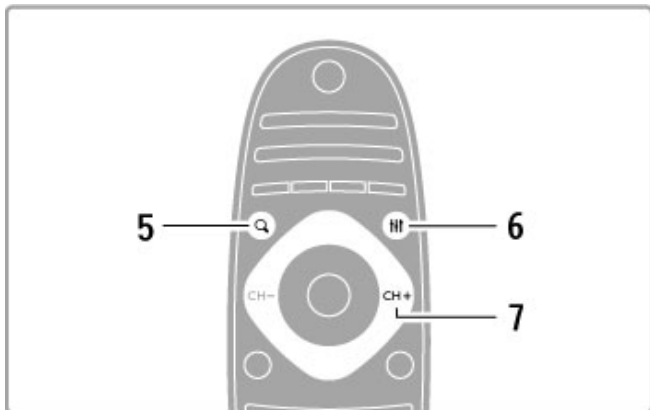

5 Find

To open or close the channel list or your list of photos, music or movies.

6 Adjust

To open or close the most used settings for picture, sound, Ambilight or 3D.

7 CH+ / Next

To switch to the next channel, page or chapter.

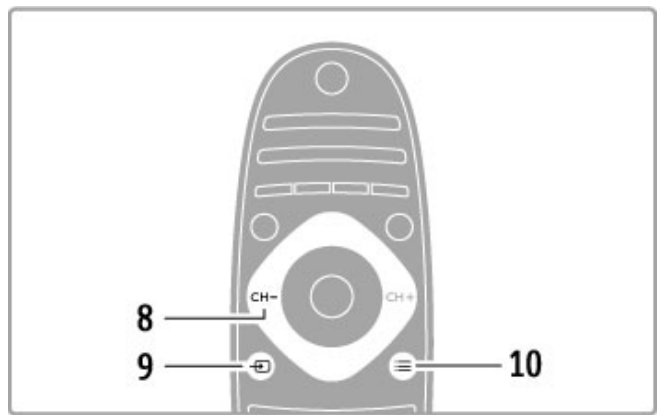

8 CH- / Previous

To switch to the previous channel, page or chapter.

9 Source

To switch directly to a TV connection.

10 Options

To open or close the Options menu.

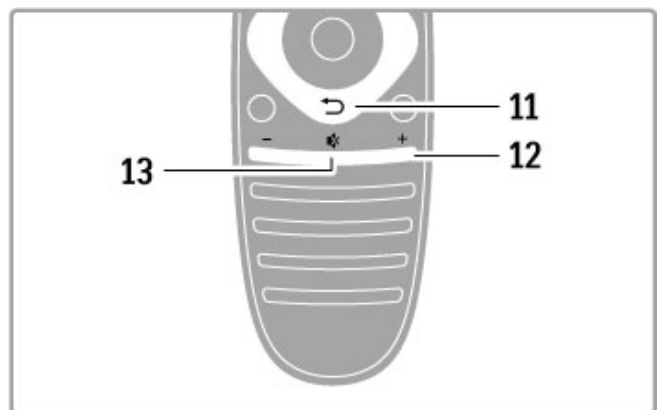

11 Back

To go back to the previous channel. To exit a menu without changing a setting. To go back to the previous Text or Net TV page.

12 Volume

To adjust the volume level.

13 Mute

To mute the sound or to restore it.

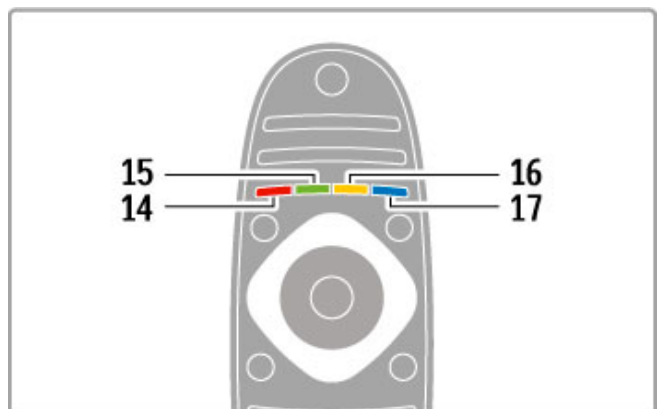

14 Red colour key

To open interactive TV or to select a Text page.

15 Green colour key

To open the Eco settings or to select a Text page.

16 Yellow colour key

To select a Text page.

17 Blue colour key

To select a Text page.

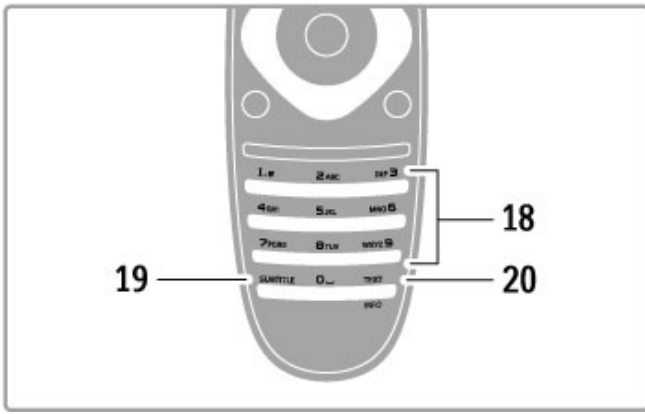

18 Number keys and text keypad

To select a TV channel directly or to enter text.

19 Subtitle

To switch Subtitles on or off.

20 Text / Info

To open or close text. / Keep this key pressed for 4 seconds to open or close information on next programmes.

Operate devices

The remote control of the TV can also operate a connected device. The device must have EasyLink (HDMI-CEC) and have it switched on. The device must also be connected with an HDMI cable.

Operate an EasyLink device

To operate such a device with the TV remote control, select the device -or its activity- in the **Home** menu and press **OK**.

The commands of all keys, except the **Home** key, the **ADJUST** key and the **OPTIONS** key, are forwarded to the device.

Switch back to TV

To switch the remote control back to operate the TV, press **Home** and select **Watch TV** and press **OK**.

Show device keys

When operating a device, some of the keys might not be available on the TV remote control. To make these keys selectable on TV, press **OPTIONS** and select **Show device keys**. Select the key you need and press **OK**.

To hide the device keys, press **Back**.

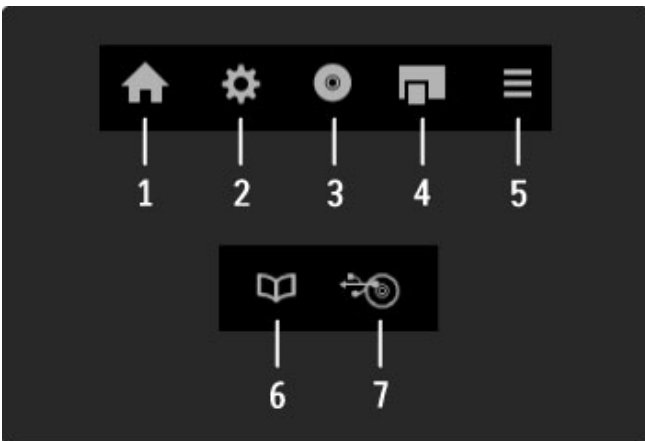

In general, these keys open the following device menus:

- 1 Home menu
- 2 Setup menu
- 3 Disc menu (disc content)
- 4 Pop-up menu
- 5 Options menu
- 6 Programme guide
- 7 Media selection

One Touch Play

Insert a disc into an EasyLink HDMI-CEC device and press **Play** on the device. The TV switches on from standby and starts playing the disc.

System Audio Control

If you connect an EasyLink audio system, you can listen to the audio from the TV through the audio system. The TV speakers are muted automatically. You can control the volume of the audio system with the TV remote control.

Surround mode

With recent Philips devices, you can change the surround sound setting of the device on the TV. To change this setting, press **ADJUST**, select **Surround mode** and press **OK**. On **Next mode**, press **OK** to toggle through the available modes on the device.

Smart sound

With recent Philips devices, you can change the Smart sound setting of the device on the TV. To change this setting, press **ADJUST**, select **Smart sound** and press **OK**. Select a sound mode from the list.

Screen off

If a recent Philips audio device only sends audio to the TV, the device may suggest switching off the TV screen. To switch off the screen when this message appears, select **Screen off** and press **OK**. To switch the screen back on, press **Home**.

System Standby

Press **Standby** on the remote control to switch the TV and all EasyLink devices to standby.

Read more about EasyLink in **Help > Setup > Devices > EasyLink HDMI-CEC**.

IR sensor

Always make sure you point the remote control at the remote control infrared sensor on the front of the TV.

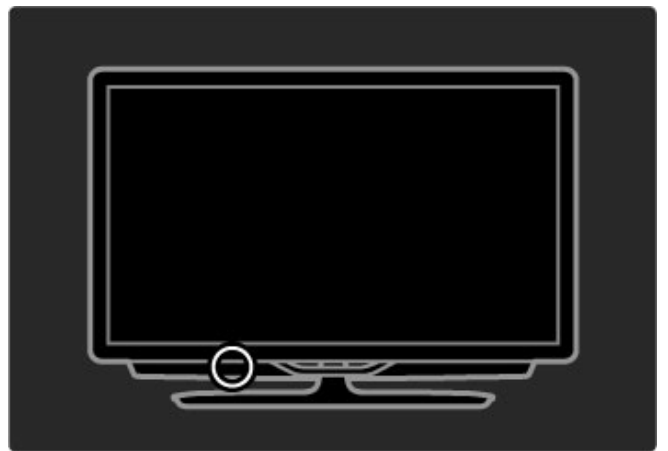

Batteries

To replace the batteries of the remote control, slide open the small tray at the bottom of the remote control. Use 2 coin-shaped batteries (Type CR2032 – 3V). Make sure the + side of the batteries (top side) point upwards. The small tray has a + indicator.

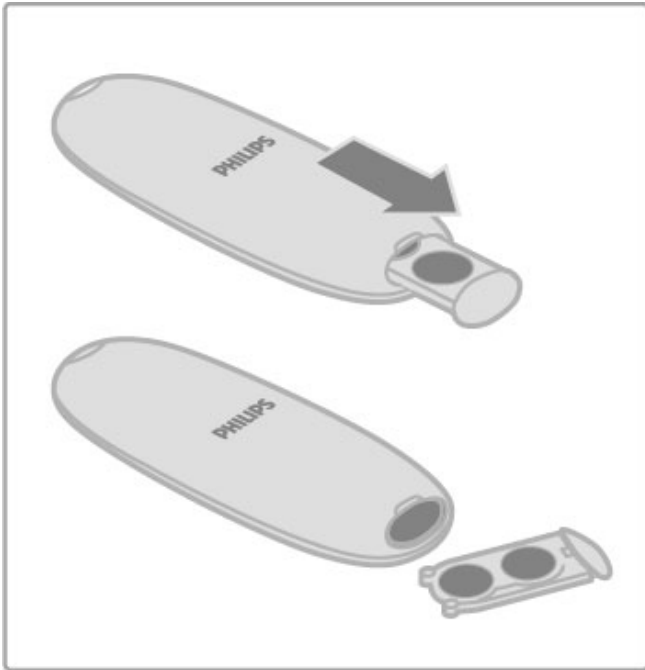

Remove the batteries if you are not using the remote control for a long time.

Dispose of batteries according to the end of use directives. Read **Help > To begin > Setting up > End of use.**

Cleaning

Your remote control is treated with a scratch-resistant coating.

To clean the remote control, use a soft damp cloth. Never use substances such as alcohol, chemicals or household cleaners on the TV or remote control.

2.2 Menus

🏠 Home

In the Home menu, you start watching TV or start watching a movie disc or any other TV activity.

Press 🏠 to open the Home menu.

To start an activity, select it with the navigation keys and press **OK**.

To close the Home menu, press 🏠 again.

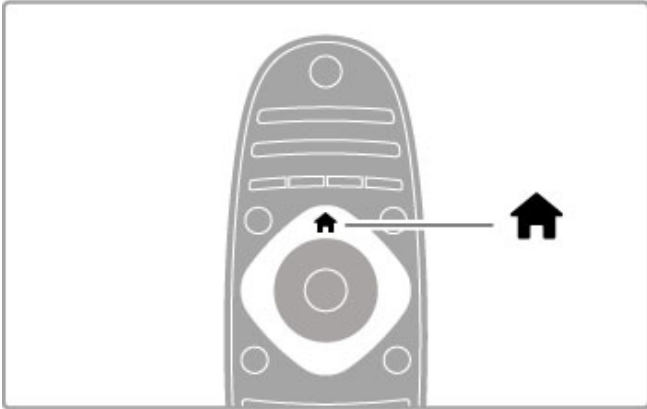

Add your devices

A connected device should be added to the Home menu for easy selection.

If your connected device does not have EasyLink (HDMI-CEC) or is not connected with an HDMI cable, you need to manually add your device to the Home menu with **Add your devices**.

Devices with EasyLink (HDMI-CEC) and connected with an HDMI cable automatically show their activity in the Home menu. A single device can add several activities.

If an EasyLink device does not appear automatically, EasyLink on the device may be switched off.

Add a device manually

In the Home menu, select **Add your devices** and press **OK**. Follow the instructions on screen.

The TV asks you to select the device and the connection to which the device is connected.

The device or its activities are now added to the Home menu.

Rename a device

To rename an added device or activity, select the device in the Home menu and press **≡ OPTIONS** and select **Rename**. Use the keypad on the remote control as you do for SMS/text messaging to enter the new name.

Remove a device

To remove a device or activity from the Home menu, select it and press **≡ OPTIONS** and then select **Remove this device**. If a device or activity keeps appearing in the Home menu after you deleted it, switch off the EasyLink setting on the device to prevent the icon from being automatically added again.

Read more about EasyLink in **Help > Use your TV > Remote control > Operate devices**.

Reorder

To reorder a device or an activity in the Home menu, select it and press **≡ OPTIONS**.

1 Select **Reorder**.

2 With the navigation keys, reposition the device or activity where you want it. You can only reorder the sequence of the added devices and activities.

3 Press **OK** to confirm the position. All devices and activities shift to the right.

You can highlight another device or activity and reposition it.

To stop Reorder, press **≡ OPTIONS** and select **Exit reorder**.

Restore activities

To recall a deleted activity from a device with several activities, select the device or one of its activities and press **≡ OPTIONS**. Select **Restore activities** and press **OK**. All deleted activities of this device appear again.

🔍 FIND

With **Q FIND** you open the Channel list while you are watching TV channels or you open the list of pictures, music and videos while browsing your PC or connected USB device.

Press **Q FIND** to open the list.

To close the list, press **Q** again.

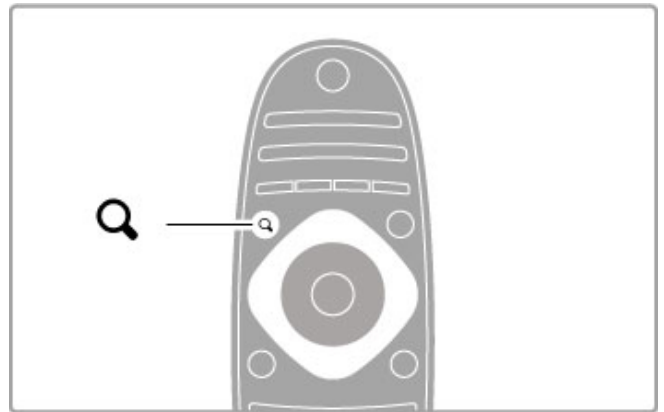

⚙️ ADJUST

With the **ADJUST** menu, you can adjust picture, sound, Ambilight and 3D settings quickly.

Press **⚙️ ADJUST** to open the Adjust menu.

Select your choice with the navigation keys and press **OK**.

To close the menu, press **⚙️ ADJUST** again.

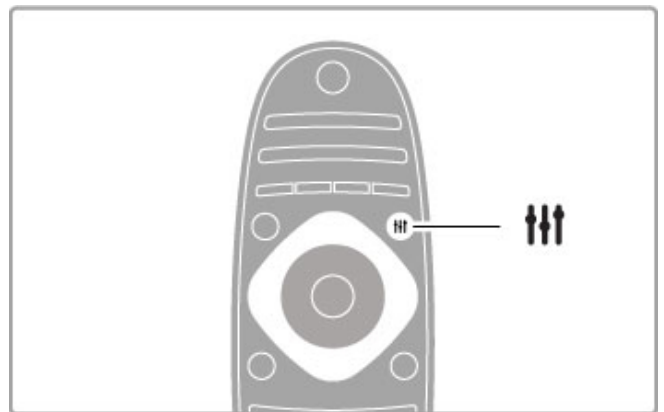

In the Adjust menu you can do these settings:

- Ambilight On or Off
- Ambilight dynamics
- Picture format
- Smart picture (presets)
- Smart sound (presets)
- Speakers
- Surround
- Picture shift

Ambilight

Read more about the Ambilight settings in **Help > Setup > Ambilight**.

Picture format

Read more about the Picture format settings in **Help > Use your TV > Watch TV > Picture format**.

Smart picture, Smart sound

You can set the TV to the pre-defined setting that best suits what you're watching.

Read more about Smart settings in **Help > Use your TV > Watch TV > Smart settings**.

Speakers

To hear the sound through the TV speakers, close Help, press **ADJUST**, select **Speakers** and select **TV**.

Select **Amplifier** if you want to hear the sound through a connected Home Theatre System or Amplifier.

These settings temporarily override any EasyLink settings.

Surround

To switch the TV automatically to the best surround sound mode (only available when a Home Theatre System is connected), close Help, press **ADJUST**, select **Surround** and select **On**.

Picture shift

You can shift the picture on screen in a vertical or a horizontal direction to view subtitles fully (depending on the TV input).

While watching TV, press **ADJUST**, select **Picture shift** and press **OK**. Shift the picture with the navigation keys. Press **OK** to stop Picture shift.

☰ OPTIONS

With the OPTIONS menu, you select optional settings related to what you are watching or doing on TV.

Press **☰ OPTIONS** at any time to see which options are available.

To close the menu, press **☰ OPTIONS** again.

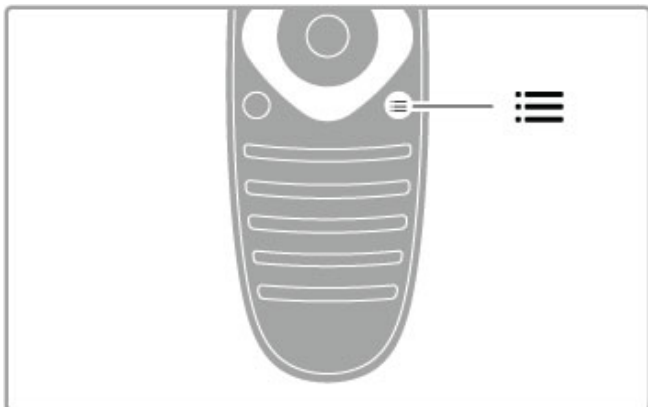

2.3 Watch TV

Switch channels

To watch TV and switch channels, make sure the **Watch TV** option is selected in the Home menu.

To watch TV, press **HOME**, select **Watch TV** and press **OK**.



To switch channels, press **CH+** or **CH-** on the remote control. You can use the number keys if you know the channel number or press **Q.FIND** to open the Channel list to select a channel.

To switch back to the previous channel, press **BACK**.

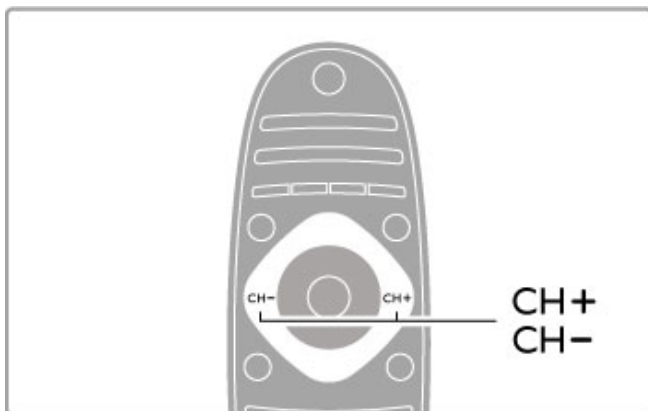

Radio channels

If digital broadcasting is available, digital radio stations are installed during installation. Switch to a radio channel just like you switch to a TV channel. A DVB-C channel installation usually places radio stations from channel number 1001 onwards.

Options for watching TV channels

If you watch digital broadcast TV channels, press **≡ OPTIONS** to view the available options:

- What's on
- Status
- Video selection

What's on

This option shows information on the current and next programme on this channel. Use the navigation keys to scroll through text or to go to the next column.

Status

Depending on the broadcast, the Status page will show relevant information. You can use this information to improve the channel signal or to check if certain services are available.

Video selection

Digital TV channels can offer multi video signals (multi-feed broadcasts), different camera viewpoints or angles of the same event or different programmes on one TV channel. The TV shows a message to advise if any such TV channels are available. When available, press **≡ OPTIONS** and select **Video selection** to select your choice.

Use your TV / Watch TV

Channel list

In the Channel list, you can look up all installed TV and radio channels.

While watching TV, press **Q.FIND** to open the Channel list. Press **Q.FIND** again or **BACK** to close the Channel list without changing the channel.

In the Channel list, you can navigate to a TV channel or radio station and press **OK** to watch the TV channel or listen to the radio station.

The Channel list can have several pages. To view the next or previous Channel list page, press **▶** or **◀**.

Channel list options

With the Channel list on screen, press **≡ OPTIONS** to select the following options:

- Select list
- Mark as favourite
- Reorder
- Rename

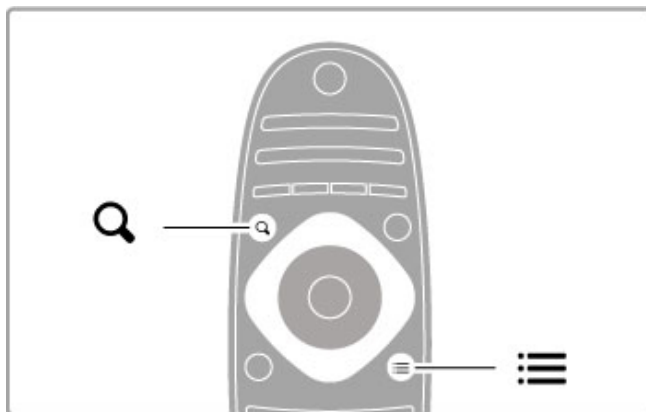

Select list

Use this option to select which channels are shown in the Channel list. The list you select here determines which channels you flick through with **CH+** and **CH-**.

Mark as favourite

When a channel is highlighted in the Channel list, you can set it as a favourite channel.

Read **Use your TV > Watch TV > Favourite channels**.

Reorder

You can reposition channels within the list.

1 Press **≡ OPTIONS** and select **Reorder** to start reordering channels.

2 Highlight a channel and press **OK**.

3 Reposition the channel where you want it with the navigation keys. Alternatively, enter the new position directly with the number keys.

4 Press **OK** to confirm the position. You can insert the channel or swap it.

You can highlight another channel and do the same.

To stop Reorder, press **≡ OPTIONS** and select **Exit reorder**.

Rename

You can rename a channel in the Channel list.

- 1 In the channel list, highlight the channel you want to rename.
- 2 Press **≡** **OPTIONS** and select **Rename** to start renaming. You can enter text directly with the remote control keypad or open a full keyboard on top of the text entry menu.

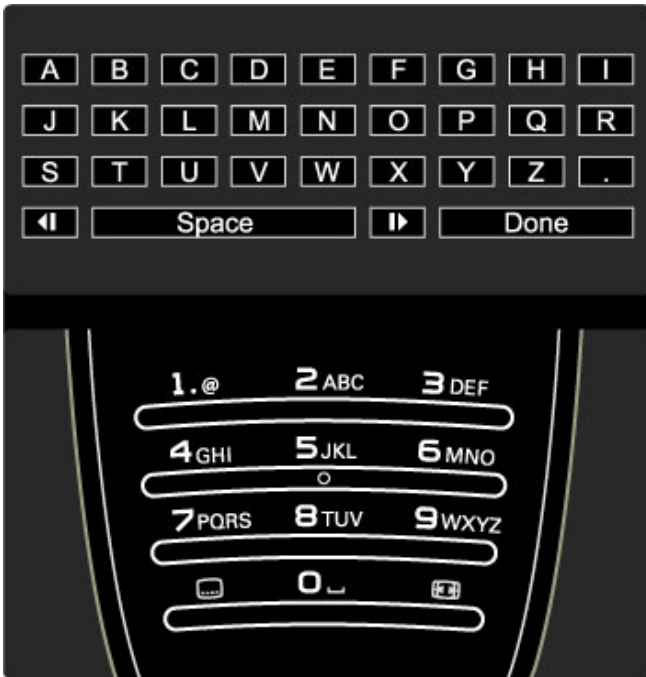

Enter text with the remote control keypad

Use the navigation keys to position the cursor in the text. Press **↶** (Back) to delete a character.

Use the remote control keypad as you do for SMS/text messaging to enter a character. Use the **1** key to select a special character. Select **Clear** to delete a character.

Select **Done** to end Rename.

Enter text with the on-screen keyboard

To open the on-screen keyboard on top of the text entry menu, press **OK** when the cursor in the text flashes.

On the keyboard, use the navigation keys to highlight a character and press **OK** to enter it. To delete a character, press **↶** (Back) or highlight **✖** and press **OK**.

To switch from uppercase to lowercase or to a set of special characters, press **▶** (Next) or **◀** (Previous).

To edit a character within a line of text, position the cursor on this character and use the **←** and **→** keys at both ends of the on-screen spacebar.

To close the on-screen keyboard, highlight **Done** and press **OK**.

Favourite channels

In the Channel list you can mark a channel as a favourite. You can set the Channel list to only zap through your list of favourite channels.

To open the **Channel list**, while you are watching TV channels, press **Q** **FIND**.

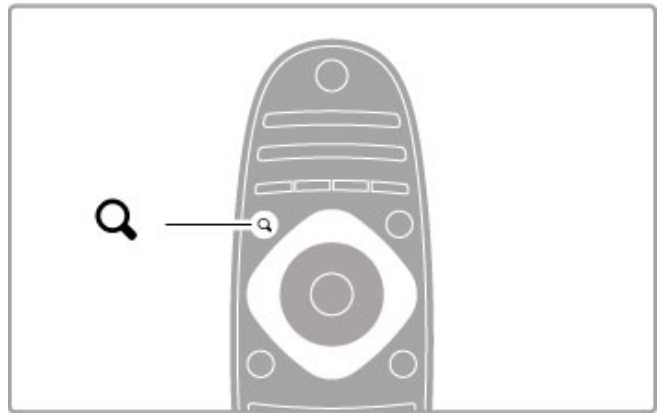

Mark a channel as favourite

While watching TV, press **Q** **FIND** to open the Channel list. Navigate to the channel you want to mark as favourite and press **≡** **OPTIONS**. Select **Mark as favourite**.

In the Channel list, the favourite channel is marked with a **★**. You can unmark a favourite channel with **Unmark favourite**.

Channel list of favourites

You can set the Channel list to only flick through your favourite channels.

With the list on screen, press **≡** **OPTIONS** and select **Select list**. Select **Favourites** from the list and press **OK**. With this list selected, you will only flick through your favourites.

Programme guide

If programme guide information is available in your area, you can open an on-screen programme guide with scheduled TV programmes.

The Programme guide is provided by the broadcaster or Net TV.



Open the Programme guide

While watching TV, press **🏠**, select **Programme guide** and press **OK**.

To quit the Programme guide without changing a setting, press **↶** (Back).

First use

The first time you open the Programme guide, the TV scans all TV channels for programme guide information. This can take several minutes. The data is stored in the TV. The TV can store programme data for up to eight days.

Programme guide options

With a programme selected in the guide, press **≡** **OPTIONS** to select the following:

- **Set reminder**

To set an on-screen reminder for when a programme is due to start, select **Set reminder** and press **OK**. The programme is marked with a **🕒** (Clock). To cancel this reminder, select **Clear reminder** and press **OK**.

- **Change day**

View the previous or next day's programmes.

- **More info**

Shows the programme details and summary.

- **Search by genre**

View all programmes selected by genre.

- **Scheduled reminders**

If a reminder is set, you can view a list of all scheduled reminders.

- **Update programme guide**

After the first scan, the TV stores the programme guide data. If you update or reinstall channels or reorder the Channel list, you will need to update the Programme guide.

To update, select **Update programme guide**. Reminders are cleared.

Broadcaster or Network

To select where the Programme guide information comes from, press **🏠** > **Setup** > **TV settings** > **Preferences** > **Programme guide**.

Select **From the network** or **From the broadcaster**.

From the network

Until you link up with Net TV, programme guide information comes from the broadcaster. Once you are connected with Net TV, the TV switches automatically to the Internet for programme guide information.

From the broadcaster

Guide information comes from the broadcaster/operator.

Smart picture and sound settings

For easy picture or sound adjustment, you can select a preset setting for each.

While watching TV, press **≡** **ADJUST** to open the Adjust menu and select **Smart picture** or **Smart sound**. Make a selection from the list and press **OK**.

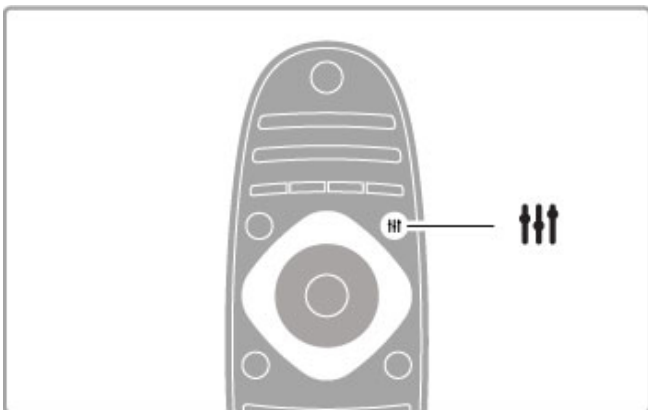

Smart picture and Smart sound

Smart settings are a combination of preset settings suited to a specific use such as gaming or daylight viewing.

You can adjust a specific setting, like Brightness or Contrast, Bass or Treble, of a chosen smart setting. The smart setting will remember the adjustments you made.

Adjust smart settings

To adjust a specific setting of a smart setting, select the smart setting and press **OK**. Then press **🏠** and select **Setup**. Select **TV settings**, navigate to the individual setting and adjust it.

To return to the original smart setting values, undo the adjustments you made by first setting the TV in the smart setting you want to reset. Then press **🏠** > **Setup** > **TV settings**, select **Reset** and press **OK**.

Read more about adjusting separate settings in **Help** > **Setup** > **Picture, Sound and Ambilight**.

Smart picture list

- **Personal** - Your choices made in Personalise picture and sound
- **Vivid** - Ideal for daylight viewing
- **Natural** - Natural picture settings
- **Cinema** - Ideal for watching movies
- **Game** - Ideal for gaming
- **Energy saving** - Energy-conscious settings

- **Standard** - Factory standard settings
- **Photo** - Ideal for viewing photos
- **Custom** - A smart picture setting free for any setting you wish

Smart sound list

- **Personal** - Your personal choices made in Personalise picture and sound
- **Standard** - Factory standard
- **News** - Ideal for speech
- **Movie** - Ideal for watching movies
- **Game** - Ideal for gaming
- **Drama** - Ideal for TV soaps
- **Sports** - Ideal for sports programmes

Picture format

If black bars appear on the screen, you can adjust the picture format to a format that fills the screen.

While watching TV, press **≡** **ADJUST** to open the Adjust menu and select **Picture format**. Select a format from the list and press **OK**.

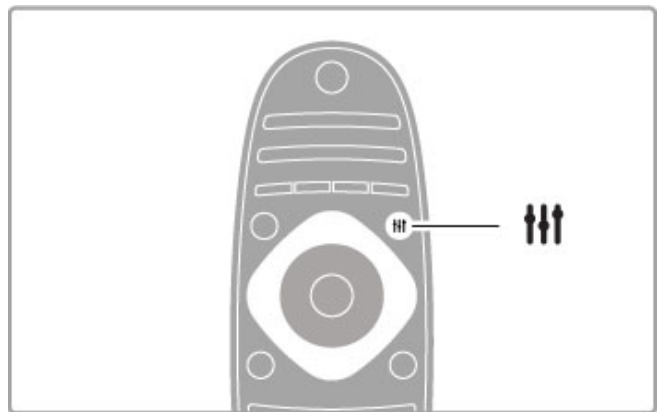

Picture formats

The following formats are available according to the picture on screen:

- **Auto fill**
Automatically enlarges the picture to fill the screen. Minimal picture distortion, subtitles remain visible. Not suitable for PC input.

- **Auto zoom**

Automatically zooms the picture in to fill the screen as much as possible without distortion. Black bars may be visible. Not suitable for PC input.

- **Super zoom**

Removes the black bars on the side of 4:3 broadcasts. The picture is adjusted to fit the screen.

- **Movie expand**

Scales the picture to a 16:9 format.

- **Wide screen**

Stretches the picture to a 16:9 format.

- **Unscaled**

Expert mode for HD or PC input. Pixel for pixel display. Black bars may appear with pictures from a PC.

Switch to standby

If the TV is on, press  on the remote control to switch to standby. The red standby key indicator is on. Although the TV consumes very little power when on standby, energy does continue to be consumed.

When you do not use the TV for an extended period of time, switch the TV off completely with the power switch.

Auto switch off

If you use the TV as a monitor or use a digital receiver to watch TV (a set top box - STB) and you do not use the remote control of the TV, switch off the automatic switch off.

This will prevent the TV from switching off automatically after a 4-hour period without a key press on the remote control of the TV.

To switch off the automatic switch off, press the **green** key while you are watching TV channels and select **Auto switch off** and select **Off**.

2.4 Watch 3D

What you need

This TV is prepared for the 3D Full HD accessory PTA02 (sold separately).

PTA02 Installation

- 1 Switch off the TV.
- 2 Connect the 3D transmitter to the 3D connection **3D Out** on the back of the TV.

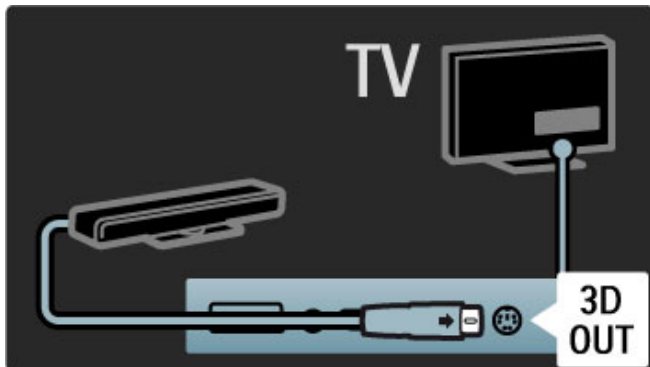

- 3 Install the 3D transmitter on the top or at the bottom of the TV. Make sure to point the transmitter directly to where you sit to watch TV.

The small window in the middle of the glasses receives the 3D signals from the transmitter.

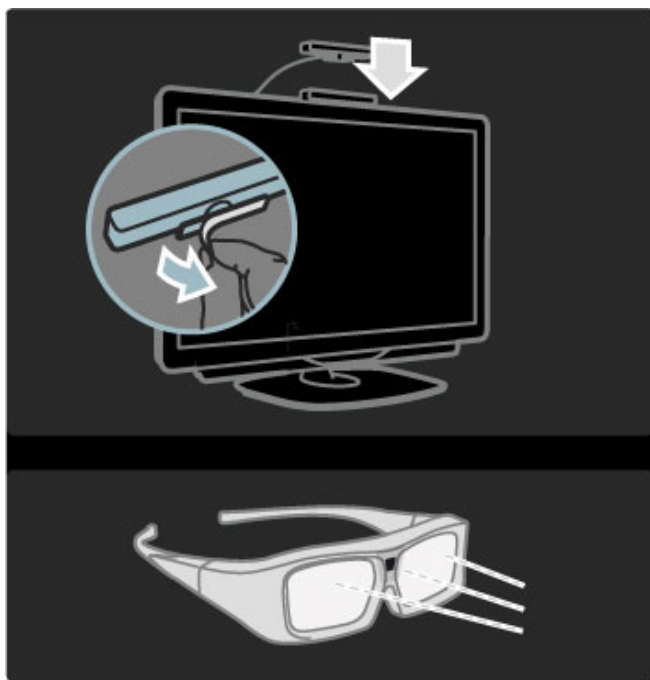

Update the TV software

To prepare your TV for 3D watching, you must update the TV software.

- 1 Switch on the TV.
- 2 Plug in the USB device in the **USB** connection at the side of the TV.

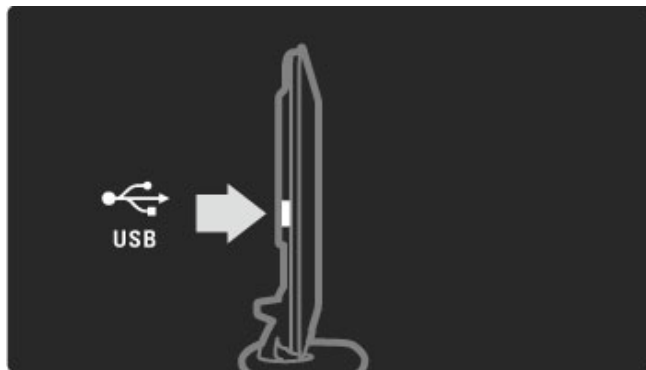

- 3 The software update will start automatically and during the update the TV might switch off and on again. Do not press any key on the remote control and wait until the message 'Operation Successful' appears.

- 4 Unplug the USB device and switch the TV off and back on again.

Your TV is ready to watch 3D.

2.5 Watch satellite

Switch channels

To watch satellite channels, press **⬆** (Home), select **Watch satellite** and press **OK**.



To switch satellite channels, press **CH+** or **CH-** on the remote control. You can use the number keys if you know the channel number or you can use the channel list to select a channel.

To switch back to the previous channel, press **⬅** (Back).

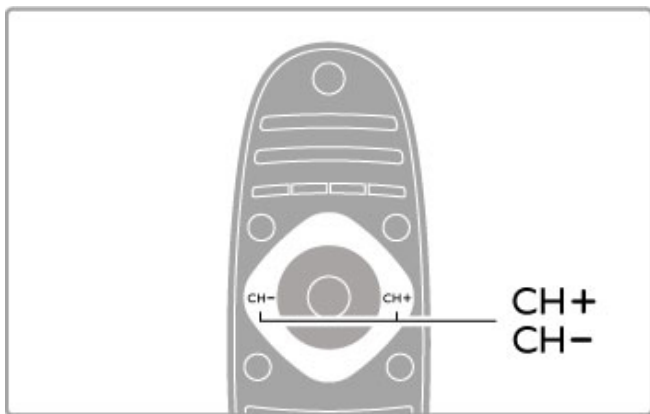

Channel list for satellite

When a satellite installation is completed, the satellite channels are stored in a specific channel list for satellite.

Read more about using the Channel list in **Help > Use your TV > Watch satellite > Channel list**.

Channel list

To open the Channel list, while watching satellite broadcast, press **QFIND**. Select a channel with the navigation keys and press **OK** to switch to the channel.

To leave the Channel list without changing the channel, press **⬅** (Back).

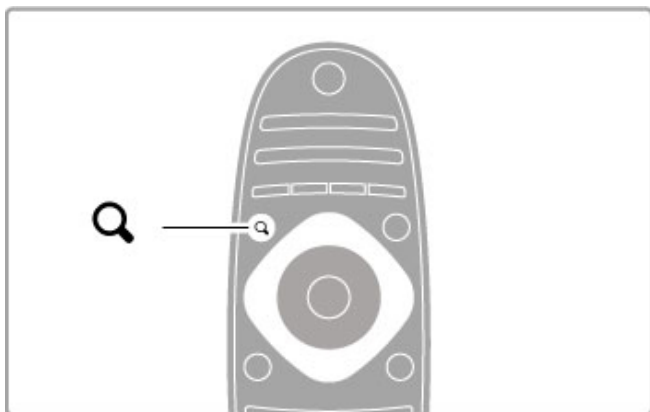

Channel list pages

The Channel list can have several pages. To view the next or previous Channel list page, press **▶** or **◀**.

Options

With the Channel list on screen, press **☰** **OPTIONS** to select :

- TV / Radio
- Select list
- Sort
- Mark as favourite
- Rename
- Reorder
- Channel lock

TV / Radio

Set the list to show TV or radio channels.

Select list

Select the list of channels from all satellites or from one specific satellite. Or show a list of only your favourite satellite channels. The list you select here determines which channels you will flick through with **CH+** and **CH-** while watching satellite.

Sort

You can sort the Channel list by **Name**, **Number** or in groups of free-to-air and scrambled channels – **Free / scrambled**.

Mark as favourite

When a channel is highlighted in the Channel list, you can set it as a favourite channel.

Read **Help > Use your TV > Watch satellite > Favourite channels**.

Reorder

You can reposition channels within the list.

1 Press **☰** **OPTIONS** and select **Reorder** to start reordering channels.

2 Highlight a channel and press **OK**.

3 Reposition the channel where you want it with the navigation keys. Alternatively, enter the new position directly with the number keys.

4 Press **OK** to confirm the position. You can insert the channel or swap it.

You can highlight another channel and do the same.

To stop Reorder, press **☰** **OPTIONS** and select **Exit reorder**.

Rename

You can rename a channel in the Channel list.

1 In the channel list, highlight the channel you want to rename.

2 Press **☰** **OPTIONS** and select **Rename** to start renaming. You can enter text directly with the remote control keypad or open a full keyboard on top of the text entry menu.

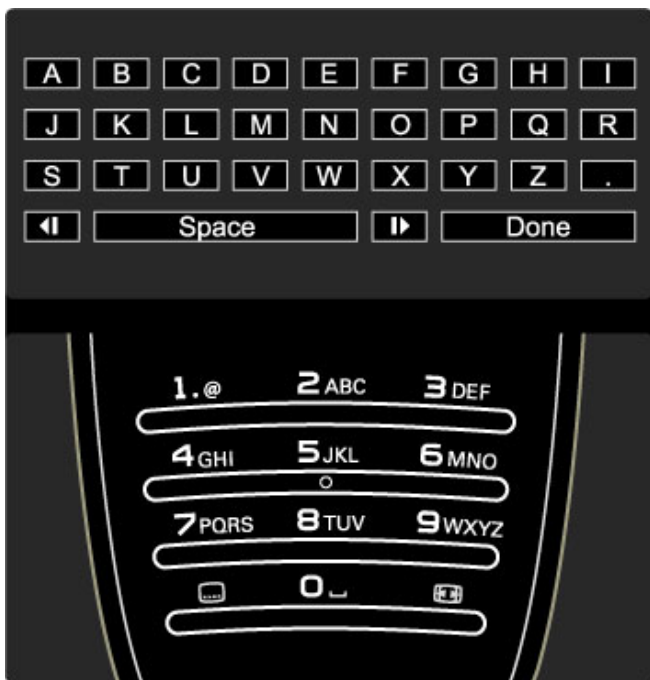

Enter text with the remote control keypad

Use the navigation keys to position the cursor in the text. Press **↶** (Back) to delete a character. Use the remote control keypad as you do for SMS/text messaging to enter a character. Use the **1** key to select a special character. Select **Clear** to delete a character. Select **Done** to end Rename.

Enter text with the on-screen keyboard

To open the on-screen keyboard on top of the text entry menu, press **OK** when the cursor in the text flashes. On the keyboard, use the navigation keys to highlight a character and press **OK** to enter it. To delete a character, press **↶** (Back) or highlight **✕** and press **OK**.

To switch from uppercase to lowercase or to a set of special characters, press **▶** (Next) or **◀** (Previous). To edit a character within a line of text, position the cursor on this character and use the **←** and **→** keys at both ends of the on-screen spacebar. To close the on-screen keyboard, highlight **Done** and press **OK**.

Favourite channels

You can set up your own list of favourite satellite channels.

Use your TV / Watch satellite

Mark as favourite

In the Channel list, navigate to a channel you want to mark as favourite and press **≡** **OPTIONS**. Select **Mark as favourite**. In the list, the favourite channel is marked with a **★**. You can unmark a favourite channel with **Unmark favourite**.

Channel list of favourites

You can set the Channel list to only show your favourite channels.

With the list on screen, press **≡** **OPTIONS** and select **Select list**. Select **Favourites** from the list and press **OK**. With this list selected, you can flick through your favourite channels with **CH+** and **CH-** while watching satellite.

Read more about the options in the Channel list for satellite in **Help > Use your TV > Watch satellite > Channel list**.

Channel lock

To prevent children from watching, you can lock channels. To unlock, you enter the 4-digit child lock code.

Lock channels

You can lock channels in the Channel list. To open the Channel list, press **Q** **FIND**. To lock channels, press **≡** **OPTIONS** and select **Channel lock**.

Enter your 4-digit child lock code. Select any channel in the list, press **≡** again and select **Lock channel**. A locked channel is marked with a **🔒** (Lock). You can select another channel to lock or unlock.

To exit Channel lock, press **≡** and select **Exit**.

Change code

To change the current code, press **🏠** and select **Setup > Channel settings** and select **Child lock > Change code**. Enter the current code and then enter the new code twice. The new code is set.

Forgotten your code?

To override the code in case you forget it, enter **8888**.

Age-rated programmes

To prevent children from watching programmes not suitable for their age, you can set an age rating (a parental rating).

Programmes with an equal or higher rating will be locked. To unlock the programme, you must enter the 4-digit child lock code. Not all programmes are rated. The age rating is set for all satellite channels.

Set an age rating

Press **🏠** and select **Setup > Satellite settings** and select **Parental rating**.

To select an age rating, you must first enter your 4-digit child lock code. If no child lock code is set yet, you can set the code now.

When the code is entered, you can select the age rating. When the rating of a programme is equal or higher than the rating you have set for your child's age, the programme will be locked. The TV will ask for the code to unlock the programme. For some operators, the TV only locks programmes with a higher rating.

Change code

To change the current code, press **🏠** and select **Setup > Channel settings** and select **Child lock > Change code**. Enter the current code and then enter the new code twice. The new code is set.

Forgotten your code?

To override the code in case you forget it, enter **8888**.

2.6 Watch a connected device

Select a device

Add a connected device to the Home menu for easy selection later on.

Read more about Add your devices in [Help > Use your TV > Menus > Home menu](#).

Select from the Home menu

To select and watch a connected device or activity, press  to open the **Home menu** and select the device or its activity and press **OK**. Make sure the device is switched on.

Select from the list of connections



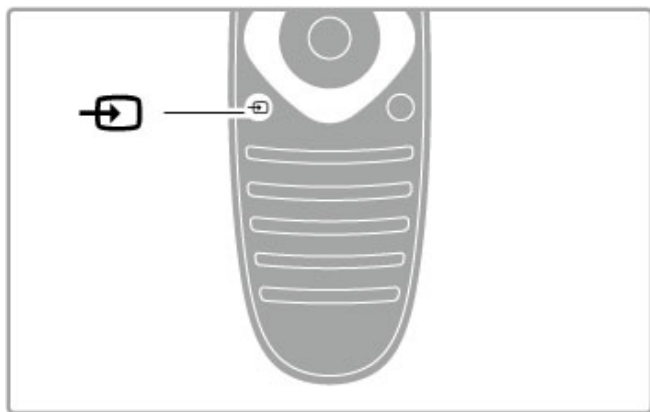

To open the list of connections, press  **SOURCE**. Select the TV connection and press **OK** to switch to the device on that connection. Make sure the device is switched on.



Operate devices

The remote control of the TV can also operate a connected device. The device must have EasyLink (HDMI-CEC) and have it switched on. The device must also be connected with an HDMI cable.

Operate an EasyLink device

To operate such a device with the TV remote control, select the device -or its activity- in the  Home menu and press **OK**. The commands of all keys, except the  key, the  **ADJUST** key and the  **OPTIONS** key, are forwarded to the device.

If the key you need is not on the TV remote control, you can show extra keys on screen with Show device keys.

Show device keys

To show the device keys on screen, press  **OPTIONS** and select **Show device keys**. Select the key you need and press **OK**.

To hide the device keys, press  (Back).

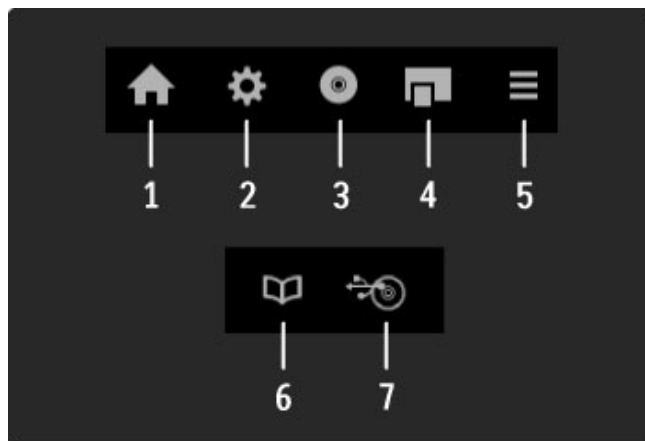

In general, these keys open the following device menus:

- 1 Home menu
- 2 Setup menu
- 3 Disc menu (disc content)
- 4 Pop-up menu
- 5 Options menu
- 6 Programme guide
- 7 Media selection

Read more about EasyLink in [Help > Setup > Devices > EasyLink HDMI-CEC](#).

2.7 Subtitles and languages

Subtitles

Programme subtitles are available most of the time. You can switch subtitles on or off. How to set subtitles depends on whether a channel is analogue or digital.

Switch on subtitles

To open the Subtitle menu, press **SUBTITLE**. You can switch subtitles **On** or **Off**. Select **On during mute** to show subtitles only when the sound is muted with .

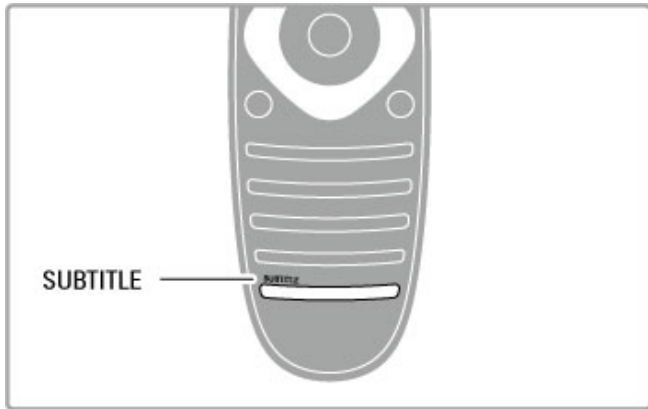



For analogue channels

To make subtitles available for a channel, switch to the channel and press **TEXT** to open Text. Enter the page number for subtitles, usually 888, and press **TEXT** again to close Text. With subtitles switched on in the Subtitle menu, subtitles will be shown if available. Each analogue channel must be set up separately.

For digital channels

There is no need to activate subtitles in Text for digital channels. You can set a preferred primary and secondary subtitle language. If these subtitle languages are not available for a channel, you can select another available subtitle language.

To set the primary and secondary subtitle language, press  and select **Setup > Channel settings** and select **Languages > Primary** and **Secondary subtitles**.

To select a subtitle language when none of your preferred languages is shown, press  **OPTIONS**, select **Subtitle language** and select a language you want temporarily.

Audio languages

Digital TV channels can broadcast audio that transmits several languages for a programme. You can set the TV to switch to your preferred language if it is available.

Set your language

To set your preferred audio language, press  and select **Setup > Channel settings** and select **Languages > Primary** and **Secondary audio**. The TV will automatically switch to one of your languages, if one of them is available.

To check if an audio language is available, press  **OPTIONS** and select **Audio language**. You can select another audio language from the list.

Some digital TV channels broadcast special audio and subtitles adapted for people who are hearing or visually impaired. Read **Help > Setup > Universal access**.

3 More TV

3.1 Net TV

What is Net TV?

Net TV offers Internet applications called apps. These apps are tailored for your TV. With these apps you can read your national newspaper, look at infotainment, or rent a movie from a video store or watch programmes you missed with catch-up TV apps. A wide range of Net TV apps are available depending on your country.



Net TV specifics

- The availability of Net TV apps vary per country.
- With Net TV, you can view any Internet website you like but most of them are not tailored for a TV screen and some plug-ins (e.g. to view pages or videos) are not available on your TV.
- Net TV apps can be added, changed or stopped.
- Net TV shows one page at a time and full screen.
- You cannot download and save files or install plug-ins.

Net TV forum website

Find out more on Net TV apps at the Net TV forum website.
www.supportforum.philips.com

Koninklijke Philips Electronics N.V. bears no responsibility regarding the content and the quality of the content provided by the content service providers.

What you need

To enjoy Net TV you must connect the TV to a router with a high-speed (broadband) connection the Internet. You can use a home network connected to the Internet. You do not need a computer.

Read more about connecting to your home network in **Help > Setup > Network**.

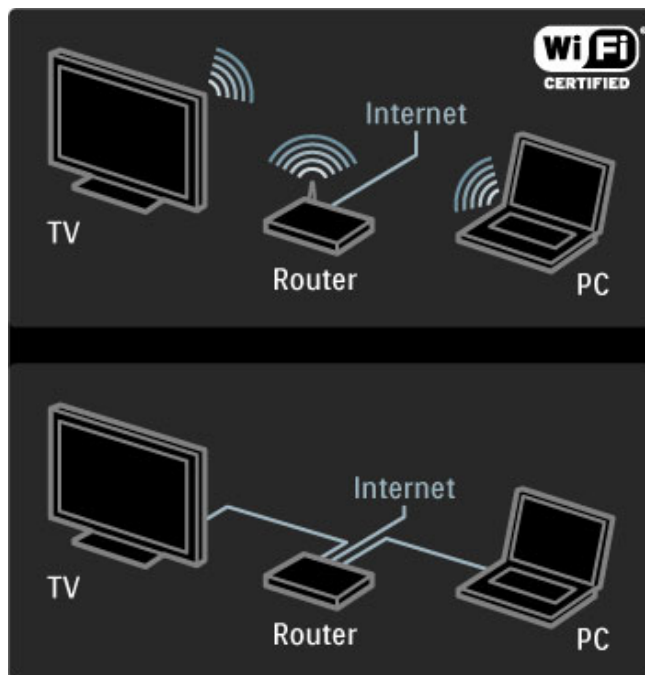

Configure

The first time you open Net TV, you must agree to the terms and conditions before you can continue. Press **OK** to agree. Press **↶** (Back) to quit Net TV.

Register

If you agree, you can register with Club Philips. Select **Register** and press **OK**. Enter your email address, select **Continue** and press **OK**. Confirm the email address.

Parental control

To lock Adult 18+ rated apps, switch on Net TV parental control by selecting **Enable** and then press **OK**. Enter an unlock PIN code of your choice. Confirm your PIN code. Adult 18+ rated apps are now locked.

To open a locked app, select the app and press **OK**. The TV will ask you to enter your 4-digit code.

Clear Net TV memory

To redo the Net TV configuration and to clear all passwords, PIN codes, history and cookies, press **⌂** (Home), select **Setup > Network settings > Clear Net TV memory**.

Net TV apps

Open Net TV

To open Net TV, press **⌂** (Home), select **Browse Net TV** and press **OK**.

To close Net TV, press **⌂** (Home) and select another TV activity.

The Net TV home page

When you open Net TV, the home page is shown.

To navigate the page, press **▲**, **▼**, **◀** or **▶**.

To open an app, select the app and press **OK**.

To go back 1 step, press **↶** (Back).

The home page

- 1 The App Gallery
- 2 Your Apps
- 3 The Internet App
- 4 Current TV channel



The App Gallery

To look for apps to add to your home page, select **App Gallery** and press **OK**.

To add an app to the home page, select an app in the list and press **Add**.

To search per category, select the category field (**All**) and press **OK**.

To open the on-screen keyboard, select a text entry field and press **OK**.

To switch to the app gallery of another country, select the country field and press **OK**.

Lock or remove an app

To lock or remove an app, select the app and press **≡ OPTIONS**. Select the option and press **OK**.

Reload an app or page

To retry loading an app or an Internet page, press **≡ OPTIONS** and select **Reload page**.

Security info

To view the level of security of the page you're on, press **≡ OPTIONS** and select **Security info**.

Internet websites

To browse Internet websites, select the **Internet** app on the Net TV home page and press **OK**.

To open the on-screen keyboard, select a text entry field and press **OK**.

To remove a visited website from the list, press **≡ OPTIONS** and select **Remove from History**.

Video stores

With the video store apps in Net TV, you can rent your favourite movie from an online rental video store. You can pay securely with your credit card.

1 Open a video store app.

2 Select a video.

3 Make the online payment.

4 Download the video.

5 Start watching.

What you need

To rent and download a video, you need a high-speed (broadband) Internet connection to the TV. You also need an SD memory card.

Read more about connecting to the network in **Help > Setup > Network**.

Video memory

To download a video, you must format an SD memory card as video memory. Insert the SD card into the SD card slot on the side of the TV. The TV starts formatting the SD card automatically. The SD card may be rejected if the write speed is insufficient for video transfer. Once formatted, leave the card permanently in the slot.

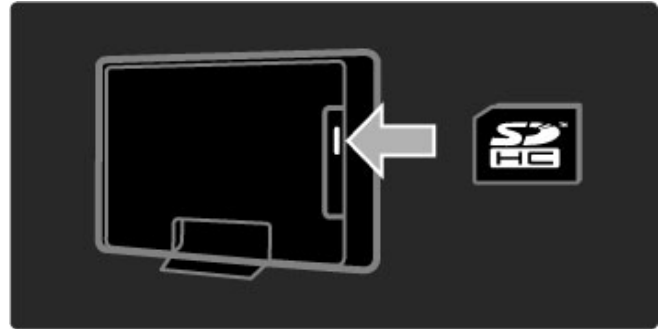

SD memory card size

Use a SD HC (High Capacity) memory card with at least 4GB of storage capacity.

For high-definition (HD) video, use an SD card with at least 8GB of storage capacity. Use a speed class 2 card or more.

Open a video store app

To open a video store, press **⬆** (Home), select **Net TV** and press **OK**. Select a video store app from the Net TV home page. Select the video store and press **OK**. You can add a video store app on your home page from the app gallery. Availability of video stores varies by country.

Rent a video

When you open a video store you will be asked to log in or to create a log in account. With a text entry field selected, press **OK** to open the on-screen keyboard.

Consult the video store website for more information.

Online TV

With the online TV apps in Net TV you can watch programmes you missed. Most often, you can recognise such an online TV app by its broadcaster's logo.

What you need

To watch online TV programmes, you need a high-speed (broadband) Internet connection to the TV.

Read more about connecting to the network in **Help > Setup > Network**.

Watch online TV

To watch an online TV programme in Net TV, press **⬆** (Home), select **Browse Net TV** and press **OK**. Select the broadcaster app on the Net TV home page and press **OK**. You can add an online TV broadcaster app on your home page from the app gallery.

Start a programme

Select a programme from the online TV app page and press **OK**. Most often, you can use the **▶** (Play) or **⏸** (Pause) keys on your remote control.

3.2 Interactive TV

What is iTV?

Interactive TV can offer additional infotainment or programmes on a digital TV channel. Interactive TV is dependent on the country or broadcast. Benefits range from enhanced text to online TV and much more.

For some iTV services, you need a high-speed connection to the Internet. Read **Help > Setup > Network**.

Use iTV

To open iTV, press the **Red** key while watching a digital channel. If interactive TV is available, the Home page of the broadcaster opens.

To close iTV, press **↶** (Back) repeatedly until the iTV page closes.

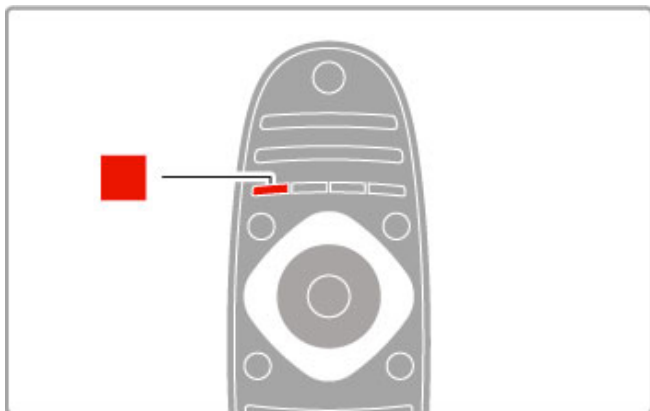

3.3 Text

Text pages

Open Text

To access Text while you are watching TV channels, press **TEXT**.

To close Text, press **TEXT** again.

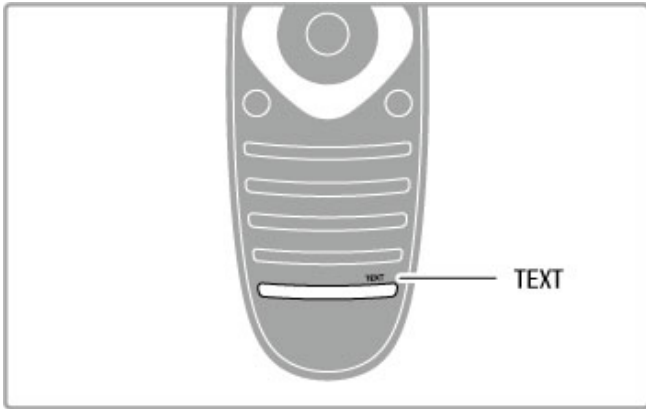

Select a Text page

To select a page ...

- Enter the page number with the number keys.
- Press **▶** or **◀**
- Press **▲** or **▼**.
- Press a colour key to select a colour-coded subject at the bottom of the screen.

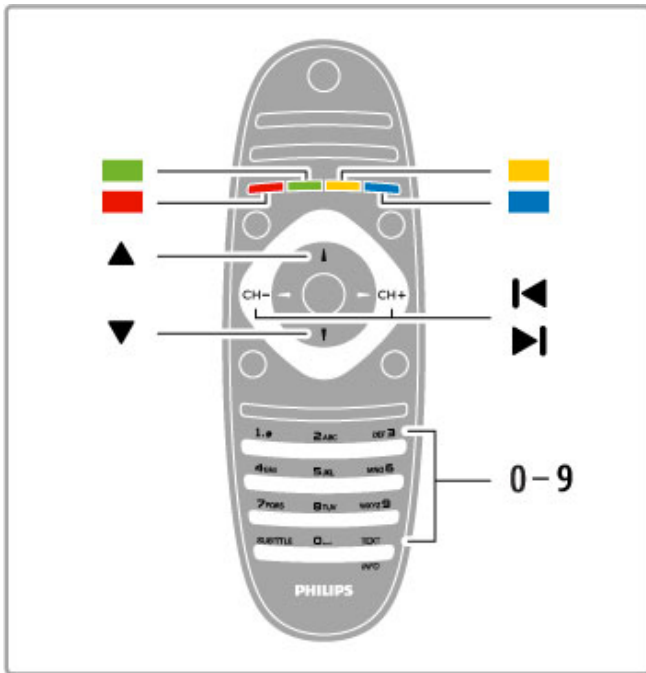

Text sub-pages

A Text page number can hold several subpages. The subpage numbers are shown on a bar next to the main page number.

To select a subpage, press **◀** or **▶**.

T.O.P. Text pages

Some broadcasters offer T.O.P. Text.

To open T.O.P. Text pages within Text, press **≡** **OPTIONS** and select **T.O.P. overview**.

Search Text

You can select a word and scan Text for all occurrences of this word.

More TV / Text

Open a Text page and press **OK**. Select a word or number with the navigation keys. Now press **OK** again to jump immediately to the next occurrence of this word or number. Press **OK** again to jump to the subsequent occurrence.

To stop the search, press **▲** until nothing is selected.

Text from a connected device

Some connected devices that receive TV channels can also offer Text.

To open Text from a connected device, press **⬆**, select the device and press **OK**. While watching a channel on the device, press **≡** **OPTIONS**, select **Show device keys** and select the **≡** key and press **OK**. Press **↶** (Back) to hide the device keys. To close Text, press **↶** (Back) again.

Digital Text (UK only)

Some digital TV broadcasters offer dedicated Digital Text or interactive TV on their digital TV channels. This includes normal Text using the number, colour and navigation keys to select and navigate.

To close Digital Text, press **↶** (Back).

Text options

In Text, press **≡** **OPTIONS** to select the following:

- Freeze page
- Dual screen
- T.O.P. overview
- Enlarge
- Reveal
- Cycle subpages
- Language

Freeze page

To stop the automatic rotation of subpages, press **≡** **OPTIONS** and select **Freeze page**.

Dual screen / Full screen

To show the TV channel and Text alongside each other, press **≡** **OPTIONS** and select **Dual screen**. Select **Full screen** to switch back to full screen view.

T.O.P. overview

To open T.O.P. Text, press **≡** **OPTIONS** and select **T.O.P. overview**.

Enlarge

To enlarge the Text page for more comfortable reading, press **≡** **OPTIONS** and select **Enlarge**. To scroll down the page, press **▼** or **▲**.

Reveal

To unhide hidden information on a page, press **≡** **OPTIONS** and select **Reveal**.

Cycle subpages

To cycle subpages when these are available, press **≡** **OPTIONS** and select **Cycle subpages**.

Language

To switch the group of characters that Text uses to display correctly, press **≡** **OPTIONS** and select **Language**.

Text setup

Text language

Some digital TV broadcasters have several Text languages available.

To set your primary and secondary Text language, press **🏠** > **Set up** > **Channel settings** and select **Primary** or **Secondary Text** and select your preferred Text languages.

Text 2.5

If available, Text 2.5 offers more colours and better graphics. Text 2.5 is activated as a standard factory setting.

To switch it off, select **🏠** > **Setup** > **TV settings** > **Preferences** > **Text 2.5**.

3.4 Videos, photos and music

Browse USB

You can view photos or play your music and videos from a USB memory device.

Insert a USB device into the USB connection on the left-hand side of the TV while the TV is switched on. The TV detects the device and opens a list showing its content. If the list does not appear automatically, press **⬆️**, select **Browse USB** and press **OK**.

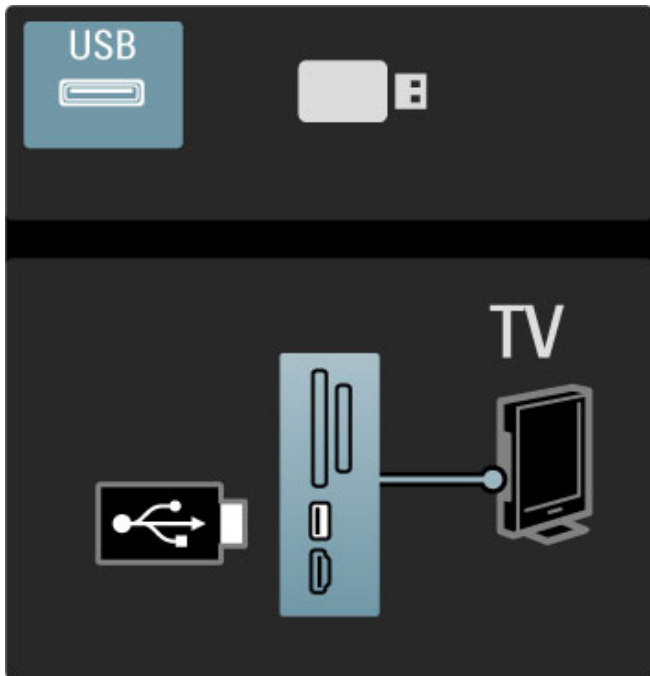

To close Browse USB, press **⬆️** and select another activity or disconnect the USB device.

View photos

To view photos, select a photo in the list and press **OK**. If there are more photos in the folder, the TV starts a slideshow with these photos.

To stop, press **☰ OPTIONS** and select **Stop**.

To pause or play the slideshow again, press **OK**.

To view the next photo, press **▶️**.

To view the previous photo, press **◀️**.

Options for photos

Press **☰ OPTIONS** to select the following:

- Show info
- Stop
- Play once / Repeat
- Rotate
- Shuffle on / off
- Slideshow speed
- Slideshow transition
- Set as Scenea

Shuffle on

Plays the files randomly.

Set as Scenea

Sets the current photo as a wallpaper photo for Scenea.

Play videos or music

To play videos or music, select the file in the list and press **OK**. If there are more music or video files in the folder, the TV plays the files one after the other. To stop, press **☰ OPTIONS**.

To pause or play, press **OK**.

To play the next file in the folder, press **▶️**.

To play to the previous file, press **◀️**.

To fast forward, press **▶️**.

To rewind, press **◀️**.

Options for music and videos

Press **☰ OPTIONS** to select the following:

- Stop
- Play once / Repeat
- Shuffle on / off

Music with photos

You can play music and show photos at the same time. Start the photo slideshow after you started the music.

1 Select a folder with music files and press **OK**.

2 Select a folder with photo files and press **OK**.

To stop, press **☰ OPTIONS** and select **Stop**.

Mute screen

If you only listen to music, you can mute the TV screen to save energy.

To mute the screen, press the **green** key, select **Mute screen** and press **OK**. To switch the screen back on, press any key on the remote control.

See the list of compatible playback formats in **Help > Specifications > Multimedia**.

Browse PC

You can view photos or play your music and videos from a PC in your home network.

The TV is DLNA certified and is compatible with other DLNA certified devices.

What you need

To browse your PC files, you need to connect the TV to your home network. Also, do not forget to set your media server software to share the files with the TV.

Browse PC

To browse your PC files, press **⬆️**, select **Browse PC** and press **OK**.

To close Browse PC, press **⬆️** and select another activity.

If the network is not yet installed when you select Browse PC, the Network installation starts automatically. Follow the instructions on screen.

To select, view and play your files, read **Help > More TV > Videos, photos and music > Browse USB**.

Find the list of compatible playback formats and compatible media server software in **Help > Specifications > Multimedia**.

Read more about connecting to a network in **Help > Setup > Network**.

Scenea

With Scenea, you can set a photo as a painting on your TV screen. Select your favourite photo from your collection.

To open Scenea, press **⬆️**, select **Scenea** and press **OK**. If you did not yet select a photo of your own, a preset photo is shown. To close the Scenea photo, press a key on the remote control.



Select a photo for Scenea

- 1 Select a photo from a connected USB device or from a connected PC. This photo must be in JPEG format.
- 2 With the photo highlighted in the Browse USB or Browse PC list, press **≡** **OPTIONS**, select **Set as Scenea** and press **OK**. By agreeing to overwrite the current photo, the new photo is set.

Scenea lounge light

To switch off Ambilight when Scenea is on, press **≡** **ADJUST**. Or press **Ambilight** on the front of the TV.

Energy saving

To switch the TV to the energy saving mode, press **≡** **ADJUST**, select **Smart picture** and press **OK**. Select **Energy saving**.

Specifics

With Scenea switched on, the TV will automatically switch to standby after 4 hours. You will be warned 1 minute before switch off. This automatic switch to standby prevents unnecessary energy use in case you forget that Scenea is on.

If the sleep timer is set, the TV will also switch to standby after the set time has elapsed.
Scenea has no sound.

Wi-Fi Media Connect

With Wi-Fi MediaConnect you can bring up (project) your PC screen on to the TV screen wirelessly. You can project video, music, presentations or other content playing on your laptop or desktop PC.

Before you can project the PC screen on to TV, you must install the Wi-Fi MediaConnect software on your PC.
Read more about installing the Wi-Fi MediaConnect software in **Help > Setup > Network > Wi-Fi MediaConnect**.

Start projecting

To start projecting the PC screen on to the TV, click on the small TV icon in the taskbar at the bottom right of the PC screen. Your PC screen appears on your TV screen.

Stop projecting

To stop projecting, click on the TV icon again.

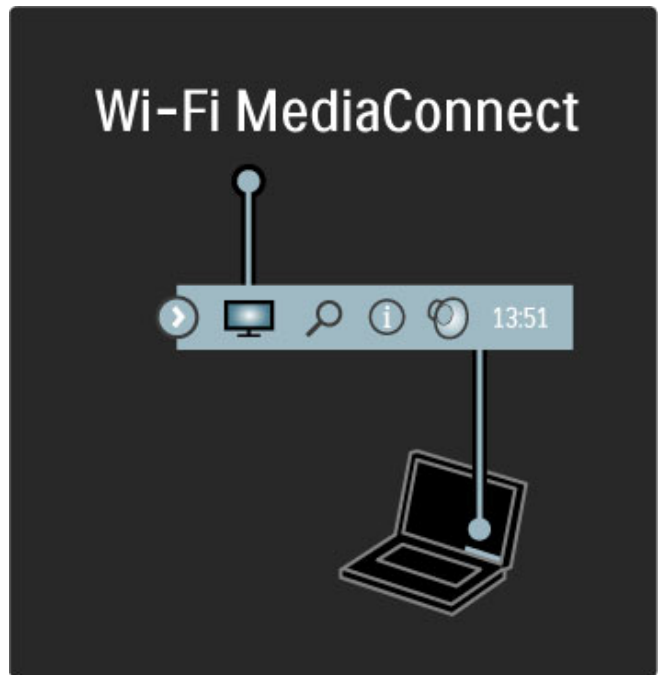

Wi-Fi MediaConnect Help

To read the Wi-Fi MediaConnect Help, right-click the TV icon in the taskbar of the PC and select **Help**.

Specifics

The playback of video can be affected by your PC performance and your wireless network bandwidth.

You can project high definition (HD) or standard definition (SD) video, depending on the processing power of your PC.
The content protection on most DVD or Blu-ray Disc movies might restrict watching the movie on a TV when the disc is playing on a PC.
The TV shows PC media files with a small delay.

3.5 Games

Play a game

Add a game console

In the Home menu, start Add your devices to add the console to the Home menu for easy selection later on. When adding a game console to the Home menu, select **Game** when the TV asks for the device type. If your game console is an EasyLink HDMI-CEC device it might add itself to the Home menu.



Smart setting - Game

The Smart picture setting **Game** sets the TV to the ideal Game settings without picture lag.

If your game console is added as **Game** in the Home menu, the TV switches to the **Game** setting automatically.

If your game console has added itself in the Home menu as a **Blu-ray Disc player** or **DVD player**, you need to switch the Smart picture setting to **Game** before you start playing.

To switch the Smart picture setting to **Game**, press **ADJUST** and select **Smart picture > Game** and press **OK**. The TV is ready for gaming. Do not forget to switch back to your normal Smart picture setting when you stop gaming.

Read more about how to connect a game console in **Help > Connections > Connect more devices > Game** or **HD Game**.

3.6 Locks and timers

Child locks

To prevent children from watching a channel or a programme, you can lock channels or lock age-rated programmes.

Parental rating

Some digital broadcasters have rated their programmes. When the rating is equal or higher than the rating you have set for your child's age, the programme will be locked.

To watch a locked programme you must enter the child lock code. The parental age rating is set for all channels.

Set an age rating

Press **⬆** and select **Setup > Channel settings** and select **Child lock > Parental rating**.

To select an age rating, you must first enter your 4-digit child lock code. If no child lock code is set, you can set the code now.

When the code is entered, you can select the age rating. When the rating of a programme is equal or higher than the rating you have set for your child's age, the programme will be locked. The TV will ask for the code to unlock the programme. For some operators, the TV only locks programmes with a higher rating.

Lock a channel

To lock a channel, press **⬆** and select **Setup > Channel settings** and select **Child lock > Channel lock**. In the list of channel numbers, select a channel and press **OK** to lock a channel.

In the list, a locked channel is marked with an **X**. Now, you can select another channel to lock or unlock. The lock is activated as soon as you close the menu.

You cannot lock programmes from connected devices.

Change code

To change the current lock code, press **⬆** and select **Setup > Channel settings** and select **Child lock > Change code**. Enter the current code and then enter the new code twice. The new code is set.

Forgotten your code?

To override the code if you forget it, enter **8888**.

Sleep timer

With the sleep timer, you can set the TV to switch to standby automatically after a specified time.

To set the sleep timer, press **⬆ > Setup > TV settings > Preferences > Sleep timer**. With the slider bar you can set the time up to 180 minutes in increments of 5 minutes. If set to 0 minutes, the sleep timer is switched off.

You can always switch off your TV earlier or reset the time during the countdown.

4 Setup

4.1 Picture and sound

Smart settings

If you select a Smart setting in the ADJUST menu, you can again change the settings of the selected Smart setting with the Picture and sound settings in Setup. The Smart setting remembers your changes.

Reset a Smart setting

To reset a Smart setting to its original values, select the Smart setting you want to reset in the ADJUST menu. Then press **⬆** > **Setup** > **TV settings**, select **Reset**, press **OK** and confirm.

Read more about using Smart picture and sound settings in **Help** > **Use your TV** > **Watch TV** > **Smart picture and sound settings**.

Picture

In the Picture menu, you can adjust all picture settings individually.

To open the Picture settings, press **⬆** > **Setup** > **TV settings** > **Picture**.

- **Contrast**

Sets the contrast level of the picture.

- **Brightness**

Sets the brightness level of the picture.

- **Colour**

Sets the level of colour saturation.

- **Hue**

If NTSC is broadcast, hue compensates the colour variations.

- **Sharpness**

Sets the level of sharpness of fine detail.

- **Noise reduction**

Filters out and reduces the image noise in the picture.

- **Tint**

Sets the colours to **Normal**, **Warm** (reddish) or **Cool** (bluish).

Select **Custom** to set up your own personal settings in the Custom menu.

- **Custom tint**

Use the slider bar to set the colour temperature of the picture.

- **Perfect Pixel HD**

Controls the advanced settings of the Perfect Pixel HD Engine.

— **Perfect Natural Motion** removes motion judder and reproduces smooth movement, especially in movies.

— **LED 400 Hz Clear LCD** gives a superior motion sharpness, better black level, high contrast with a flicker-free, quiet image and a larger viewing angle.

— **Super resolution** enables superior sharpness, especially on lines and contours in the picture.

— **Perfect contrast** sets the level at which the TV automatically enhances the details in the dark, middle and light areas of the picture.

— **Dynamic backlight** sets the level at which power consumption can be reduced by dimming the brightness intensity of the screen. Choose for the best power consumption or for the picture with the best brightness intensity.

— **MPEG artefact reduction** smooths the digital transitions in the picture.

— **Colour enhancement** makes the colours more vivid and improves the resolution of details in bright colours.

— **Gamma** is a non-linear setting for picture luminance and contrast. Use the slider bar to set a higher or lower gamma value.

- **PC mode**

Sets the TV to the ideal pre-defined computer setting if a computer has been connected.

- **Light sensor**

Adjusts the picture and Ambilight settings automatically to the lighting conditions of the room.

- **Picture format**

Read **Help** > **Use your TV** > **Watch TV** > **Picture format**.

- **Screen edges**

Slightly enlarge the picture to hide distorted edges.

- **Picture shift**

Move the picture up / down or left / right with the cursor keys.

Sound

In the Sound menu, you can adjust all sound settings individually.

To open Sound settings, press **⬆** > **Setup** > **TV settings** > **Sound**.

- **Bass**

Sets the level of low tones in the sound.

- **Treble**

Sets the level of high tones in the sound.

- **Surround**

Sets the surround sound effect from internal speakers.

- **Headphones volume**

Sets the volume for the headphone connection of the TV.

- **Auto volume levelling**

Reduces sudden volume differences like at the beginning of adverts or when switching from one channel to another.

- **Balance**

Sets the balance of the left and right speakers to best fit your listening position.

Eco settings

Eco settings bundle the TV settings that help the environment.

While you are watching TV channels, press the **Green** key to open **Eco settings**. Active settings are marked with a . Press again to close.

Energy saving

This Smart picture setting sets the picture, together with Ambilight, in the most ideal energy conscious setting. To switch on, select **Energy saving** in Eco settings and press **OK**. To switch off Energy saving, select another Smart picture setting.

Screen off

If you only listen to music, you can switch off the TV screen to save energy. Select **Screen off** and press **OK**. To switch the screen back on, press any key on the remote control.

Light sensor

The built-in light sensor automatically adjusts the picture, together with Ambilight, to the lighting conditions of the room. To switch on, select **Light sensor** and press **OK**. To switch off, press **OK** again.

Auto switch off

If no keys on the TV remote control were pressed during a 4-hour period, the TV switches off automatically to save energy. You can switch off this **Auto switch off**.

If you use the TV as a monitor or use a digital receiver to watch TV (a set top box - STB) and you do not use the remote control of the TV, switch off the automatic switch off.

4.2 Ambilight

Placement

For the best Ambilight effect :

- Dim the lighting conditions in the room and position the TV up to 25 cm away from the wall.
- Adjust Ambilight according to the colour of your wall at home in the Wall colour setting.
- To prevent poor infrared remote control reception, position your devices out of sight of Ambilight.



Adjust

To open the Adjust menu, press **||||ADJUST**.

To close, press **||||** again.

Switch Ambilight on or off

In the Adjust menu, select **Ambilight** and press **OK**. Switch Ambilight **On** or **Off**. You can also press Ambilight on the TV.

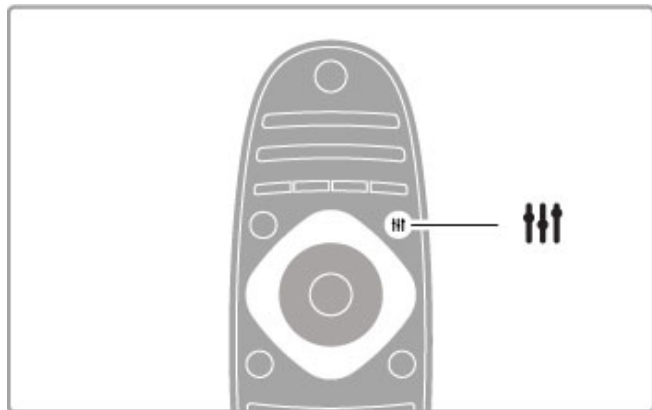

Ambilight dynamic

In the Adjust menu, select **Ambilight dynamic** and press **OK**. Adjust the speed at which Ambilight responds to onscreen images.

Read more about other Ambilight settings in **Help > Setup > Ambilight > Settings**.

Settings

More Ambilight settings are available in the Ambilight settings menu in Setup. To change these settings, press **⬆** and select **Setup > TV settings > Ambilight**.

Ambilight brightness

To set the Ambilight brightness, select **Ambilight brightness** and press **OK**. Adjust the light output of Ambilight.

Setup / Ambilight

Ambilight colour

To set the Ambilight colour, select **Ambilight colour** and press **OK**. Select **Dynamic**, if Ambilight should respond to onscreen images or select one of the fixed colours. Select **Custom** if you want to set a specific fixed colour.

Custom colour

To set a Ambilight colour of your own, select **Custom** in the Ambilight **Colour** menu. With Custom selected, you can open the **Custom colour** menu. Select **Palette** to choose your own colour. Ambilight Custom colour is a fixed (non-dynamic) colour setting.

Separation

To set the difference in colour level between the lights on each side of the TV, select **Separation**. Separation **Off** gives a dynamic but uniform Ambilight colour.

TV switch off

To set Ambilight to fade out and switch off a few seconds after you have switched off the TV, select **TV switch off**. Allow Ambilight to fade out and switch off completely before you switch the TV back on again.

Lounge light mood

Read more about Lounge light mood in **Help > Setup > Ambilight > Lounge light mood**.

Scenea lounge light

To always switch off Ambilight when Scenea is switched on, select **Scenea lounge light** and select **Off**.

Wall colour

The colour of the wall behind your TV can influence the colour effect of Ambilight. To correct this influence, select **Wall colour** and select a colour that matches the wall colour. Ambilight will correct its colours to mix best with the colour of the wall behind the TV.

Lounge light

When the TV is on standby, you can switch Ambilight on and create a Lounge light effect in your room.

To switch Ambilight on while the TV is on standby, press **Ambilight** on the TV.

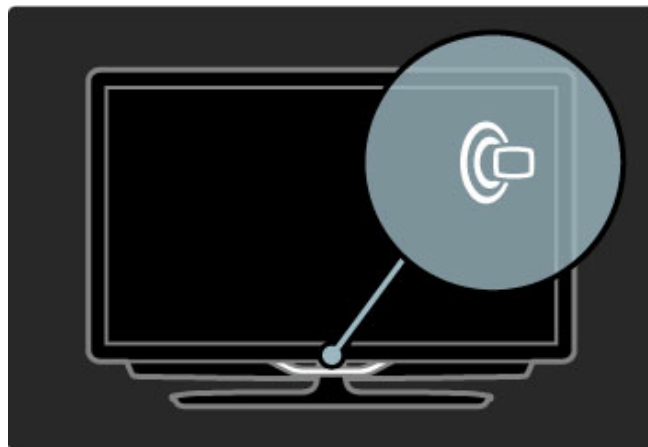

To change the Lounge light colour scheme, press **Ambilight** on the TV again.

To switch off Lounge light, press and hold **Ambilight** on the TV for 3 seconds.

You can also set up the colour scheme in the Setup menu. With the TV switched on, press **⬆** and select **Setup**. Select **TV settings > Ambilight > Lounge light mood**. Select the colour scheme with which Lounge light will start up.

4.3 Channels

Reorder and rename

You can reorder and rename channels in the Channel list.

To reorder or rename a channel, read **Help > Use your TV > Watch TV > Channel list**.

Update channels

The TV puts all installed channels in the Channel list. If you receive digital channels, you can set the TV to automatically update the list with new channels. You can also start an update of the Channel list yourself.

Automatic channel update

Once a day, at 6 AM, the TV updates the channels and stores new channels. Empty channels are removed. For new or removed channels, a message is shown at TV start up. The TV must be in standby to automatically update channels.

To switch off the message at start up, press **🏠 > Setup > Channel settings** and press **OK**. Select **Channel installation > Channel update message** and select **Off**.

To switch off the automatic channel update, press **🏠 > Setup > Channel settings** and press **OK**. Select **Channel installation > Automatic channel update** and select **Off**.

Start an update

To start an update yourself, press **🏠 > Setup > Search for channels** and press **OK**. Select **Update channels** and press **OK**. Press **Start**. The update can take a few minutes. Follow the instructions on screen.

Reinstall channels

Reinstall channels

To reinstall only the channels, press **🏠 > Setup > Search for channels > Reinstall channels** and press **OK**. Select **DVB-T** or **DVB-C**. The channel search can take a few minutes. Follow the instructions on screen.

Full installation

To redo a full TV installation, press **🏠 > Setup > TV settings > Reinstall TV** and press **OK**. The installation can take a few minutes. Follow the instructions on screen.

You can reorder and rename channels in the Channel list.

Channel list copy

Channel list copy is intended for dealers and expert users.

With Channel list copy, you can copy the channels installed on one TV onto another Philips TV of the same range. With Channel list copy, you avoid the time-consuming channel search and you can offer a predefined channel list setup. The small file you copy fits every USB memory device.

Conditions

- Both TVs are from the same year range.
- Both TVs have the same product type suffix for DVB (H, K, M, T or D/00) in their type number and have the TV installed for the same country.

- Both TVs have the same hardware type. Check the hardware type on the TV type plate on the back of the TV. Typically noted as

Q . . . LA

- Both TVs have compatible software versions. When you upload, an on-screen message will warn you if software versions are not compatible.

Copy a Channel list

1 Switch on the TV which has its channels installed. Plug in a USB memory device.

2 Press **🏠 > Setup > TV settings > Preferences > Channel list copy > Copy to USB** and press **OK**. To copy the Channel list from this TV, you might be asked to enter the TV PIN code you entered during the installation.

3 When copying is done, unplug the USB memory device.

Now you can upload the copied Channel list onto another Philips TV.

Upload a Channel list

To a TV that's not yet installed

1 Plug in the power plug to start the installation and select language and country. You can skip Search for channels. Finish the installation.

2 Plug in the USB memory device that holds the Channel list of the other TV.

3 To start the Channel list upload, press **🏠 > Setup > TV settings > Preferences > Channel list copy > Copy to TV** and press **OK**. You might be asked to enter the TV PIN code of this TV.

4 The TV notifies if the Channel list is copied to the TV successfully. Unplug the USB memory device.

To an already installed TV

1 Verify the country setting of the TV. (To verify this setting, press **🏠 > Setup > Search for channels > Reinstall channels** and press **OK**. Press **↶** (Back) and later **Cancel** to leave the Search for channels.)

If the country is correct continue with step 2 hereunder.

If the country is not correct, you need to start a reinstallation. To start the reinstallation, press **🏠 > Setup > TV settings > Reinstall TV** and press **OK**. Select the correct country and skip the Search for channels. Finish the installation. When done, return to step 2.

2 Plug in the USB memory device that holds the Channel list of the other TV.

3 To start the Channel list upload, press **🏠 > Setup > TV settings > Preferences > Channel list copy > Copy to TV** and press **OK**. You might be asked to enter the TV PIN code of this TV.

4 The TV notifies if the Channel list is copied to the TV successfully. Unplug the USB memory device.

DVB-T or DVB-C

If both DVB-T and DVB-C reception is available in your country and if this TV is ready to receive DVB-T and DVB-C for your country, you will have selected one or the other during the channel installation.

If you want to change the DVB setting to start a new channel installation, press **🏠 > Setup > Channel settings** and press **OK**. Select **Channel installation > Antenna or Cable DVB** and press **OK**. Select the DVB setting you want.

DVB-C channel installation

For ease of use, all DVB-C settings are set to automatic. If your DVB-C provider gave you specific DVB-C values, like a symbol rate or a frequency, enter these values when the TV asks for them during installation.

DVB-T + DVB-C

You can set up your TV for DVB-T and DVB-C. Install one system followed by the other. When both installations are complete, the Channel list will show both DVB-T and DVB-C channels.

Reception quality

If you receive digital channels, you can check the quality and signal strength of a channel.

If you use an antenna, you can reposition the antenna to try and improve the reception.

To check the reception quality of a digital channel, switch to the channel and press **⬆** > **Setup** > **Channel settings** and press **OK**. Select **Channel installation** > **Digital : reception test** and press **OK**.

The digital frequency is shown for this channel. If the reception is poor, you can reposition your antenna. To check the signal quality of this frequency again, select **Search** and press **OK**.

To enter a specific digital frequency yourself, select the frequency, position the arrows on a number with **▶** and **◀** and change the number with **▲** and **▼**. To check the frequency, select **Search** and press **OK**.

If you use DVB-C to receive channels, the options **Symbol rate mode** and **Symbol rate** are available. For Symbol rate mode, select **Automatic**, unless your cable provider gave you a specific symbol rate value. To enter the symbol rate value, use the number keys.

Manual installation — Analogue

Analogue TV channels can be manually tuned in channel by channel.

To install analogue channels manually, press **⬆** > **Setup** > **Channel settings** and press **OK**. Select **Channel installation** > **Analogue : manual installation** and press **OK**.

1 System

To set up the TV system, select **System** and press **OK**. Select your country or part of the world where you are now.

2 Find channel

To find a channel, select **Find channel** and press **OK**. Select **Search** and press **OK**. You can also enter a frequency yourself. If the reception is poor, press **Search** again. If you want to store the channel, select **Done** and press **OK**.

3 Fine tune

To fine tune a channel, select **Fine tune** and press **OK**. You can fine tune the channel with **▲** or **▼**. If you want to store the channel found, select **Done** and press **OK**.

4 Store

You can store the channel on the current channel number or as a new channel number. Select **Store current channel** or **Store as new channel**.

You can redo these steps until you found all available analogue TV channels.

Clock settings

In some countries, digital broadcasts do not send UTC - Coordinated Universal Time information. The daylight saving change might be ignored and the TV might show an incorrect time.

To correct the TV clock, press **⬆** > **Setup** > **TV settings** > **Preferences** > **Clock** and select **Country dependent**. Select **Daylight saving** and select the appropriate setting. To set the time and date manually, select **Manual**. Then select **Time** or **Date**.

4.4 Satellite channels

Introduction

As well as the DVB-T and DVB-C reception, this TV has a built-in satellite **DVB-S receiver**. With a satellite dish antenna connected, you can receive **digital satellite channels**. You do not need an external satellite receiver.

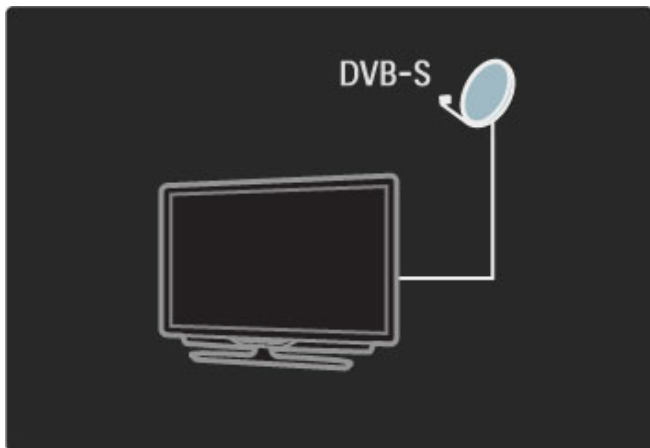

LNB

An LNB (Low Noise Block-downconverter) captures the signals from a satellite and is mounted at the end of the pole on the dish antenna. The TV can receive signals from 4 different LNBs.

Installation

With a properly set-up and connected satellite dish antenna, you can install satellite channels on the TV.

You can install channels from 4 different satellites (4 LNBs).

1 Install

To search for satellites and install satellite channels, press **Home** > **Setup** > **Search for satellite** and press **OK**. If you have already installed satellites, select **Reinstall channels** and press **OK**.

2 Connection type

Before you start searching for satellites, you must set the connection type. The connection type will determine the number of LNBs you can install (the number of different satellites). For ease of installation, select the correct type for the number of satellites you want to install.

To set up the connection type, select **Settings** and press **OK**. Select **Connection type** and select **One LNB** if you have only one LNB, select **DiSEqC Mini** for 2 LNBs or select **DiSEqC 1.0** to install 3 or 4 LNBs. Select **Done** to close the settings.

3 Search for satellites

To start the search, select **Start** and press **OK**. The TV searches for all available satellites. This can take several minutes. If no satellites are found, check the antenna connections and the position of the dish antenna.

The signal quality shown is not always representative of the signal quality of all channels on that satellite.

To repeat the search for satellites, select **Restart** and press **OK**. If you are satisfied with the satellites found, you can install all their channels.

4 Install channels

To install all channels for the satellites you found, press **Install**. The installation can take several minutes per satellite.

When the installation is finished, you can find all channels in the satellite Channel list.

More settings

For most satellites, you do not need to change the LNB settings but, if you are searching for a specific satellite on C-band for instance, you need to set the LNB you use for this satellite to **Single**. Or, if you are an expert user, you might need a **Custom** setting for the LNBs you use.

Reset

You might have lost track of the settings you set up.

To reset the satellite installation settings to factory settings, select **Reset** in Settings and press **OK**.

Signal reception test

The automatic channel install might have missed a specific channel or channels from a transponder. You can add a transponder with Signal reception test. Read **Help** > **Setup** > **Satellite channels** > **Signal reception test**.

Dish antenna connection

Read more about the antenna connection for satellite in **Help** > **Connections** > **First connections** > **Satellite antenna**.

Find the list of preset satellites on this TV in **Help** > **Specifications** > **Power and reception**.

Add or remove

If satellite channels are already installed, you can add an extra satellite to the installation. You can install channels from 4 different satellites - 4 LNBs.

1 Connection type

Check the Connection type setting before you add a satellite. The setting **One LNB** receives only one LNB, the setting **DiSEqC Mini** receives only 2 LNBs and the setting **DiSEqC 1.0** can receive 3 or 4 LNBs.

To check the Connection type first, press **Home** > **Setup** > **Search for satellite** and press **OK**. Select **Reinstall channels** and select **Settings** and press **OK**. Select **Connection type** and select the setting you need for the number of satellites you want to install. Select **Done** to close the settings. Press **Back** to close Reinstall channels.

2 Add a satellite

To add a satellite, press **Home** > **Setup** > **Search for satellite** and press **OK**. Select **Add satellite** and press **OK**. The TV searches for a satellite on the first free LNB. This can take several minutes.

If no satellites are found, check the antenna connections and the position of the dish antenna. Select **Restart** or **Next LNB**.

If there are no free LNBs, you can remove a satellite first. Read **Remove satellites** on the following page.

3 Install channels

If you are satisfied with the added satellite, you can install the channels.

To install all channels, press **Install**. The installation can take several minutes. When installation is complete, you can find the added channels in the satellite Channel list.

You can remove a satellite from your satellite installation.

To remove a satellite, press **Home** > **Setup** > **Search for satellite**. Select **Remove satellite** and press **OK**. Select the satellite you want to remove and press **OK**. To confirm, select **Yes** and press **OK**. The satellite and its channels are removed from the installation.

Update channels

If satellite channels are already installed, you can update the channel list with possible new channels from all installed satellites.

To update the satellite channels, press **⬆** > **Setup** > **Search for satellite**. Select **Update channels** and press **OK**. The TV scans the satellites for new channels and adds them to the list. Empty channels are removed from the list. The update can take several minutes per satellite. When the update has finished, the Channel list for satellites is updated.

Signal reception test

With Signal reception test for satellites, you can check the signal strength of a satellite or you can add a new satellite channel.

To start Signal reception test, press **⬆** > **Setup** > **Search for satellite**. Select **Signal reception test** and press **OK**.

1 Select the **LNB**.

2 If you know the frequency of the transponder (which can hold several channels), select **Frequency** and enter it.

3 Select **Search** and press **OK**.

4 If the TV finds a frequency and there is a store button shown, a new transponder has been found.

5 Press **Store** to add the new transponder with its channel or channels to the Channel list.

To add another transponder, select **Exit** and repeat the steps.

Troubleshooting

The TV cannot install the satellite I want

- Check the orientation of the dish antenna.
- Check the setting for the LNB that you use for this satellite.
- Check the connection type in the satellite installation settings.

• Reset all satellite settings if you lost track of the settings you changed. Read **Help** > **Setup** > **Satellite channels** > **Installation**.

The reception of a satellite channel is poor

- Check the orientation of the dish antenna.

Sometimes the reception is poor

- Check if the dish antenna is solidly mounted. Strong winds can move the dish.
- Snow and rain can degrade reception.

Read more about troubleshooting in **Help** > **Troubleshooting**.

4.5 Network

Benefits

Browse PC

If you connect the TV to a home network, you can play photos, music and videos from your computer or storage device. Once the network is installed on the TV, you can find and play the files from your PC on the TV screen.

Net TV

If you connect the TV to a home network, you can link up the TV to Net TV. Net TV offers Internet services and websites tailored to your TV. Play music and videos, consult infotainment, rent movies and much more. Once the network is installed, you can enjoy the best of the Internet for your TV.

Wi-Fi MediaConnect

With Wi-Fi MediaConnect you can bring up (project) your PC screen on the TV screen wirelessly. You start Wi-Fi MediaConnect from your PC.

What you need

To connect the TV to a home network and the Internet, you need a router in your home network. The router must be set to DHCP server on. Use a router with a high-speed (broadband) connection to the Internet. You can connect the TV wirelessly or wired.

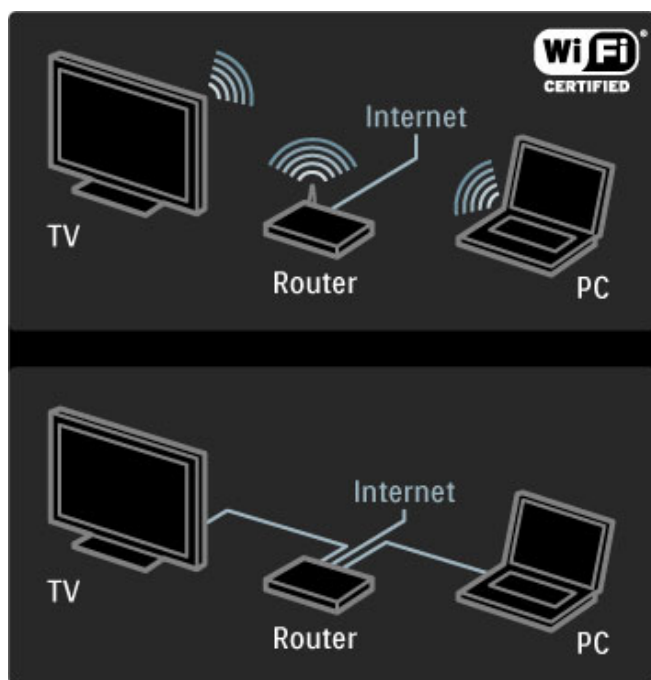

If you use a wired connection to the router you need a network (Ethernet) cable.

The TV uses a DLNA-certified protocol. You can use a computer with Microsoft Windows XP, Vista or Windows 7, Intel Mac OSX or Linux as the operating system.

Find your PC files

To select your PC files on screen, you need recent media server software on your computer, like Windows Media Player 11 or similar. To find your files on the TV, some media server software must be set up to share the PC files with the TV.

Find the list of supported media server software in **Help > Specifications > Multimedia**.

Wireless installation

Switch on your router before you start the network installation.

To start the wireless network installation, press **Home**, select **Setup > Connect to network** and press **OK**. Follow the instructions on screen.

WPS - Wi-Fi Protected Setup

If your router has WPS (Wi-Fi Protected Setup), go to the router and press the WPS button. Return to the TV within 2 minutes, select **WPS** and press **OK**. The TV connects to your network. This takes about 2 minutes. Finish the installation.

Most new wireless routers have the WPS system and carry the WPS logo. The WPS system uses WPA security encryption and cannot be combined with devices on your network that use the WEP security encryption. If you still need this WEP device in your network, install with **Scan > Standard**.

Scan for routers

If you have several routers in your network, you can select the network you need. To select a specific network router, press **Scan** on the first page of the installation. The routers with WPS and with the strongest signal are shown first in the list.

Select the router you need and press **WPS** if the router has WPS. Or press **Pin code** if you can enter the PIN code in your router software to connect. Or press **Standard** to enter the encryption key manually.

PIN code

To make the secured connection with a PIN code, select **PIN code** and press **OK**. Write down the 8-digit PIN code shown and enter it in the router software on your PC. See the router manual where to enter the PIN code.

Standard

To enter the encryption key (the security key) manually, select **Standard** and press **OK**. If you have WPA security on your router, enter the passphrase with the remote control. To open the on-screen keyboard, select the text entry field and press **OK**.

If you have WEP security encryption, the TV asks for the WEP encryption key in hexadecimal numbers. Find this hexadecimal key in the router software on your PC. Write down the first key of the WEP keys list and enter it on TV with the remote control. If the security key is accepted, the TV is connected with the wireless router.

If asked, agree to the End User License Agreement.

Wi-Fi Media Connect

With Wi-Fi MediaConnect you can bring up (project) your PC screen on the TV screen wirelessly. With the supplied Wi-Fi MediaConnect CD-ROM you can download the software for free. Wi-Fi MediaConnect is only available for PC.

What you need

To use Wi-Fi MediaConnect, you need to connect the TV to your home network. You need a wireless router. Read more about connecting to a network in **Help > Setup > Network**.

Install Wi-Fi MediaConnect

- 1 Insert the Wi-Fi MediaConnect CD-ROM into your PC.
- 2 Your PC starts your Internet browser and opens the Wi-Fi MediaConnect download page - www.philips.com/wifimediconnect. On the website, you can check the necessary PC system requirements.

- 3 Enter the code printed on the CD-ROM envelope.
- 4 Click the 'Download now' button to download the free Wi-Fi MediaConnect software.
- 5 Once downloaded, start the file 'Wi-Fi MediaConnect_setup.exe'. Follow the instructions on screen.

TV network name

If you have more than one TV in your home network, you can rename this TV. To rename this TV in the network, press **⬆** > **Setup** > **Network settings** and select **TV network name**. To enter the name, press **OK** to open the on-screen keyboard or use the remote control keypad.

To use Wi-Fi MediaConnect on your PC read **Help** > **More TV** > **Videos, photos and music** > **Wi-Fi MediaConnect**.

PC requirements

Windows XP, Vista, Windows 7 (PC only)

Minimum PC requirements

- Intel® Pentium Core™ 2 Duo 1.8GHz
- 512MB RAM
- 200MB free hard disk space
- Wi-Fi 802.11g
- Broadband Internet connection

Recommended PC requirements

- Intel® Pentium Core™ 2 Duo 2.1GHz
- 1GB RAM
- 200MB free hard disk space
- Wi-Fi 802.11n for router and PC
- Broadband Internet connection

Wired installation

Connect the router to the TV and switch on your router before you start the network installation.

To start the network installation, press **⬆**, select **Setup** > **Connect to network** and press **OK**. Follow the instructions on screen.

The TV constantly searches for a network connection. The router must be set to DHCP server on.

If asked for, agree to the End User License Agreement.

Read more about how to connect in **Help** > **Connections** > **Network** > **Wired**.

Network settings

To open the Network settings, press **⬆** > **Setup** > **Network settings** and press **OK**.

You can view the network type, IP and MAC address, the signal strength, speed and encryption method etc. You can set DHCP and Auto IP, the IP configuration settings, DMR and the TV network name.

4.6 Devices

EasyLink HDMI-CEC

With EasyLink HDMI-CEC your TV and the connected devices can work together. You can use the TV remote control to operate EasyLink devices. The device needs to be connected with an HDMI cable. Devices with EasyLink appear automatically in the Home menu.

Setup

The TV comes with EasyLink switched on.

Make sure that all HDMI-CEC settings are properly set up on the connected EasyLink devices. EasyLink might not work with devices from other brands.

Switch off EasyLink RC

If you don't want to operate devices with the TV remote control, you can switch off EasyLink remote control separately. Press Home  > **Setup** > **TV settings** and select **EasyLink** > **EasyLink Remote Control** and select **Off**.

Switch off EasyLink

To switch off EasyLink completely, press Home  > **Setup** > **TV settings** and select **EasyLink** > **EasyLink On/Off** and select **Off**.

HDMI-CEC on other brands

The HDMI-CEC functionality has different names on different brands. Some examples are: Anynet, Aquos Link, Bravia Theatre Sync, Kuro Link, Simplink and Viera Link. Not all brands are fully compatible with EasyLink.

Read more about using EasyLink in **Help** > **Use your TV** > **Remote control** > **Operate devices**.

Add a new device

Devices connected with EasyLink HDMI-CEC automatically show their activity in the Home menu. A single device can add several activities. The device must be connected with an HDMI cable. If your connected device does not appear in the Home menu, on the device EasyLink may be switched off.

If your connected device does not have EasyLink or is not connected with an HDMI cable, you need to manually add your device with **Add your devices** in the Home menu.

Add your devices

In the Home menu, select **Add your devices** and press **OK**.

Follow the instructions on screen.

The TV asks you to select the device and the connection to which the device is connected.

The device or its activities are now added to the Home menu.

Rename a device

To rename a device in the Home menu, select the device and press  **OPTIONS** and select **Rename**. Use the keypad on the remote control as you do for SMS/text messaging to enter the new name or press **OK** to open the on-screen keyboard.

Delete a device

To delete a device or activity from the Home menu, select the item and press  **OPTIONS** and then select **Remove this device**.

If the device or activity, keeps appearing in the Home menu after you deleted it, switch off the EasyLink setting on the device to prevent the icon from being automatically added again.

Audio to Video sync

With a Home Theatre System (HTS) connected to the TV, the picture on TV and the sound from the HTS should be synchronised. A mismatch can be visible in scenes with people talking. When they finish sentences before their lips stop moving.

Automatic audio to video sync

With recent Philips Home Theatre Systems, the audio to video sync is automatically synchronised and always correct.

Audio sync delay

Other Home Theatre Systems might need to adjust the audio sync delay to synchronise the audio to video. On the HTS, increase the delay value until there is a match between picture and sound. A delay value of 180ms may be required. Read the user manual of the HTS.

With a delay value set up on the HTS, you need to switch off **Audio Out delay** on the TV if the HTS sets an identical delay for all its incoming audio. To switch off Audio Out delay, press  and select **Setup** > **TV settings** > **Preferences** > **Audio Out delay**. Select **Off** and press **OK**.

If you cannot set up a delay on the HTS or its maximum setting is insufficient, you can switch off the Perfect Natural Motion picture processing of the TV. To switch off Perfect Natural Motion, press  and select **TV settings** > **Picture** > **Perfect Natural Motion**. Select **Off** and press **OK**.

Auto subtitle shift

If you play a DVD or Blu-ray Disc on a recent Philips player, the TV can move the subtitles upwards. Subtitles will then be visible whatever Picture format you select. The TV comes with Auto subtitle shift switched on.

To switch off Auto subtitle shift, press  > **Setup** > **TV settings** > **EasyLink** > **Auto subtitle shift**. Select **Off**.

Pixel Plus link

Some other devices, DVD or Blu-ray Disc players, might have their own picture quality processing. To avoid bad picture quality caused by interference with the TV processing, the picture processing of these devices should be disabled. The TV comes with Pixel Plus link switched on and disables the picture quality processing of recent Philips devices connected to the TV.

To switch off Pixel Plus link, press  > **Setup** > **TV settings** > **EasyLink** > **Pixel Plus link**. Select **Off**.

4.7 Universal access

Switch on

With Universal access switched on, the TV is set for use for hearing and visually impaired people.

Switch on

If you did not switch on Universal access during the installation, you can still switch it on in Setup.

To switch on Universal access, press **▲** > **Setup** > **TV settings** > **Preferences** > **Universal access**. Select **On** and press **OK**.

With Universal access switched on in Setup, the Universal access option is added in the Options menu. With Universal menu in the Options menu, you can set specific settings for hearing and visually impaired people.

Hearing impaired

Some digital TV channels broadcast special audio and subtitles adapted for hearing impaired people. With Hearing impaired switched on, the TV automatically switches to the adapted audio and subtitles, if available.

Switch on

To switch on Hearing impaired, press **≡** **OPTIONS**, select **Universal access** and press **OK**. Select **Hearing impaired**, select **On** and press **OK**.

To check whether a hearing impaired audio language is available, press **≡** **OPTIONS**, select **Audio language** and look for an audio language marked with a .

If Universal access does not appear in the Options menu, switch on Universal access in the Setup. Read **Help** > **Setup** > **Universal access** > **Switch on**.

Visually impaired

Some digital TV channels broadcast special audio called Audio Description for visually impaired people. The audio consists of a narrator describing what is happening in the programme during the pauses in the normal audio.

Switch on

To switch this visually impaired audio, press **≡** **OPTIONS**, select **Universal access** and press **OK**. Select **Visually impaired** and select **On** or, if available, select the speakers the adapted audio should be played from. If available, the TV will play the visually impaired audio.

Volume - Visually impaired

If available, you can set the volume of the extra commentary.

To check whether a visually impaired audio language is available, press **≡** **OPTIONS**, select **Audio language** and look for an audio language marked with a .

If Universal access does not appear in the Options menu, switch on Universal access in the Setup. Read **Help** > **Setup** > **Universal access** > **Switch on**.

Key beep

Key beep gives an audio feedback each time you press a key on the remote control. The volume of the beep is fixed.

Switch on

To switch on Key beep, press **≡** **OPTIONS**, select **Universal access** and press **OK**. Select **Key beep** and select **On**.

If Universal access does not appear in the Options menu, switch on Universal access in the Setup. Read **Help** > **Setup** > **Universal access** > **Switch on**.

4.8 Software

Current version

To view the current TV software version, press **▲** > **Setup** > **Software settings** and press **OK**. Select **Current software info** and read **Version**:

Update from Internet

If the TV is connected to the Internet, you may receive a message from Philips to update the TV software. You need a high-speed (broadband) Internet connection.

If you receive this message, we recommend you carry out the update. Select **Update**. Follow the instructions on screen.

You can also look for new updates yourself. To look for an update, press **▲** > **Setup** > **Update software** and press **OK**. Follow the instructions on screen.

When the update is complete, the TV switches off and back on again automatically. Wait for the TV to switch itself back on. Do not use the Power switch **⏻** on the TV.

Update with USB

It might be necessary to update the TV software. You need a PC with an high-speed Internet connection and a USB memory device to upload the software on the TV. Use a USB memory device with 256MB free space. Make sure that write protection is switched off.

- 1 Start
- 2 Identify
- 3 Download
- 4 Update TV

1 Start the update on TV

To start the software update, press **▲** > **Setup** > **Update software**. Select **USB**.

2 Identify the TV

Insert the USB memory into the side of the TV, select **Start** and press **OK**. An identification file is written on the USB memory device.

3 Download the TV software

Insert the USB memory into your PC. On the USB memory device, locate the file **update.htm** and double click it. Click on **Send ID**. If new software is available, download the .zip file. After the download, unzip the file and copy the file **autorun.upg** onto the USB memory device. Do not place this file in a folder.

4 Update the TV software

Insert the USB memory into the TV again. The update starts automatically. The TV switches itself off for 10 seconds and then back on again. Please wait.

Do not . . .

- use the remote control
- remove the USB memory device from the TV

If a power cut occurs during the update, never remove the USB memory device from the TV. When the power returns, the update will continue.

At the end of the update, the message **Operation successful** appears on screen. Remove the USB memory device and press **⏻** on the remote control.

Do not . . .

- press **⏻** twice
 - use the **⏻** switch on the TV
- The TV switches itself off (for 10 seconds) and then back on again. Please wait.

The TV software has been updated. You can use the TV again.

To prevent an accidental update of the TV software, delete the **autorun.upg** file from the USB memory device.

5 Connections

5.1 First connections

Power cable

Insert the power cable into the power socket of the TV.

When disconnecting the power cable, always pull the plug, never the cable.

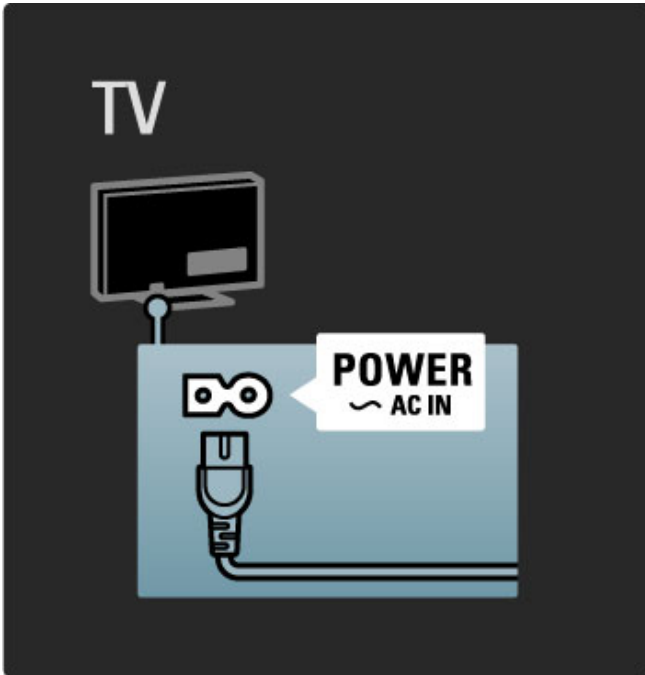

Although this TV has a very low standby power consumption, switch off the TV with the power switch to save energy if you do not use the TV for a long period of time. Read more about the power switch in **Help > To begin > Keys on the TV > Power switch**.

Make sure the power cable is securely inserted into the TV. Make sure that the power plug in the wall socket is accessible at all times.

Antenna cable

Locate the antenna connection at the back of the TV. Insert the antenna cable securely into the **Antenna** socket.

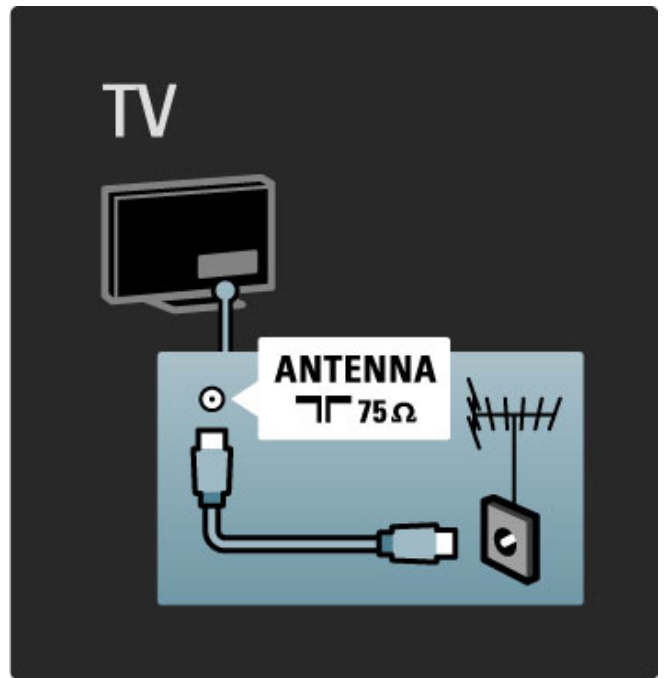

Satellite antenna cable

Locate the F-type satellite antenna connection at the side of the TV. Attach the satellite antenna cable to this connection.

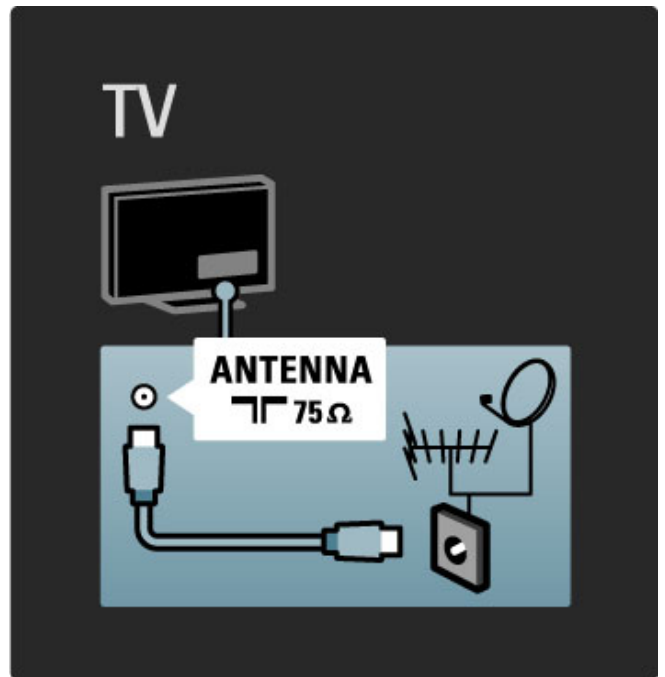

5.2 About cables

Cable quality

Before you connect devices to the TV, check which connectors are available on the device. Connect the device to the TV with the highest quality connection available. Good quality cables ensure a good transfer of picture and sound. Read the other chapters of **About cables**.

The connections diagrams shown in **Help > Connections > Connect devices** are recommendations. Other solutions are possible.

HDMI

An HDMI connection has the best picture and sound quality. One HDMI cable combines video and audio signals. Use an HDMI cable for High Definition (HD) TV signals. An HDMI cable transfers picture and sound signals in only one direction (except for the HDMI ARC). Do not use an HDMI cable longer than 5 m.

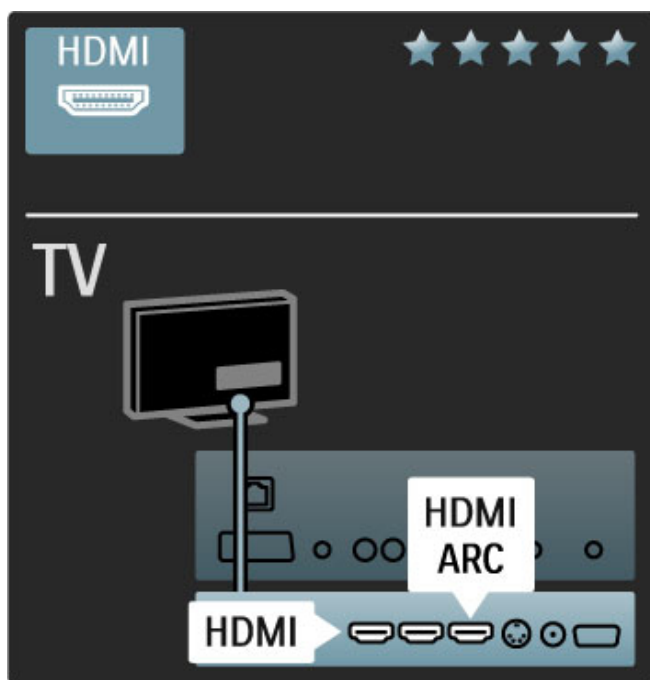

EasyLink HDMI-CEC

If your devices are connected with HDMI and have EasyLink, you can operate them with the TV remote control. Read more about EasyLink in **Help > Use your TV > Remote control > Operate devices**.

HDMI ARC connection

Connect a Home Theatre System to the HDMI ARC connection. With HDMI ARC, the extra audio cable from the TV to the HTS is not necessary. With one HDMI cable connected to HDMI ARC (Audio Return Channel) both cables are combined.

Switch off HDMI ARC

In case you would like to switch off the audio return signal on the HDMI ARC connection, press **Home** > **Setup** > **TV settings** > **EasyLink** > **HDMI 1 ARC**, select **Off** and press **OK**.

DVI to HDMI

Use a DVI to HDMI adapter if your device only has a DVI connection. Use one of the HDMI connections and add an Audio L/R cable (mini-jack 3.5 mm) to **Audio In DVI/VGA** for sound, on the back of the TV.

Copy protection

DVI and HDMI cables support HDCP (High-bandwidth Digital Contents Protection). HDCP is a copy protection signal that prevents copying content from a DVD disc or Blu-ray Disc. Also referred to as DRM (Digital Rights Management).

Y Pb Pr

Use the Component Video YPbPr connection together with an Audio Left and Right connection for sound.

Match the YPbPr connector colours with the cable plugs when you connect. YPbPr can handle High Definition (HD) TV signals.

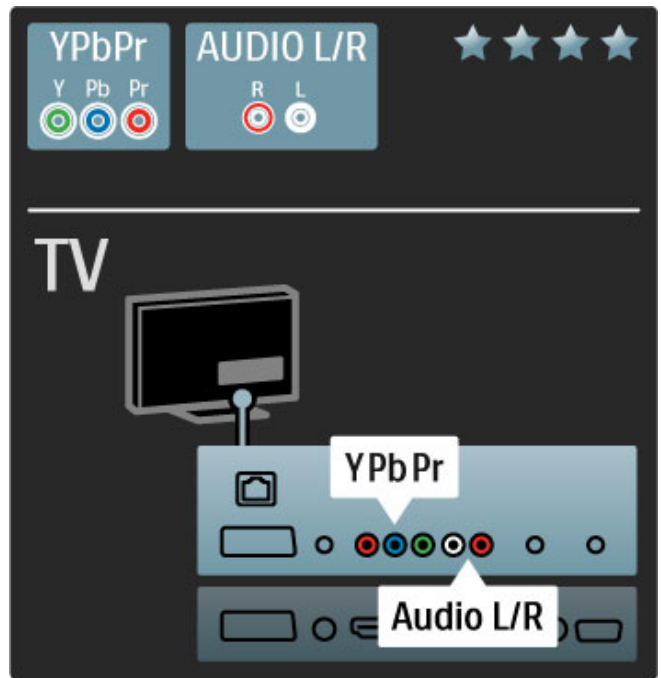

SCART

A SCART cable combines video and audio signals. SCART connectors can handle RGB video signals but cannot handle High Definition (HD) TV signals.

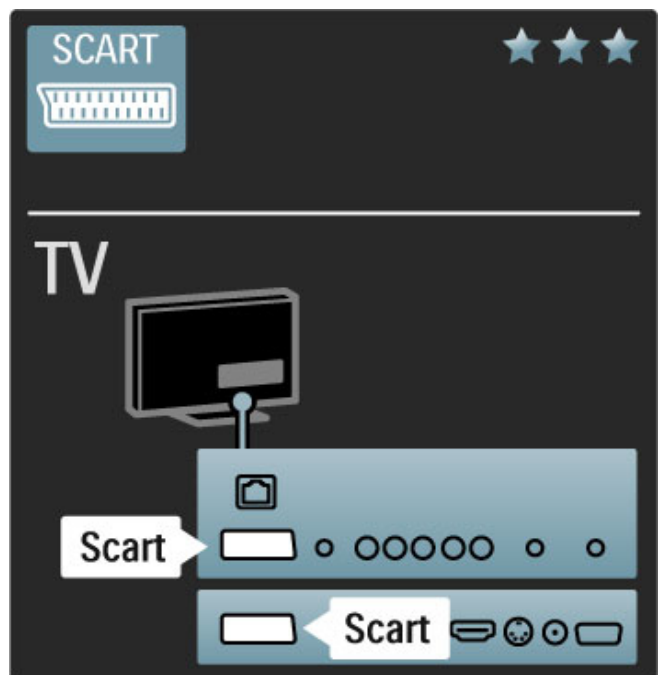

Video

If you have a device with only a Video (CVBS) connection, you need to use a **Video to SCART adapter** (not supplied). Connect the adapter to the SCART connection of the TV. You can add the Audio L/R connections (mini-jack 3.5 mm).

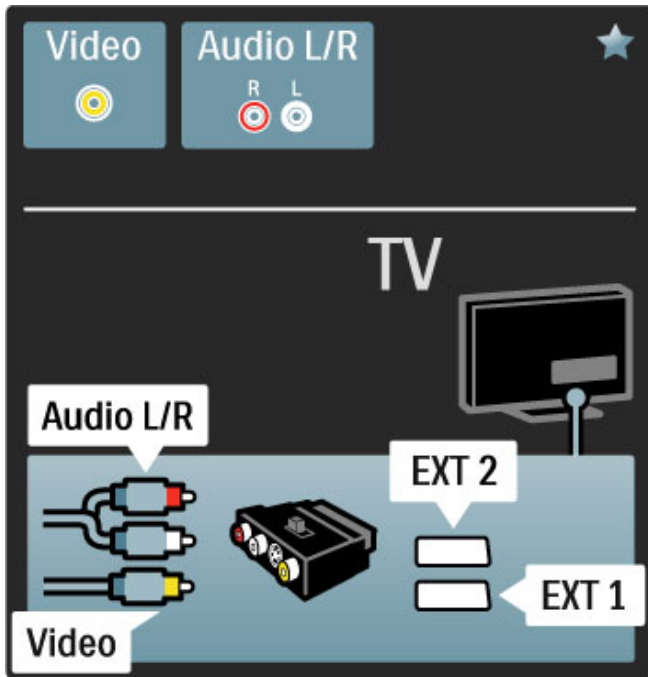

VGA

Use a VGA cable (DE15 connector) to connect a computer to the TV. With this connection you can use the TV as a computer monitor. You can add an Audio L/R cable for sound (mini-jack 3.5 mm).

To connect a computer with the VGA connection, read **Help > Connections > Connect more devices > TV as PC monitor**.



5.3 Connect devices

SoundBar

Use an HDMI cable to connect the device to the TV.

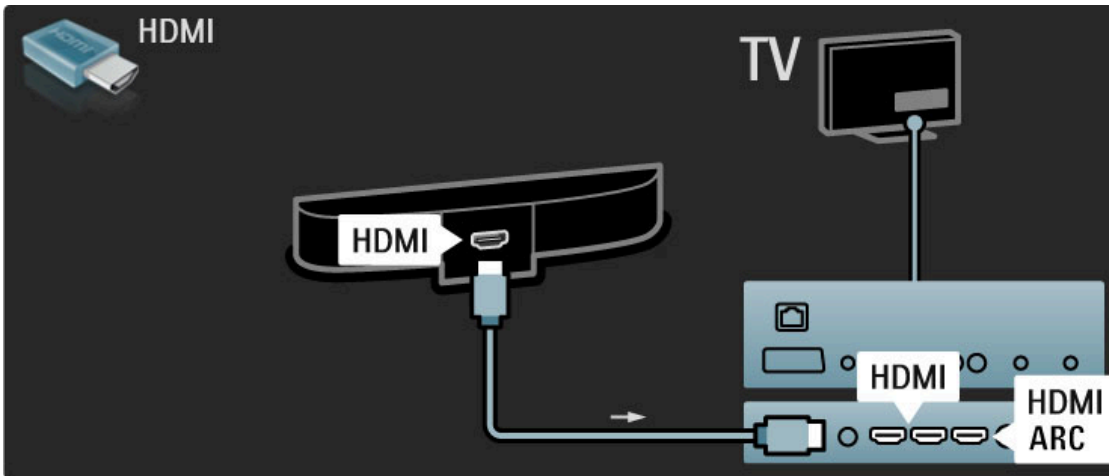

If you use the HDMI-ARC connections on both TV and device, no other cable is needed. If not, read on.

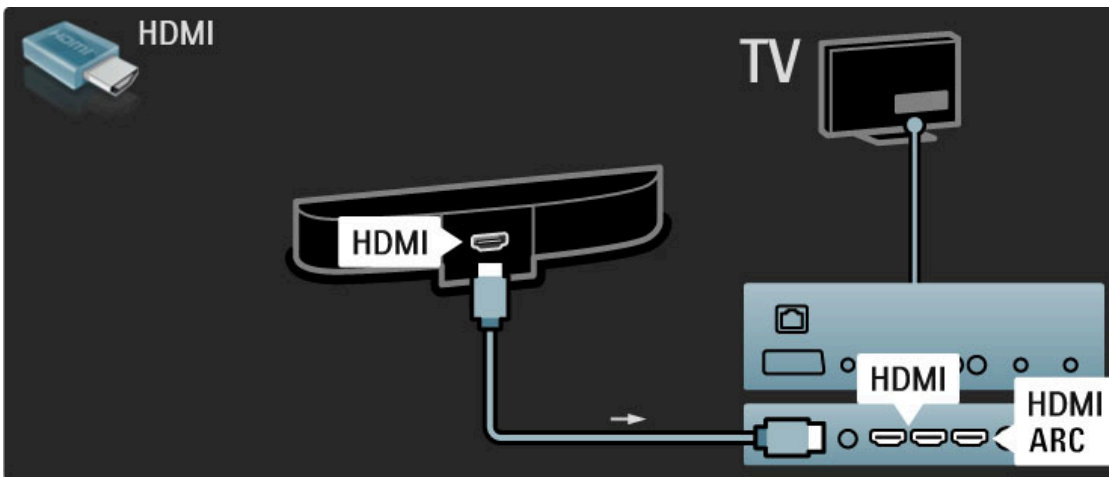

If you do not use the HDMI-ARC connection, add a digital audio cable (cinch coaxial).

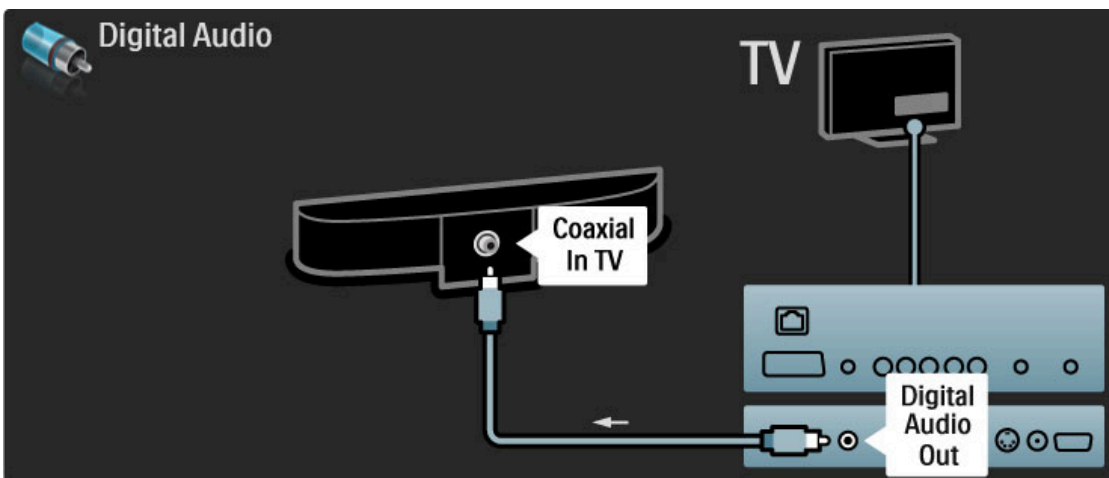

Blu-ray Disc / DVD player

Use an HDMI cable to connect the device to the TV.

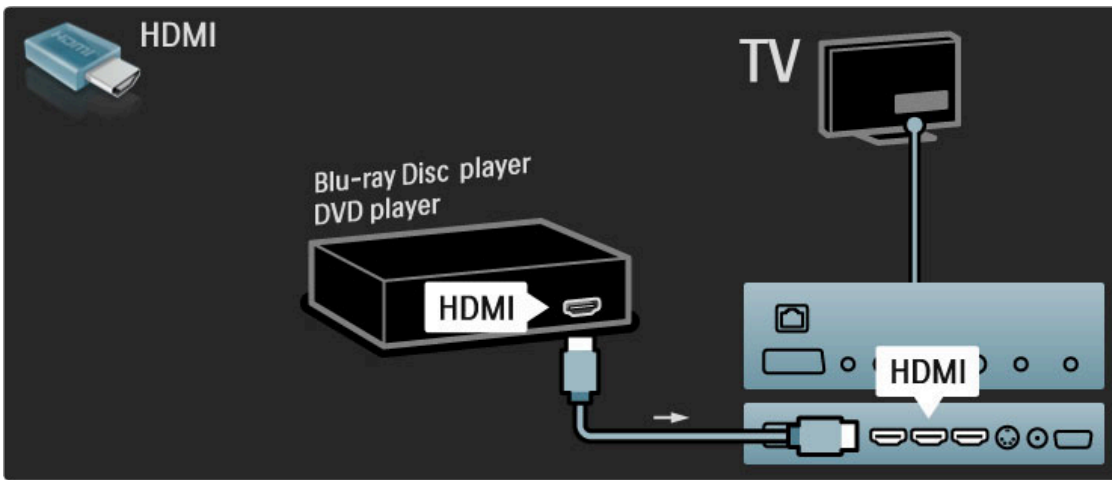

Home Theatre System with disc player

Use an HDMI cable to connect the device to the TV.

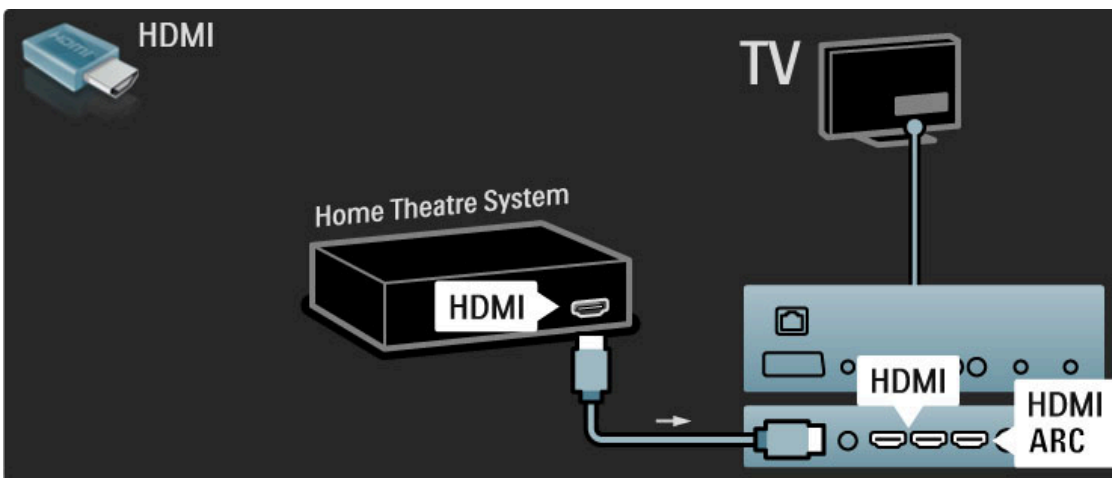

If you use the HDMI-ARC connections on both TV and device, no other cable is needed. If not, read on.

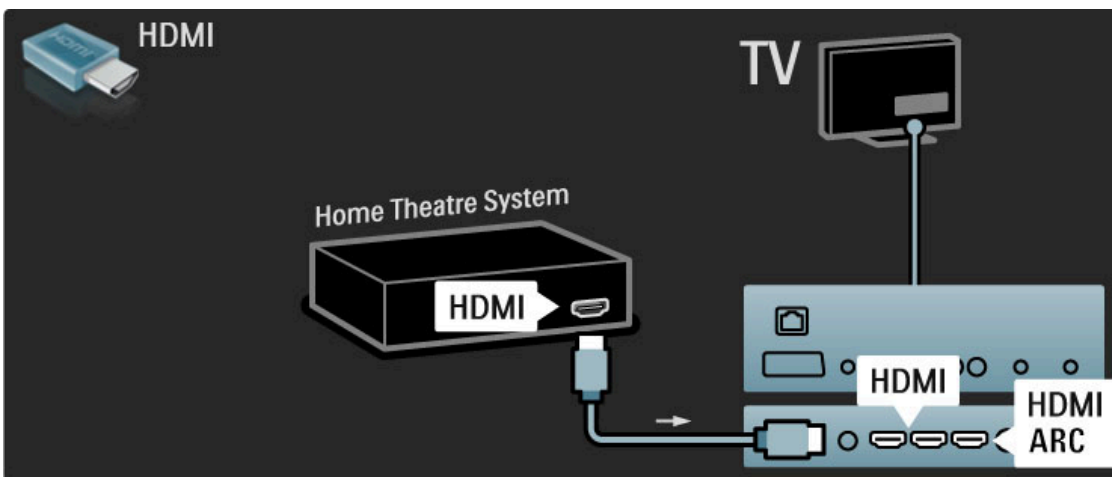

If you do not use the HDMI-ARC connection, add a digital audio cable (cinch coaxial).

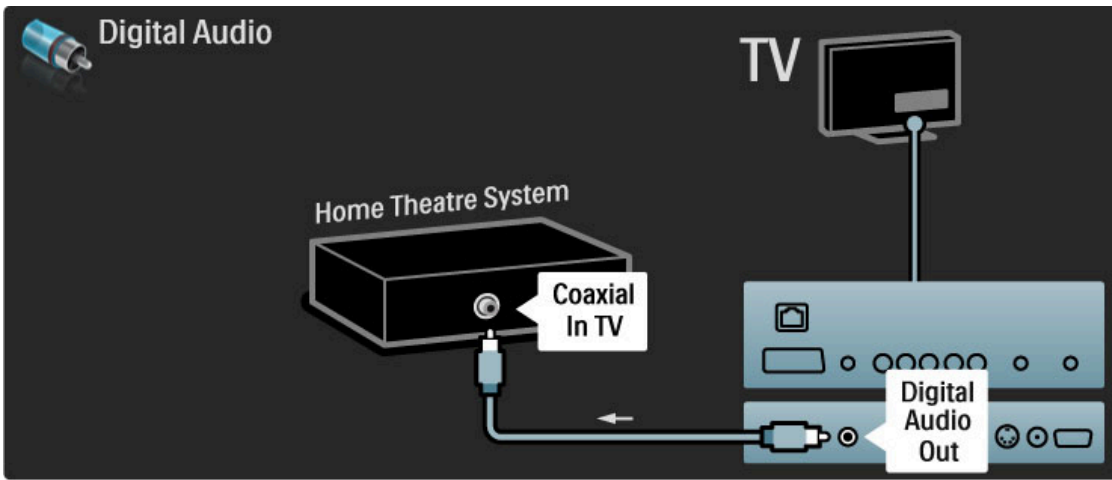

Audio to Video synchronisation (sync)

If the sound does not match with the video on screen, you can set a delay on most DVD Home Theatre Systems to match the sound and video.

Read more about Audio to Video sync in **Help > Setup > Devices > Audio to Video sync.**

Do not connect the audio signal from a DVD player or other device directly to the Home Theatre System. Always route the sound through the TV first.

Recorder

Use 2 antenna cables to connect the antenna to the device and the TV.

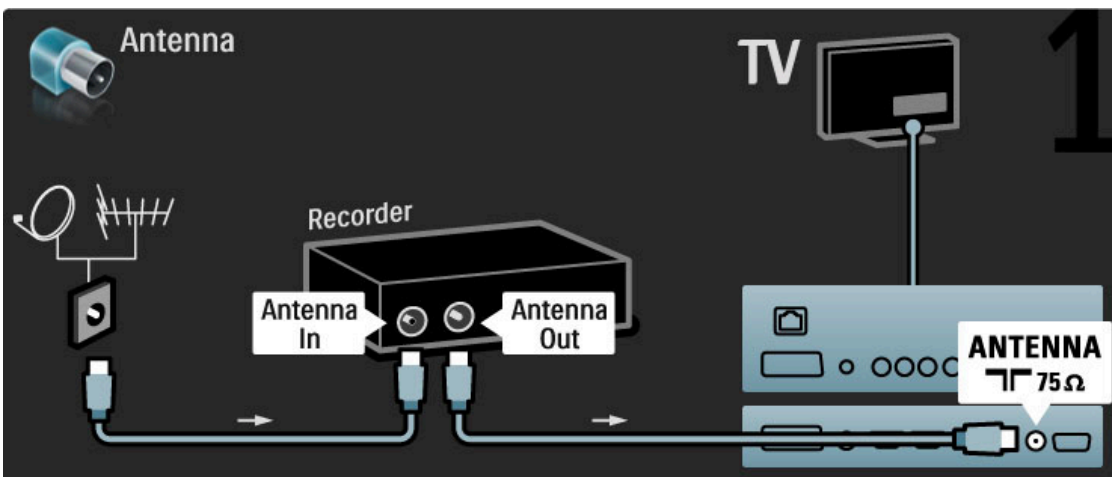

Add an HDMI cable to connect the device to the TV.

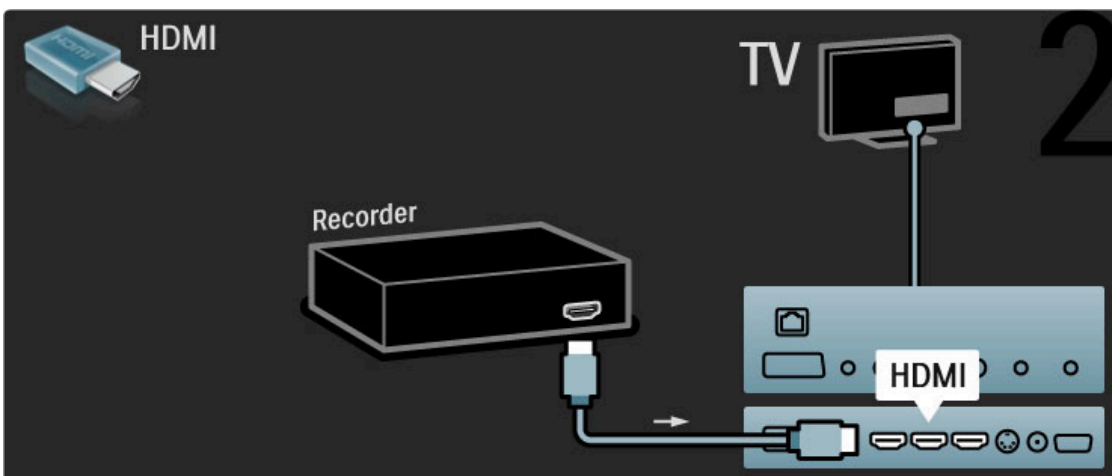

Digital receiver / Sat.

If you use a digital receiver to watch TV (a set top box - STB) and you do not use the remote control of the TV, then switch off the automatic switch off. This will prevent the TV from switching off automatically after a 4 hour period without a key press on the remote control of the TV.

To switch off the automatic switch off, press the **green** key while you are watching TV channels and select **Auto switch off** and select **Off**.

Use 2 antenna cables to connect the antenna to the device and the TV.

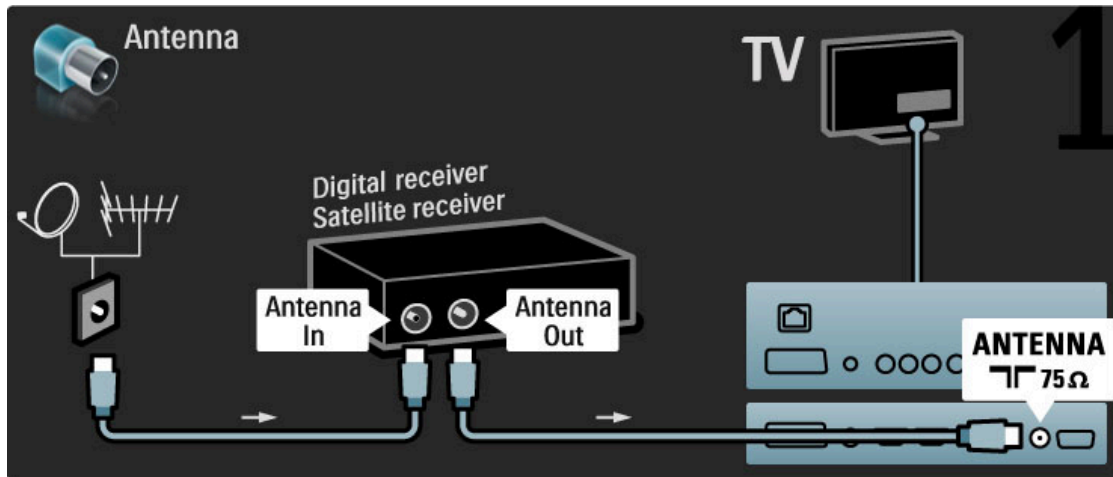

Add an HDMI cable to connect the device to the TV.

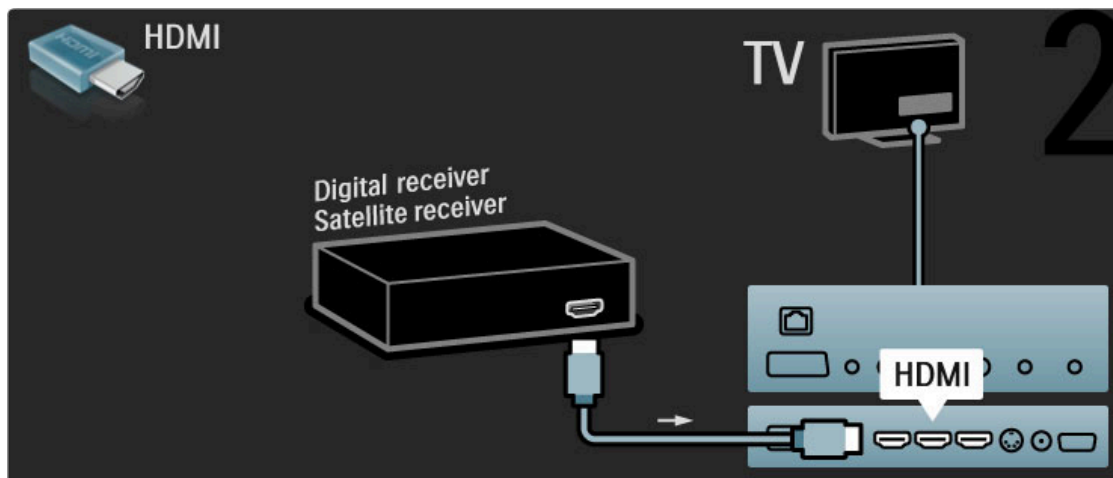

Dig. receiver + Disc Recorder

If you use a digital receiver to watch TV (a set top box - STB) and you do not use the remote control of the TV, then switch off the automatic switch off. This will prevent the TV from switching off automatically after a 4 hour period without a key press on the remote control of the TV.

To switch off the automatic switch off, press the **green** key while you are watching TV channels and select **Auto switch off** and select **Off**.

First, use 3 antenna cables to connect the devices to the TV.

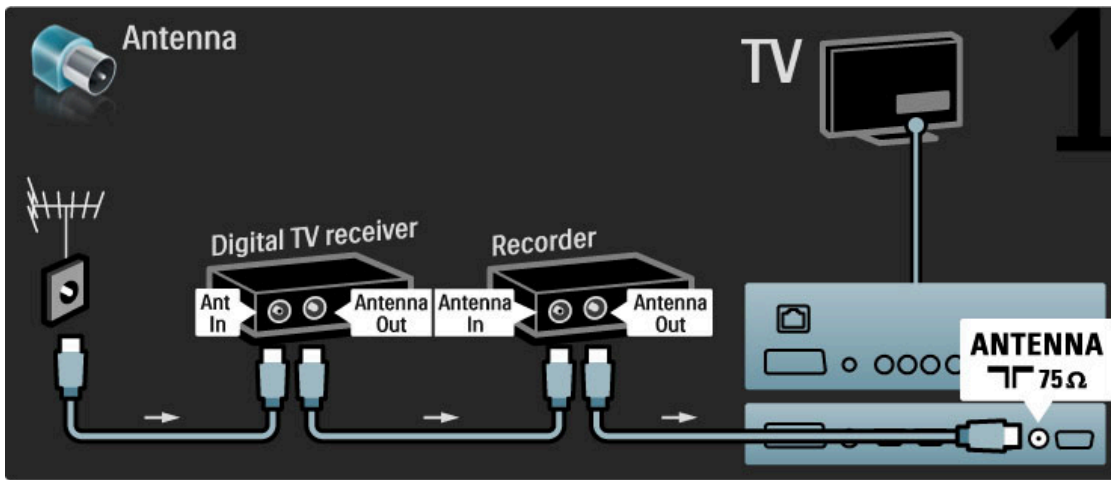

Then use an HDMI cable to connect the digital receiver to the TV.

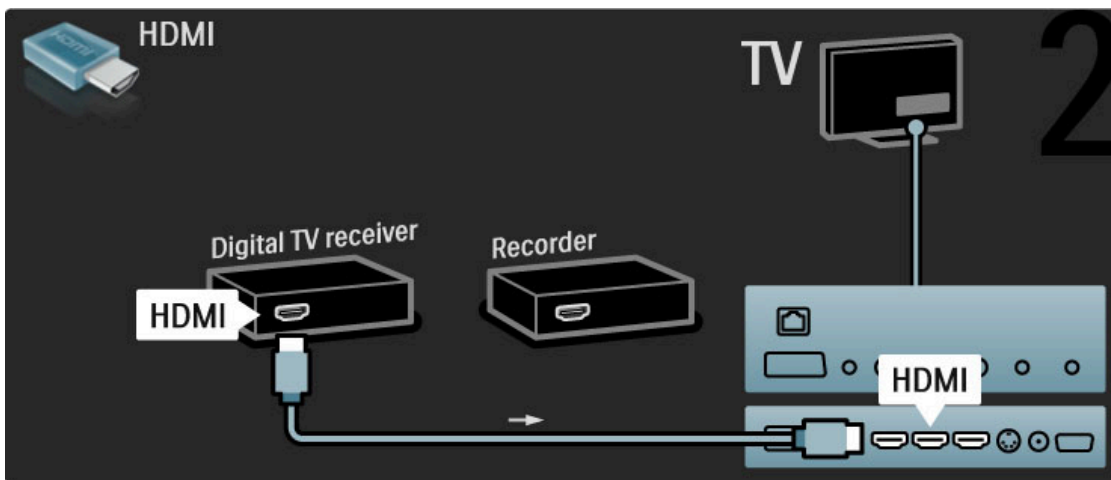

Finally, use an HDMI cable to connect the Disc Recorder to the TV.

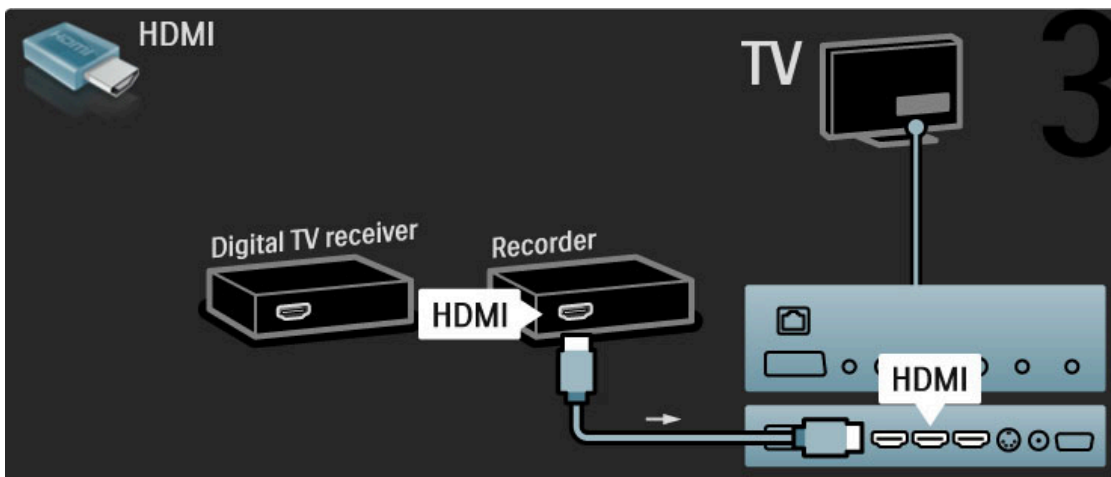

Dig. receiver + Disc-R + Home Theatre

If you use a digital receiver to watch TV (a set top box - STB) and you do not use the remote control of the TV, then switch off the automatic switch off. This will prevent the TV from switching off automatically after a 4 hour period without a key press on the remote control of the TV.

To switch off the automatic switch off, press the **green** key while you are watching TV channels and select **Auto switch off** and select **Off**.

First, use 3 antenna cables to connect the devices to the TV.

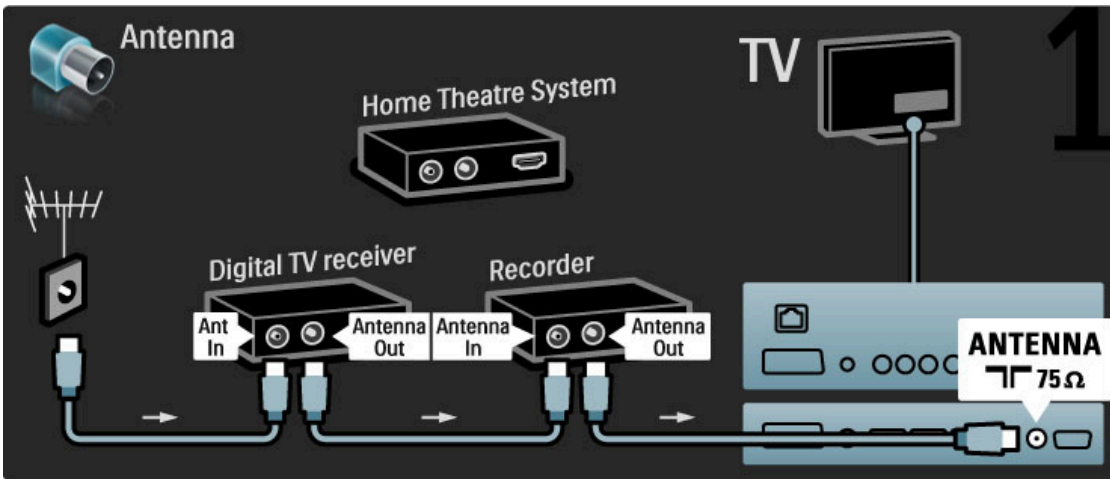

Then use an HDMI cable to connect the digital receiver to the TV.

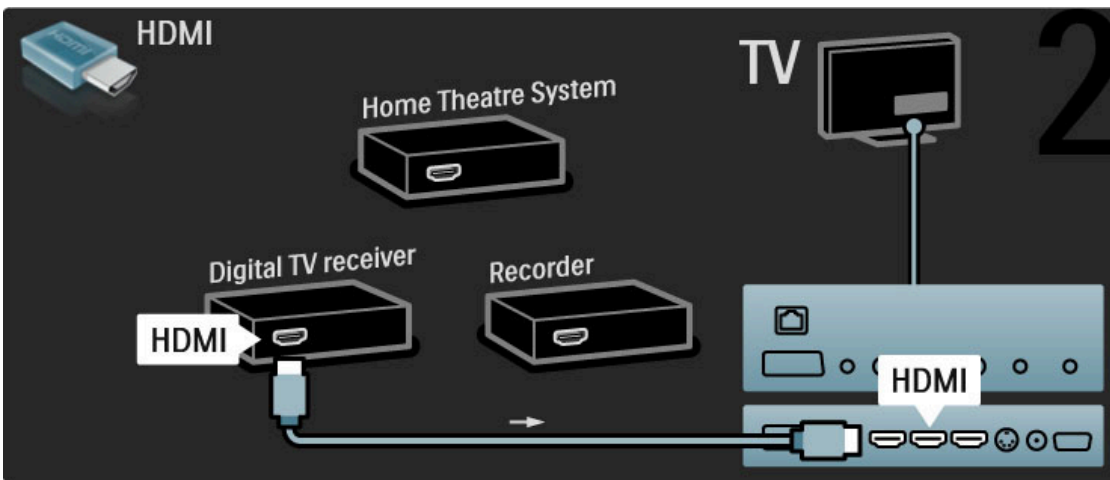

Then use an HDMI cable to connect the Disc Recorder to the TV.

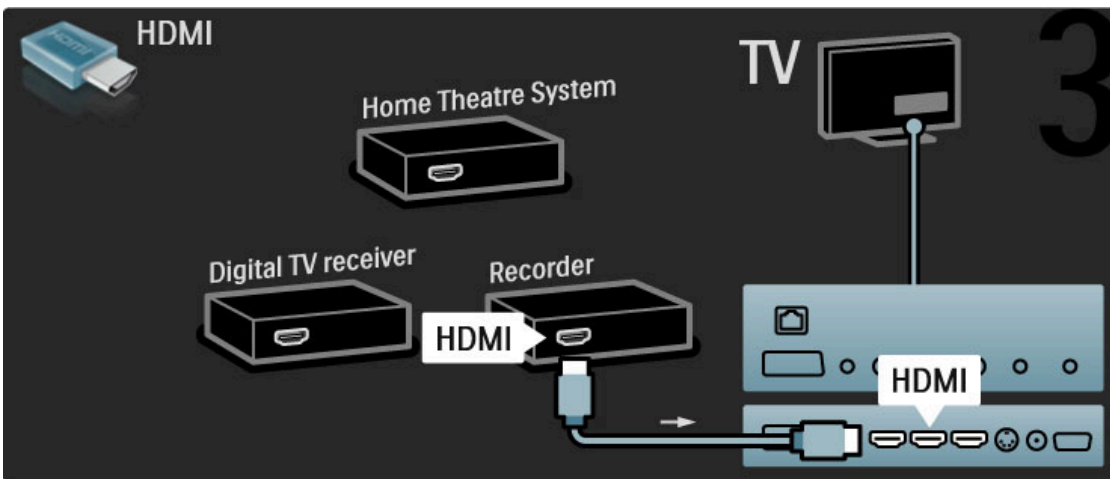

Then use an HDMI cable to connect the Home Theatre System to the TV.

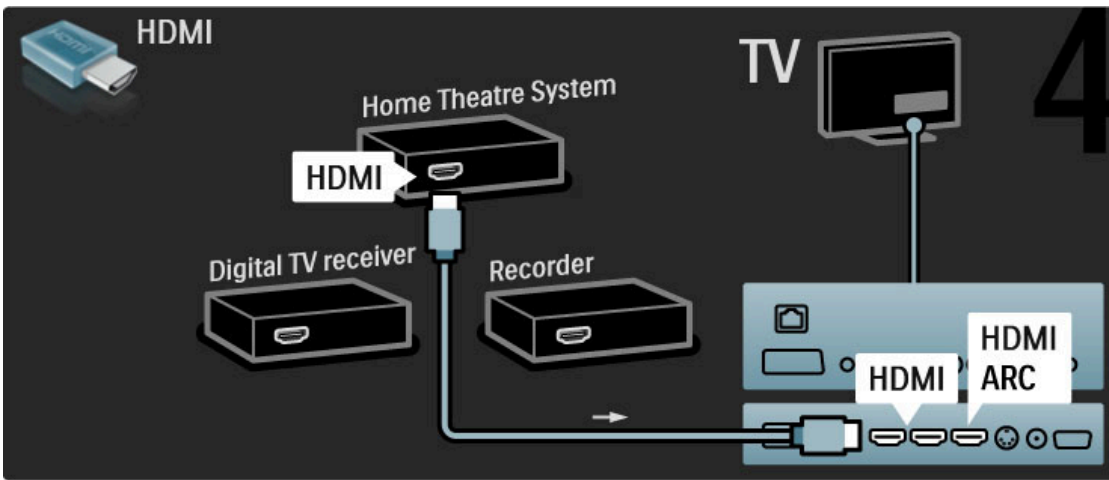

If you do not use the HDMI-ARC connection on the TV and the device, add a digital audio cable (cinch coaxial).

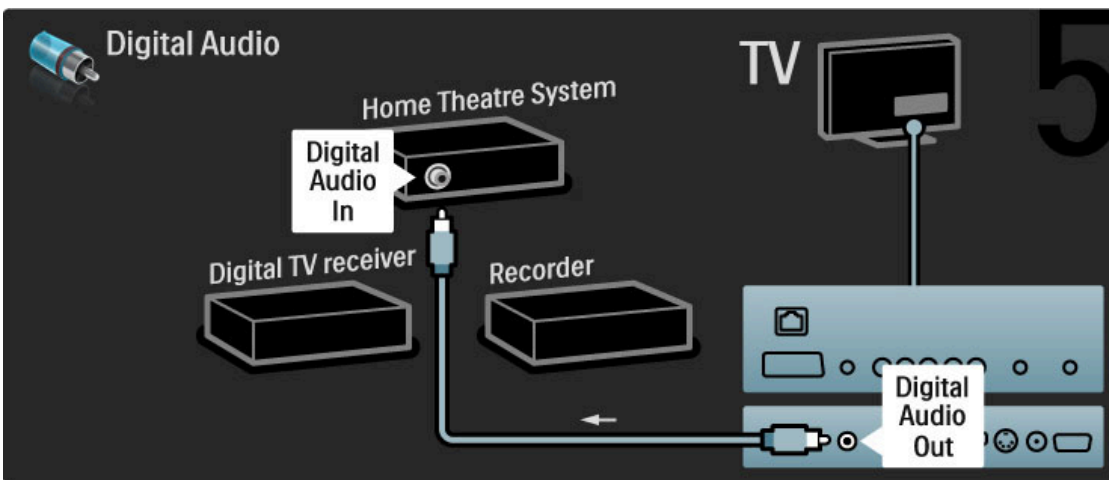

Digital HD receiver

If you use a digital receiver to watch TV (a set top box - STB) and you do not use the remote control of the TV, then switch off the automatic switch off. This will prevent the TV from switching off automatically after a 4 hour period without a key press on the remote control of the TV.

To switch off the automatic switch off, press the **green** key while you are watching TV channels and select **Auto switch off** and select **Off**.

First, use 2 antenna cables to connect the device to the TV.

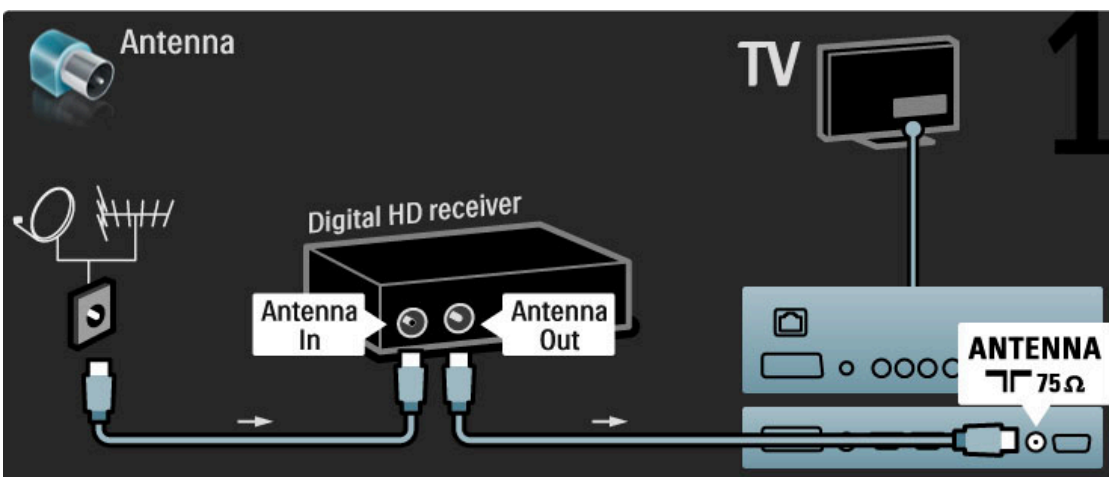

Use an HDMI cable to connect the device to the TV.

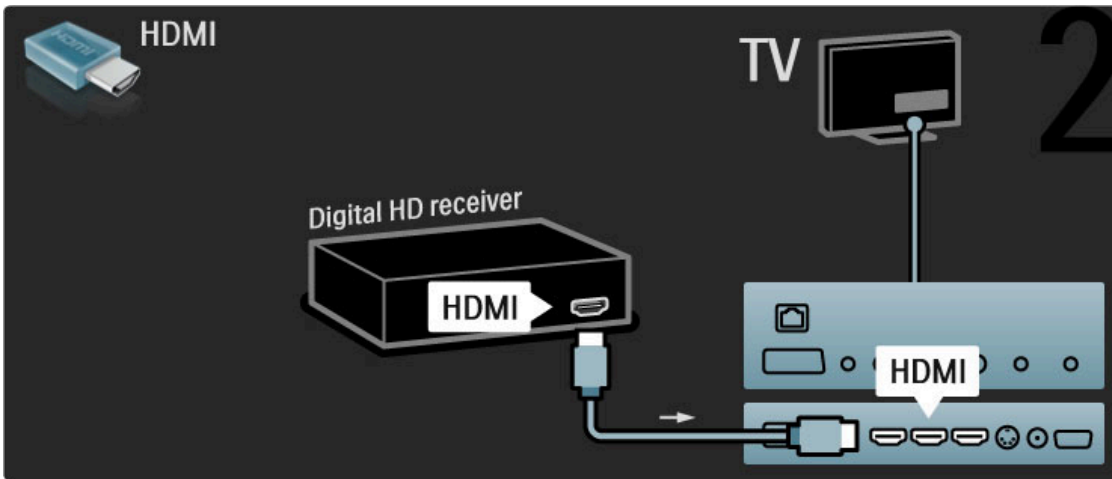

5.4 Connect more devices

Game

Connect a game console to the side or back of the TV. You can use an HDMI, YPbPr or SCART connection. If your game console only has Video (CVBS) and Audio L/R output, use a **Video Audio L/R to SCART** adapter to connect to the SCART connection.

Read more about Games in **Help > More TV > Games**.

Use an HDMI cable to connect the device to the side of the TV.

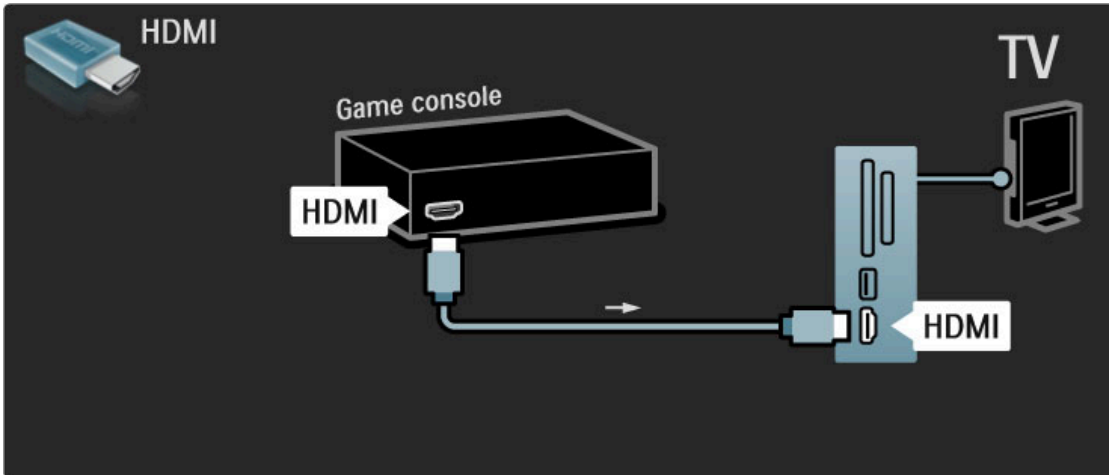

Or use a SCART adapter to connect the device to the TV.

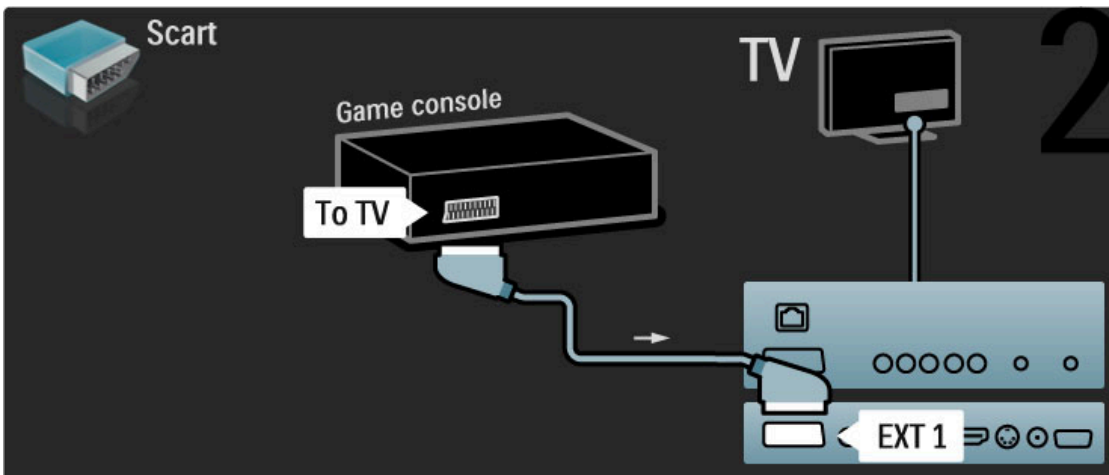

HD Game

Use an HDMI cable or YPbPr and Audio L/R cables to connect a High Definition game console to the TV.

To connect a HD Game console, read **Help > Connections > Connect more devices > Game**.

Photo camera

To view photos stored on your digital photo camera, you can connect the camera directly to the TV. Use the USB connection on the side of the TV to connect. Switch on the camera after you made the connection.

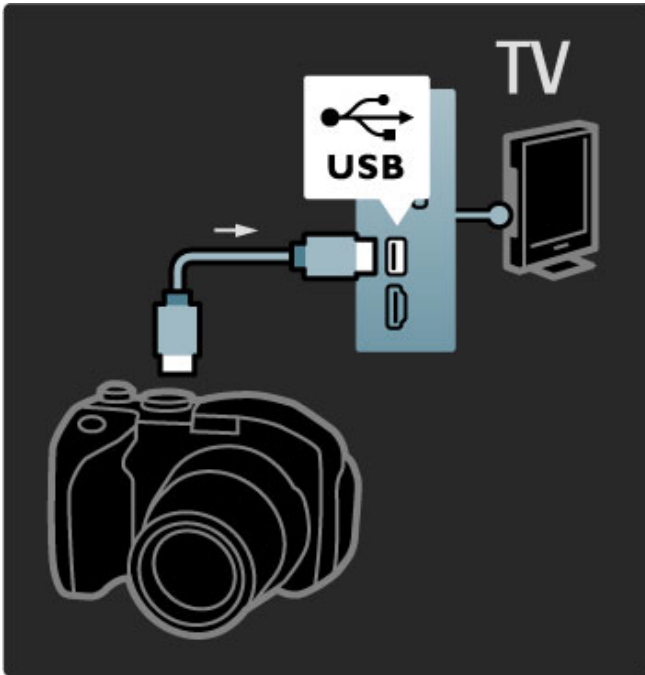

If the list with the content of the camera does not appear automatically, your camera might need to be set to transfer its content with PTP (Picture Transfer Protocol). Read the user manual of the digital photo camera.

Camcorder

Connect a camcorder to the side or back of the TV. You can use an HDMI, YPbPr or SCART connection. If your camcorder only has Video (CVBS) and Audio L/R output, use a **Video Audio L/R to SCART** adapter to connect to the SCART connection.

See the following pages to connect your camcorder.

Use an HDMI cable to connect the camcorder to the side of the TV.

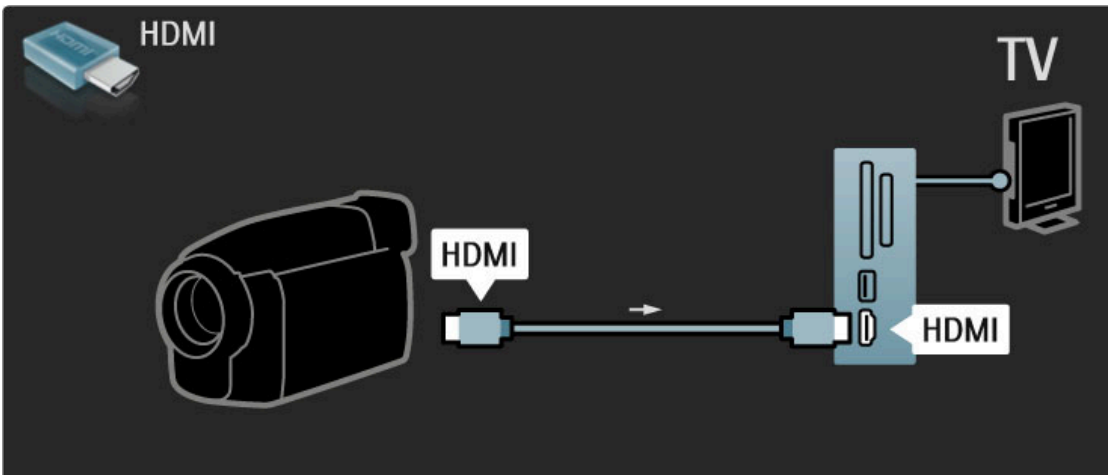

Or use a SCART adapter to connect the device to the TV.

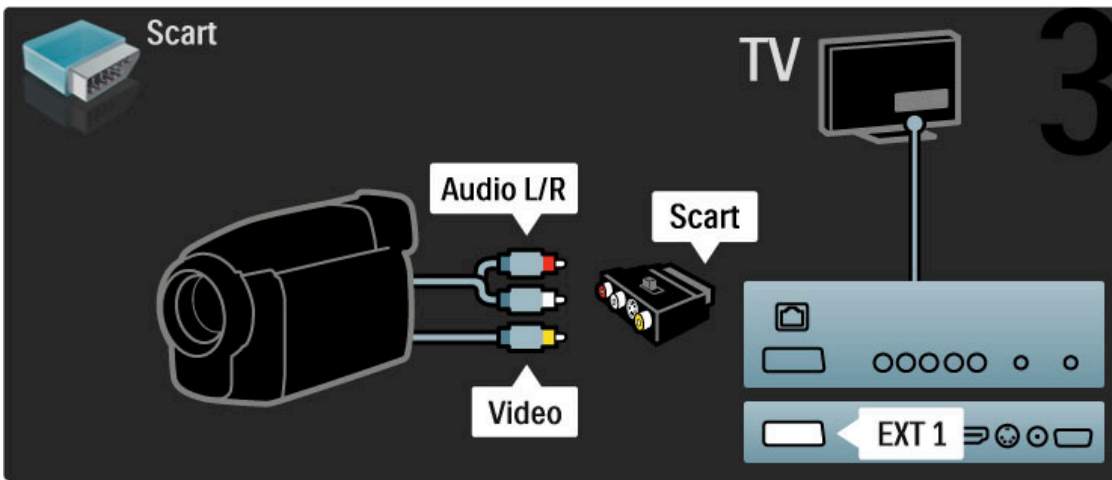

TV as PC monitor

You can connect the TV to your home network wireless. With Wi-Fi MediaConnect, you can use the TV as a PC monitor. Read [Help > Setup > Network > Wi-Fi MediaConnect](#).

Read on to connect a computer to the TV as a PC monitor wired. You can use a VGA cable or a DVI to HDMI adapter.

Use a VGA cable to connect the PC to the VGA connector and an audio L/R cable to connect the VGA Audio L/R to the back of the TV.

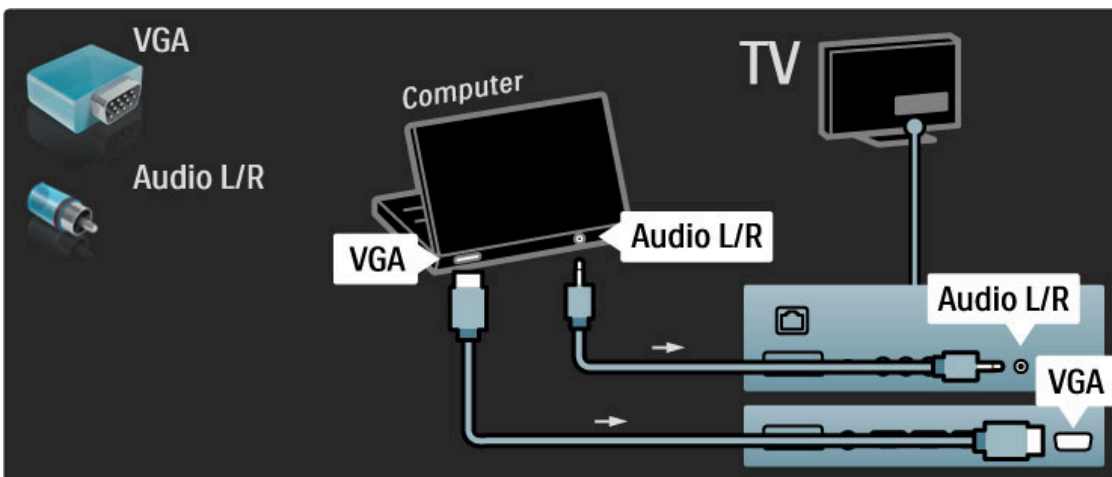

Use a DVI to HDMI adapter to connect the PC to HDMI and an audio L/R cable to connect the Audio L/R to the back of the TV.

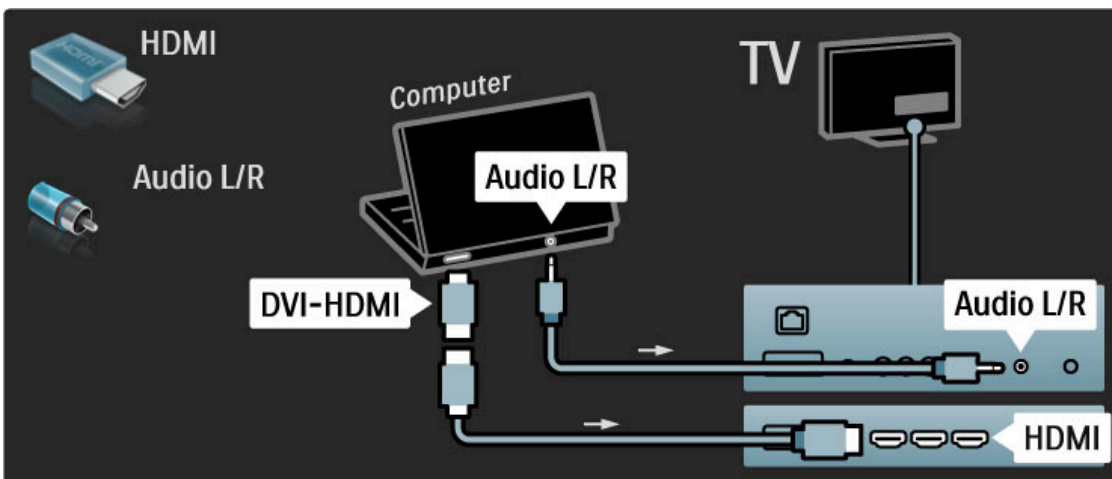

Ideal TV setting

Set the TV picture format to Unscaled for the sharpest picture quality. While watching TV, press **≡** **OPTIONS**, select **Picture format** and select **Unscaled**.

For a list of supported resolutions see **Help > Specifications > Display resolutions**.

Decoder

Use a SCART cable to connect a decoder that decodes analogue antenna channels. Use the **EXT1** connector on the back of the TV.

You have to assign the TV channel as a channel to be decoded. Then assign the connection where the decoder is connected. To assign this TV channel, press **🏠** > **Setup** > **Channel settings** > **Decoder**. Select **Channel** to set up the channel that you want to decode. Select **Status** to set the connection you use for the decoder.

5.5 Network

Wireless

To set up the wireless network connection, read **Help > Setup > Network**.

Wired

To set up the wired network connection, read **Help > Setup > Network**

Connect the router to the TV with a network cable. To fulfil EMC regulations, use a shielded FTP Cat. 5E Ethernet cable.

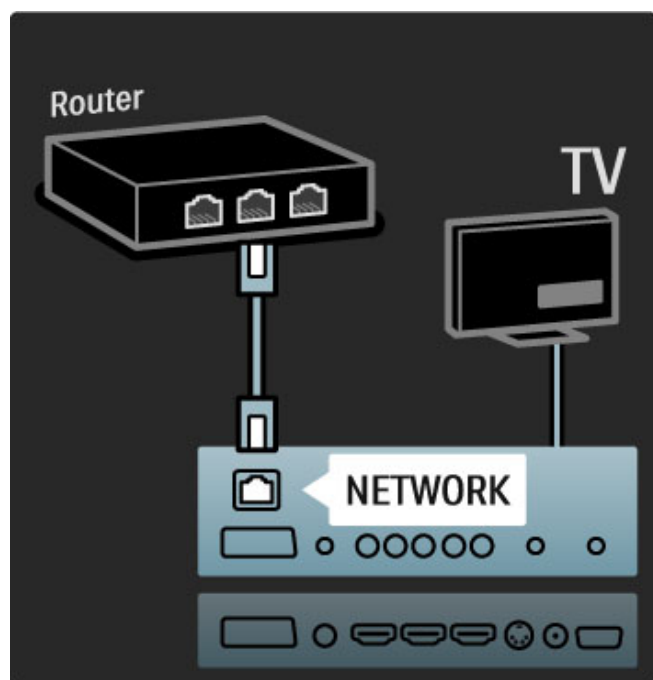

5.6 SD card

Memory size

To store videos downloaded from a Video store on Net TV, you need to insert an SD memory card into the TV SD card slot. Once formatted, leave the card permanently in the slot.

SD memory card size

Use a SD HC (High Capacity) memory card with at least 4GB of storage capacity.

For high-definition (HD) video, use an SD card with at least 8GB of storage capacity. Use a speed class 2 card or more.

Read more about renting videos in **Help > More TV > Net TV > Video stores**.

Insert the card

Make sure to unlock the SD memory card before you insert it.

To format the SD card, switch on the TV and insert the SD card into the SD card slot. The TV will automatically start formatting. Leave the SD card permanently in the slot.

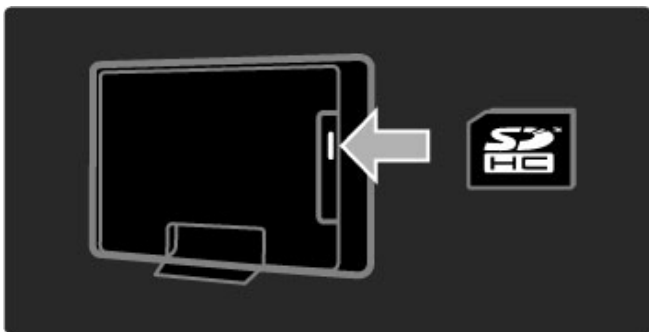

5.7 Common interface CAM

CAM

Scrambled digital TV channels can be decoded with a Conditional Access Module (CAM). Digital TV service operators provide the CAM when you subscribe to their services. Contact a digital TV service operator for more information and to see terms & conditions.

Insert a CAM

Switch off the TV before inserting a CAM. Look on the CAM for the correct method of insertion. Incorrect insertion can damage the CAM and the TV.

Look for the common interface slot on the back of the TV. Gently insert the CAM as far as it will go and leave it in the slot permanently.

It can take a few minutes before the CAM is activated. Removing the CAM will deactivate the service on TV.

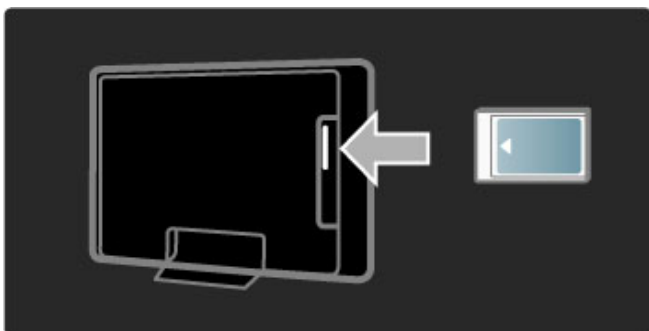

Watching a CAM service

If a CAM is inserted and subscription fees have been paid, the TV shows the programme from the digital TV service provider. The applications, their function, the content and the onscreen messages all come from the CAM service.

CAM settings

To set passwords or PIN codes for the CAM service, press **⬆** > **Setup** > **Channel settings** > **Common Interface**. Select the CAM provider and press **OK**.

CI+

This TV can handle the CI+ conditional access.

CI+ allows service providers to offer premium HD digital programmes like movies and sports with a high level of copy protection.

To insert a CI+ CAM, read chapter **CAM - Conditional Access Module**.

5.8 3D

3D

This TV is prepared for the 3D Full HD accessory PTA02 (sold separately).

PTA02 Installation

- 1 Switch off the TV.
- 2 Connect the 3D transmitter to the 3D connection **3D Out** on the back of the TV.

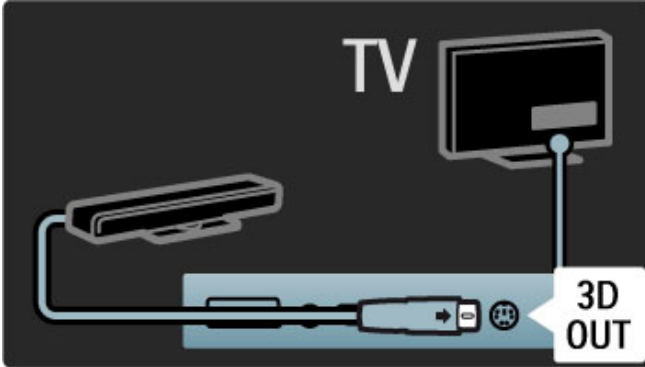

- 3 Install the 3D transmitter on the top or at the bottom of the TV. Make sure to point the transmitter directly to where you sit to watch TV.

The small window in the middle of the glasses receives the 3D signals from the transmitter.

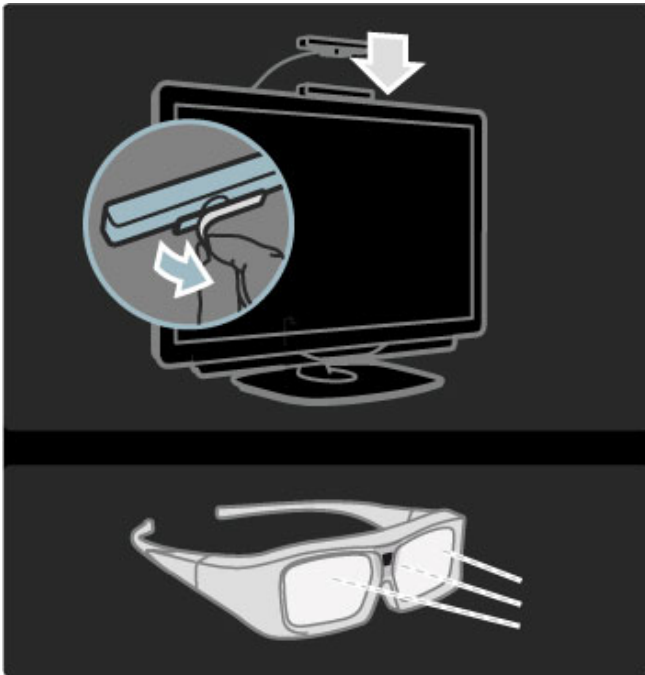

Update the TV software

To prepare your TV for 3D watching, you must update the TV software.

- 1 Switch on the TV.
- 2 Plug in the USB device in the **USB** connection at the side of the TV.

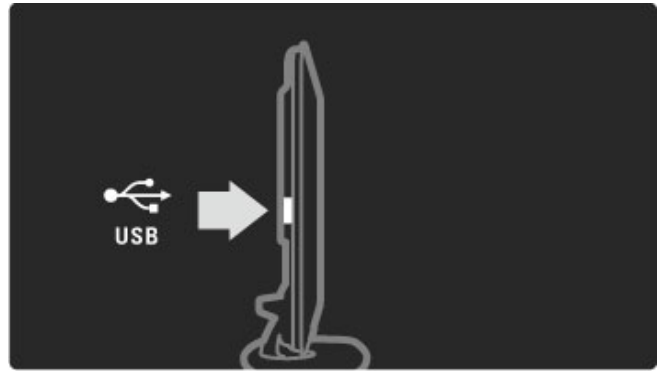

- 3 The software update will start automatically and during the update the TV might switch off and on again. Do not press any key on the remote control and wait until the message 'Operation Successful' appears.
- 4 Unplug the USB device and switch the TV off and back on again.

Your TV is ready to watch 3D.

6 Troubleshooting

6.1 Contact information

If the advice and suggestions in Troubleshooting do not help resolve the problem, try switching the TV off and back on again.

Warning

If your TV breaks down, **NEVER** try to repair the TV yourself.

Consumer Care

If the TV problem is not solved you can call the Philips Consumer Care hotline in your country. Look up the TV model and serial number before you call. Find the telephone number on the documentation that came with the TV. Or consult our website www.philips.com/support

TV model number and serial number

Find these numbers on the packaging label or on the type label on the back or bottom of the TV.

6.2 TV and remote control

The TV does not switch on

- Switch the TV off and on again with the switch on the bottom of the TV.
- Check the power cable connection.
- Try using the keys on the TV to switch on.

The TV does not switch on from standby

- Check that the batteries of the remote control are not empty or weak. Check their + / - orientation.
- Try using the keys on the TV to switch on.

The TV does not respond to the remote control

- Check that the batteries of the remote control are not empty or weak. Check their + / - orientation.
- Clean the remote control and TV sensor lens.

- During start-up, which can take up to two minutes with connected devices, the TV and some external devices do not immediately respond to commands from the remote control. The device is functioning normally and is not broken.

The TV switches off and the red light flashes

- Switch the TV off and on again with the switch at the bottom of the TV. Check if there is enough space for ventilation. Wait until the TV has cooled down.

If the TV does not restart from standby and the light flashes again, call Consumer Care.

You forgot your code to unlock Child lock?

Read **Help > More TV > Locks and timers > Child lock**.

6.3 TV channels

Some TV channels are gone

- Check if the correct list is selected in the Channel list. Press **Q FIND** to open the Channel list, then press **☰ OPTIONS** and select the list you need with **Select list**.

- A channel could be hidden in the Channel list. Read more about Channel list in **Help > Use your TV > Watch TV > Channel list**.

No digital channel found during installation

- Check if the TV supports DVB-T or DVB-C in your country. Check the 'Digital TV Country Compatibility' sticker on the back of the TV.

6.4 Picture and sound

No picture

- Check if the antenna is connected properly.
- Check if the correct device is selected and connected properly.
- Check the contrast or brightness setting in **🏠 > Setup > TV settings > Picture > Contrast** or **Brightness**.

The picture is poor

- Bad weather can influence the picture quality.
- Check if the antenna is connected properly.
- Non-earthed audio devices, neon lights, high buildings or mountains can influence the picture quality. Try to improve the picture by changing the position of the antenna or placing devices away from the TV.

- Check that the correct TV system is chosen in the Manual installation menu.
- If only a certain channel is poor, try to fine tune this channel with the Fine tune menu.

Read **Help > Setup > Channels > Manual installation - Analogue**.

The picture has poor colour

- Check the colour settings in **🏠 > Setup > TV settings**. Or press **☰ OPTIONS** to select a **Smart picture** setting.

Picture delay when a game console is connected

- To prevent picture delay, press **☰ OPTIONS**, select **Smart picture > Game**.

The TV does not remember my settings when I switch it back on

- Check whether the TV is set to the **Home** location. Press **🏠 > Setup > TV settings > Preferences > Location**.

The picture does not fit the screen

- Press **☰ OPTIONS**, **Picture format** and select **Auto fill**.

The picture position on screen is not correct

- To correct a shifted picture, press **☰ OPTIONS** and select **Picture shift**. Use the navigation keys to adjust the picture position. Press **OK** to stop Picture shift.

- If distorted screen edges are visible, press **🏠 > Setup > TV settings > Picture > Screen edges** and use the slider bar to enlarge the picture slightly.

There is a picture but no sound

- Check the volume is not set to 0.
- Check the sound has not been muted with **🔇**.
- Check that all cables are connected properly.
- If no sound signal is detected, the TV automatically switches off sound. This is proper operation and is not a malfunction.

The sound is poor

- Try any Smart sound setting, press **☰ OPTIONS**, **Smart sound**.
- Check that the sound is set to Stereo.

The sound comes from one speaker only

- Check the Balance setting. Press **🏠 > Setup > TV settings > Sound > Balance**. Use the slider bar to set the balance.

Sound delay

- If there is an audio to video sync mismatch when sound comes from a Home Theatre System, an audio sync delay needs to be set up. Read more about Audio to Video sync in **Help > Setup > Devices > Audio to Video sync**.

6.5 Devices

HDMI connections

- The HDMI-HDCP procedure might take a few seconds before the picture from a device appears.
- If the TV does not recognise the device and there is no picture, try switching from one device to another and back again to restart the HDCP procedure. Or switch the device off and back on again.

- If sound interruptions occur persistently, see the user manual of the device to check the output settings. If that does not help, connect an additional audio cable.
- If a DVI to HDMI adaptor is used, check that an additional audio connection is in place to complete the DVI connection.

EasyLink HDMI-CEC

- Check if the connected device supports the HDMI-CEC standard and is properly set up. Read the user manual that comes with the device.
- Check if the HDMI cable is properly connected.

- Check if EasyLink on the TV and device is switched on.
- Make sure that the System audio control in your HDMI-CEC audio devices is properly set up. Read the user manual that comes with your audio device.

PC display

- The refresh rate of a PC connected to the TV with VGA or DVI to HDMI adapter should set to 60Hz.
- Check that the correct resolution mode is selected on your PC. See the list in **Help > Specifications > Display resolutions**.

6.6 Videos, photos and music

The files on my USB device are not shown

- Set your device (camera) to 'Mass Storage Class' compliant.
- The USB device may need specific driver software.

Unfortunately, this software cannot be downloaded to your TV.

- Not all audio and picture files are supported. See the list in **Help > Specifications > Multimedia**.

Files from a USB device do not play back smoothly

- The transfer performance of the USB device limits the transfer rate.

The files on my PC are not shown

- To look for files on your home network with Browse PC, your PC media server software should be set up to share the files with the TV. See the list of compatible Media server software in **Help > Specifications > Multimedia**.

6.7 Network

Wireless network not found or distorted

- Microwave ovens, Dect phones or other WiFi 11b devices in your neighbourhood might disturb the wireless network.
- Make sure that the firewalls in your network allow access to the TV wireless connection.

- If the wireless network does not work properly in your home, try the wired network installation. Read **Help > Setup > Network > Wired installation**.

Net TV does not work

- If the connection to the router is OK, check the router connection to the Internet.

Browse PC or Net TV work slow

- Look in your wireless router's user manual for information on indoor range, transfer rate and other factors of signal quality.
- You need a high-speed (broadband) Internet connection for your router.

7 Specifications

7.1 Software

Software version

To view the current TV software version, press **⏠** > **Setup** > **Software settings** and press **OK**. Select **Current software info** and read **Version**.

Open source software

This television contains open source software. Philips hereby offers to deliver, upon request, a copy of the complete corresponding source code for the copyrighted open source software packages used in this product for which such offer is requested by the respective licences.

This offer is valid up to three years after product purchase to anyone in receipt of this information. To obtain the source code, please contact open.source@philips.com.

If you prefer not to use email or if you do not receive a confirmation receipt within a week after mailing to this email address, please write in English to . . .

Open Source Team, Philips Electronics
Intellectual Property and Standards
P.O. Box 220
5600 AE Eindhoven
The Netherlands

Read the Open Source Licences in **Help** > **To begin** > **Open Source Licences**.

7.2 Environmental

Energy saving

Light sensor

To save energy, the built-in ambient light sensor lowers the brightness of the TV screen when the surrounding light darkens.

Energy saving

The energy saving Smart picture setting, combines several TV settings that result in saving energy.

Low standby power

The class-leading and highly advanced power circuitry brings down the power consumption of the TV to an extremely low level, without losing out on the constant Standby functionality.

Power management

The advanced power management of this TV ensures the most efficient use of energy. You can check how your personal TV settings, the level of brightness in current onscreen pictures, and the surrounding light conditions determine the relative power consumption.

To check the relative power consumption, press **⬆** > **Setup** and press **▶**. Select **Watch demos** > **Active control** and press **OK**. Select a Smart setting to check the corresponding values.

End of use

Disposal of your old product and batteries

Your product is designed and manufactured with high quality materials and components, which can be recycled and reused.



When this crossed-out wheeled bin symbol is attached to a product it means that the product is covered by the European Directive 2002/96/EC.



Please inform yourself about the local separate collection system for electrical and electronic products.

Please act according to your local rules and do not dispose of your old products with your normal household waste. Correct disposal of your old product helps to prevent potential negative consequences for the environment and human health.

Your product contains batteries covered by the European Directive 2006/66/EC, which cannot be disposed with normal household waste.



Please find out for yourself about the local rules on separate collection of batteries because correct disposal will help to prevent negative consequences for the environment and human health.

7.3 Power and reception

Power

Product specifications are subject to change without notice. For more specification details of this product, see www.philips.com/support.

Power

- Mains power : AC 220-240V +/-10%
- Ambient temperature : 5°C to 35°C
- Standby power consumption : < 0.15W
- Power saving features : Light sensor, Eco mode, Picture mute (for radio), Auto switch-off timer, Eco settings menu.

Reception

- Aerial input : 75 ohm coaxial (IEC75)
- Tuner bands : Hyperband, S-Channel, UHF, VHF
- DVB : DVB-T (terrestrial, antenna) COFDM 2K/8K, DVB-C (cable) QAM

- Analogue video playback : NTSC, SECAM, PAL
- Digital video playback : MPEG2 SD/HD (ISO/IEC 13818-2), MPEG4 SD/HD (ISO/IEC 14496-10)
- Digital audio playback (ISO/IEC 13818-3)
- See selected countries on the TV type plate

- Satellite aerial input : 75 ohm F-type
- Input frequency range : 950 to 2150MHz
- Input level range : 25 to 65 dBm
- DVB-S/S2 QPSK, symbol rate 2 to 45M symbols, SCPC and MCPC

- Preset for satellites : Astra (19.2°E), Astra (23.5 °E), Astra (28.2 °E), Hotbird (13.0 °E), TürkSat (42.0 °E)
- Astra HD+ support
- LNB : DiSEqC 1.0, 1 to 4 LNBs supported, Polarity selection 14/18V, Band selection 22kHz, Tone burst mode, LNB current 300mA max
- See selected countries on the TV type plate

7.4 Display and sound

Display / Picture

- Diagonal size :
 - 40PFL9705 : 102cm / 40"
 - 46PFL9705 : 116cm / 46"
- Picture enhancement :
 - Perfect Pixel HD Engine
 - LED Pro
 - 400Hz Clear LCD*

- Display type : LCD Full HD, 2D segmented LED backlight
- Panel resolution : 1920 × 1080p
- Color processing : 2250 trillion colors 17bit RGB
- Brightness : 500 cd/m²
- Dynamic contrast : 10.000.000:1
- Response time (typical) : 0,5 (BEW equiv.) ms

* 400Hz Clear LCD : displays 400 scenes per second by combining advanced 200Hz technology with scanning backlight @ 50% dutycycle.

Sound

- Output power (RMS) : 2 × 15W
- Dolby Digital Plus, Dolby Pulse - Dolby and the double-D symbol are registered trademarks of Dolby Laboratories.
- Speaker types : 2 dome tweeters, 2 woofers

7.5 Display resolutions

Video formats

Resolution — Refresh rate

- 480i - 60 Hz
- 480p - 60 Hz
- 576i - 50 Hz
- 576p - 50 Hz
- 720p - 50 Hz, 60 Hz
- 1080i - 50 Hz, 60 Hz
- 1080p - 24 Hz, 25 Hz, 30 Hz
- 1080p - 50 Hz, 60 Hz

Computer formats

Resolution — Refresh rate

- 640 × 480p — 60 Hz (VGA/HDMI)
- 800 × 600p — 60 Hz (VGA/HDMI)
- 1024 × 768p — 60 Hz (VGA/HDMI)
- 1280 × 768p — 60 Hz (VGA/HDMI)
- 1360 × 765p — 60 Hz (VGA/HDMI)
- 1360 × 768p — 60 Hz (VGA/HDMI)
- 1280 × 1024p — 60 Hz (HDMI)
- 1920 × 1080i — 60 Hz (HDMI)
- 1920 × 1080p — 60 Hz (HDMI)

7.6 Multimedia

Connections

- USB 2.0
- Ethernet LAN RJ-45
- Wi-Fi 802.11b/g/n (built-in)

Supported USB file systems

- FAT 16, FAT 32, NTFS

Playback formats

- Containers : MPEG Program Stream, MPEG Transport Stream, AVI, MPEG-4, Matroska, Windows Media, ASF
- Video Codecs : MPEG-1, MPEG-2, MPEG-4 Part 2, MPEG-4 AVC (H264), WMV9
- Audio Codecs : MP3, AAC, HE-AAC V1, HE-AAC V2, WMA, AC3
- Image Codecs : JPEG
- Limitations : WMA (V2 up to V9.2), MPEG-4 AVC (up to level 4.0)

Supported DLNA media server software (DMS)

- Windows Media Player 11 (for Microsoft Windows XP, Vista or Windows 7)
- TVersity 1.9.3 (pro) (for Windows XP)
- Twonky Media — PacketVideo 4.4.9 (for PC and Intel MacOX)
- Nero 9 — Nero MediaHome (for Microsoft Windows XP)
- Sony Vaio Media Server (for Microsoft Windows XP or Vista)

- Sony PS3 media server (for Windows XP)
- Google Media Server (Google desktop) (for Windows XP)
- DiXiM (for Windows XP)
- Macrovision Network Media Server (for Windows XP)
- Philips NAS SPD8020 (v. 1.2.9.47)
- Fuppes (for Linux)
- uShare (for Linux)

Supported DLNA mobile devices (DMS/DMC)

- Nokia N78, N80, N81, N82, N92, N93, N93i, N95, N96, N800, N810
- Samsung SGH-i780

ESD regulations

This apparatus meets performance criteria A for ESD. In case the apparatus does not recover in DLNA mode due to electrostatic discharge, user interference is required.

7.7 Connectivity

TV Rear

- EXT1 Scart : Audio L/R, CVBS in, RGB
 - EXT2 Scart : Audio L/R, CVBS in, RGB
 - EXT3 : Y Pb Pr, Audio L/R
 - VGA (D-sub 15), Audio In (stereo mini-jack 3.5mm)
 - HDMI 1 - ARC in (HDMI v1.4)
 - HDMI 2 in (HDMI v1.3)
 - HDMI 3 in (HDMI v1.3)
 - Audio In (DVI to HDMI)(stereo mini-jack 3.5mm)
-
- Audio Out L/R — display synchronised (coaxial-cinch-S/PDIF)
 - Headphones (stereo mini-jack 3.5mm)
 - Network — (RJ45)
 - 3D Out

TV Side

- HDMI Side in (HDMI v1.3)
- 2x USB
- Common interface slot (CAM)
- SD card slot (SD High Capacity)(as Video stores memory)

7.8 Dimensions and weights

40PFL9715

Width 955 mm

Height 596 mm

Depth 69mm

Weight ± 14 kg

. . . with TV stand

Height 632 mm

Depth 240 mm

Weight ± 16 kg

46PFL9715

Width 1088 mm

Height 671 mm

Depth 69 mm

Weight ± 19 kg

. . . with TV stand

Height 707 mm

Depth 260 mm

Weight ± 22 kg

UMv 3104 327 0053.2 - 110331

Index

A

Adjust menu 21
Age rating, satellite 29
Ambilight colour 43
Ambilight, setup 43
Ambilight, switch on 43
Audio Description 51
Audio Out delay 50
Auto switch off 42

B

Balance 41
Black bars 25

C

CAM 70
Channel list copy 44
Channel list, options 23
Channel, favourite 24
Channel, rename 24
Channel, reorder 23
Channel, switch 23
Channel, update 44
CI+ 70
Clock 45
Common interface slot 70
Component Video YPbPr 54
Connections 54
Consumer Care 72

D

Device, add 21
Device, remove 21
Device, rename 21
Device, reorder 21
Digital Text 35
DVB 44
DVD player, connect 56
DVI to HDMI adapter 54

E

EasyLink, remote control 50
Eco settings 41
Encryption method 48
ESD 84

F

Find 21

G

Game console 39
Gamma 41

H

HD TV 6
HD video clip 6
HDMI ARC 54
HDMI connection 54
Headphone volume 41
Help, Search 17
Home menu 21
Home network 48

I

Infrared sensor 19
Interactive TV 34

K

Keyboard, on screen 24

Index

L

Lock code 40

M

Media server software 84
Music with photos 37

N

Net TV 32
Net TV, connection 32
Net TV, open 32
Network, wired connection 68
Network, wired installation 49
Network, wireless installation 48

O

One Touch Play 19
Online, rental video 33
Open source software 79
Options menu 22

P

Parental rating 40
Parental rating, satellite 29
PC, browse 37
PC, connect 37
PC, monitor 66
Perfect Pixel HD Engine 41
Photos 37
Photos, slideshow 37
Picture settings 41
Picture shift 22
Play videos 37
Power consumption 80
Product recycling 80

R

Radio channels 23
Reception quality 45
Router 48

S

Satellite channel, favourite 29
Satellite channel, remove 46
Satellite channel, rename 28
Satellite channel, reorder 28
Satellite channel, signal 47
Satellite channel, update 47
Satellite, add 46
Satellite, installation 46
Satellite, LNB 46
Satellites, search for 46
Screen edges 41
SD card, install 69
SD memory card 33
Select list 23
Smart setting, sound 25
Smart settings, reset 41
Software, current version 52
Software, Internet update 52
Software, USB update 52
Sound settings 41
Subtitle, auto shift 50
Subtitles, language 31
Subtitles, On during mute 31
Surround mode 19
Surround sound 22
System standby 19

T

Text, dual screen 35
Text, freeze 35
Text, setup 35

Text, T.O.P. overview 35
TV network name 49
TV tour 5

U

Universal access 51
USB, browse 37

V

Video (CVBS) connection 55
Video selection 23

W

Wall colour 43
Watch satellite 28
Watch TV 23
WEP security encryption 48
WPA security encryption 48
WPS (Wi-Fi Protected Setup) 48

Europe

CE Declaration of conformity

English

Hereby, Philips Innovative Applications N.V. declares that this television is in compliance with the essential requirements and other relevant provisions of Directive 1999/5/EC.

Deutsch

Hiermit erklärt Philips Innovative Applications N.V. dass sich das Fernsehgerät in Übereinstimmung mit den grundlegenden Anforderungen und den übrigen einschlägigen Bestimmungen der Richtlinie 1999/5/EG befindet.

Français

Par la présente Philips Innovative Applications N.V. déclare que cet appareil de télévision est conforme aux exigences essentielles et aux autres dispositions pertinentes de la directive 1999/5/CE.

Nederlands

Hierbij verklaart Philips Innovative Applications N.V. dat deze televisie in overeenstemming is met de essentiële eisen en de andere relevante bepalingen van richtlijn 1999/5/EG.

Español

Por medio de la presente Philips Innovative Applications N.V. declara que el televisor cumple con los requisitos esenciales y cualesquiera otras disposiciones aplicables o exigibles de la Directiva 1999/5/CE.

Italiano

Con la presente Philips Innovative Applications N.V. dichiara che questo televisore è conforme ai requisiti essenziali ed alle altre disposizioni pertinenti stabilite dalla direttiva 1999/5/CE.

Português

Philips Innovative Applications N.V. declara que este televisor está conforme com os requisitos essenciais e outras disposições da Directiva 1999/5/CE.

Ελληνικά

ΜΕ ΤΗΝ ΠΑΡΟΥΣΑ Η Philips Innovative Applications N.V. ΔΗΛΩΝΕΙ ΟΤΙ Η ΤΗΛΕΟΡΑΣΗ ΣΥΜΜΟΡΦΩΝΕΤΑΙ ΠΡΟΣ ΤΙΣ ΟΥΣΙΩΔΕΙΣ ΑΠΑΙΤΗΣΕΙΣ ΚΑΙ ΤΙΣ ΛΟΙΠΕΣ ΣΧΕΤΙΚΕΣ ΔΙΑΤΑΞΕΙΣ ΤΗΣ ΟΔΗΓΙΑΣ 1999/5/ΕΚ.

Svenska

Härmed intygar Philips Innovative Applications N.V. att denna TV står i överensstämmelse med de väsentliga egenskapskrav och övriga relevanta bestämmelser som framgår av direktiv 1999/5/EG.

Norsk

Philips Innovative Applications N.V. erklærer herved at utstyret TV er i samsvar med de grunnleggende krav og øvrige relevante krav i direktiv 1999/5/EF.

Dansk

Undertegnede Philips Innovative Applications N.V. erklærer herved, at dette TV overholder de væsentlige krav og øvrige relevante krav i direktiv 1999/5/EF.

Suomi

Philips Innovative Applications N.V. vakuuttaa täten että tämä televisio on direktiivin 1999/5/EY oleellisten vaatimusten ja sitä koskevien direktiivin muiden ehtojen mukainen.

Polski

Firma Philips Innovative Applications N.V. niniejszym oświadcza, że 'Telewizor' jest zgodny z zasadniczymi wymogami oraz pozostałymi stosownymi postanowieniami Dyrektywy 1999/5/EC.

Magyar

Alulírott, Philips Innovative Applications N.V. nyilatkozom, hogy a televízió megfelel a vonatkozó alapvető követelményeknek és az 1999/5/EC irányelv egyéb előírásainak.

Česky

Philips Innovative Applications N.V. tímto prohlašuje, že tento televizor je ve shodě se základními požadavky a dalšími příslušnými ustanoveními směrnice 1999/5/ES.

Slovensky

Philips Innovative Applications N.V. týmto vyhlasuje, že tento televizor spĺňa základné požiadavky a všetky príslušné ustanovenia Smernice 1999/5/ES.

Slovensko

Philips Innovative Applications N.V. izjavlja, da je ta televizor v skladu z bistvenimi zahtevami in ostalimi relevantnimi določili direktive 1999/5/ES.

Eesti

Käesolevaga kinnitab Philips Innovative Applications N.V. seadme Teler vastavust direktiivi 1999/5/EÜ põhinõuetele ja nimetatud direktiivist tulenevatele teistele asjakohastele sätetele.

Latviski

Ar šo Philips Innovative Applications N.V. deklarē, ka 'Televizors' atbilst Direktīvas 1999/5/EK būtiskajām prasībām un citiem ar to saistītajiem noteikumiem.

Lietuvių

Šiuo Philips Innovative Applications N.V. deklaruoją, kad šis 'Televizorius' atitinka esminius reikalavimus ir kitas 1999/5/EB Direktyvos nuostatas.

Malti

Hawnhekk, Philips Innovative Applications N.V. jiddikjara li dan 'Television' jikkonforma mal-htigijiet essenzjali u ma provvedimenti oħrajn relevanti li hemm fid-Direttiva 1999/5/EC.

Íslenska

Hér með lýsir Philips Innovative Applications N.V. yfir því að 'Television' er í samræmi við grunnkröfur og aðrar kröfur, sem gerðar eru í tilskipun 1999/5/EC.

A copy of the Declaration of Conformity is available at :
<http://www.philips.com/support>



This equipment may be operated in the following European countries ...

AT	BE	BG	CH	CY	CZ
DE	DK	EE	ES	FI	FR
GB	GR	HU	IE	IS	IT
LI	LT	LU	LV	MT	NL
NO	PL	PT	RO	SE	SK
SL	TR				

This equipment can be operated in other non-European countries.

Italia

Sistema TV wireless
Informazioni sulle normative applicabili

Per il mercato italiano

- uso privato: Decreto legislativo .259 1/8/2003 Codice delle comunicazioni elettroniche. In particolare, l'articolo 104 specifica i casi in cui occorre richiedere un'autorizzazione generale, mentre l'Art. 105 indica i casi in cui l'utilizzo è libero
- regolamentazione della fornitura dell'accesso RLAN del pubblico alle reti e ai servizi pubblici di comunicazione elettronica (es. sistema TV wireless). Decreto ministeriale 28/5/2003 e relative modifiche, e Art. 25 (autorizzazione generale per reti e servizi di comunicazione elettronica) del Codice delle comunicazioni elettroniche
- uso privato: Decreto ministeriale 12/7/2007



Contact information

Argentina	0800 8888 7532 (gratuito)	Magyarország	06 80018 189 (Ingyenes hívás)
België / Belgique	0800 80 190 (gratis / gratuit) CHAT www.philips.com/support	Nederland	0800 023 0076 (gratis) CHAT www.philips.com/support
Brazil	0800 701 0203 Sao Paulo (11) 2121 0203	Norge	2270 8111 (lokalsamtale) CHAT www.philips.com/support
България	+3592 489 99 96 (Местен разговор)	Österreich	0800 180 016 (kostenlos) CHAT www.philips.com/support
Česká republika	800 142840 (Bezplatný hovor)	Polska	022 3491504 (połączenie lokalne)
China / 中国	4008 800 008	Portugal	800 780 903 (grátis) CHAT www.philips.com/support
Danmark	3525 8759 (lokalt opkald) CHAT www.philips.com/support	România	0800 894910 (gratis)
Deutschland	0800 000 7520 (kostenlos) CHAT www.philips.com/support	Россия	- Москва (495) 961-1111 - Местный звонок - 8-800-200-0880 - Местный звонок CHAT www.philips.com/support
Ελλάδα	0 8000 3122 1280 Κλήση χωρίς χρέωση	Suisse / Schweiz / Svizzera	0800 002 050 (kostenlos / gratuit / gratuito)
España	900 800 655 (gratuito) CHAT www.philips.com/support	Србија	+381 114 440 841 (Lokalni poziv)
Estonia	6008600 (local)	Slovakia	0800 004537 (Bezplatný hovor)
France	0805 025 510 (gratuit) CHAT www.philips.com/support	Slovenija	00386 1 280 95 00 (Lokalni klic)
Hrvatska	01 6403 776 (Lokalni poziv)	Suomi	09 23113415 (paikallispuhelu) CHAT www.philips.com/support
Italia	800 088 774 (gratuito) CHAT www.philips.com/support	Sverige	08 5792 9100 (lokalsamtal) CHAT www.philips.com/support
Ireland	0160 11 161 (free)	Thailand / ประเทศไทย	66 2 652 8652
Northern Ireland	0800 055 6882	Türkiye	0800 261 3302 (Şehir içi arama) CHAT www.philips.com/support
Казакстан	007 727 250 66 17 (local)	United Kingdom	0800 331 6015 (toll free) CHAT www.philips.com/support
Latvia	527 37691 (local)		
Lithuania	67228896 (local)		
Luxembourg / Luxemburg	0800 26 550 (kostenlos / gratuit) CHAT www.philips.com/support		



Non-contractual images / Images non contractuelles / Außervertragliche Bilder
All registered and unregistered trademarks are property of their respective owners.

Specifications are subject to change without notice
Trademarks are the property of Koninklijke Philips Electronics N.V. or their respective owners
2011 © Koninklijke Philips Electronics N.V. All rights reserved

www.philips.com

Free Manuals Download Website

<http://myh66.com>

<http://usermanuals.us>

<http://www.somanuals.com>

<http://www.4manuals.cc>

<http://www.manual-lib.com>

<http://www.404manual.com>

<http://www.luxmanual.com>

<http://aubethermostatmanual.com>

Golf course search by state

<http://golfingnear.com>

Email search by domain

<http://emailbydomain.com>

Auto manuals search

<http://auto.somanuals.com>

TV manuals search

<http://tv.somanuals.com>