

Register your product and get support at  
[www.philips.com/welcome](http://www.philips.com/welcome)

SDV1121/27



---

EN User manual

---

# PHILIPS



# Contents

---

<b>1 Important</b>	4
Safety	4
Notice for USA	4
Notice for Canada	4
Recycling	4

---

<b>2 Your SDV1121</b>	5
Overview	5

---

<b>3 Get started</b>	5
Installation	5

---

<b>4 Set up the SDV1121</b>	6
For UHF reception	6
For VHF reception	6
Set up a digital tuner with this antenna	6

---

<b>5 Frequently asked questions</b>	7
-------------------------------------	---

---

<b>6 Warranty and Service</b>	7
-------------------------------	---

---

<b>7 Glossary</b>	8
-------------------	---

# 1 Important

---

## Safety

This manual contains important information about the Philips indoor television antenna. Read it carefully before you start the installation and setup.

---

## Notice for USA

This equipment has been tested and found to comply with the limits for a Class B digital device, pursuant to part 15 of the FCC Rules. These limits are designed to provide reasonable protection against harmful interference in a residential installation. This equipment generates, uses and can radiate radio frequency energy and, if not installed and used in accordance with the instruction manual, may cause harmful interference to radio communications.

However, there is no guarantee that interference will not occur in a particular installation. If this equipment does cause harmful interference to radio or television reception, which can be determined by turning the equipment off and on, the user is encouraged to try to correct the interference by one or more of the following measures:

- Relocate the receiving antenna.
- Increase the separation between equipment and receiver.
- Connect the equipment into an outlet on a circuit different from that to which the receiver is connected.
- Consult the dealer or an experienced radio/TV technician for help.

---

## Notice for Canada

### Class B Clause

This digital apparatus does not exceed the Class B limits for radio noise emissions from digital apparatus as set out in the Radio Interference Regulations of the Canadian Department of Communications.

This Class B digital apparatus complies with Canadian ICES-003.

---

## Recycling



Your product is designed and manufactured with high quality materials and components, which can be recycled and reused.

Never dispose of your product with other household waste. Please inform yourself about the local rules on the separate collection of electrical and electronic products. The correct disposal of your old product helps prevent potentially negative consequences on the environment and human health.

The packaging of this product is intended to be recycled. Contact your local authorities for information about how to recycle the packaging.



When this logo is attached to a product, it means a financial contribution has been paid to the associated national recovery and recycling system.

© 2009 Koninklijke Philips Electronics N.V. All rights reserved. Reproduction in whole or in part is prohibited without the written consent of the copyright owner. Trademarks are the property of Koninklijke Philips Electronics N.V. or their respective owners.

## 2 Your SDV1121

Congratulations on your purchase and welcome to Philips!

To fully benefit from the support that Philips offers, register your product at [www.philips.com/welcome](http://www.philips.com/welcome).

### Overview

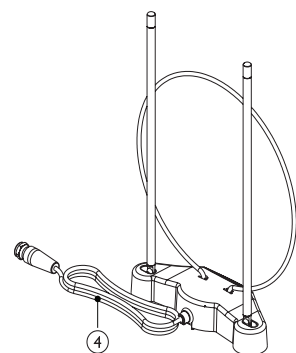
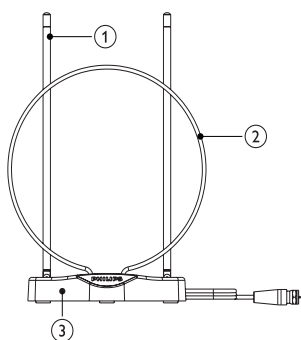

1	VHF antenna
2	UHF antenna
3	Antenna stand
4	Coaxial cable (for TV connection)

## 3 Get started

To ensure the antenna to work properly, read the user manual of your television before you start. Set the television so that it receives the signal from an antenna instead of a cable or satellite.

### Installation

#### Determine the signal strength

Before Installation, determine the best location for optimum reception. It is important for the antenna to have an unobstructed path to the transmitter. For best results, ensure the antenna faces the location of the transmitter.

#### Note

- Choose a location near a window which gives the antenna a clear view of the transmitter.

#### Note

- Place the antenna away from the metal surface to avoid interference.

#### Connect to the TV

- 1 One end of your coaxial cable is already connected to the signal output of the antenna.
- 2 Connect the other end to the input on the TV receiver.

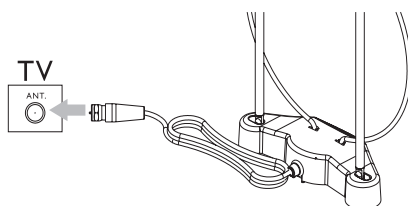

# 4 Set up the SDV1121

## For UHF reception

- 1 Turn the TV to the desired channel/ station.
- 2 Point the antenna stand towards the transmitter until the reception is achieved.

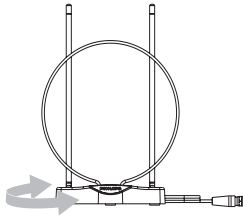

### Tip

- For best results, ensure that the UHF antenna faces towards the transmitter.

## For VHF reception

- 1 Extend the telescopic dipoles to the longest possible length.

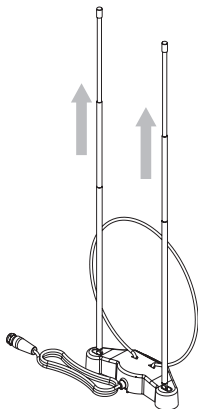

- 2 Turn the TV to the desired channel/ station. Move the dipoles in different directions up and down until the reception is achieved.

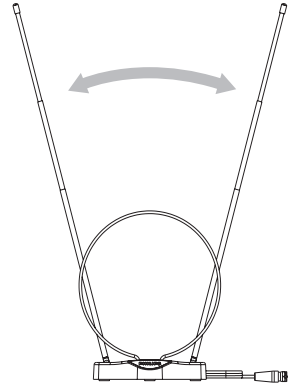

### Note

- To check the distance from the local TV broadcast transmitters to your location, visit [www.antennaweb.org](http://www.antennaweb.org) for more information.

## Set up a digital tuner with this antenna

You can install available channels with the digital TV tuner. This automatic process is part of the setup of the tuner. Ensure the antenna has set up properly before the tuner can receive viewable channels.

- Connect the antenna to a digital tuner. If the signal strength is good enough, the channels can be memorized in the tuner automatically .

## 5 Frequently asked questions

### Can this antenna receive digital or work with ATSC broadcasts?

Yes, this antenna is designed to receive ATSC and HDTV broadcasts in the UHF & VHF bandwidths.

### Where should I place the antenna in order to get the best reception possible?

Choose a location near a window which gives the antenna a clear view of the transmitter.



#### Note

- For best reception, place the antenna away from the metal surface to avoid interference.

### Can I set up this antenna with a digital tuner?

Yes, this antenna can be set up with a digital tuner.



#### Tip

- For more information, see the section on "Set up a digital tuner with this antenna".

## 6 Warranty and Service

Limited One-Year Warranty Philips warrants that this product shall be free from defects in material, workmanship and assembly, under normal use, in accordance with the specifications and warnings, for one year from the date of your purchase of this product. This warranty extends only to the original purchaser of the product, and is not transferable. To exercise your rights under this warranty, you must provide proof of purchase in the form of an original sales receipt that shows the product name and the date of purchase. For customer support or to obtain warranty service, please call 919-573-7854. THERE ARE NO OTHER EXPRESS OR IMPLIED WARRANTIES. Philips' liability is limited to repair or, at its sole option, replacement of the product. Incidental, special and consequential damages are disclaimed where permitted by law. This warranty gives you specific legal rights. You may also have other rights that vary from state to state.

Warranty information can also be found at: [www.philips.com/welcome](http://www.philips.com/welcome)

For technical support, send us an email with the model number of the product and a detailed description of your problem to: [accessorysupport@philips.com](mailto:accessorysupport@philips.com)

# 7 Glossary

---

## A

### Antenna

A device, such as a rod or wire, which picks up a received radio frequency signal or radiates a transmitted RF signal.

### ATSC (Advanced Television Systems Committee)

The Advanced Television Systems Committee, Inc., is an international, non-profit organization developing voluntary standards for digital television. The high definition television standards defined by the ATSC produce wide screen 16:9 images up to 1920x1080 pixels in size -- more than six times the display resolution of the earlier standard. However, many different image sizes are also supported, so that up to six standard-definition "virtual channels" can be broadcast on a single 6 MHz TV channel.

---

## C

### Coaxial

A single copper conductor, surrounded with a layer of insulation, covered by a surrounding copper shield and finally, an insulating jacket. An unbalanced transmission line with constant impedance. In audio, this type is commonly used for low level, line signals terminated in RCA connectors.

---

## H

### HDTV (High-Definition Television)

It is a digital television broadcasting system with higher resolution than traditional television systems (standard-definition TV, or SDTV). HDTV is digitally broadcast; the earliest implementations used analog broadcasting, but today digital television (DTV) signals are used, requiring less bandwidth due to digital video compression.

---

## U

### UHF (Ultra high frequency)

In radio or TV broadcasting: it is the frequency range of electromagnetic waves which lies between 300 MHz and 3 GHz (3000 MHz).

---

## V

### VHF (Very high frequency)

In radio or TV broadcasting: it is the frequency range of electromagnetic waves which lies between 30 MHz and 300 MHz.





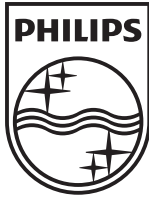

## Free Manuals Download Website

<http://myh66.com>

<http://usermanuals.us>

<http://www.somanuals.com>

<http://www.4manuals.cc>

<http://www.manual-lib.com>

<http://www.404manual.com>

<http://www.luxmanual.com>

<http://aubethermostatmanual.com>

Golf course search by state

<http://golfingnear.com>

Email search by domain

<http://emailbydomain.com>

Auto manuals search

<http://auto.somanuals.com>

TV manuals search

<http://tv.somanuals.com>