

User Manual

MAGNAVOX
SMART. VERY SMART.

20MC4206

COLOR TV WITH BUILT-IN DVD PLAYER



Thank you for choosing
Magnavox.

Need help fast?

Read your Quick Start Guide and/or Owner's Manual first for quick tips that make using your Magnavox product more enjoyable.

If you have read your instructions and still need assistance, you may access our online help at

www.magnavox.com/usasupport
or call

1-800-705-2000

while with your product
(and Model / Serial number)



Magnavox vous remercie de
votre confiance.

Besoin d'une aide rapide?

Les Guide de mise en route rapide et Manuel de l'utilisateur regorgent d'astuces destinées à simplifier l'utilisation de votre produit Magnavox.

Toutefois, si vous ne parvenez pas à résoudre votre problème, vous pouvez accéder à notre aide en ligne à l'adresse

www.magnavox.com/usasupport
ou formez le

1-800-661-6162 (Francophone)

1-800-705-2000 (English speaking)

Veillez à avoir votre produit à
portée de main
(et model / serial nombre)



Gracias por escoger
Magnavox.

Necesita ayuda inmediata?

Lea primero la Guía de inicio rápido o el Manual del usuario, en donde encontrará consejos que le ayudarán a disfrutar plenamente de su producto Magnavox.

Si después de leerlo aún necesita ayuda, consulte nuestro servicio de asistencia en línea en

www.magnavox.com/usasupport
o llame al teléfono

1-800-705-2000

y tenga a mano el producto
(y número de model / serial)



20MC4206



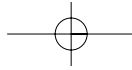

Return your Product Registration Card or register online at www.magnavox.com/usasupport today to get the very most from your purchase.

Registering your model with MAGNAVOX makes you eligible for all of the valuable benefits listed below, so don't miss out. Complete and return your Product Registration Card at once, **or register online at www.magnavox.com/usasupport** to ensure:

| | | |
|--|---|---|
| <p>*Proof of Purchase Returning the enclosed card guarantees that your date of purchase will be on file, so no additional paperwork will be required from you to obtain warranty service.</p> | <p>*Product Safety Notification By registering your product, you'll receive notification - directly from the manufacturer - in the rare case of a product recall or safety defect.</p> | <p>*Additional Benefits Registering your product guarantees that you'll receive all of the privileges to which you're entitled, including special money-saving offers.</p> |
|--|---|---|

MAGNAVOX

Congratulations on your purchase, and welcome to the "family!"

Dear MAGNAVOX product owner:

Thank you for your confidence in MAGNAVOX. You've selected one of the best-built, best-backed products available today. We'll do everything in our power to keep you happy with your purchase for many years to come.

As a member of the MAGNAVOX "family," you're entitled to protection by one of the most comprehensive warranties and outstanding service networks in the industry. What's more, your purchase guarantees you'll receive all the information and special offers for which you qualify, plus easy access to accessories from our convenient home shopping network.

Most importantly, you can count on our uncompromising commitment to your total satisfaction.

All of this is our way of saying welcome - and thanks for investing in a MAGNAVOX product.

P.S. To get the most from your MAGNAVOX purchase, be sure to complete and return your Product Registration Card at once, or register online at:

www.magnavox.com/usasupport

Know these **safety** symbols

| | | |
|---|---|--|
| | CAUTION RISK OF ELECTRIC SHOCK DO NOT OPEN | |
| <p>CAUTION: TO REDUCE THE RISK OF ELECTRIC SHOCK, DO NOT REMOVE COVER (OR BACK). NO USER-SERVICEABLE PARTS INSIDE. REFER SERVICING TO QUALIFIED SERVICE PERSONNEL.</p> | | |

This "bolt of lightning" indicates uninsulated material within your unit may cause an electrical shock. For the safety of everyone in your household, please do not remove product covering.

The "exclamation point" calls attention to features for which you should read the enclosed literature closely to prevent operating and maintenance problems.

WARNING: To reduce the risk of fire or electric shock, this apparatus should not be exposed to rain or moisture, and objects filled with liquids, such as vases, should not be placed on this apparatus.

CAUTION: To prevent electric shock, match wide blade of plug to wide slot, fully insert.

ATTENTION: Pour éviter les choc électriques, introduire la lame la plus large de la fiche dans la borne correspondante de la prise et pousser jusqu'au fond.

For Customer Use

Enter below the Serial No. which is located on the rear of the cabinet. Retain this information for future reference.

Model No. _____

Serial No. _____

MAGNAVOX Visit our World Wide Web Site at <http://www.magnavox.com/usasupport>

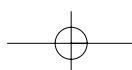

Safety and General Information 3

IMPORTANT SAFETY INSTRUCTIONS

Read before operating equipment

1. Read these instructions.
2. Keep these instructions.
3. Heed all warnings.
4. Follow all instructions.
5. Do not use this apparatus near water.
6. Clean only with a dry cloth.
7. Do not block any of the ventilation openings. Install in accordance with the manufacturers instructions.
8. Do not install near any heat sources such as radiators, heat registers, stoves, or other apparatus (including amplifiers) that produce heat.
9. Do not defeat the safety purpose of the polarized or grounding-type plug. A polarized plug has two blades with one wider than the other. A grounding type plug has two blades and third grounding prong. The wide blade or third prong are provided for your safety. When the provided plug does not fit into your outlet, consult an electrician for replacement of the obsolete outlet.
10. Protect the power cord from being walked on or pinched particularly at plugs, convenience receptacles, and the point where they exit from the apparatus.
11. Only use attachments/accessories specified by the manufacturer.
12.  Use only with a cart, stand, tripod, bracket, or table specified by the manufacturer, or sold with the apparatus. When a cart is used, use caution when moving the cart/apparatus combination to avoid injury from tip-over.
13. Unplug this apparatus during lightning storms or when unused for long periods of time.
14. Refer all servicing to qualified service personnel. Servicing is required when the apparatus has been damaged in any way, such as power-supply cord or plug is damaged, liquid has been spilled or objects have fallen into apparatus, the apparatus has been exposed to rain or moisture, does not operate normally, or has been dropped.
15. This product may contain lead and mercury. Disposal of these materials may be regulated due to environmental considerations. For disposal or recycling information, please contact your local authorities or the Electronic Industries Alliance: www.eiae.org
16. **Damage Requiring Service** - The appliance should be serviced by qualified service personnel when:
 - A. The power supply cord or the plug has been damaged; or
 - B. Objects have fallen, or liquid has been spilled into the appliance; or
 - C. The appliance has been exposed to rain; or
 - D. The appliance does not appear to operate normally or exhibits a marked change in performance; or
 - E. The appliance has been dropped, or the enclosure damaged.
17. **Tilt/Stability** - All televisions must comply with recommended international global safety standards for tilt and stability properties of its cabinet design.
 - Do not compromise these design standards by applying excessive pull force to the front, or top, of the cabinet which could ultimately overturn the product.
 - Also, do not endanger yourself, or children, by placing electronic equipment/toys on the top of the cabinet. Such items could unsuspectingly fall from the top of the set and cause product damage and/or personal injury.
18. **Wall or Ceiling Mounting** - The appliance should be mounted to a wall or ceiling only as recommended by the manufacturer.
19. **Power Lines** - An outdoor antenna should be located away from power lines.
20. **Outdoor Antenna Grounding** - If an outside antenna is connected to the receiver, be sure the antenna system is grounded so as to provide some protection against voltage surges and built up static charges. Section 810 of the National Electric Code, ANSI/NFPA No. 70-1984, provides information with respect to proper grounding of the mast and supporting structure, grounding of the lead-in wire to an antenna discharge unit, size of grounding connectors, location of antenna-discharge unit, connection to grounding electrodes, and requirements for the grounding electrode. See Figure below.
21. **Object and Liquid Entry** - Care should be taken so that objects do not fall and liquids are not spilled into the enclosure through openings.
 - a) **Warning:** To reduce the risk of fire or electric shock, this apparatus should not be exposed to rain or moisture and objects filled with liquids, such as vases, should not be placed on this apparatus.
22. **Battery Usage CAUTION** - To prevent battery leakage that may result in bodily injury, property damage, or damage to the unit:
 - Install all batteries correctly, with + and - aligned as marked on the unit.
 - Do not mix batteries (old and new or carbon and alkaline, etc.).
 - Remove batteries when the unit is not used for a long time.

Note to the CATV system installer: This reminder is provided to call the CATV system installer's attention to Article 820-40 of the NEC that provides guidelines for proper grounding and, in particular, specifies that the cable ground shall be connected to the grounding system of the building, as close to the point of cable entry as practical.

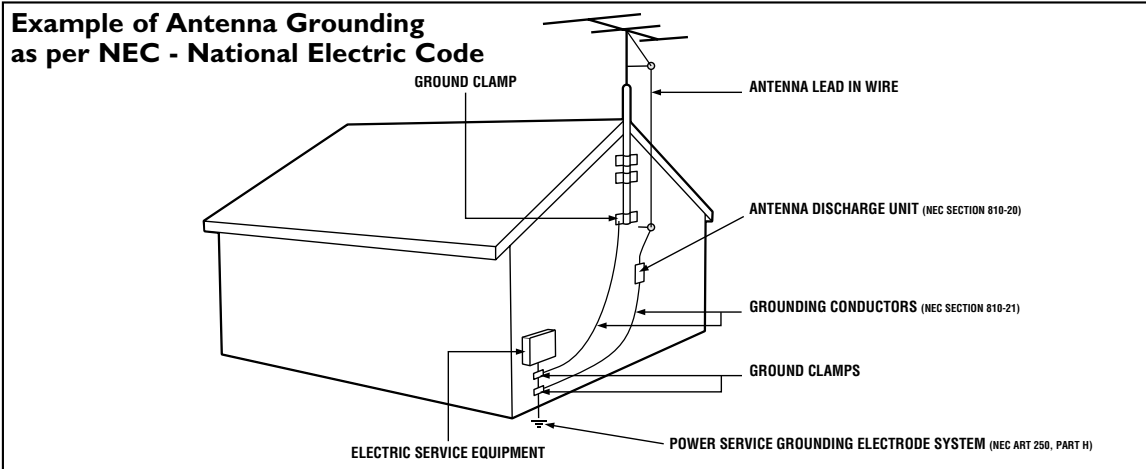

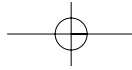

4 Safety and General Information (cont'd)

Safety Precautions

- Do not stand the unit up vertically. Install the unit in a horizontal and stable position.
- Be sure to remove the disc and unplug the AC power cord from the outlet before carrying the unit.

Warning: To prevent fire or shock hazard, do not expose this equipment to rain or moisture.

Federal Communications Commission (FCC) Warning: Any unauthorized changes or modifications to this equipment void the user's authority to operate it.

Laser Safety: This unit employs a laser. Only a qualified service person should remove the cover or attempt to service this device, due to possible eye injury.

CAUTION: USE OF CONTROLS OR ADJUSTMENTS OR PERFORMANCE OF PROCEDURES OTHER THAN THOSE SPECIFIED HEREIN MAY RESULT IN HAZARDOUS RADIATION EXPOSURE.
CAUTION: VISIBLE AND INVISIBLE LASER RADIATION WHEN OPEN AND INTERLOCK DEFEATED. DO NOT STARE INTO BEAM. THE BEAM IS LOCATED INSIDE, NEAR THE DECK MECHANISM.

Special Information for Canadian Users: This Class B digital apparatus complies with Canadian ICES-003. Cet appareil numérique de la classe B est conforme à la norme NMB-003 du Canada.

Radio/TV Interference: This equipment has been tested and found to comply with the limits for a Class B digital device, pursuant to Part 15 of the FCC Rules. These limits are designed to provide reasonable protection against harmful interference in a residential installation. This equipment generates, uses, and can radiate radio frequency energy and, if not installed and used in accordance with the instructions, may cause harmful interference to radio communications. However, there is no guarantee that interference will not occur in a particular installation. If this equipment does cause harmful interference to radio or television reception, which can be determined by turning the equipment off and on, the user is encouraged to try to correct the interference by one or more of the following measures:

- 1) Reorient or relocate the receiving antenna.
- 2) Increase the separation between the equipment and the receiver.
- 3) Connect the equipment into an outlet on a circuit different from that to which the receiver is connected.
- 4) Consult the dealer or an experienced radio/TV technician for help.

Copyright Protection: Unauthorized copying, broadcasting, public performance and lending of discs are prohibited. "This product incorporates copyright protection technology that is protected by U. S. patents and other intellectual property rights. Use of this copyright protection technology must be authorized by Macrovision, and is intended for home and other limited viewing uses only unless otherwise authorized by Macrovision. Reverse engineering or disassembly is prohibited."

Declaration of Conformity

Model Number: 20MC4206
Trade Name: Magnavox
Responsible Party: Philips Consumer Electronics North America
P.O. Box 671539
Marietta, GA 30006-0026
1-800-705-2000

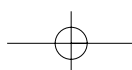

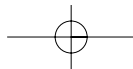

Table of Contents 5

General Information

- Safety and General Information3-4
- Table of Contents5
- Introduction6
- Playable Discs7

Initial Setup and Use

- Before Using the TV/DVD8
- Hooking Up the TV/DVD9-10
- Optional Connections11
- Remote Control Buttons12-13
- Front Panel14
- Rear Panel15
- Initial Setups16
- Watching TV17
- Playing a Disc18

TV Settings

- Menu Language, Auto Channel Programming .19
- Adding/Deleting Channels20
- Picture Controls21

Additional TV Features

- Sleep Timer22
- Closed Captions23
- Setting V-Chip24-29

T
V

Disc Features

- DVD Disc Menus, Title Menus30
- Fast Forward/Fast Reverse31
- Chapter/Title/Time Search32
- Track Search33
- Paused and Step-by-Step Playback, Resume On ...34
- Repeat, A-B Repeat35
- Markers36
- Subtitles, Camera Angles37
- Slow Motion, Zoom38
- Audio Language, Stereo Sound39
- On-Screen Displays40-41
- Black Level, Virtual Surround, Initializing42
- Random Playback, Program Playback43
- MP3/Windows Media™ Audio/JPEG Playback ...44
- Dual Playback, Folder Playback45

D
V
D

DVD Setup Features

- Language Settings46-47
- Display Settings48-49
- Audio Settings50
- Parental Settings51-53
- Others54-55

Information You May Need

- Glossary56
- Helpful Hints57-58
- Specifications59
- Limited Warranty60
- Index61

Symbols Used in This Manual

The following symbols appear in some headings and notes in this manual.



Description refers to playback of DVDs.



Description refers to playback of Video CDs.



Description refers to playback of Video CDs without PBC function.



Description refers to playback of Audio CDs.



Description refers to playback of MP3 discs.



Description refers to playback of Windows Media™ Audio CDs.



Description refers to playback of JPEG discs.

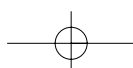

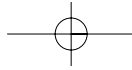

6 Introduction

Welcome to Your TV/DVD Owner's Manual.

Features - TV

- Automatic Channel Setup
- Closed Captions
- English, Spanish or French Setup Menus
- Sleep Timer
- V-Chip (Parental Controls)

Features - Discs

- Audio Language choices *
 - Camera Angle *
 - Dolby Digital Sound *
 - Dual Playback
 - Dynamic Range Control
 - Fast/Paused/Slow/Step-by-Step Playback
 - JPEG Playback
 - Markers
 - MP3/Windows Media™ Audio Playback
 - Parental Controls *
 - Program Playback
 - Random Playback
 - Repeat (A-B, Chapter, Title, Track, Group, Disc)
 - Search (Title/Chapter, Time, Track)
 - Subtitles *
 - Virtual Surround
 - Zoom
- * If available on the disc

Package Contents

- Remote Control
- Two AAA batteries
- User Manual
- Quick Start Guide
- Registration Card

DVD Disc Menus...

Some explanations in this manual describe DVD Disc Menus. DVD manufacturers set the menus, which vary among DVDs. Not all DVDs have menus. If the DVD has a menu, access it by pressing DISC MENU on the remote control.

Details are on page 30.

Setup Menus...

Some instructions explain how to use the Setup Menus of the TV/DVD. There are two Setup Menus: one for the TV features while the unit is in TV mode, and one for the disc features while the unit is in DVD mode. Access the Setup Menus by pressing SET-UP on the remote control.

While in TV mode, you can select only the TV SETUP Menu.

In DVD mode, you can select both the TV SETUP Menu and the Setup Menu for the unit's DVD player. Press SET-UP once to select the TV SETUP Menu. Press SET-UP twice to get to the DVD player's Setup Menu.

Even if you set a DVD feature in the unit's Setup Menu, it will not be available if the current disc does not include that feature.

Available Disc Features...



All features described in this manual are not available on every disc. If the feature is not available on the disc, you cannot use the TV/DVD to make it available.

An "X" will appear in the top right corner of the screen if you try to access a feature that is not available.

For example, some features are available only during playback, while others are available only if playback is stopped. If you cannot access a feature, try stopping or starting playback, then try the feature again.

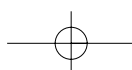

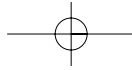

Playable Discs 7

Playable Discs

The DVD player of this TV/DVD will play many types of discs, including Digital Video Discs (DVDs) and Audio Compact Discs (CDs). It will play MP3, Windows Media™ Audio and JPEG files as well.

To play a DVD, make sure it meets the requirements for Region Codes and Color Systems as described below. Discs that have the following logos will play on the DVD player of this TV/DVD. Finalize CD-R, CD-RW, DVD+R and DVD+RW Discs before playing them in the TV/DVD.

- A disc may not play properly if the disc's recorded area is less than 55mm across.
- Do not glue paper or put stickers on to the disc. These may damage the disc, and the TV/DVD may not read it correctly.



DVD: Prerecorded Digital Video Discs



Video CDs



CD-RW: Compact Disc Rewritable. CD-RWs can be recorded on multiple times.



DVD+R: DVD Recordable. DVD+Rs can be recorded on only once.



Audio CDs



DVD+RW: DVD Rewritable. DVD+RWs can be recorded on multiple times.



CD-R: Compact Disc Recordable. CD-Rs can be recorded on only once.



MP3: Digital audio files recorded on a CD-R or CD-RW



DVD is a trademark of DVD Format/Logo Licensing Corporation.

Windows Media is a trademark of Microsoft Corporation.

This unit is not compatible with Multiple Bit Rate.

(MBR: a file that contains the same content encoded at several different bit rates).

ABOUT THE PBC FUNCTION OF VIDEO CD

This unit can play Video CD 1.1 (without PBC) and 2.0 (with PBC).

With version 2.0 (with PBC), you can use interactive menu (e.g., playlists) on the TV screen.

When playing a Video CD with PBC, some operations cannot be performed unless the PBC function is cancelled temporarily. See page 30 for more details.

Region Codes

This TV/DVD has a Region One (1) DVD player. DVDs must be labeled for ALL regions or for Region 1 in order to play on the unit. You cannot play DVDs that are labeled for other regions. Look for the symbols below on your DVDs. If these region symbols do not appear on your DVD, you cannot play the DVD in this TV/DVD.



The number inside the globe refers to a region of the world. Region 1 represents the United States, Canada, upper regions of North America, Bermuda, the U.S. Virgin Islands, and small regions near Australia. A DVD labelled for a specific region can only play on DVD players with the same region code.

Color Systems

DVDs are recorded in different color systems throughout the world. The most common color systems are NTSC (which is used primarily in the United States and North America), PAL, and SECAM.

The DVD player of this unit uses NTSC, so DVDs you play must be recorded in the NTSC color system. You cannot play DVDs recorded in other formats. The color system of the DVD may be listed on the DVD or on the disc case.

Unacceptable Discs

If you insert an unacceptable type of disc, a Disc Error message may appear on the TV screen. The following discs will not play on this DVD player.

- CD-ROM
- Compact Disc-Interactive (CD-I)
- Unfinalized discs
- DVD-RAM
- Video Single Disc (VSD)
- DVD contains MP3, Windows Media™ Audio or JPEG files
- DVD-ROM
- DVD-Audio

On the following disc, the sound may not be heard.

- Super Audio CD - Only the sound on the CD layer can be heard. The sound on the high-density Super Audio CD layer cannot be heard.

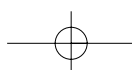

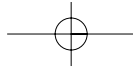

8 Before Using the TV/DVD

Remote Control Battery Installation

- 1** Remove the battery compartment lid on the bottom of the remote control. Slide the lid down and off. Follow the direction of the arrow on the lid.
- 2** Place two AAA batteries inside the battery compartment. Align the + and – ends as indicated.
- 3** Replace the battery compartment lid.

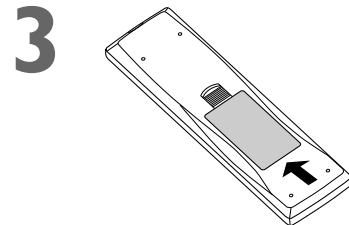
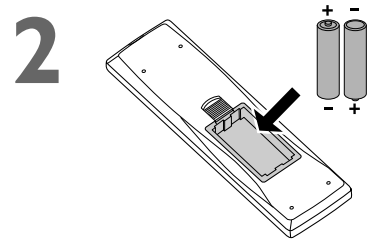
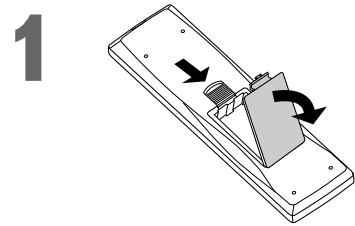

Recycling Guide

Your new product, its packaging and this manual contain materials that can be recycled and reused.

Specialized companies can recycle your product to increase the amount of reusable materials and to minimize the amount that needs to be properly disposed.

Your product uses batteries that should not be thrown away when depleted but should be disposed of as small chemical waste.

Please find out about the local regulations on disposal of your old product, batteries, manual and packaging when you replace existing equipment.

Battery Safety

Battery Usage CAUTION - To prevent battery leakage that may result in bodily injury, property damage or damage to the unit.

- Install ALL batteries correctly, with the + and – markings on the battery aligned as indicated on the unit.
- Do not mix batteries, for example, old with new or carbon with alkaline.
- Remove batteries when the unit will not be used for a long time.

Using the Remote Control

- Point the remote control at the remote sensor on the front of the TV/DVD. *Details are on page 14.*
- Do not put objects between the remote control and the TV/DVD.

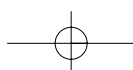

Hooking Up the TV/DVD 9

1 Hook up your TV/DVD using one of the connections shown.

A Hooking Up Your TV/DVD with a Cable TV Signal or Outdoor Antenna

Connect a Cable TV signal or an antenna to the ANT(enna) Jack.

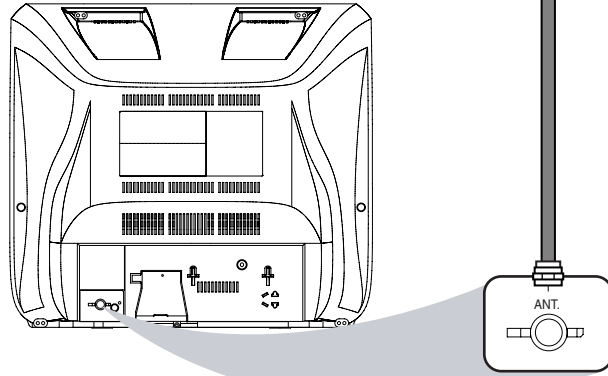

B Hooking Up Your TV/DVD with a Cable Box/Satellite Receiver

To view any channel, set the TV/DVD to the output channel (channel 03 or 04) of the Cable Box/Satellite Receiver. Then, select channels at the Cable Box/Satellite Receiver.

Connect the Cable TV or Satellite signal to the IN Jack on the Cable Box/Satellite Receiver.

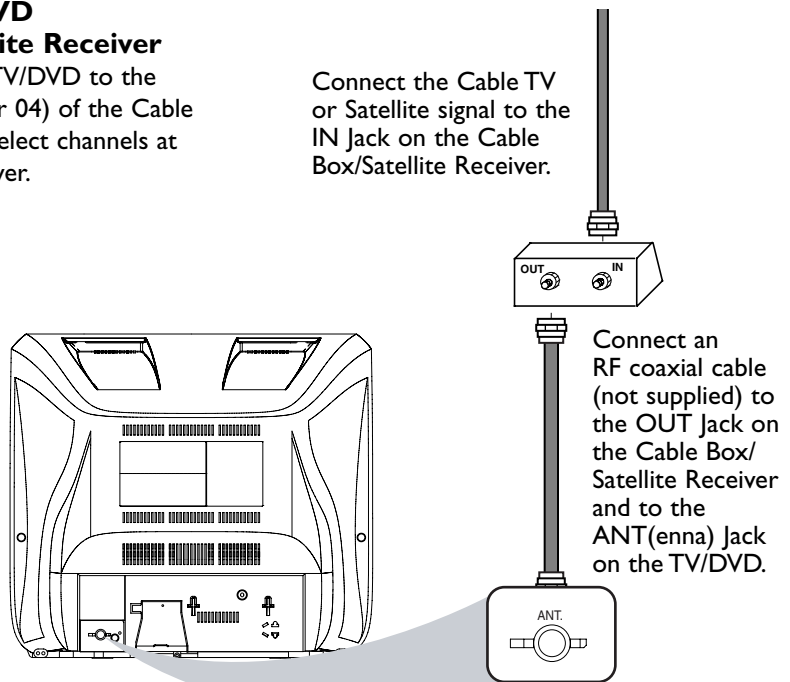

Connect an RF coaxial cable (not supplied) to the OUT Jack on the Cable Box/Satellite Receiver and to the ANT(enna) Jack on the TV/DVD.

Your Cable Box/Satellite Receiver may have Audio and Video Out jacks instead of the single Antenna Out jack (RF coaxial or 75 ohm) shown here.

If so, connect Audio and Video cables to the Audio/Video Out jacks of the Cable Box/Satellite Receiver and to the AUDIO/VIDEO In jacks on the front of the TV/DVD.

Press SELECT on the remote to set the TV/DVD to AUX, not channel 3 or 4. Select channels you want to watch at the Cable Box/Satellite Receiver as usual, leaving the TV/DVD on AUX.

Instructions continue on the next page.

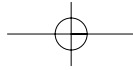

10 Hooking Up the TV/DVD (cont'd)

Instructions continued from the previous page.

C Hooking Up Your TV/DVD to Another Video Source (VCR, DVD player, Camcorder, etc.)

You may need this connection if you want to play discs or tapes on other equipment but watch them on the TV/DVD. Press SELECT on the remote to select AUX at the TV/DVD.

When you play the materials on the other equipment, it will show on the TV/DVD's AUX channel.

Audio and video cables are not supplied.

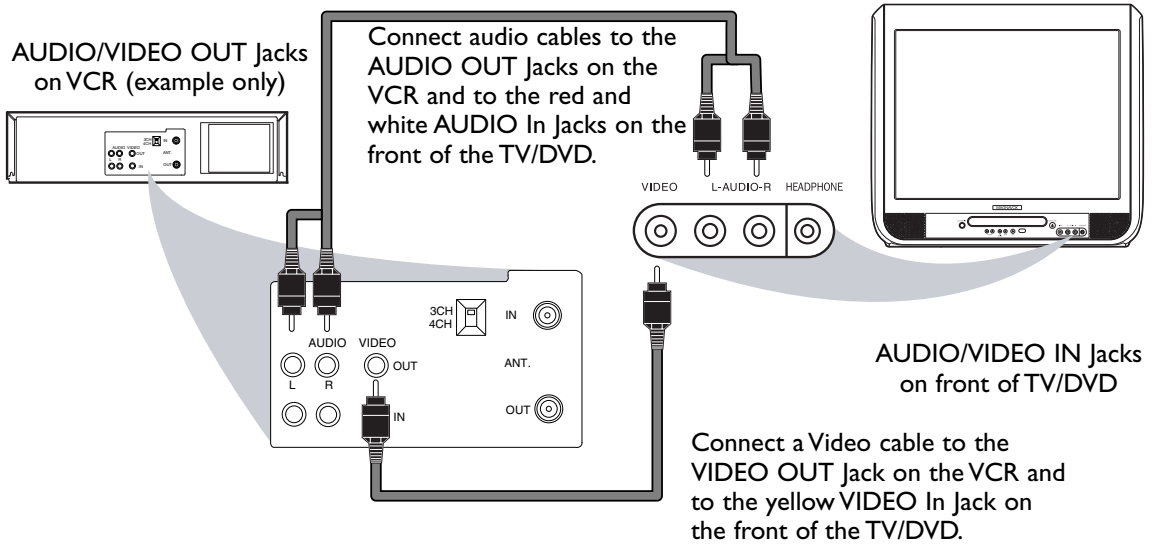

2 When all other connections are complete, plug in the TV/DVD's power cord.

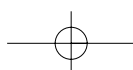

Optional Connections 11

Digital Stereo Hookups

You can connect the TV/DVD to a Stereo that has a Digital Coaxial In jack. Use this hookup if you want to hear the TV/DVD sound through the Stereo instead. Use these connections for a Dolby Digital-compatible Stereo or for a Receiver that has a Mini-Disc or Digital Audio Tape deck.

- 1** Connect the antenna/Cable TV signal. Details are on pages 9-10.
- 2** Connect a digital audio coaxial cable (not supplied) to the **COAXIAL** jack on the TV/DVD. Also connect the cable to the Stereo's **COAXIAL DIGITAL AUDIO IN** jack.
- 3** If the Stereo is Dolby Digital-compatible, set **DOLBY DIGITAL** to **BITSTREAM**. If the Stereo is not Dolby Digital-compatible or if you connected to a Mini-Disc or Digital Audio Tape Deck, set **DOLBY DIGITAL** to **PCM**. Details are on page 50. An incorrect setting causes noise distortion and damages speakers.

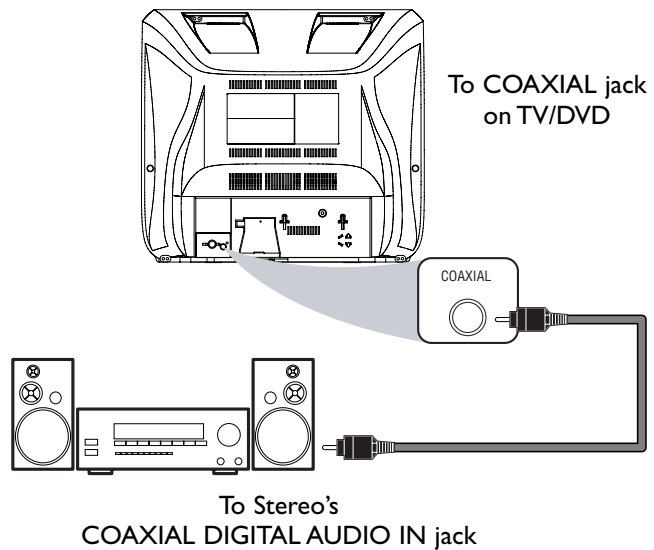

Helpful Hints

- You cannot use a Mini-Disc or Digital Audio Tape deck to copy Dolby Digital Multi-channel surround sound discs.
- If the disc is not recorded in Dolby Digital Multi-channel surround sound, you will not hear multi-channel sound even if you use the Digital Stereo hookup.
- To see if your disc is recorded in Dolby Digital, look for a Dolby Digital logo on disc or on its case.
- To see if your Stereo has Dolby Digital, look for a Dolby Digital logo on your Stereo. Or, refer to the Stereo owner's manual.

12 Remote Control Buttons

STANDBY-ON Button

Press to turn on or off the TV/DVD.

CLEAR Button

Press to reset or erase wrong information.

PREV Button

During playback;
- press to skip to the beginning of the current track/chapter.
- press repeatedly to skip to previous tracks/chapters.
Details are on page 33.

Button

During playback;
- Press to search backward.
Details are on page 31.
- Use this button in combination with PAUSE  to start the Slow Motion Playback.
Details are on page 38.

MODE Button

Press to access the settings listed below:

- Audio Setting**
Details are on page 39.
 - Search Setting**
Details are on pages 32 and 33.
 - Repeat Setting**
Details are on page 35.
 - A-B Repeat Setting**
Details are on page 35.
 - Subtitle Setting**
Details are on page 37.
 - Camera Angle Setting**
Details are on page 37.
 - Zoom Setting**
Details are on page 38.
 - Black Level Setting**
Details are on page 42.
 - Virtual Surround Setting**
Details are on page 42.
 - Random Playback Setting**
Details are on page 43.
 - Program Playback Setting**
Details are on page 43.
 - Folder Playback Setting**
Details are on page 45.
- Some settings are not available in specific modes.

OPEN/CLOSE Button

Press to open or close the disc tray. *Details are on page 18.*

NEXT Button

During playback;
- press to skip to the next track or chapter.
Details are on page 33.

Button

During playback;
- Press to search forward.
Details are on page 31.
- Use this button in combination with PAUSE  to start the Slow Motion Playback.
Details are on page 38.

TITLE Button

Press to access a DVD's Title Menu if available. *Details are on page 30.*

ENTER Button

Press to accept or change a menu setting.

SET-UP Button

Press to access or remove the TV/DVD's Setup Menus.

MUTE Button

Press to mute or restore the sound.

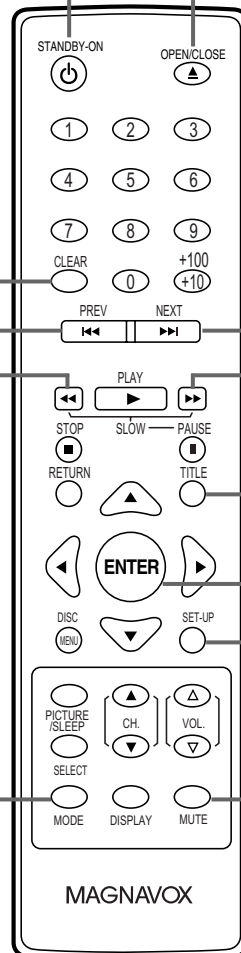

Remote Control Buttons (cont'd) 13

Number Buttons

TV Mode: Press two digits to access a specific channel. Press 0 before the number of a single-digit channel. *Details are on page 17.*

+100/+10 button: To select channels 100 or higher, press +100/+10, then the Number buttons of the last 2 digits of the channel number.

DVD Mode: Use the Number buttons to enter a track or chapter number.

+100/+10 button: Press before entering double-digit numbers. For example, to select chapter 16, press +100/+10, then 1, 6.

STOP ■ Button

Press to stop disc playback.

RETURN Button

Press to go to the previous Setup Menu in DVD or TV mode. Press to remove On-Screen Displays.

DISC MENU Button

Press to access DVD disc menus. *Details are on page 30.*

PICTURE/SLEEP Button

Press to set the Sleep Timer. *Details are on page 22.*
Press to access the picture controls. *Details are on page 21.*

SELECT Button

Press to choose AUX, TV or DVD mode. When you select DVD mode using this button, you must press PLAY ► or OPEN/CLOSE ▲ before you can access the DVD features or setup menus.

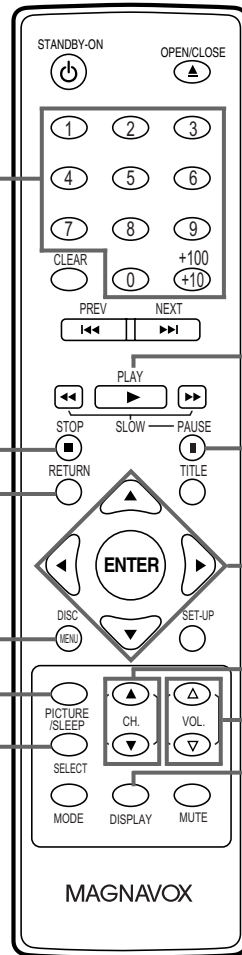

PLAY ► Button

Press to start playing a disc. *Details are on page 18.*

PAUSE ■■ Button

Press to pause DVD playback. Press repeatedly to advance the DVD picture one frame at a time. *Details are on page 34.*

Arrow ▲▼◀▶ Buttons

Use the Arrow buttons to select or adjust menu items.

CH. (channel) ▲/▼ Buttons

Press to select memorized TV channels. *Details are on page 17.*

VOL. (volume) ▲/▼ Buttons

Press to adjust the volume.

DISPLAY Button

TV Mode: Press to see the channel on the screen.

DVD Mode: Press to see the disc status on the screen. *Details are on page 40.*

14 Front Panel

Disc tray

Insert a disc here.
Details are on page 18.

PLAY ► Button

Press to start disc playback.
Details are on page 18.

STOP ■ Button

Press to stop disc playback.
Details are on page 18.

CH. SELECT ▲ Button

Press to select TV channels.
Details are on page 17.

STANDBY-ON ⏻ Button

Press to turn the TV/DVD on or off.

VOLUME ▲/▼ Buttons

Press to adjust the volume.
Details are on page 17.

Remote Sensor

Receives a signal from your remote control so you can operate the TV/DVD from a distance.

OPEN/CLOSE ▲ Button

Press to open or close the disc tray.
Details are on page 18.

VIDEO and AUDIO L/R (left/right) IN jacks

Use audio and video cables to connect these jacks to the audio and video out jacks of a Camcorder, DVD player, etc. This lets you watch materials playing on the other equipment when you choose AUX at the TV/DVD. Details are on page 10.

HEADPHONE jack

Connect headphones (not supplied) here for personal listening.

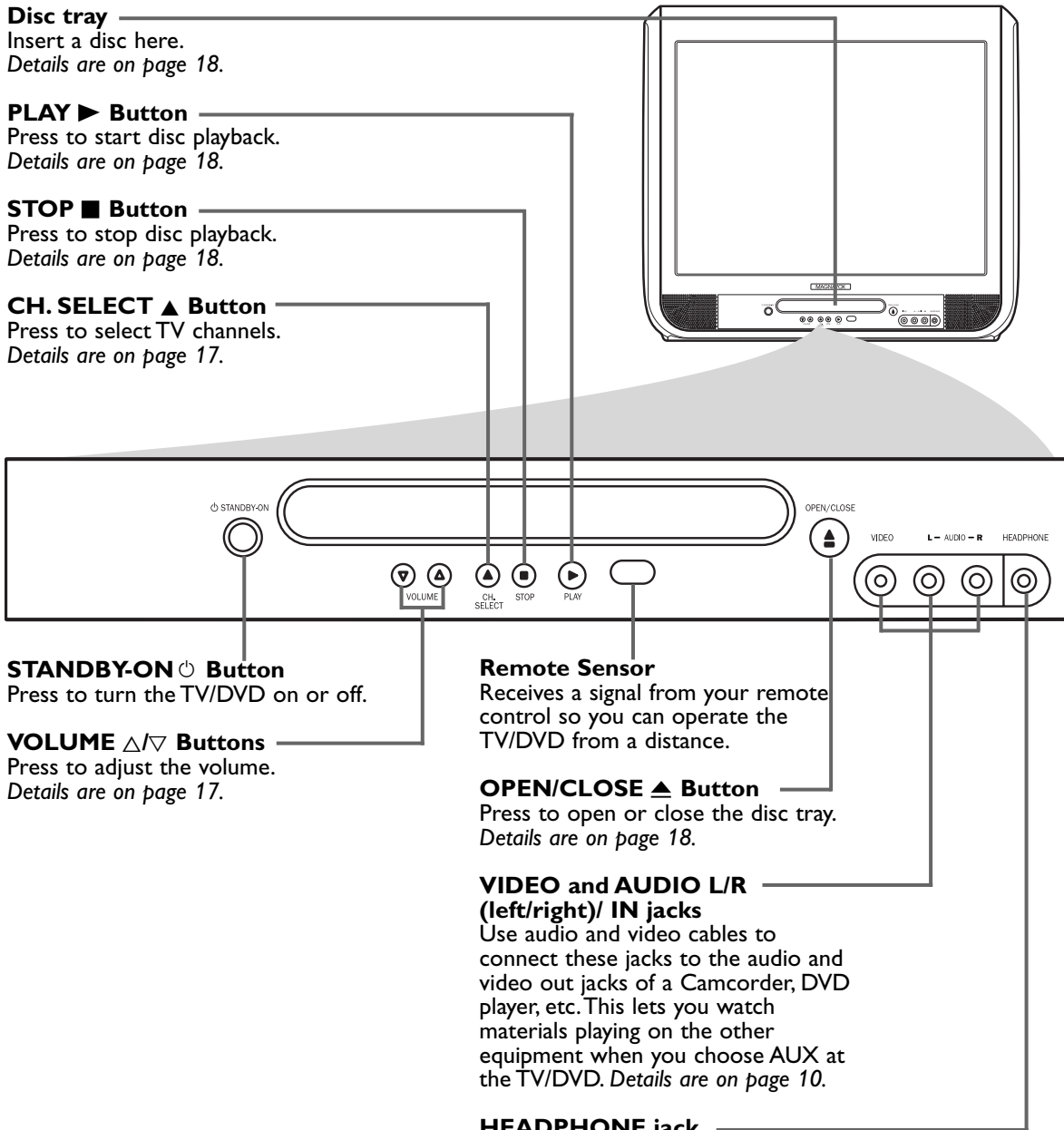

Rear Panel 15

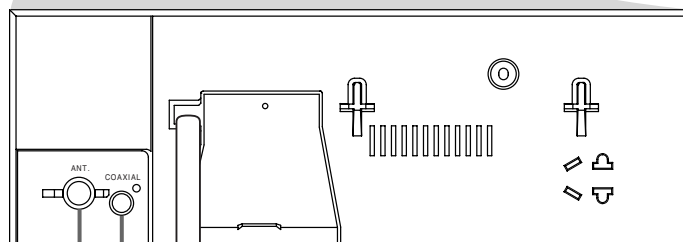
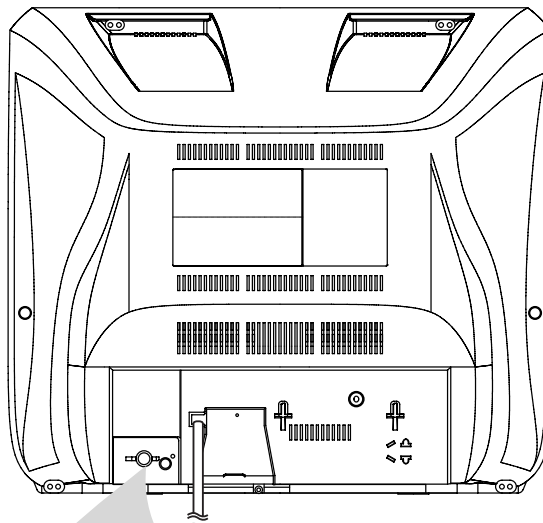

**ANT. jack
(Antenna In)**

Connect an antenna or Cable TV signal here. This brings TV channels to the TV/DVD. If you do not connect an antenna or Cable TV signal to the TV/DVD (or connect to a Cable Box/Satellite Receiver through this jack), you will not receive any TV channels. *Details are on page 9.*

COAXIAL jack

Connect this jack to a Digital Stereo using a coaxial digital audio cable (not supplied). Use this connection if the Stereo has Dolby Digital compatibility and has a coaxial digital audio in jack. You may also use this connection when connecting the TV/DVD to a Mini-Disc or Digital Audio Tape deck. *Details are on page 11.*

Power Cord

Connect to a standard AC outlet (120V/60Hz).

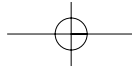

16 Initial Setups

First Time You Turn on the Unit

Right after the purchase of the unit, do the Initialize Setting by taking the following procedures.

1 After making all the necessary connections, turn on the TV/DVD.

Initial Setup Screen will appear.

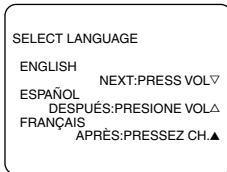

2 Press the appropriate button to select the language of your choice.

- To select ENGLISH, press **VOL. ▽**.
- To select ESPAÑOL, press **VOL. ▲**.
- To select FRANÇAIS, press **CH. ▲**.

3 Confirm the antenna (or cable) connection and press **PLAY ►**. The Auto Channel Programming will start.

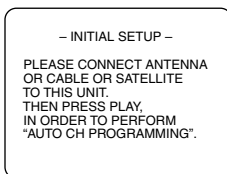

4 When scanning is complete, the TV/DVD will go to the lowest available channel. Use **CH. ▲/▼** to scan non-memorized channels. You can select non-memorized channels with the Number buttons.

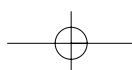
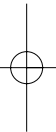
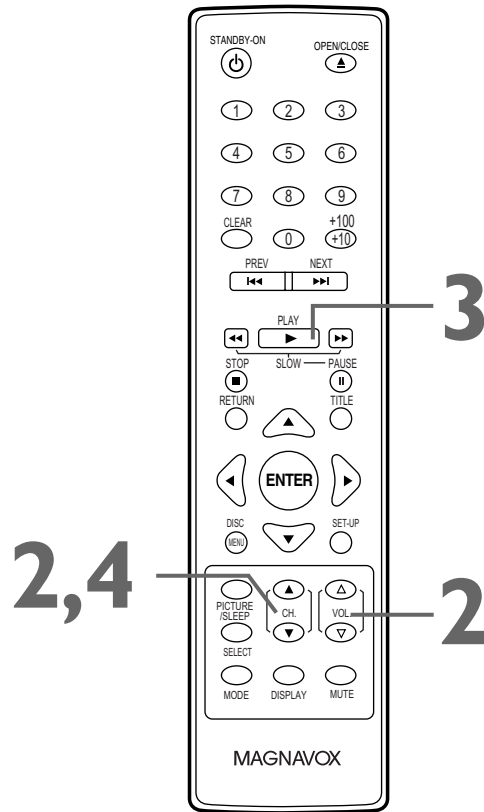

Watching TV 17

The unit selects available TV channels automatically when you connect an Antenna or Cable TV signal to it. To reset TV channels, see page 20.

If you are using a Cable Box or Satellite Receiver, you do not need to set channels at the TV/DVD.

1 Press **STANDBY-ON**  to turn on the TV/DVD.

2 To watch TV, press **CH. ▲/▼** to select memorized channels. Memorized channels are those that appear when you flip through channels. If a channel is skipped, you still can use the Number buttons to select it. This is a non-memorized channel; it may have weak reception in your area.

To update your memorized and non-memorized channels, see page 19.

Remember, if you are using a Cable Box/Satellite Receiver, set the TV/DVD to channel 3, 4 or AUX.

Change channels at the Cable Box/Satellite Receiver.

3 Press **VOL. ▲/▼** to adjust the volume.

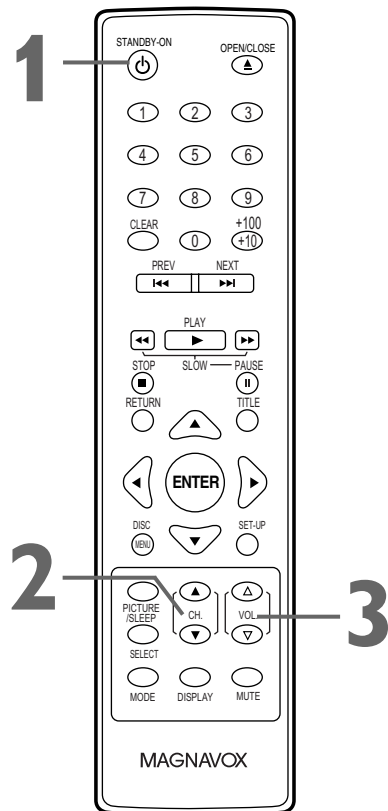
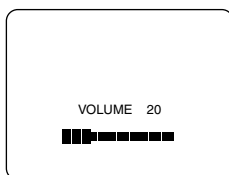

Helpful Hint

- If the TV screen shows snow noise and there is no operation for more than 10 seconds, "HELPFUL HINTS" appears.

- HELPFUL HINTS -
 1. PLEASE CHECK TO SEE IF THE ANTENNA/CABLE/SATELLITE IS PROPERLY CONNECTED.
 2. DID YOU PERFORM "AUTO CH PROGRAMMING"?
 3. PLEASE REFER TO FRONT PAGE OF THE OWNER'S MANUAL OR REAR PANEL FOR SUPPORT LINE INFORMATION.

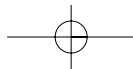

18 Playing a Disc

Before you begin, turn on the power of other equipment connected to the TV/DVD. Set a stereo (if applicable) to the correct sound source or channel. *Details are on page 11.*

- 1** Press **STANDBY-ON** to turn on the TV/DVD.
- 2** Press **OPEN/CLOSE** to open the disc tray. The unit will switch to DVD mode automatically.
- 3** Place a disc into the tray. Some DVDs are recorded on both sides. Make sure the label of the side you want to play is facing up. Or, if the DVD is recorded on only one side, place the disc in the tray with the label facing up and the shiny side facing down.

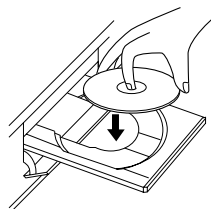

- 4** Press **PLAY** . The tray will close and playback will begin. If playback does not start automatically, press **PLAY** again. If a DVD Menu appears instead, see page 30. To play MP3, Windows Media™ Audio or JPEG files, see page 44. You also can close the tray by pressing **OPEN/CLOSE** .
- 5** Press **STOP** to stop playback. If playback remains stopped for 5 minutes, the DVD Screen will dim. If playback is stopped for 20 minutes with no activity at the TV/DVD, the unit will turn off.

REMINDER: Only certain discs will play.
See page 7 for details.

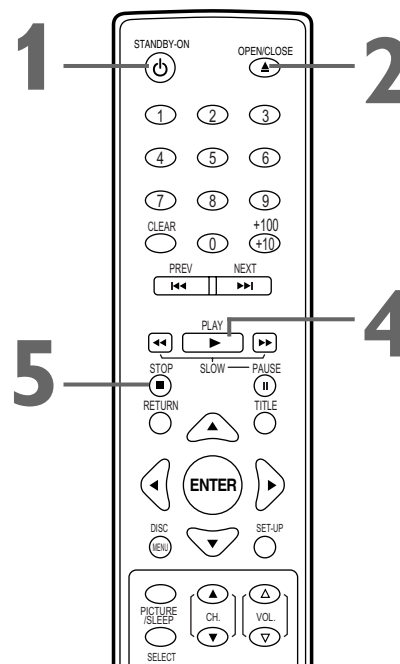

Helpful Hints

- Even if you turn off the unit in DVD mode, if you turn it on again with the **STANDBY-ON** button, it will be in TV mode. If the unit was shut down by unplugging the power cord or due to a power failure, it will be in DVD mode when you turn it on again.
- An "X" will appear on the screen when you try to access a feature that is not available. This is not a problem with the TV/DVD.
- If a disc is dirty or scratched, the picture may be distorted or playback may stop. Remove the disc and try a different one.
- Pressing **OPEN/CLOSE** or **PLAY** will turn on the unit in DVD mode (not TV mode).
- If a disc has multiple layers, the picture may freeze occasionally. This happens when the first layer switches to the second layer. This is not a malfunction.
- Pressing **SELECT** during disc playback stops disc playback and switches the unit to TV mode.

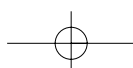

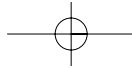

TV

20 Adding/Deleting Channels

● To put the TV/DVD in TV mode, press **SELECT**.

You can delete TV channels you no longer receive or seldom watch. Or, you can add more channels if the TV/DVD did not memorize all your favorite channels.

1 Press **SET-UP**.

2 Press **▲** or **▼** to select **CHANNEL SET UP**. Then, press **ENTER**.

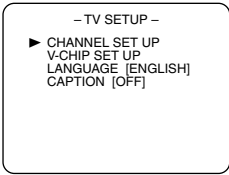

3 Press **▲** or **▼** to select **ADD/DELETE CH.** (TV or (CATV) will appear beside ADD/DELETE CH. This indicates whether you connected an Antenna (TV) or a Cable TV signal (CATV) to the TV/DVD. Then, press **ENTER**. The menu will disappear and a TV channel will appear. The channel number will appear, along with ADD/DELETE.

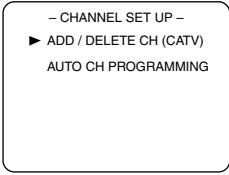

4 Press **▲** or **▼** until the channel you wish to add or delete appears. You also can use the Number buttons or **CH. ▲/▼** to choose a channel.

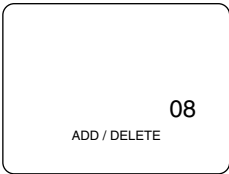

5 Press **ENTER** to add or delete the channel. To add a channel, press **ENTER** so **ADD** and the channel number appear in light blue (teal). To delete a channel, press **ENTER** so **DELETE** and the channel number appear in light red (purple). To delete another channel, repeat steps 4-5.

6 Press **SET-UP** when you are finished.

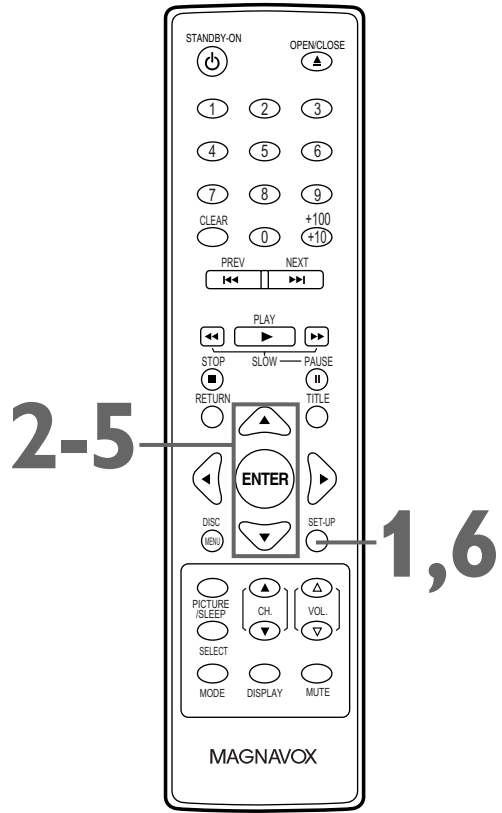

Helpful Hints

- To confirm that a channel has been added or deleted, press **CH. ▲/▼** to see if you can or cannot select the channel. Only memorized/added channels can be selected with **CH. ▲/▼**. Use the Number buttons to select deleted channels.
- If you connected an Antenna to the TV/DVD, channels 2-69 will be available to add or delete. If you connected to Cable TV, channels 1-125 will be available.
- This function will not operate when the unit is in DVD mode.

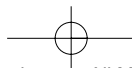

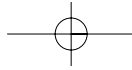

TV

Picture Controls 21

Follow these steps to adjust the TV/DVD's brightness, sharpness, tint, color or contrast.

- 1** Press **PICTURE/SLEEP** twice.
- 2** Within 10 seconds, press **▲** or **▼** to select the picture control you want to adjust. You can select **BRIGHT**, **CONTRAST**, **COLOR**, **TINT** or **SHARPNESS**.

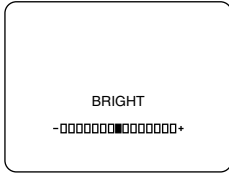

- 3** Within 10 seconds, press **◀** or **▶** to adjust the picture control.

| | ◀ | ▶ |
|------------------|------------------------|------------------------|
| BRIGHT | to decrease brightness | to increase brightness |
| CONTRAST | to decrease contrast | to increase contrast |
| COLOR | to decrease color | to brighten color |
| TINT | to add purple | to add green |
| SHARPNESS | to make soft | to make clear |

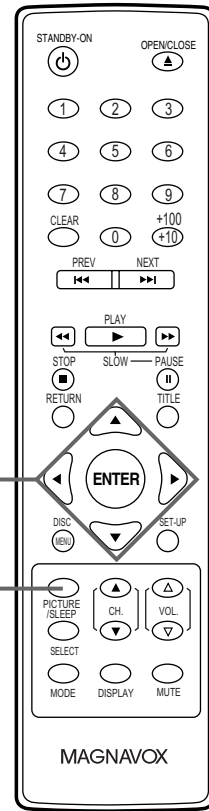
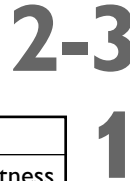

Helpful Hint

- **Degaussing:** Magnetism from nearby appliances and speakers might affect the color of the TV picture. If this happens, move the TV/DVD away from the appliance. If the color is still not correct, disconnect the power cord for 30 minutes. After 30 minutes, try using the unit again.

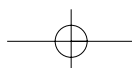

TV

22 Sleep Timer

Use the Sleep Timer to program the TV/DVD to shut off in a certain amount of time.

- Press PICTURE/SLEEP once. Sleep information will appear at the bottom of the TV screen.**

Press ◀ or ▶ to change the amount of time until shut down. The Sleep Timer can be set every 10 minutes between 10 to 120 minutes. Each press of ▶ will increase the time by 10 minutes. After 10 seconds, the Sleep Timer information will disappear from the screen. The TV/DVD will turn itself off after the selected amount of time has passed.

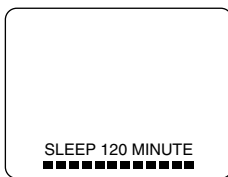

To cancel the Sleep Timer

Press CLEAR to set the amount of time to 0.

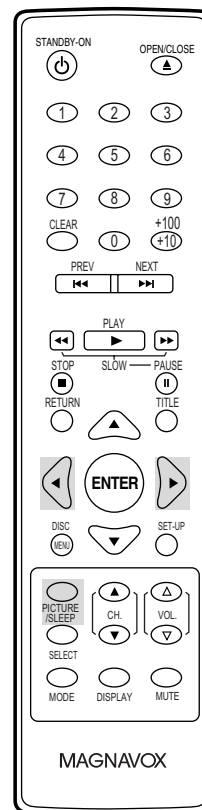

Helpful Hint

- To see how much time remains before the TV/DVD turns itself off, press PICTURE/SLEEP once. The information will disappear automatically in 10 seconds.

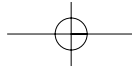

TV

Closed Captions 23

● To put the TV/DVD in TV mode, press **SELECT**.

Follow the steps below to select closed captions for TV programming. Not all TV programs and commercials have closed captions or all types of closed captions (second language, half-screen text, etc.). If closed captioning is not broadcast, you cannot receive it. This does not indicate a problem with the TV/DVD. Check your TV program listings for shows with closed captions.

If the TV/DVD receives poor quality television signals, the captions may contain errors, or there might be no captions at all. Some possible causes of poor quality signals are:

- Automobile ignition noise
- Electric motor noise
- Weak signal reception
- Multiplex signal reception (ghosts or screen flutter)

1 Press **SET-UP**. Press **▲** or **▼** to select **CAPTION**.

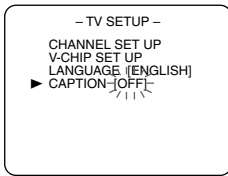

2 Press **ENTER** repeatedly to select **CAPTION1**, **CAPTION2**, **TEXT1**, **TEXT2** or **OFF**.

CAPTION1 displays standard closed captions (what a character is saying). CAPTION2 displays foreign language closed captions (foreign language words showing what a character is saying).

TEXT1 and TEXT2 display half-screen text (such as a channel guide, schedule or announcement).

OFF turns off closed captions. Captions will not appear on the screen.

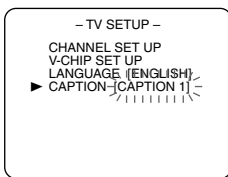

3 Press **SET-UP** to exit the menu.

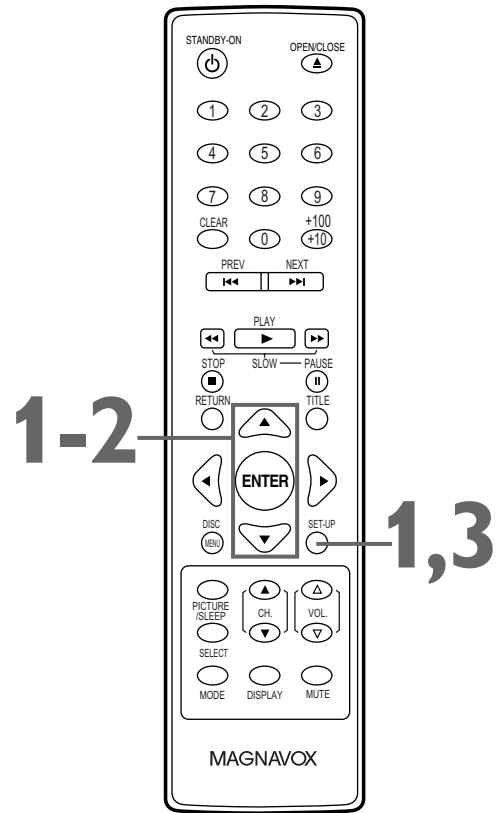

Helpful Hints

- If a black box appears on the screen, a TEXT mode is selected. Select CAPTION1, CAPTION2 or OFF.
- The TV/DVD retains the Closed Caption Setting if the power fails.
- Abbreviations, symbols and other grammatical shortcuts may be used in order to keep pace with the on-screen action. This is not a problem with the TV/DVD.
- Changing channels may delay closed captions for a few seconds.
- Adjusting or muting the volume may delay closed captions for a few seconds.

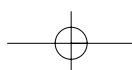

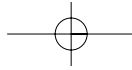

TV

24 Setting V-Chip

● To put the TV/DVD in TV mode, press **SELECT**.

TV Rating Settings

V-CHIP enables parents to prevent their children from watching inappropriate material on TV. V-CHIP reads the ratings for programming (except for news and sports programs, unedited movies on premium cable channels, and Emergency Broadcast System signals), then denies access to programming if the program's rating meets the limitations you select. In this case, a "PROTECTED PROGRAM by ..." message appears on the TV screen.

If the "PROTECTED..." message appears during your TV viewing, change to a channel that is not blocked. Then, you can access the V-Chip Setup Menu and change the settings to allow all TV viewing.

Programming may be rated by the Motion Picture Association of America (MPAA) or according to the Television Parental Guidelines. To block any inappropriate programming, set your limits in both MPAA RATING and TV RATING.

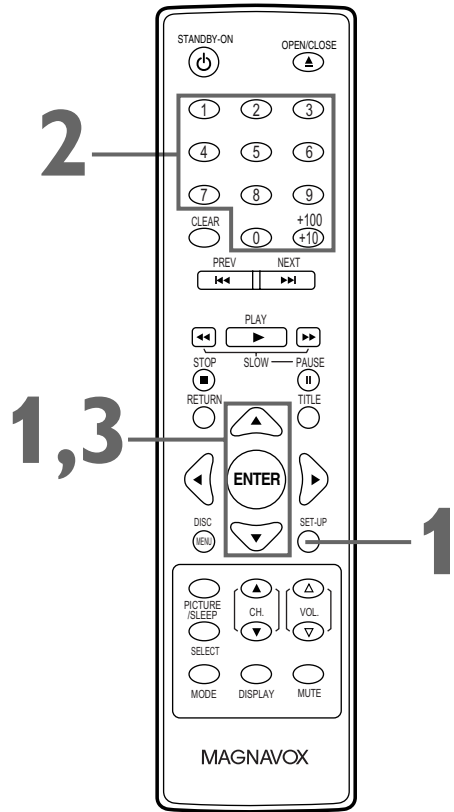

1 Press SET-UP. Press ▲ or ▼ to select V-CHIP SET UP. Then, press ENTER.

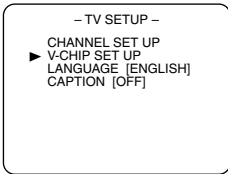

2 Press the Number buttons to enter the 4-digit access code. When entering the access code for the first time or if there has been a power failure, enter default code 0000. 4 Xs will appear instead of your code. This protects the identity of your code.

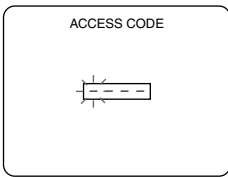

3 Press ▲ or ▼ to select TV RATING. Then, press ENTER.

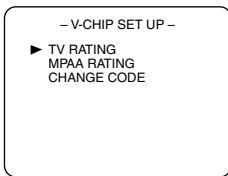

TV Rating Explanations

- TV-Y - Appropriate for all children
- TV-Y7 - Appropriate for children seven and older
- TV-G - General Audience
- TV-PG - Parental Guidance suggested.
- TV-14 - Unsuitable for children under 14
- TV-MA - Mature audience only

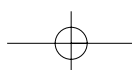

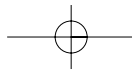

TV

Setting V-Chip (cont'd) 25

4 Press ▲ or ▼ to select the TV Rating level at which you want to block viewing, then press **ENTER** once. If you press ENTER again, the subratings for that category will appear.
Details are on pages 26-27.

When you select the rating category and set it to **BLOCK**, the higher ratings will turn to **BLOCK** automatically. Lower ratings will turn to **VIEW**.
 When you set "TV-Y" to **VIEW** (or **BLOCK**), all ratings will turn to **VIEW** (or **BLOCK**) automatically.

| | | |
|-------|-----|---------|
| TV-Y | () | [VIEW] |
| TV-Y7 | () | [VIEW] |
| TV-G | () | [BLOCK] |
| TV-PG | () | [BLOCK] |
| TV-14 | () | [BLOCK] |
| TV-MA | () | [BLOCK] |

5 Press **SET-UP** to save your settings and remove the menus.

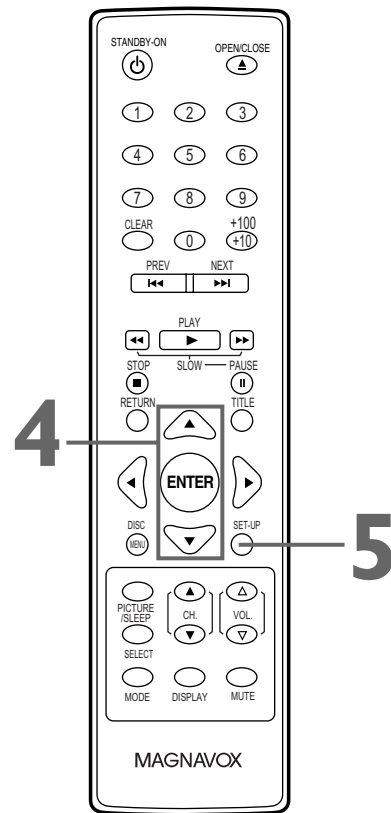

Helpful Hints

- If you want to disable V-Chip so you can view all TV programming, set TV-Y to **VIEW**.
- The V-CHIP Settings will be retained after a power failure (except the access code reverts to 0000).

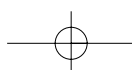

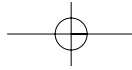

TV

26 Setting V-Chip (cont'd)

TV Rating Subratings

When you select TV-Y7, TV-PG, TV-14 or TV-MA, you can use the subratings to block specific elements of programming, such as language or violence.

1 Press **SET-UP**.

2 Press **▲** or **▼** to select **V-CHIP SET UP**. Press **ENTER**.

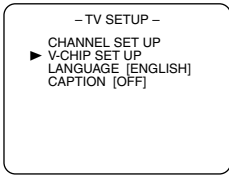

3 Press the **Number** buttons to enter the **4-digit access code**. The default code is 0000 (if you have not set up your own code yet or if there has been a power failure).

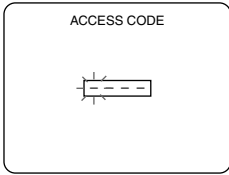

4 Press **▲** or **▼** to select **TV RATING**. Press **ENTER**.

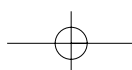
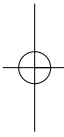
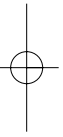
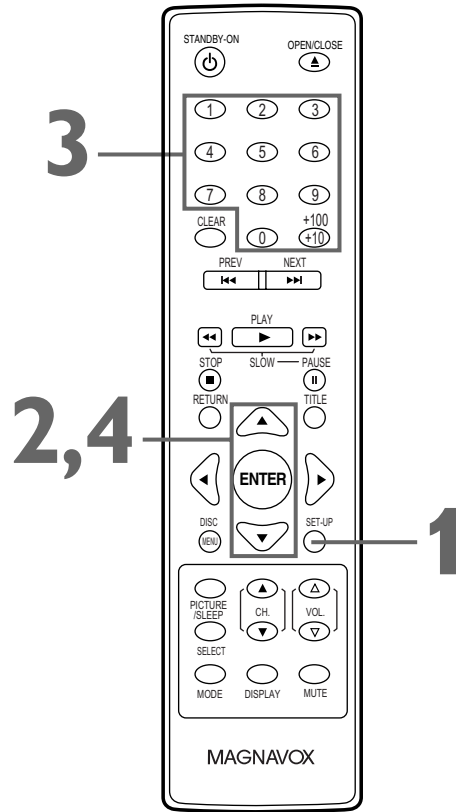
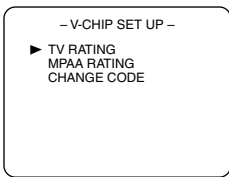

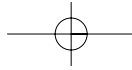

TV

Setting V-Chip (cont'd) 27

5 Press **▲** or **▼** to select the rating you wish to adjust. Then, press **ENTER** twice to go to its subratings.

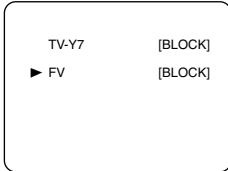

Example:
TV-Y7 subratings

- **When you select TV-Y7:**
Press **▲** or **▼** to select FV (Fantasy Violence, violence that seems realistic to young children). Then, press **ENTER** to select **BLOCK** or **VIEW**.
- **When you select TV-PG, TV-14 or TV-MA:**
Press **▲** or **▼** to select "D" (Suggestive Dialog), "L" (Coarse Language), "S" (Sexual Situation) or "V" (Violence). Then, press **ENTER** repeatedly to select **BLOCK** or **VIEW** for each subrating. To go to the previous menu, press **RETURN**.

6 Press **SET-UP** to save your settings and remove the menus.

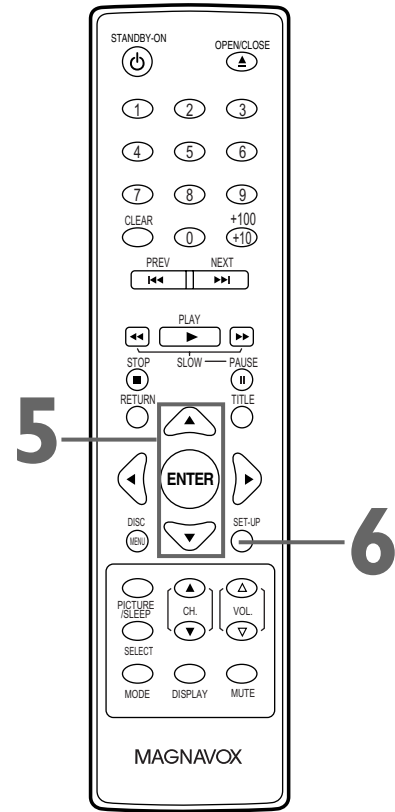

Helpful Hints

- Dialog (D) is not an available subrating for TV-MA.
- Blocked subratings will appear beside the rating category in the TV Ratings Menu.
- You cannot **BLOCK** a subrating (D, L, S or V) if the main category is set to **VIEW**. However, you can set a subrating to **VIEW** even when the main category is set to **BLOCK**.
- Changing the category to **BLOCK** or **VIEW** automatically changes all its subratings to the same (**BLOCK** or **VIEW**).

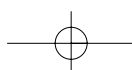

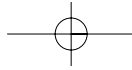

TV

28 Setting V-Chip (cont'd)

MPAA Rating Settings

You can block TV channel viewing according to the Motion Picture of Association ratings. To do so, follow these steps.

1 Press SET-UP.

2 Press ▲ or ▼ to select V-CHIP SET UP. Then, press ENTER.

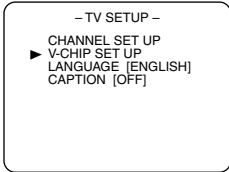

3 Press the Number buttons to enter the 4-digit access code. (The default code is 0000 if you have not set up your own code yet or if the power has failed.)

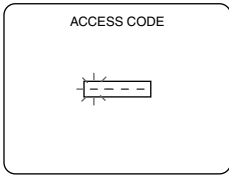

4 Press ▲ or ▼ to select MPAA RATING. Then, press ENTER.

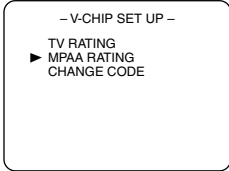

5 Press ▲ or ▼ to select the level at which you want to block viewing. Then, press ENTER to select BLOCK or VIEW.

When you Block a category, higher ratings turn to BLOCK automatically. Lower ratings turn to VIEW. When you set G to VIEW or BLOCK, all ratings turn to VIEW or BLOCK automatically.

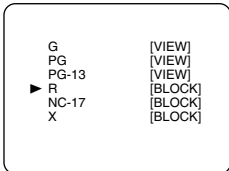

6 Press SET-UP to save your settings and remove the menus.

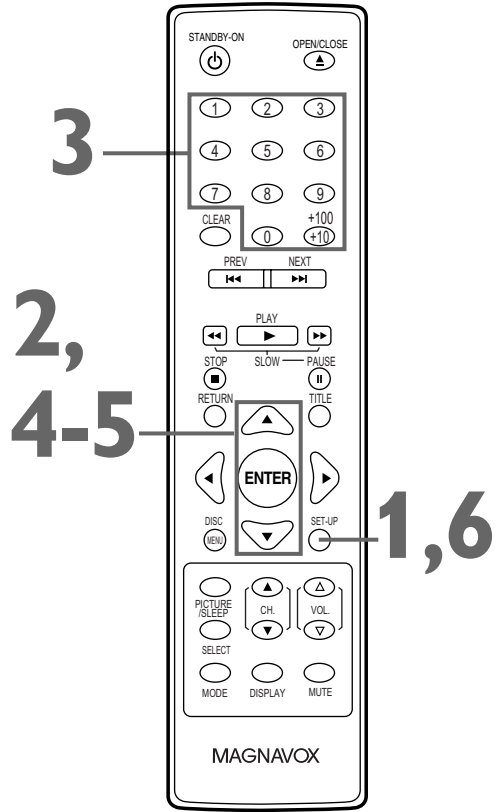

MPAA Rating Explanations

- G - General Audience
- PG - Parental Guidance suggested.
- PG-13 - Unsuitable for children under 13
- R - Restricted; under 17 requires accompanying parent or adult guardian
- NC-17 - No one under 17 admitted
- X - Mature audience only

Helpful Hints

- To disable all the MPAA Ratings, set G to VIEW.
- The V-CHIP Settings will be retained after a power failure (except the access code reverts to 0000).

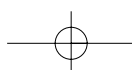

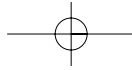

TV

Setting V-Chip (cont'd) 29

Changing the Access Code

Although the default code 0000 is supplied with the TV/DVD, you can set your own access code.

1 Press SET-UP.

2 Press ▲ or ▼ to select V-CHIP SET UP. Then, press ENTER.

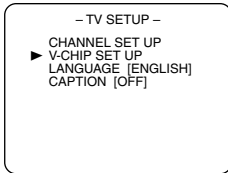

3 Press the Number buttons to enter the old access code. When doing this for the first time, use 0000. 4 Xs will appear instead of the code to protect its identity.

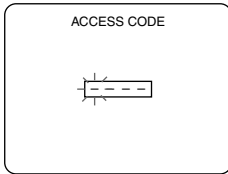

4 Press ▲ or ▼ to select CHANGE CODE. Then, press ENTER.

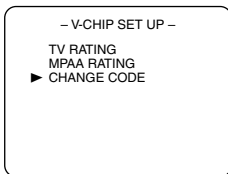

5 Press the Number buttons to enter your preferred access code in the NEW CODE space. Then, enter the same code in the CONFIRM CODE space. Again, Xs will appear instead of the code numbers. The access code must have exactly 4 digits.

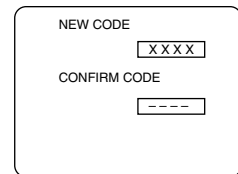

6 Press SET-UP to save your settings and remove the menus.

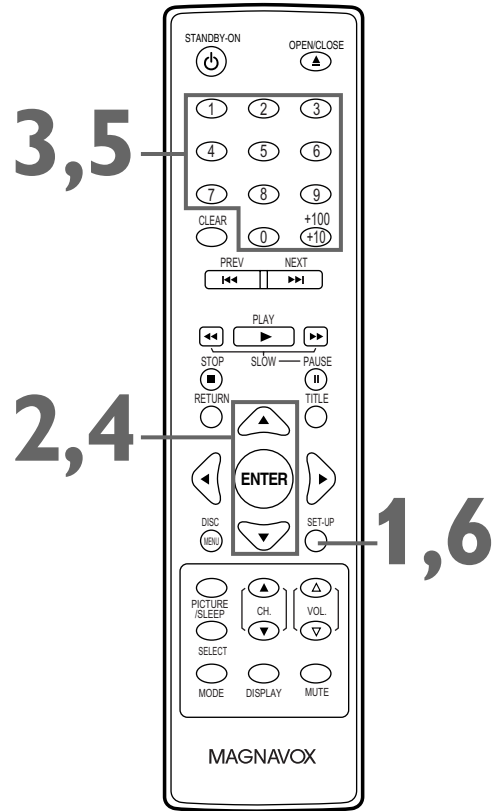

Helpful Hints

- If you enter the wrong code in the CONFIRM CODE space, repeat step 5. Enter the same new code exactly in the CONFIRM CODE space.
- If you unplug the power cord or if the power fails, the default code will be active again (0000). Change your access code again as necessary.

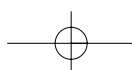

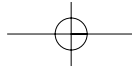

DVD

30 DVD Disc Menus, Title Menus

- To put the TV/DVD in DVD mode, press **SELECT**. Then, press **PLAY** ► or **OPEN/CLOSE** ▲ to activate the DVD mode.

Disc Menus

Some DVDs contain menus that describe the contents of the disc or allow you to customize disc playback. For example, the menu may offer choices for subtitle languages, special features or scene selection. To use the DVD Disc Menu and select playback features, follow these steps.

1 Press DISC MENU.
The DVD's Disc Menu will appear.

2 Press ▲, ▼, ◀ or ▶ to select an item, then press ENTER. Continue this process to set up all the features you want or to start disc playback.

Title Menus

Some DVDs have a Title Menu, which lists the titles available on the DVD. Use the Title Menu to play a specific title.

1 Press TITLE. The Title Menu will appear. If a Title Menu is not available, the "X" may appear on the TV screen. Or, if the DVD only has a main menu as described above, it may appear when you press **TITLE**.

2 Press ▲, ▼, ◀ or ▶ to select a title, then press ENTER. Playback will begin at the title you selected.

Playback Control (PBC) Function

When playing a Video CD with PBC (Playback Control), you can use interactive menu (e.g., playlists) on the TV screen. Refer to instructions accompanying your Video CD for more details on PBC.

Some operations cannot be performed unless the PBC function is cancelled temporarily.

Canceling and calling back the PBC function

1 While playback is stopped, press the Number Buttons to enter a track number.
PBC function is now cancelled and the playback of the Video CD will start.

2 To call back the PBC function, press STOP ■ twice, then press PLAY ►.
The Title menu will appear on the TV screen.

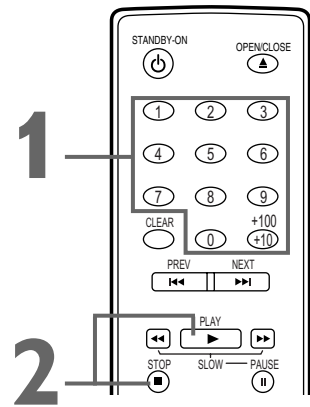
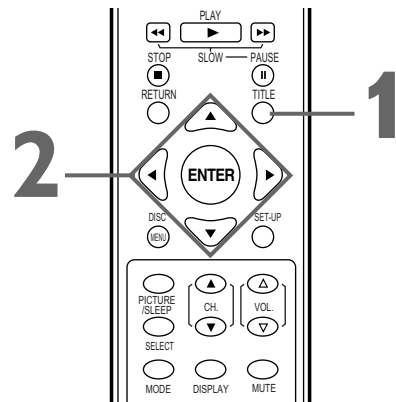
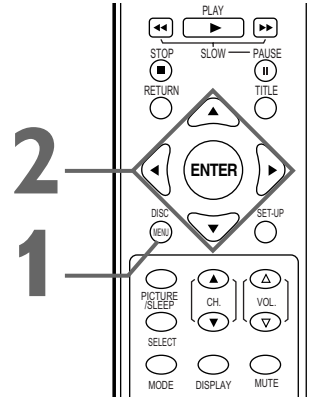

Helpful Hints

- Menus vary among discs. Follow the information with the DVD.
- Not all DVDs have Disc or Title Menus.
- Some DVDs may refer to chapters as "scenes." Some DVDs may refer to the Title Menu as the "scene index."
- TITLE may not be active with all DVDs.

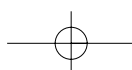

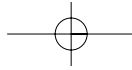

DVD

Fast Forward/Fast Reverse 31

- To put the TV/DVD in DVD mode, press **SELECT**. Then, press **PLAY ▶** or **OPEN/CLOSE ▲** to activate the DVD mode.



1 During playback, press ◀◀ or ▶▶ on the remote control to fast forward or fast reverse the picture.

- For DVD playback, each time you press the button, it will increase the speed by approximately 2, 8, 20, 50 or 100 times the normal speed. The speed may vary depending on the disc.
▶▶ 1, ▶▶ 2, ▶▶ 3, ▶▶ 4 or ▶▶ 5 will appear briefly on the TV screen to indicate Forward Searching. Or, ◀◀ 1, ◀◀ 2, ◀◀ 3, ◀◀ 4 or ◀◀ 5 will indicate Reverse Searching. For DVD playback, the sound will be mute during the search.
- For Video CDs, Audio CDs, MP3 or Windows Media™ Audio playback, the speed will increase by 2, 8 or 30 times the normal speed. The speed may vary depending on the disc.
▶▶ 1, ▶▶ 2 or ▶▶ 3 will appear briefly on the TV screen to indicate Forward Searching. Or, ◀◀ 1, ◀◀ 2 or ◀◀ 3 will indicate Reverse Searching. For Audio CD, MP3 or Windows Media™ Audio playback, the sound will be intermittent during the search. For Video CD playback, the sound will be mute during the search.

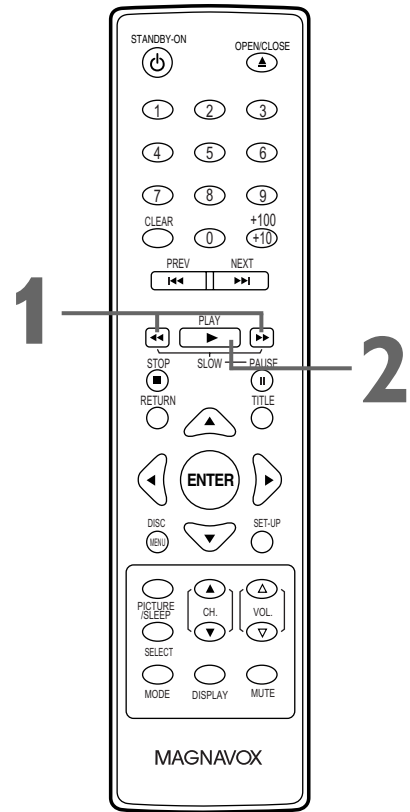

Example: Playing a DVD in reverse at twice the normal playing speed.

2 Press **PLAY ▶** to return to normal playback.

Helpful Hint

- If you use ◀◀ or ▶▶ during Dual Playback, JPEG playback will be paused.

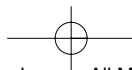

DVD

32 Chapter/Title/Time Search

- To put the TV/DVD in DVD mode, press **SELECT**. Then, press **PLAY**  or **OPEN/CLOSE**  to activate the DVD mode.

- 1** During disc playback, press **MODE** repeatedly until the Search Menu appears in the information bar at the top of the screen.

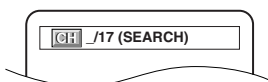

Then proceed to the step 2 of your desired search mode.

Chapter Search

- 2** Enter the chapter number you want to search in the input field in the information bar using the **Number** buttons. The chapter will play.
 - To play a single-digit chapter when there are more than 10 sections, press **ENTER** after entering the chapter number.
 - If you enter the chapter number that is not available on the disc, playback will not begin (or the current chapter will continue to play).

Title Search

- 2** Press **▲** or **▼** repeatedly until  appears.

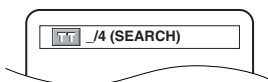

- 3** Enter the title number you want to search in the input field using the **Number** buttons. The title will play.
 - To play a single-digit title when there are more than 10 selections, press **ENTER** after entering the title number.
 - If you enter the title number that is not available on the disc, playback will not begin (or the current title will continue to play).

Time Search

- 2** Press **▲** or **▼** repeatedly until  appears.

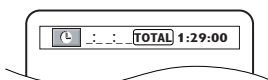

- 3** Within 1 minute, use the **Number** buttons to enter the elapsed playing time (of the track or title) at which you want play to begin. Enter the time in hours, minutes and seconds. Within a few seconds, playback will start at the specified time.
 - Example: 1 hour, 23 minutes and 30 seconds
1 → 2 → 3 → 3 → 0
 - Make sure the time you enter is within the total time of the current title or track. If it is not, the time space will clear and playback will continue at its current point. The total time available in the current track or title will be displayed in the information bar.
 - If you make a mistake entering the time, press **CLEAR** to clear the time area. Enter the correct information.

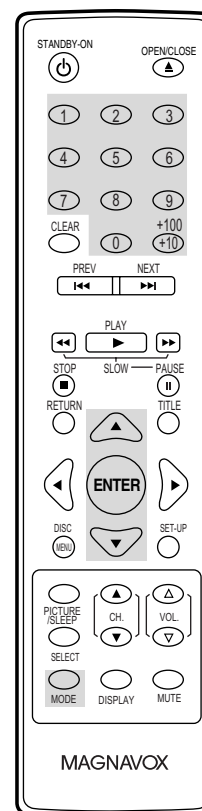

Helpful Hints

- When playback is stopped, use the Number buttons to select a title for immediate playback. During playback, use the Number buttons to choose a chapter for immediate playback.
- Title/Chapter Playback is not available with some DVDs.
- Time Search is not available for MP3, Windows Media™ Audio and JPEG files.

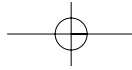

DVD

Track Search 33

- To put the TV/DVD in DVD mode, press **SELECT**. Then, press **PLAY** ► or **OPEN/CLOSE** ▲ to activate the DVD mode.

Track Search



There are three ways to search for a track. Refer to A-C below.

A

Using the Number Buttons

To select a single digit track number: press the number directly. Playback of the selected track will start automatically.

To select 2 digit track number:

- If the disc contains more than 9 and less than 100 tracks (total track number is 2 digit), press +100/+10 button first. Then enter the track number. For example if you want to select track 26, press +100/+10 first, then press 2 and 6.

- If the disc contains more than 99 tracks (total track number is 3 digit), press +100/+10 button then press 0. Then enter the track number. Or press +100/+10 first, enter the track number, then press ENTER at the last.

To select 3 digit track number: Press +100/+10 first. Then enter the track number.

If you enter a track number that is not available on the disc, playback will not begin (or the current track will continue to play).

B

Using PREV ◀◀ and NEXT ▶▶

During playback, press NEXT ▶▶ to skip the current track and move to the next track.

Press PREV ◀◀ to return to the beginning of the current track or to go to previous tracks.

(For JPEG playback, you also can use ◀ or ▶.)

C

Using MODE

- 1** During disc playback, press **MODE** repeatedly until the Search Menu appears in the information bar at the top of the screen.

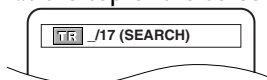

2

Press ▲ or ▼ repeatedly until TR appears. Within 1 minute, enter the desired track number using the Number buttons.

To select a single digit track number: Press 0 first. (If the total track number is more than 9 and less than 100, press 0 once. If the total track number is more than 99, press 0 twice.) Then enter the track number.

To select 2 digit track number:

- If the disc contains more than 9 and less than 100 tracks (total track number is 2 digit), enter the track number directly.
- If the disc contains more than 99 tracks (total track number is 3 digit), press 0 first. Then enter the track number. Or enter the track number, then press ENTER at the last.

To select 3 digit track number: Enter the track number directly.

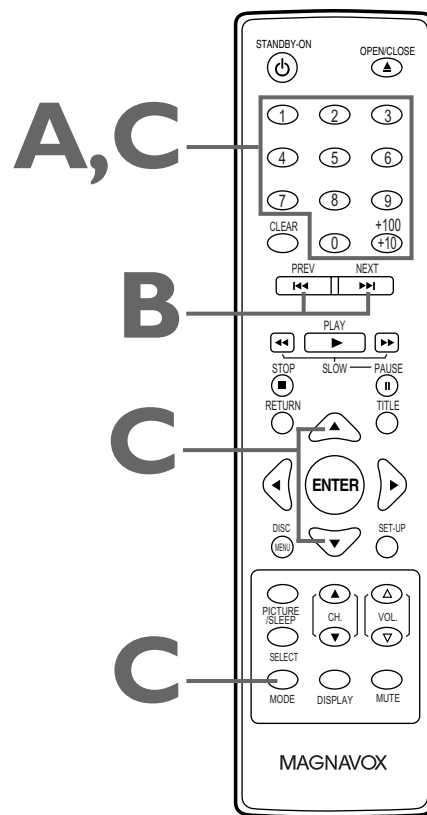

Helpful Hints

- PREV ◀◀ and NEXT ▶▶ does not function when playback is stopped.
- You cannot use NEXT ▶▶ to go from the last track on the disc to the first track.
- Using PREV ◀◀ or NEXT ▶▶ during Dual Playback will only affect MP3 files. If you want to skip JPEG files during Dual Playback, press ◀ or ▶.

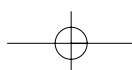

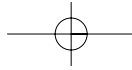

DVD

34 Paused and Step-by-Step Playback, Resume On

- To put the TV/DVD in DVD mode, press **SELECT**. Then, press **PLAY** ► or **OPEN/CLOSE** ▲ to activate the DVD mode.

Paused Playback



Step-by-Step Playback



- 1 During disc playback, press PAUSE** ■. Playback will pause and the sound will be mute.
 - Pressing **PAUSE** ■ once during Dual Playback will pause a JPEG file only. Pressing **PAUSE** ■ one more time will pause an MP3 playback.
- 2 Press PAUSE** ■ repeatedly to see a DVD or Video CD picture advance one frame (or step) at a time. The sound will remain mute. Pressing **PAUSE** ■ repeatedly during Audio CD, MP3, Windows Media™ Audio or JPEG playback will have no effect.
- 3 Press PLAY** ► to resume playback.

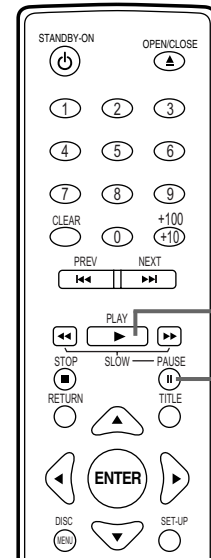

Resume On



- 1 Press STOP** ■ during playback. In a few seconds, the following Resume message will appear on the TV screen.

For DVD, VideoCD or AudioCD:

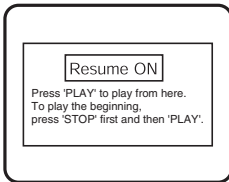

For MP3, Windows Media™ Audio or JPEG:

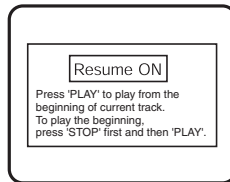

- 2 Press PLAY** ►. In a few seconds, playback will resume from the point at which it stopped last. You can resume playing at the same point even if you turn off the TV/DVD, then turn it on again later. However, opening the disc tray will cancel the Resume feature. Playback will start at the beginning the next time you insert the disc. For MP3, Windows Media™ Audio and JPEG, the playback will resume from the beginning of the current track. To cancel the Resume feature, press **STOP** ■ again while playback is stopped. The resume information will be saved even when the power is turned off.

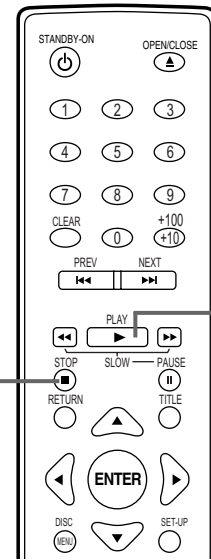

Helpful Hint

- Set **STILL MODE** to **FIELD** in the Display Menu if paused images are blurry. Details are on pages 48-49.

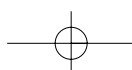

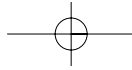

DVD

Repeat, A-B Repeat 35

- To put the TV/DVD in DVD mode, press **SELECT**. Then, press **PLAY** ► or **OPEN/CLOSE** ▲ to activate the DVD mode.

Repeat

- 1** During disc playback, press **MODE** repeatedly until the Repeat Menu appears in the information bar at the top of the screen.

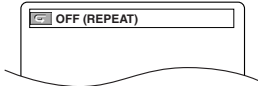

Press ▲ or ▼ repeatedly to change the repeat mode.

- Select CHAPTER, TITLE or OFF for DVDs.
- Select TRACK, ALL (all tracks on the disc) or OFF for VCDs without PBC function or Audio CDs.
- Select TRACK, GROUP (all tracks in the current folder), ALL or OFF for MP3, Windows Media™ Audio or JPEG files.

Selecting a new track, chapter or title will cancel Repeat Playback.

- During Programmed Playback, Repeat Setting will be effective for the tracks in the program.

A-B Repeat

Follow these steps to play a section of a DVD, Video CD or Audio CD repeatedly.

- 1** During disc playback, press **MODE** repeatedly until the A-B Repeat Menu appears in the information bar at the top of the screen.



- 2** Play the disc up to the point where you want to set the start point, then press **ENTER** to set the starting point (A). If you make a mistake, press **CLEAR**. This will erase point A and let you start over. OFF will appear briefly on the TV screen.

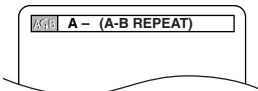

- 3** Play the disc up to the point where you want to set the end point, then press **ENTER** again. Within a few seconds, the section will begin to play. The segment will play over and over until you cancel the A-B Repeat feature.

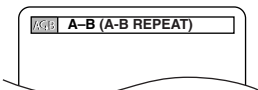

- 4** To cancel A-B Repeat Playback, press **MODE** repeatedly until A-B appears. Press **ENTER** so OFF appears on the TV screen. Regular playback will resume.

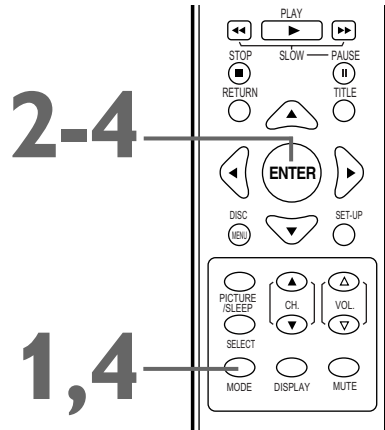
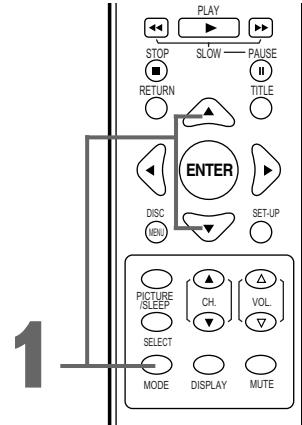

Helpful Hints

- Repeat and A-B Repeat are not available with some discs.
- A-B Repeat is not available with MP3, Windows Media™ Audio and JPEG playback.
- The entire A-B Repeat section must be within a single title or track. If you do not enter Point B before the end of the track or title is reached, the end of the track or title will become Point B automatically.
- Stopping playback will cancel A-B Repeat.
- If you choose GROUP Repeat during Dual Playback, all tracks or files in each folder will play repeatedly. For example if you choose GROUP Repeat during Dual Playback of MP3 folder A and JPEG folder B, all MP3 tracks in folder A and all JPEG files in folder B will be repeated.

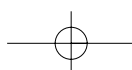

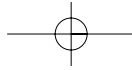

DVD

36 Markers

- To put the TV/DVD in DVD mode, press **SELECT**. Then, press **PLAY** ► or **OPEN/CLOSE** ▲ to activate the DVD mode.

Marker Setting/Marker Search



You can put marks on your favorite playback points and can easily call them back later during playback.

- 1** During disc playback, press **MODE** repeatedly until the Search Menu appears in the information bar at the top of the screen.

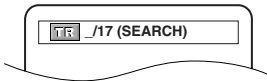

- 2** Press **▲** or **▼** repeatedly until the Marker information appears in the information bar.

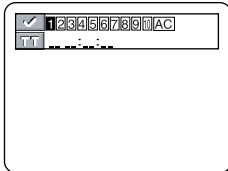

Example: DVD

- 3** Within 1 minute, press **◀** or **▶** to select a **Marker (1-10)**. Make sure **__ : __ : __** appears beneath the number.

- 4** Let the disc playback to the point at which you want to set the Marker (up to 60 seconds away).

When the disc reaches the point you want to remember, press **ENTER**. The title or track number and its elapsed playing time will appear beneath the markers.

A checkmark will replace the Marker number. The Marker information will disappear in about 1 minute. Otherwise press **RETURN**.

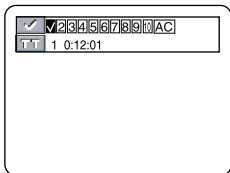

Example: DVD

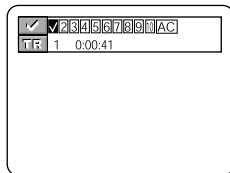

Example: Video CD or Audio CD

- 5** To search for a specific Marker, repeat steps 1 and 2. Press **◀** or **▶** to choose the Marker you want. Press **ENTER**. The playback will start from the selected point.

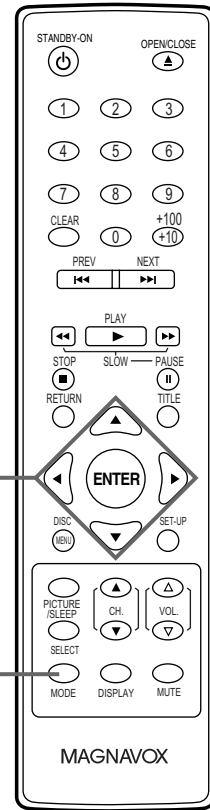

Helpful Hints

- Opening the disc tray, switching to TV mode, or turning off the TV/DVD will erase all the Markers.
- To erase a single Marker, repeat steps 1 and 2. Press **◀** or **▶** to select a Marker. Press **CLEAR**. Press **RETURN** to remove the information bar.
To erase all the Markers, select **AC (All Clear)**, then press **ENTER**.

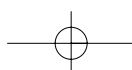

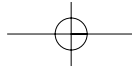

DVD

Subtitles, Camera Angles 37

- To put the TV/DVD in DVD mode, press SELECT. Then, press PLAY ► or OPEN/CLOSE ▲ to activate the DVD mode.

Subtitles

You can select a language for DVD subtitles during playback. You may select only the subtitles that are available on the DVD.

- 1 During disc playback, press MODE repeatedly until the Subtitle Menu appears in the information bar at the top of the screen.

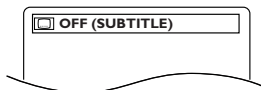

Press ▲ or ▼ repeatedly to change the language.

The number of available languages are displayed at the right of the current subtitle language. In the example below, six languages are available (/6). After a few seconds, the subtitles will appear.

When no subtitles are available, "NOT AVAILABLE" will appear in the information bar.

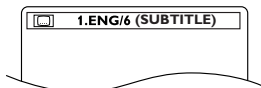

Example: English as first of six available subtitles

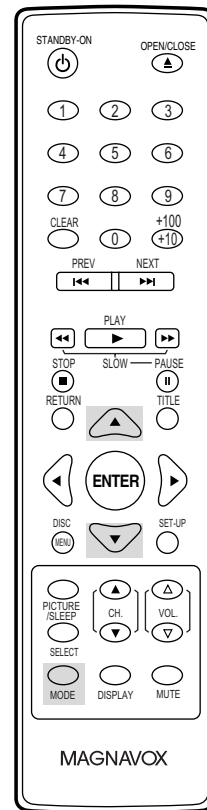

Camera Angles

Some DVDs contain scenes recorded from different angles. The camera angle will not change if the DVD does not contain sequences recorded from different perspectives.

- 1 During disc playback, press MODE repeatedly until the Angle Menu appears in the information bar at the top of the screen.

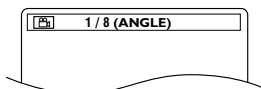

Press ▲ or ▼ repeatedly to change the angle.

The number of available angles are displayed at the right of the current angle. In this example, eight angles are available (/8).

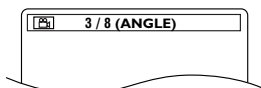

Example: Angle 3 of eight available angles

Helpful Hints

- With some DVDs, you must select a subtitle language in the Disc Menu.
- If the desired language does not appear after pressing ▲ or ▼ several times, the disc does not have subtitles in that language.
- Opening the disc tray will cancel your Subtitle Setting.
- If the ANGLE ICON Setting is ON,  will appear on the TV screen when the current portion of the disc has multiple camera angles. To set the ANGLE ICON ON or OFF, see pages 54-55.

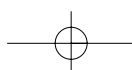

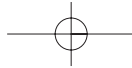

DVD

38 Slow Motion, Zoom

- To put the TV/DVD in DVD mode, press **SELECT**. Then, press **PLAY** ► or **OPEN/CLOSE** ▲ to activate the DVD mode.

Slow Motion

- 1** During disc playback, press **PAUSE** II.
- 2** Press ◀◀ or ▶▶. Slow Motion Playback will begin. Press ◀◀ or ▶▶ repeatedly to play the DVD forward or backward at approximately 1/16, 1/8 or 1/2 the normal speed. Reverse slow motion is not available on a Video CD. An ► 1 (1/16), ► 2 (1/8) or ► 3 (1/2) will appear briefly on the TV screen to indicate Slow Forward Playback. An ◀ 1 (1/16), ◀ 2 (1/8) or ◀ 3 (1/2) will indicate Slow Reverse Playback.



Example: Playing a DVD forward at half the normal speed.

- 3** Press **PLAY** ► to return to normal playback.

Zoom

Zooming lets you enlarge the playback image of a DVDs, Video CDs or JPEG CDs, and lets you pan through the enlarged image.

- 1** During disc playback, press **MODE** repeatedly until **OFF (ZOOM)** appears in the information bar at the top of the screen.
- 2** Press **ENTER** repeatedly to change the zoom factor. Each press of **ENTER** will change the factor as shown below.

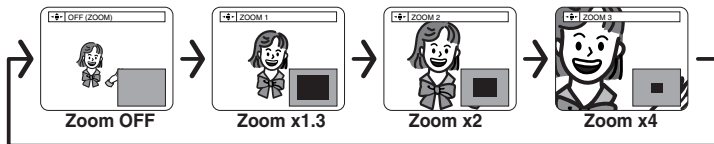

- 3** Press ▲, ▼, ◀ or ▶ to move the zoomed image up, down, left or right.



Position guide example: The Zoomed area is in the top portion of the overall picture.

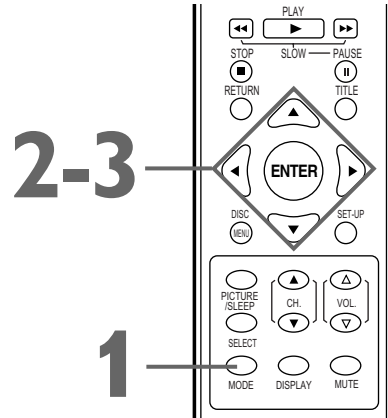
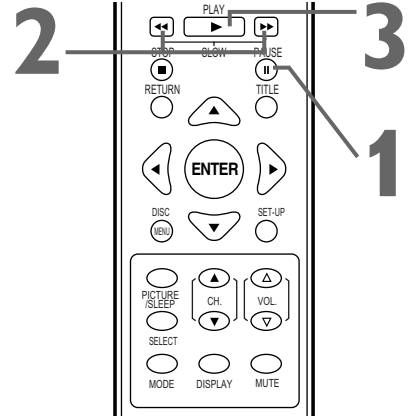

Helpful Hints

- The sound will be mute during Slow Motion Playback.
- The gray box with an inner blue box that shows during Zoomed Playback is the position guide. Position guide stays on the screen while the information bar is shown. To remove it or show it, press ENTER after the information bar disappears. Or remove the information bar by pressing RETURN, then press ENTER. The position of the blue box inside the gray box indicates the position of the zoomed image within the overall picture.
- The x4 zooming is not active with some discs. x1.3 and x2 zooming is available for Video CDs. Only x2 zooming is available for JPEGs.
- Position guide is not available for JPEG playback.



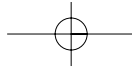

DVD

Audio Language, Stereo Sound 39

- To put the TV/DVD in DVD mode, press SELECT. Then, press PLAY ► or OPEN/CLOSE ▲ to activate the DVD mode.

Audio Language

You can select a language for DVDs during playback if multiple languages are available.

- 1 During disc playback, press MODE repeatedly until the Audio Language Menu appears in the information bar at the top of the screen.

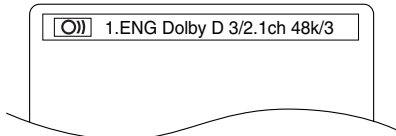

Example: English Audio

Press ▲ or ▼ repeatedly to change the language. The new audio will be heard. The information bar will disappear after about 1 minute. The Audio information may include the current settings for the Dolby Digital or Multi-channel sound, if they are available on the disc, and the sampling rate of the disc. The number of available languages are displayed at the right end of the information bar (/3, for example).

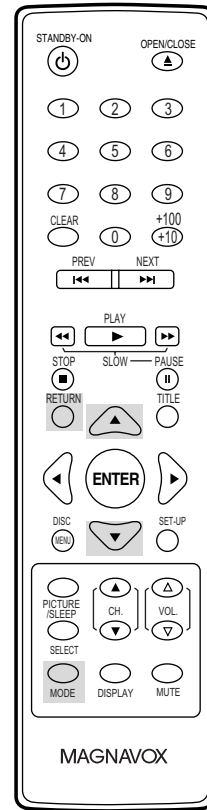

Stereo Sound

Adjust Stereo Sound to determine whether you will hear the left channel, the right channel or both channels (stereo) during Video CD or Audio CD playback.

- 1 During disc playback, press MODE repeatedly until the Stereo Menu appears in the information bar at the top of the screen. Press ▲ or ▼ to change the Stereo Setting. The setting will change in the order illustrated below. The information bar will disappear in about 1 minute.

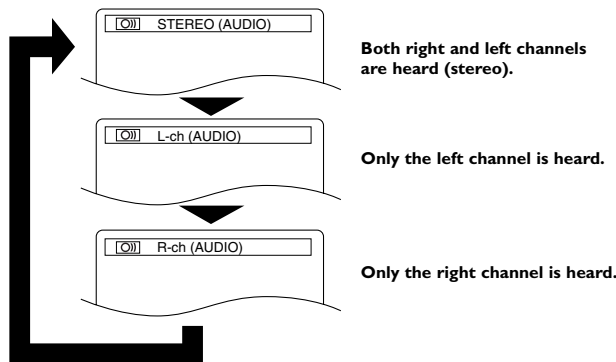

Press RETURN to remove the information bar.

Helpful Hints

- If a language is not available after pressing ▲ or ▼ several times, the DVD does not have that language.
- Some DVDs only let you change the language in the Disc Menu.
- Audio languages may be abbreviated (such as ENG for English). Or, 3 dashes (- - -) may appear instead of an abbreviation.

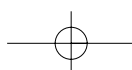

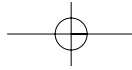

DVD

40 On-Screen Displays

- To put the TV/DVD in DVD mode, press **SELECT**. Then, press **PLAY** ► or **OPEN/CLOSE** ▲ to activate the DVD mode.

DVD Display

- 1 Press **DISPLAY** repeatedly to show the following information on the screen during DVD playback.

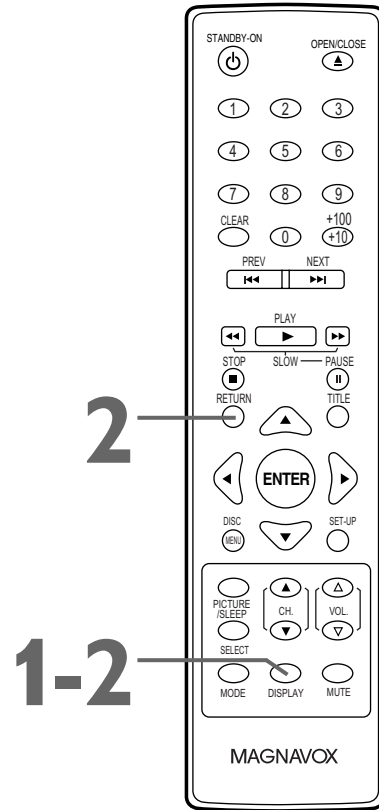
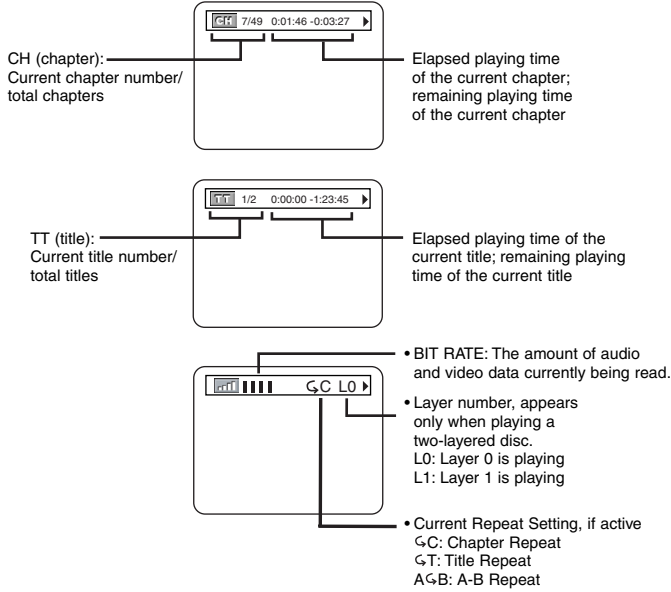

- 2 Press **DISPLAY** repeatedly or press **RETURN** to remove the information from the screen.

Video CD and Audio CD Display

- 1 Press **DISPLAY** repeatedly to show the following information on the screen during Video CD (without PBC) or Audio CD playback.

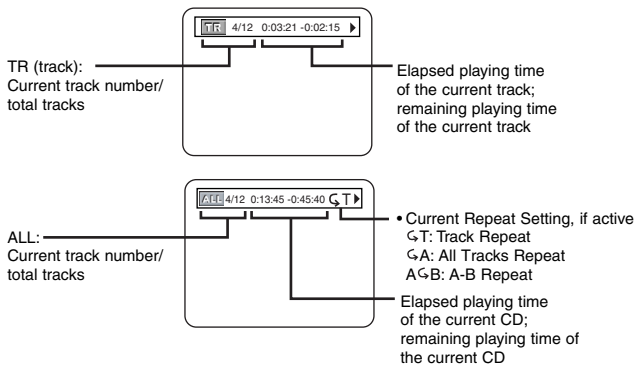

- 2 Press **DISPLAY** repeatedly or press **RETURN** to remove the information from the screen.

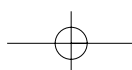

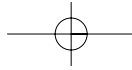

DVD

On-Screen Displays (cont'd) 41

- To put the TV/DVD in DVD mode, press SELECT. Then, press PLAY ► or OPEN/CLOSE ▲ to activate the DVD mode.

MP3/Windows Media™ Audio/JPEG Displays

1 Press DISPLAY until the current track or file information appears.

During JPEG playback

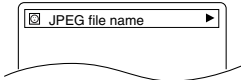

or

During MP3 playback

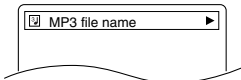

During Windows Media™ Audio playback

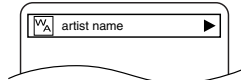
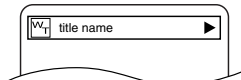
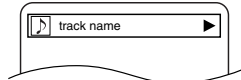

- If Dual Playback is on, MP3 file name will be displayed after JPEG file name.

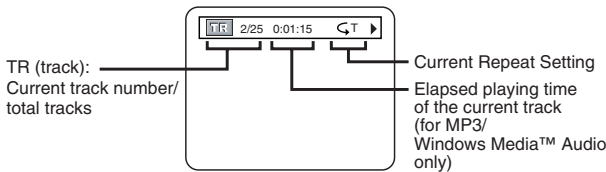

Example: MP3 playback

The following may appear to indicate Repeat Playback.

- ☞ T : The current track will play repeatedly.
- ☞ G : Tracks in the current folder (group) will play repeatedly.
- ☞ A : All tracks will play repeatedly.

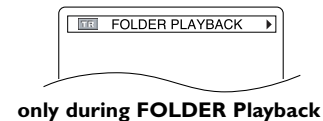
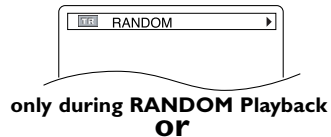
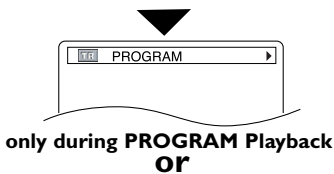

- Program and Random Playback is available only when DUAL PLAYBACK is OFF.
- Folder Playback is available only when DUAL PLAYBACK is ON.

2 Press DISPLAY again to remove the display.

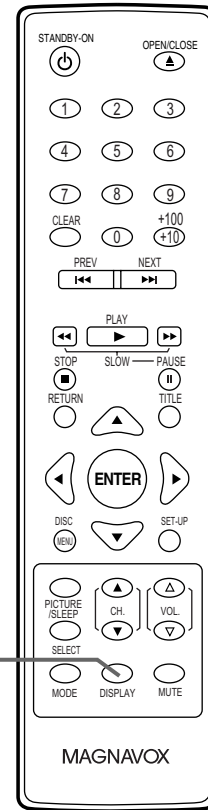

Helpful Hint

- For MP3/Windows Media™ Audio files recorded in Variable Bit Rate (VBR), the elapsed time displayed on the screen may vary from the actual elapsed time.

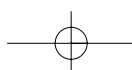

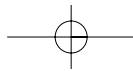

DVD

42 Black Level, Virtual Surround, Initializing

- To put the TV/DVD in DVD mode, press **SELECT**. Then, press **PLAY** ► or **OPEN/CLOSE** ▲ to activate the DVD mode.

Black Level

Adjust Black Level to brighten the DVD and Video CD picture during playback.

- 1 During disc playback, press **MODE** repeatedly until the Black Level Menu appears in the information bar at the top of the screen.



- 2 Within 1 minute, press ▲ or ▼ to switch **ON** or **OFF**. ON brightens the dark parts of the picture. OFF shows the original picture as recorded.

Virtual Surround



You can enjoy improved stereo sound when you play DVDs, Video CDs, Audio CDs, MP3 or Windows Media™ Audio files recorded in Dolby Digital or Pulse Code Modulation (PCM). Check the disc case for details on availability.

- 1 During disc playback, press **MODE** repeatedly until the Virtual Surround Menu appears in the information bar at the top of the screen.



- 2 While the information bar is on the screen, press ▲ or ▼ to change **1**, **2** or **OFF**. The default setting is OFF. The information bar will disappear after about 1 minute.

Initializing

You can return all the DVD player's Setup Menu items (except for PARENTAL) to their default settings.

- 1 While playback is stopped, press **SET-UP** twice. The QUICK SETUP Screen appears.

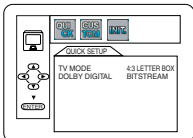

- 2 Press ◀ or ▶ to select **INIT. (INITIALIZE)** at the top of the menu, then press **ENTER**.

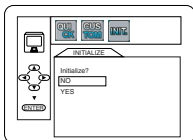

- 3 Press ▲ or ▼ to select **YES**. Then, press **ENTER** twice. To cancel, select **NO** instead.

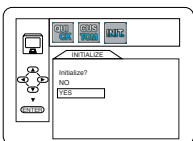

- 4 Press **SET-UP** to remove the menu.

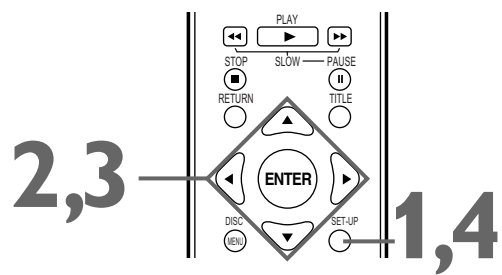
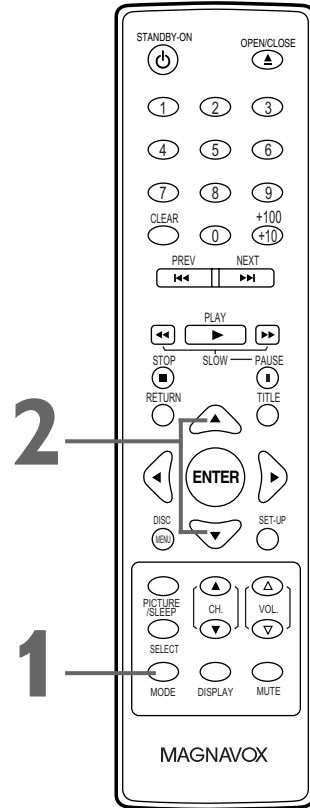

Helpful Hints

- For Video CDs and Audio CDs, you can adjust Virtual Surround only if you set Stereo Sound to STEREO. Details are on page 39.
- The Black Level and Virtual Surround Settings will be saved even if the player is turned off.

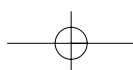

Random Playback, Program Playback 43

- To put the TV/DVD in DVD mode, press **SELECT**. Then, press **PLAY** ► or **OPEN/CLOSE** ▲ to activate the DVD mode.

Random Playback

You may play the tracks / files in Random order instead of the order in which they are recorded (1, 2, 3...).

- 1 While playback is stopped, press **MODE** until the **RANDOM** Screen appears.

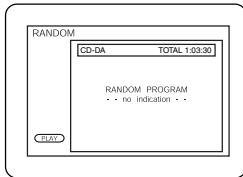

Example: Audio CD

- 2 Press **PLAY** ►. The tracks will play in random order. After all the tracks have played once, playback will stop.

Program Playback

You may determine the order in which the tracks / files will play. To set a program, follow these steps.

- 1 While playback is stopped, press **MODE** until the **PROGRAM** Screen appears.
- 2 Press ▲ or ▼ to select a track you want to play, then press **ENTER**.

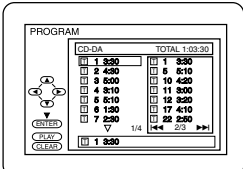

Example: Audio CD

Press **CLEAR** to erase the last track in the program if you make an error.

Additional tracks may be on other screens. press ▼ to go on to the next page, and press ▲ to go back to the previous page.

Repeat this step until you have selected all the tracks you wish to play in the program.

To see tracks in a program when there are more than eight tracks, use **PREV** ◀◀ and **NEXT** ▶▶ to see all the tracks.

For MP3, Windows Media™ Audio or JPEG folders, press ◀ or ▶ to go to the previous or next level of folders. Press **TITLE** to return to the first item in the highest level.

- 3 Press **PLAY** ►. The tracks will play once in the order you set. Turning off the TV/DVD or opening the disc tray will erase the program. You can start Program Playback only while in the **PROGRAM** Screen.

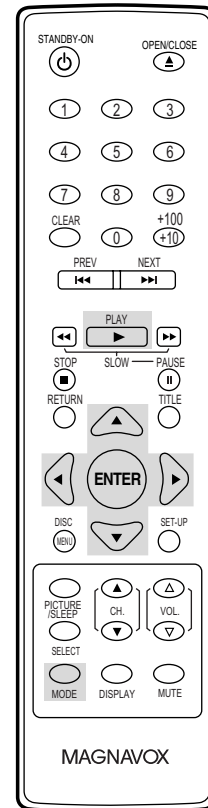

Helpful Hints

- You cannot use the Number buttons to select another track while playing a program. Press **PREV** ◀◀ or **NEXT** ▶▶ to select other tracks in the program.
- You cannot combine Random Playback with Programmed Playback.
- You cannot alter a program during playback.
- You can start Program Playback only while in the **PROGRAM** Screen.
- A program can have a maximum of 99 tracks.
- To erase all tracks in the program, select **ALL CLEAR** at step 2.
- Program/Random Playback of MP3, Windows Media™ Audio or JPEG tracks is not available while Dual Playback is ON.

DVD

44 MP3/Windows Media™ Audio/JPEG Playback

- To put the TV/DVD in DVD mode, press **SELECT**. Then, press **PLAY ►** or **OPEN/CLOSE ▲** to activate the DVD mode.

The DVD player will play MP3, Windows Media™ Audio and JPEG files that you record and finalize on a CD-R (Compact Disc-Recordable) or CD-RW (Compact Disc-Rewritable).



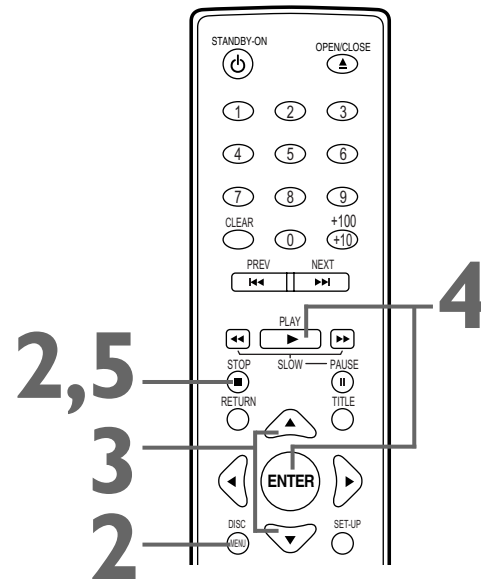

- You cannot make or record such discs using this unit. See your computer manual for details on making or recording such discs. Keep the characteristics listed below in mind when making discs.
- Record MP3 files at a sampling frequency of 44.1 kHz or 48 kHz. Record in a constant bit rate between 32 kbps and 320 kbps.
- Record Windows Media™ Audio files at a sampling frequency of 44.1 kHz or 48 kHz. Record in a constant bit rate between 48 kbps and 192 kbps.
- When recording JPEG files, the size of the picture should be between 32 x 32 and 6300 x 5100 dots.

To play the files from the File List follow the steps below.

- 1** Load a CD-R or CD-RW with MP3, Windows Media™ Audio or JPEG files. The first file in the File List will start to play automatically.
- 2** Press **DISC MENU** to call up the File List during playback. Or press **STOP ■** twice to stop the playback. (File List will appear whenever the playback is stopped completely.)
- 3** Press **▲** or **▼** to select a folder or a file.
- 4** If you choose a track or file, press **PLAY ►** or **ENTER**. Starting with the track or file you selected, the tracks/files will play in the order they were recorded, i.e. 1, 2, 3.
If you select a folder and press **ENTER**, the tracks or files within that folder will appear. Press **▲** or **▼** to select the track or file you want, then press **PLAY ►** or **ENTER**.
 - Press **TITLE** to return to the first item in the highest level of folders or files.
 - Press **◀** or **▶** to return to previous or next levels.
 - To change the TRANSITION MODE of JPEG playback, press **MODE** repeatedly during playback until **FADE IN/OUT** or **CUT IN/OUT** appears. Then press **▲** or **▼** to switch **CUT IN/OUT** and **FADE IN/OUT**. If you choose **CUT IN/OUT**, the images will cut in and out sharply as playback progresses. If you choose **FADE IN/OUT**, the images will fade in and out as playback progresses.
 - To change the size of the playback image, press **MODE** repeatedly until **SIZE** appears at the top of the TV screen during playback. Then press **ENTER** to switch between **NORMAL(100%)** and **SMALL(95%)**.
 - To remove the On-Screen Display, press **RETURN**.
 - During JPEG playback, press **▲** or **▼** to rotate a picture 90 degrees counter-clockwise or clockwise.
- 5** To stop playback, press **STOP ■**.



Helpful Hints

- MP3 tracks, Windows Media™ Audio tracks and JPEG images are known as files. Groups of files are called folders.
- Folders have the  icon.
- MP3 files have the  icon.
- Windows Media™ Audio files have the  icon.
- JPEG files have the  icon.
- A maximum of 255 folders can be recognized. A maximum of 999 files can be recognized.
- During playback, press the Number buttons to select another track. Or, press **PREV ◀◀** or **NEXT ▶▶** to change tracks. If a track is not available, "X" may appear on the TV screen, and playback may resume at an incorrect track or may continue with its current track.
- Specific Time Playback is not possible with MP3 and Windows Media™ Audio files.
- Progressive JPEGs (JPEG files saved in the progressive format) will not play on this TV/DVD.
- Copyright protected Windows Media™ Audio files will not play on this TV/DVD.
- High resolution JPEG files takes longer to be displayed.
- **SIZE CHANGE MODE** may have no effect on some files (e.g. files with a small picture size).

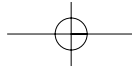

DVD

Dual Playback, Folder Playback 45

- To put the TV/DVD in DVD mode, press SELECT. Then, press PLAY ► or OPEN/CLOSE ▲ to activate the DVD mode.

Dual Playback

This feature lets you play MP3 and JPEG files simultaneously. Available only when Dual Playback is ON. See pages 54-55 on how to set the Dual Playback ON or OFF.

- 1 Press DISC MENU during MP3/JPEG playback.**
A File List will appear.
- 2 Press ▲ or ▼ to select a desired MP3/JPEG file from the list and press PLAY ► or ENTER.**
- 3 To stop playback, press STOP ■.**

Folder Playback

You may select to play a folder. Available only when Dual Playback is ON. See pages 54-55 on how to set the Dual Playback ON or OFF.

- 1 While playback is stopped, press MODE.**
A Folder List will appear.
- 2 Press ▲ or ▼ to select a folder, then press PLAY ► or ENTER.**
 - MP3 and JPEG files in the selected folder will play simultaneously.

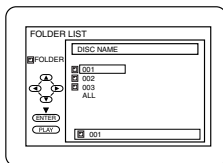

- If Windows Media™ Audio files are in the folder, those files will be skipped during Folder Playback.

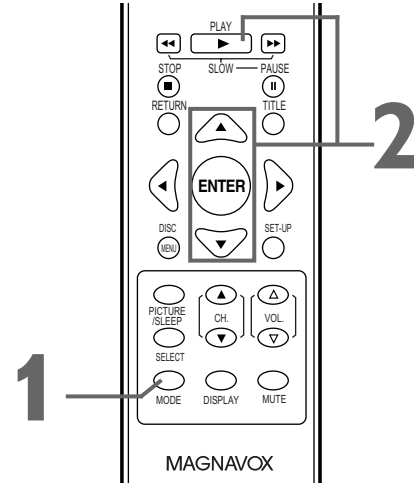
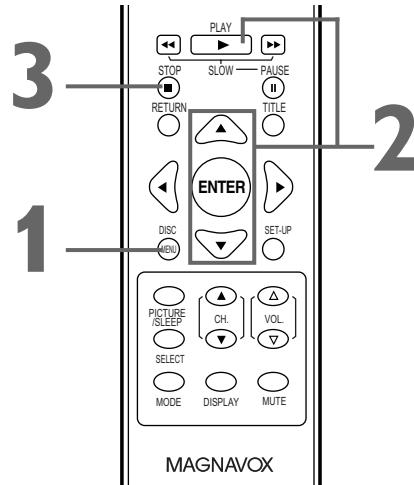

Helpful Hints

- If you press PLAY ► directly after you inserted a disc which contains both MP3 and JPEG files and if the Dual Playback Setting is ON, Dual Playback will start automatically.
- You can not play Windows Media™ Audio and JPEG files together at the same time. If you choose a Windows Media™ Audio file during Dual Playback, only Windows Media™ Audio file will play.
- Zooming or rotating a JPEG file during Dual Playback may cause an intermittent sound.
- Dual Playback may not function properly if MP3 and JPEG files on the disc interfere each other due to the difference in their data size.

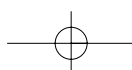

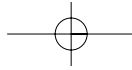

DVD

46 Language Settings

- To put the TV/DVD in DVD mode, press **SELECT**. Then, press **PLAY** ► or **OPEN/CLOSE** ▲ to activate the DVD mode.



You can use the LANGUAGE Settings to select different languages for the Audio or Subtitles of DVDs, as well as languages for DVD Disc Menus.

- Press **SET-UP** once so the TV SETUP Menu appears.

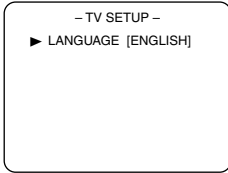

- While playback is stopped, press **SET-UP** again. The QUICK SETUP Screen appears.

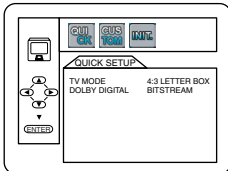

- Press **◀** or **▶** to select **CUSTOM** at the top of the menu, then press **ENTER**.

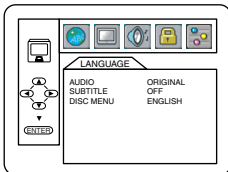

- (LANGUAGE) will be selected. Press **ENTER**.

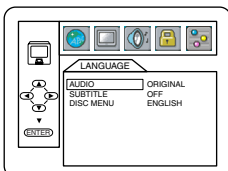

- Press **▲** or **▼** to select **AUDIO**, **SUBTITLE** or **DISC MENU**. Then, press **ENTER**. The language options for the selected item will appear.

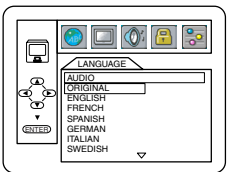

AUDIO:
The DVD's audio plays in the selected language.

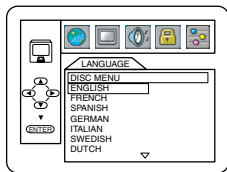

DISC MENU:
A DVD's Disc Menu appears in the selected language.

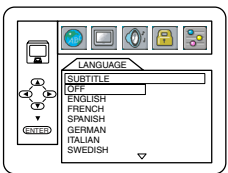

SUBTITLE:
Subtitles appear in the selected language.

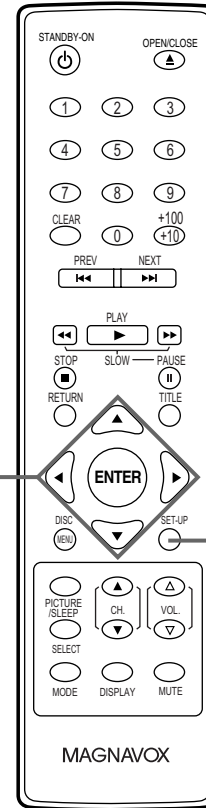

1-2
3-5
1-2

Helpful Hints

- If the DVD's default settings for Audio and Subtitle are the same language, the subtitles may not show unless you turn them on.
- Use **MODE** to select Audio and Subtitles available on the DVD. Details are on pages 37 and 39.
- If you set **AUDIO** to **ORIGINAL**, the default setting of the DVD Audio will play.

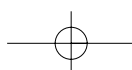

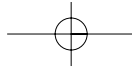

DVD

Language Settings (cont'd) 47

- 6** Press **▲** or **▼** to select a language, then press **ENTER**. The language lists may continue on multiple screens. Press **▲** or **▼** to move to the other screens.
- If you select OTHER, press four Number buttons to enter the code for the language you desire. Use the Language Codes below. The language or language code you select will appear in the Language Menu beside AUDIO, SUBTITLE or DISC MENU.

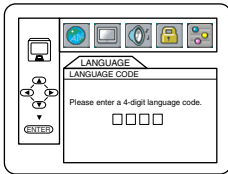

- You can select other languages for AUDIO, SUBTITLE and DISC MENU only if the language is available on the disc. If the language is not recorded on the DVD, changing these settings will have no effect.

- 7** Press **SET-UP** to exit the menu.

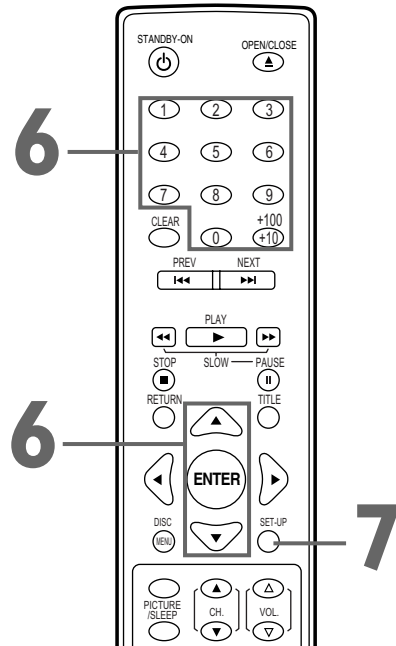

Language Codes

| | | | | | | | | | |
|--------------|---------|----------------|---------|--------------|---------|----------------|----------|------------|------|
| A-B | English | 5160 | Kannada | 5760 | Panjabi | 6247 | T | | |
| Abkhazian | 4748 | Esperanto | 5161 | Kashmiri | 5765 | Pashto | 6265 | Tagalog | 6658 |
| Afar | 4747 | Estonian | 5166 | Kazakh | 5757 | Persian | 5247 | Tajik | 6653 |
| Afrikaans | 4752 | F-H | | Kinyarwanda | 6469 | Polish | 6258 | Tamil | 6647 |
| Albanian | 6563 | Faroese | 5261 | Kirghiz | 5771 | Portuguese | 6266 | Tatar | 6666 |
| Amharic | 4759 | Fiji | 5256 | Kirundi | 6460 | Pushto | 6265 | Telugu | 6651 |
| Arabic | 4764 | Finnish | 5255 | Korean | 5761 | Quechua | 6367 | Thai | 6654 |
| Armenian | 5471 | French | 5264 | Kurdish | 5767 | Rhaeto-Romance | 6459 | Tibetan | 4861 |
| Assamese | 4765 | Frisian | 5271 | L-N | | Romanian | 6461 | Tigrinya | 6655 |
| Aymara | 4771 | Gaelic (Scots) | 5350 | Laothian | 5861 | Russian | 6467 | Tonga | 6661 |
| Azerbaijani | 4772 | Galician | 5358 | Latin | 5847 | S | | Tsonga | 6665 |
| Bangla | 4860 | Georgian | 5747 | Latvian | 5868 | Samoan | 6559 | Turkish | 6664 |
| Bashkir | 4847 | German | 5051 | Lettish | 5868 | Sangho | 6553 | Turkmen | 6657 |
| Basque | 5167 | Greek | 5158 | Lingala | 5860 | Sanskrit | 6547 | Twí | 6669 |
| Bengali | 4860 | Greenlandic | 5758 | Lithuanian | 5866 | Serbian | 6564 | U-Z | |
| Bhutani | 5072 | Guarani | 5360 | Macedonian | 5957 | Serbo-Croatian | 6554 | Ukrainian | 6757 |
| Bihari | 4854 | Gujarati | 5367 | Malagasy | 5953 | Sesotho | 6566 | Urdu | 6764 |
| Bislama | 4855 | Hausa | 5447 | Malay | 5965 | Setswana | 6660 | Uzbek | 6772 |
| Breton | 4864 | Hebrew | 5569 | Malayalam | 5958 | Shona | 6560 | Vietnamese | 6855 |
| Bulgarian | 4853 | Hindi | 5455 | Maltese | 5966 | Sindhi | 6550 | Volapuk | 6861 |
| Burmese | 5971 | Hungarian | 5467 | Maori | 5955 | Singhalese | 6555 | Welsh | 4971 |
| Byelorussian | 4851 | I-K | | Marathi | 5964 | Siswat | 6565 | Xhosa | 7054 |
| C-E | | Icelandic | 5565 | Moldavian | 5961 | Slovak | 6557 | Yiddish | 5655 |
| Cambodian | 5759 | Indonesian | 5560 | Mongolian | 5960 | Slovenian | 6558 | Yoruba | 7161 |
| Catalan | 4947 | Interlingua | 5547 | Nauru | 6047 | Somali | 6561 | Zulu | 7267 |
| Chinese | 7254 | Interlingue | 5551 | Nepali | 6051 | Spanish | 5165 | | |
| Corsican | 4961 | Inupiak | 5557 | Norwegian | 6061 | Sundanese | 6567 | | |
| Croatian | 5464 | Irish | 5347 | O-R | | Swahili | 6569 | | |
| Czech | 4965 | Italian | 5566 | Occitan | 6149 | Swedish | 6568 | | |
| Danish | 5047 | Japanese | 5647 | Oriya | 6164 | | | | |
| Dutch | 6058 | Javanese | 5669 | Oromo (Afan) | 6159 | | | | |

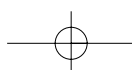

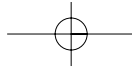

DVD

48 Display Settings

- To put the TV/DVD in DVD mode, press **SELECT**. Then, press **PLAY** ► or **OPEN/CLOSE** ▲ to activate the DVD mode.

You can change the TV Aspect ratio and still mode clarity in the Display Menu.

- 1 Press SET-UP once so the TV SETUP Menu appears.**

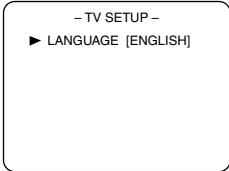

- 2 When playback is stopped, press SET-UP again. The QUICK SETUP Screen will appear.**

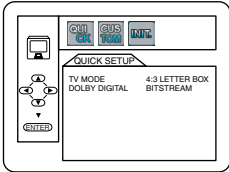

- 3 Press ◀ or ▶ to select CUSTOM at the top of the menu, then press ENTER.**

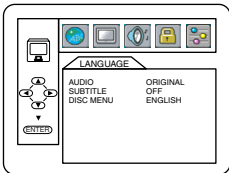

- 4 Press ◀ or ▶ to select [DISPLAY] (DISPLAY), then press ENTER.**

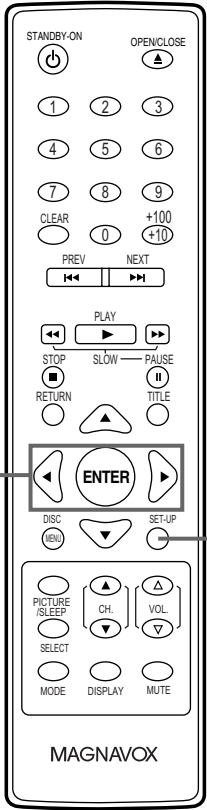
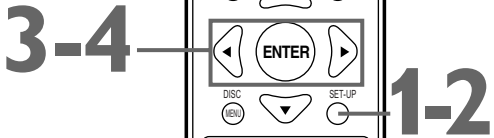
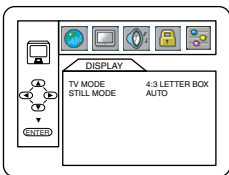

Helpful Hints

- Selecting a different TV MODE Setting is only effective if it is available on the DVD. Check the DVD Disc Menu or case for details.
- You also can adjust TV MODE in the QUICK SETUP Menu. With QUICK selected, press ENTER. TV MODE will be selected, so press ENTER. Press ▲ or ▼ to choose a setting, then press ENTER. Press SET-UP to remove the menu.

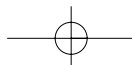

Display Settings (cont'd) 49

5 Press ▲ or ▼ to select an item, then press ENTER.

- If you selected **TV MODE**, press ▲ or ▼ to select a setting, then press ENTER.

Choose 4:3 LETTER BOX if you want to see the entire, widened picture with black bars at the top and bottom of the screen. This looks like the picture you see when watching movies in a theater. This setting is possible only if the DVD was recorded in the letterbox or widescreen format. Choose 4:3 PAN & SCAN for a full height picture, with both sides trimmed. Some companies refer to this as reformatting the picture to fit your TV screen and may call it the regular or normal format.

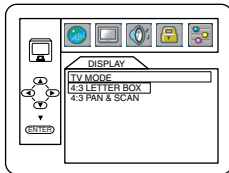

TV MODE

- If you selected **STILL MODE**, press ▲ or ▼ to select a setting, then press ENTER.

This function allows you to adjust the quality of a still image. AUTO is the default setting. If you select FIELD, still images will be stabilized but coarse due to the limited amount of data. If you select FRAME, the picture quality will be improved due to the simultaneous output of two field data but the image can be unstabilized.

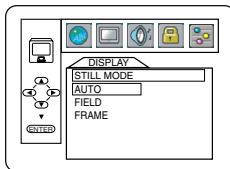

STILL MODE

6 Press SET-UP to exit the menus.

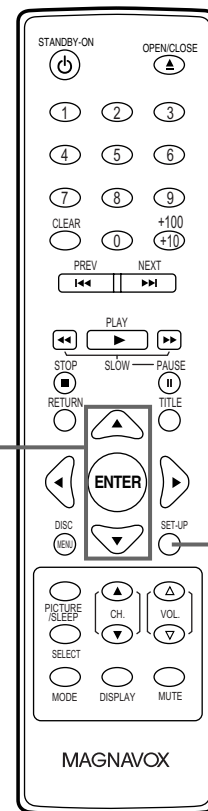

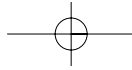

DVD

50 Audio Settings

- To put the TV/DVD in DVD mode, press **SELECT**. Then, press **PLAY** ► or **OPEN/CLOSE** ▲ to activate the DVD mode.

Change Audio Settings based on other equipment you connected to the TV/DVD or according to your disc sound features. These settings only affect the Audio from the DVD player of the TV/DVD.

- 1 Press **SET-UP** once so the TV SETUP Menu appears.

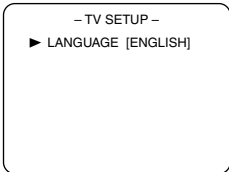

- 2 While playback is stopped, press **SET-UP** again. The QUICK SETUP Screen will appear.

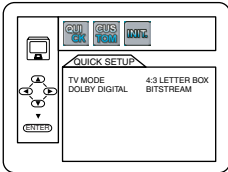

- 3 Press **◀** or **▶** to select **CUSTOM** at the top of the menu, then press **ENTER**.

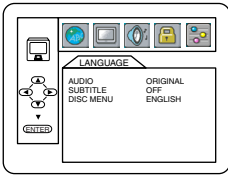

- 4 Press **◀** or **▶** to select **AUDIO**, then press **ENTER**.

- 5 Press **▲** or **▼** to select **DRC**, **DOWN SAMPLING**, or **DOLBY DIGITAL**, then follow step 6 accordingly.

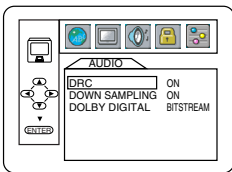

DRC

- 6
 - If you selected **DRC**, press **ENTER** repeatedly to turn Dynamic Range Control (DRC) ON or OFF. Choosing ON compresses the range of volume by suppressing loud sounds and raising low sounds. DRC is available only on discs recorded in the Dolby Digital format.
 - If you selected **DOWN SAMPLING**, press **ENTER** repeatedly to choose ON or OFF. ON sets downsampling to 48 kHz. OFF sets downsampling to 96 kHz. DOWN SAMPLING is available only when the unit is connected to a Stereo using the COAXIAL jack.
 - If you selected **DOLBY DIGITAL**, press **ENTER** repeatedly to select BITSTREAM or PCM. Select BITSTREAM if you used the COAXIAL jack to connect the TV/DVD to a stereo that is Dolby Digital compatible. Details are on page 11. Otherwise, choose PCM.

- 7 Press **SET-UP** to exit the menu.

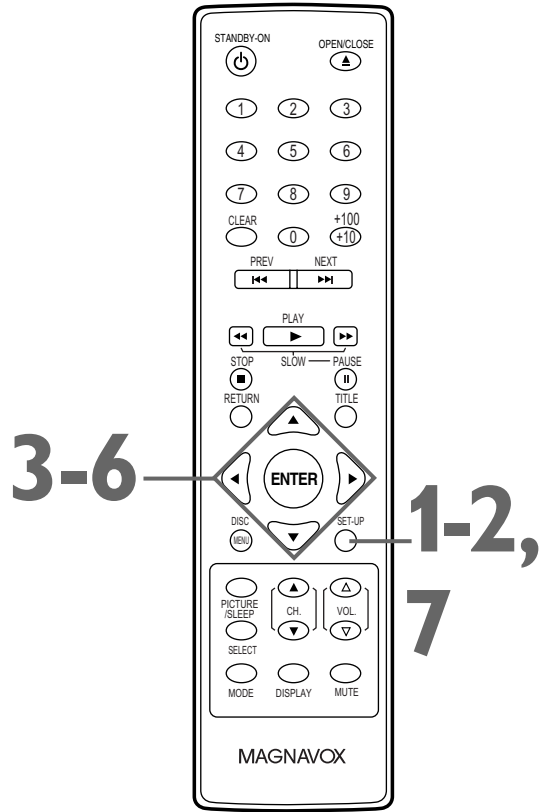

Helpful Hints

- Dolby Digital sound must be available on the DVD.
- You can adjust DOLBY DIGITAL in the QUICK SETUP Menu. With QUICK selected, press ENTER. Press ▼ to select DOLBY DIGITAL. Press ENTER to choose BITSTREAM or PCM. Press SET-UP to remove the menu.
- When you play a disc that has copyright protection, downsampling will be at 48 kHz, even if DOWN SAMPLING is OFF.

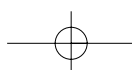

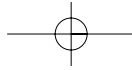

DVD

Parental Settings 51

- To put the TV/DVD in DVD mode, press **SELECT**. Then, press **PLAY** ► or **OPEN/CLOSE** ▲ to activate the DVD mode.



The Parental feature prevents viewing of DVDs that exceed your rating limits. This feature will not limit viewing if the DVD is not rated or coded. Check your DVDs and settings before letting children access the TV/DVD. Follow these steps to set the Parental Level.

- 1** Press **SET-UP** once so the **TV SETUP** Menu appears.

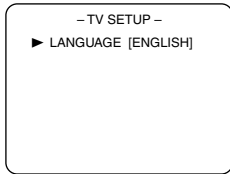

- 2** Press **SET-UP** again while playback is stopped.

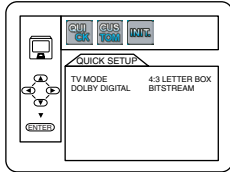

- 3** Press **◀** or **▶** to select **CUSTOM** at the top of the menu, then press **ENTER**.

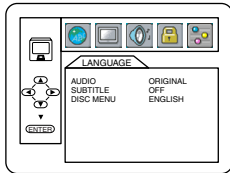

- 4** Press **◀** or **▶** to select **PARENTAL**, then press **ENTER**.

- If this is the first time to access the Parental Menu, proceed to step A.
- If this is not the first time to access the Parental Menu and you had already set the password before, proceed to step B.

- A** The display shown below will appear.

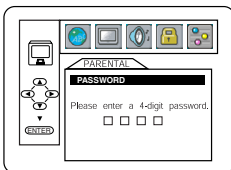

Press the Number buttons to enter a 4-digit password. The password will appear on the screen. Write it down so you don't forget it.

Press ENTER. The Parental Menu will appear.

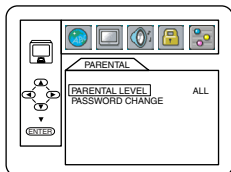

Proceed to step 5.

Instructions continue on the next page.

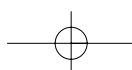
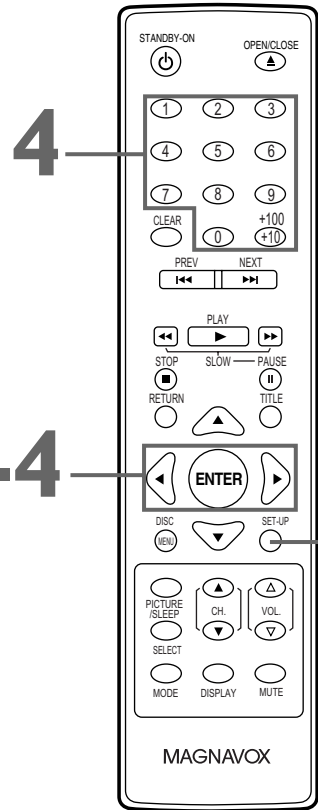

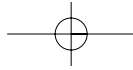

DVD

52 Parental Settings (cont'd)

Instructions continued from the previous page.

B The display shown below will appear.

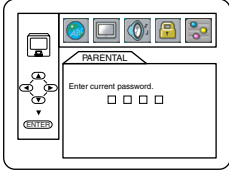

Press the Number buttons to enter your current 4-digit password. Asterisks (*) will appear instead of your password. This protects its identity. After entering the password, the Parental Menu will appear.

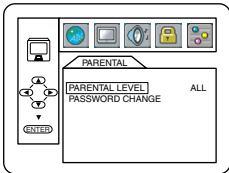

Proceed to step 5.

5 Press ▲ or ▼ to select PARENTAL LEVEL, then press ENTER.

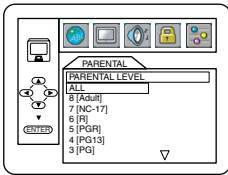

6 Press ▲ or ▼ to select a level, then press ENTER. The previous menu will appear. The level you selected will appear beside PARENTAL LEVEL. The rating levels continue on two menu screens. Press ▲ or ▼ repeatedly to move to the next or previous screen to find the rating level you want.

7 Press SET-UP to exit the menu.

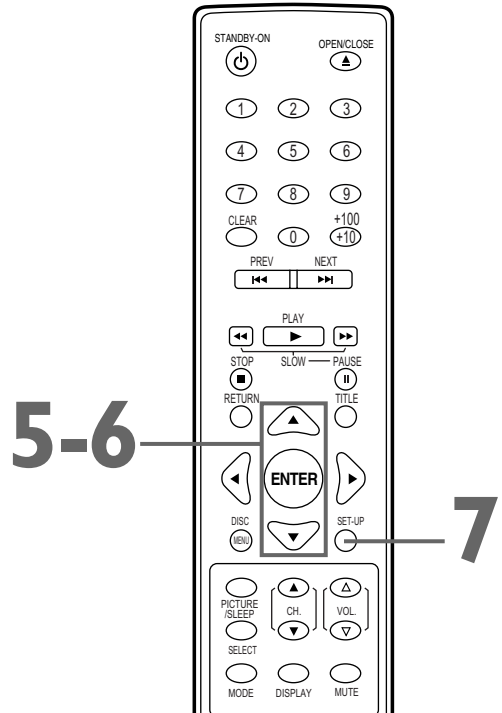

RATING EXPLANATIONS

- ALL - The Parental feature is inactive; all discs can play.
- 8 [ADULT] - DVD softwares of any grades (adult/general/children) can be played back.
- 7 [NC-17] - No one under 17 admitted
- 6 [R] - Restricted; under 17 requires accompanying parent or adult guardian
- 5 [PGR] - Parental Guidance Recommended
- 4 [PG13] - Unsuitable for children under 13
- 3 [PG] - Parental Guidance suggested
- 2 [G] - General Audience
- 1 [KID SAFE] - Suitable for children

Helpful Hints

- When you try to play a DVD whose rating exceeds the level you set, an on-screen message will indicate the DVD cannot play. Remove the DVD, then set PARENTAL LEVEL to ALL. Reload the DVD and begin playback. Some DVDs may let you enter your 4-digit password to begin playback. Follow the on-screen messages as prompted.
- You cannot use the default password (4737) to play a DVD.

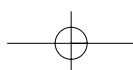

Parental Settings (cont'd) 53

Changing the Parental Password

- 1** If you like to change the password, repeat 1-4B on pages 51-52.
- 2** Press **▲** or **▼** to select **PASSWORD CHANGE**, then press **ENTER**.

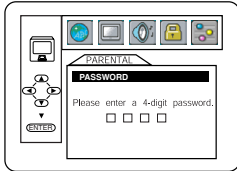

- 3** Press the **Number** buttons to enter a **4-digit password**. The password numbers will appear on the screen. Write down the password so you will not forget it. Press **ENTER**. The previous menu will reappear.
- 4** Press **SET-UP** to exit the menu.

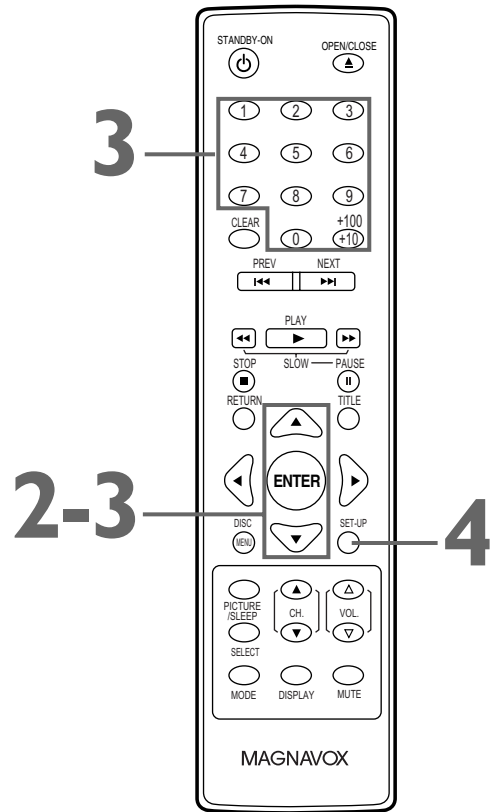

Helpful Hints

- The default password is 4737. If you forget your password, press Number buttons 4, 7, 3, 7 at step 3. You will be prompted to enter a new 4-digit password. Use the Number buttons to enter a new 4-digit password, then press ENTER. PARENTAL LEVEL will reset to ALL. Press SET-UP to remove the menu. See pages 51-52 to reset PARENTAL LEVEL as you desire.
- A power failure will not erase your password.

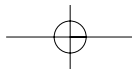

DVD

54 Others

- To put the TV/DVD in DVD mode, press **SELECT**. Then, press **PLAY** ► or **OPEN/CLOSE** ▲ to activate the DVD mode.

You may adjust the Angle Icon, Automatic Power Off, Dual Playback and Slide Show Settings.

- 1** Press **SET-UP** once so the **TV SETUP** Menu appears.

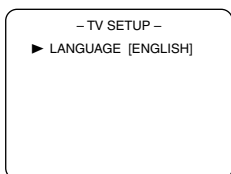

- 2** When playback is stopped, press **SET-UP** again. The **QUICK SETUP** Screen will appear.

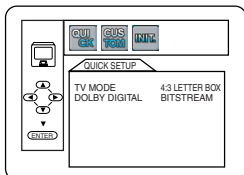

- 3** Press **◀** or **▶** to select **CUSTOM** at the top of the menu, then press **ENTER**.

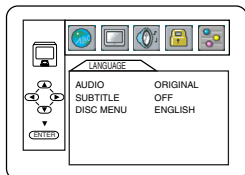

- 4** Press **◀** or **▶** to select **OTHERS**, then press **ENTER**.

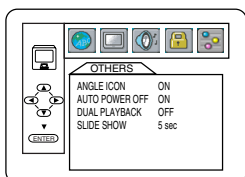

3-4

1-2

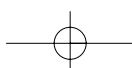
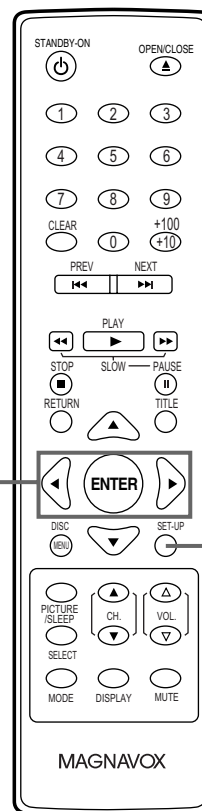

Others (cont'd) 55

5 Press ▲ or ▼ to select an item, then press ENTER.

- If you selected **ANGLE ICON**, press **ENTER** repeatedly to select ON or OFF. The default setting is ON. Choose ON to see the Angle icon when multiple camera angles are available during DVD playback. Details are on page 37. Choose OFF to disable the Angle icon.

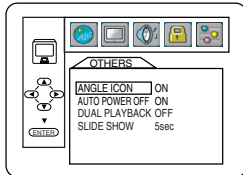

ANGLE ICON

- If you selected **AUTO POWER OFF**, press **ENTER** repeatedly to choose ON or OFF. The default setting is ON. Choose ON if you want the player to turn off when there is no activity at the player or its remote for 20 minutes.

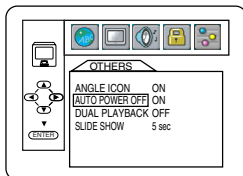

AUTO POWER OFF

- If you selected **DUAL PLAYBACK**, press **ENTER** to choose ON or OFF. This feature lets you play MP3 and JPEG files simultaneously.

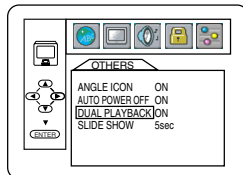

DUAL PLAYBACK

- If you selected **SLIDE SHOW**, press ▲ or ▼ to choose 5sec or 10sec, then press **ENTER**. This adjusts the playback speed of the SLIDE SHOW. The default setting is 5 sec. Choose 5 sec to display each image for 5 seconds. Choose 10 sec to display each image for 10 seconds.

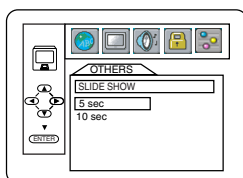

SLIDE SHOW

6 Press SET-UP to remove the menus.

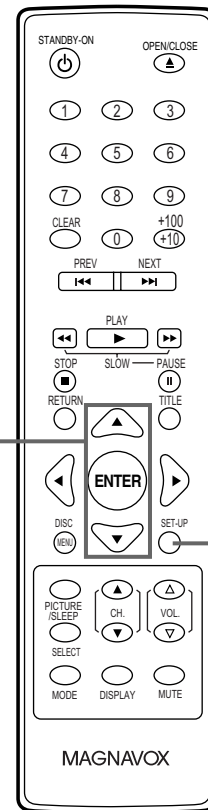

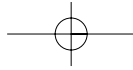

56 Glossary

AUDIO In Jacks: red and white jacks on the front of the TV/DVD which are used to receive audio from another source (VCR, Camcorder, etc.).

Automatic Channel Setup: process in which the TV/DVD memorizes all available TV channels. Then, when you push CH. ▲/▼, you only scan through channels you receive.

Auxiliary (AUX): The channel to which you set your TV/DVD when viewing material that is playing on another device that is connected to the TV/DVD (for example, a Camcorder or VCR or TV channels from a Cable Box/Satellite Receiver). Press SELECT to choose AUX at the TV/DVD.

Bands: settings that allow you to tune channels.

- **Antenna** – VHF (very high frequency; channels 2-13) and UHF (ultra high frequency; channels 14-69).
- **Cable** – standard channels can be received without a Cable Box.

Brightness: adjusting increases or decreases the brightness of the color on the screen.

COAXIAL Digital Audio Out Jack: Sends digital audio to a stereo, allowing you to adjust the volume at the stereo.

Color: adjusting pales or brightens the TV/DVD picture color.

Dolby Digital: A surround sound system that provides Multi-channel sound as used in movie theaters. Sound is heard through multiple channels, not just the right and left as with standard stereo.

Sharpness: adjusting softens or clarifies the picture on the screen.

Tint: adjusting changes the tints of the picture from purple to green.

VIDEO IN Jack: yellow jack on the front of the TV/DVD which is used to receive video from another source (VCR, Camcorder, etc.).

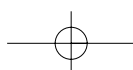

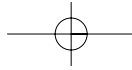

Helpful Hints 57

If you are having problems with your product, check this list of problems and possible solutions before requesting service. You may be able to solve the problem yourself.

Location

For safe operation and satisfactory performance of your TV/DVD, remember the following:

- Shield it from direct sunlight and keep it away from sources of intense heat.
- Avoid dusty or humid places.
- Avoid places with insufficient ventilation. Do not block the ventilation openings at the top and bottom of the TV/DVD. Do not place the TV/DVD on a carpet, as this will block the ventilation openings.
- Avoid locations subject to strong vibrations.
- Do not place the TV/DVD near strong magnetic fields.
- Do not move the TV/DVD from a cold place to a hot place, or vice versa.

Electrical Shock and Fire Hazards

- Do not handle the power cord with wet hands.
- Do not pull the power cord when disconnecting the TV/DVD from the AC (alternating current) wall outlet. Grasp it by the plug.
- If you spill water on the TV/DVD, unplug the power cord immediately and take the TV/DVD to an authorized service center.
- Do not place anything on top of the TV/DVD.

Channel reception is poor.

- Check connections, then set up the channels again. *Details are on page 19.*

TV/DVD has no power.

- Connect the power plug to an AC (alternating current) outlet completely.

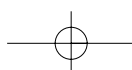
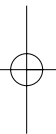
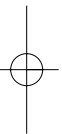

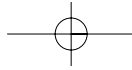

58 Helpful Hints (cont'd)

Disc cannot play.

- Insert a playable disc. Make sure the disc is labelled for Region 1 or ALL regions and is NTSC compatible. *Details are on page 7.*
- Place the disc correctly in the disc tray. If the disc is one-sided, place the disc in the tray with the label facing up. If the disc is two-sided, make sure the label of the side you want to play is facing up.
- Clean the disc. Make sure the disc is not scratched or warped.
- Cancel the Parental Controls, enter the password, or change the Parental Level. *Details are on pages 51-52.*

TV/DVD does not have a picture.

- Adjust the antenna or check the Cable TV or satellite signal connection. If using a Cable Box/Satellite Receiver, set the TV/DVD to channel 3, 4 or AUX. *Details are on pages 9-10.*
- Adjust the picture controls. *Details are on page 21.*
- Select an active TV channel. *Details are on pages 19-20.*
- Make sure the disc is compatible with the DVD player of the TV/DVD. *Details are on page 7.*

TV/DVD has poor sound or no sound.

- Press VOL. Δ/∇ to adjust the volume. Press MUTE to restore the volume.
- Check the Audio Settings for DVD mode. *Details are on page 50.*
- Check the Audio Settings of the disc. For example, you may have selected "soundtrack" playback or an unavailable Sound Setting (such as Dolby Digital) or language. *Details are on pages 39, 46-47 and 50.* Try other sound options provided in the DVD Disc Menu.

You cannot choose a DVD feature, such as camera angle or audio or subtitle language.

- The feature must be recorded on the DVD. Not all DVDs contain multiple angles, subtitles, etc. Refer to the disc case to see what features are available. If the feature is not available, the "X" may appear in the top right corner of the screen.

TV/DVD does not display closed captions for TV programs.

- Make sure closed captioning is available for the program. Refer to the TV listings in your local newspaper.

Remote control does not operate the TV/DVD.

- Aim the remote control directly at the remote sensor on the front of the TV/DVD. *Details are on page 14.*
- Remove all obstacles between the remote control and the TV/DVD.
- Inspect and replace the batteries in the remote control. *Details are on page 8.*

Number buttons will not select channels above 69.

- Enter channel numbers as a 2-digit number. If you want to select channels 100 and above, press the +100/+10 button, then the Number buttons for the last 2 digits. *Details are on page 13.*
- If you are using an antenna and do not have Cable TV/Satellite, only channels 2-69 will be available.

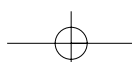

Specifications 59

General TV

CRT: 20 inch in-line gun
90° deflection tube

Closed Caption system: 15.119/FCC
Tuner channels: 2-69
Cable TV: 1-125

General DVD

Color System: NTSC

Electrical Specifications

Sound output: Two speakers, 1W, 8 ohm

Other Specifications

Terminals

Antenna In: VHF/UHF/Cable TV
75 ohm unbalanced (F-type)

Video In: One RCA connector

Audio L/R In: Two RCA connectors

Headphone: 1/8" stereo (3.5 mm)

Coaxial Digital

Audio Out: One pin jack,
500m Vpp (75 ohm)

Operating

temperature: 41°F-104°F (5°C-40°C)

Power requirements: AC 120V, 60Hz

Power consumption

(Maximum): 80W

Dimensions: Height: 18" (457 mm)

Width: 20.2" (512 mm)

Depth: 19.9" (505 mm)

Weight: 45.2 lbs. (20.5 kg)

Designs and specifications are subject to change without notice and without our legal obligation.

60 Limited Warranty

MAGNAVOX LIMITED WARRANTY NINETY (90) DAY LABOR / ONE (1) PARTS

WARRANTY COVERAGE:

MAGNAVOX warranty obligation is limited to the terms set forth below.

WHO IS COVERED:

Magnavox warrants the product to the original purchaser or the person receiving the product as a gift against defects in materials and workmanship as based on the date of original purchase ("Warranty Period") from an Authorized Dealer. The original sales receipt showing the product name and the purchase date from an authorized retailer is considered such proof.

WHAT IS COVERED:

The Magnavox warranty covers new products if a defect arises and a valid claim is received by Magnavox within the Warranty Period. At its option, Magnavox will either (1) repair the product at no charge, using new or refurbished replacement parts, or (2) exchange the product with a product that is new or which has been manufactured from new, or serviceable used parts and is at least functionally equivalent or most comparable to the original product in Magnavox current inventory, or (3) refund the original purchase price of the product.

Magnavox warrants replacement products or parts provided under this warranty against defects in materials and workmanship from the date of the replacement or repair for ninety (90) days or for the remaining portion of the original product's warranty, whichever provides longer coverage for you. When a product or part is exchanged, any replacement item becomes your property and the replaced item becomes Magnavox' property. When a refund is given, your product becomes Magnavox' property.

Note: Any product sold and identified as refurbished or renewed carries a ninety (90) day limited warranty.

Replacement product can only be sent if all warranty requirements are met. Failure to follow all requirements can result in delay.

WHAT IS NOT COVERED - EXCLUSIONS AND LIMITATIONS:

This Limited Warranty applies only to the new products manufactured by or for Magnavox that can be identified by the trademark, trade name, or logo affixed to it. This Limited Warranty does not apply to any non-Magnavox hardware product or any software, even if packaged or sold with the product. Non-Magnavox manufacturers, suppliers, or publishers may provide a separate warranty for their own products packaged with the bundled product.

Magnavox is not liable for any damage to or loss of any programs, data, or other information stored on any media contained within the product, or any non-Magnavox product or part not covered by this warranty. Recovery or reinstallation of programs, data or other information is not covered under this Limited Warranty.

This warranty does not apply (a) to damage caused by accident, abuse, misuse, misapplication, or non-Magnavox product, (b) to damage caused by service performed by anyone other than Magnavox or Magnavox Authorized Service Location, (c) to a product or a part that has been modified without the written permission of Magnavox, or (d) if any Magnavox serial number has been removed or defaced, or (e) product, accessories or consumables sold "AS IS" without warranty of any kind by including refurbished Magnavox product sold "AS IS" by some retailers.

This Limited Warranty does not cover:

- Shipping charges to return defective product to Magnavox.
- Labor charges for installation or setup of the product, adjustment of customer controls on the product, and installation or repair of antenna systems outside of the product.
- Product repair and/or part replacement because of improper installation, connections to improper voltage supply, abuse, neglect, misuse, accident, unauthorized repair or other cause not within the control of Magnavox.
- Damage or claims for products not being available for use, or for lost data or lost software.
- Damage occurring to product during shipping.
- A product that requires modification or adaptation to enable it to operate in any country other than the country for which it was designed, manufactured, approved and/or authorized, or repair of products damaged by these modifications.
- A product used for commercial or institutional purposes (including but not limited to rental purposes).
- Product lost in shipment and no signature verification receipt can be provided.
- Failure to operate per Owner's Manual.

TO OBTAIN ASSISTANCE IN THE U.S.A., PUERTO RICO, OR U.S. VIRGIN ISLANDS...

Contact Magnavox Customer Care Center at:
1-800-705-2000

TO OBTAIN ASSISTANCE IN CANADA...

1-800-661-6162 (French Speaking)
1-800-705-2000 - (English or Spanish Speaking)

REPAIR OR REPLACEMENT AS PROVIDED UNDER THIS WARRANTY IS THE EXCLUSIVE REMEDY FOR THE CONSUMER. MAGNAVOX SHALL NOT BE LIABLE FOR ANY INCIDENTAL OR CONSEQUENTIAL DAMAGES FOR BREACH OF ANY EXPRESS OR IMPLIED WARRANTY ON THIS PRODUCT. EXCEPT TO THE EXTENT PROHIBITED BY APPLICABLE LAW, ANY IMPLIED WARRANTY OF MERCHANTABILITY OR FITNESS FOR A PARTICULAR PURPOSE ON THIS PRODUCT IS LIMITED IN DURATION TO THE DURATION OF THIS WARRANTY.

Some states do not allow the exclusions or limitation of incidental or consequential damages, or allow limitations on how long an implied warranty lasts, so the above limitations or exclusions may not apply to you.

This warranty gives you specific legal rights. You may have other rights which vary from state/province to state/province.

Magnavox, P.O. Box 671539, Marietta, GA. 30006-0026

3121 233 48931

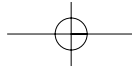

Index 61

-
- a-b repeat35
 - ant(enna) jack9, 15
 - arrow buttons13
 - audio cd7
 - audio in/out jacks10, 14
 - audio settings (dvd)50
 - auxiliary mode (aux)9-10, 17

 - batteries8
 - black level42
 - brightness21

 - camera angle37
 - channel
 - above 10013, 33
 - adding/deleting20
 - setup19
 - ▲/▼ buttons13-14, 19
 - chapters32
 - clear button12, 22
 - closed captions23
 - coaxial jack11, 15
 - color21
 - connections9-11
 - contents, table of5
 - contrast21
 - controls
 - remote12-13
 - copyright protection4

 - disc menu button13, 30
 - disc tray14, 18
 - display button13, 40-41
 - display settings48-49
 - dvd video7

 - enter button12

 - fast forward search31
 - front panel14

 - glossary56

 - headphone jack14
 - helpful hints57-58
 - hookups9-11
 - language (dvd)39, 46-47
 - language (setup menus)19
 - language settings46-47
 - menus6, 19, 30
 - mode button12, 32-33
 - mp3 display41
 - mp3 playback44
 - mp3 track selection44
 - mute button12

 - number buttons13

 - on-screen displays40-41
 - open/close button ▲12, 14
 - parental setting51-53
 - password53
 - pause ■■ button13, 34, 38
 - picture controls21
 - play ► button13-14
 - playing a disc18
 - power cord10, 15
 - program playback43
 - random playback43
 - ratings
 - mpaa28
 - tv24-27
 - rear panel15
 - remote control buttons12-13
 - using8
 - remote sensor14
 - repeat playback35
 - resuming playback34
 - return button13
 - reverse searching31
 - rf coaxial cable9

 - safety precautions4
 - searching31
 - select button13
 - set-up button6, 12
 - sharpness21
 - sleep timer22
 - slow motion38
 - specifications59
 - standby-on Ⓞ button12, 14
 - still picture34
 - stop ■ button13-14

 - table of contents5
 - tint21
 - title button12, 30
 - titles30
 - tracks33

 - v-chip setup24-29
 - video in/out jacks10, 14
 - virtual surround42
 - volume ▲/▼ buttons13-14

 - warranty60
 - Windows Media™ Audio display41
 - Windows Media™ Audio playback44

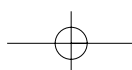

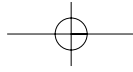

62 Memo

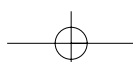
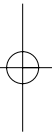
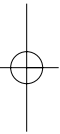

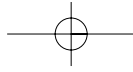

Memo 63

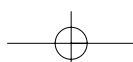
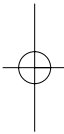
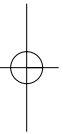

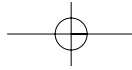

PHILIPS CONSUMER ELECTRONICS

A Division of Philips Electronics North America Corp
P.O. Box 671539 Marietta, GA 30006 0026

Meet Magnavox at the Internet
<http://www.magnavox.com/usasupport>

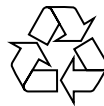

20MC4206



8239 300 47291

Printed In Malaysia
JpnCN-0609/37-3
1EMN21533
T9201UB *****

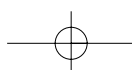

Free Manuals Download Website

<http://myh66.com>

<http://usermanuals.us>

<http://www.somanuals.com>

<http://www.4manuals.cc>

<http://www.manual-lib.com>

<http://www.404manual.com>

<http://www.luxmanual.com>

<http://aubethermostatmanual.com>

Golf course search by state

<http://golfingnear.com>

Email search by domain

<http://emailbydomain.com>

Auto manuals search

<http://auto.somanuals.com>

TV manuals search

<http://tv.somanuals.com>