

MAGIC 5

User Manual



PHILIPS

Dear Customer,

In buying this device you have chosen a quality product made by PHILIPS. Their device fulfils the most varied requirements for private use or in your office and business everyday.

Your device is delivered with an already inserted free ink film for a few test pages. For this film, you do not require any Plug'n'Print card (= chip card with information regarding ink film capacity).

In the telephone book of your machine, you can save entries with multiple numbers and collect multiple entries into groups. You can assign various ring tones to the entries.

You can assign short dial numbers to frequently dialled telephone numbers. You can load these numbers quickly with the short dial button and the number buttons.

You can send fax messages in different resolutions to one or more recipients or a group. You can also poll faxes and prepare documents for polling.

Five fax templates, which you can use, are stored in your device. With these templates you can quickly create, for example, a short fax note or an invitation.

Select the resolution for text and photo in order to copy documents with your machine. You can also create multiple copies.

If you want, your device can print Sudoku puzzles in four different difficulty levels with solution.

We hope you enjoy your machine and its many functions!

About this User Manual

With the installation guide on the following pages, you can start using your machine quickly and easily. Detailed descriptions can be found in the following sections of this user manual.

Read the entire user manual carefully. Follow all safety instructions in order to ensure proper operation of your machine. The manufacturer accepts no liability if these instructions are not followed.

Symbols Used



Warns about dangers for people, damage to the machine or other objects as well as possible loss of data. Injuries or damage can result from improper handling.



This symbol designates tips that will help you to use your machine more effectively and easily.

Installation Guide

Package Contents

- 1 Device
 - 2 Telephone handset
 - 3 Spiral cable for telephone handset
 - 4 Paper tray
 - 5 Mains cable with plug (country-specific)
 - 6 Telephone cable with plug (country-specific)
- User manual with installation guide (not depicted)

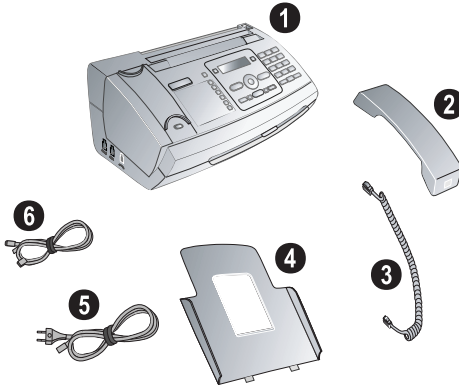

💡 If one of the parts is missing or damaged, please contact your retailer or our customer service.

Attaching the Paper Tray

Insert the paper tray into the openings behind the paper feed mechanism.

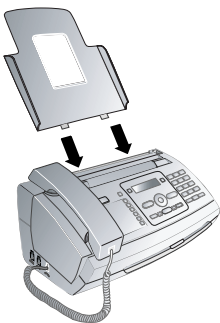

Inserting Paper

Before you can receive or copy documents, you must insert paper. Please use only suitable paper in the standard format **A4** (210 × 297 millimetre · preferably 80 g/m²). Observe the information in the technical data.

💡 Separate the paper sheets by fanning them out, then align them by tapping edge of the stack lightly against a flat surface. This will prevent several sheets of paper from being drawn in all at once.

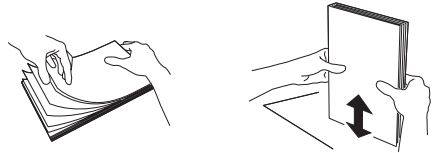

- 1 Fold open the lever on the right beside the paper feed towards front.
- 2 Insert paper in the paper feeder. You can insert **maximum 50 sheets** (A4 · 80 g/m²).
- 3 Fold open the lever on the right beside the paper feed backward in order to enclose the paper.

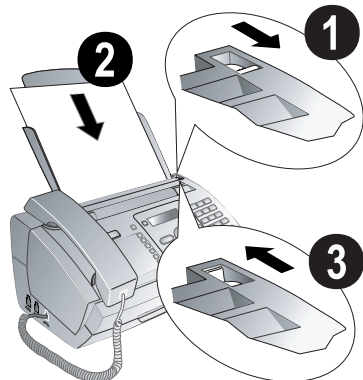

Connecting the Handset

Plug one end of the spiral cable into the socket on the telephone handset. Insert the other end into the socket designated with the ☞ symbol.

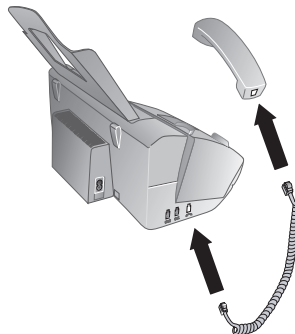

Connecting the Telephone Cable

Connect the telephone cord to the device by inserting it in the socket designated with **LINE** (RJ-11-Connector). Insert the telephone plug into your telephone connection socket.

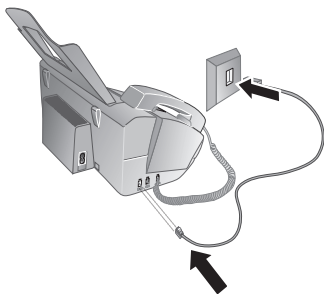

 If you connect your device as extension to a telephone system, you must set it for working as an extension (also see Chapter "Telephone connections and additional devices, page 21).

Ireland

When connecting to the telephone line socket, use only a **two-pin** RJ-11-telephone cable (modular plug). The use of a four-pin cable may lead to the machine not functioning correctly.

Connecting the Power Cable

 Check whether the mains voltage of your device (indicated on the type label) matches the mains voltage available at the setup location.

Insert the mains cable into the connection located on the rear side of the device. Connect the mains cable to the electrical socket.

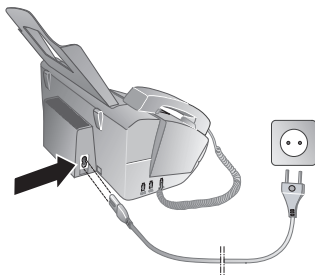

Initial Installation

After you connect your device to the mains voltage, the initial installation commences. Press **[1]**. Your device prints a help page.

Selecting the Language

- 1 Use **▲/▼** to select the desired display language.
- 2 Confirm with **OK**.

Selecting the Country

 Always set the country in which you are operating the machine. Otherwise, your machine is not adapted to the telephone network. If your country is not included in the list, you must select a different setting and use the correct telephone cable for the country. Consult your retailer.

- 1 Use **▲/▼** to select the country in which you are operating the machine.
- 2 Confirm with **OK**.

After this input, the machine prints another help page and checks the telephone line.

Entering Your Number

Your name and number are added together with date, time and page number at the top edge of each fax transmission (= header).

- 1 Enter your number. Using **#** or ***** you can enter a plus sign.
- 2 Confirm with **OK**.

Entering Your Name

- 1 Enter your name. You can enter characters using the numeric keys (see button labels). Enter special characters using **0**. Press the respective button several times until the desired character or special character appears on the display.

 You can move the cursor using **▲/▼**. Use **C** to delete individual characters.

- 2 Confirm with **OK**.

After the input, the machine prints an overview of the functions.

Entering the Time and Date

- 1 Enter the time, e.g. **1 4 0 0** for 2 pm.
- 2 Enter the date (two digits each) e.g. **0 8 0 6 0 7** for 8 June 2007.
- 3 Confirm with **OK**.

 You can restart the initial installation process any time. Press **[1]** and **[2]**.

Overview

Overview of the Menu Functions

The following functions are available on your device. There are two ways in which you can call functions:

Navigating in the menu: Press **OK** or one of the two arrow keys **▲/▼** to open the function menu. Page through **▲/▼** menu entries. Use **OK** to select a function. Press **C** to return to the previous menu level. Press **STOP** to close the menu and return to the starting mode.

Calling functions directly: You can call a menu function directly using the function number. Press **OK** and enter the appropriate function number using the numeric keypad. Confirm using **OK**. You will find the function number in the following list.

 Press **1** and **6** to print a list of all functions and settings of your device.

1 Telephone book

- ①① Looking up an entry page 10
- ①② New entry..... page 10
- ①③ Creating group page 11
- ①④ Short dial..... page 11
- ①⑤ Modifying an entry..... page 11
- ①⑥ Deleting entries page 11
- ①⑦ Printing entries page 19

2 Calls

- ②① Received calls..... page 10
- ②② Outgoing calls page 10
- ②③ Printing entries page 19

3 Fax

- ③① Polled reception..... page 14
- ③② Polling send..... page 14
- ③③ Sending fax later page 14
- ③④ Sending to multiple recipients (= broadcast)
..... page 14
- ③⑤ Printing fax journal..... page 19
- ③⑥ Printing transmission report page 19
- ③⑦ Print reduced in size page 18
- ③⑧ Reducing transmission speed page 18

4 Miscellaneous

- ④① Printing call list page 19
- ④③ Using fax templates..... page 15
- ④④ Setting the contrast..... page 18
- ④⑤ Using service codes page 26
- ④⑥ Checking the ink film reserve page 23
- ④⑦ Checking the firmware version page 26
- ④⑧ Sudoku page 17

5 Fax switch

- ⑤① Configuring day mode..... page 19
- ⑤② Configuring night mode page 19
- ⑤③ Setting the timer page 19
- ⑤④ Easylink page 22
- ⑤⑤ Setting the ring tones page 18

9 Settings

- ⑨① Entering the date and time..... page 18
- ⑨② Selecting the language..... page 18
- ⑨③ Selecting the country page 18
- ⑨④ Entering number..... page 18
- ⑨⑤ Entering name page 18
- ⑨⑥ Configuring telephone lines and services... page 21

Device Overview

- ① Handset
- ② Paper tray
- ③ Document feeder (writing facing up)
- ④ Panel with display
- ⑤ -Socket—Connection socket for the telephone handset
- ⑥ **EXT**-Socket—Connection socket for additional devices
- ⑦ **LINE**-Socket—Connection socket for telephone cable

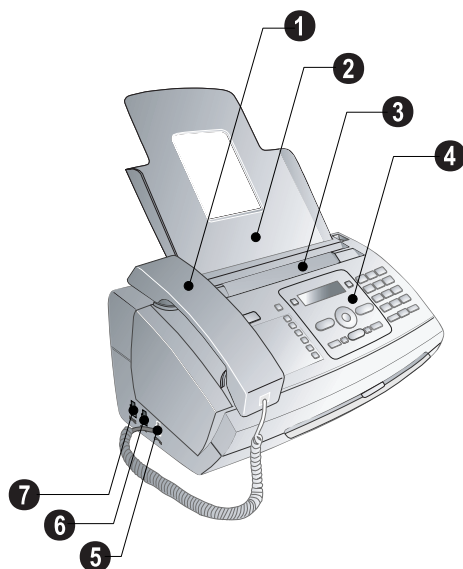



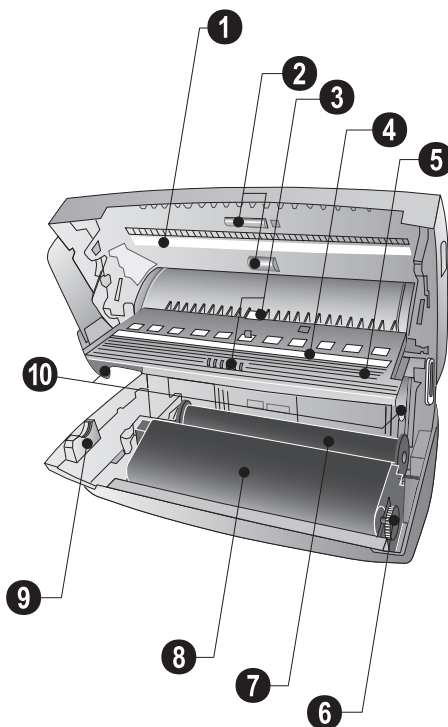



- ① Scanner glass
- ② Rollers of the automatic document feeder
- ③ Rests of the intake rollers
- ④ Document guide / scanner film
- ⑤ Cover for scanner and automatic document feeder
- ⑥ Toothed wheel for tightening the ink film
- ⑦ Ink film roll in the rear ink film compartment
- ⑧ Ink film roll in the front ink film compartment
- ⑨ Slot for the Plug'n'Print card
- ⑩ Locks for the cover of the scanner and automatic document feeder









Panel

—Lights up, if new messages are received / list of the new messages with submenus / blinks in the case of device error (for example no ink film)



—Press briefly: Load short dial entries. Selecting the entries with the  /  or numeric keys / press and hold: Assign a new short dial entry

 **A-Z**—Press briefly: Calling up the telephone book entries. Selecting the entries with the  /  / press and hold:

 /  / —Setting the timer and the fax reception modes (= fax switch). Modes set on the display  (day),  (night). Activated timer is indicated with 

STOP—Function abort / return to the starting mode / documents eject

C—Return to the previous menu level / press briefly: deleting individual characters / press and hold: deleting complete input

 / —Calling the menu functions / navigation within the menu / selecting options / moving the cursor / adjusting the volume level

OK—Calling the menu functions/ confirming input

START—Press briefly: Starting transmission of messages / press and hold: Starting fax polling

—Press briefly: Printing help pages and setting lists / press and hold: Starting initial installation process

COPY—Press briefly: creating a copy / press and hold: creating multiple copies

—Setting higher resolution for faxes and copying (RESOL. : STANDARD, RESOL. : FINE, RESOL. : PHOTO)

Numeric keypad—Inputting digits, characters and special characters / press and hold: Recalling short dial numbers

—Press briefly: Toggling between the list of the last 10 dialled numbers (= redial list) / press and hold: List of last ten callers (caller list)

—Dialling with the handset replaced

R—Press briefly: insert short line interruption (Hook Flash) as office index on PABX or for calling special functions in the public telephone network (PSTN)/long press: Inserting dialling pause

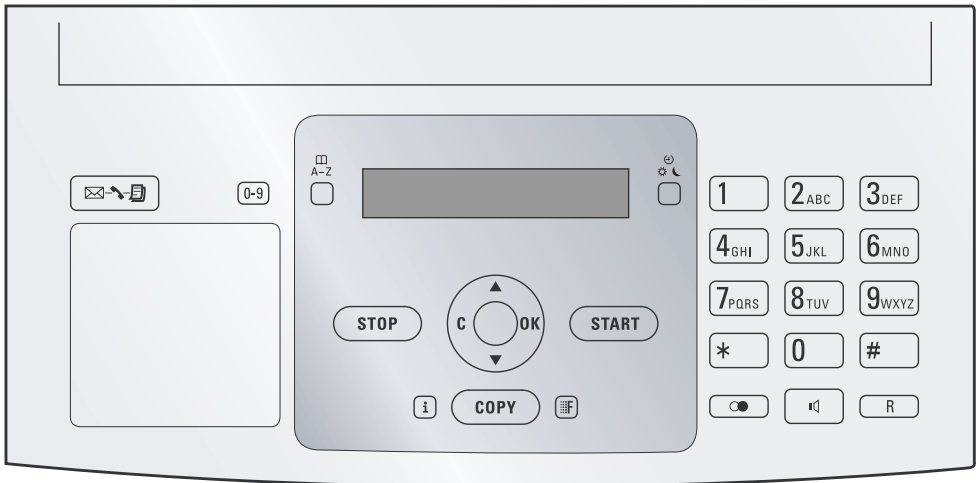

General Safety Information

Your device has been tested in conformity with standards EN 60950-1 and IEC 60950-1 and should only be operated with telephone systems and power equipment that meet these standards. The device was built exclusively for use in the indicated sales region.

Do not make any changes or settings that are not described in this user manual.

Setting Up the Machine

The device should rest securely on a stable, flat surface. If the device should fall, it can be damaged or can cause injury to people, especially small children. Position all cables in such a way that no one will stumble on them, thus avoiding possible injuries to persons or damage to the device itself.

The distance between the device and other devices or objects must be at least 15 centimetres; this also applies to the use of additional cordless telephones. Do not place the device in the vicinity of radios or televisions.

Lock the cover of the device completely into place when opening the device. You could be injured if the cover falls while you are working on the device.

Protect the device against direct sunlight, heat, large temperature fluctuations and moisture. Do not place the device in the vicinity of heaters or air conditioners. Observe the information on temperature and humidity in the technical data.

The device must have sufficient ventilation and may not be covered. Do not put your device in closed cabinets or boxes. Do not place the machine on soft surfaces such as tablecloths or carpets and do not cover the ventilation slits. Otherwise, the device can overheat and catch on fire.

In the event that the device becomes too hot, or if you see smoke coming from the device, you must immediately pull the power cable out of the power socket. Have your device examined by trained professionals at a technical service location. To prevent the spread of fire, open flames should be kept away from the device.

Do not plug in the device in moist rooms. Never touch the mains cable, the mains connection or the telephone socket with wet hands.

Do not allow liquids to enter into the device. Disconnect the device from the power socket if liquids or foreign objects have entered the device and have your device examined by trained professionals at a technical service location.

Do not allow children to handle the device without supervision. The packing materials should be kept out of the hands of children.

The telephone handset of the device is magnetic. Caution, small metallic objects (paper clips) may be retained if placed near or on the telephone handset.

Power Supply

Check whether the mains voltage of your device (indicated on the type label) matches the mains voltage available at the setup location.

Use only the power and telephone cables supplied.

Set up your device so that the power socket is easily accessible. The device does not have an on/off button. In an emergency, disconnect your device from the power supply by pulling the power plug.

Never touch the power or telephone cable if the insulation is damaged.

Disconnect your device from the power and telephone networks during an electrical storm. If this is not possible, do not use the device during an electrical storm.

Before cleaning the surface of your device, disconnect it from the power and telephone networks. Never use liquid, gaseous or easily flammable cleansers (sprays, abrasives, polishes, alcohol).

Only clean the display with a dry, soft cloth. If the display breaks, a mildly corrosive liquid may escape. Avoid all contact with your skin and eyes.

In the event of a power failure, your device will not function; saved data is retained.

Repairs

Should disruptions occur, follow the instructions on the display and on the error report.

Do not make any repairs to the device yourself. Improper maintenance can result in injuries or damage to the device. Only have your device repaired by an authorised service centre.

Do not remove the type label from your device; this would void the warranty.

Consumable Materials

Use only original consumable materials. These are available from a specialised retailer or through our order service. Other consumable materials could damage the device or shorten its service life.

Dispose of old consumable materials according to the waste regulations of your country.

Table of Contents

Dear Customer,	2
About this User Manual	2
Installation Guide	3
Package Contents	3
Attaching the Paper Tray	3
Inserting Paper	3
Connecting the Handset	3
Connecting the Telephone Cable	4
Connecting the Power Cable	4
Initial Installation	4
Overview	5
Overview of the Menu Functions	5
Device Overview	6
Panel	7
General Safety Information.....	8
1 Telephone Functions.....	10
Making Telephone Calls on the Machine	10
Getting outside line	10
Chain Dialling	10
Insert dialling pause	10
Telephone Book of the Machine	10
Groups	11
Short Dialling	11
Calling Line Identification (CLIP)	12
Missed Calls	12
2 Fax.....	13
Sending a Fax	13
Manually Sending a Fax	13
Direct inward dialling or selecting sub-address	13
Listening while a connection is established	14
Broadcasting	14
Delayed Fax Transmission	14
Receiving Faxes	14
Receiving fax manually	14
Polling Faxes	14
Using Fax Templates	15
3 Copier	16
Inserting Documents	16
Creating a Copy	16
Creating Multiple Copies	16
4 Fun and Games	17
Sudoku	17
5 Settings	18
Entering the Date and Time	18
Selecting the Language	18
Selecting the Country	18
Entering Your Number	18
Entering Your Name	18
Setting the Contrast	18
Lowering the Transmission Speed	18
Switching Page Adjustment On and Off	18
Setting the Ring Tone	18
Setting the Fax Switch	19

Printing Lists and Help Pages	19
Starting the Initial Installation	20

6 Telephone Lines and Additional Devices	21
Configuring Telephone Lines and Services	21
Connecting Additional Devices	21
Using Additional Telephones (Easylink)	21
7 Service	23
Checking the Ink Film Reserve	23
Changing the ink film	23
Fixing a Paper Jam	24
Fixing a Document Jam	25
Cleaning	25
Checking the Firmware Version	26
Using Service Codes	26
Power Cycling	26
8 Appendix	28
Technical Data	28
Guarantee	28
Declaration of Conformity (DoC)	29
Customer Information	32

I Telephone Functions

 Press **1** and **3** to print an overview of the telephone book functions.

For information on how to connect additional telephones and which functions are available to you, please refer the chapter on Telephone Connections and Additional Devices, Page 21.

Making Telephone Calls on the Machine

Dial the desired telephone number. There are multiple ways to do this. Then lift up the handset.

 You can also lift up the receiver first, then dial a number. The dialling process begins immediately.

Manual dialling: Dial the desired telephone number with the number pad.

Telephone book:

1 Press **1**A-Z

 You can also load telephone book entries by pressing **OK**, **1** and **OK**.

2 Select an entry using **▲/▼**. Enter the starting letters with the numeric keypad to quickly navigate through the telephone book.

 You can save an entry multiple times with the same name but in a different category. In the telephone book, the first letter of the category appears after the entry.

Short dial: Press **0-9**. Select the desired entry using **▲/▼** or with the numeric keys.

 You can also load short dial entries by holding the respective number button pressed (for at least two seconds).

Redial list: Press **0**. Use **▲/▼** to select an entry from the list of the dialled numbers.

 You can also load the redial list by pressing **OK**, **2** and **OK**.

Caller list: Press and hold **0** (at least two seconds). Use the **▲/▼** to select an entry from the list of callers.

 You can also load the caller list by pressing **OK**, **2** and **OK**.

 For this function to work, the caller line identification (CLIP) must be activated for your telephone connection (country and network dependent). The number and name will not be shown if the caller suppresses his number.

Getting outside line

Private branch exchanges (PABX) are typical in many offices and some households. You must dial an outside line access code in order to get a connection to the public telephone network (PSTN) from a PABX.

Enter the outside line access code with which you reach the public telephone network before you enter the desired number or select a stored entry. The outside line access code is usually **0**.

 In rare cases, the outside line access code may be a different number or a two-digit number. For older telephone systems, the outside line access code can be R (= Flash). Press **R** to enter this outside line access code. If the connexion to the public telephone network is not possible, contact your telephone system supplier.

 If you operate your device permanently at an extension, store the outside line access code with the 96 function (see page 21).

Chain Dialling

You can combine and edit manually entered digits and saved entries, before the dialling process starts. If you have saved, for example, the telephone number prefix of an inexpensive telephone service provider (call-by-call) as a telephone book entry, select this entry and manually enter the subsequent telephone number or select another saved entry.

Insert dialling pause

It may be necessary to insert a dial pause in telephone number, for example, for a direct-inward dialling number, a sub-address or in a long distance number. Hold **R** pressed (for at least two seconds). = appears on the display. The second part of the number is dialled only after a short pause.

Telephone Book of the Machine

In the telephone book of your device, you can save entries with multiple numbers and collect multiple entries into groups. You can assign various ring tones to the entries. Follow the specifications in the technical data.

 You can move the cursor using **▲/▼**. Use **C** to delete individual characters. Press **STOP** to close the menu and return to the starting mode.

Saving entry

1 Hold **1**A-Z pressed (for at least two seconds).

 You can also call the function by pressing **OK**, **1** and **OK**.

2 Enter the name. You can enter characters using the numeric keys (see button labels). Enter special characters using **0**. Press the respective button several times until the desired character or special character appears on the display.

3 Confirm with **OK**.

4 Using **▲/▼**, select the category for which you would like to enter a number: **CATEGORY: HOME**, **CATEGORY: WORK**, **CATEGORY: MOBILE** or **CATEGORY: FAX**.

5 Confirm with **OK**.

6 Enter the telephone number.

7 Confirm with **OK**.

8 You can assign a ring tone to the number. Use the number buttons **0** to **9** to select a ring tone. Using **▲/▼**, set the volume.

9 Confirm with **OK**. The entry is saved.

Edit Entry

- 1 Press **OK**, **①⑤** and **OK**.
- 2 Using **▲/▼** select the entry which you would like to edit.
- 3 Confirm with **OK**.
- 4 Edit the name.
- 5 Confirm with **OK**.
- 6 Using **▲/▼**, select the category for which you would like to enter a number: **CATEGORY: HOME**, **CATEGORY: WORK**, **CATEGORY: MOBILE** or **CATEGORY: FAX**.
- 7 Confirm with **OK**.
- 8 Enter the telephone number.
- 9 Confirm with **OK**.
- 10 You can assign a ring tone to the number. Use the number buttons **⑩** to **⑨** to select a ring tone. Using **▲/▼**, set the volume.
- 11 Confirm with **OK**. The entry is saved.

Deleting an Entry

- 1 Press **OK**, **①⑥** and **OK**.
- 2 Using **▲/▼** select the entry which you would like to delete.
- 3 Confirm with **OK**.
- 4 Confirm **DELETE: YES** with **OK**.

Groups

You can combine several telephone book entries into a group. A message is sent to all members of this group in succession.

Adding Group Entries

- 1 Press **OK**, **①③** and **OK**.
- 2 Use **▲/▼** to select the group you would like to create.
- 3 Confirm with **OK**. You can add entries to the group, display the members of the group, delete the group or send a fax to the group.
- 4 Using **▲/▼** select **ADD MEMBER?**.
- 5 Confirm with **OK**.
- 6 Use **▲/▼** to select the entry you would like to add to the group.
- 7 Confirm with **OK**.
- 8 Repeat steps **4** to **6** to add additional entries to the group.
- 9 Press **STOP** to end the input.

Displaying Group Entries

- 1 Press **OK**, **①③** and **OK**.
- 2 Use **▲/▼** to select the group you would like to display.
- 3 Confirm with **OK**.
- 4 Using **▲/▼** select **VIEW MEMBERS?**.
- 5 Confirm with **OK**.
- 6 Page through the entries of the group with **▲/▼**.
- 7 Press **STOP** twice to return to the starting mode.

Deleting Individual or All Group Entries

Deleting an Individual Entry

- 1 Press **OK**, **①③** and **OK**.
- 2 Using **▲/▼** select the group from which you would like to delete entries.
- 3 Confirm with **OK**.
- 4 Using **▲/▼** select **DELETE MEMBER?**.
- 5 Confirm with **OK**.
- 6 Using **▲/▼** select the entry which you would like to delete.
- 7 Confirm with **OK**.
- 8 Using **▲/▼** select **DELETE: YES**.
- 9 Confirm with **OK**. The entry is deleted.



Deleting a Group

- 1 Press **OK**, **①③** and **OK**.
- 2 Using **▲/▼** select the group you would like to delete.
- 3 Confirm with **OK**.
- 4 Using **▲/▼** select **DELETE MEMBER?**.
- 5 Confirm twice with **OK**.
- 6 Using **▲/▼** select **DELETE: ALL**.
- 7 Confirm with **OK**. All entries in the group are deleted.



Short Dialling

You can assign short dial numbers to frequently dialled telephone numbers. You can load these numbers quickly with the short dial button and the number buttons.

Assigning or Changing a Short Dial Entry

- 1 Hold **0-9** pressed (for at least two seconds).
 You can also call the function by pressing **OK**, **①④** and **OK**.
- 2 Use **▲/▼** or the respective number button to select the short dial number you would like to assign or change.
 If you select a short dial number that is already assigned, the entry is overwritten.
- 3 Confirm with **OK**.
- 4 Use **▲/▼** to select the telephone book entry you would like to assign as a short dial entry.
- 5 Confirm with **OK**.

Deleting a Short Dial Entry

- 1  This function not only deletes the short dial entry, it also deletes the entire entry from the telephone book. Overwrite the short dial entry if you would like to change the assignment.
 1 Press **0-9**.
 You can also call the function by pressing **OK**, **①④** and **OK**.
- 2 Use **▲/▼** or the respective number button to select the entry you would like to delete.
- 3 Press **C**.
- 4 Confirm the deletion with **OK**.

Calling Line Identification (CLIP) (Function is not supported in all countries and networks)

The number of an incoming call appears on the display. For this function to work, the Calling Line Identification Presentation (CLIP) must be activated for your telephone connection. Enquire with your telephone company. Caller Line Identification may be associated with a fee.

 If the Caller Line Identification does not work even though the function is activated for your telephone connection, check if you have set the correct country (also see Chapter Settings, page 18).

Missed Calls

If you received a call while away, the  - button flashes.

- 1 Press .
- 2 Using **▲/▼**, you can page through the list of missed calls.

 If you have received additional messages, first select the missed calls using **▲/▼** and confirm with **OK**.

- 3 To call back, pick up the handset.

 Your machine displays the name with which you have saved the number in the telephone book. The number and name will not be shown if the caller suppresses his number.

2 Fax

 Press **[1]** and **[4]** to print the instructions for sending faxes and for fax switch settings.

 Do not insert any documents into the machine that...

... are wet, have been edited with correction fluid, are soiled or have a coated surface.

... are written on with a soft pencil, with paint, chalk or charcoal.

... originate from newspapers or magazines (printing ink).

... are held together with office or notebook staples or with tape or glue.

... are pasted with note papers.

... are creased, crumpled or torn.

Use documents with sizes **A5** or **A4** with 60 to 100 g/m² weight. You can insert **up to 10 documents** at a time.

 Press **STOP** to eject the documents without sending them.

Sending a Fax

1 Insert the documents face up into the document feeder. The top most document will be fed in first.



2 Set the desired resolution. You can choose between **RESOL. : STANDARD** (for documents without special features), **RESOL. : FINE** (for texts with small print or drawings) and **RESOL. : PHOTO** (for photos). Press **[F]**. The configured resolution appears on the display. Press **[F]** again to change the resolution.

 They can adjust the preset contrast (also see Chapter "Settings", page).

3 Dial the desired number. There are several ways to do this:

4 Press **START**.

 If the subscriber is busy, the device dials the number again after some time. Press **STOP**, in order to cancel the transmission process. After the transmission, the machine prints out a transmission report depending on the settings.

Manual dialling: Dial the desired telephone number with the number pad.

Telephone book:

1 Press **[A-Z]**

 You can also load telephone book entries by pressing **OK**, **[1]** and **OK**.

2 Select an entry using **▲/▼**. Enter the starting letters with the numeric keypad to quickly navigate through the telephone book.

 You can save an entry multiple times with the same name but in a different category. In the telephone book, the first letter of the category appears after the entry.

Short dial: Press **[0-9]**. Select the desired entry using **▲/▼** or with the numeric keys.

 You can also load short dial entries by holding the respective number button pressed (for at least two seconds).

Redial list: Press **[0]**. Use **▲/▼** to select an entry from the list of the dialled numbers.

 You can also load the redial list by pressing **OK**, **[2]** and **OK**.

Caller list: Press and hold **[0]** (at least two seconds). Use the **▲/▼** to select an entry from the list of callers.

 You can also load the caller list by pressing **OK**, **[2]** and **OK**.

 For this function to work, the caller line identification (CLIP) must be activated for your telephone connection (country and network dependent). The number and name will not be shown if the caller suppresses his number.

Manually Sending a Fax

1 Insert the document.

2 Enter the desired number using the numeric keypad or select a saved entry.

3 Press **[*]**.

4 Press **START**.

Direct inward dialling or selecting sub-address

You can send a fax to a direct-inward dialling number or a sub address or call from a direct-inward dialling number or sub address - for example to use a certain service of a fax database provider. For this purpose, attach the direct-inward dialling number or sub address with a short dialling pause to the fax number.

1 Enter the desired number using the numeric keypad or select a saved entry.

2 Hold **R** pressed (for at least two seconds).

3 Enter the direct-inward dialling number or sub address.

4 Press **START**. The direct-inward dialling number or sub address is dialled only after a short pause.

Listening while a connection is established

You can listen while a connection is established, for example if a fax transmission constantly fails.

Enter the desired number using the numeric keypad or select a saved entry. Press **⏏**.

 Hands-free operation is not possible with this function. You cannot answer if the subscriber picks up.

Broadcasting

You can send one fax to multiple recipients in succession.

Entering Recipients Individually

- 1 Insert the document.
- 2 Press **OK**, **③④** and **OK**. The document is now read.
- 3 Enter the desired number using the numeric keypad or select a saved entry.
- 4 Confirm with **OK**.
- 5 Enter the next telephone numbers.
- 6 Confirm with **OK**. You can enter up to 25 recipients.
- 7 Press **START**. The device transmits the fax message successively to all recipients.

Sending a Fax to a Group

- 1 Insert the document.
- 2 Press **OK**, **①③** and **OK**.
- 3 Use **▲▼** to select the group to which you would like to send a fax.
- 4 Confirm with **OK**.
- 5 Using **▲▼** select **SEND FAX?**.
- 6 Confirm with **OK**.

 If your machine cannot reach a recipient, the fax message is sent to the other recipients. After the machine has called all recipients, it once again dials the numbers that previously could not be reached.

Delayed Fax Transmission

If you would like to make use of the lower telephone tariffs or if the recipient can be reached at some specific time only, you can send the fax at a later time – within 24 hours.

- 1 Insert the document.
- 2 Press **OK**, **③③** and **OK**.
- 3 Enter the time, at which the document should be transmitted, e.g. **①④ ①①** for 2 pm.
- 4 Confirm with **OK**.
- 5 Enter the desired number using the numeric keypad or select a saved entry.
- 6 **Selecting a saved entry:** Confirm the selected entry using **OK**.
- 7 Press **START**. The device goes into standby mode and transmits the fax at the entered time. You can continue to make telephone calls and receive faxes.

 Press **STOP** to eject the document. This interrupts the standby mode.

Receiving Faxes

If you have not changed the factory settings, received faxes will be printed out automatically. If no paper or no ink film is inserted, the machine saves the incoming faxes. The  - button blinks. Once paper or a new ink film is inserted, the saved faxes are printed out.

 Check whether you have inserted and clamped in the paper correctly. The lever on the right next to the paper feed mechanism must be pushed back.

If the message memory is full, no additional messages can be received. A warning appears on the display. Observe the information in the technical data.

 If there are problems with printing out saved fax messages, a service code is available (see also section Service, page 26).

Receiving fax manually

Select manual reception under number of rings of the fax switch (see Chapter Setting the Fax Switch, page 19). The device will not receive faxes on its own. This setting is useful, when you want to receive faxes via a modem connected to a computer.

You can start fax reception manually, by pressing **START**.

Polling Faxes

With the fax polling function, you can retrieve faxes that lie ready in the dialled fax machine. You can also provide documents on your machine to be polled by others.

Polling Faxes Directly

- 1 Enter the desired number using the numeric keypad or select a saved entry.
- 2 Hold **START** pressed (for at least two seconds).

Polling Secure Faxes

With this function, you can poll faxes that are protected with a code.

- 1 Press **OK**, **③①** and **OK**.
- 2 Enter the code.
- 3 Confirm with **OK**.
- 4 Enter the desired number using the numeric keypad or select a saved entry.
- 5 Press **START**.

Sending Faxes via Polling

 Protect your document against unauthorised access with a code.

A caller who knows the code can poll the fax from your device. You can continue to make telephone calls and receive faxes.

- 1 Insert the document.
- 2 Press **OK**, **③②** and **OK**.
- 3 Enter a code (max. 20 characters).
- 4 Confirm with **OK**.

 Press **STOP** to eject the document. This interrupts the standby mode.

Using Fax Templates

Five fax templates, which you can use, are stored in your device. With these templates you can quickly create, for example, a short fax note or an invitation.

- 1 Press **OK**, **④③** and **OK**.
- 2 Use **▲/▼** to select the template you would like to print.
- 3 Confirm with **OK**. The device prints the template.
- 4 Fill the template and send it to the desired recipient per fax.

3 Copier

 Press **F1** and **F9** to print help for copying.

Use documents with sizes **A5** or **A4** with 60 to 100 g/m² weight. You can insert **up to 10 documents** at a time.

Inserting Documents

- 1 Insert the documents face up into the document feeder. The top most document will be fed in first.



- 2 Set the desired resolution. You can choose between **RESOL. : STANDARD** (for documents without special features), **RESOL. : FINE** (for texts with small print or drawings) and **RESOL. : PHOTO** (for photos). Press **F4**. The configured resolution appears on the display. Press **F4** again to change the resolution.

 They can adjust the preset contrast (also see Chapter "Settings", page).

Creating a Copy

Press **COPY** briefly. The copy is created.

Creating Multiple Copies

- 1 Hold **COPY** pressed (for at least two seconds).
- 2 Enter the number of times you would like to copy the document (maximum of 15 copies).
- 3 Press **COPY**.
- 4 Using **▲/▼** select whether to reduce or enlarge the document in size when copying. You can magnify up to 200 percent or reduce to as small as 50 percent of the original size.
- 5 Confirm with **OK**. The copy is created.

 Press **STOP** to eject the documents without copying them.

4 Fun and Games

 Press **I** and **7** to print the instructions for the Games and Fun functions of your device.

Sudoku

Sudoku is a Japanese number puzzle. The game has 3×3 squares divided into 3×3 fields. Depending on the difficulty level, lesser or more digits are already given at the beginning of the game. The aim of the game is to fill digits from 1 to 9 in the game field in such a way that each digit appears only once in a row, a column and each of the nine blocks. There is only one solution.

 The solution of the last printed game is saved. The solutions of earlier games are no longer available.

Printing a Game

- 1 Press **OK**, **4** **8** and **OK**.
- 2 Dial using **▲/▼** **SUDOKU: NEW**.
- 3 Confirm using **OK**.
- 4 Using **▲/▼** select the difficulty level.
- 5 Confirm using **OK**.
- 6 Enter, how many copies of the Sudoku you would like to print (maximum 9 copies).
- 7 Confirm using **OK**.
- 8 Using **▲/▼** select if you would like to print the solution.
- 9 Confirm using **OK**.

Printing the Last Game Again

- 1 Press **OK**, **4** **8** and **OK**.
- 2 Dial using **▲/▼** **SUDOKU: LAST**.
- 3 Confirm using **OK**.
- 4 Enter, how many copies of the Sudoku you would like to print (maximum 9 copies).
- 5 Confirm using **OK**.
- 6 Using **▲/▼** select if you would like to print the solution.
- 7 Confirm using **OK**.

Printing the Solution

- 1 Press **OK**, **4** **8** and **OK**.
- 2 Dial using **▲/▼** **SUDOKU: SOLUTION**.
- 3 Confirm using **OK**.

Sudoku for Every Day

You can have a new Sudoku automatically printed each day.

- 1 Press **OK**, **4** **8** and **OK**.
- 2 Using **▲/▼** select **SUDOKU: AUTO**.
- 3 Confirm with **OK**.
- 4 Enter the time, e.g. **1** **4** **0** **0** for 2 pm.
- 5 Confirm with **OK**.
- 6 Using **▲/▼** select the difficulty level.
- 7 Confirm with **OK**.

8 Enter, how many copies of the Sudoku you would like to print (maximum 9 copies).

9 Confirm with **OK**.

10 Using **▲/▼** select if you would like to print the solution.

11 Confirm with **OK**.

12 Using **▲/▼** indicate whether you would like to turn printing on or off.

13 Confirm with **OK**.

 You can turn off the daily Sudoku print by selecting the function as described above and by switching off the automatic printing under point 12.

5 Settings

 You can move the cursor using ▲/▼. Use **C** to delete individual characters. Press **STOP** to close the menu and return to the starting mode.

Entering the Date and Time

- 1 Press **OK**, **9** **1** and **OK**.
- 2 Enter the time, for example **1** **4** **0** **0** for 2 o'clock p.m.
- 3 Enter the date (two digits for each field), for example **0** **8** **0** **6** **0** **7** for June 8th, 2007.
- 4 Confirm with **OK**.

 You must check the time and date after a short power failure. Confirm with **OK**.

Selecting the Language

- 1 Press **OK**, **9** **2** and **OK**.
- 2 Use ▲/▼ to select the desired display language.
- 3 Confirm with **OK**.

Selecting the Country

 Always set the country in which you are operating the machine. Otherwise, your machine is not adapted to the telephone network. If your country is not included in the list, you must select a different setting and use the correct telephone cable for the country. Consult your retailer.

 When you select a new country, all settings are reset to the factory defaults for that country. Saved data is retained. Check the number entered for the header.

- 1 Press **OK**, **9** **3** and **OK**.
- 2 Use ▲/▼ to select the country in which you are operating the machine.
- 3 Confirm with **OK**.
- 4 Using ▲/▼ select **SURE: YES**.
- 5 Confirm with **OK**.

Entering Your Number

Your name and number are added together with date, time and page number at the top edge of each fax transmission (= header).

- 1 Press **OK**, **9** **4** and **OK**.
- 2 Enter your number. Using **#** or ***** you can enter a plus sign.
- 3 Confirm with **OK**.

Entering Your Name

- 1 Press **OK**, **9** **5** and **OK**.
- 2 Enter your name. You can enter characters using the numeric keys (see button labels). Enter special characters using **0**. Press the respective key several times until the desired character or special character appears on the display.
- 3 Confirm using **OK**.

Setting the Contrast

For copying and printing of fax messages, you can select different contrast levels.

- 1 Press **OK**, **4** **4** and **OK**.
- 2 Using ▲/▼, select the desired contrast:
CONTR. : LIGHT—For brighter copies and fax transmission
CONTR. : NEUTRAL—For all types of originals (for example white text on black background or documents with coloured background)
CONTR. : OPTIMISED (Factory settings)—Optimized adaptation for text and photo printing
CONTR. : DARK—For darker copies and fax transmission (for example documents with faint printing)
- 3 Confirm with **OK**.

 The changed settings are stored as new default settings. If you select a special function for a one-time process, take care to restore the default settings or factory settings after that.

Lowering the Transmission Speed

The machine adapts the transmission speed to the line quality. This may take some time, especially for overseas connections. Set a lower transmission speed if you are sending faxes into networks with poor line quality.

- 1 Press **OK**, **3** **8** and **OK**.
- 2 Use ▲/▼ to set whether you would like to use a lower transmission speed.
- 3 Confirm with **OK**.

Switching Page Adjustment On and Off

In order that no information is lost, received faxes are reduced in size when printed.

- 1 Press **OK**, **3** **7** and **OK**.
- 2 Use ▲/▼ to select whether you would like to switch size reduction on or off.
- 3 Confirm with **OK**.

Setting the Ring Tone

Selecting the Ring Tone

You can select from among ten different ring tones.

- 1 Press **OK**, **5** **5** and **OK**.
- 2 Use the number buttons **0** to **9** to select a ring tone. Using ▲/▼, set the volume.
- 3 Confirm with **OK**.

Setting the Volume

You can adjust the volume of the ring tone when the device is ringing or when you set the ring tone. You can save different volumes for the ***** (day) and **☎** (night) modes, (also see Chapter Fax Switch).

Using ▲/▼ you can set adjust the volume when the device is ringing.

Setting the Fax Switch

The built-in fax switch of your device distinguishes between fax messages and telephone calls. Faxes are automatically received, telephone calls can be received—even on additionally connected devices. While the device is checking the call, it continues to ring.

You can set how often the device should ring before picking up separately for the modes *** (day)** and **☾ (night)**. This makes it possible for you to receive faxes silently at night without getting disturbed.

Press **☺/☼/☾** to switch between day and night mode. With the activated timer **⌚**, the device switches between the modes *** (day)** and **☾ (night)** at the configured times.

Configuring Day Mode

- 1 Press **OK**, **⑤①** and **OK**.
- 2 Use **▲/▼** to select the total number of rings. The device stops the ring after these total number of rings and accepts a call or a possible silent fax.
- 3 Confirm with **OK**.
- 4 Use **▲/▼** to select the number of rings for the fax switch. After the number of rings, the fax switch switches on and distinguishes between fax transmissions and telephone calls. While the device is checking the call, it continues to ring.
- 5 Confirm with **OK**.
- 6 Using **▲/▼**, set the volume.
- 7 Confirm with **OK**.



Older devices do not transmit any fax-tone (= CNG tone) as an announcement for fax transmission (= silent fax transmission). If the total number of rings has been set to a value using **7**, silent fax transmissions cannot be received automatically.

Configuring Night Mode

- 1 Press **OK**, **⑤②** and **OK**.
- 2 Configure the same settings as for the day mode (see steps **2** to **7**).

Setting the Timer

The timer switches between the modes *** (day)** and **☾ (night)** at the configured times.

- 1 Press **OK**, **⑤③** and **OK**.
- 2 Enter the time at which the machine should switch to *** (day)** mode, for example **①⑥ ①①** for 6 o'clock a.m.
- 3 Confirm with **OK**.
- 4 Enter the time at which the machine should switch to **☾ (day)** mode, for example **②② ①①** for 2 o'clock a.m.
- 5 Confirm with **OK**.

Special Settings

Silent Fax Reception

If you would like to accept a fax without preceding rings, set the number of rings of the fax switch to **0**.

Switching Off All Rings

If you don't want to be disturbed, e.g. in the night, by any incoming calls, you can set the number of rings to **0**. The device switches immediately to silent fax reception.

Printing Lists and Help Pages

Printing Numbers and Entries

The list of numbers and entries contains the last ten calls received and numbers dialed as well as the saved entries and groups.

Press **OK**, **②③** and **OK**. The list is printed.

Printing the Call List

The call list contains the last 50 numbers dialed.

- 1 Press **OK**, **④①** and **OK**.
- 2 Using **▲/▼** indicate whether you would like to turn printing on or off.
- 3 Confirm with **OK**.
- 4 **Switch on printing:** Use **▲/▼**, to select whether the call list should be printed immediately or after every 50 calls.
- 5 Confirm with **OK**.

Printing the Telephone Book

Press **OK**, **①⑦** and **OK**. The machine prints a list with the telephone book entries and saved assignments.

Printing Fax Journal

The fax journal is a list of the last ten faxes sent and received.

- 1 Press **OK**, **③⑤** and **OK**.
- 2 Using **▲/▼** indicate whether you would like to turn printing on or off.
- 3 Confirm with **OK**.
- 4 **Switch on printing:** Use **▲/▼**, to select whether the fax journal should be printed immediately or after every ten transmissions.
- 5 Confirm with **OK**.

Printing Transmission Report

After every transmission, the machine prints out a transmission report. If a transmission error occurs, an error report is printed out. You can switch off printing of the transmission report.

- 1 Press **OK**, **③⑥** and **OK**.
- 2 Using **▲/▼** indicate whether you would like to turn printing on or off.
- 3 Confirm with **OK**.

Printing Help Pages

Help 1 · Overview

Press **1** and **①** to print an overview of the help pages.

Help 3 · Telephone Functions

Press **1** and **③** to print an overview of the telephone book functions.

Help 4 · Fax Transmission

Press **1** and **4** to print instructions for sending fax messages and for configuring the fax switch.

Help 5 · Copier

Press **1** and **5** to print the help for copying.

Help 6 · Function List

Press **1** and **6** to print a list of all functions and settings of your machine.

Help 7 · Games and Fun

Press **1** and **7** to print the instructions for the Games and Fun functions of your device.

Starting the Initial Installation

- 1 Press **1** and **2**.
- 2 The machine prints out a help page and starts the initial installation process.

6 Telephone Lines and Additional Devices

Configuring Telephone Lines and Services

PABX Systems

Private branch exchanges (PABX) are typical in many of-fices and some households. You must dial an outside line access code in order to get a connection to the public telephone network (PSTN) from a PABX.

 An additional telephone connected to the machine on a telephone socket is not considered an extension.

- 1 Press **OK**, **Ⓞ** and **OK**.
- 2 In some countries you can set the dialling process to pulse dialling or tone dialling (DTMF tones). Use **▲/▼** to select the desired dialling process.
 Only use pulse dialling if tone dialling is not yet activated for your telephone line.
- 3 Confirm with **OK**.
- 4 Use **▲/▼** to set whether you operate your device on an extension.
- 5 Confirm with **OK**.
- 6 **Configuring an extension:** Enter the outside line access code with which you reach the public telephone network. This is usually **Ⓞ**.

 In rare cases, the outside line access code may be a different number or a two-digit number. For older telephone systems, the outside line access code can be R (= Flash). Press **R** to enter this outside line access code. If the connexion to the public telephone network is not possible, contact your telephone system supplier.

- 7 Confirm with **OK**.
- 8 When finished, the device tests the telephone line. Confirm with **OK**.
- 9 Your device checks whether it can establish a connection with the public telephone network. If it cannot establish the connection, you are once again asked for input.

DSL Connection

In the event that you use a DSL modem: Connect the machine after the modem. For additional information, please consult the operating manual of your DSL system.

ISDN Connection

Your device is an analogue fax device (Group 3). It is not an ISDN device (Group 4), and therefore it cannot be operated directly on an ISDN connection. In order to do this, you need either an analogue adapter or a connection for analogue terminals. Details for ISDN connections can be found in the instructions provided with the terminal adapter or the dial-up router.

Voice-Mailbox

You cannot simultaneously use the answering machine facility of your telephone service provider (= voice-mail box) and receive faxes on your devices. Get the mail-box function for your telephone connection deactivated or set the number of rings for the fax switch to lower than **5** on your device (also see Chapter Setting the Fax Switch, Page 19). When the fax switch accepts the call, the mail-box of the service provider does not step in. Enquire with your telephone company.

Connecting Additional Devices

You can operate additional devices on a telephone line, such as cordless telephones, answering machines, modems or charge counters.

Connection to the Machine

You can connect additional devices directly to your device. Insert the telephone cable of the additional device into the **EXT-** socket (RJ-11-connection) on the device.

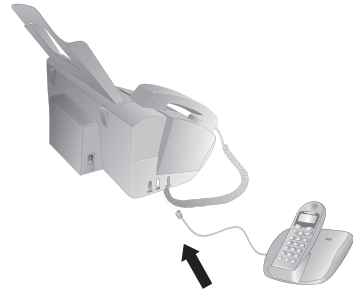

 We recommend direct connection to the device because this allows the fax switch to function optimally and to control the additional devices.

Connection to the Telephone Line

In order for the fax switch to function, the machine must be first in the series if multiple devices are connected to the same telephone socket. Follow the correct order.

 If you have multiple telephone sockets for the same telephone line, the machine must be connected to the first telephone socket.

Using Additional Telephones (Easylink)

With the Easylink function you can control your device with additional telephones. To use this function, additional telephones must be set to the tone dialling mode (DTMF/MFV tones) (for this purpose see the operating manual of your additional telephone).

Starting Fax Reception

If you pick up at an additional device and hear that you are receiving a fax (whistling tone or silence), you can start the fax reception by pressing ***Ⓞ** on the additional telephone or pressing **START** on the device.

Taking Over the Line

If you pick up on an additional telephone and the machine continues to ring or attempts to receive a fax, you can disconnect the machine from the line. Press **(*)** on the additional telephone.

Changing Code

 Only change the codes if it is absolutely necessary. The codes must begin with **(*)** or **(#)** and must be different.

- 1 Press **OK**, **(5)** **(4)** and **OK**.
- 2 Enter the new code for starting fax reception.
- 3 Confirm with **OK**.
- 4 Enter the new code for taking over the line on an additional device.
- 5 Confirm with **OK**.

Using an External Answering Machine

For the best operation, the answering machine must be connected to the **EXT** socket of the device. The number of rings set for the external answering machine should be less than the one set under **FAX RINGS** by at least two.

Example of the setting:

Number of rings of the external answering machine	1
FAX RINGS	3
TOTAL RINGS	5

(also see Chapter Setting the Fax Switch, Page 19)

 The outgoing message should be shorter than ten seconds. Avoid music in the outgoing message.

If the external answering machine has a “conserving function” (i.e. a function that changes the number of rings as soon as new messages have been recorded), switch it off.

If the external answering machine records fax signals, but your device cannot receive faxes, inspect the connection of the external answering machine

7 Service

 Should disruptions occur, follow the instructions on the display and on the error report.

Checking the Ink Film Reserve

- 1 Press **OK**, **④** **⑥** and **OK**.
- 2 The number of pages that can still be printed with the ink film is shown on the display.
- 3 Press **STOP** to return to the starting mode.

If the ink film used up or if there is no ink film in the machine, a message appears on the display.

Changing the ink film

 Use only original consumable materials. These are available from a specialised retailer or through our order service. Other consumable materials can cause damage to the machine.

 Follow the instructions on the packaging of the consumable materials.

For receiving or copying documents, an ink film must be inserted in your device. Your device is delivered with an already inserted free ink film for a few test pages. For this film, you do not require any Plug'n'Print card (= chip card with information regarding ink film capacity). For every next film that you insert, you must load the capacity memory with the included Plug'n'Print card.

- 1 Remove the paper from the paper feeder and take the paper tray out of the device.
- 2 Open the device by lifting the panel using grip in the centre and folding it down.



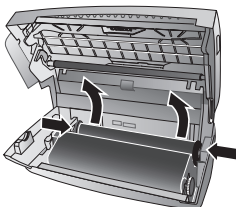

 Lock the cover of the machine completely into place when opening the machine. You could be injured if the cover falls while you are working on the machine.

- 3 Grip the rear ink film roll at both the sides and place it next to the front ink film roll.

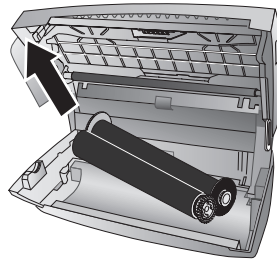

- 4 Remove both the rolls from the device. The used ink film cannot be reused.



 The messages and copies you have printed out can be read from used ink films. Consider data protection issues when disposing of used ink films.

- 5 Pull the used Plug'n'Print card out of the plug socket on the left hand side next to the ink film tray. The Plug'n'Print card cannot be reused.

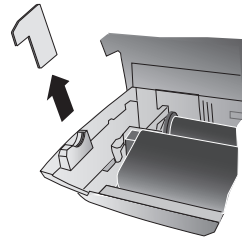

- 6 Carefully remove the rubber bands from the new ink film. Make sure that the film is not damaged!

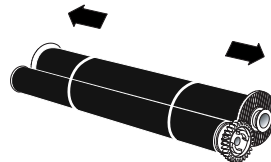

- 7 Place the larger roll with the ink film in the rear ink film tray. The blue gear wheel must be on the right hand side.

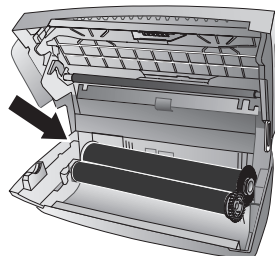

- 8** Place the smaller roll without film in the front tray. The blue gear wheel must be on the right hand side and the pin must be inserted in the depression on the left hand side.

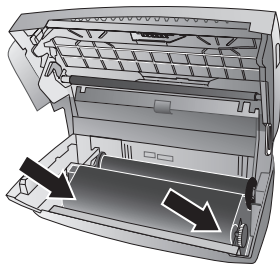

- 9** Break the chip card from the Plug'n'Print card. Insert the chip card in the plug socket on the left hand side next to the ink film tray.

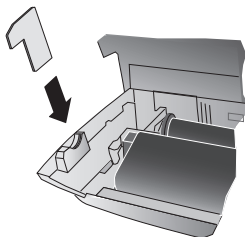

- 10** Turn the blue gear wheel forward to tension the ink film. The ink film must not have any creases.

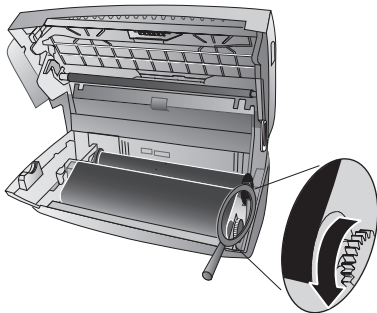

- 11** Close the device. Insert the paper tray in the opening provided for it behind the paper feeder. Insert paper again.

Fixing a Paper Jam

- 1 Remove the paper from the paper feeder and take the paper tray out of the device.
- 2 Open the device by lifting the panel using grip in the centre and folding it down.



- ⚠** Lock the cover of the machine completely into place when opening the machine. You could be injured if the cover falls while you are working on the machine.

- 3 Carefully pull the paper out.

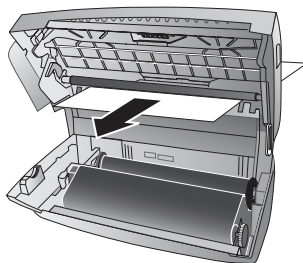

- 4 Turn the blue gear wheel forward to tension the ink film. The ink film must not have any creases.

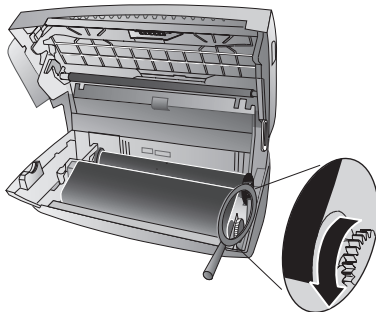

- 5 Close the device. Insert the paper tray in the opening provided for it behind the paper feeder. Insert paper again.

Fixing a Document Jam

- 1 Remove the paper from the paper feeder and take the paper tray out of the device.
- 2 Open the device by lifting the panel using grip in the centre and folding it down.

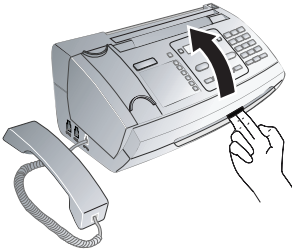

⚠ Lock the cover of the machine completely into place when opening the machine. You could be injured if the cover falls while you are working on the machine.

- 3 Open the scanner cover and the cover of the automatic document cover by first pushing the support (A) and then the support (B) inside. The cover (C) folds below.

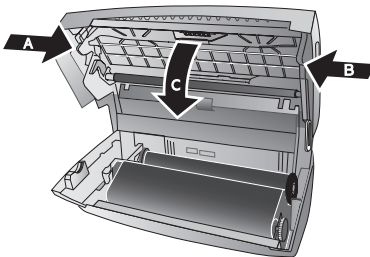

- 4 Carefully pull the document to the front or to the back out of the device.

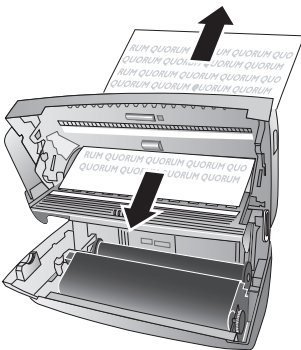

- 5 Close the scanner cover and the cover of the automatic document feeder. Both the supports must securely snap into place.

- 6 Turn the blue gear wheel forward to tension the ink film. The ink film must not have any creases.

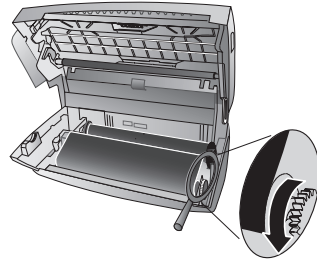

- 7 Close the device. Insert the paper tray in the opening provided for it behind the paper feeder. Insert paper again.

Cleaning

⚠ Unplug the machine from the power socket before cleaning it. Use a soft, lint-free cloth. Never use liquid or easily flammable cleansers (sprays, abrasives, polishes, alcohol, etc.). Do not allow any moisture to reach the interior of the fax machine.

💡 Special fax cleaning sheets are available as accessories from our call centre. Insert a sheet into the document feeder. Press **STOP**; the page is ejected. Repeat this process at a few times.

- 1 Remove the paper from the paper feeder and take the paper tray out of the device.
- 2 Open the device by lifting the panel using grip in the centre and folding it down.



⚠ Lock the cover of the machine completely into place when opening the machine. You could be injured if the cover falls while you are working on the machine.

- 3 Open the scanner cover and the cover of the automatic document cover by first pushing the support (A) and then the support (B) inside. The cover (C) folds below.

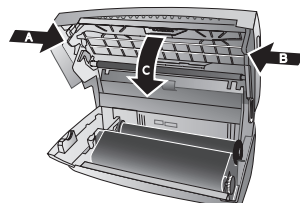

- 4 Lightly wipe the upper side of the scanner glass (A) and the lower side of the document feeder/scanner film (= white plastic plate) (B) with a cloth.

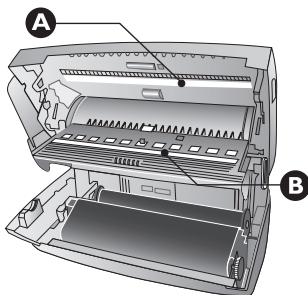

- 5 Clean the feed roller (A) and the underside of the support pad of the feeder roller (B) with a soft, lint-free cloth moistened with cleaning alcohol (96 percent). Rotate the feed roller; You must clean the entire roller.

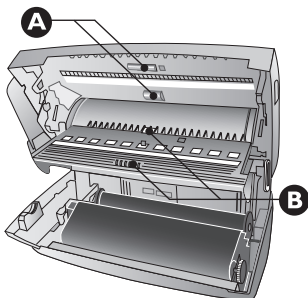

- 6 Close the scanner cover and the cover of the automatic document feeder. Both the supports must securely snap into place.
- 7 Turn the blue gear wheel forward to tension the ink film. The ink film must not have any creases.

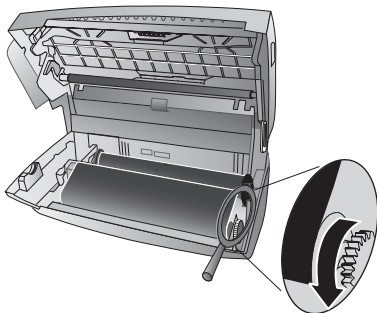

- 8 Close the device. Insert the paper tray in the opening provided for it behind the paper feeder. Insert paper again.

Checking the Firmware Version

- 1 Press **OK**, **④⑦** and **OK**.
- 2 The model designation and the configured country appear on the display.
- 3 Confirm with **OK**.
- 4 The information on the firmware version of the device is displayed.
- 5 Confirm with **OK**.

Using Service Codes

The service codes delete all the changed settings and your device is reset to factory settings. It may be possible that the device with the changed settings reacts differently than expected.

⚠ Only use the service codes if this is absolutely necessary. Some service codes also delete saved messages and telephone book entries.

- 1 Press **OK**, **④⑤** and **OK**.
- 2 Enter a service code:
 - ⑦①①⑦**—Deletes all changed settings and saved data. The device is reset to factory settings and the initial installation process is started.
 - ⑦①④⑩**—Deletes all changed settings. Saved data and telephone book entries remain intact.
 - ⑦②②⑦**—Deletes saved faxes, when there are problems with printing.
- 3 Confirm using **OK**.
- 4 Dial using **▲/▼ SURE: YES**.
- 5 Confirm using **OK**.

⚠ If you have entered the incorrect code, you can cancel the entry with **SURE: NO**.

Power Cycling

If a problem occurs that cannot be corrected with the instructions in this user manual (see also the help below), follow the steps given here.

- 1 Pull out the power plug.
- 2 Wait at least ten seconds, then plug the power plug back into the socket.
- 3 If the error occurs again, please contact our technical customer service or your retailer. Follow the instructions on the display and on the error report.

General information	
The time and date flash on the display.	You must check the time and date after a short power failure. Confirm using OK .
Problems when faxing or printing	
Faxes sent are of poor quality.	Change the resolution from RESOL. : STANDARD to RESOL. : FINE or RESOL. : PHOTO . Change the contrast. Clean the scanner and the document feed slot. Test the device by making a copy of the document. If the device is in order, the fax machine of the recipient is defective.
The device produces black lines when sending or printing.	Clean the scanner and the document feed slot.
Copy is blank.	Insert the documents face up into the document feeder.
Printing is interrupted.	Paper or document jam, no paper or ink film. Follow the instructions on the display and in the error report. There could be a small pause after printing several pages. The device continues printing automatically.
No printing	Check if you have inserted clamped paper correctly. The lever on the right hand side next to the paper feeder must be folded backwards.
Documents are not properly fed.	Clean the scanner and the document feed slot.
Problems with the connection	
The device rings once, remains silent for a short while and starts ringing again.	This is absolutely normal. The fax switch checks the call after the first ring. If it is a voice call, the device continues to ring.
No dial tone	Check the installation of the device. Connect the telephone cable to the socket marked LINE . Insert the telephone plug into your telephone connection socket.
Fax transmissions are constantly interrupted.	Try to send the fax manually: Press ⏏ and dial the number. If the recipient is using an answering machine, wait until you hear a whistling tone. Press START . It is possible that the recipient's machine is not ready to receive.
You hear a whistling tone or silence in the handset.	The call is a fax: Press START on the device. In addition, press *5 on the telephone. Hang up.
No fax reception or a short fax audio signal as message on the answering machine	Using function 51, set the number of rings for the fax switch to 4 and the total number or the number of rings for the answering machine (model dependent) to 5 (see Page 19). You cannot simultaneously use the answering machine facility of your telephone service provider (= voice-mail box) and receive faxes on your devices(see page 21).

8 Appendix

Technical Data

Dimensions (L x H x W)	313 x 129 x 197 mm
Weight	1,9 kg
Power Supply	220–240 V - / 50–60 Hz
Power Consumption	
Stand-by mode	< 1,5 W
Transmission	< 20 W
Recommended Ambient Temperature.....	18–28 °C
Relative humidity	20–80 % (non-condensing)
Type of connection.....	PSTN · PABX
Dialling mode. Tone / pulse dialling (country dependent)	

Standards

Safety.....	EN 60950-1
Emissions	EN 55022 Class B
Immunity to electrical noise	EN 55024

Scanner

Scan width.....	212 mm
Horizontal resolution.....	8 dots/mm
Vertical resolution	Standard: 3,85 lines/mm
.....	Fine: 7,7 lines/mm

Memory

Telephone book.....	up to 50 entries
Fax messages.....	up to 15 pages (standard test letter)

Paper

Capacity	50 sheets
Size.....	A4 · 210 x 297 mm
Thickness	0,07–0,11 mm
Weight	60–90 g/m ²

Document Feeder

Capacity	10 sheets
Breadth.....	148–212 mm
Length	100–600 mm
Thickness	0,06–0,15 mm

Fax

Type.....	Group 3
Compatibility	ITU-TT.30
Data compression	MH · MR
Modulation	V.21 · V.27ter · V.29
Transmission speed.....	9.600 bps

Technical specifications subject to change without notice.

Guarantee

(UK Terms and Conditions)

At the beginning of April 2002, SAGEM SA bought the PHILIPS fax business unit. SAGEM SA is now the European Number 1 in fax and offers a complete range of fax terminals with Internet access and SMS function, multi-functional terminals and servers covering the needs of all its customers—from home-users to multinational organisations.

In order to apply the guarantee, you should contact your dealer. Proof of purchase will be required. Should malfunctioning arise, the dealer will advise you what to do.

If you bought your equipment from SAGEM directly, the following shall apply:

A SAGEM undertakes to remedy by repair, free of charge for labour and replacement parts, any defects in the equipment during a period of twelve (12) months from the date of original delivery of the Equipment, where those defects are a result of faulty workmanship. During this twelve month guarantee period, the defective equipment will be repaired free of charge; the customer must however first contact the SAGEM After Sales Department, the phone number of which can be found on the delivery slip or in the user manual. Unless the customer has concluded with SAGEM a maintenance contract in respect of the equipment which specifically provides for repairs to be carried out at the customer's premises, the repairs will not be carried out on the equipment at the customer's premises. The following sentence applies to purchases of equipment for the customer's trade, business or profession. Except as otherwise expressly provided in this Document and to the extent permitted by law, SAGEM makes no representations or warranties, express or implied, statutory or otherwise, and to such extent, all terms and conditions implied by law are hereby excluded. This guarantee does not affect the Customer's statutory rights.

B Exclusions From Guarantee

SAGEM shall have no liability under the guarantee in respect of:

- damage, defects breakdown or malfunction due to:
 - failure to properly follow the installation process and instructions for use; or
 - an external cause to the equipment (including but not limited to, lightning, fire, shock or water damage of any nature); or
 - modifications made without the written approval of SAGEM SA; or
 - a failure or neglect to maintain the equipment or inappropriate maintenance; or
 - unsuitable operating conditions, particularly of temperature and humidity; or
 - repair or maintenance of the equipment by persons not authorised by SAGEM; or

- wear and tear from normal daily use of the equipment and its accessories
- damage due to insufficient or bad packaging of equipment when returned to SAGEM
- supply of new versions of software
- work on any equipment or software modified or added without the prior written consent of SAGEM
- malfunctions not resulting from the Equipment or from software installed in user workstations for the purpose of use of the equipment
- communication problems related to an unsuitable environment, including:
 - problems related to access and/or connection to the Internet such as interruptions by access networks or malfunction of the line used by the subscriber or his correspondent
 - transmission faults (for example poor geographical coverage by radio transmitters, interference or poor line quality)
 - the local network fault (wiring, servers, workstations) or the failure of the transmission network
- the normal servicing (as defined in the user guide supplied with the equipment) as well as malfunctioning due to servicing not being carried out, servicing costs are in any event always borne by the customer.

C In the cases set forth in § B as well as after expiry of the twelve month guarantee period, the customer must ask SAGEM for an estimate, and he/she must accept the estimate and agree to pay the charges mentioned in it before returning the equipment to SAGEM. The repair and delivery costs will be invoiced to the customer.

The foregoing shall apply unless otherwise agreed in writing with the customer and only for the UK. If any provision of this guarantee shall be held to be in whole or in part invalid or illegal due to an obligatory rule applicable to consumers pursuant to their national legislation, such invalidity or illegality shall not impair or affect the remaining provisions or parts of this guarantee.



The CE symbol confirms conformity with the EU directives that apply to the device.

Declaration of Conformity (DoC)

Hereby, **Sagem Communication Austria GmbH** declares that this **PPF 631, PPF 632** is in compliance with the essential requirements and other relevant provisions of Directive 1999/5/EC.

You can find the complete Declaration of Conformity on our website www.sagem-ca.at/doc



As a participant in the ENERGY STAR programme, Sagem Communication Austria GmbH has made sure that this machine complies with the ENERGY STAR requirements.

Environment: Respect of environment is a key objective of Sagem. Sagem uses environmentally friendly processes to run its operations and has chosen to integrate strong environmental constraints in the full lifecycle of its products including manufacturing, product use and end of life.



Packaging: To facilitate packaging recycling, please conform to your local selective recycling rules.

Batteries: Old batteries have to be deposited in designated collection areas.



Product: The crossed out dustbin logo on your product signifies it is classified as Electrical and Electronic Equipment covered by special disposal regulations.

To enforce recycling, recovery of The Waste Electrical and Electronic Equipment (WEEE) and to protect the environment and human health, European regulations requires that you selectively collect waste equipment using one of the following options:

- Your retailer will take your equipment back if you are buying a replacement product.
- Waste equipment can also be deposited in designated collection areas.

This user manual was printed on recycled paper bleached without chlorine. This satisfies the highest standards for low environmental impact. The cardboard packaging used and the packaging inserts of paper and cardboard can be disposed of as waste paper. The plastic foil may be submitted for recycling or disposed of with waste not intended for recycling, depending on the requirements in your country.

Trademarks: The references mentioned in this manual are trademarks of the respective companies. The lack of the symbols ° and ™ does not justify the assumption that these dedicated terms are free trademarks. Other product names used herein are for identification purposes only and may be trademarks of their respective owners. Sagem disclaims any and all rights in those marks.

The reproduction of certain documents (e.g. by scanning, printing, copying) is prohibited in many countries. The list of such documents below is not intended to be complete, it only offers a general overview. In case of doubt, consult your legal advisor.

- Passports (personal identification)
- Entrance and exit visa papers (immigration papers)
- Military service documents
- Bank notes, travel checks, payment orders
- Postage stamps, tax stamps (stamped or unstamped)
- Loan papers, certificates of deposit, bonds
- Documents protected by copyright

Follow the statutory regulations of your country with regard to the legal validity of fax transmissions – particularly in connection with the validity of signatures, meeting delivery deadlines or disadvantages resulting from the loss of quality in the transmission, etc.

Take care to maintain the statutory regulations of your country regarding telecommunications secrecy and data privacy.

This product is intended for use on an analogue public telecommunications network (PSTN) and in the country specified on the packaging. Use in other countries can result in faulty functioning.

For more information, please contact the technical service centre for your country. Should problems arise during use of your machine, please contact your retailer first.

Neither Sagem nor its affiliates shall be liable to the purchaser of this product or third parties for damages, losses, costs, or expenses incurred by the purchaser or third parties as a result of accident, misuse, or abuse of this product or unauthorized modifications, repairs, or alterations to this product, or failure to strictly comply with Sagem operating and maintenance instructions.

Sagem shall not be liable for any damages or problems arising from the use of any options or any consumable materials other than those designated as original Sagem products or Sagem approved products.

Sagem shall not be held liable for any damage resulting from electromagnetic interference that occurs from the use of any interface cables other than those designated as Sagem products.

All rights reserved. No part of this publication may be reproduced, stored in a retrieval system or transmitted in any form or by any means, electronic, mechanical, photocopying, recording, or otherwise, without the prior written permission of Sagem. The information contained herein is designed only for use with this product. Sagem is not responsible, if this information is applied to other devices.

This user manual is a document that does not represent a contract.

Errors, printing errors and changes are reserved.

Copyright © 2008 Sagem Communication Austria GmbH

Customer Information

As part of our continuing quest for total customer satisfaction, all of our products are made with ease-of-use and reliability in mind.

In your user manual you will find all the information required to use your machine. If, after consulting your user manual, you still require assistance, you should contact our Call Centre. Our personnel are highly trained specialists who can ensure that you receive the maximum benefit from your product.

We can assist you more quickly if you do not call us from the machine, rather an external telephone. Keep a printout of the settings as well as the serial number of the machine handy. The serial number can be found on the type label.

United Kingdom

Telephone: 08 71 - 075 07 11 (0,10 £/minute)

Fax: 08 70 - 124 02 02

Use only PHILIPS accessories. The warranty does not cover damages to the machine resulting from the use of other consumable materials.

In United Kingdom, you can order PHILIPS accessories by telephone via our toll-free telephone number.

United Kingdom

Telephone: 08 00 - 358 08 07

E-Mail: dti.faxinfo@sgem.com

Internet: www.sagem-communications.com

We hope that you will enjoy using your new product!

SAGEM COMMUNICATIONS

Printing Terminals

Headquarters : Le Ponant de Paris
27, rue Leblanc · 75015 Paris · FRANCE
Tél. : +33 1 58 11 77 00 · Fax : +33 1 58 11 77 77

www.sagem-communications.com
Limited company · Capital 167.038.185 Euros · 440 294 510 RCS PARIS
Sagem is a registered brand of SAFRAN Group

PPF 631 · 632

UK

253056155-A

Download from Www.Somanuals.com. All Manuals Search And Download.



Free Manuals Download Website

<http://myh66.com>

<http://usermanuals.us>

<http://www.somanuals.com>

<http://www.4manuals.cc>

<http://www.manual-lib.com>

<http://www.404manual.com>

<http://www.luxmanual.com>

<http://aubethermostatmanual.com>

Golf course search by state

<http://golfingnear.com>

Email search by domain

<http://emailbydomain.com>

Auto manuals search

<http://auto.somanuals.com>

TV manuals search

<http://tv.somanuals.com>