

# User manual



**Charge the handset(s) for 24 hours before use !**

# PHILIPS



<b>3</b>	<b>Contents</b>
<b>4</b>	<b>Important information</b>
<b>6</b>	<b>What's in the box</b>
<b>7</b>	<b>Your VOIP 321</b>
<b>9</b>	<b>Icons on the handset display</b>
<b>10</b>	<b>Install</b>
<b>12</b>	<b>Connect</b>
<b>13</b>	<b>Main menu</b>
<b>14</b>	<b>Call</b>
<b>21</b>	<b>Phonebook</b>
<b>24</b>	<b>Call log</b>
<b>25</b>	<b>Redial list</b>
<b>27</b>	<b>Other features</b>
<b>35</b>	<b>Using the intercom</b>
<b>37</b>	<b>Default settings</b>
<b>38</b>	<b>Troubleshooting</b>
<b>39</b>	<b>Informations</b>
<b>41</b>	<b>Index</b>

## Instructions for use for the VOIP 321

The VOIP321 is a Skype ready USB / PSTN phone, capable of voice communication through Internet protocol as well as on a normal telephone line.

## For your safety

### Safety information

This telephone is not designed for making emergency telephone calls when the power fails. An alternative should be made available for access to emergency calls.

### Power requirements

The product requires an electrical supply of 220 - 240 volts, single phase alternating current, excluding IT installations defined in standard EN 60950.

### Battery requirements

The handset requires power source of two rechargeable NiMH batteries, size AAA 1.2V 650mAh. IF THE INCORRECT TYPE OF BATTERIES ARE USED, A WARNING MESSAGE WILL BE DISPLAYED.

**WARNING :** The electrical network is classified as dangerous according to criteria in the standard IEC 60950. The only way to power down this product is by unplugging the power supply from the electrical outlet. Ensure the electrical outlet is located close to the apparatus and is always easily accessible.

**CAUTION :** RISK OF EXPLOSION IF BATTERY IS REPLACED BY AN INCORRECT TYPE. Never use non-rechargeable batteries; use recommended type supplied with this telephone. NiMH batteries must be disposed of in accordance with the applicable waste disposal regulations.

## Safety precautions

- > Do not allow the handset to come into contact with liquids or moisture.
- > Do not open the handset or base station. This could expose you to high voltages.
- > Do not allow the charging contacts of the charger or the battery to come into contact with extraneous conductive materials.
- > There is a slight chance that the telephone could be damaged by an electrical storm. It is recommended that users unplug the phone from the USB socket and the phone line from the phone wall socket during a storm.
- > Do not use the handset in an explosive hazard area such as where there is gas leaking.
- > Young children should be supervised to ensure that they do not play with the telephone.
- > Because the phone works by sending radio signals between the base unit and the handset, wearers of hearing aids may experience interference in the form of a humming noise.
- > We advise that this phone should not be used near intensive care medical equipment or by persons with pacemakers.
- > Your phone can interfere with electrical equipment such as answering machines, TV and radio sets if placed too close. It is recommended that you position the base unit at least one meter from such appliances.

## Install requirements

In order to use the phone, your computer should meet the following requirements :

- PC running Windows 2000 or XP
- 400 MHz processor
- 128 MB RAM
- Free USB slot on the PC
- Internet Connection (broadband recommended)

## Need help

**For more information on troubleshooting and FAQ's:**

Online help : [www.p4c.philips.com](http://www.p4c.philips.com)

Troubleshooting : see page 38

DFU update on : [www.p4c.philips.com](http://www.p4c.philips.com)

# What's in the box



Handset VOIP 321



2 AAA Battery



Battery door

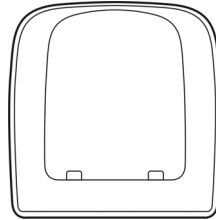

Charger

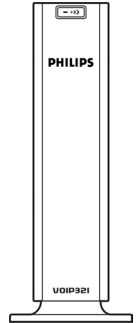

Base station VOIP 321

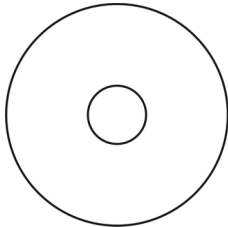

Installation CDROM



Quick Start Guide

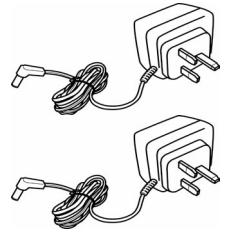

I power supply for base station  
and I power supply for charger



Line Cord and line adaptor (if relevant) to plug the  
RJ11/RJ11 Line Cord (see below) in your wall plug

## What else you need :

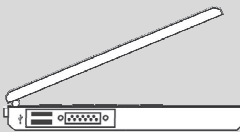

A desktop or a laptop  
with free USB port



A telephone line

- Internet connection (broadband recommended)
- Only the Skype version printed on the CD ROM is granted for a full compatibility. New feature may not work with VOIP 321 when upgrading Skype.

## Overview handset

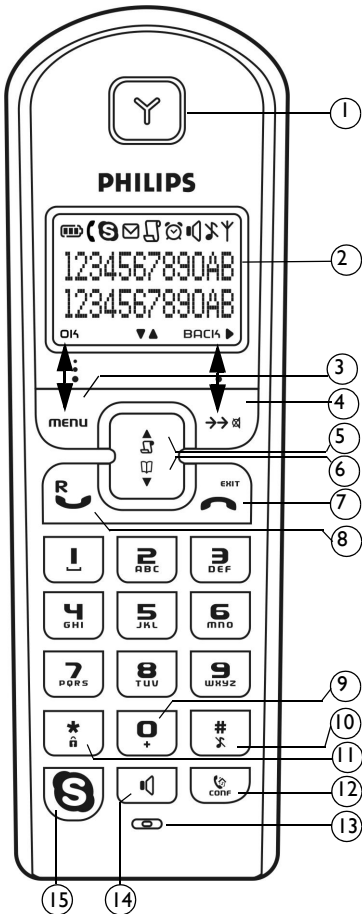

- 1 **Earpiece**
- 2 **Display, icons see page 9**
- 3 **Menu key & Softkey OK**  
Use to enter menus.  
Use to select menu.  
Use to confirm an operation.
- 4 **Redial, Mute & Softkey Back**  
Use to switch between call details.  
Use to enter dial list.  
Use to redial last dialled number.  
Use to mute/unmute a call  
Use to delete text and digits.
- 5 **CID & Scroll up Key**  
Use to enter call list.  
Use to scroll up items  
Use to increase ringer and receiver volume.
- 6 **Phonebook & Scroll down Key**  
Use to access phonebook.  
Use to scroll down items.  
Use to reduce ringer and receiver volume.
- 7 **Off & Exit Key**  
Use to end a call.  
Use to exit menus.  
Use to turn the handset ON/OFF.
- 8 **Talk & Recall Key**  
Use to make and receive calls.  
Use to send flash signal.  
Use to pick up or make second incoming calls on Skype.
- 9 **0 and + key**  
Use to enter 0 when making a call.  
Press and hold to enter + while making SkypeOut calls.
- 10 **Pound, Ringer off & Pause Key**  
Use to enter a pause.  
Use to turn the ringer on/off.
- 11 **Star & Key lock Key**  
Use to lock the keypad.
- 12 **Intercom and Conference Key**  
Use to make intercom calls.  
Use to set up 3-way conference.
- 13 **Microphone**
- 14 **Loudspeaker Key\***  
Use to turn the speaker on/off.
- 15 **Skype key**  
Use to make SkypeOut calls.  
Use to launch Skype contact list.

**\*Warning!** Handsfree activation could suddenly increase the volume in the loudspeaker to a very high level. Make sure the handset is not too close to your ear.

## Overview base station

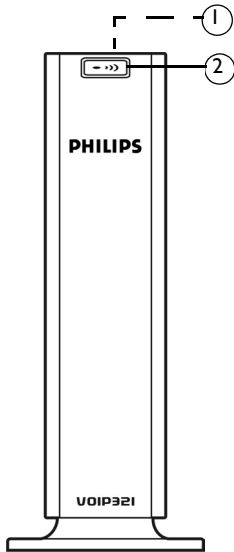

### 1 LED on base station



- On when the base is powered up.
- Blinks normally when there is an incoming telephone call or during a telephone call.
- Blinks slowly while paging the handset.
- Blinks quickly during registration mode.



- Steady ON when the USB is plugged in and the base is powered up.
- Flash when there is data communication with USB.

### 2 Paging key

- Use to page the handset.
- Use to register a handset.

## Main features



- Contact list display on handset.
- Connection and Skype status display.
- Skype status display for each contact on the contact list.
- Change your online status on the handset.

## Dual line phone

- Able to receive calls from Skype as well as from regular telephone line.
- User selectable melodies for each line for easy recognition.
- Call waiting alert when there is another incoming call from another line.



# Icons on the handset display

EN

When being used for the first time, it is sometimes necessary to wait until the battery is sufficiently charged before the icons appear on the display.

The display gives information about the operation of your telephone. Following icons can be shown in the headline of the display.



Base/Handset link.



Telephone call in progress.



Battery full; 2/3 full; 1/3 full; Empty, please charge.



Loudspeaker is turned on.



The alarm clock is turned on.



The ringer is turned off.



There is a new Caller ID record or Caller ID records are being reviewed.



Message Waiting Indicator.



Skype call in progress.



Digits/characters on the right.



More menu options are available upward.



More menu options are available downward.



OK/Confirmation of selection.



Press to return to the previous screen.  
Press to erase text or digits.

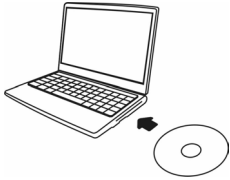

## How to install the software

Before using your phone, please install the VOIP321 driver provided in the enclosed CD.

To install the VOIP321 driver :

1. Insert the installation CD into the PC's CD ROM (or DVDROM) drive.
2. The installation program will start automatically.
3. Follow the instructions on the screen.
4. Click on **Quit**.
5. Remove the installation CD from the PC's CD ROM (or DVDROM) drive.

**TIP :** If for some reason the installation does not start automatically :

- Click on Windows **START** and then **Run**.
- Type **explorer** and navigate to the CD ROM (or DVDROM) drive.
- Double-click on **Setupwizard.exe**.

- > If your operating system is Windows 2000, you need to restart your PC to complete the setup.
- > The VOIP 321 driver should autostart if this option is checked during installation.

## Getting Ready To start making Skype call

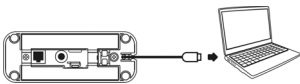

1. Power up your base and connect your USB base on a free USB port of your PC if you have not already done so.
2. Start the VOIP 321 driver by double clicking on the shortcut icon created on your desktop if it is not already started.
3. If this is the first time you use the VOIP 321 driver, you will see the message **ANOTHER PROGRAM WANTS TO USE SKYPE**. Simply select **ALLOW THIS PROGRAM TO USE SKYPE** and press **OK**.
4. Start Skype if the VOIP 321 driver has not started Skype for you; login to your Skype account.
5. From Skype, click on **Tools**. Select **Options**. Select **Sound Devices** from the left.
6. For XP user, select **Philips VOIP321** from Audio IN, Audio OUT and Ringing pull down box. Press **SAVE**.  
For Windows 2000 user, select **USB Audio Device** from Audio IN, Audio OUT and Ringing pull down box. Press **SAVE**.
7. Now your phone is ready for use. The status icon should be shown on the handset to indicate your current status.

### About the VOIP321 Driver

Once VOIP 321 driver is installed and started on your PC, a tray icon will be shown when the VOIP321 driver is loaded.

Double click on the tray icon will return the **ABOUT** page of the VOIP 321 driver, where the current status will be shown. If there are problems with the connection, the problem will be displayed; otherwise **CONNECTED** will be shown.

Right click on the tray icon either to stop the VOIP 321 driver or to see the status of VOIP 321 driver.

## Adjusting the handset speaker volume on your PC

The earpiece volume setting on your PC affects the sound quality of your phone.

Please follow the steps below to adjust your earpiece volume.

On the PC, click on the Start button and select **Settings**. Select **Control Panel**.

**For Windows 2000 users,**

- Click on **Sound and Multimedia**.
- Under Sounds and **Multimedia Properties**, select the **Audio** tab.
- To adjust the earpiece volume, select USB audio Device from the **Preferred device** pulldown menu under **Sound Playback**; to adjust the microphone volume, select USB audio Device from the **Preferred device** under **Sound Recording**.
- Click the **Volume** button.
- Adjust the volume using the slider. Close the window when finished.
- When finished, click **CANCEL** to retain audio driver selection.

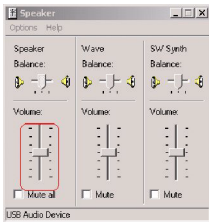

**For Windows XP users,**

- Click on **Sound and Audio Devices**.
- Select the **Audio** tab.
- To adjust the earpiece volume, select **Philips VOIP321** from the **Default device** pulldown menu under **Sound Playback**; to adjust the microphone volume, select USB audio Device from the **Default device** under **Sound Recording**.
- Click the **Volume** button.
- Adjust the volume using the slider. Close the window when finished.
- When finished, click **CANCEL** to retain audio driver selection.

**Note :** Before exiting sound and audio properties, please make sure that **Use only Preferred Devices** (for Windows 2000 user) or **Use only Default Devices** (for Windows XP user) checkbox is checked. Once this checkbox is checked, you will be able to separate the audio path of your PC, such that audio from Skype will come out from the handset and audio from other PC applications will come out from the preferred audio device.

# Connect

**Note :** Install the drivers and software first (see page 10) and connect the USB phone only once it is done.

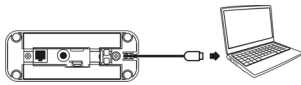

1. Connect the output plug of the base adapter to the adapter socket on the back of the base unit and the base adapter to the wall main supply. A click should be heard when the cord is properly connected to the base.

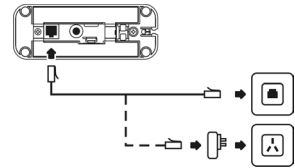

2. Connect the USB plug directly to your PC's USB slot.
3. Connect the telephone line cord to the phone socket on the back of the base unit and to the plug (optional and country dependent) then wall phone socket.

**Note :** You may find in the box the line adaptor delivered separately from the line cord. In this case, please, first plug this line adaptor onto the line cord before connecting it to the line socket.

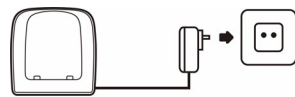

4. If you have bought a multi-pack product, each extra handset comes with a charger and adapter. Connect the adapter to the wall main supply.



5. Place the 2 rechargeable NiMH AAA batteries (included), observing their polarities, into the battery compartment on the handset.
6. Slide the battery door firmly into place.

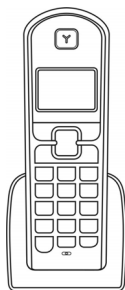



7. Place the handset on the charger and let the batteries continuously charge for 24 hours before using. The handset may get warm during the initial charge. This is normal.
8. Please note that handset may not turn ON for up to 15 minutes if the batteries are too low.
9. To set the language of your handset, press any key when you see **WELCOME**. Select your country and press **OK**.

**Note :** Before first use, put the product on the charger and charge batteries for 24 hours minimum.

# Main menu

EN

Your phone offers a variety of functions and features that are grouped in the menus.

To access the main menu, press  and press UP / DOWN  to browse the menu.

Press  to exit the menus.

## Main menu

### SKYPE

- Contacts
- User Status
- Voicemail
- Credits

### PHONEBOOK

#### Private

- View
- Add
- Edit
- Quick Dial
- To Shared
- Delete
- Delete All
- Status

#### Shared

- View
- Add
- Edit
- To Private
- Delete
- Delete All
- Status

### CLOCK / ALARM

- Set Clock
- Set Alarm
- Alarm Tone

### PERSONAL SET

- Handset Tone
- Handset Name
- Contrast
- Auto Answer
- Backlit
- Language

### ADVANCED SET

- Recall Time
- Dial Mode
- Pause
- PABX
- Baby Call
- Registration
- Base Select
- Delete HS
- Change PIN
- Reset

## Call records menu

### Missed

- To Private
- To Shared
- Delete
- Delete All

### Received

- To Private
- To Shared
- Delete
- Delete All

### Dialled

- To Private
- To Shared
- Delete
- Delete All

## General Information

Before any call is made, please note the following.

### Emergency Calls

Skype does not support emergency call; all emergency calls will be routed to the telephone line.





### Low battery warning

If your phone is almost out of battery during a call, it will sound an alert tone. Place your phone on the charger for charging as soon as possible or it would turn off when it is out of battery. Placing the phone on the charger for charging will end the current call.

### Call timer

The call timer shows the duration of your current call on display. It is shown in minutes and seconds (MM-SS) in the first hour. After that, it will be shown in hours and minutes (HH-MM).

## Make a Skype call

1. Press  to access Skype contact list.
2. Press UP / DOWN  to select the Skype user you would like to call.
3. Press  or  to call the selected contact. The selected contact's name will be displayed and called.

**Note :** The contact list shows the Skype contact list of the user who is currently logged in to Skype on the PC. The icon on the left of each entry shows the online status of that entry. See page 34 for user status display icon.

**TIP : Search by letter** - Using the keypad, enter the first letter of the name you wish to find.

E.g. If you want to find the contact name "Peter", press  once should return the first contact begins with the letter P.

E.g. If you want to find "Sam", press  four times, the first contact begins with the letter S will be selected.

**Note :** You can also change your online status on the handset. Refer to the menu - Skype section for instruction on how to change online status, see page 34.





**Note :** The full name of the contacts on the contact list will be shown. If you want to view the contact's

Skype ID, press  when the contact is selected. If a SkypeOut entry is selected, the number of the entry will be shown.

### Making a Skype call while the Telephone line is in used

If you have two handsets, you can make a Skype call while another handset is on a Telephone call. To make a Skype call while the telephone line is in used, follow the instruction in "Make a Skype call", page 14. If the Skype line is in used, **UNAVAILABLE** will be shown when you attempt to launch the contact list, or busy tone will be returned.

## Make a SkypeOut call



1. Press  to access Skype contact list.
2. Press UP / DOWN  to select the SkypeOut number to call.
3. Press  or  to call the selected contact. The selected number will be displayed and called.

OR

Enter the SkypeOut number and press  to make a SkypeOut call.

**Note :** In order to make SkypeOut calls, you need to purchase SkypeOut credits; please go to <http://www.skype.com/store/buy/skypeout.html> for further details.  
When making SkypeOut calls, it is necessary to dial the country prefix of the phone number you are calling, i.e. 00, 011 or + .  
For example, when making calls to North America: 00-1-905-5251258 or 011-1-905-3456622  
when making international calls: 00-852-25447555 or +852-90446577

To enter + : In idle mode, long press .

**Note :** Press  to delete an incorrect digit. Long press  or press  to return to idle mode.

## Answer a Skype call

When you receive a call,

If the incoming call is from the Skype line, the Skype melody will ring and  will flash in the display and the Skype ID will display on the phone.

Press  to answer the call.

**Note :** You will be able to receive second incoming call from the other line (i.e. receive a telephone call while on a Skype call). A special call waiting tone will be heard and the caller ID will be shown on the

display. To pick up the call on the other line, end the current call and press  again.

## End a Skype call



Press  or place the phone on the charger will end the call and return the phone to idle mode.

## Reject a Skype call

To reject an incoming Skype call, press  when the call is received on the handset. The incoming call information will be stored in the MISSED call list.

## 3- way Skype conference

You can start a 3-way Skype conference call.

1. Call the first party.
2. After the first party answered the call, put the first party on hold by pressing  and make a Skype call to the second party.
3. When the second party answered the call, press and hold  to join the two parties.





## Recall

While on a call, you can use the recall function to make a second outgoing call or receive a second incoming call.



**Note :** If you are using Skype, you will be able to make or receive second calls without extra charges. However if you are using the telephone line, you have to subscribe to the call waiting service from your local service provider to use this feature.

**Note :** You can only make second outgoing call via the line your current call is on. If you are currently on Skype call, you can make a second call to a contact on your Skype list or a SkypeOut call; if you are currently on telephone call, you can make a second call to another landline number.

To make a second outgoing call while on a Skype call,



1. While on the first call, press . A dial tone should be heard; the first call will be put on hold.
2. To call a Skype contact, press  to obtain the contact list; select the contact to call and press .
3. To make a SkypeOut call, enter the number to call.
4. To return to the first call or to toggle between calls, press .

To make a second outgoing call while on a telephone call (note: this is a network dependent feature),

1. While on the first call, press .
2. Enter the number to call.
3. To toggle between the two calls on the telephone line, press .





To receive a second incoming call (note: this is a network dependent feature),

1. When there is a second incoming call, a call-waiting alert will be heard; if the second incoming call is from the other line, a special call-waiting alert will be heard.
2. If the second incoming call is from the other line, press  to terminate the current call first.
3. Press  to pick up the second call.
4. Press  again to return to the first call, and to toggle between the two calls if both calls are on the same line.

## Chaining Dialling

You can dial out numbers from the phonebook even after you have seized the phone line. And there is no limit to the number of times chain dialling is accessed.

1. During off hook, press DOWN  for 2 seconds to access the phonebook.
2. Press UP / DOWN  to scroll through the phonebook records or you can use the number keys to jump directly to the record starting with the corresponding letters of that key.

**Note :** If you decide to quit using chain dialling, simply press DOWN  for 2 seconds again to exit.



3. Press **OK**.



## Skype voice mail access



Your phone allows you to access your Skype voicemail box with just a few presses.

**Note :** To get a voicemail account, please go to <http://www.skype.com/products/skypevoicemail/> for further details.

## Retrieving voicemail

When there are new voicemails waiting for you, the icon  will appear on the top line of the display during standby. The  icon will be gone when there is no more new message in your voicemail box.







1. Press .
2. Press UP / DOWN  to select **SKYPE** and press **OK**.
3. Press UP / DOWN  to select **VOICEMAIL** and press **OK**.

4. Press UP / DOWN  to select the voicemail to listen to and press .





**Note :** While you are browsing the voicemail list, an asterisk (\*) is used on the second line to indicate that the voicemail is new.

5. Press UP / DOWN  to select **PLAY** to play the message.

## Deleting a voicemail

1. Press .
2. Press UP / DOWN  to select **SKYPE** and press **OK**.
3. Press UP / DOWN  to select **VOICEMAIL** and press **OK**.
4. Press UP / DOWN  to select the voicemail to delete and press .
5. Press UP / DOWN  to select **DELETE** and press **OK** to confirm.

## Deleting all voicemails

1. Press .
2. Press UP / DOWN  to select **SKYPE** and press **OK**.
3. Press UP / DOWN  to select **VOICEMAIL** and press **OK**.
4. Press  to enter the voicemail menu.
5. Press UP / DOWN  to select **DELETE ALL** and press **OK**.
6. A confirmation prompt should be shown; press **OK** to confirm.

# Make a telephone call

## Call from telephone line

1. Press  to obtain the line; a dial tone should be heard.
2. Enter the number to dial.

## Pre-dial

1. Enter the number you want to call. The number will appear on the display. You can enter up to 20 digits.
2. Press  to dial the number.

**Note :** Long press  where you want to enter a pause.

### **Making a Telephone call while the Skype line is in used**

If you have two handsets, you can make a Telephone call while another handset is on a Skype call. To make a telephone call while the Skype line is in used, follow the steps in "Make a telephone call", page 19. If the telephone line is in used, busy tone will be returned.

## Answer a call

If the incoming call is from the landline, the landline melody will ring and  will flash in the display. The caller ID will display if you have subscribed caller ID service from your local telephone service provider.

Press  to to answer the call.

## End a call

Press  or place the phone on the charger will end the call and return the phone to standby.

## Quick dialling



You can assign frequently dialled number from the phonebook to keys on the handset. Once assigned, press and hold the key on the handset during standby will dial the stored number. The number will be dialled using your landline.

## Call in progress

### Set the earpiece volume during a call

You can increase or decrease the volume of a caller's voice during a call. There are 5 volume levels for selection.



To adjust the volume, during a call :

1. Press UP or DOWN . The display shows the current volume level.
2. Press UP or DOWN again  to adjust the volume.

**Note :** Besides adjusting the volume on the handset, you might also need to adjust the volume on your PC in order to set the speaker to the most comfortable volume. Please refer to "Adjusting the handset speaker volume on your PC", page 11 for information on how to adjust the volume on the PC.

### Microphone mute



During a call, if you wish to speak to someone privately without having the caller hear your conversation,

1. Press ; the caller cannot hear you, but you can hear the caller.
2. Press  again to communicate with your caller again.



### Handsfree call (Speaker)

Handsfree provides the convenience of talking to the caller without holding onto the phone. You can communicate by using the speaker/microphone of the phone. Handsfree also allows others in the room to be involved in the conversation if you are not using the headset.

If you want to use the phone's speaker, during a call,



1. Press .  
You can hear the caller over the loudspeaker and you can speak via the microphone.  will appear on the display.
2. Press  again to deactivate the handsfree mode.

### Setting the loudspeaker volume during a handsfree call

1. While the phone is off hook, press UP or DOWN . The display shows the current volume level.
2. Press UP or DOWN again  to adjust the volume.

## Viewing phonebook



To view your phonebook,

1. Press , select **PHONEBOOK** and press **OK**.
2. Select the phonebook to open, **PRIVATE** or **SHARED** and press **OK**.
3. Press UP / DOWN  to select **VIEW** and press **OK**.

## Add entry in phonebook

Each record can store a name up to 10 characters and a number up to 20 digits.

To add an entry to your phonebook,





1. Press , select **PHONEBOOK** and press **OK**.
2. Select the phonebook to open, **PRIVATE** or **SHARED** and press **OK**.
3. Press UP / DOWN  to select **ADD** and press **OK**.

**Note** : Please note that contacts on the Skype contact list cannot be stored to the phonebook (both shared and private).  
If your phonebook is full, **FULL** is displayed. You have to delete some records before entering new ones.

4. Enter the name for the record. A name must be entered and it must be unique. Press **OK** to continue.
5. Enter the number for the record. You must enter a number





**Note** : Long press  where you want to enter a pause.  
You cannot enter an identical name for two different records in your phonebook. If so, **DUPLICATE REPLACE?** is displayed. Press **OK** to replace the existing record with the new entry or press **BACK** to return to the previous display and make changes to the name.

## Edit phonebook entry



1. Press , select **PHONEBOOK** and press **OK**.
2. Press UP / DOWN  to select the phonebook you want to open, **PRIVATE** or **SHARED**; press **OK** to continue.
3. Press UP / DOWN  to select **EDIT** and press **OK**.
4. Press UP / DOWN  to scroll to the entries you wish to edit or search by letter, press **OK**.

5. Edit the name and number using the keypad. Press  to erase a character or digit.
6. Press **OK** to save your changes.

## Delete phonebook entry

1. Press , select **PHONEBOOK** and press **OK**.
2. Press UP / DOWN  to select the phonebook you want to open, **PRIVATE** or **SHARED**; press **OK** to continue.
3. Press UP / DOWN  to select **DELETE** and press **OK**.
4. Press UP / DOWN  to select the record to delete and press **OK**.
5. Press **OK** to confirm.

## Phonebook record search by letter





1. Press DOWN  to directly access the phonebook.
2. Press the key with the first letter of the record you want to find, i.e.  one time to find Peter.

## Quick dial to entries in your private phonebook





This feature allows you to dial to the entries in your private phonebook by pressing and holding a quick dial key that you have assigned. You can assign 9 quick dial keys (keys 1-9).

**Note** : Contacts on the contact list cannot be assigned to quick dial keys.





### Assign a quick dial key

1. Press , select **PHONEBOOK** and press **OK**.
2. Press UP / DOWN  to select the **PRIVATE** phonebook and press **OK**.
3. Press UP / DOWN  to select **QUICK DIAL** and press **OK**.
4. Press UP / DOWN  to select the key to assign a number to; press **OK**.
5. Press UP / DOWN  to select the record to assign to the key selected in the previous step; press **OK** to save.

## Change a quick dial key



1. Press , select **PHONEBOOK** and press **OK**.
2. Press UP / DOWN  to select the **PRIVATE** phonebook and press **OK**.
3. Press UP / DOWN  to select **QUICK DIAL** and press **OK**.  
The first quick dial key is displayed.
4. Press **OK**. Press UP / DOWN  to select **EDIT**. Press **OK**.
5. Press UP / DOWN  to select a new entry for the selected key. Press **OK** when the entry is selected.

## Delete a quick dial key

1. Press , select **PHONEBOOK** and press **OK**.
2. Press UP / DOWN  to select the **PRIVATE** phonebook and press **OK**.
3. Press UP / DOWN  to select **QUICK DIAL** and press **OK**.  
The first quick dial key is displayed.
4. Press UP / DOWN  to scroll to the quick dial key you wish to delete and press **OK**.
5. Press UP / DOWN  to select **DELETE** and press **OK**.
6. **CONFIRM?** is displayed. Press **OK** to confirm.

## View available phonebook space

Your phone keeps track of how much memory you have used and how much is still available in your phonebook.





1. Press , select **PHONEBOOK** and press **OK**.
2. Press UP / DOWN  to select the phonebook you want to open, **PRIVATE** or **SHARED** and press **OK**.
3. Press UP / DOWN  to select **STATUS**. Press **OK** when finished.

Your phone keeps a record each time you make, receive or miss a call. You can access a list of the last 15 calls that you have missed, the last 5 calls you have received, and the last 10 dialled numbers you have dialled. Each record stores a name up to 12 characters and a 20 digits number and up to 32 alphanumeric characters for contact.





For missed and received calls, the call records will automatically be stored only if you have subscribed to caller ID service from your local Telephone line service provider, otherwise only Skype calls will be stored.

If you have more than one handset, each handset has its own call list.

## View caller ID

1. Press UP  to directly access the call log. Press UP / DOWN  to select **MISSED** or **RECEIVED** call list and press **OK**.
2. Browse  in the call records.
3. Press  to view the number.

## To call / redial

1. Press UP  to directly reach the call log in idle mode. Press UP / DOWN  to select **MISSED** or **RECEIVED** call list and press **OK**.
2. Browse  in the call records to select an entry.
3. Press .

**Note :** To be able to call back a correspondent in the case of an incoming call, you need to subscribe to the Caller Line Identification service.

## Copy call log entry in the phonebook

To save the phone number of your family, friends, and colleagues, you can save the call records to your phonebook if you do not already have their contact information.

While you are viewing the call record that you would like to save,



1. Press .
2. To save the call log record to your private phonebook, select **TO PRIVATE** and press **OK**.  
**OR**  
to save it to your shared phonebook, select **TO SHARED** and press **OK**.
3. Enter a name for this entry and press **OK**.
4. Edit the number if necessary and press **OK**.  
The record will be saved in the selected phonebook.



**Note :** The call record saved into the phonebook is still in your call list but it will show the new name entered.  
Skype contacts, Skypeln or SkypeOut numbers cannot be saved to the phonebook.



## Delete a call log entry

You can delete each individual call record one at a time. To delete a record :

1. While viewing the call record, press .
2. Press UP / DOWN  to select **DELETE** and press **OK**.
3. **CONFIRM?** is displayed. Press **OK** to confirm.

## Delete all the call log entries



You can delete all the call records at once. To delete all call records list :

1. While viewing the call record, press .
2. Press UP / DOWN  to select **DELETE ALL** and press **OK**.
3. **CONFIRM?** is displayed. Press **OK** to confirm.



# Redial list

Your phone stores the last 10 numbers/contacts you have dialled, up to 32 alphanumeric characters each. If you have more than one handset, each handset has its own redial list.

## View the redial list

1. Press , the last number/contact dialled is displayed.
2. Browse  through the last 10 dialled numbers.

## Call / redial

1. Press  to directly reach the redial list in idle mode.
2. Browse  through the redial list to select the wanted number.



### Matching your phonebook record

If a dialled number matches a phone number stored in the phonebook, that phonebook name will be displayed instead of the dialled number.

3. Press .

## Record a number from redial into phonebook

While you are viewing a dial record that you would like to save :

1. Press  to directly reach the redial list in idle mode.
2. Browse  through the redial list to select the wanted record.
3. Press .
4. To save the record to the private phonebook, select **TO PRIVATE** and press **OK**  
**OR**  
to save the record to the shared phonebook, select **TO SHARED** and press **OK**.

### Matching your phonebook record

If a dialled number matches a phone number stored in the phonebook, that phonebook name will be displayed instead of the dialled number.

5. Enter a name for this record and press **OK**.
6. Edit the number if necessary and press **OK**.

**Note :** The redial record saved into the phonebook is still in your redial list but it will show the new name entered.  
Skype contacts, Skypeln or SkypeOut numbers cannot be saved to the phonebook.

## Delete last numbers dialled

While you are viewing a dial record that you would like to delete,

1. Press .
2. Select **DELETE** and press **OK**.
3. Press **OK** to confirm.

## Delete whole redial list

Instead of deleting the records one by one, you have this option to delete the entire dial list.



While you are viewing any dial record,

1. Press .
2. Select **DELETE ALL** and press **OK**.
3. Press **OK** to confirm.

## Lock keypad

Keypad can be locked to prevent accidental key press.

When the keypad is locked, you can still answer an incoming call by pressing . During the call, the keypad is active. When the call is ended, the keypad will be locked again.

1. In idle mode, long press . When locked, **LOCKED** appears on the display.
2. Long press  again to unlock the keypad.



## Paging

You can locate the handsets by using this feature.

Press  on the base.

All handsets registered to the base will produce the paging tone for 30 seconds and the screen displays **PAGING**.

### To stop paging :

Press  on one of the handsets or press  on the base again.

**Note :** If an external call comes in, all the handsets will stop paging, and play the external call melody. A handset will not play the paging melody if it is powered off or not in idle mode. However, all the other handsets will still ring.

## CallerID first ring suppression

If you have subscribed for CallerID service, your phone will suppress the first ring before the CID. After resetting, first ring suppression will be deactivated. After the first call, your phone will automatically detect if CID service is subscribed. If CID service is detected, your phone will start suppressing the first ring after the first call.

**Note :** Once first ring suppression is activated, the first ring before CID will be suppressed even after you have unsubscribed the CID service. If you have unsubscribed the CID service and do not wish to have the first ring suppressed, please power recycle the base.

## Switch on/off the handset

To switch off the your phone, long press  while in idle mode.

To switch on the power of your phone, press  or return the handset to the charger.  
The handset should be automatically turned on.

## Personalizing your sounds



You can assign different ringing melodies for each handset at different volume levels.

You can select a different ringtone for Skype, Telephone and intercom calls.

### Selecting your handset's ringing melody

1. In idle mode, press .
2. Select **PERSONAL SET** and press **OK**.
3. Select **HANDSET TONE** and press **OK**.
4. Select the line to select ringtone for and press **OK**.
5. Select the desired ringtone and press **OK** to confirm.

### Selecting your handset's ringing volume

1. In idle mode, press .
2. Select **PERSONAL SET** and press **OK**.
3. Select **HANDSET TONE** and press **OK**.
4. Select **VOLUME** and press **OK**.
5. Press UP / DOWN  to select the volume level and press **OK** to confirm.

### Shortcut for turning handset ringer on/off

In idle mode, long press  to turn on/off the handset ringer.

 appears to indicate the ringer is turned off. The handset will not emit any sound for any incoming call.

### Set key tones on/off

1. In idle mode, press .
2. Select **PERSONAL SET** and press **OK**.
3. Select **HANDSET TONE** and press **OK**.
4. Select **KEYBEEP** and press **OK**. The current setting is displayed.
5. Select **ON** or **OFF** and press **OK** to confirm.

## Rename handset

You can give your phone a different name. If you have more than one handset, you can give each handset its own name.



The handset name can be up to 10 characters long and it can be composed of A-Z, 0-9, and space.

1. In idle mode, press .
2. Select **PERSONAL SET** and press **OK**.
3. Select **HANDSET NAME** and press **OK**. The current handset name is displayed.
4. Edit the handset name and press **OK** to confirm.

## Set time

Once the base is powered up and connected to the PC and the USB driver is running, your handset will obtain the current time from the PC.

However, you can still adjust the clock manually. To adjust your clock :

1. In idle mode, press .
2. Press UP / DOWN  to select **CLOCK/ALARM** and press **OK**.
3. Press UP / DOWN  to select **SET CLOCK** and press **OK**.
4. Use numeric keys to enter the time for the clock in 24 hours format and press **OK**.

## Setting the alarm clock

You can set the alarm time and personalize the alarm tone.

### Setting the alarm time

1. In idle mode, press .
2. Select **CLOCK/ALARM** and press **OK**.
3. Select **SET ALARM** and press **OK**. The current setting is displayed.
4. Select **ON** or **OFF** and press **OK**. If you selected **ON**, continue to step 5.
5. Enter the alarm time using the digit keys and press **OK**.

The alarm tone rings for at most 1 minute. Press  to turn off the alarm clock.

## Selecting the alarm clock's ringing melody

1. In idle mode, press .
2. Select **CLOCK/ALARM** and press **OK**.
3. Select **ALARM TONE** and press **OK**.
4. Select **MELODY** and press **OK**. The current setting is displayed.
5. Select the desired melody and press **OK** to confirm.

## Setting the alarm volume

1. In idle mode, press .
2. Select **CLOCK/ALARM** and press **OK**.
3. Select **ALARM TONE** and press **OK**.
4. Select **VOLUME** and press **OK**. The current setting is displayed.
5. Select the desired volume level and press **OK** to confirm.

## Auto-answer on/off

Auto answer gives you the convenience of answering a call by just picking up the phone from the cradle or charger. You don't need to press .

1. In idle mode, press .
2. Select **PERSONAL SET** and press **OK**.
3. Select **AUTO ANSWER** and press **OK**. The current setting is displayed.
4. Select **ON** or **OFF** and press **OK** to confirm.

## Language setting

Your phone comes with several languages. When you change your phone's language, the menus will be displayed in the chosen language.

1. In idle mode, press .
2. Select **PERSONAL SET** and press **OK**.
3. Select **LANGUAGE** and press **OK**. The current language is displayed.
4. Select the desired language and press **OK** to confirm.

## Set dialling mode (Tone/Pulse)



Dialling mode applies only when you are making a telephone call. Your phone is by default set to tone dialling. You can switch to pulse dialling if necessary.

1. In idle mode, press .
2. Select **ADVANCED SET** and press **OK**.
3. Select **DIAL MODE** and press **OK**. The current setting is displayed.
4. Select **TONE** or **PULSE** and press **OK** to confirm.

### Temporary tone dialling in pulse dial mode

If the dialling mode is set to pulse, you can long press  to set temporary tone dialling. **d** will be displayed on the screen. All the following digits will be dialed as tones until you hang up.

## Set display contrast

1. In idle mode, press .
2. Select **PERSONAL SET** and press **OK**.
3. Select **CONTRAST** and press **OK**. The current setting is displayed.
4. Press **UP / DOWN**  to adjust the contrast and press **OK** to confirm.

## Turning the backlit on/off

The LCD and keypad will be lit when the phone is being used.

1. In idle mode, press .
2. Select **PERSONAL SET** and press **OK**.
3. Select **BACKLIT** and press **OK**. The current backlit is displayed.
4. Select **ON** or **OFF** and press **OK** to confirm.

## Pin code setting

A PIN (personal identification number) code is required to access the registration, delete handset, and reset mode.

The factory-preset code is "0000". You can change it to a unique code of your own. A PIN code can be up to 8 digits long.

1. In idle mode, press .
2. Select **ADVANCED SET** and press **OK**.
3. Select **CHANGE PIN** and press **OK**.
4. Enter the current PIN and press **OK**.
5. Enter the new PIN and press **OK**.
6. Repeat the new PIN and press **OK** to confirm.

**Note :** You will hear a reject tone if the new PIN is not repeated correctly. Follow steps 3 to 7 and try again.

## Restore handset default settings

You can reset the display, sounds, and other settings of your phone. Refer to the chapter "Default settings", page 37.

1. In idle mode, press .
2. Select **ADVANCED SET** and press **OK**.
3. Select **RESET** and press **OK**.
4. Enter the PIN and press **OK** to confirm.

## Set Baby call on/off

Baby call allows you to dial out a programmed number via the telephone line by pressing any key on the handset (except the OFF key).

1. In idle mode, press .
2. Select **ADVANCED SET** and press **OK**.
3. Select **BABY CALL** and press **OK**. The current setting is displayed.
4. Select **ON** and press **OK**.
5. Enter or edit the number and press **OK** to confirm.  
**BABY CALL** is displayed when you return to standby mode.

### To turn off baby call,



1. Press .
2. Select **OFF** and press **OK**.



## Registering

### Register a new handset to base station

Each base can register up to 4 handsets.

1. In idle mode, press .
2. Select **ADVANCED SET** and press **OK**.
3. Select **REGISTRATION** and press **OK**.
4. Before you enter the PIN, long press  on the base for 4 seconds.

**Note** : If the base is full, the base would not go into registration mode. See the section "Unregister a handset", page 33 to unregister a currently registered handset.

**Note** : The range of this handset is 250 m outdoor and 50 m indoor. An out of range warning will be emitted and the range icon will be flashing on the display if you move too far away from the base unit during a call. You will need to move closer to the base unit or your call will be disconnected.

### Unregister a handset

A handset can un-register another handset registered to the same base. It can also un-register itself.

1. In idle mode, press .
2. Select **ADVANCED SET** and press **OK**.
3. Select **DELETE HS** and press **OK**.
4. Select the handset you would like to un-register and press **OK**.
5. Enter the PIN (by default PIN is "0000") and press **OK** to confirm.

### Select the base station

If your handset is registered to more than 1 base, you can select which base the handset will use.





1. In idle mode, press .
2. Select **ADVANCED SET** and press **OK**.
3. Select **BASE SELECT** and press **OK**.
4. Select the base to use and press **OK**.

**Note** : Bases your handset is registered to which is not Philips VOIP 321 base will be labelled as GAP BASE; your Philips VOIP 321 base will be labelled as BASE in Base Select.

## User status

### User status display

Skype status icons are used on the handset to represent different online status as well as each contact's online status on the Skype contact list. Please refer to the following table for the description of each status.

	Online / SKYPE ME
	Offline
	Away
	Not Available
	Not Disturb
	Invisible
	SkypeOut entry

### User status settings



You can change your current Skype status on the handset. To change your online status :

1. In idle mode, press .
2. Select **SKYPE** and press **OK**.
3. Select **USER STATUS** and press **OK**.
4. Select the status to change into and press **OK** to save the status.

## Check your Skype credits

You can also check your SkypeOut account credits before you make a SkypeOut call.

To check your SkypeOut credits,

1. In idle mode, press .
2. Press UP / DOWN  to select **SKYPE** and press **OK**.
3. Press UP / DOWN  to select **CREDITS** and press **OK** when finish.

**Note :** You need at least 2 handsets to carry out the functions mentioned in this chapter.

## Make an internal call

You can call someone in the house by using the intercom function on your phone.

To make an intercom call :

1. Press .
2. Select the handset you want to call and press **OK**  
**OR**  
enter the number of the handset that you want to call.

**Note :** You will hear a busy tone if the other handset is not available.

## Make an internal call during an external call

While you are on an outside call, you can put the outside call on hold and make a call (inquiry call) to someone in the house.



To make an inquiry call, during an outside call :

1. Press .
2. Select the handset you want to call and press **OK**  
**OR**  
enter the number of the handset that you want to call.
3. Wait for the other handset to answer your call.

**Note :** If the other handset does not answer, press  again to cancel the attempt and return to the external call.

## Transfer an external call to another handset



During an external call,

1. Press .
2. Select the handset you want to call and press **OK**  
**OR**  
enter the number of the handset that you want to call.
3. When the other handset has answered your call, press  or place the handset on cradle. The external call is transferred.

## Make a conference call

You can invite another handset to join a call with the external line.

During an outside call,

1. Press .
2. Select the handset you want to call and press **OK**  
**OR**  
enter the number of the handset that you want to call.
3. When the other handset has answered your call, long press .  
You are then in a conference call.

**Note :** Any handset hangs up during a conference call will leave the other handset still connecting with the external call.

## Answer a call from the telephone line while on Skype call (Multi-handset)

The other handsets will ring the telephone melody.

Press  on the other handset to pick up the call.

## Answer a Skype call while on a call on the telephone line (multi-handset case)

The other handsets will ring the Skype melody.

Press  on the other handset to pick up the call.

# Default settings

EN

Handset name :	PHILIPS
Time :	00:00
Ringer melody (fixed lines) :	Party
Ringer melody (Skype) :	Dring
Ringer melody (Internal call) :	Party
Ringer volume :	Level 3
Alarm :	Off
Alarm ringer melody :	Party
Alarm ringer volume :	Level 3
Key tone :	ON
Backlit :	ON
Recall duration :	100 ms
Dial mode :	Tone
Contrast :	Level 2
Auto answer :	OFF
Menu language :	English
Pause duration :	Pause 1
Baby call :	Off
Baby call number :	Empty
Base select :	Auto
CID first ring suppression :	OFF
Message waiting indicator :	OFF
System PIN :	0000
Keypad lock :	OFF
Earpiece volume :	Medium

## Problems

No dial tone when pressing



Signal icon  is flashing.

The phone does not ring.

When the handset is placed on the charger, no beep is heard.

The call waiting call cannot be answered.

Battery icon remains empty although the handset has charged for 24 hours.

No symbol on the display.

Bad audio quality (crackles, echo, etc.).

Cannot hear the other party clearly/ speaker too loud/quiet.

Contact list/ User status returns UNAVAILABLE.

Cannot make SkypeOut calls.

Busy tone is returned while making Skype call.

## Solutions

- Make sure that the adapter and the phone cord is connected properly.
- Check that the batteries are fully charged and installed properly.
- This phone does not work during power failure.
- Register your handset to a base.
- Move closer to the base unit.
- Make sure the adapter and the phone cord are connected properly.
- Move the handset closer to the base unit.
- Turn on the ringer.
- Take the handset off the charger and put it back again.
- Clean charging contacts with a clean and dry cloth.
- Turn on the handset tone from the PERSONAL SET Menu.
- There will be no beep if the handset's power is turned off previously.
- Check with your local phone company and select the correct recall duration.
- End the current call, and press TALK again to pick up the second call.
- Please contact your dealer to purchase new rechargeable battery.
- Check to make sure the battery icon is scrolling while being charged.
- Charge battery.
- Make sure the batteries are in the compartment and your handset is ON.
- Install the base unit in a different room or higher location or away from other electronic appliances.
- Move closer to the base unit.
- Refer to "Adjusting the handset speaker volume on your PC", page 11.
- Check if your base is connected to the PC.
- Check if Skype is running on the PC. Start Skype if the VOIP 321 driver has not started Skype for you.
- Check if the VOIP 321 driver is running on the PC.
- Move the handset closer to the base if it is out of range.
- Enter 00, + (press and hold 0) or 011 before the number to dial.
- Check your account to see if you have enough credit.
- Check to see if a link is established between then handset and the base.
- Refer to "Make a SkypeOut call", page 15 for more detail.
- Make sure both Skype and the PC application is/are started on the PC and running properly.
- Make sure the phone is setup correctly.
- Wait for the remote party to be online.

If the above solutions do not help, remove the power from the handset and the base and restart Skype as well as the PC software. Wait for 15 minutes and try again.

## Safety information

This equipment is not designed to make emergency calls when the power fails. An alternative has to be made available to allow emergency calls.

## Warranty

The warranty informations are available on [www.p4c.philips.com](http://www.p4c.philips.com).

## Conformity

The Declaration of conformity is available on [www.p4c.philips.com](http://www.p4c.philips.com).

## Safety precautions

Do not allow the handset to come into contact with water. Do not open the handset or the base station. You could be exposed to high voltages. Do not allow the charging contacts or the batteries to come into contact with conductive materials. Never use any battery type other than the one supplied : risk of explosion.

**WARNING !** Never use non-rechargeable batteries; use only the recommended type supplied with this telephone. IF RECHARGEABLE BATTERIES ARE NOT USED, A WARNING MESSAGE WILL BE DISPLAYED.

## Replace handset batteries

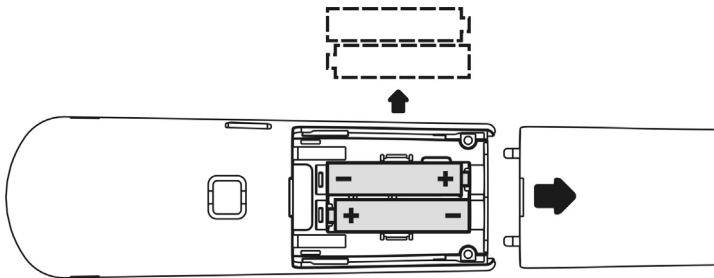

## Electric, Magnetic and Electromagnetic Fields ("EMF")

1. Philips Royal Electronics manufactures and sells many consumers oriented products, which usually, as with any electronic apparatus, have the ability to emit and receive electro magnetic signals.
2. One of Philips' leading Business Principles is to take all necessary health and safety precautions for our products, to comply with all applicable legal requirements and to stay well within the EMF standards applicable at the time of producing the products.
3. Philips is committed to develop, produce and market products that cause no adverse health effects.
4. Philips confirms that if its products are handled properly for their intended use, they are safe to use according to scientific evidence available today.
5. Philips plays an active role in the development of international EMF and safety standards, enabling Philips to anticipate further developments in standardization for early integration in its products.

## Environmental care

Please remember to observe the local regulations regarding the disposal of your packaging materials, exhausted batteries and old phone and, where possible, promote their recycling.

## Recycling & disposal

Disposal instructions for old products :

The purpose of the WEEE directive (Waste Electrical and Electronic Equipment; 2002/96/EC) is to ensure that products are recycled using best available treatment, recovery and recycling techniques to ensure human health and high environmental protection.

Your product is designed and manufactured with high quality materials and components, which can be recycled and reused.



Do not dispose of your old product in your general household waste bin.

Inform yourself about the local separate collection system for electrical and electronic products marked by this symbol .

Use one of the following disposal options :

1. Dispose of the complete product (including its cables, plugs and accessories) in the designated WEEE collection facilities.
2. If you purchase a replacement product, hand your complete old product back to the retailer. He should accept it as required by the WEEE directive.

**Philips has marked the packaging with standard symbols designed to promote the recycling and appropriate disposal of your eventual waste.**



A financial contribution has been paid to the associated national recovery & recycling system.



The labelled packaging material is recyclable.



**Numerics**

3- way Skype conference 16

**A**

Add entry in phonebook 21

Alarm clock,set 29

Alarm melody 30

Alarm volume 30

Answer a call 19

Answer a call from the telephone line while on

Skype call 36

Answer a Skype call 15

Answer a Skype call while on a call on the

telephone line 36

Assign a quick dial key 22

Auto-answer on/off 30

**B**

Baby call on/off 32

Backlit on/off 31

Base station 8

Base station, select 33

Batteries, insert 12

Battery 4

**C**

Call 20

Call / redial from call log 24

Call / redial from redial list 25

Call from telephone line 19

Call in progress 20

Call log 24

Call timer 14

CallerID first ring suppression 27

Chaining Dialling 17

Change a quick dial key 23

Conference call 36

Conformity 39

Connect 12

Contents 3

Contrast 31

Copy call list entry in the phonebook 24

**D**

Default settings 37

Delete a call log entry 25

Delete a quick dial key 23

Delete last numbers dialled 26

Delete phonebook entry 22

Delete whole redial list 26

Deleting a voicemail 18

Dialling mode 31

Display contrast 31

Driver 10

**E**

Earpiece volume,set 20

Edit phonebook entry 21

Electric, Magnetic and Electromagnetic Fields ("EMF") 39

End a call 19

End a Skype call 15

Environmental care 40

**H**

Handset 7

Handsfree call 20

Help 5

**I**

Icons on the handset display 9

Install 10

Install requirements 5

Install the software 10

Installation CD 10

Instructions for use for the VOIP 321 4

Intercom 35

Internal call 35

Internal call during an external call 35

**K**

Key tones on/off 28

Keys handset 7

**L**

Language setting 30

LED on base station 8

Lock keypad 27

Loudspeaker volume, adjust 20

Low battery warning 14

**M**

Main menu 13

Mute 20

**P**

Paging 27

Paging key 8

Phonebook 21

Pin code 32

Power requirements 4

Pre-dial 19

**Q**

Quick dial 22

Quick dialling 19

**R**

Range 33

Recall 16

Receive a second incoming call 17

Record a number from redial into phonebook 26

Recycling & disposal 40

- Redial list 25
- Registering 33
- Reject a Skype call 16
- Rename handset 29
- Replace handset batteries 39
- Restore handset default settings 32
- Retrieving voicemail 17
- Ringing melody 28
- Ringing volume 28
- S**
- Safety 4, 39
- Search by letter 14
- Search by letter in phonebook 22
- Second outgoing call 16
- Shortcut for turning handset ringer on/off 28
- Skype call 14
- Skype contacts list 8
- Skype credits, check 34
- Skype status icons 34
- Skype voice mail access 17
- SkypeOut call 15
- Sounds 28
- Speaker 20
- Speaker volume, adjust on PC 11
- Status, phonebook 23
- Switch on/off the handset 27
- T**
- Telephone call 19
- Time, set 29
- Transfer an external call to another handset 35
- Troubleshooting 38
- U**
- Unregister 33
- User status 34
- User status settings 34
- V**
- View available phonebook space 23
- View caller ID 24
- View the redial list 25
- Viewing phonebook 21
- W**
- What else you need 6
- What's in the box 6





Specifications are subject to change without notice.  
Trademarks are the property of Koninklijke Philips Electronics N.V. or their respective owners.  
2006 © Koninklijke Philips Electronics N.V. All rights reserved.

[www.philips.com](http://www.philips.com)

3111 285 29702



## Free Manuals Download Website

<http://myh66.com>

<http://usermanuals.us>

<http://www.somanuals.com>

<http://www.4manuals.cc>

<http://www.manual-lib.com>

<http://www.404manual.com>

<http://www.luxmanual.com>

<http://aubethermostatmanual.com>

Golf course search by state

<http://golfingnear.com>

Email search by domain

<http://emailbydomain.com>

Auto manuals search

<http://auto.somanuals.com>

TV manuals search

<http://tv.somanuals.com>