

Portable CD Player

AZT9240





Let's make things better.

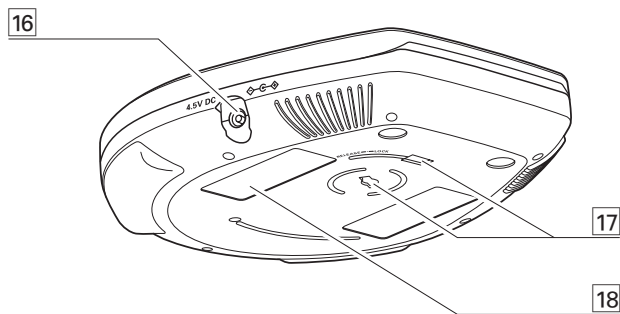
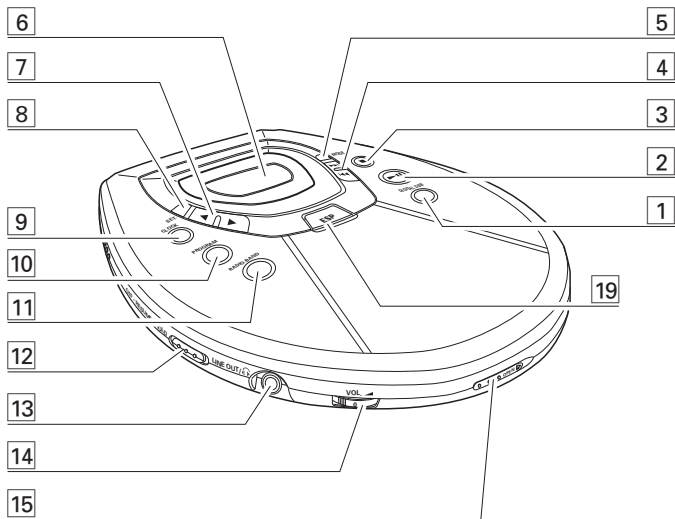

PHILIPS
The Best of What's Possible



CONTROLS, refer to the illustration on page 3

- 1 DIGITAL DBB ...DIGITAL **D**YNAMIC **B**ASS **B**OOST switches the bass enhancement on and off
- 2 **▶||**.....switches the player on, starts or pauses CD play
- 3 **■**.....stops CD play, clears a CD program or switches the player off
- 4 **▶▶**.....skips and searches CD tracks forwards, selects the next preset radio station
◀◀.....skips and searches CD tracks backwards, selects the previous preset radio station
- 5 **·MODE**.....selects the different playing possibilities: **SHUFFLE**, **SHUFFLE REPEAT ALL**, **REPEAT**, **REPEAT ALL** and **SCAN**
- 6display
- 7 **▲**.....tunes to radio stations upwards, sets the time upwards
▼.....tunes to radio stations downwards, sets the time downwards
- 8 **SET**activates/confirms the current time setting, activates/confirms the alarm time setting
- 9 **CLOCK**switches to clock or alarm clock display
- 10 **PROGRAM**.....programs CD tracks and radio stations, reviews the program
- 11 **RADIO-BAND** ...switches the radio on, selects a waveband
- 12 **RESUME**.....stores the last position of a CD track played
HOLD**locks all buttons**
OFFswitches RESUME and HOLD off
- 13 **LINE OUT**/.....3.5 mm headphone socket, socket to connect the player to another analogue audio input of an additional appliance, remote control socket
- 14 **VOL** .....adjusts the volume
- 15 **OPEN** **▶**.....opens the CD lid
- 16 **4.5V DC**socket for external power supply
- 17belt clip holder
- 18typeplate
- 19 **ESP****ELECTRONIC SKIP PROTECTION** ensures continuous CD playback regardless of vibrations and shocks, switches the alarm function on and off

QUICK START

English

1 OPEN

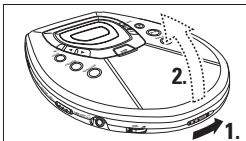

2

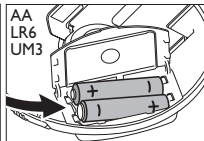
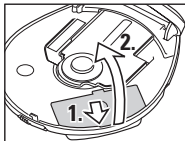

3 CD

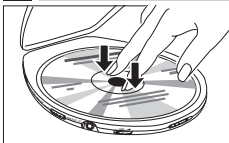

4

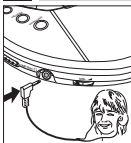

5 HOLD → OFF

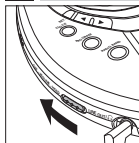

6 PLAY

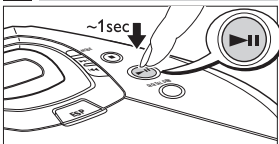

7 VOLUME

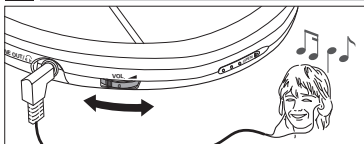

8 RADIO / BAND

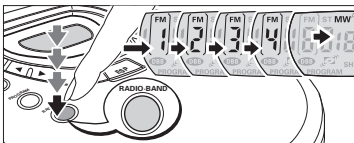

9 TUNING

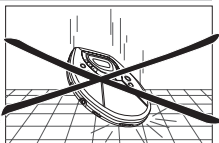
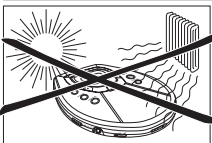
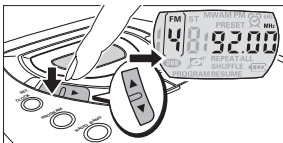

POWER SUPPLY

Batteries (supplied or optionally available)

With this player you can use either:

- normal batteries type **LR6, UM3** or **AA** (preferably Philips), or
- alkaline batteries type **LR6, UM3** or **AA** (preferably Philips).

Notes: – Old and new or different types of batteries should not be used in combination.

– Remove batteries if they are empty or if the player is not going to be used for a long time.



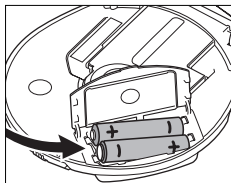

Inserting batteries

- 1 Push OPEN ► to open the CD lid.
- 2 Open the battery compartment and insert either 2 normal or alkaline batteries.



Battery indication

The approximate power level of your batteries is shown in the display.

-  Battery full
-  Battery two-thirds full
-  Battery one-third full
-  Battery dead or empty. When the batteries are dead or empty, the symbol  flashes, **bAtt** is displayed, and the beep tone sounds repeatedly.



Average playing time of batteries under normal conditions



Battery type	ESP on	ESP off
Normal	7 hours	6 hours
Alkaline	22 hours	19 hours
ECO-PLUS NiMH batteries (not on all versions)	10 hours	9 hours

Batteries contain chemical substances, so they should be disposed of properly.

ECO-PLUS NiMH battery information (for versions supplied with rechargeable ECO-PLUS NiMH batteries AY 3362 only)

Recharging works only on players with supplied rechargeable ECO-PLUS NiMH batteries AY 3362.

Recharging the ECO-PLUS NiMH batteries on board

- 1 Make sure you insert the rechargeable ECO-PLUS NiMH batteries AY 3362.
- 2 Connect the mains adapter to the 4.5V DC socket of the player and then to the wall socket.
 -  is shown and *CHARGE* is displayed for 5 seconds.
- Recharging stops after a maximum of 7 hours, or when you start playback.
- 3 When the batteries are fully recharged,  and *FULL* appear briefly in the display, before the display switches off.

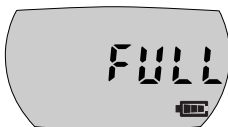
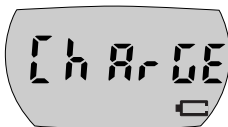

Notes: – It is normal for the batteries to become warm during recharging.

– If the batteries become too warm, recharging will be interrupted for approximately 30 minutes and *Hot* is displayed.

– To ensure proper recharging on board, take care that contacts are clean, and you are using only the ECO-PLUS NiMH batteries AY 3362.

Rechargeable ECO-PLUS NiMH battery handling

- Recharging already charged or half-charged batteries will shorten their lifetime. Therefore, after using the rechargeable ECO-PLUS NiMH batteries a few times, discharge them completely before recharging.
- To avoid a short circuit, the batteries should not touch any metal objects.
- When the batteries quickly become empty after recharging, the contacts are dirty or the end of their lifetime has been reached.

POWER SUPPLY/HEADPHONES

Mains adapter (supplied or optionally available)

Use only the AYT 3170 adapter (4.5 V/300 mA direct current, positive pole to the centre pin). Any other product may damage the player.

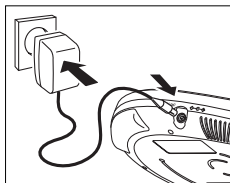

- 1 Make sure that the local voltage corresponds to the mains adapter's voltage.
- 2 Connect the mains adapter to the 4.5V DC socket of the player and to the wall socket.

Note: Always disconnect the adapter when you are not using it.

Belt Clip (not on all versions)

- 1 To attach the belt clip to the CD-player, position the shaped grip (found on the back of the belt clip) so that it fits into the belt clip hole of the CD-player.
- 2 Turn the clip to LOCK as indicated on the set.
- 3 To detach, gently lift the belt clip and turn to RELEASE as indicated on the set.

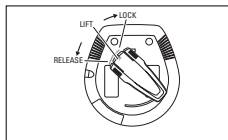
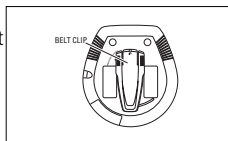

Environmental information

- All redundant packing material has been omitted. We have done our utmost to make the packaging easily separable into two mono materials: cardboard (box) and polyethylene (bags, protective foam sheet).
- Your set consists of materials which can be recycled if disassembled by a specialized company. Please observe the local regulations regarding the disposal of packing materials, exhausted batteries and old equipment.

GENERAL INFORMATION

CD player and CD handling

- Do not touch the lens (A) of the CD player.
- Do not expose the set, batteries or CDs to humidity, rain, sand or excessive heat (caused by heating equipment or direct sunlight).
- You can clean the CD player with a soft, slightly dampened, lint-free cloth. Do not use any cleaning agents as they may have a corrosive effect.
- To clean the CD, wipe it in a straight line from the centre towards the edge using a soft, lint-free cloth. A cleaning agent may damage the disc! Never write on a CD or attach a sticker to it.
- The lens may cloud over when the set is moved suddenly from cold to warm surroundings. Playing a CD is not possible then. Leave the CD player in a warm environment until the moisture has evaporated.
- Active mobile phones in the vicinity of the CD player may cause malfunctions.
- Avoid dropping the set as this may cause damage.

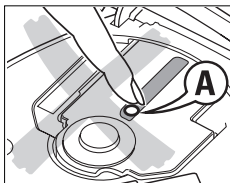

Headphones HE 545 (or HL 350)

- Connect the supplied headphones to the LINE OUT/🔊 socket.

Note: LINE OUT/🔊 can also be used for connecting the player to your HiFi system (with a signal lead) or to your car radio (with a cassette adapter or signal lead). In both cases, the volume of the player must be set to position 8.

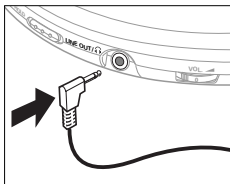

Use your head when using headphones

Hearing safety: Do not play your headphones at a high volume. Hearing experts advise that continuous use at high volume can permanently damage your hearing.

Traffic safety: Do not use headphones while driving a vehicle. It may create a hazard and it is illegal in many countries. Even if your headphones are an open-air type designed to let you hear outside sounds, do not turn up the volume so high that you cannot hear what is going on around you.

CD PLAY

Playing a CD

This CD player can play all kinds of **Audio Discs** such as CD-Recordables and CD-Rewritables. Do not try to play a CD-ROM, CDi, VCD, DVD or computer CD.

- 1 Push the OPEN ► slider.
→ The lid opens.
- 2 Insert an audio CD, printed side up, by pressing gently on the CD centre so that it fits onto the hub. Close the lid by pressing it down.
- 3 Press ►|| to switch the player on and start playback.
→ The current track number and elapsed playing time are displayed.

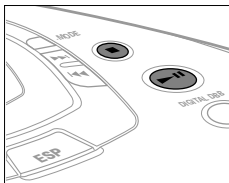
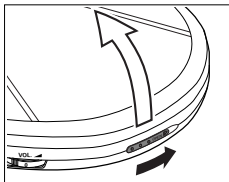

- You can pause playback by pressing ►||.
→ The time where playback was paused is flashing.
 - Continue playback by pressing ►|| again.
- 4 Press ■ to stop playback.
→ The total number of tracks and the total playing time of the CD are displayed.
 - 5 Press ■ again to switch the player off.
- To remove the CD, hold it by its edge and press the hub gently while lifting the CD.

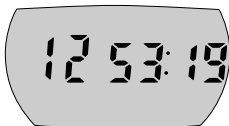
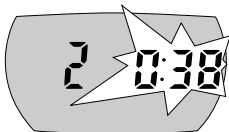

Note: If there is no activity, the set will automatically switch off after a while to save energy.

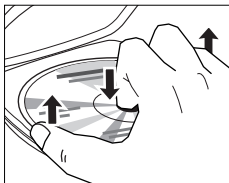

Playback information

- If a recordable CD (CD-R) or a rewritable CD (CD-RW) is not recorded properly, *no disc* is displayed. In that case use FINALIZE on your CD recorder to complete the recording.
- If you want to play a rewritable CD (CD-RW), it takes 3–15 seconds for sound reproduction to start once you have pressed ►II.
- Playback will stop if you open the CD lid.
- While the CD is read, *1 - - -* is displayed.

Volume and bass

Volume adjustment

- Adjust the volume by using VOL ▲.

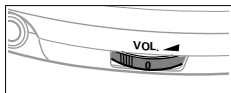

Bass adjustment

You can choose between the bass enhancement levels *dbb 1* and *dbb 2*.

- 1 Press DIGITAL DBB as often as necessary to select the desired bass intensity.
 - *dbb 1* or *dbb 2* is displayed for 2 seconds and **DBB** is shown.
- 2 To switch *dbb 1* or *dbb 2* off, press DIGITAL DBB repeatedly.
 - **DBB** goes off.

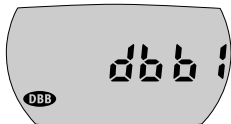
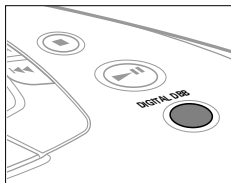

This set complies with the radio interference requirements of the European Community.

FEATURES

Selecting a track and searching

Selecting a track during playback

- Briefly press ◀◀ or ▶▶ once or several times to skip to the current, previous or next track.
 - Playback continues with the selected track and its number is displayed.

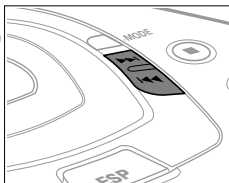

Selecting a track when playback is stopped

- 1 Briefly press ◀◀ or ▶▶ once or several times.
 - The selected track number is displayed.
- 2 Press ▶|| to start CD play.
 - Playback starts with the selected track.

Searching for a passage during playback

- 1 Keep ◀◀ or ▶▶ pressed to find a particular passage in a backward or forward direction.
 - Searching is started and playback continues at low volume. After 2 seconds the search speeds up.
- 2 Release the button when you reach the desired passage.
 - Normal playback continues from this very position.

Notes: – During SCAN searching is not possible.
– During SHUFFLE, SHUFFLE REPEAT ALL, REPEAT or while playing a program, searching is only possible within the particular track.

Programming track numbers

You can select up to 99 tracks and store them in memory in a desired sequence. Any track can be stored more than once.

- 1 While playback is stopped, select a track with **◀◀** or **▶▶**.
 - 2 Press **PROGRAM** to store the track.
 - **PROGRAM** lights up; the track number programmed and **P** with the total number of stored tracks are displayed.
 - 3 Select and store all desired tracks in this way.
 - 4 Press **▶||** to start playback of your selected tracks.
 - **PROGRAM** is shown and playback starts.
- You can review the program by pressing **PROGRAM** for more than 2 seconds.
 - The display shows all stored tracks in sequence.

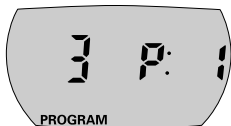
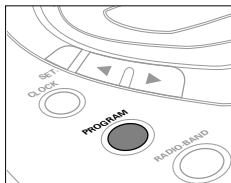

Notes: – If you press **PROGRAM** and there is no track selected, **SELECT** is displayed.
 – If you try to store more than 99 tracks, **FULL** is displayed.

Clearing the program

- 1 If necessary, press **■** to stop playback.
- 2 Press **■** to clear the program.
 - **CLEAR** is displayed once, **PROGRAM** goes off and the program is cleared.

Notes: The program will also be cleared if you
 – interrupt the power supply or
 – open the CD lid.



FEATURES

Storing the last position played – RESUME

You can store the last position played. When restarting, playback continues from where you have stopped.

- 1 Switch the slider to RESUME during playback to activate RESUME.
→ **RESUME** is shown.
 - 2 Press ■ whenever you want to stop playback.
 - 3 Press ►|| whenever you want to resume playback.
→ **RESUME** is shown and playback continues from where you have stopped.
- To deactivate RESUME, switch the slider to OFF.
→ **RESUME** goes off.

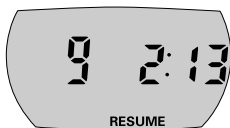
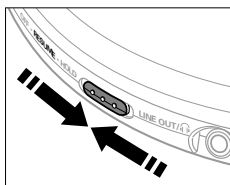

CAUTION

Use of controls or adjustments or performance of procedures other than herein may result in hazardous radiation exposure or other unsafe operation.

Locking all buttons – HOLD

You can lock the buttons of the set. When a key is pressed, no action will be executed then.

- 1 Switch the slider to HOLD to activate HOLD.
→ All buttons are locked. *Hold* is displayed by pressing any key.
- 2 To deactivate HOLD, switch the slider to OFF.

Note: When you deactivate HOLD by switching the slider to RESUME and restart, playback continues from where you have stopped.

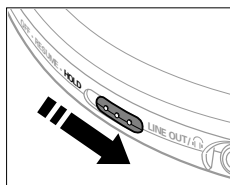



FEATURES

ESP

With a conventional portable CD player you might have experienced that the music stopped e.g. when you were jogging. The **ELECTRONIC SKIP PROTECTION** prevents loss of sound caused by light vibrations and shocks. Continuous playback is ensured.

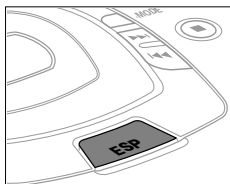
However, ESP does not prevent playback interruptions during serious running. It also does not protect the set against any **damage** caused **by dropping!**



- Press ESP during playback to activate the skip protection.
 -  is shown and the protection is activated.
- To deactivate the skip protection, press ESP again.
 -  goes off and the protection is deactivated.



Selecting different playing possibilities – MODE

It is possible to play tracks in random order, to repeat a track or the CD and to play the first few seconds of each track.

1 Press **MODE** during playback as often as necessary until the display shows either:

- **SHUFFLE**: All tracks of the CD are played in random order until all of them have been played once.
- **SHUFFLE REPEAT ALL**: All tracks of the CD are played repeatedly in random order.
- **REPEAT**: The current track is played repeatedly.
- **REPEAT ALL**: The entire CD is played repeatedly.
- **SCAN**: The first 10 seconds of each of the remaining tracks are played in sequence.

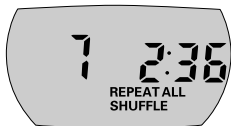
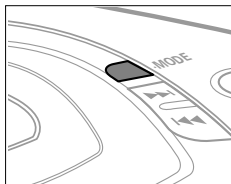

2 Playback starts in the chosen mode after 2 seconds.

- To return to normal playback, press **MODE** repeatedly until the display indicator goes off.

RADIO

Radio play

You can tune to any FM or MW (or AM) station automatically or manually. Stereo stations are indicated by **ST**.

- 1 Press **RADIO-BAND** to switch the radio on.
- 2 Press **RADIO-BAND** if necessary repeatedly to select the desired waveband.
→ **FM 1**, **FM 2**, **FM 3**, **FM 4** or **MW** (or **AM**) is shown.

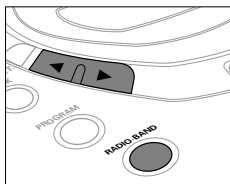

Tuning to radio stations automatically

- 1 Keep **▲** or **▼** pressed for at least 1 second.
→ The radio tunes to a station with sufficient strength and radio play starts.
A (for "automatic search") and the current waveband and frequency are displayed.

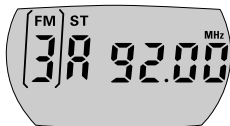

- 2 Repeat searching until you find the desired radio station.

Tuning to radio stations manually

- 1 Keep **▲** or **▼** pressed.
- 2 Release **▲** or **▼**, then briefly press **▲** or **▼** again when you are close to the desired frequency.
- 3 Briefly press **▲** or **▼** repeatedly until you reach the desired frequency.
→ Radio play starts. The current waveband and frequency are displayed.

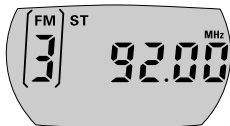

- To switch from radio play to CD play press **▶||**.
- Press **■** to switch the radio off.

*Note: In case of interferences in stereo mode press **-MODE** to switch to mono.*

Antennas

- **FM:** The headphone wire is used as FM antenna. If necessary move it for optimum reception.
- **MW (or AM):** The internal MW (or AM) antenna is directed by turning the player.

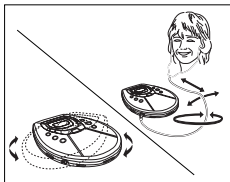

Storing radio stations

You can store up to 30 radio stations.

- 1 Tune to a desired radio station and press PROGRAM.
- 2 Press ◀◀ or ▶▶ if necessary repeatedly to select the number that should be assigned to this radio station.
- 3 Press PROGRAM while **PRESET** is blinking to confirm the storing.
 - **PRESET**, the waveband, the frequency and the preset number of the stored station are displayed.
- 4 Store all desired stations this way.

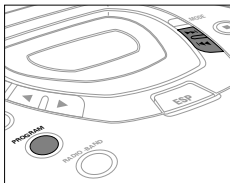

*Note: Already stored stations can be recognized by the indicator **PRESET** and the preset number.*

Tuning to a stored radio station

- 1 Select the waveband.
- 2 Press ◀◀ or ▶▶ if necessary repeatedly to select the preset number of the desired radio station.
 - Radio play starts. **PRESET**, the waveband, the frequency and the preset number of the stored station are displayed.

CLOCK

Time setting

Your player has a built-in clock. However CD or tuner play is not conditional upon the time setting.

- 1 Keep SET· pressed for approximately 2 seconds.
→ The clock digits *00:00* (or *12:00* in some versions) flash.
 - 2 Keep ▲ or ▼ pressed, then briefly press ▲ or ▼ again repeatedly within 5 seconds to set the current time.
→ The current time is displayed.
 - 3 Press SET· three times or do not press any key for 5 seconds.
→ The current time is set and the time display goes off.
- To switch to the clock display during CD or tuner play, press CLOCK.
→ The current time is displayed for 5 seconds.

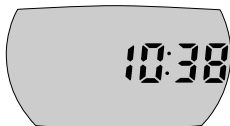
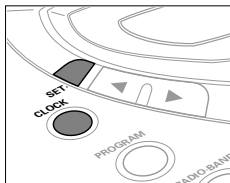

Notes: – When the player is supplied by batteries do not remove the batteries during radio play, otherwise time settings will be lost and will have to be readjusted.
– If the power supply is interrupted for longer than 1 minute, all time settings will be lost and will have to be readjusted.

Alarm time setting

Provided the current time has been set, your player can be used as an alarm clock.

- 1 Keep SET· pressed for approximately 2 seconds, then briefly press SET· again.
→ AL is displayed and the alarm clock digits 00:00 (or 12:00 in some versions) flash.



- 2 Press ▲ or ▼ repeatedly within 5 seconds to set the alarm time.
→ ☹ is shown and the alarm time is displayed.

- 3 Press SET· twice or do not press any key for 5 seconds.
→ The alarm time is set and the alarm display goes off.

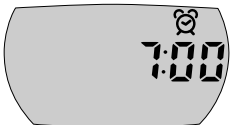

- To switch to the alarm clock display during CD or tuner play, press CLOCK twice.
→ ☹ is shown and the alarm time is displayed for 5 seconds.



ALARM CLOCK

Alarm activation/deactivation

At the set alarm time either the tuner will start playing for 1 hour, the beeper will come on for 3 minutes or an entire CD will be played.

IMPORTANT!

To ensure your selected **beeper**, **CD** or **tuner alarm** activates at the set time, make sure you leave the CD player in **standby mode**.

- 1 Keep SET· pressed for approximately 2 seconds, then briefly press SET· twice.
→ Either *AL bEEP*, *AL Cd* or *AL tun* is displayed.
 - 2 Press ▲ or ▼ if necessary repeatedly within 5 seconds to select the desired alarm signal until the display shows either:
AL bEEP: the beeper will be the alarm signal,
AL Cd: the CD will be the alarm signal, or
AL tun: the tuner will be the alarm signal.
→ At the set time  starts flashing and the selected alarm signal will come on.
- You can deactivate the beeper for 24 hours by pressing any key on the player.
 - If you deactivate the alarm function by switching CD or tuner play off with , CD or tuner play will restart after 24 hours.
 - To switch the alarm function on or off, keep ESP pressed for approximately 2 seconds.
→  is shown if the alarm function is on.

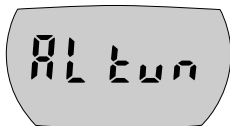

Notes: – If there is no CD inserted or no radio station tuned, the beeper will be taken as the alarm signal instead.

– If the alarm is activated during CD or tuner playback, playback is interrupted and you will hear the **beeper alarm** through the LINE OUT/ connection only, irrespective of your chosen alarm signal.

– In standby mode, the beeper alarm uses the built-in speaker located on the base of the CD player.

IN-CAR CONNECTION

In-car use (connections supplied or optionally available)

Only use the AY 3545 car voltage converter (4.5 V, DC, positive pole to the centre pin) and the AY 3501 car cassette adapter. Any other product may damage the set.

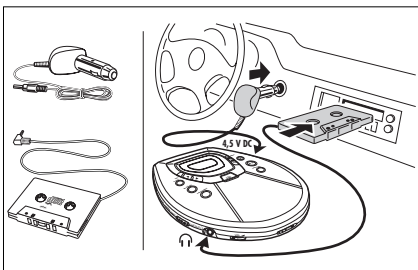

- 1 Put the CD player on a horizontal, vibration-free and stable surface. Make sure it is in a safe place, where the player is neither a danger nor obstacle to the driver and passengers.
 - 2 Connect the DC plug of the voltage converter to the 4.5V DC socket of the CD player (**only for a 12 V car battery, negative grounding**).
 - 3 Insert the voltage converter into the cigarette lighter socket. If necessary, clean the cigarette lighter socket to obtain a good electrical contact.
 - 4 Turn down the volume and connect the cassette adapter plug to the LINE OUT/🔊 socket of the CD player.
 - 5 Carefully insert the cassette adapter into the car radio's cassette compartment.
 - 6 Make sure the cord does not hinder your driving.
 - 7 Start the CD player, set VOL \blacktriangleleft to position 8 and adjust the sound with the car radio controls.
- Always remove the voltage converter from the cigarette lighter socket when the CD player is not in use.

Notes: – Avoid excessive heat from the car heating or from direct sunlight (e.g. in a parked car in the summer).

– If your car radio has a LINE IN socket, it is better to use it for the car radio connection instead of the cassette adapter. Connect the signal lead to this LINE IN socket and to the LINE OUT/🔊 socket of the CD player.

TROUBLESHOOTING

WARNING

Under no circumstances should you try to repair the set yourself as this will invalidate the guarantee.

Problem	Possible cause	Solution
No power, playback does not start	Batteries	
	Batteries inserted incorrectly	Insert the batteries correctly.
	Batteries are empty.	Change the batteries.
	Contact pins are dirty.	Clean them with a cloth.
	Mains adapter	
Loose connection	Connect the adapter securely.	
In-car use		
	Cigarette lighter is not powered when ignition is off.	Switch on ignition or insert batteries.
	no disc indication	
CD-RW (CD-R) is not recorded properly.	Use FINALIZE on the CD recorder to complete the recording.	
no disc indication		
	The CD is badly scratched or dirty.	Replace or clean the CD.
	CD is not or incorrectly inserted.	Insert a CD, label upwards.
Hold indication and/or no reaction to controls		
	The laser lens is steamed up.	Wait until the lens has cleared.
	HOLD is activated.	Deactivate HOLD.
The CD skips tracks.		
	Electrostatic discharge	Disconnect the set from power supply or take out the batteries for a few seconds.
	The CD is damaged or dirty.	Replace or clean the CD.
	RESUME, SHUFFLE or PROGRAM is active.	Switch RESUME, SHUFFLE or PROGRAM off.

TROUBLESHOOTING

If a fault occurs, first check the points listed, before taking the set for repair.

If you are unable to solve a problem by following these hints, consult your dealer or service centre.

Problem	Possible cause	Solution	
No sound or bad sound quality	PAUSE is activated.	Press ►II.	
	Loose, wrong or dirty connections	Check and clean connections.	
	Volume is not adjusted.	Adjust the volume.	
	Malfunctions due to vicinity of active mobile phones	Keep the player away from active mobile phones.	
	Strong magnetic fields near the player	Change the player's position or connections.	
	In-car use		
	cassette adapter is inserted incorrectly.	Insert the cassette adapter correctly.	
	Temperature inside the car is too high/low.	Let the player adjust to the temperature.	
	Cigarette lighter socket is dirty.	Clean the cigarette lighter socket.	
	Wrong playback direction of the car cassette player's autoreverse feature	Change the autoreverse direction.	
Poor radio reception	Weak radio signal	Direct the antenna for optimum reception.	
	Interference caused by electric equipment like TVs, computers, engines etc.	Keep the player away from electric equipment.	
Alarm does not work.	Alarm time is not set/alarm is not activated.	Set the alarm time/activate the alarm.	
Malfunction, loss of time settings	Continued operation with weak batteries	Change batteries, readjust settings.	

Free Manuals Download Website

<http://myh66.com>

<http://usermanuals.us>

<http://www.somanuals.com>

<http://www.4manuals.cc>

<http://www.manual-lib.com>

<http://www.404manual.com>

<http://www.luxmanual.com>

<http://aubethermostatmanual.com>

Golf course search by state

<http://golfingnear.com>

Email search by domain

<http://emailbydomain.com>

Auto manuals search

<http://auto.somanuals.com>

TV manuals search

<http://tv.somanuals.com>